



PLDC04626
REVISION DATE
March 11, 2022
DATE
March 11, 2022
TECHNICAL OFFICE
Stavale

CS16



TECHNICAL SERVICE MANUAL

ALARM CODES DISPLAYED

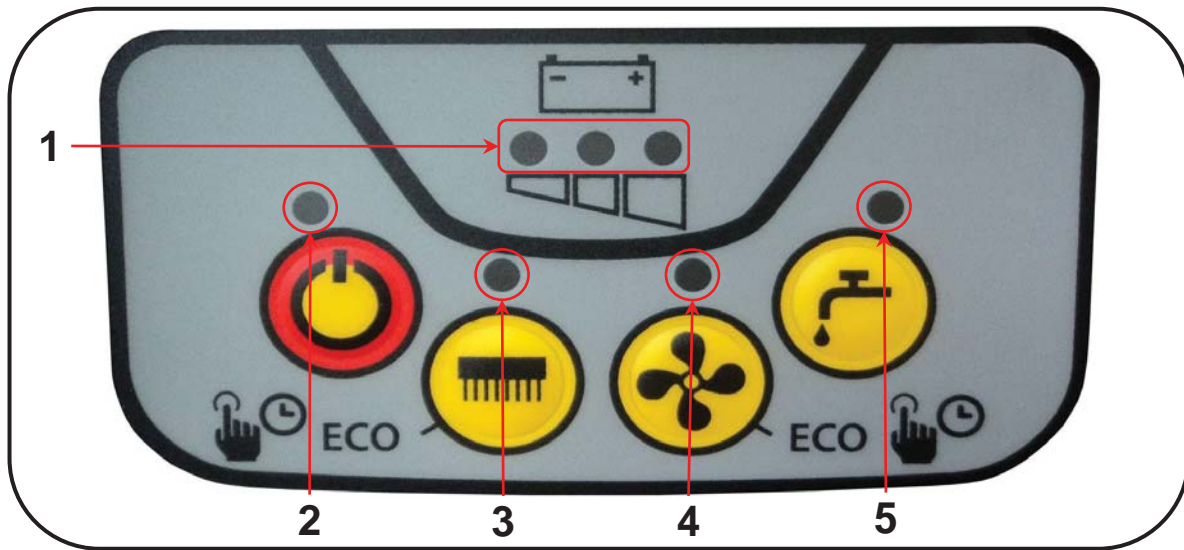

WARNING: Triggering of the brush motor thermal, interruption of the brush motor and vacuum motor fuses, malfunction (interrupted cable) of the brush motor and vacuum motor power cables are not displayed on the dashboard.

Error: **BRUSH SHUTDOWN**

On display: 2 quick flashes of brush LED ref. 3
 Short-circuit protection error.
 This occurs when excessive peak current is detected.
 Check that the brush motor wiring is not short-circuited.
 Manually check that the brush motor rotates freely and without effort.

Error: **BRUSH I²T**

On display: 2 slow flashes of brush LED ref. 3
 Brush motor overload error.
 Check that the brushes and the drive are not rubbing anywhere.
 Check brush motor current draw.

Error: **SUCTION SHUTDOWN**

On display: 2 fast flashes of suction LED ref. 4
 Short-circuit protection error.
 This occurs when excessive peak current is detected.
 Check that the suction motor wiring is not short-circuited.
 Manually check that the suction motor rotates freely and without effort.

Error: **SUCTION I²T**

On display: 2 slow flashes of suction LED ref. 4
 Suction motor overload error.
 Check check that the suction motor rotor rotates freely.
 Check brush motor current draw.

Error: MAXIMUM TEMPERATURE

On display: fast, continuous flashing of brush LED ref. 3 and suction LED ref. 4 simultaneously.

Power board overheating error.

To restore the functions switch the machine off and wait around 15 minutes until the power board cools down.

Check brush motor and suction motor current draw.

Error: BRUSH THERMAL PROTECTOR

On display: 4 consecutive flashes of brush LED ref. 3.

Brush motor overheating error.

Brush motor thermal protector tripped

The board cuts off power to the brush motor.

Wait for the brush motor to cool down and the thermal protector inside the motor to reset.

Warning: BATTERIES CHARGED

On display: 5 consecutive flashes of yellow battery LED ref. 1.

Charged batteries warning.

Disconnect the battery charger.

Warning: BATTERIES DISCHARGED

On display: 6 consecutive flashes of yellow battery LED ref. 1.

Discharged batteries warning.

Recharge the batteries.

Warning: BATTERY CHARGER ON

On display: 7 consecutive flashes of yellow battery LED ref. 1.

Batteries charging warning.

Wait until batteries are fully recharged.

Error: BRUSH MOTOR SHUTDOWN

On display: 11 consecutive flashes of yellow battery LED ref. 1.

Brush motor shut down by power board, due to discharged battery with voltage at minimum set threshold of 21.9 Volts.

Recharge the batteries.

Error: SUCTION MOTOR SHUTDOWN

On display: 12 consecutive flashes of yellow battery LED ref. 1.

Brush motor shut down by power board, due to discharged battery with voltage at minimum safety threshold of 21.5 Volts.

Recharge the batteries.

Information - **SHUTDOWN ERROR:**

If activated due to "*short circuit*" or "*excessive peak current*" detected by the power board, the problem may involve the brush and/or suction motor wiring or motor power supply or the actual power board itself.

In the shutdown error involves the motors or the motor wiring, the electronic control board stops the function and signals the error via the LED on the instrument panel.

Information - **I²T:**

The overload error (I²T) is shown when the power board needs to deliver current that exceeds the set maximum value.

Activation of the power board shuts down the motor that caused the error, and is signalled by the flashing of the LED on the instrument panel corresponding to the motor in question.

For the suction motor, the limit is 30 Amperes (exceeding 30A) for a maximum of 20 seconds.

For the brush motor, the limit is 15 Amperes (exceeding 15A) for a maximum of 20 seconds.

The problem can be reset by switching the machine off and on again. If the error occurs again, check the

Information - **MAXIMUM TEMPERATURE ERROR:**

The overheating error on the brush motor and suction motor power board is shown when the board temperature exceeds the maximum set value.

Activation of the power board shuts down both motors, regardless of which caused the overheating, and is signalled by fast and continuous flashing of the LEDs corresponding to both the brush and suction motor.

Information - **ERRORS NOT DISPLAYED:**

If the machine fails to start or the functions cannot be activated, without any errors shown on the display, the problem could be due to a broken flat cable, a damaged display board or a short-circuit on the power board.

In these cases to restore normal operation, replace the faulty component (flat cable, display board, power board), which can be identified by inspecting the component visually, or replacing them one-by-

Information - **SUCTION IN REMOTE MODE:**

Can be activated starting from serial number 8000209102

Pressing the suction button ref. 4 for around 5 seconds, the suction motor will start without acting on the brush control lever.



INDEX

Subject	Page
A BRUSH HEAD	
A1 MEASURING BRUSH MOTOR CURRENT DRAW	2
A1.1 Measuring brush motor current draw on the CS16 Battery	3
A1.2 Replacing the brush motor's carbon brushes on the CS16 Battery	5
A1.3 Replacing the brush motor's carbon brushes on the CS16 Cord	9
A2 REMOVING THE BRUSH MOTOR - BRUSH HEAD	13
A2.1 Removing the brush motor from the CS16 Battery	14
A2.2 Removing the brush motor from the CS16 Cord	18
A2.3 Removing the brush head from the CS16 B and CS16 Cord	19
A2.4 Replacing the brush motor's thermal protector	21
B SUCTION UNIT - TANKS	
B1 SUCTION MOTOR	25
B1.1 Measuring suction motor current draw on the CS16 Battery	26
B1.2 Removing the suction motor from the CS16 Battery	28
B1.3 Replacing the suction motor carbon brushes on the CS16 Battery	30
B1.4 Removing the suction motor from the CS16 Cord	32
B1.5 Replacing the suction motor carbon brushes on the CS16 Cord	33
B2 SQUEEGEE UNIT	35
B2.1 Adjusting the squeegee	36
B2.2 Replacing the squeegee flaps	37
B3 CLEANING FILTERS AND HOSES - TESTING THE SOLENOID VALVE AND FLOAT	41
B3.1 Testing the solenoid valve	42
B3.2 Testing and replacing the solenoid valve on "B" version machines	44
B3.3 Checking the condition of the float	48
B3.4 Cleaning the filters, hoses and solution dispensing cock	49
D INSTRUMENT PANEL/POWER BOARD-BATTERY CHARGER-ELECTRICAL CIRCUIT	
D1 INSTRUMENT PANEL BOARD - POWER BOARD	55
D1.1 Replacing the function control card on "B" and "C" version machines	56
D1.2 Testing the function control card on "B" and "C" version machines	59
D1.3 Replacing the power board on "Battery" version machines	62
D1.4 Testing the power control card on "Battery" version machines	66
D1.5 Replacing the power control card on Cord type machines	69
D1.6 Testing the power control card on Cord type machines	73
D2 BATTERY CHARGER	82
D2.1 Replacing the battery charger	83
D2.2 Setting the battery charger charging curve	88
D3 WIRING DIAGRAMS	96
D3.1 Electric wiring diagram for type Battery versions	96
D3.2 Electric wiring diagram for type Cord versions	97
E ERROR CODES - TROUBLESHOOTING	
E1 DISPLAY OF ERROR CODES	99
E1.1 Error codes for the function control card on Battery type machines	99
E2 TROUBLESHOOTING	105
E2.1 Troubleshooting	105
REVISIONS - UPDATES	109

OPTIONS

WARNINGS

! DANGER

Indicates the need for attention in order to avoid a series of consequences which could cause death or damage to the health of the operator.

👉 WARNING

Indicates the need for attention in order to avoid a series of consequences which could cause damage to the machine or work environment or financial loss.

i INFORMATION

Indicates particularly important instructions.

In line with the company's policy of constant product development and updating, the Manufacturer reserves the right to make modifications without warning. Although your machine may differ appreciably from the illustrations in this document, safety and the information contained in this manual are guaranteed.



PLDC04626

REVISION 00

March 11, 2022

TECHNICAL DEPT.

Stavale

A

BRUSH HEAD

👉 WARNING!

Go to the designated draining area and empty the solution and collection tanks using the drain plugs and the hoses provided.

Position the machine on a flat floor, and place wedges under the wheels to stop it moving.

Switch the machine off and disable all functions by pressing the “On–Off” button on the control panel.

Disconnect the machine’s electrical system by removing the main fuse F1, or by disconnecting the terminals from the battery poles (battery powered machines), or by removing the plug from the mains power socket (mains powered machines).

i INFORMATION

Important information

In this Service Manual, the terms **RIGHT** and **LEFT** are used to indicate the sides of the machine. They always refer to the direction of travel.

In this Service Manual, the machine version (**CS16 B** = battery, **CS16 C** = corded) may appear between brackets “()”. This indicates that the instruction in question refers only to the version specified.



PLDC04626

REVISION 00

March 11, 2022

TECHNICAL DEPT.

Stavale

A1 MEASURING BRUSH MOTOR CURRENT DRAW

On the scrubber CS16, the brush motors of type battery versions and cord type versions are very similar. Apart from the power source (24 V DC for battery versions and 230V AC for “C” versions), the differences lie in the motors’ maximum current draw and in the type of connections. The motors of mains powered versions feature waterproof terminals to provide increased protection against electric shock.



CS16 Battery



CS16 Cord

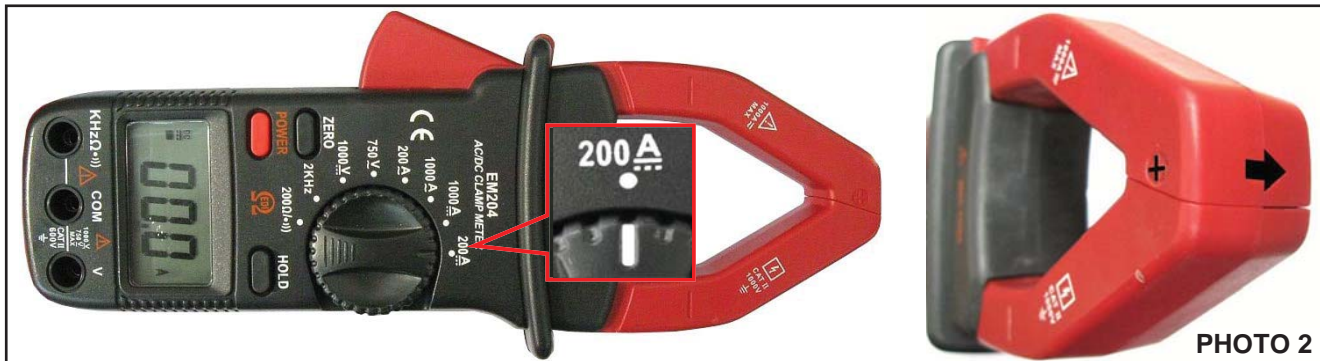

PHOTO 1



A1.1 Measuring brush motor current draw on the CS16 Battery

- 1 Make sure that the batteries on the machine are fully charged ($24V \pm 1V$).
- 2 Use a clamp-on ammeter with a full scale reading of at least 200 A (amperes) as shown below.



- 3 Move the machine to the tank draining area, and completely empty the collection tank A.
- 4 Make sure that the solution tank contains only a small amount of solution before you start.
- 5 Move the machine to a flat, dry and smooth floor.
- 6 Make sure that you have enough room around the machine to perform the measurement safely.
- 7 Unhook the hoses and lift up and remove the collection tank A to access the cables B of the brush motor.

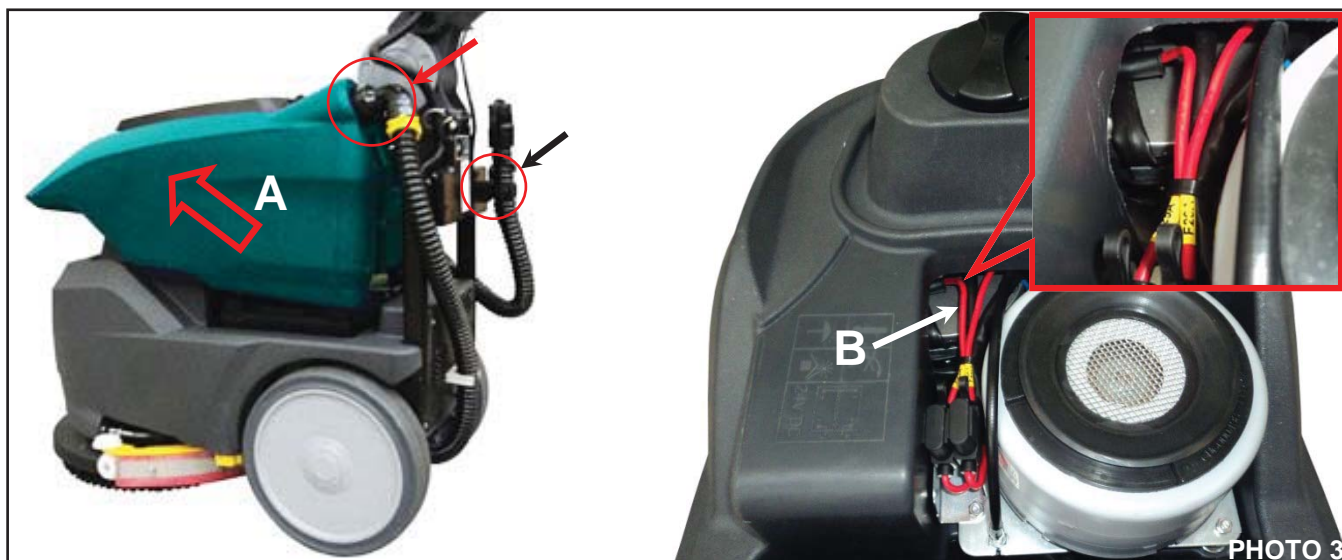

- 8 Set the clamp-on ammeter to measure amperes (A) of DC current, and clamp it to the red cable.
- 9 Press the "On-Off" button to switch the machine on, and press button C to switch off suction.
- 10 Pull in the control lever D on the handle. Read and record the current draw of the brush motor.

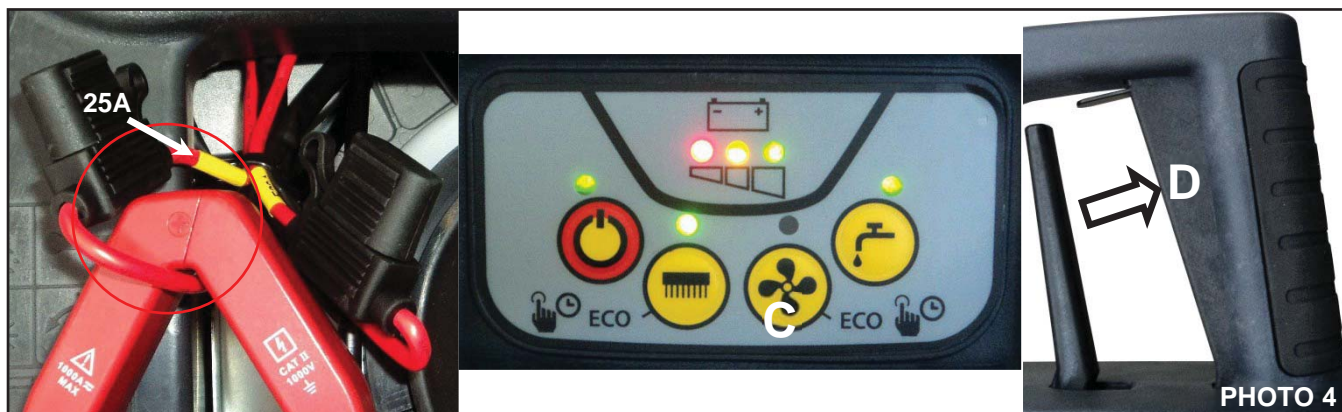



On the CS16 Battery, the brush motor is powered by the power control card. This imposes a current ramp, so you are unlikely to see in-rush current peaks. For this reason, always wait a few seconds for current draw to stabilise before taking the reading.



To obtain current draw readings that can be compared to those in the table below, make sure that the machine is fitted with a standard brush and that the floor surface is neither excessively rough nor excessively smooth.

- 11** Completely fill the solution tank and measure current draw under full load.
- 12** Pull in the control lever **D** on the handle. Read and record the current draw of the brush motor.
- 13** Now lift the brush off the floor by pulling down on the handle and tilting the machine backwards.
- 14** Pull in the control lever **D** on the handle. Read and record the current draw of the brush motor under zero load.



PHOTO 5

- 15** Provided the current draw values lie between the minimum and maximum values specified in the table below, the motor is functioning correctly. You can now remove the ammeter and replace the collection tank.
- 16** If the measurements do not correspond to those specified, proceed as follows.
 - 16a** If no-load current draw (brush raised) is correct, but full load current draw (brush on floor and solution tank full) is too high, first check that the solution is being dispensed properly. Also try moving to a smoother floor surface. Check that battery voltage has not fallen much under 24 V. Check the motor's carbon brushes and replace if necessary.
 - 16b** If current draw is too high at full load and at zero load, check that the brush rotates freely without rubbing against the brush cover or any part of the frame. Check also that the gear unit is properly lubricated. Check the motor's carbon brushes and replace if necessary.
 - 16c** If the above checks have not revealed the problem, replace the brush motor with a new one.

Current draw A (amperes)	Min	Max
<i>Light load (standard brush – solution tank almost empty)</i>	7 A	9 A
<i>Full load (standard brush – solution tank full)</i>	9 A	11 A
<i>No load (brush raised off floor)</i>	2 A	3.5 A



PLDC04626

REVISION 00

March 11, 2022

TECHNICAL DEPT.

Stavale

A1.2 Replacing the brush motor's carbon brushes on the CS16 B Disassembly

- 1 Move the machine to the tank draining area, and empty the solution tank and the collection tank.
- 2 Move the machine to a flat, dry floor. For convenience, use a fork lift if one is available.
- 3 Remove the brush and the collection tank.
- 4 Disconnect and remove the batteries from the battery compartment.

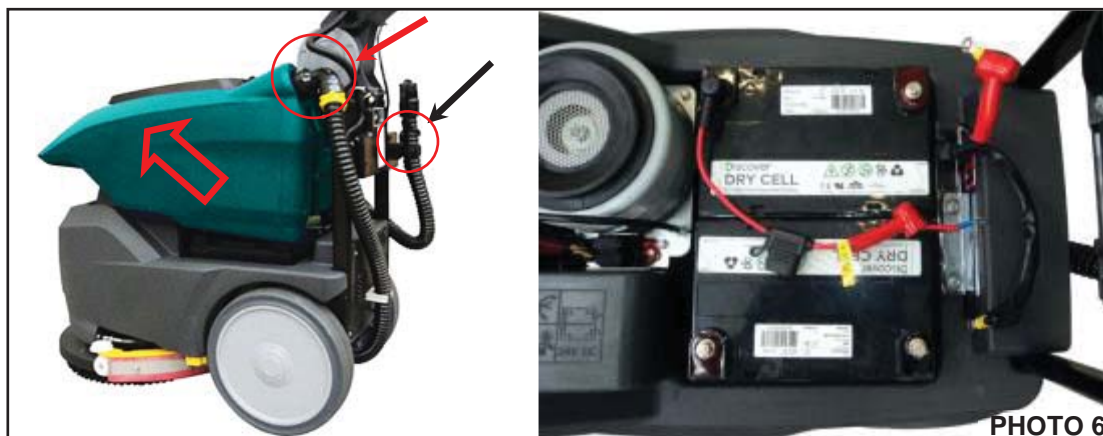

- 5 Lower the squeegee by means of its operating lever.
- 6 Close the solution dispensing cock **A**, at the bottom left of the tank.
- 7 Turn the handle **A1** of the cock **A** clockwise to shut off the solution supply.
- 8 Disconnect the hose **B** from the cock **A**.
- 9 Cut the plastic straps **C** fixing the rear of the tank to the frame.



- 10 Remove the screw **D** securing the solution tank to the bottom front of the machine frame.

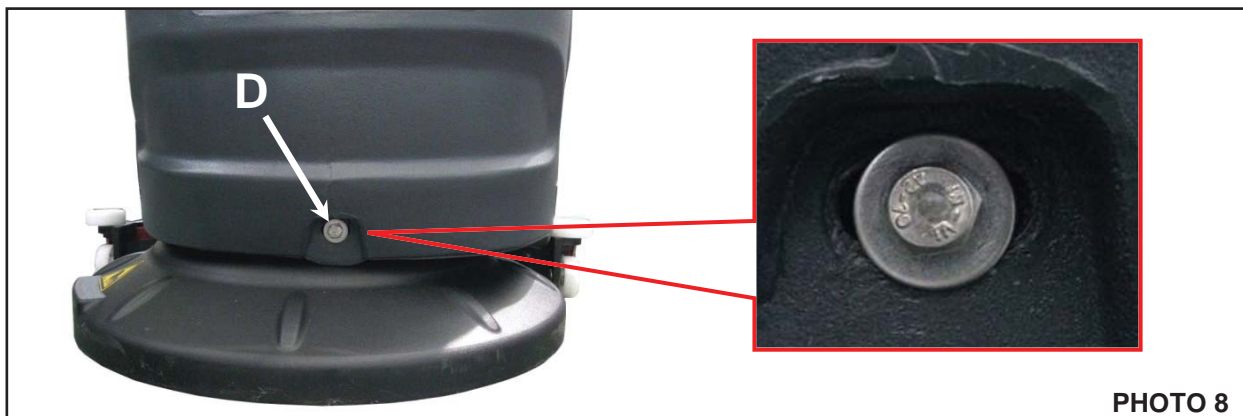

- 11 Lift from its seat the two fuse holders.
- 12 Detach the cable from the squeegee mounting by unscrewing the screw E.
- 13 Lift the solution tank up to the brush motor.

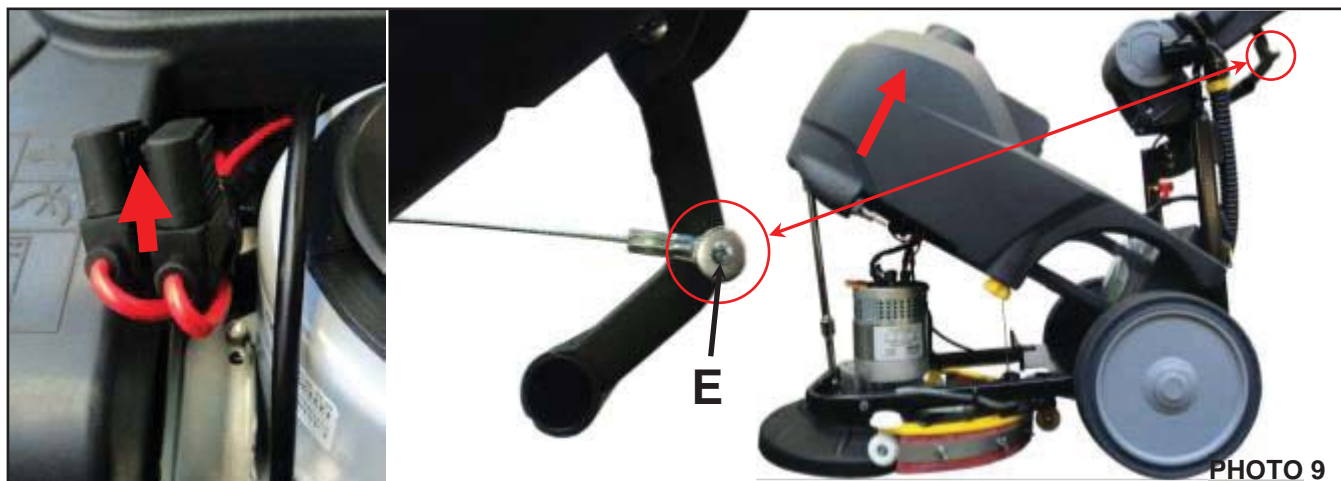

PHOTO 9

- 14 Pull the machine frame and brush motor mounting away from the solution tank.
- 15 Remove the screw G holding the metal strap H in place, to protection of carbon motor brushes I.



PHOTO 10

- 16 Disconnect the brush motor's four carbon brushes I, and pull them out one by one to check their condition.
- 17 Use a long nose pliers to disconnect the fast-on connector of each carbon brush I.

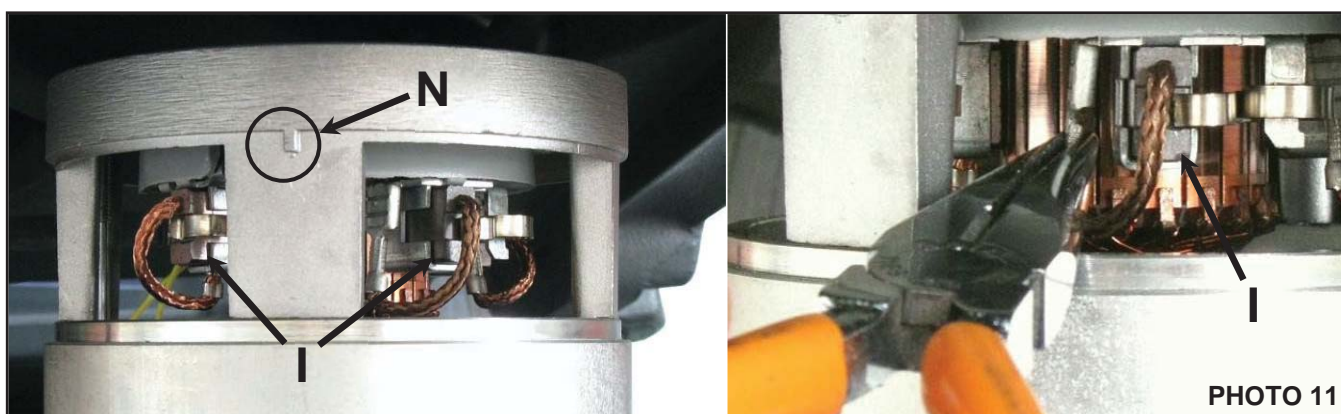

PHOTO 11

18 Use a suitable hook to pull away the spring clip **L** while lifting the carbon brush out by its cable.



19 Check that the dimensions of the carbon brush **I** lie within the tolerances given in the figure below. The brush must have a minimum length of 8.0 mm / 0,31 in.

20 Check the sliding contact surface **I1** of the carbon brushes **I** for wear or damage. The surface must not be badly worn or burned.

21 When fitting new carbon brushes, compare the new ones with the old ones, or check them against the dimensions given in the figure below. Only the length must be different.



Always replace all four carbon brushes at the same time.



When fitting the carbon brushes, make sure that they slide freely in their seats.

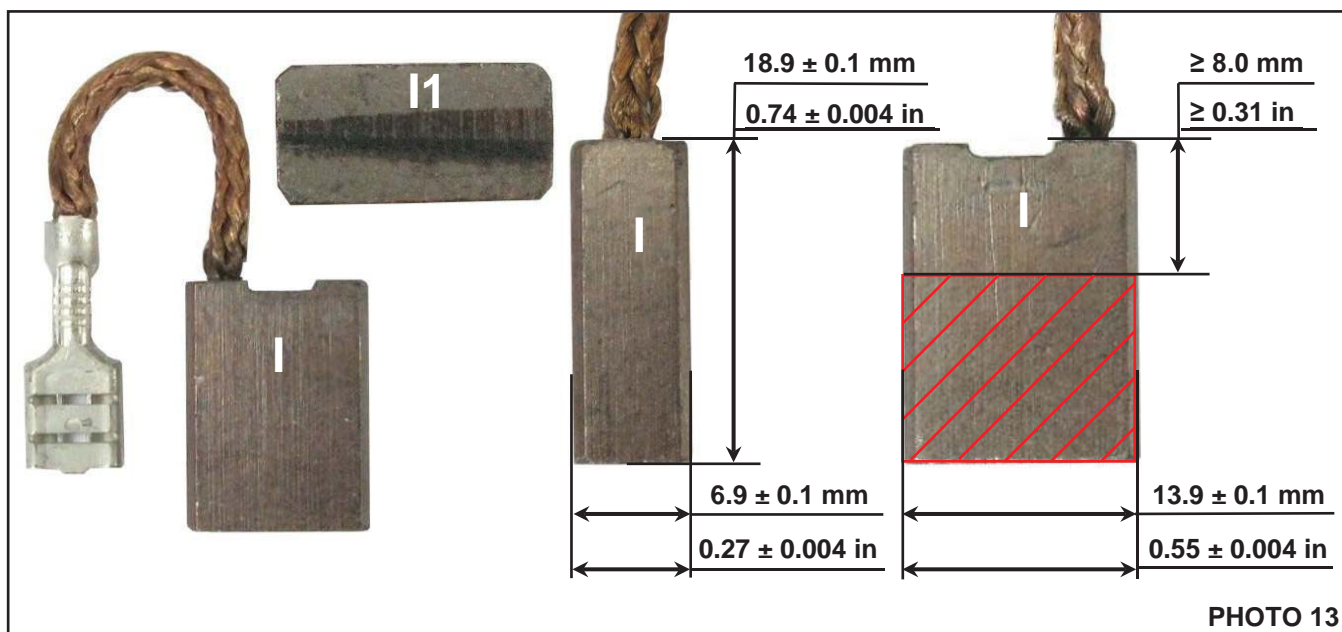

- 22** Blow the inside of the motor clean with a jet of compressed air, paying particular attention to the area around the carbon brushes and to the part of the rotor **M** with which the carbon brushes come into sliding contact.
- 23** Check the rotor **M** for wear, paying particular attention to the area of contact with the carbon brushes.

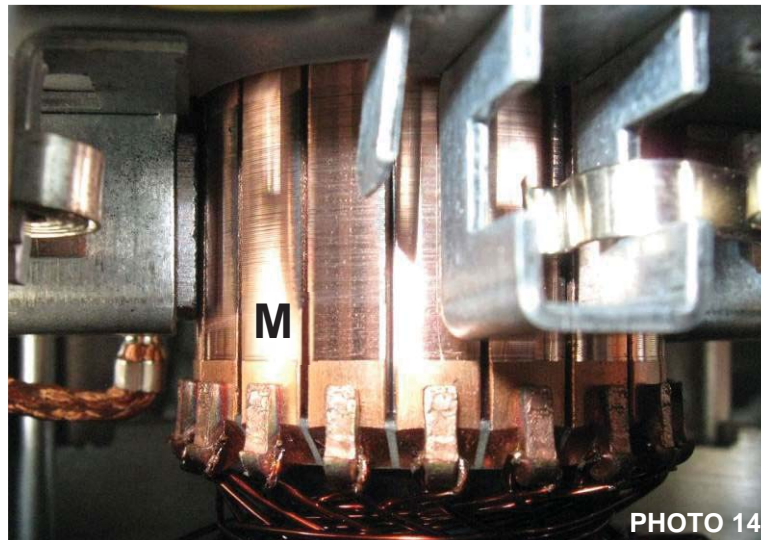

- 24** When repositioning the metal strap **H** over the carbon brushes **I**, align the notch **N** in the strap with the corresponding reference on the motor body.
- 25** Arrange the clamp **H1** of the metal strap **H** as shown in the figure below when reassembling.

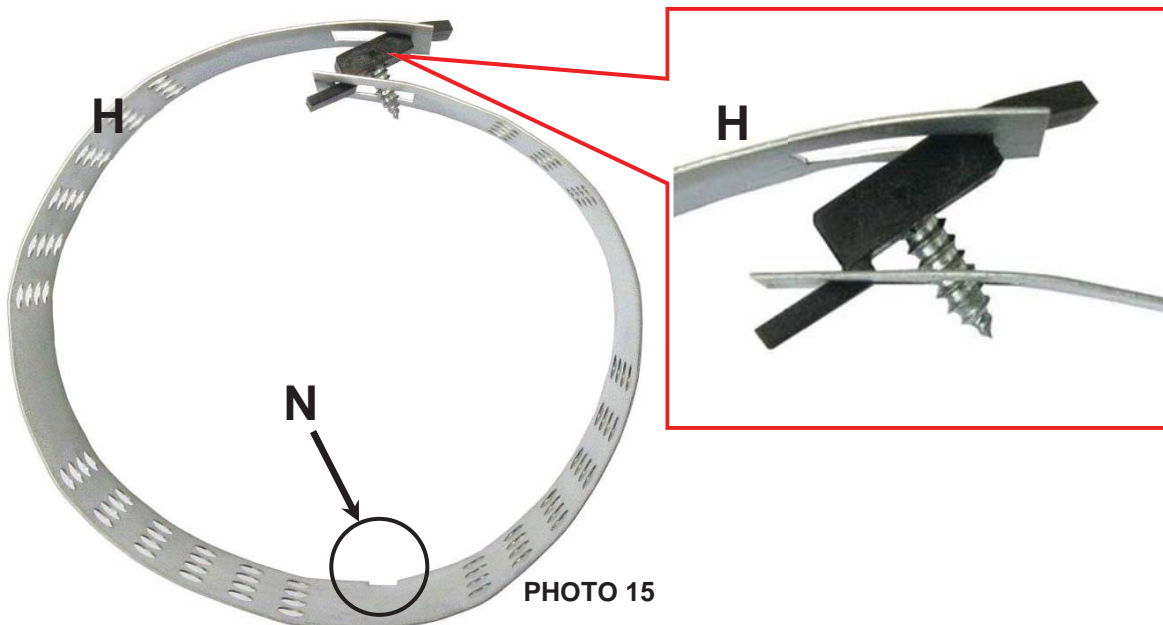

Reassembly

- 1** When fitting carbon brushes, make sure that all four slide freely in their seats.
- 2** Always check the rotor **M** for wear before fitting new carbon brushes.
- 3** To fit the new carbon brushes and reassemble the machine, repeat the steps for disassembly in reverse order.



PLDC04626

REVISION 00

March 11, 2022

TECHNICAL DEPT.

Stavale

A1.3 Replacing the brush motor's carbon brushes on the CS16 C Disassembly

- 1 Make sure that the machine is disconnected from the electricity supply.
- 2 Move the machine to the tank draining area, and empty the solution tank and the collection tank.
- 3 Move the machine to a flat, dry floor. For convenience, use a fork lift if one is available.
- 4 Remove the brush and the collection tank. Lower the squeegee.
- 5 Close the solution dispensing cock **A**, at the bottom left of the tank.
- 6 Turn the handle **A1** of the cock **A** clockwise to shut off the solution supply.
- 7 Disconnect the hose **B** from the cock **A**.

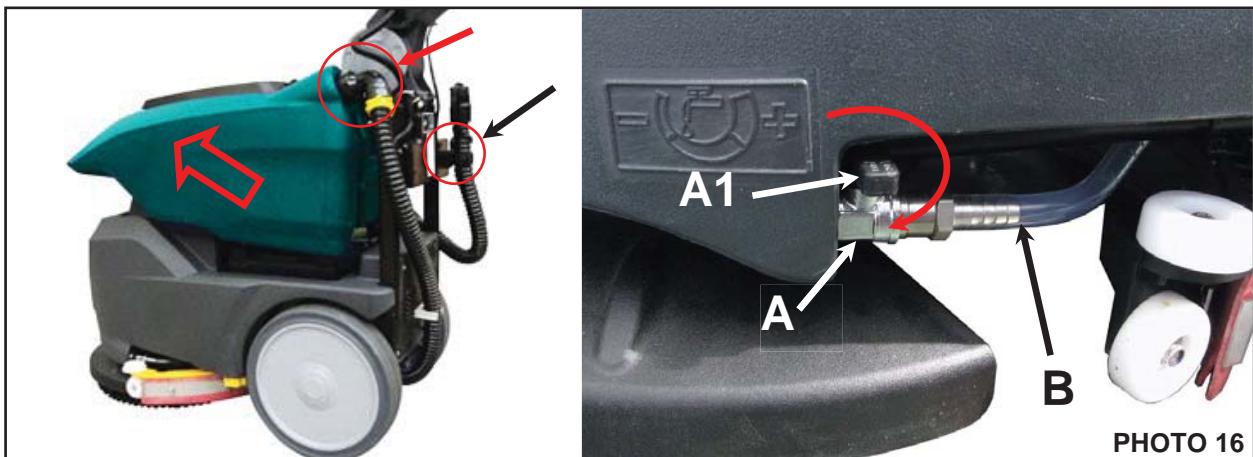

PHOTO 16

- 8 Cut the plastic straps **C** fixing the rear of the tank to the frame.
- 9 Remove the screw **D** securing the solution tank to the bottom front of the machine frame.

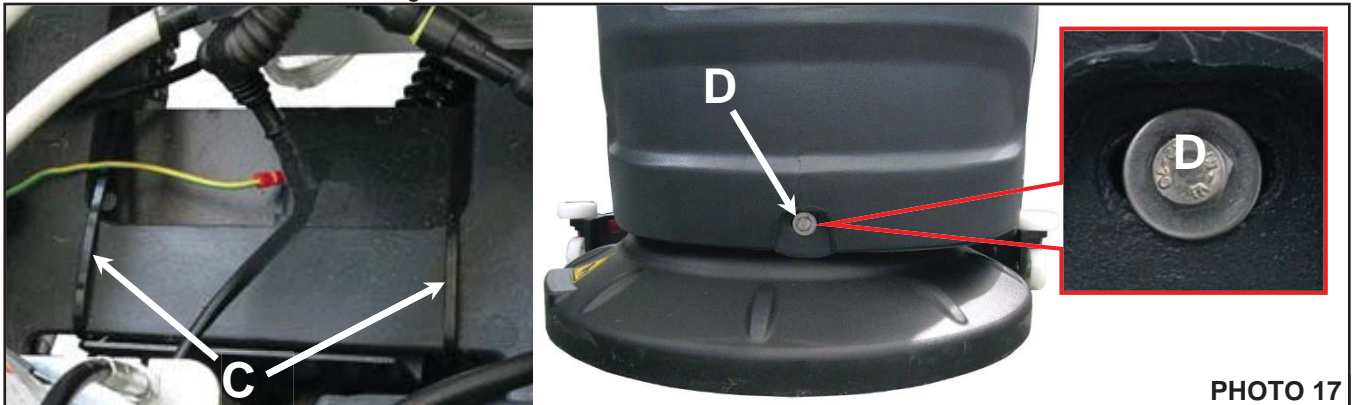

PHOTO 17

- 10 Disconnect the brush motor's power connector **E** (EMI Filter is not visible in this photo).
- 11 Tilt the handle back through about 45°.



PHOTO 18



PLDC04626

REVISION 00

March 11, 2022

TECHNICAL DEPT.

Stavale

- 12 Arrange the motor cable (power **E**) so that they are not pulled when the motor is moved away from the solution tank.
- 13 Tip the machine rearwards, until the handle rests on the floor.
- 14 Detach the cable from the squeegee mounting elastic ring **F**.

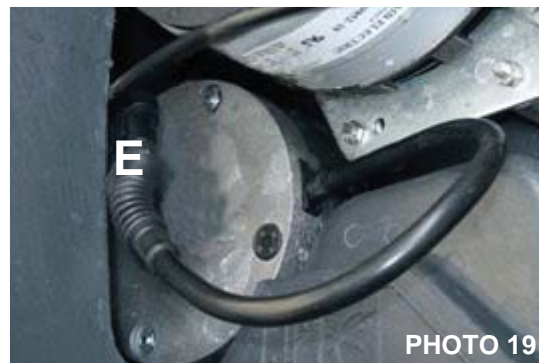

- 15 Pull the machine frame and brush motor mounting away from the solution tank.
- 16 Remove the screw **G** holding the metal strap **I** in place, to protection of carbon motor brushes **L**.



- 17 Disconnect the brush motor's two carbon brushes **L**, and pull them out one by one to check their condition.
- 18 Use a long nose pliers to disconnect the fast-on connector of each carbon brush from the circuit board.



19 Use a suitable hook to pull away the spring clip **M** while lifting the carbon brush **L** out by its cable.

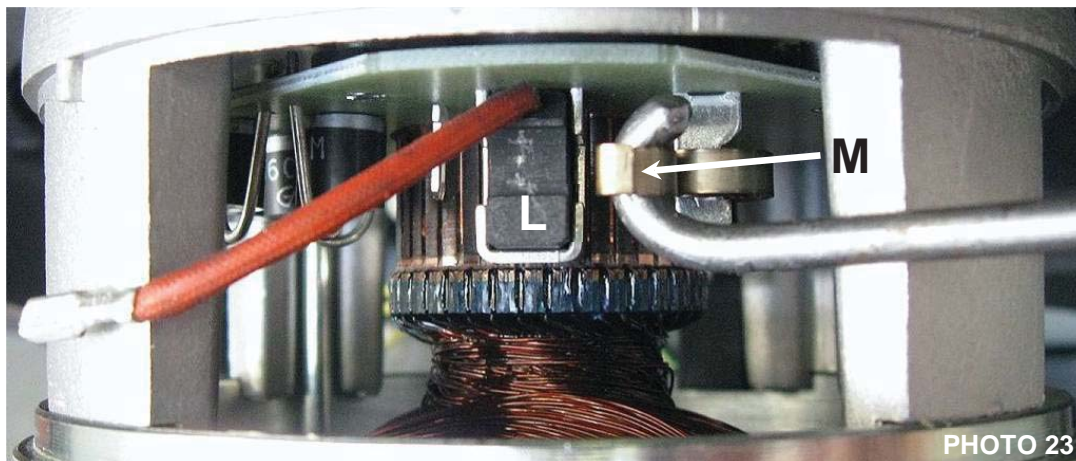

20 Check that the dimensions of the carbon brush **L** lie within the tolerances given in the figure below. The brush must have a minimum length of 8.0 mm / 0,31 in.

21 Check the sliding contact surface **L1** of the carbon brush **L** for wear or damage. The surface must not be badly worn or burned.

22 When fitting new carbon brushes, compare the new ones with the old ones, or check them against the dimensions given in the figure below. Only the length must be different.



Always replace both carbon brushes at the same time.



When fitting the carbon brushes, make sure that they slide freely in their seats.

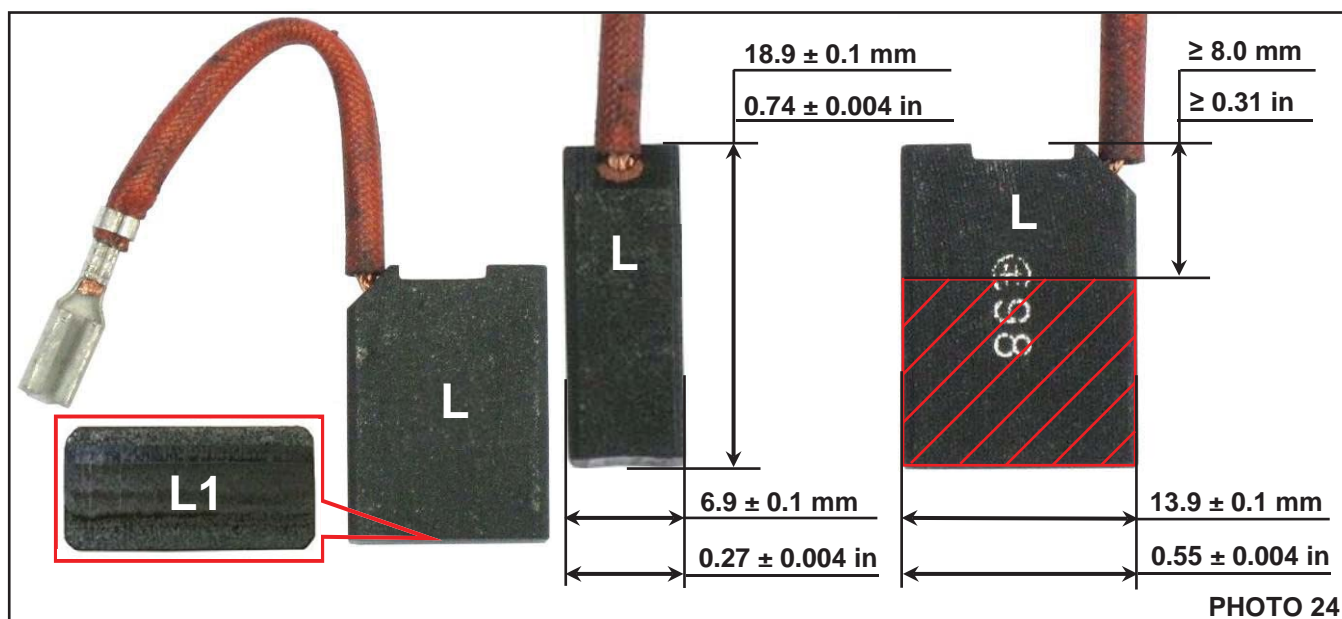

- 23** Blow the inside of the motor clean with a jet of compressed air, paying particular attention to the area around the carbon brushes and to the part of the rotor **N** with which the carbon brushes come into sliding contact.
- 24** Check the rotor **N** for wear, paying particular attention to the area of contact with the carbon brushes.

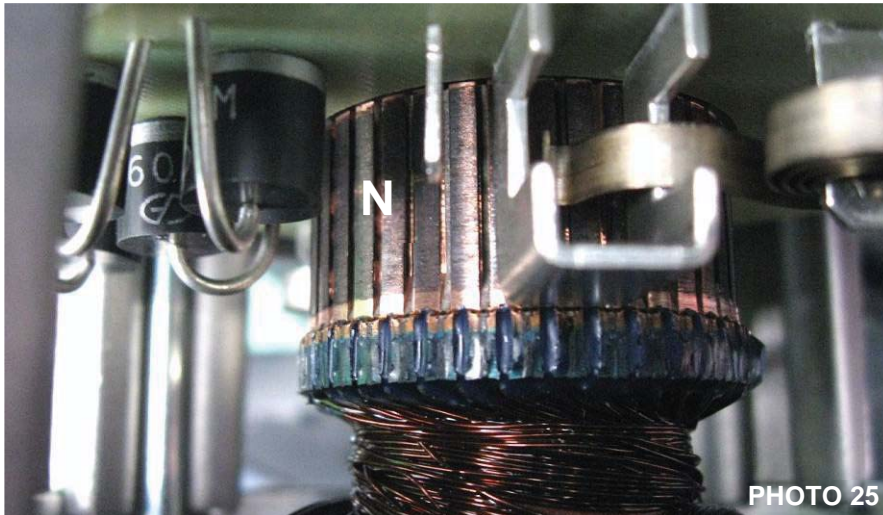

- 25** When repositioning the metal strap **I** over the carbon brushes **L**, align the notch **O** in the strap with the reference on the motor body.
- 26** Arrange the clamp **I1** of the metal strap **I** as shown in the figure below when reassembling.

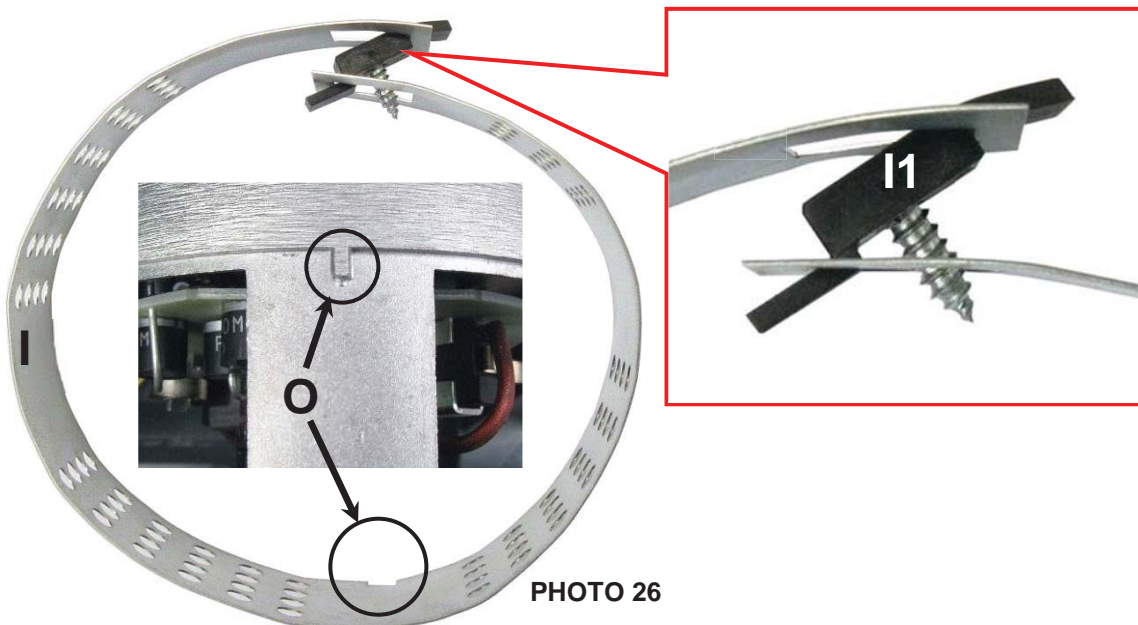

Reassembly

- 1** When fitting carbon brushes, make sure that they both slide freely in their seats.
- 2** Always check the rotor **N** for wear before fitting new carbon brushes.
- 3** To fit the new carbon brushes and reassemble the machine, repeat the steps for disassembly in reverse order.



PLDC04626

REVISION 00

March 11, 2022

TECHNICAL DEPT.

Stavale

A2 REMOVING THE BRUSH MOTOR AND BRUSH HEAD

Removing the CS16 brush motor and brush head is a quick and easy operation. It is nevertheless important to take careful note of the polarity of the motor's power cables, to avoid problems caused by the brush that could compromise the washing.

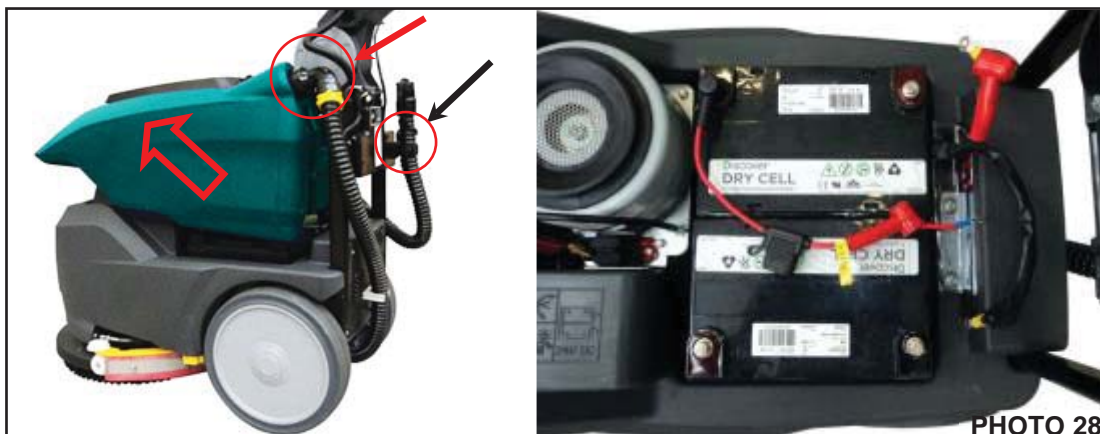

PHOTO 27



A2.1 Removing the brush motor from the CS16 Battery *Disassembly*

- 1 Move the machine to the tank draining area, and empty the solution tank and the collection tank.
- 2 Move the machine to a flat, dry floor. For convenience, use a fork lift if one is available.
- 3 Remove the brush and the collection tank.
- 4 Disconnect and remove the batteries from the battery compartment.



- 5 Lower the squeegee by means of its operating lever.
- 6 Close the solution dispensing cock **A**, at the bottom left of the tank.
- 7 Turn the handle **A1** of the cock **A** clockwise to shut off the solution supply.
- 8 Disconnect the hose **B** from the cock **A**.
- 9 Cut the plastic straps **C** fixing the rear of the tank to the frame.

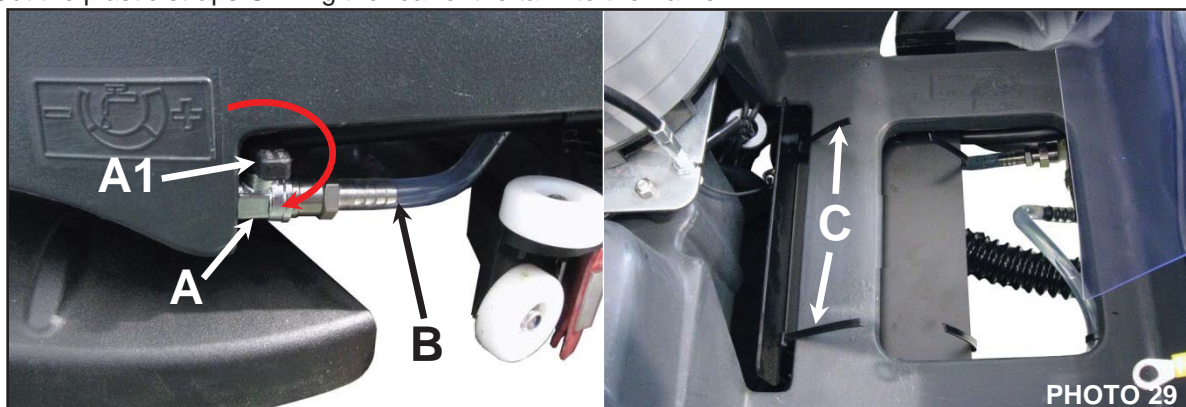

- 10 Remove the screw **D** securing the solution tank to the bottom front of the machine frame.

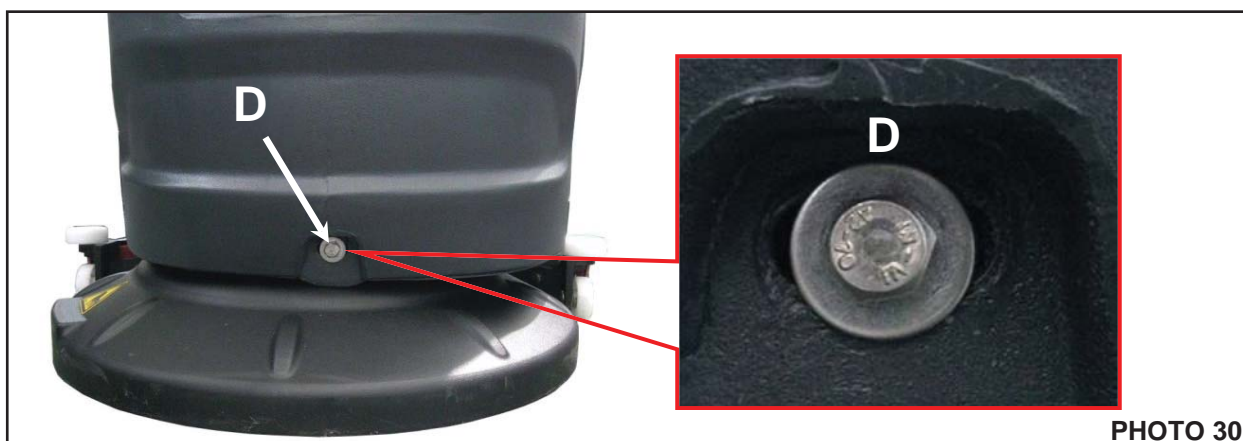



- 11 Lift from its seat the two fuse holders.
- 12 Detach the cable from the squeegee mounting by unscrewing the screw **E**.
- 13 Lift the solution tank up to the brush motor.

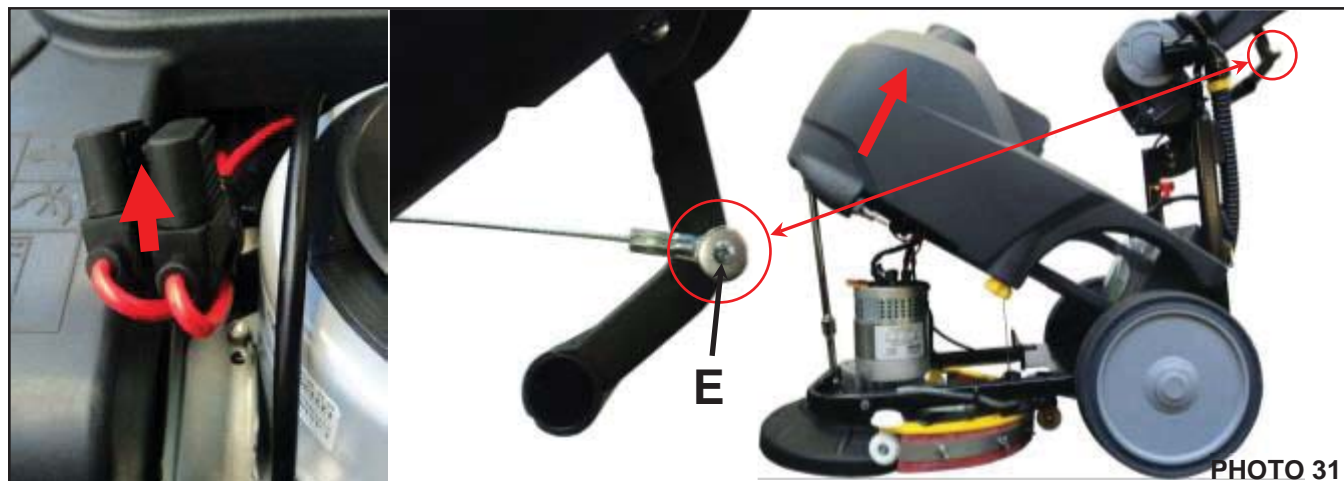

- 14 Disconnect the thermal cutout's two red bullet connectors **F**.
- 15 Pull the protective boots **G** away from power terminals and disconnect the power cables from the motor. When reassembling, make sure that you connect the cables correctly. The red cable must be connected to the positive "+" terminal.

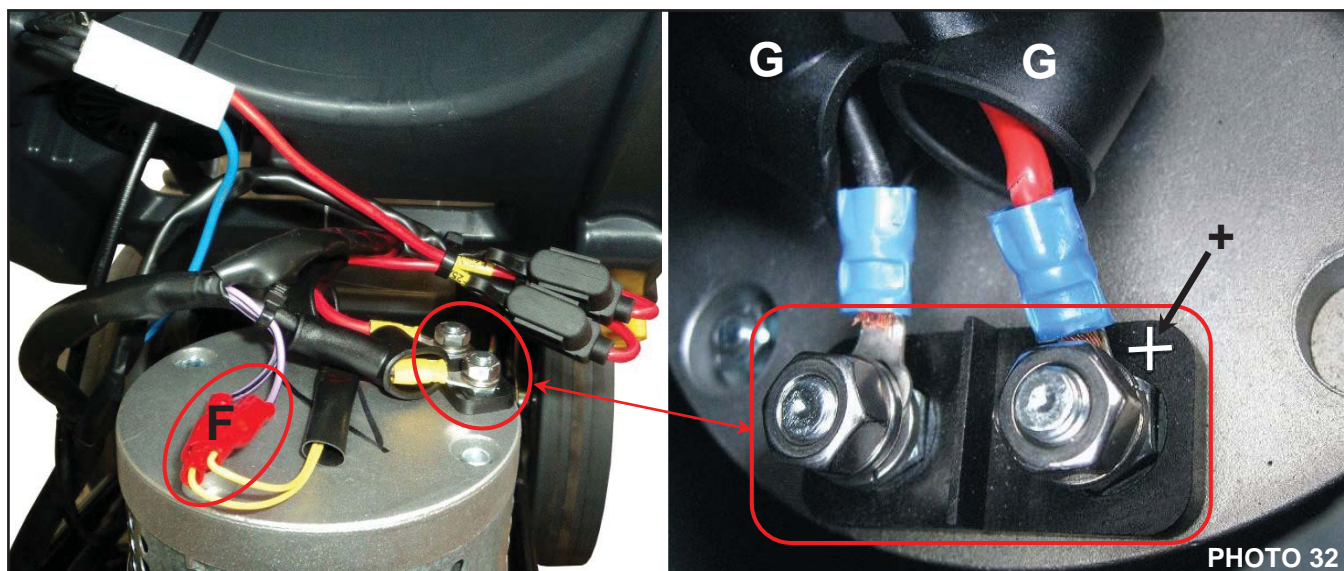



PLDC04626

REVISION 00

March 11, 2022

TECHNICAL DEPT.

Stavale

- 16 Remove the brush drive flange H.
- 17 Remove the stainless steel M8 x 20 mm bolt H1 along with its lock washer and flat washer.
- 18 Use a suitable puller to remove the brush drive flange H.

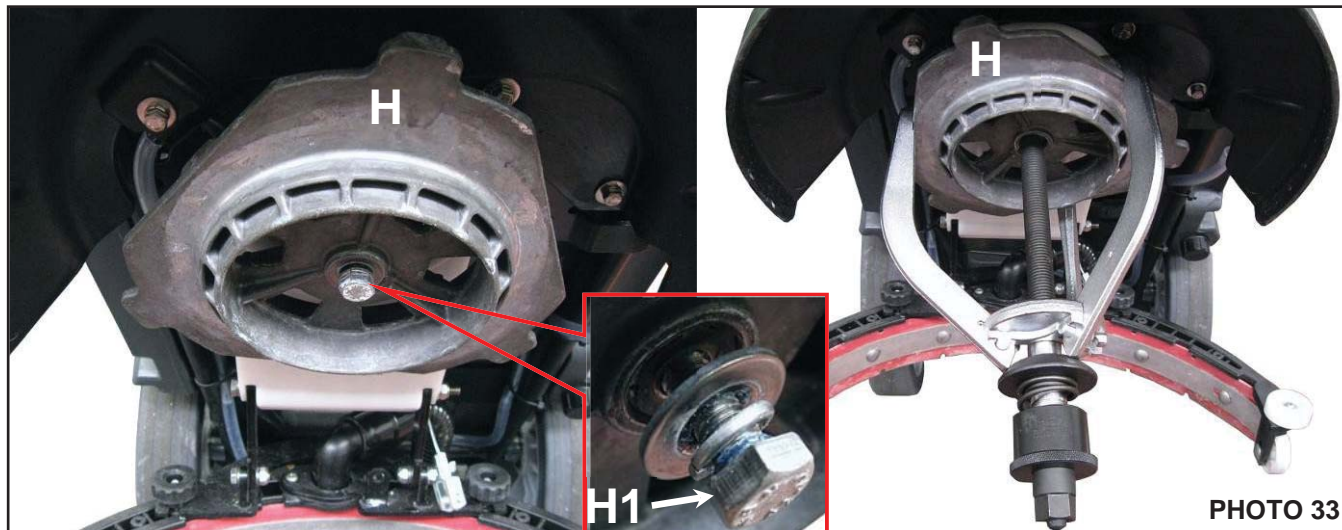

- 19 Remove the key I from the groove in the motor shaft and keep it safe.
- 20 Identify and remove the four bolts L securing the white plastic squeegee mounting.

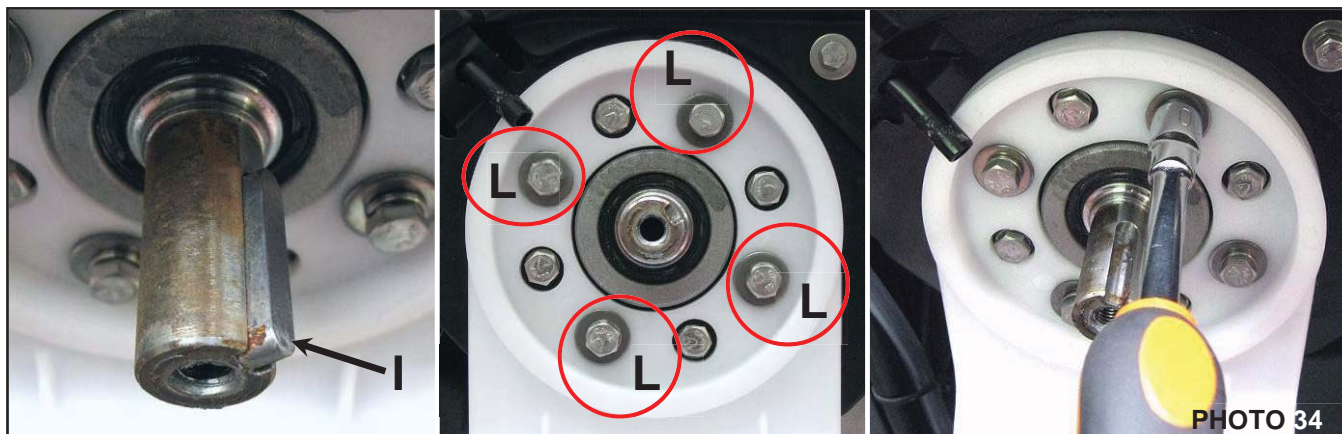

- 21 Remove the three bolts M securing the brush motor to its mounting.
- 22 Pull the machine frame and brush motor mounting away from the solution tank.
- 23 Remove the last bolt N securing the motor to the machine frame, while supporting the motor by hand so that it does not fall.

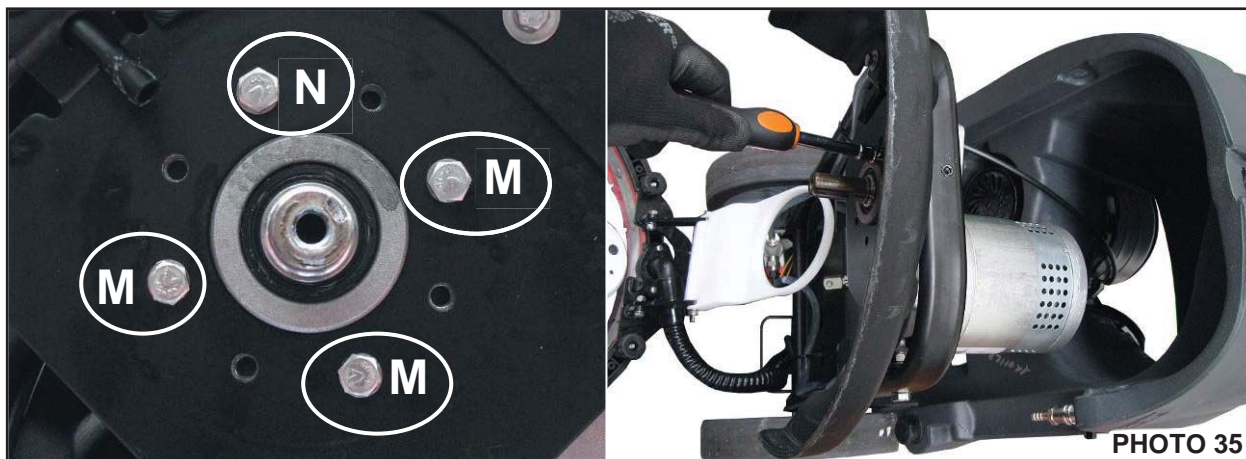

- 24** Remove the motor and replace it with an identical new one.
- 25** Before you fit the new motor, make sure that the key **I** engages properly with the groove in its shaft. It must be neither too tight nor (worse still) too loose. Also check that the brush drive flange **H** slides over the motor shaft without having to be forced.



PHOTO 36

- 26** Make sure that the motor is positioned as shown in the figure below before fitting and tightening the bolts **N** and **M**.



PHOTO 37

Reassembly

- 1** To fit the new motor, repeat the steps for disassembly in reverse order.
- 2** Make quite sure that the motor is correctly positioned on its mounting.
- 3** Tighten the bolts **L**, **M**, **N** to a maximum torque of 9 Nm / ~ 79,66 lbf-in.
- 4** Make sure that you connect the motor power cables the right way around, respecting polarity.



A2.2 Removing the brush motor from the CS16 Cord *Disassembly*

- 1 Move the machine to the tank draining area, and empty the solution tank and the collection tank.
- 2 Move the machine to a flat, dry floor. For convenience, use a fork lift if one is available.
- 3 Make sure that the machine is disconnected from the electricity supply.
- 4 Remove the brush and the collection tank.
- 5 Follow the procedure for removing the brush motor from “B” type battery powered machines. The only differences are that there is no need to remove the batteries, and that the brush motor connections are of a different type.
- 6 Cut the plastic straps **C** fixing the rear of the tank to the frame.
- 7 Locate and disconnect the waterproof electrical connector **E** for the power cable.

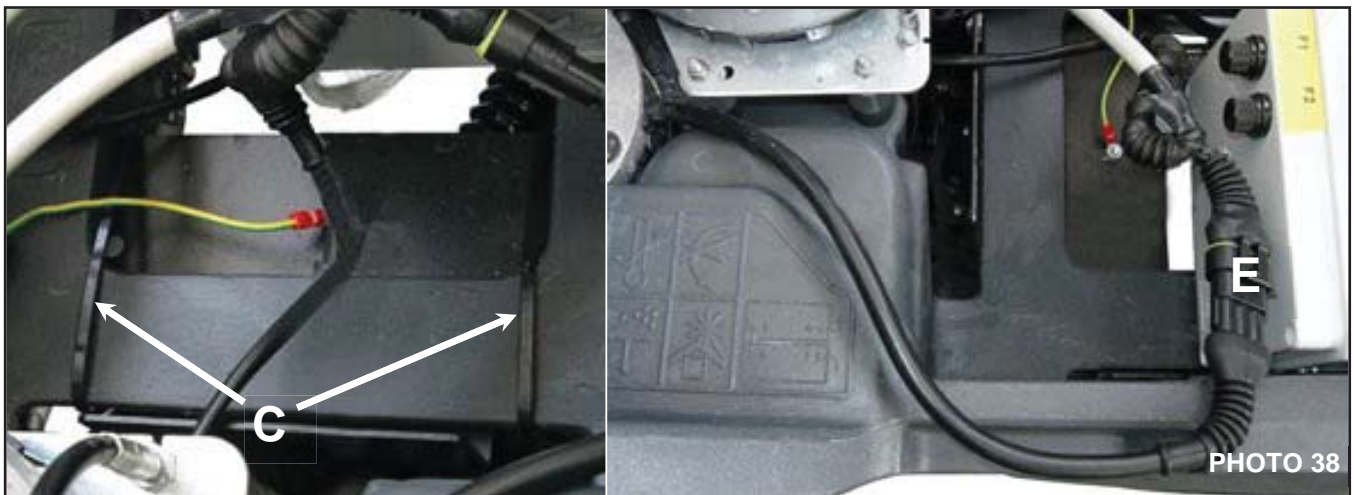

- 8 Arrange the motor cable (power **E**) so that they are not pulled when the motor is moved away from the solution tank.

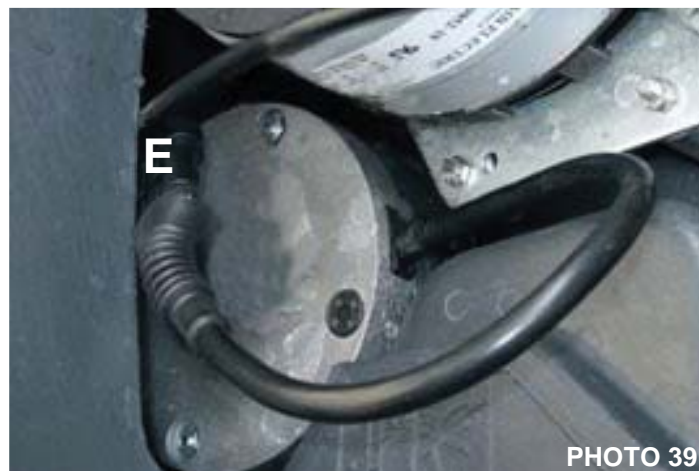

- 9 Follow the same procedure and precautions as for the “B” type battery powered version.

Reassembly

- 1 To fit the new motor, repeat the steps for disassembly in reverse order.
- 2 Make quite sure that the motor is correctly positioned on its mounting.
- 3 Tighten the bolts **L**, **M**, **N** to a maximum torque of 9 Nm / ~ 79.66 lbf-in.



A2.3 Removing the brush head from the CS16 Battery and Cord Disassembly

- 1 On "B" (battery powered) versions, follow the procedure given in section A2.1 "Removing the brush motor from the CS16 B", as far as step 16.
- 2 Remove the suction hose **A** from the union on the squeegee unit.
- 3 Remove the squeegee unit from its mounting.
- 4 Move the solution tank to gain access to the frame of the machine.
- 5 Disconnect the clear pipe **B** from the union on the brush head.

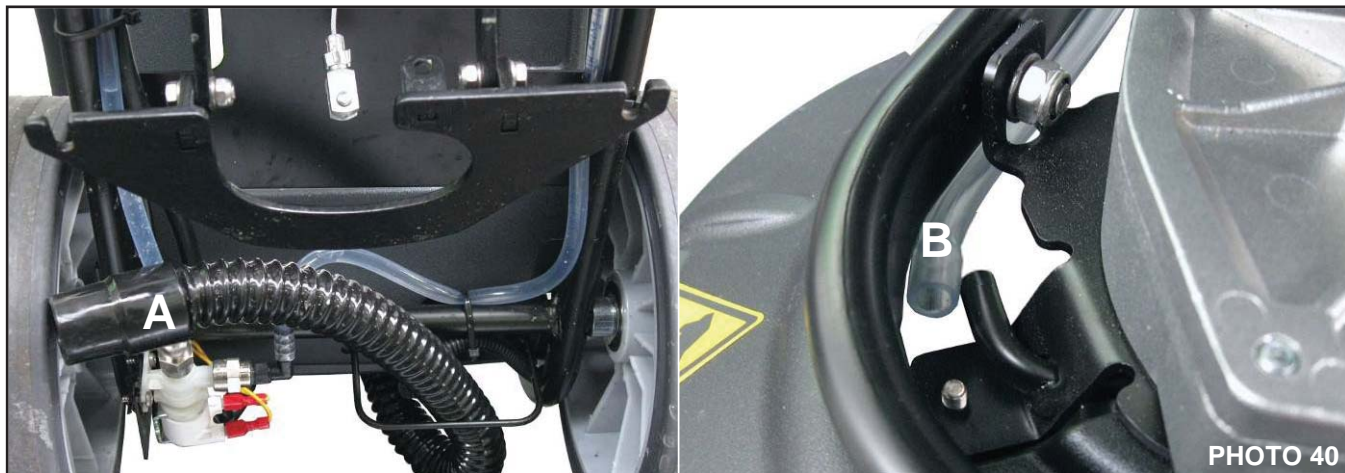

- 6 Identify the two bolts **B1** and **B2** securing the brush head **B** to the frame of the machine.
- 7 Remove the bolts **B1** and **B2**, taking care not to lose the bushes **C** and flat washers **D**.

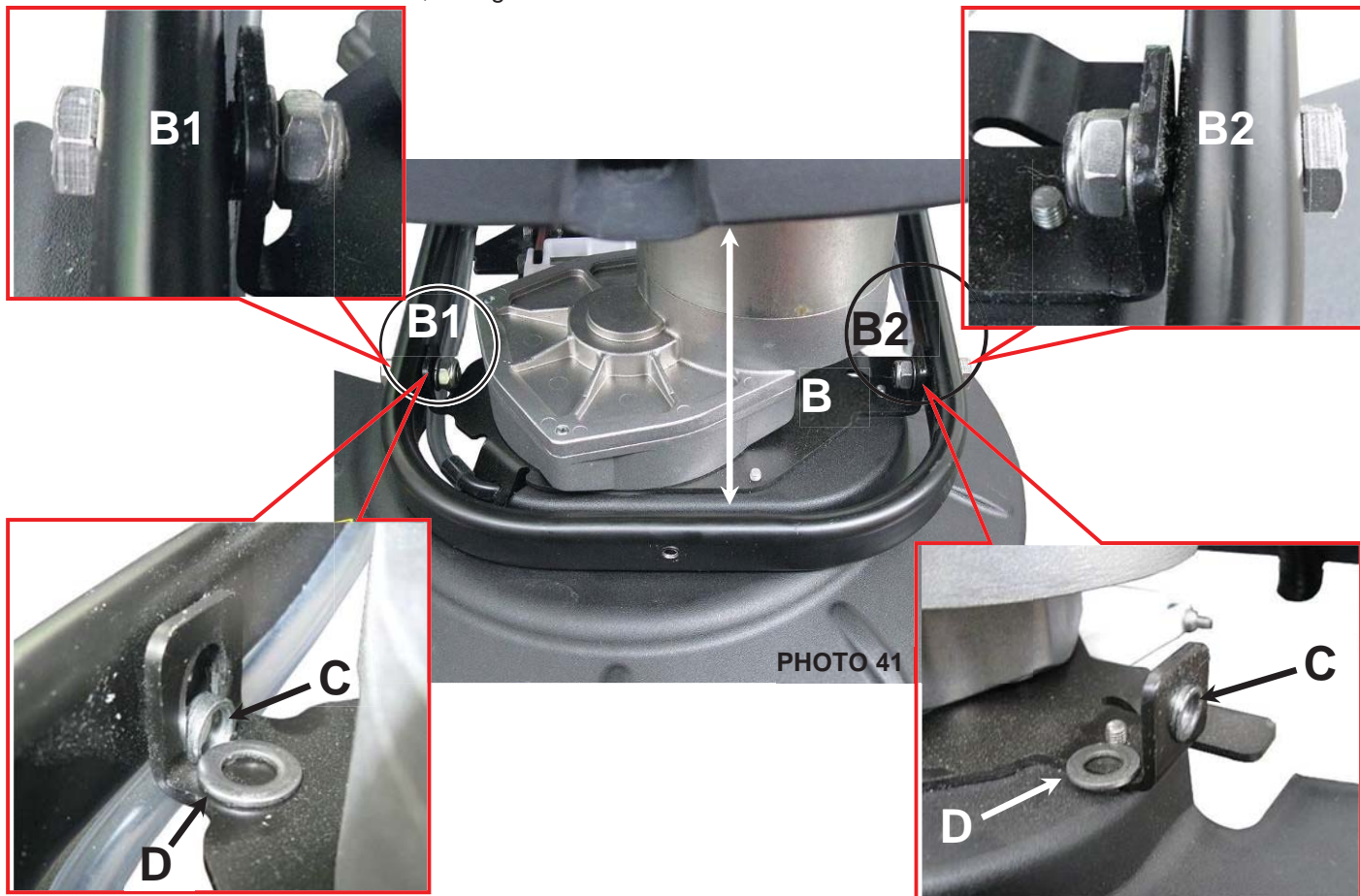

- 8 Lift the machine frame and pull out the brush head complete with brush cover and squeegee mounting.

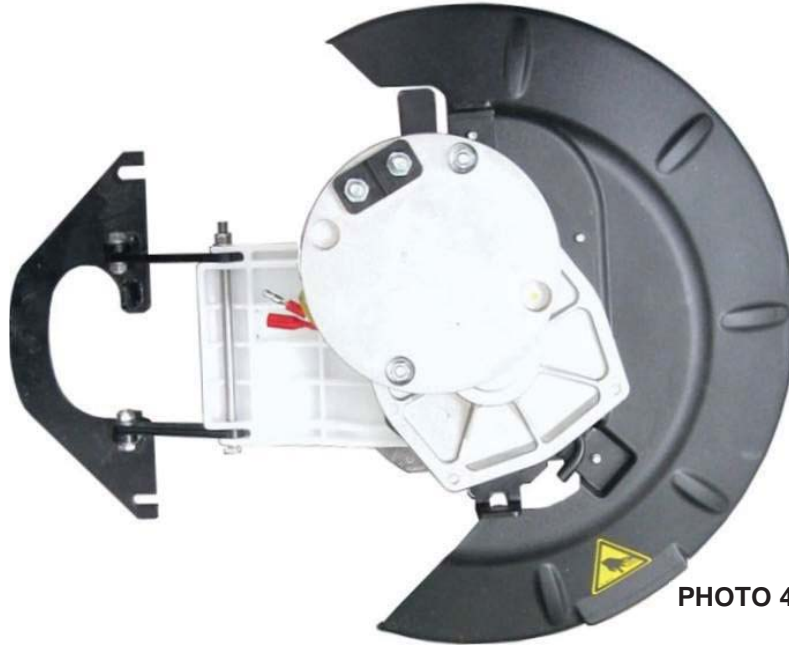

PHOTO 42

Reassembly

- 1 To fit the brush head, repeat the steps for disassembly in reverse order.
- 2 On completion of reassembly, make sure that the brush head pivots smoothly around the axes formed by bolts **B1** and **B2**.



It is extremely important for the head to pivot freely in order for the brush to follow any longitudinal slope in the floor irrespective of the position of the machine's rear wheels.



PHOTO 43

- 3 Tighten the bolts **B1** and **B2** to a maximum torque of 23 Nm / ~ 0,9 lbf-in.
- 4 Make sure that you connect the motor power cables the right way around respecting their polarity ("B" type battery version only).



PLDC04626

REVISION 00

March 11, 2022

TECHNICAL DEPT.

Stavale

A2.4 Replacing the brush motor's thermal protector



Though it is highly unlikely, the thermal protector in the brush motor may, in time, stop functioning properly and start cutting out at temperatures below that for which it was originally calibrated. It may even develop a fault causing its contacts to remain open, thus cutting off power to the motor.

Motor Thermal Operation Check

- 1 Remove the back cover, detach the 4-pin connector and check for continuity of the thermal and your own wiring. Check the two purple-black wires on the connector.
- 2 If there is no continuity proceed to replace the motor thermal.

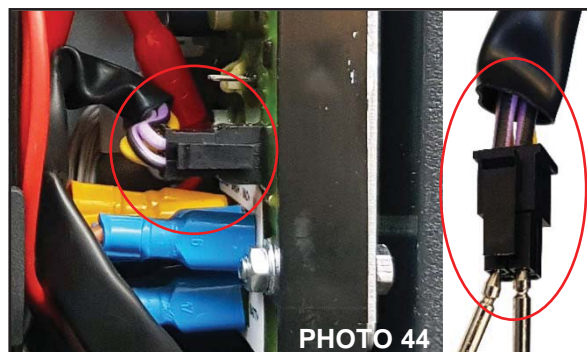

PHOTO 44

Disassembly

- 1 Remove the brush motor from the machine as instructed in section A2.1, and take it to the work bench.
- 2 Remove the screw **A1** and remove the metallic strap **A** along with the plastic clamp **A2**.

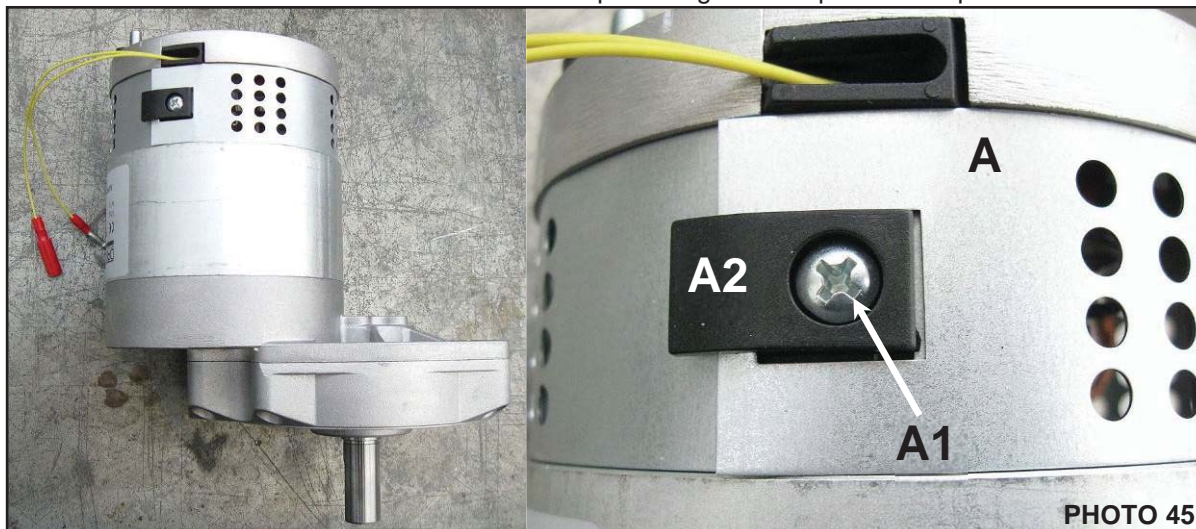

PHOTO 45

- 3 **CT 15 B:** Remove the four carbon brushes **B** as instructed in section A1.3.

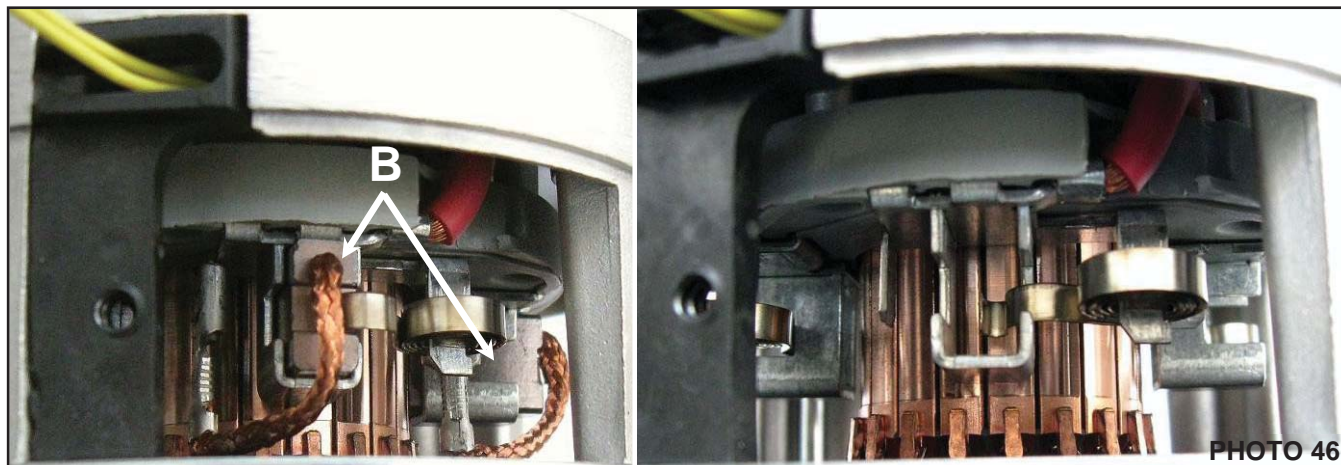

PHOTO 46



PLDC04626

REVISION 00

March 11, 2022

TECHNICAL DEPT.

Stavale

- 4 Remove the two bolts **C1** from the top of the motor cover **C**.



- 5 Rest the brush motor on its side, and pull off the cover **C**, applying the necessary force.
6 Take care not to lose the shims **C2** from the bearing housing in the cover. Remove the bearing **D**.
7 Pull the plastic guard **C3** for the thermal protector cables upwards and remove it.

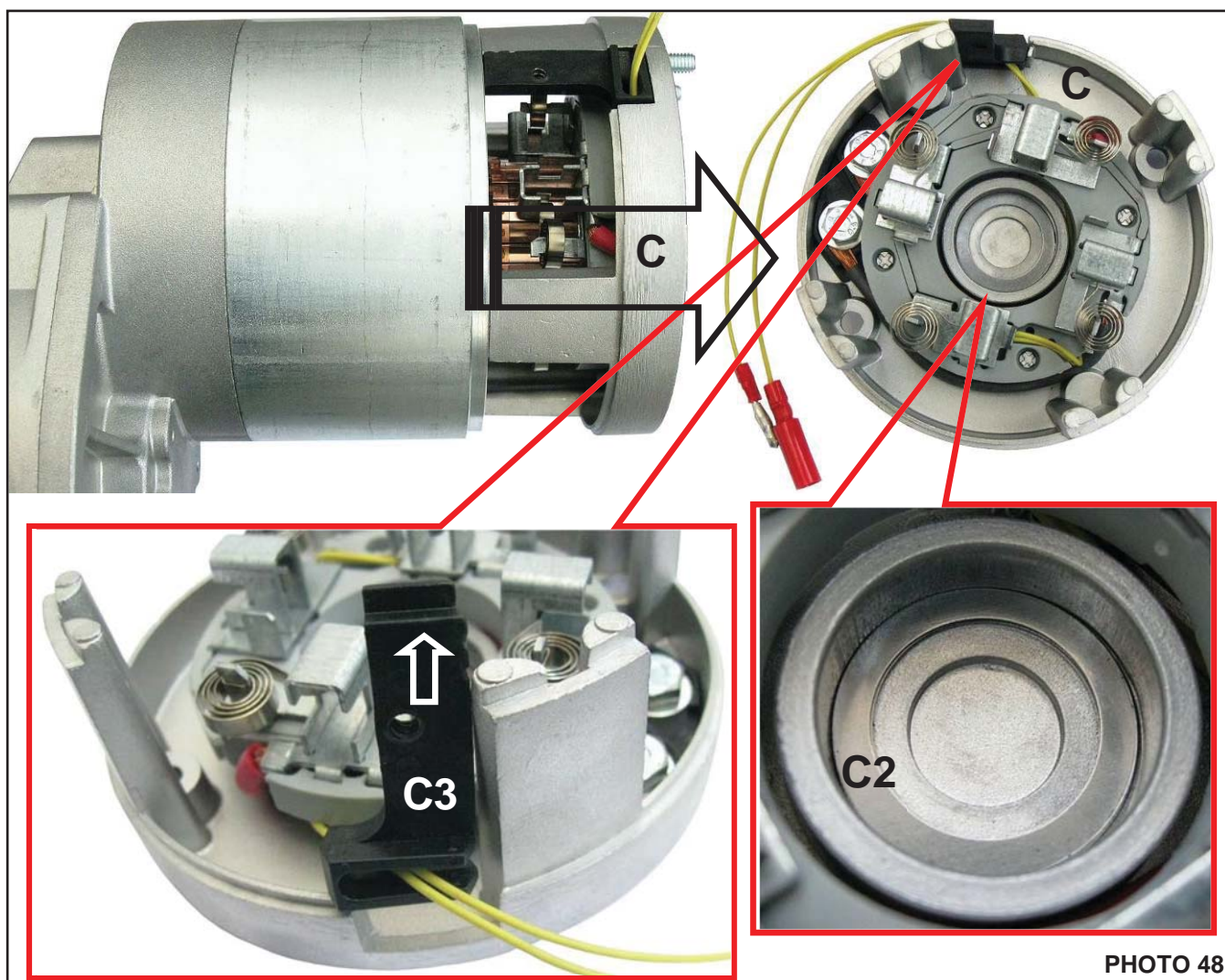



PLDC04626

REVISION 00

March 11, 2022

TECHNICAL DEPT.

Stavale

Reassembly

- 1 Before fitting a new cover **C**, fit the shims **C2** and the bearing **D** in the bearing housing.
- 2 Check the rotor **E** for wear, paying particular attention to the area with which the carbon brushes come into sliding contact. Clean and/or recondition as necessary.
- 3 Also check the condition of bearing **D**, turning the races by hand to test for noise or roughness, and inspecting it carefully for any violet colouration that could indicate overheating.

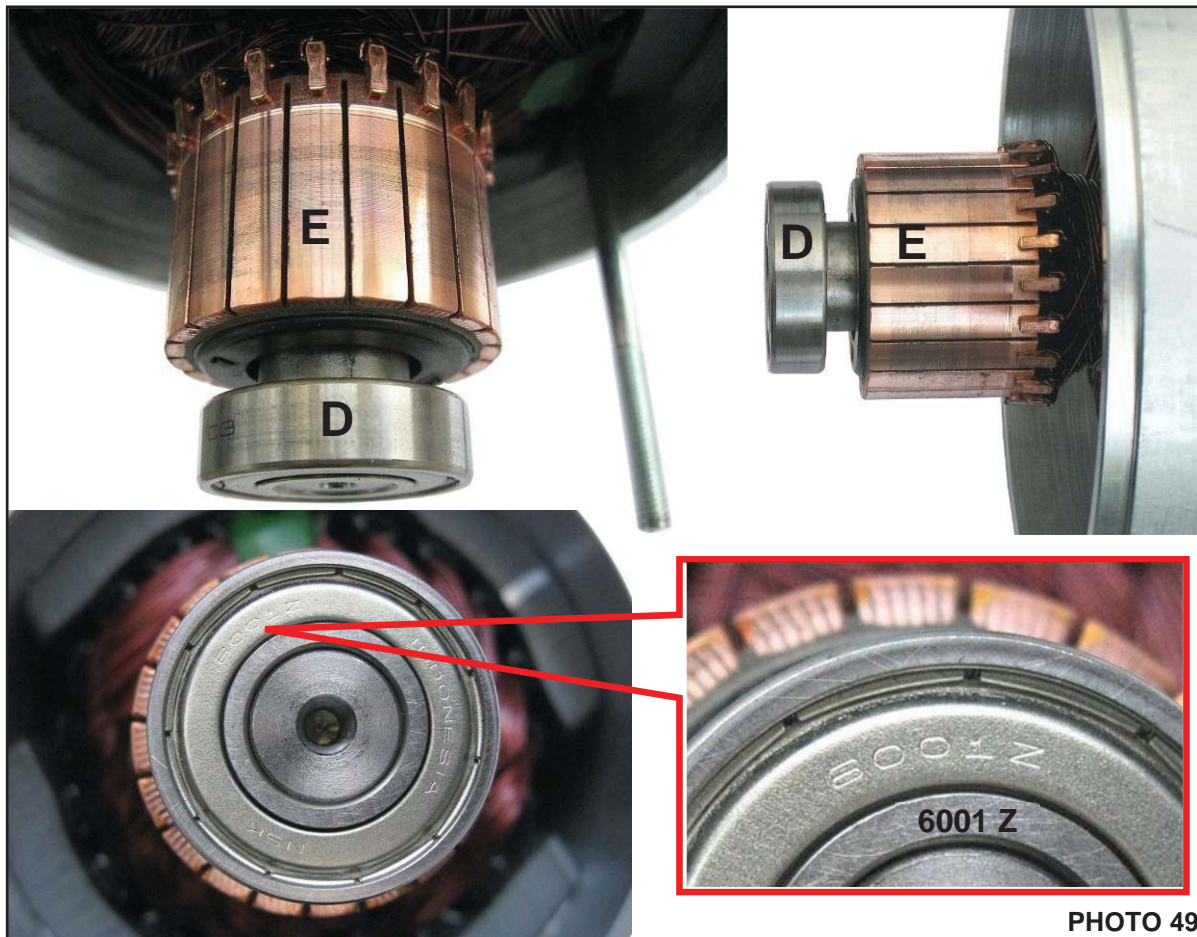

PHOTO 49

- 4 Fit the new cover **C** with the electrical connections on the opposite side to the gear unit, as shown in the figure below.

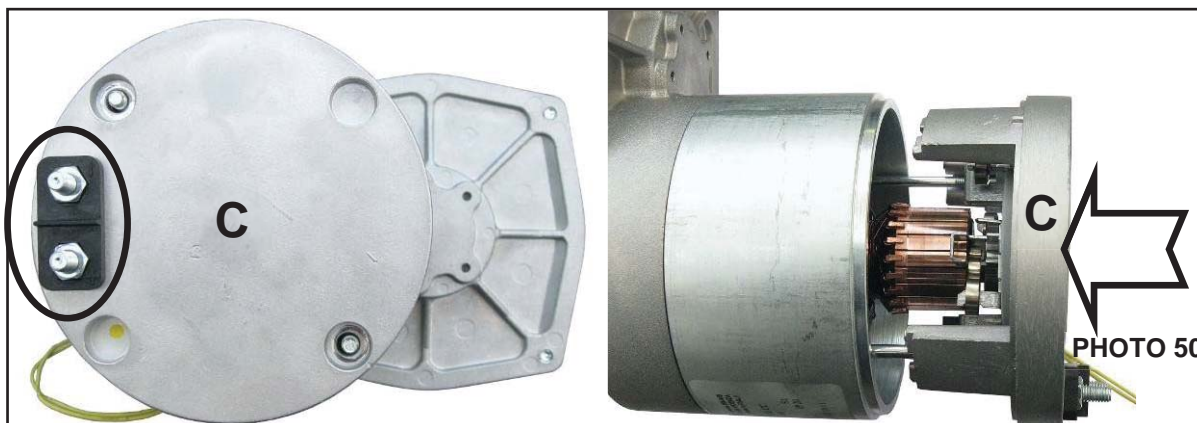

PHOTO 50

- 5 To fit the new cover, repeat the steps for disassembly in reverse order.
- 6 Tighten the bolts **C1** to a maximum torque of 6 Nm / ~ 53.1 lbf-in.
- 7 To fit the carbon brushes, see sections A1.3.



PLDC04626

REVISION 00

March 11, 2022

TECHNICAL DEPT.

Stavale

B

TANKS AND SUCTION SYSTEM

⚠ WARNING!

Go to the designated draining area and empty the solution and collection tanks using the drain plugs and the hoses provided.

Position the machine on a flat floor, and place wedges under the wheels to stop it moving.

Switch the machine off and disable all functions by pressing the “On–Off” button on the control panel.

Disconnect the machine’s electrical system by removing the main fuse F1, or by disconnecting the terminals from the battery poles (battery powered machines), or by removing the plug from the mains power socket (mains powered machines).

i INFORMATION

Important information

In this Service Manual, the terms **RIGHT** and **LEFT** are used to indicate the sides of the machine. They always refer to the direction of travel.

In this Service Manual, the machine version (**CS16 B** = battery, **CS16 C** = corded) may appear between brackets “()”. This indicates that the instruction in question refers only to the version specified.



PLDC04626
 REVISION 00
 March 11, 2022
 TECHNICAL DEPT.
 Stavale

B1 SUCTION MOTOR

On the scrubber CS16, the suction motors of “B” type battery versions and “C” type mains versions are very similar. Apart from the power source (24 V DC for battery versions and 240V AC / 50-60 Hz cord versions), the differences lie in the motors’ maximum power consumption (~ 550W for battery type motors, and ~ 400W for cord type motors) and in the type of connections. The motors of mains powered versions feature waterproof terminals to provide increased protection against electric shock. The number of turbine stages also differs: three for battery type machines and two for cord type machines.



PHOTO 51

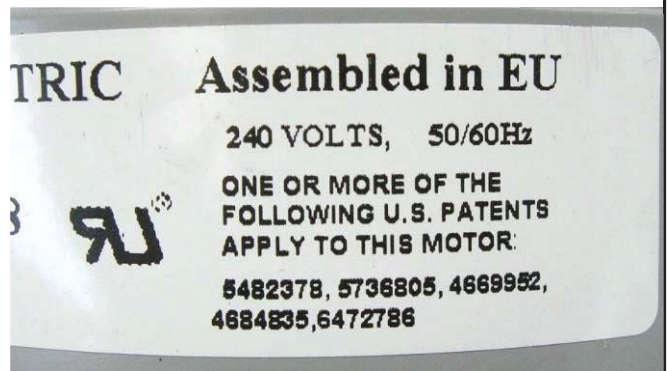
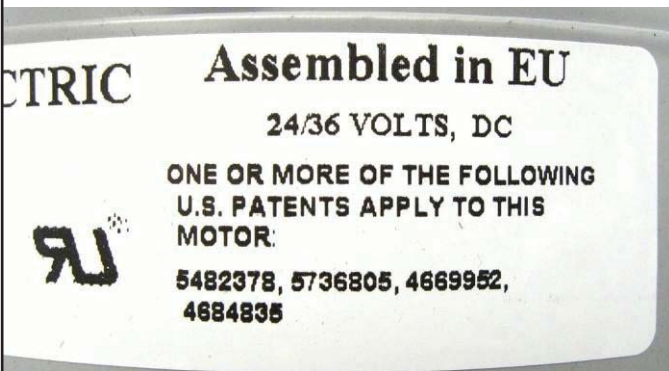

B1.1 Measuring vacuum motor current draw on the CS16 Battery Disassembly

- 1 Make sure the batteries on the machine are fully charged ($24V \pm 1V$).
- 2 Use a clamp-on ammeter with a full scale reading of at least 200 A (amperes) as shown below.

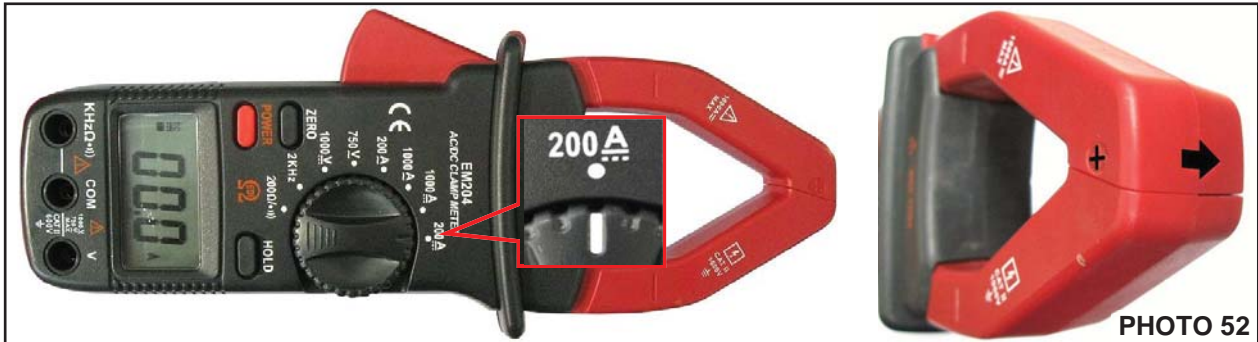

PHOTO 52

- 3 Move the machine to the tank draining area, and completely empty the collection tank A.
- 4 Make sure that you have enough room around the machine to perform the measurement safely.
- 5 Lift up and remove the collection tank A to access the fuse B of the suction motor.

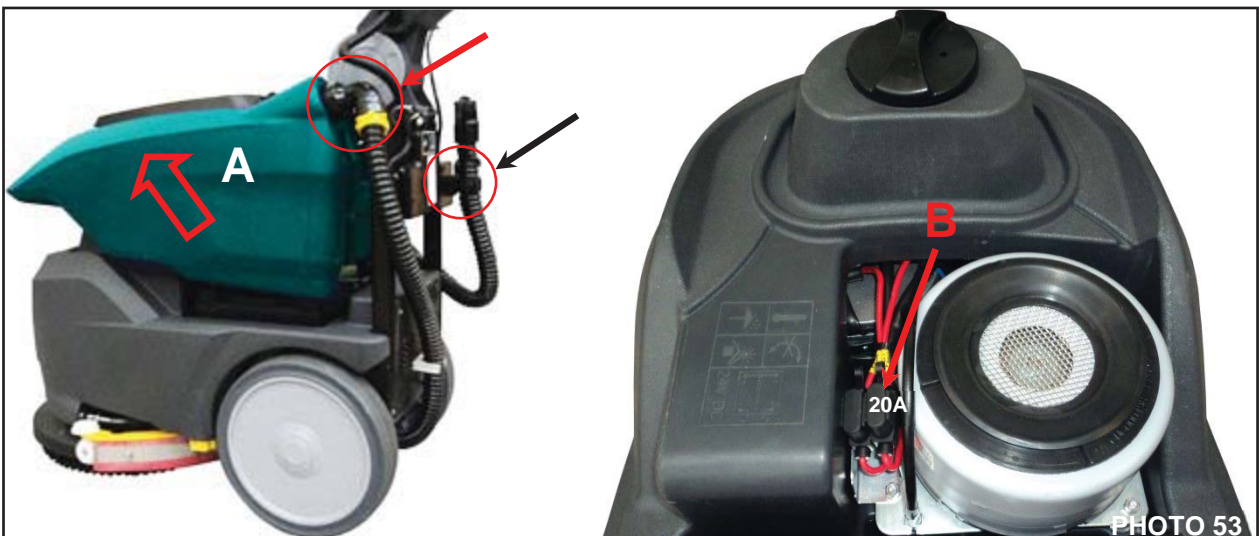

PHOTO 53

- 6 Set the clamp-on ammeter to measure amperes (A) of DC current and clamp it to cable of the suction motor.
- 7 Press the "On-Off" button to switch the machine on, and press the brush button C and the solution dispensing button D to switch off the associated functions.
- 8 Pull in the control lever E on the handle. Read and record the current draw of the suction motor.

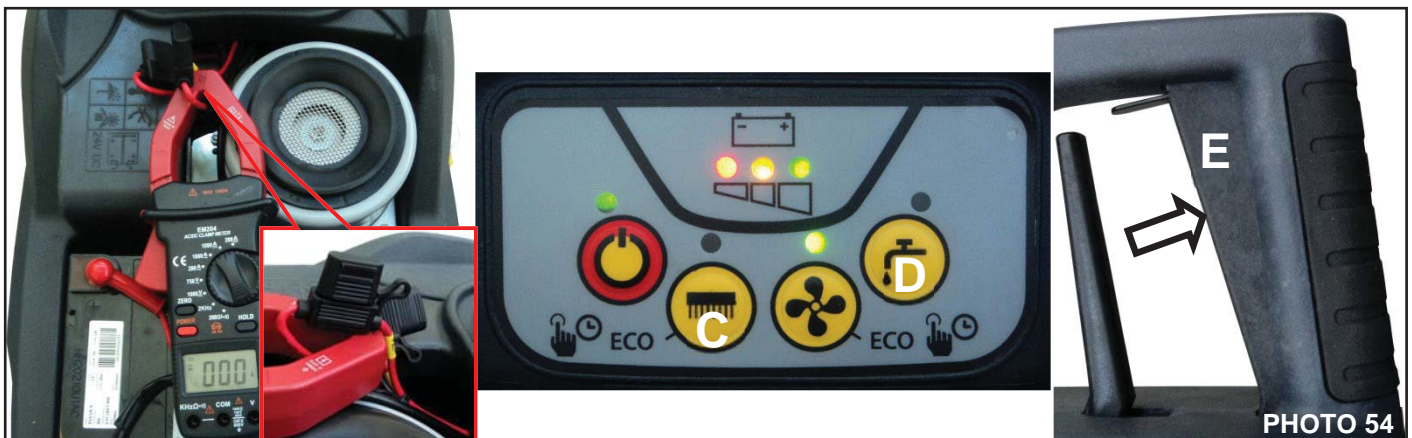

PHOTO 54



On the scrubber CS16 Battery, the suction motor is powered by the power control card. This imposes a current ramp, so you are unlikely to see in-rush current peaks. For this reason, always wait a few seconds for current draw to stabilise before taking the reading.

- 9** Compare the measured value with the values specified in the table below.
- 10** Provided the current draw values lie between the minimum and maximum values specified in the table below, the motor is functioning correctly. You can now remove the ammeter and replace the collection tank.
- 11** If the measured value is correct, but the machine's suction is poor, check the condition of the squeegee flaps. Also check the condition of the suction hose: there must be no holes or cracks in it. Check that the seals at the tank cap and on the suction motor are in good condition.
- 12** If the measurements still do not correspond to those specified, proceed as follows:
 - 12a** Check that battery voltage has not fallen under 24 V by more than 2 V. Larger drops in voltage indicate that the batteries are starting to lose their efficiency. Under such conditions the suction motor will tend to draw more current.
 - 12b** If the current draw of the suction motor exceeds the maximum values specified in the table below, but battery voltage has not fallen significantly, check the motor's carbon brushes.
 - 12c** If the current draw of the suction motor exceeds the maximum values specified in the table below, but the motor's carbon brushes are in good condition, replace the entire suction motor.

Current draw A (amperes)	Min	Max
<i>No load (without recovery tank)</i>	13 A	17 A



PLDC04626

REVISION 00

March 11, 2022

TECHNICAL DEPT.

Stavale

B1.2 Removing the vacuum motor from the CS16 Battery *Disassembly*

- 1 Move the machine to the tank draining area, and completely empty the collection tank.
- 2 Move the machine to a flat, dry floor. For convenience, use a fork lift if one is available.
- 3 Remove the collection tank from the machine.
- 4 Disconnect and remove the batteries from the battery compartment.

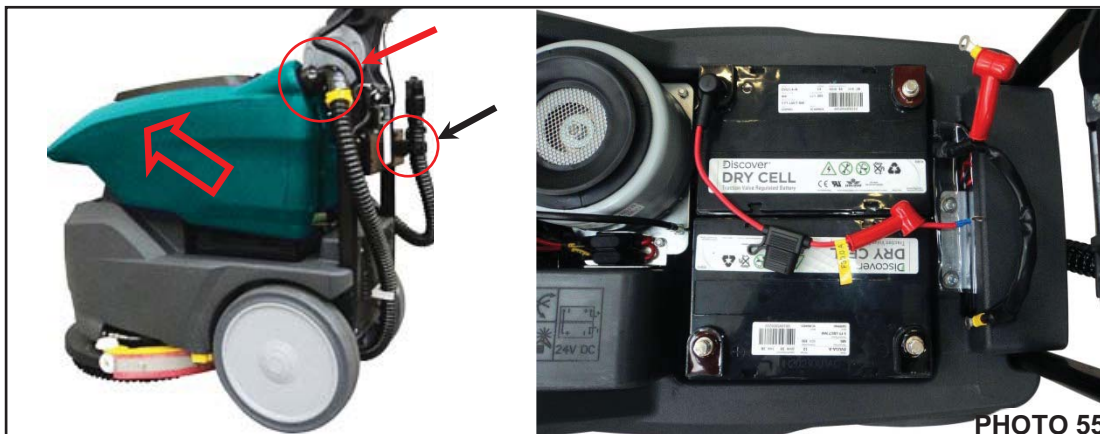

- 5 Lower the squeegee by means of its operating lever.
- 6 Cut the plastic strap **A** securing the cables, and disconnect the plastic connector **B** to the suction motor.

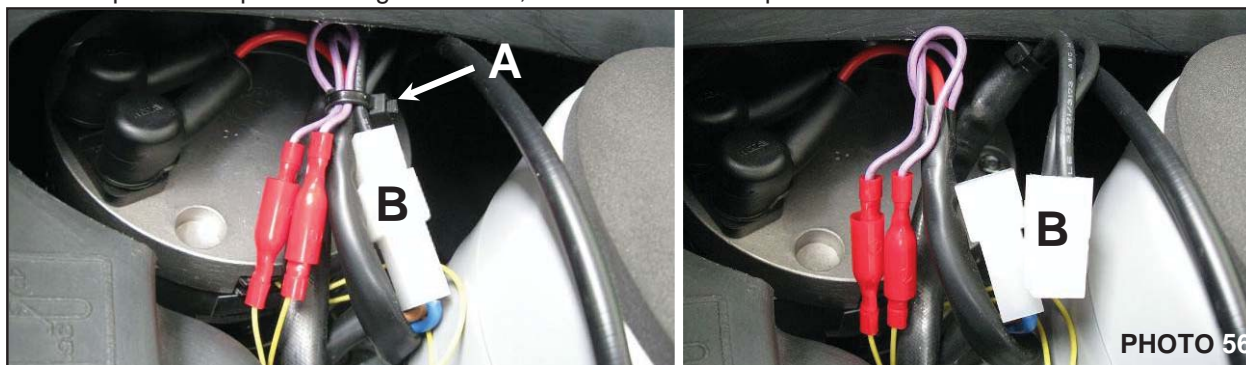

- 7 Free the power connector **B** from the other cables.
- 8 Identify the four nuts **C** securing the bracket **D** of the suction motor to the solution tank.
- 9 Remove the four nuts **C**, taking care not to lose the lock washers from underneath them.

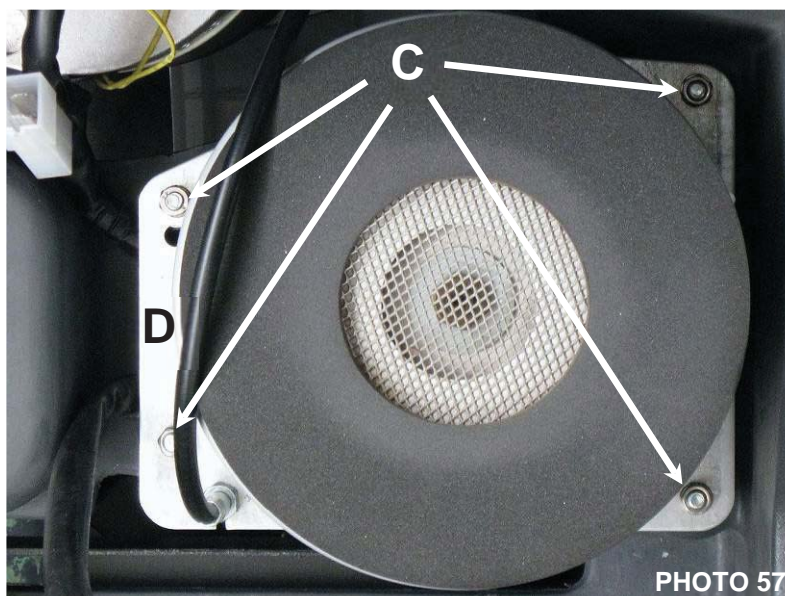



PLDC04626

REVISION 00

March 11, 2022

TECHNICAL DEPT.

Stavale

10 Lift the motor, complete with its bracket **D**. Disengage it from the anti-vibration mountings, and turn it through 180° (upside down).

11 Identify the four self-tapping screws **E** securing the bracket **D** to the suction motor.



12 Remove the four self-tapping screws **E** securing the bracket **D** to the suction motor.

13 Remove the bracket **D** from the suction motor.

14 Replace the suction motor with a new one.

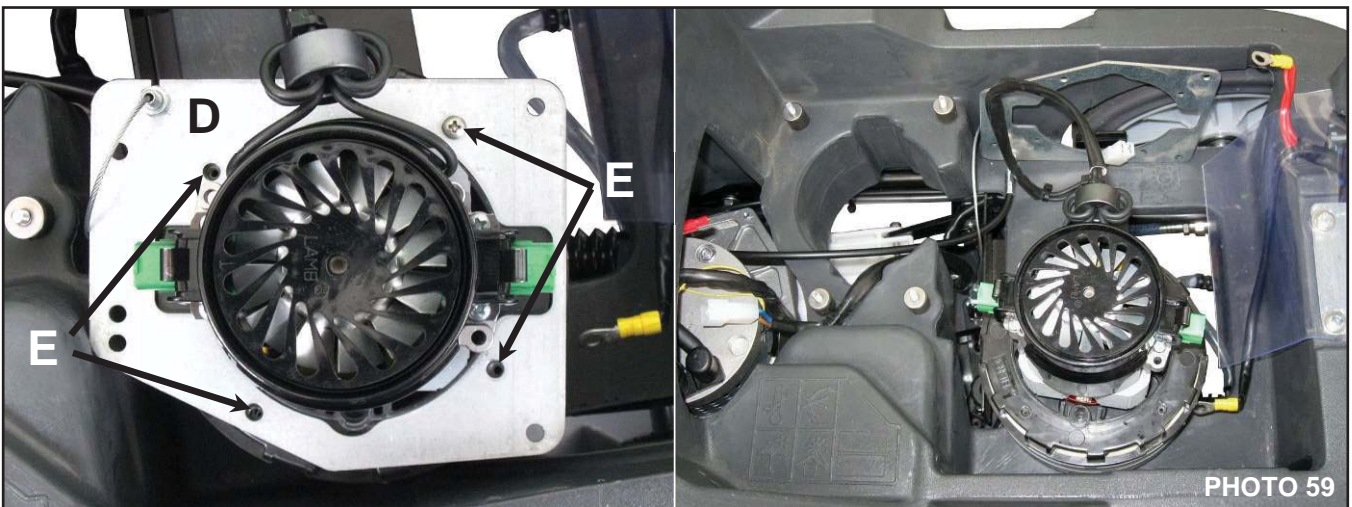

Reassembly

1 When fitting a new suction motor, also order and fit a new plastic strap **F**.

2 To fit the new suction motor, repeat the steps for disassembly in reverse order.

3 Take care not to over-tighten the screws **E**.





PLDC04626

REVISION 00

March 11, 2022

TECHNICAL DEPT.

Stavale

B1.3 Replacing the vac. motor's carbon brushes on the CS16 "B" Disassembly

- 1 Follow the procedure for removing the suction motor, given in section B1.2, as far as step 10.
- 2 With the suction motor turned upside down, remove the cover **A** from the cooling fan.
- 3 Gently press outward the two clips **B** and **C**, and lift the cover **A** off the cooling fan. Release one clip at a time.

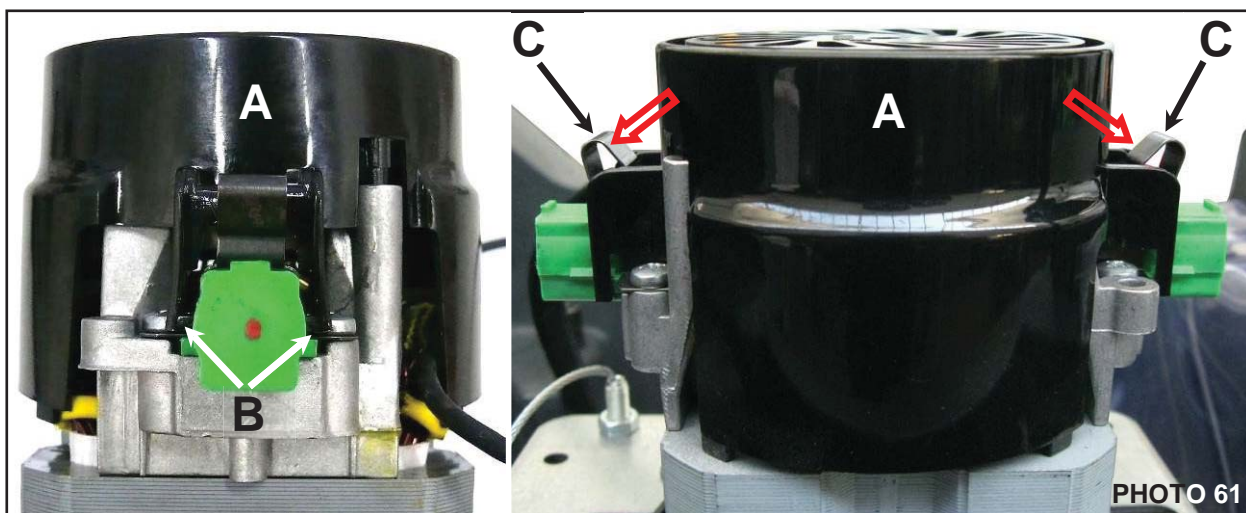

- 4 Remove the screws **D** (two per brush) securing the brackets **F** over the carbon brushes **E**.
- 5 Remove the carbon brushes **E** from the brackets **F**, lifting them gently and pulling them out of their seats. If you encounter any resistance, push the dark part **E1** in with a screwdriver.

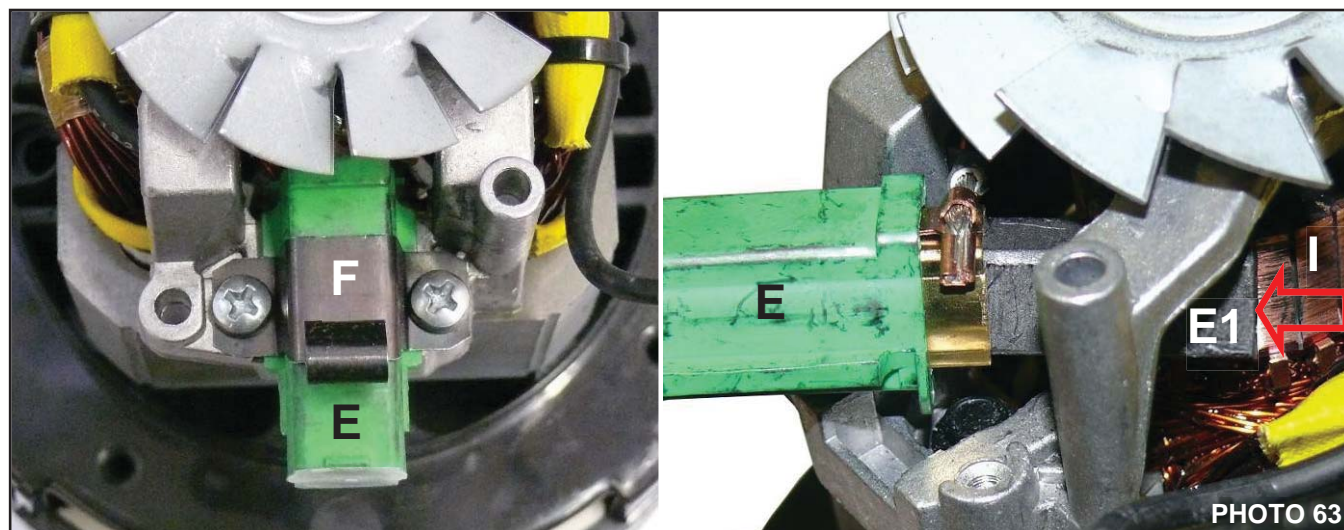
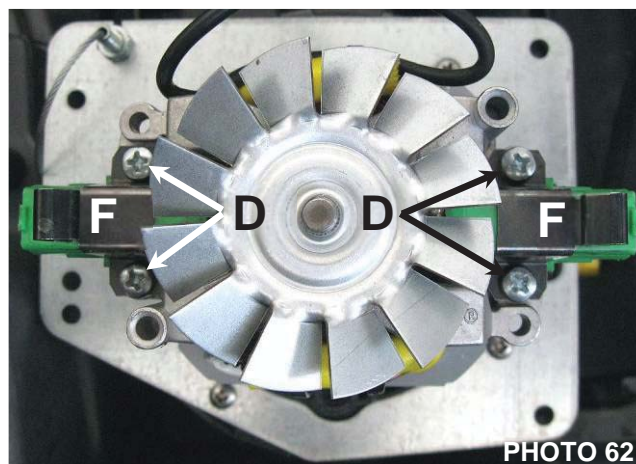

- 6 Check the carbon brushes for wear and for signs of burning on the surface that comes into sliding contact with the rotor. Check also that the carbon brushes are free to slide in their seats and that the springs push with sufficient force for their entire stroke.
- 7 Provided the carbon brushes satisfy the above conditions, measure the dark (carbon/graphite) part **E1**.
- 8 The correct length of the carbon brushes is between maximum 23 mm / 0.91 in and minimum 8 to 6 mm / 0.31 to 0.24 in, replace them.

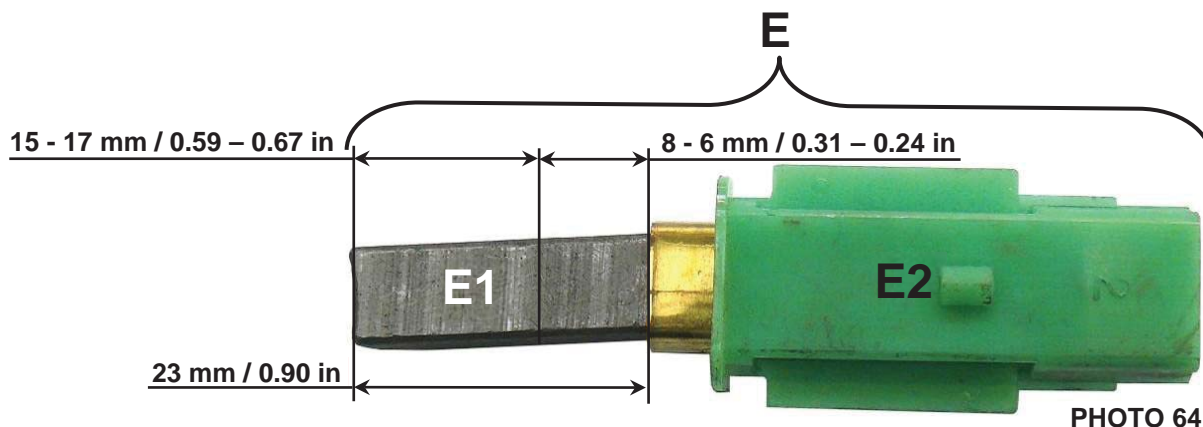

PHOTO 64



Always replace both carbon brushes together.

Replacement

- 9 Proceed as follows to replace the carbon brushes.
- 10 Identify the cable **G** connecting the carbon brush to the motor's electrical system.
- 11 Use a screwdriver to gently lift the plastic part **E2** of the carbon brush holder while simultaneously pulling out the cable **G** and terminal **H**.

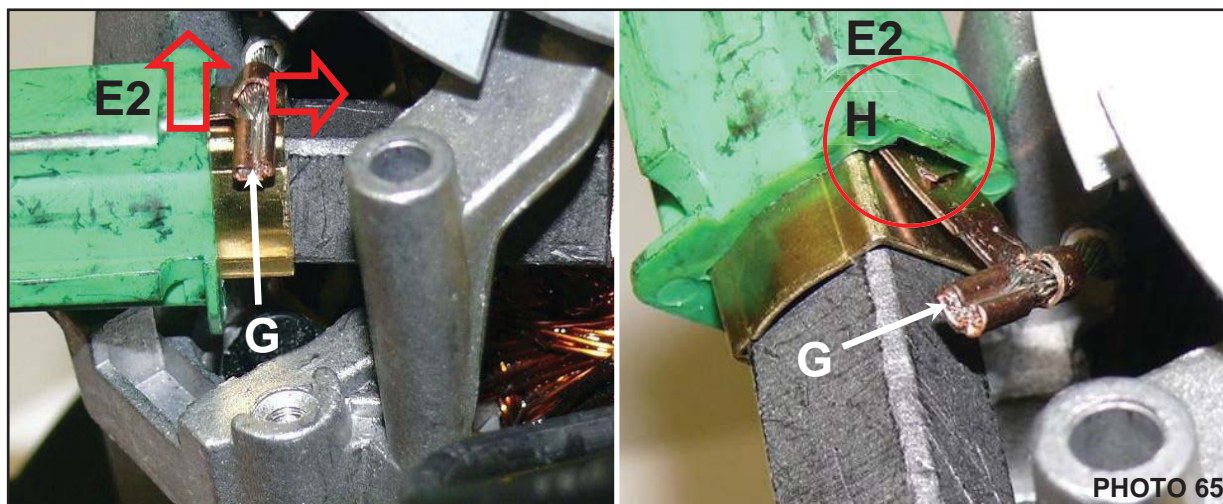

PHOTO 65

- 12 Disconnect the old brush from the terminal **H** by opening the terminal clamp.
- 13 Fit the new carbon brushes. Push the terminals **H** into their seats and check that they make firm contact.
- 14 Connect the terminals of the two carbon brushes to the cables **G**, and reassemble the suction motor.

Reassembly

- 1 To fit the new carbon brushes, repeat the steps for disassembly in reverse.
- 2 Check the rotor **I** of the suction motor for wear before fitting new carbon brushes.
- 3 Blow the inside of the motor clean with a jet of compressed air, paying particular attention to the area around the carbon brushes and to the area of the rotor **I** with which the carbon brushes **E** come into sliding contact.



PLDC04626

REVISION 00

March 11, 2022

TECHNICAL DEPT.

Stavale

B1.4 Removing the suction motor from the CS16 “Cord”

Disassembly

- 1** Move the machine to the tank draining area, and completely empty the collection tank.
- 2** Move the machine to a flat, dry floor. For convenience, use a fork lift if one is available.
- 3** Make sure that the machine is disconnected from the electricity supply.
- 4** Remove the collection tank from the machine.
- 5** Follow the procedure for removing the suction motor from “B” type battery powered machines. The only differences are that there is no need to remove the batteries, and that the suction motor connections are of a different type.
- 6** Locate and disconnect the waterproof electrical connector **A** for the power cable.
- 7** Lift the motor complete with its bracket **B**. Disengage it from the anti-vibration mountings, and turn it through 180° (upside down).
- 8** Identify the four self-tapping screws **C** securing the bracket **B** to the suction motor.
- 9** Remove the screws **C** and lift off the bracket **B** off the motor.
- 10** Replace the suction motor with a new one.

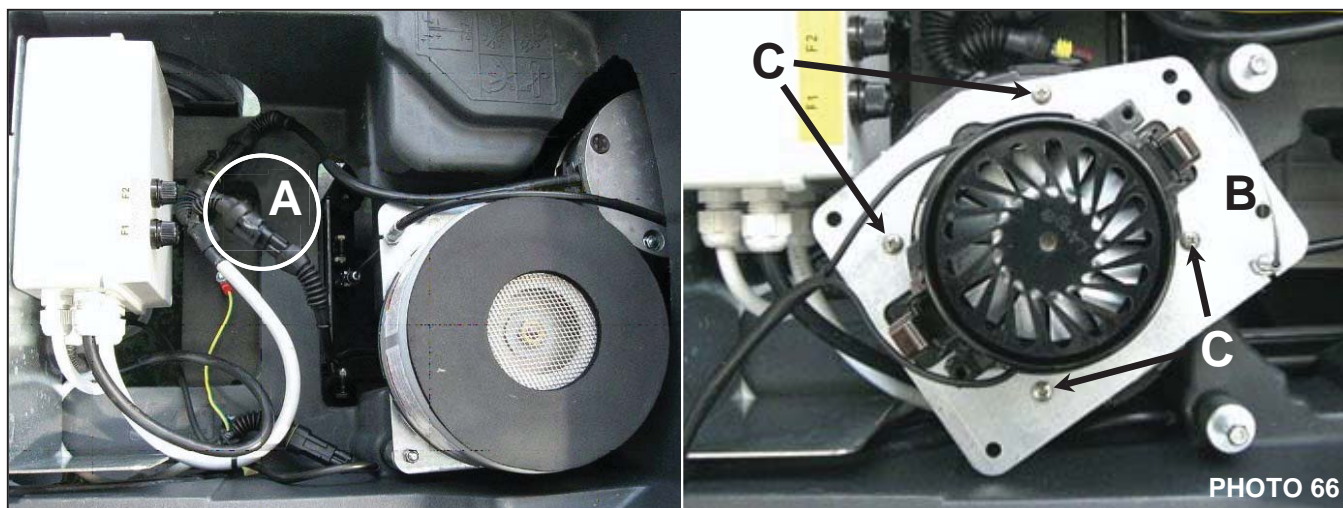

- 11** Follow the same procedure and precautions as for the “B” type battery powered version. Take care not to over-tighten the screws **C**.

Reassembly

- 1** When fitting a new suction motor, also order and fit a new plastic strap **F**.
- 2** To fit the new suction motor, repeat the steps for disassembly in reverse order.





B1.5 Replacing the vac. motor's carbon brushes on the CS16 C Disassembly

- 1 Follow the procedure for removing the suction motor, given in section B1.4, as far as step 7.
- 2 With the suction motor turned upside down, remove the cover **A** from the cooling fan, following the instructions given in section B1.5 for battery powered machines.
- 3 Remove the screws **B** (two per brush) securing the brackets **D** over the carbon brushes **C**.

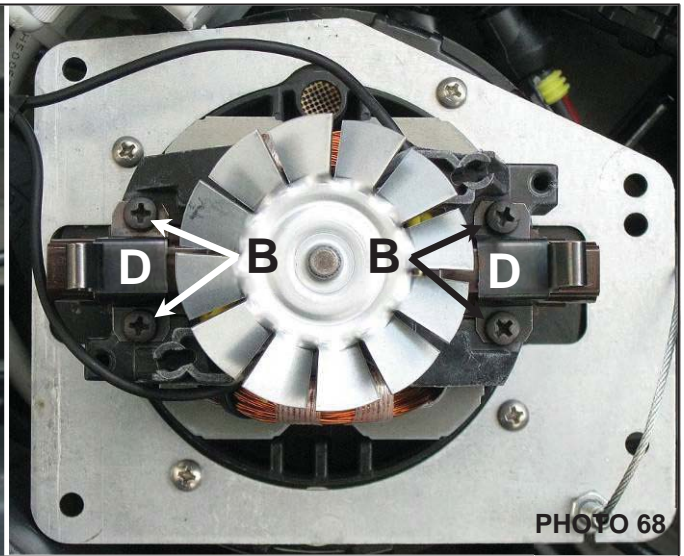

- 4 Remove the carbon brushes **C** from the brackets **D**, lifting them gently and pulling them out of their seats. If you encounter any resistance, push the dark part **C1** in with a screwdriver.
- 5 Check the carbon brushes for wear and for signs of burning on the surface that comes into sliding contact with the rotor. Check also that the carbon brushes are free to slide in their seats and that the springs push with sufficient force for their entire stroke.
- 6 Check the rotor **E** of the suction motor for wear.
- 7 Provided the carbon brushes satisfy the above conditions, measure the dark (carbon/graphite) part **C1**.
- 8 The correct length of the carbon brushes between maximum 29 mm / 1,14 in and minimum 8 mm / 0.31 in to 6 mm / 0.24 in. If the carbon brushes are shorter than 8 to 6 mm / 0.31 to 0.24 in, replace them.

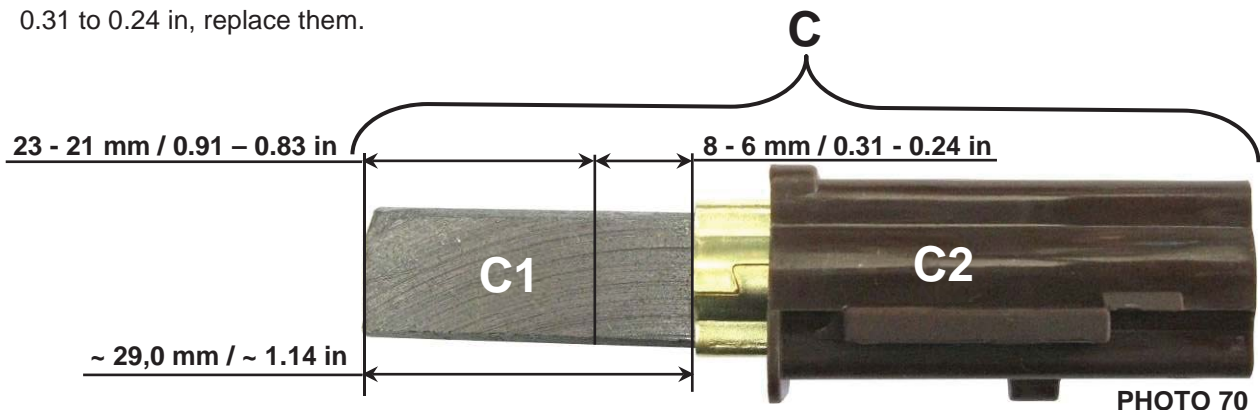
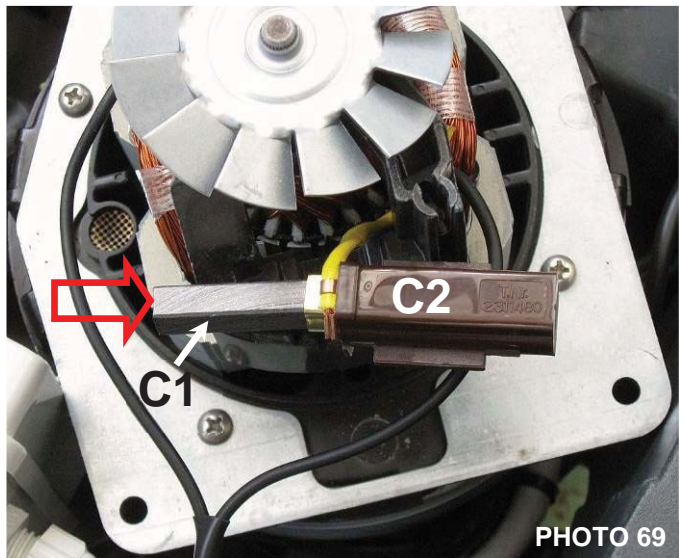

Replacement



Always replace both carbon brushes together.

- 9 Identify the cable **F** connecting the carbon brush to the motor's electrical system.
- 10 Use a screwdriver to disconnect the cable **F** from the carbon brush **C**. Gently lift the plastic part **C2** of the carbon brush holder while gently pulling out the cable **F** and terminal **G**.
- 11 Disconnect the old brush from the terminal **G** by opening the terminal clamp.

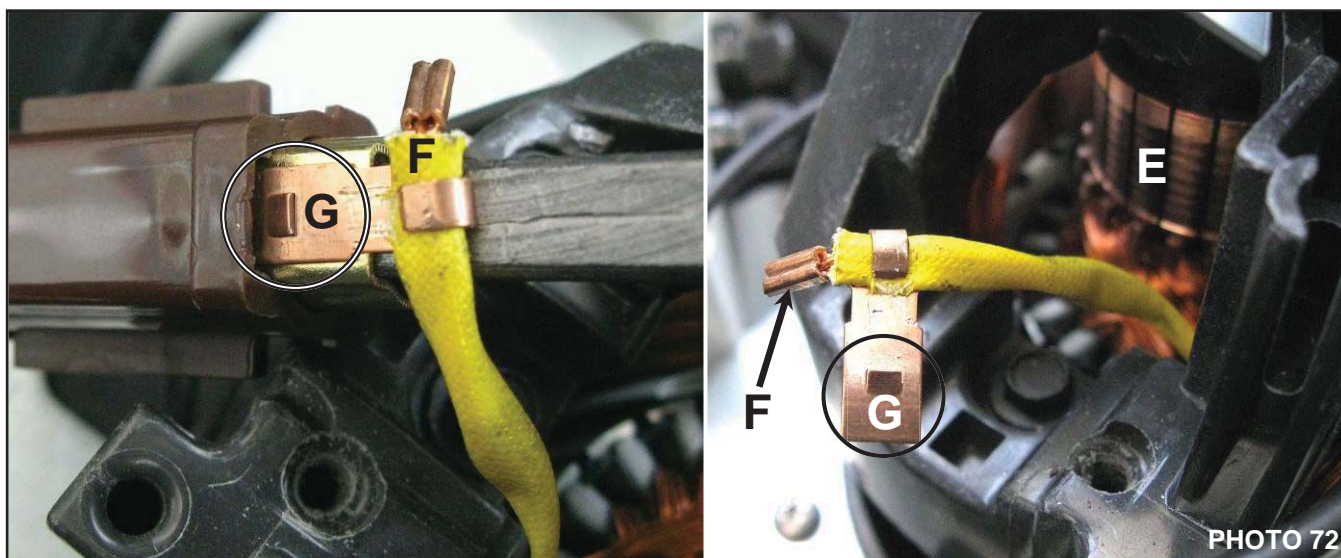
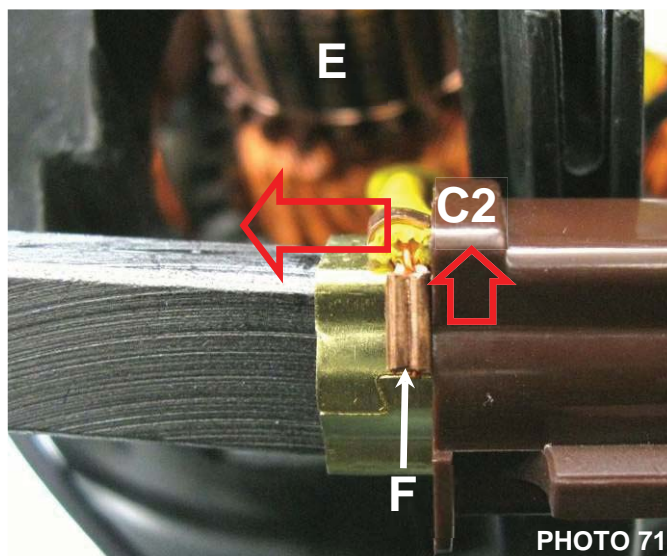

- 12 Fit the new carbon brushes. Push the terminals **G** into their seats and check that they make firm contact.
- 13 Connect the terminals of the two carbon brushes to the cables **F**, and reassemble the suction motor.

Reassembly

- 1 To fit the new carbon brushes, repeat the steps for disassembly in reverse.
- 2 Check the rotor **E** of the suction motor for wear before fitting new carbon brushes.
- 3 Blow the inside of the motor clean with a jet of compressed air, paying particular attention to the area around the carbon brushes and to the area of the rotor **E** with which the carbon brushes **C** come into sliding contact.



PLDC04626

REVISION 00

March 11, 2022

TECHNICAL DEPT.

Stavale

B2 SQUEEGEE UNIT

i Unlike those of other scrubber driers, the squeegee unit on the CS16 is mounted just behind the brush, and covers just over a third of its circumference. The squeegee mounting pivots directly under the brush motor so that the squeegee turns on the same axis as the brush, giving a better drying action around curves.

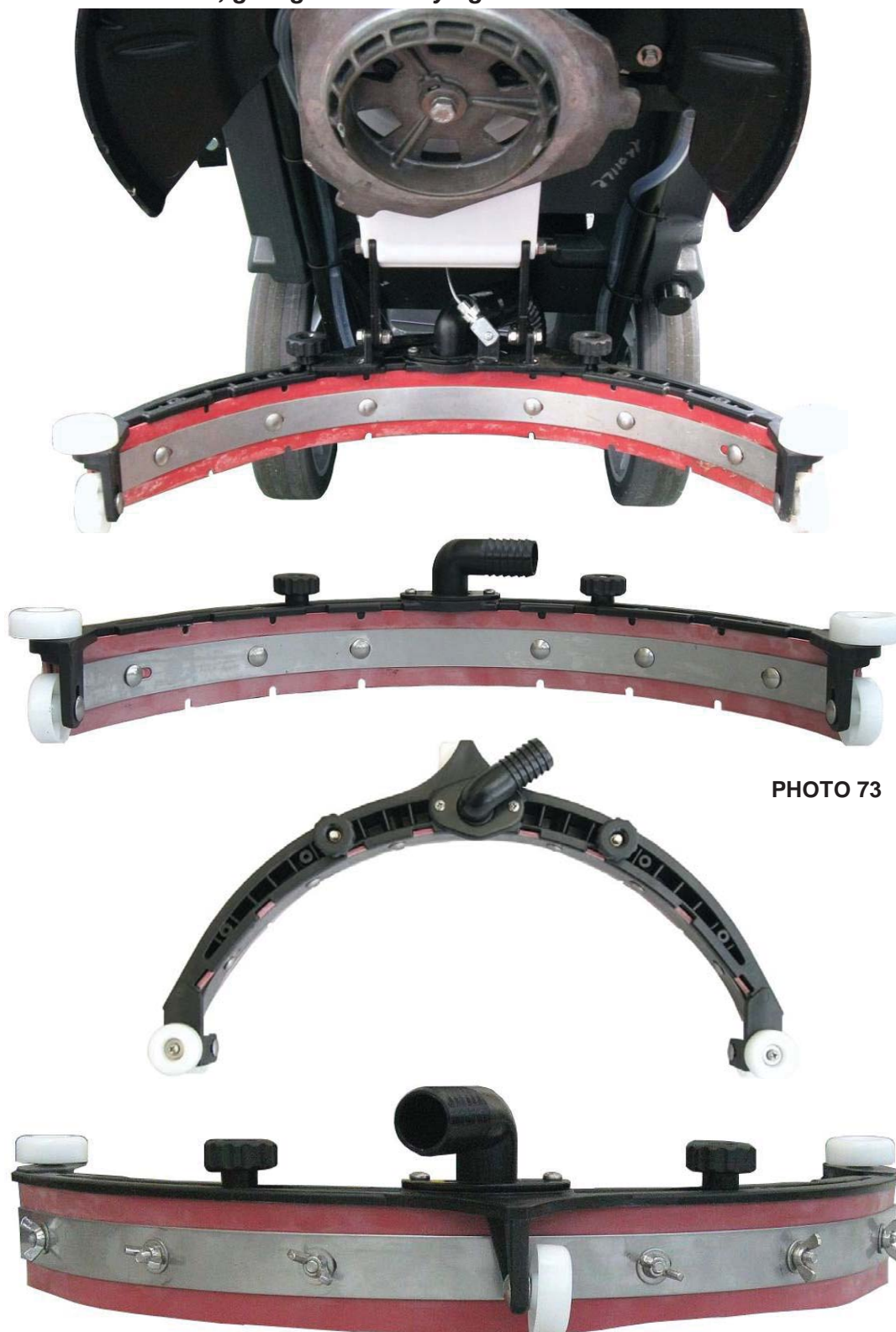
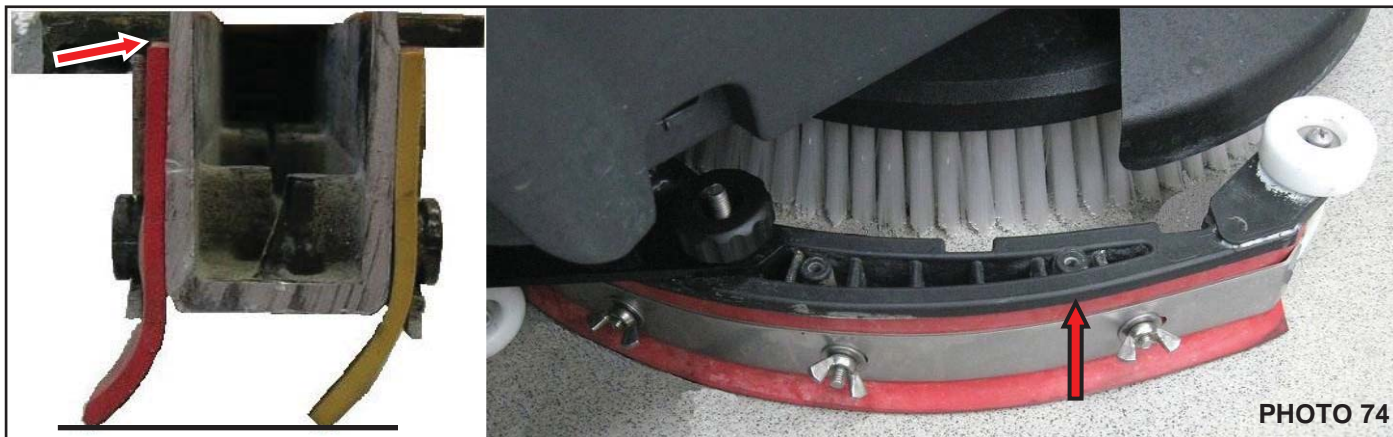

PHOTO 73



B2.1 Adjusting the squeegee

- 1 Prepare the machine for use and go to a flat, dry area of floor.
- 2 Make sure that the squeegee flaps are in good condition and that the tops of the flaps are firmly seated in the squeegee body before beginning adjustment.
- 3 Clean a few metres of floor under normal working conditions to ensure that the squeegee flaps are in their proper drying position.
- 4 Make sure that the rear flap rests evenly on the floor.
- 5 The figure below illustrates the ideal working condition.



- 6 If the flaps rest evenly on the floor, but apply very little pressure (shown by the flaps lying almost perpendicular to the floor), increase flap pressure by adjusting the three wheels on the squeegee unit.



- 7 Raise the wheels to increase flap pressure and increase the angle of flap tilt. Lower the wheels to reduce flap pressure.
- 8 Under normal conditions (i.e. with evenly worn flaps) all three wheels should be adjusted by the same amount.



PLDC04626

REVISION 00

March 11, 2022

TECHNICAL DEPT.

Stavale

B2.2 Replacing the squeegee flaps

Disassembly

- 1 Lower the squeegee unit to working position to facilitate its removal.
- 2 Remove the suction hose **A** from the union on the squeegee unit.
- 3 Unscrew the two plastic knobs **B** securing the squeegee unit to its mounting.
- 4 Remove the squeegee unit from the machine and take it to the work bench.

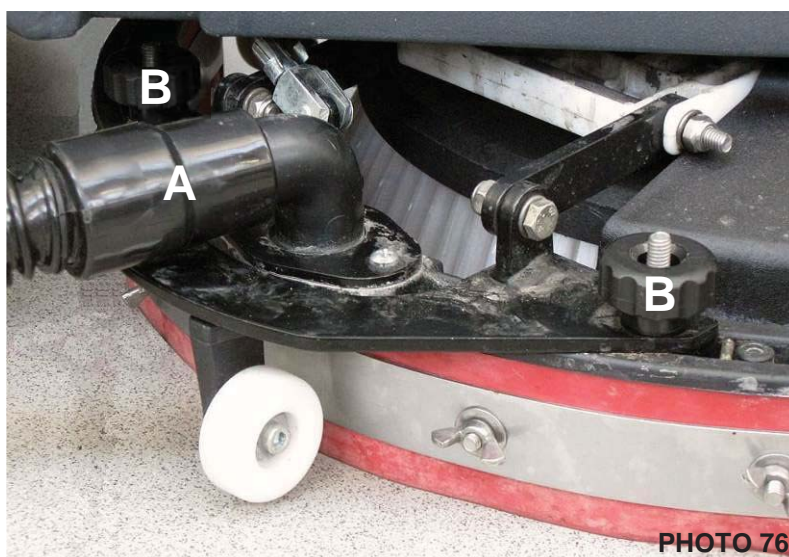

- 5 Unscrew the six butterfly nuts **C** and **C1**, and remove the bolts holding the flaps **D** and **E** and the flap retainers **F** and **G**, taking care not to lose the washers under the butterfly nuts.
- 6 Remove the flap retainers **F** and **G** and the flaps **D** and **E** from the squeegee unit.

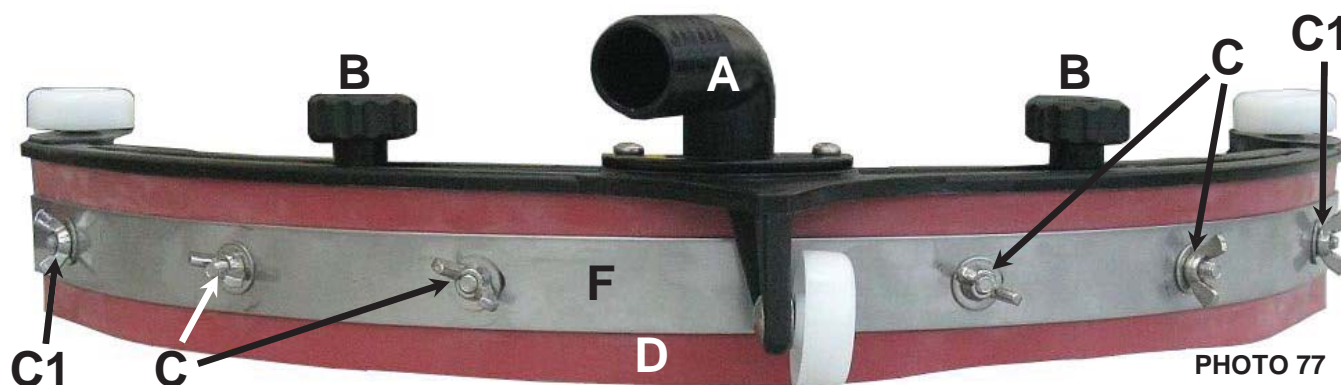



7 Clean the flap seats in the squeegee unit before fitting new flaps.

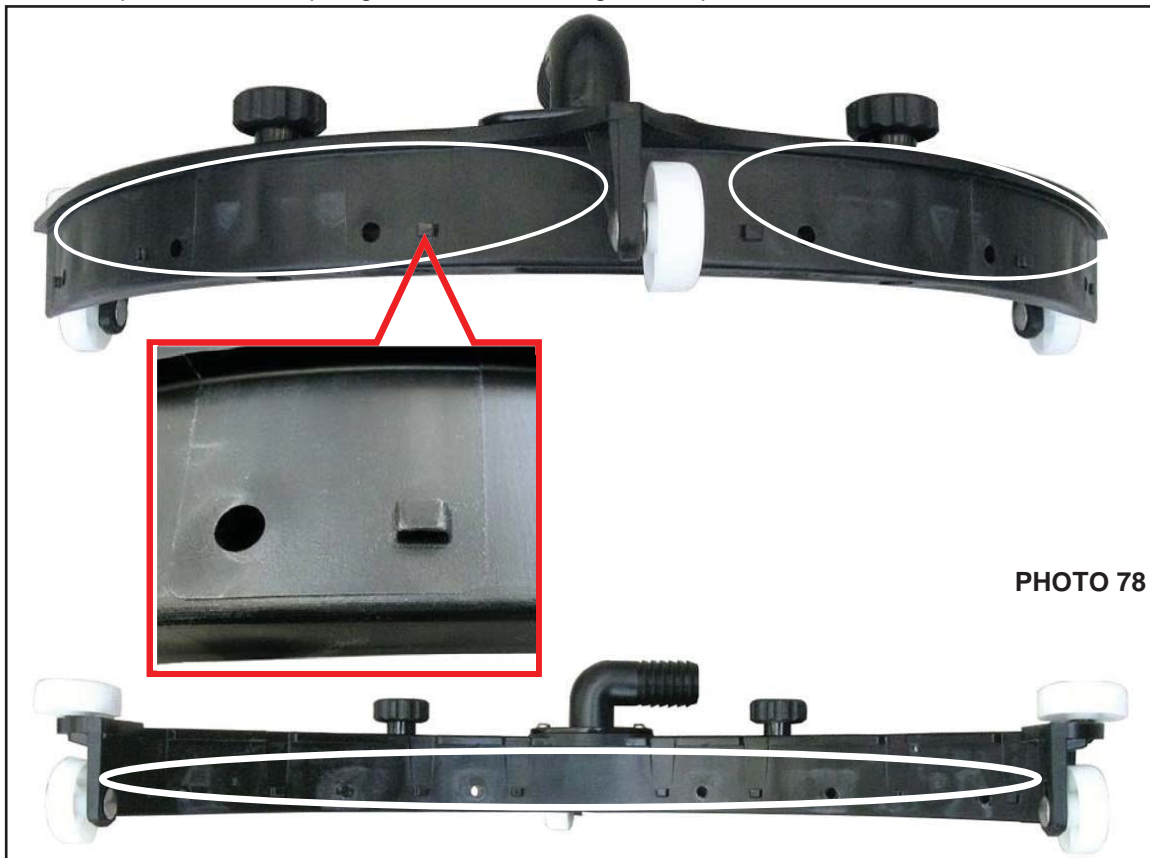

PHOTO 78

8 Identify the front flap E and the rear flap D, and fit them to the squeegee, aligning them with the raised plastic references.

i The front flap differs from the rear flap as it has notches in both long edges to permit some water to pass through during drying.

i Standard flaps (front and rear) are made from latex rubber and are 2 mm thick. The flaps are perfectly symmetrical in profile and can be reversed to permit use of all four corners. This extends their working life before replacement becomes necessary.



Squeegee flaps should be rotated every 30 operating hours, approximately.

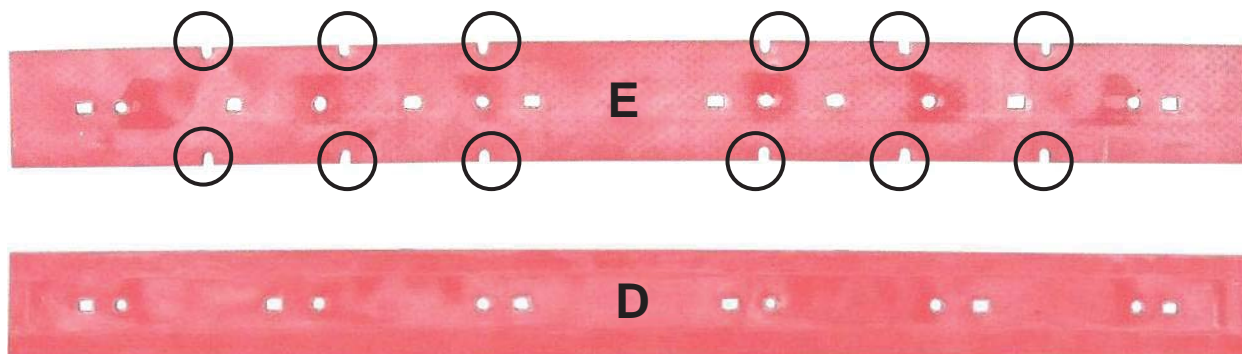

PHOTO 79



PLDC04626
REVISION 00
March 11, 2022
TECHNICAL DEPT.
Stavale



PHOTO 80



9 Position the flap retainers **G** and **F**, and fit the bolts **C**.

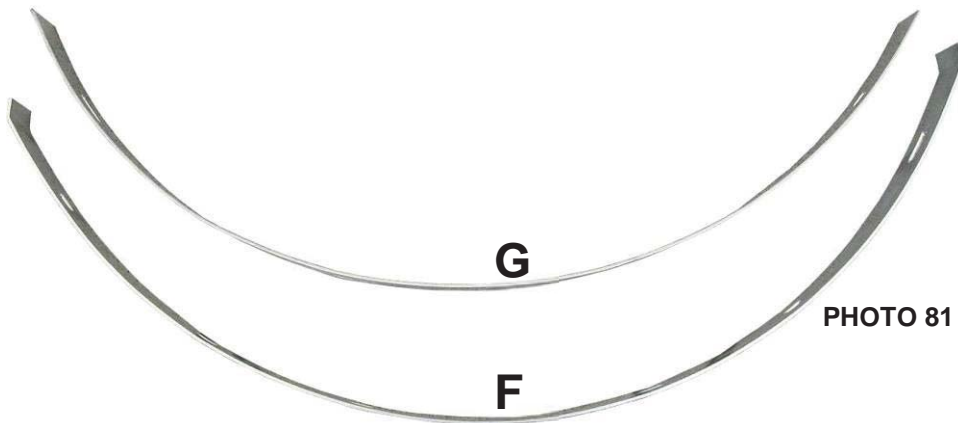

PHOTO 81

10 Fit the two short bolts **C1** in the outside holes of the squeegee unit (where thickness is reduced).

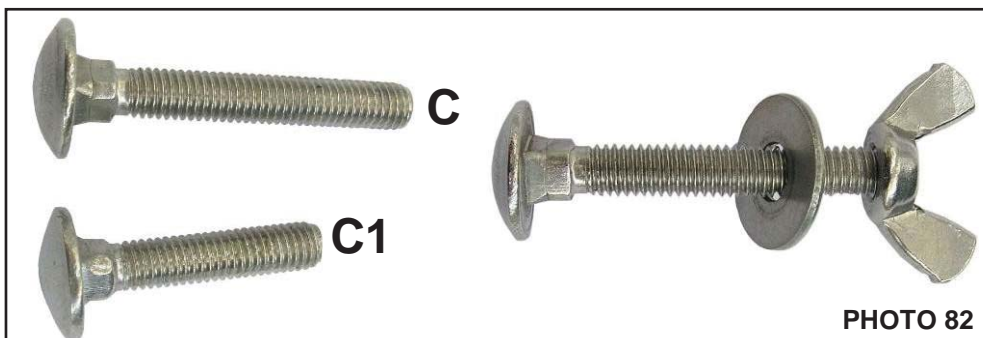

PHOTO 82

- 11 Position the flaps **E** and **D** and flap retainers **G** and **F** on the squeegee unit and fit the bolts **C** and **C1** to hold them in place. Leave the butterfly nuts slack until the flaps are properly seated in the squeegee unit.
- 12 Gradually tighten the butterfly nuts **C**, starting from the two nearest to the suction hose union. Make sure that the front flap **E** adheres perfectly to the front face of the squeegee unit.

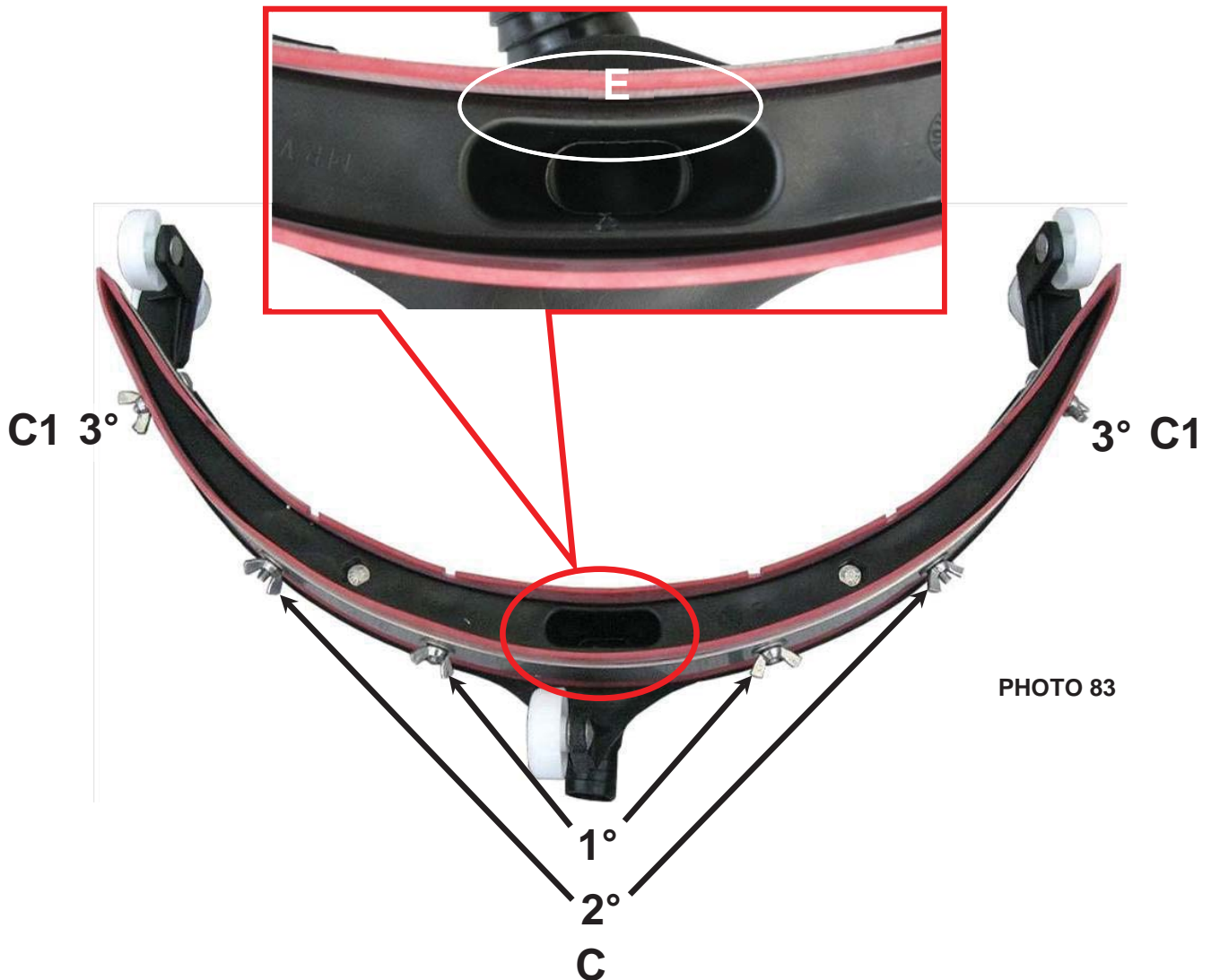

PHOTO 83

Reassembly

- 1 To fit new squeegee flaps, repeat the steps for disassembly in reverse order.
- 2 Thoroughly clean the flap contact surfaces on the squeegee unit before fitting new flaps.
- 3 Do not over-tighten the butterfly nuts **C** - **C1**, as this could cause the flaps to deform, reducing their drying efficiency.



PLDC04626

REVISION 00

March 11, 2022

TECHNICAL DEPT.

Stavale

B3 CLEANING FILTERS AND HOSES, CHECKING THE SOLENOID VALVE, CHECKING THE FLOAT

i To ensure correct functioning, it is essential for all machine components to be fully efficient in addition to the brush. It is therefore important to verify the correct functioning of the solenoid valve and its cleanliness. The hose from the solution dispensing cock to the dispenser on the brush head must be kept clean. The float system must also be kept in good condition and fully functional. The solenoid valve (A1) on the "B" battery version and the solenoid valve (A2) on the "C" cord version differ not only for the type of power supply but for the type of connection to the machine's electrical system.

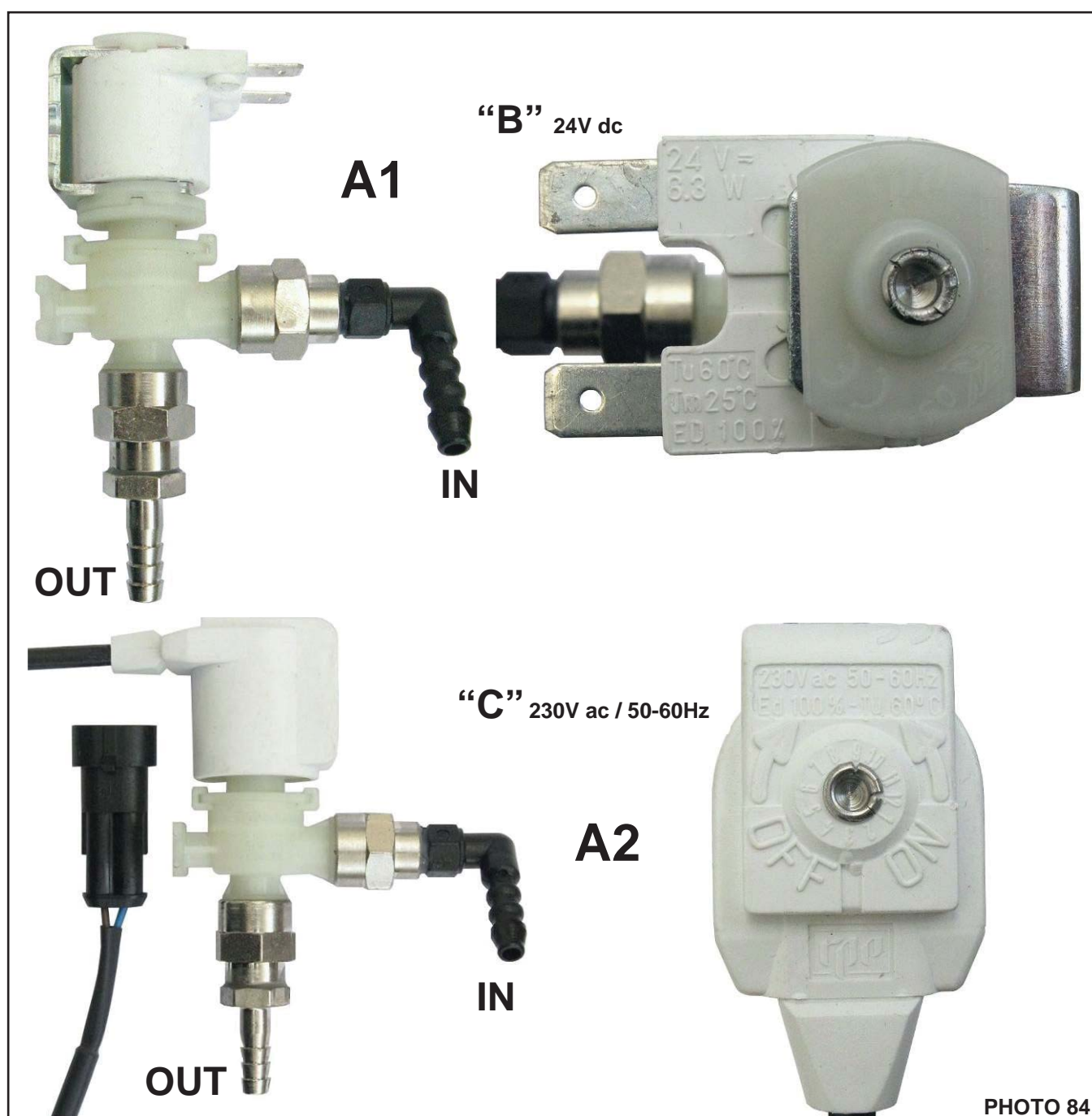



PLDC04626

REVISION 00

March 11, 2022

TECHNICAL DEPT.

Stavale

B3.1 Testing the solenoid valve

“B” type battery version

- 1 Make sure the batteries on the machine are fully charged (24V ± 1V).
- 2 Use a digital multi-meter able to measure DC voltages of at least 50 V.
- 3 Make sure that the button on the control panel operates the solution dispensing solenoid valve (LED lit).

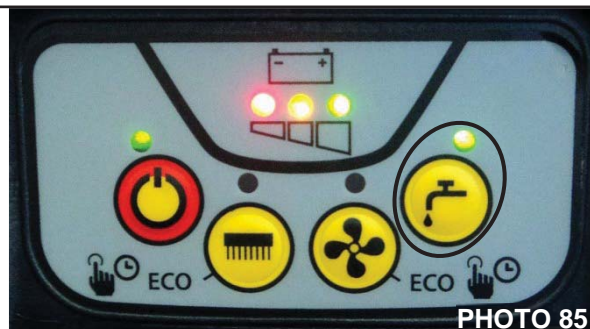

- 4 Take the machine to a flat, dry floor area.
- 5 Close the solution dispensing cock A by turning it clockwise.
- 6 Identify the solution dispensing solenoid valve at the bottom rear of the machine, under the battery charger.

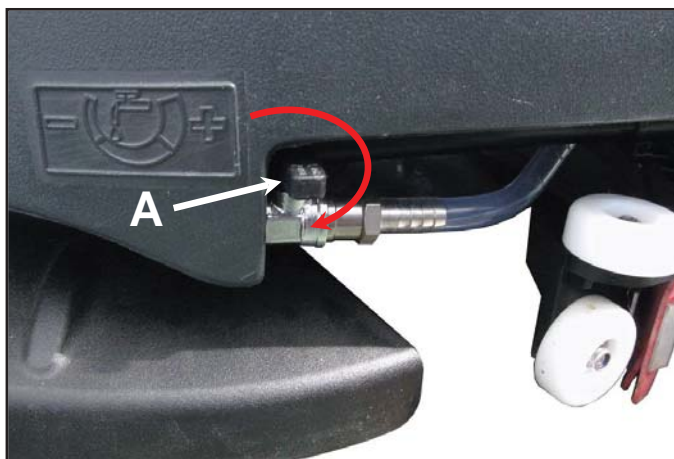

- 7 Switch off the machine and disconnect the solenoid valve from the electrical system by disconnecting the two fast-ons B. Connect the probes of the digital multimeter to the two fast-ons.

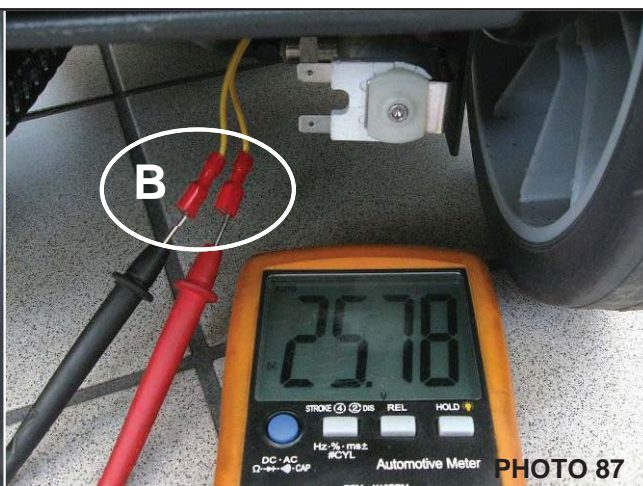

- 8 Switch the machine back on and press the solution dispensing button.



PLDC04626

REVISION 00

March 11, 2022

TECHNICAL DEPT.

Stavale

- 9 Pull the lever **C** on the handle and measure the voltage (V) between the two fast-ons **B**.

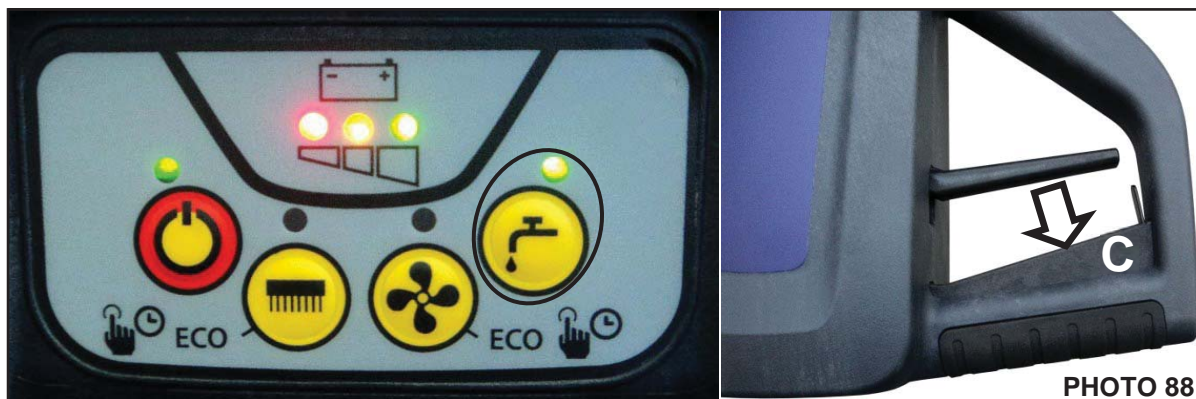

PHOTO 88

- 10 Provided measured voltage is between 25 and 21.4 V, the cabling and the electronic control system are functioning correctly. Re-connect the fast-ons to the solenoid valve. You should hear a click, showing that the solenoid valve is working. If you hear no noise, check the functioning of the solenoid valve as instructed in section B3.2, and replace it if necessary.



PLDC04626

REVISION 00

March 11, 2022

TECHNICAL DEPT.

Stavale

B3.2 Testing and replacing the solenoid valve on “B” type machines

- 1 Make sure the batteries on the machine are fully charged ($24V \pm 1V$).
- 2 Use a digital multi-meter able to measure DC voltages of at least 50 V.
- 3 Make sure that the button on the control panel operates the dispensing solenoid valve (LED lit)



- 4 Move the machine to the tank draining area, and empty the solution and collection tanks.
- 5 Take the machine to a flat, dry floor area.
- 6 Close the solution dispensing cock **A** by turning it clockwise. Tilt the handle back through about 60° .
- 7 Tip the machine rearwards, until the handle rests on the floor.

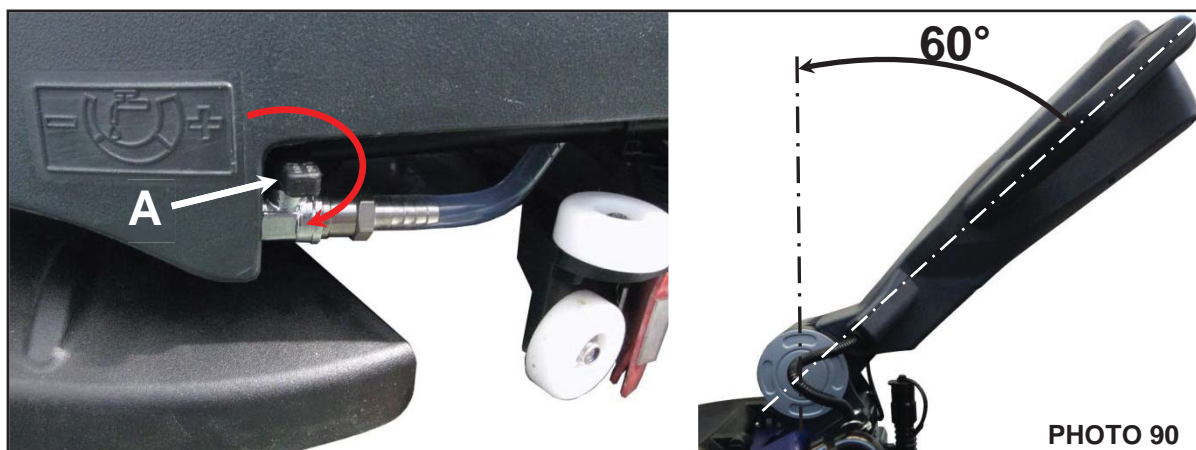

- 8 Make sure the machine is switched off. Disconnect the solenoid valve from the electrical system by disconnecting the two fast-ons **B**.

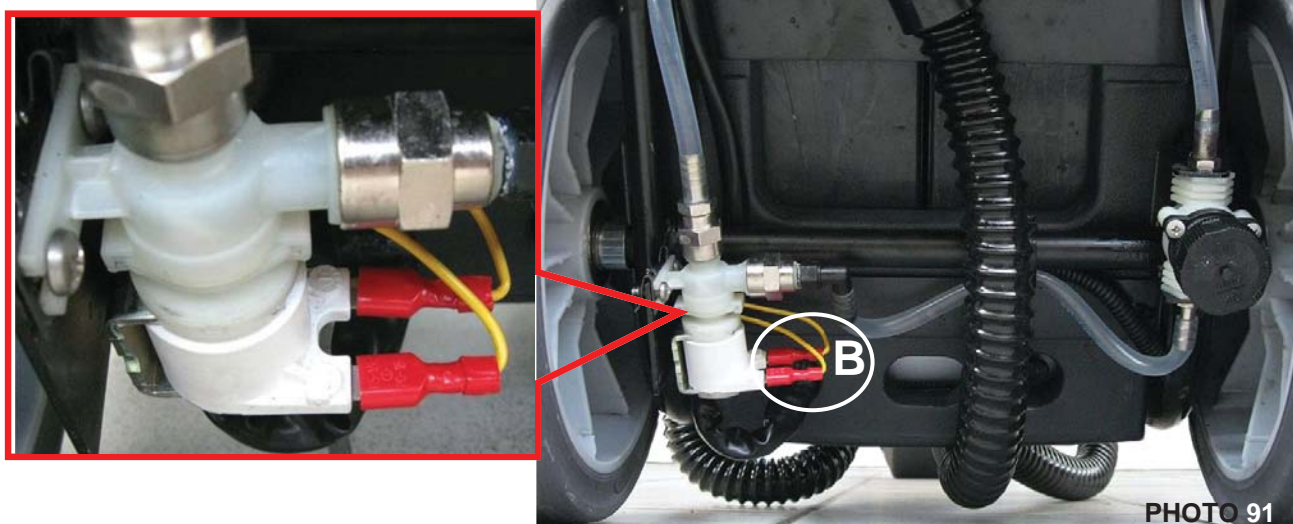



- 9 Connect the probes of the digital multimeter to the two fast-ons **B**.
- 10 Switch the machine back on and press the solution dispensing button.
- 11 Pull the lever **C** on the handle and measure the voltage (V) between the two fast-ons **B**.

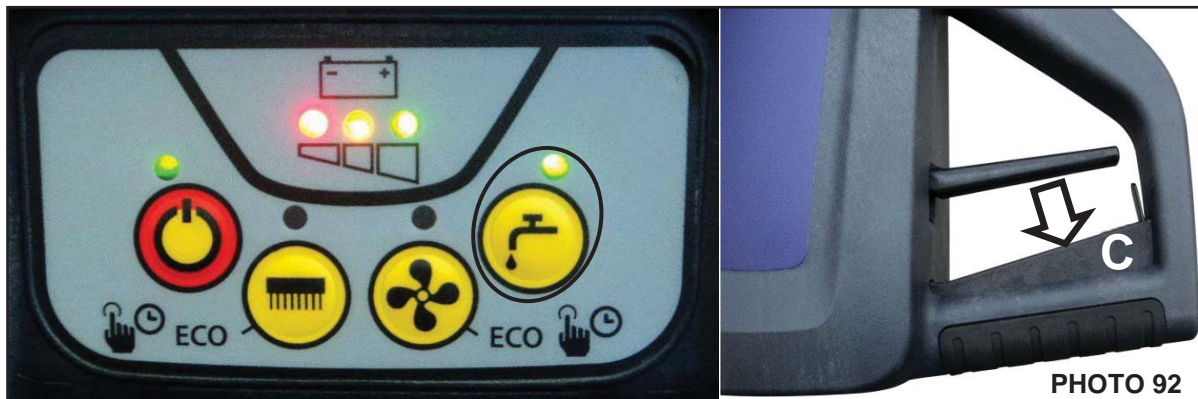

PHOTO 92

- 12 Read the voltage off the digital multi-meter.

12a Provided measured voltage is between 25 and 21.4 V, the cabling and the electronic control system are functioning correctly. Re-connect the fast-ons to the solenoid valve. You should hear a click, showing that the solenoid valve is working. If you hear no noise, check the functioning of the solenoid valve **D**, and replace it if necessary.

12b To check the functioning of the valve's solenoid **D**, remove it from the valve body and check whether the rubber membrane moves. If the rubber membrane does not move when the solenoid is energised, replace the entire solenoid valve.

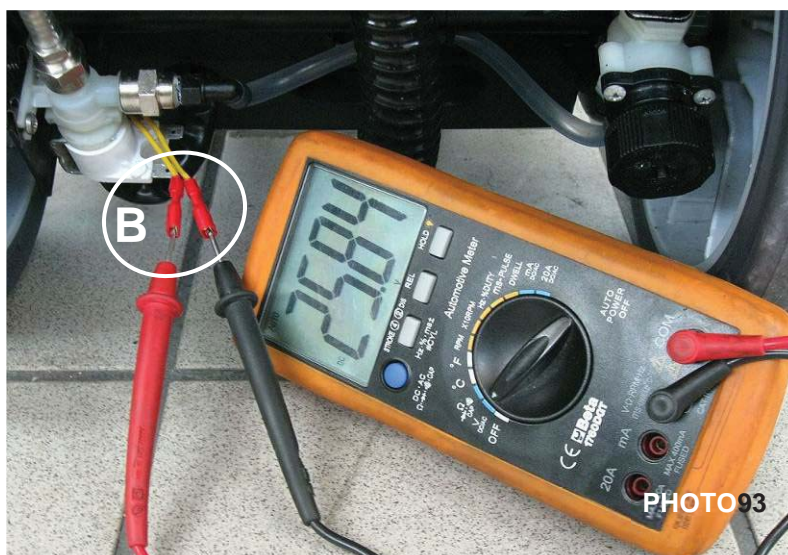

PHOTO 93

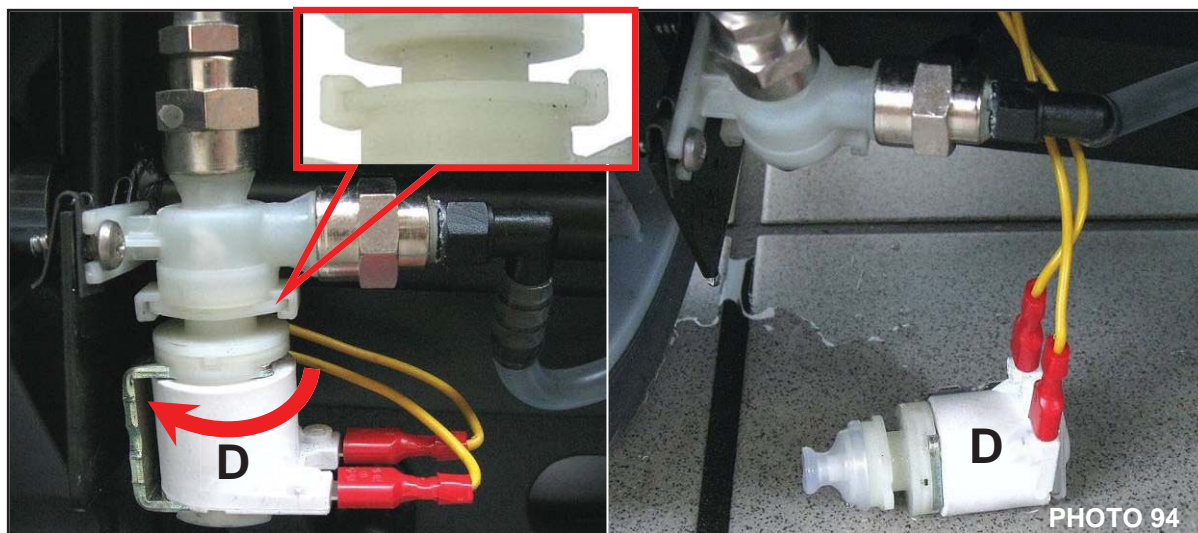
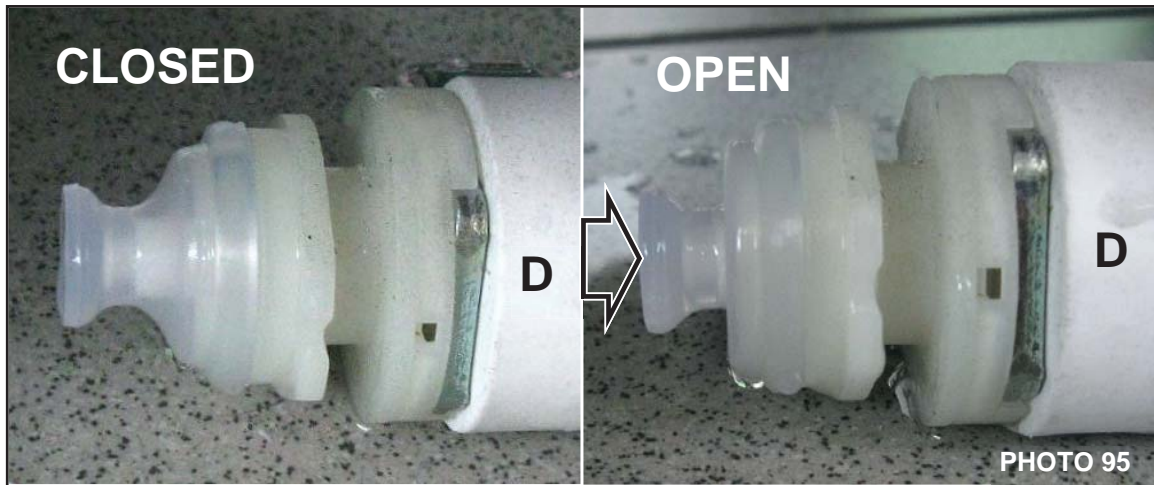

PHOTO 94



12c If, with fully charged batteries, voltage across the fast-ons is between 21 and 1 V, check the connections at the power control card and check the continuity of the wires to the solenoid valve. If the connections and the wiring are efficient, replace the power control card.

12d If, with fully charged batteries, and with the dispensing LED on the control panel lit, there is no voltage across the fast-ons, check the continuity of the wiring between the two electronic control cards. If there are no continuity problems in the wiring, check whether the problem is due to the power control card or to the function control card, as instructed in sections D1.2 / D1.4.

Cleaning the solenoid valve

- 13** The solenoid valve can be cleaned on the machine or on the bench.
- 14** With the solenoid valve on the machine, disconnect the solenoid **D**, turn it and remove it from the valve body as shown above. Clean the outlet hole **E** in the valve body.
- 15** To remove the solenoid valve from the machine, follow the instructions given below. With the solenoid valve on the bench, clean the outlet hole **E** in the valve body.

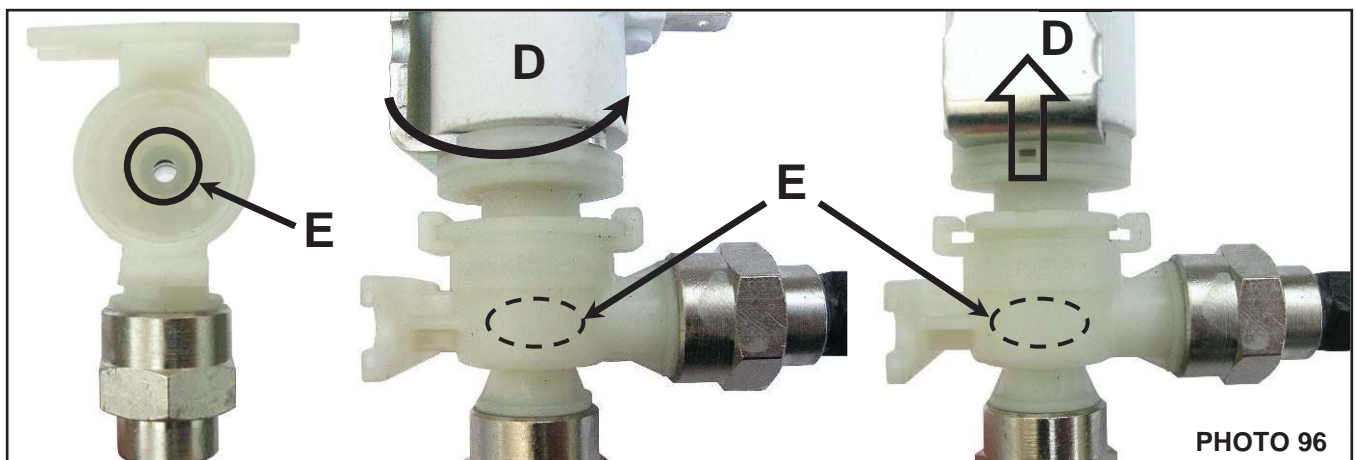



PLDC04626

REVISION 00

March 11, 2022

TECHNICAL DEPT.

Stavale

Replacing the solenoid valve

- 16 Disconnect the two fast-ons **B** (if still connected), and replace just the solenoid **D**. Alternatively, proceed as instructed below.
- 17 Remove the two screws **F** securing the body of the solenoid valve to the machine frame.
- 18 Remove the rubber hoses from the unions **G** and **H**.

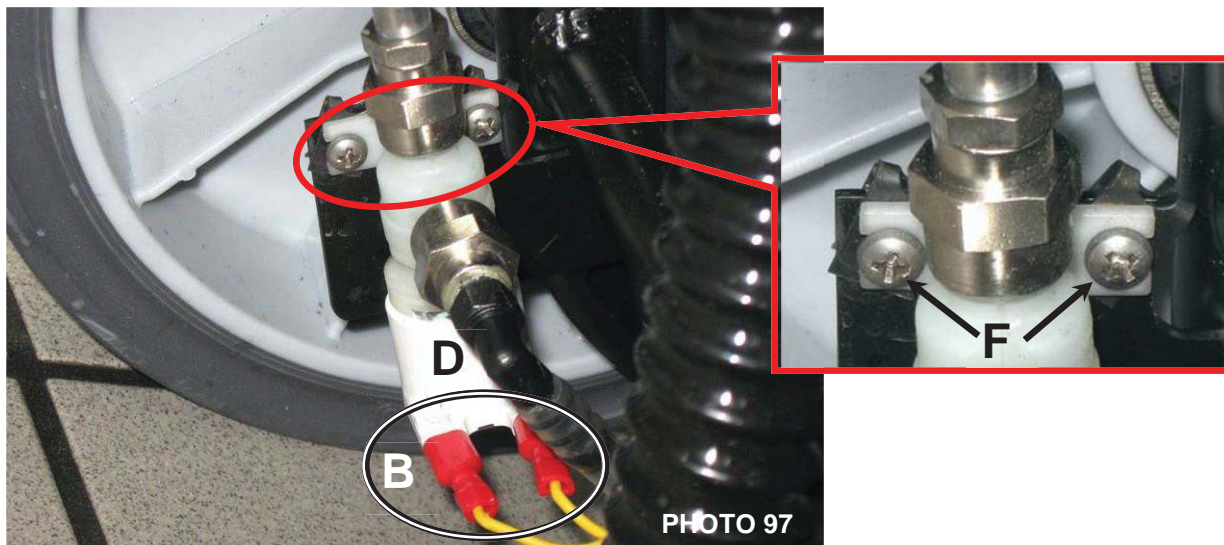

- 19 Remove the unions **G** and **H** from the old valve body and fit them to the new valve body. Adjust the 'L' union **G** to an angle of approximately 35°.

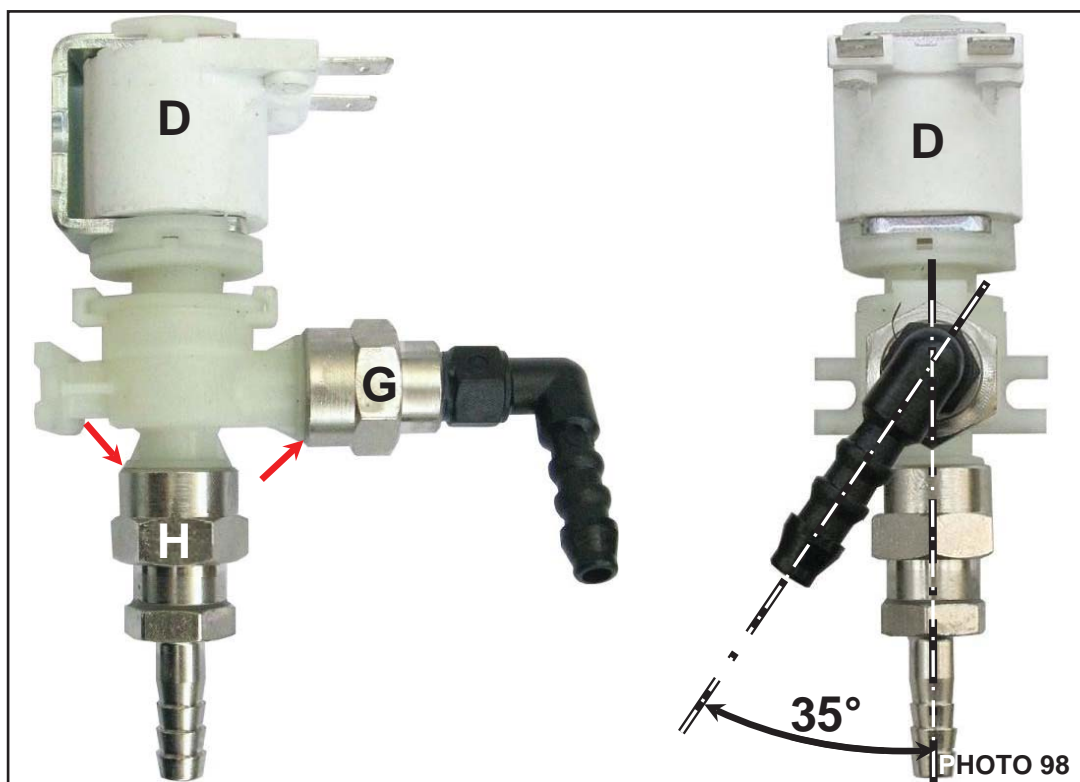

Reassembly

- 1 To fit the solenoid valve, repeat the steps for disassembly in reverse order.
- 2 Apply a drop of liquid Teflon or similar sealant to the threads of the solenoid valve where the unions **H** and **G** will be fitted.
- 3 Remember to adjust the 'L' shaped union **G** to an angle of about 35°.

B3.3 Checking the condition of the float



The collection tank float serves two purposes: it warns when the collection tank is full and, more importantly it prevents the suction motor from sucking in water, which would cause it to malfunction.

i

The CS16 uses a very simple float system, based on a rigid block of foam. When suction is switched on to dry the floor, the dirty water rising in the collection tank gradually lifts the float towards the suction holes. When the float becomes very close to the holes, the suction pulls it against the holes and shuts them off. When this occurs, the operator will notice a clear increase in suction noise.



PHOTO 99

Checking and replacement

- 1** Check that the float is in good condition, and that there are no cracks or holes in the surface that comes into contact with the suction holes in the collection tank cover.
- 2** To replace the float, simply remove the screw **A**.
- 3** If no new float is available, but the underside of the old float is in good condition, turn the old float over.



PHOTO 100

B3.4 Cleaning the filters, hoses and solution dispensing cock

i Because its solution tank only contains a limited volume, and because the solution dispensing solenoid valve can be cleaned so easily, the CS16 is not fitted as standard with a solution filter. If required, an optional filter can be fitted, as shown below. Even with a filter fitted, however, the solution dispensing hoses and the dispensing cock must be kept clean to ensure correct flow and control.

Disassembly and inspection

- 1 Move the machine to the tank draining area, and empty the solution and collection tanks.
- 2 Take the machine to a flat, dry floor area.
- 3 Tilt the handle back through about 60°.
- 4 Tip the machine rearwards, until the handle rests on the floor.
- 5 Inspect the clear hose from the dispensing cock to the brush head.
- 6 If necessary, remove the solenoid from the solenoid valve and clean the valve as instructed in the previous sections.

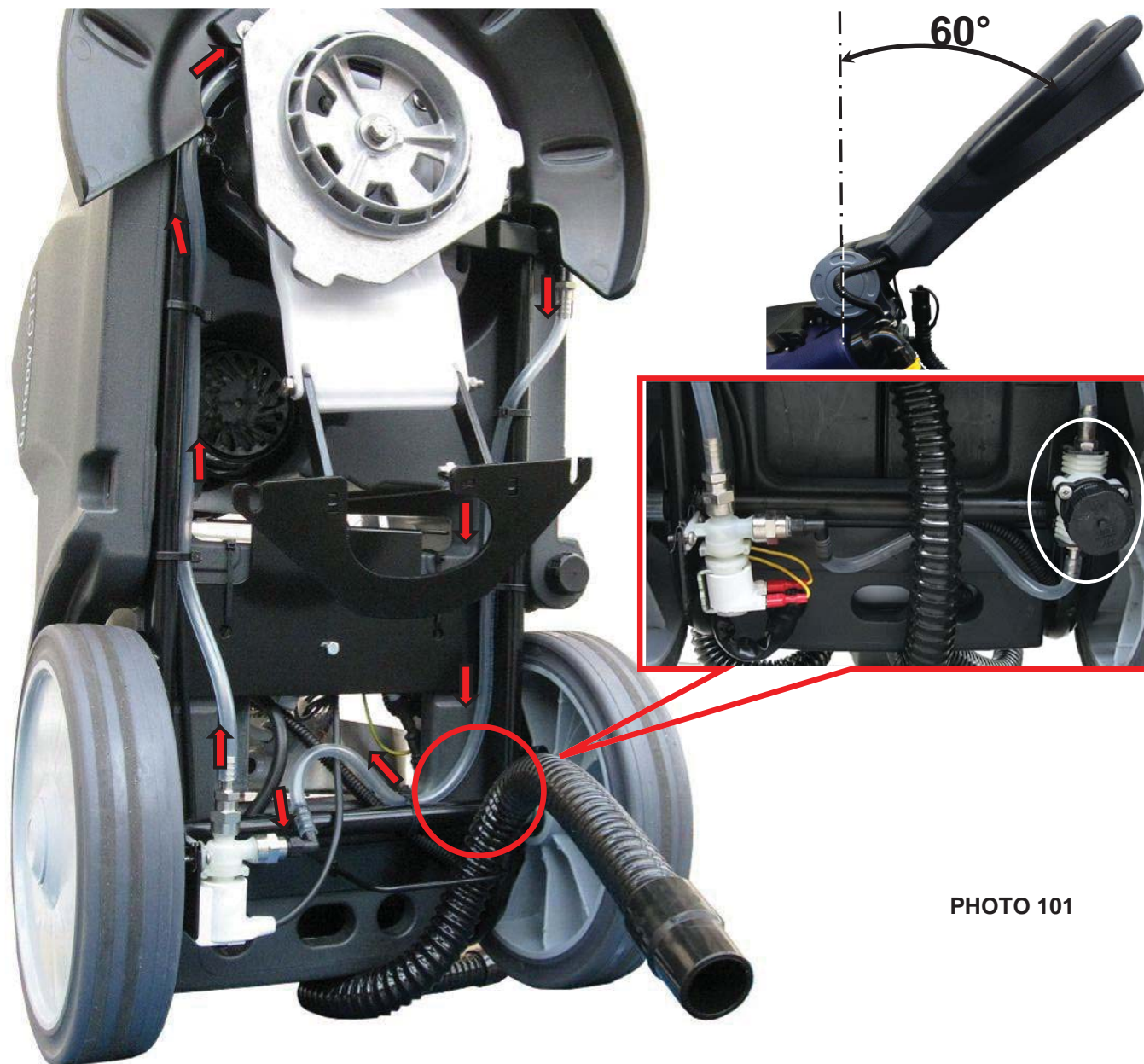
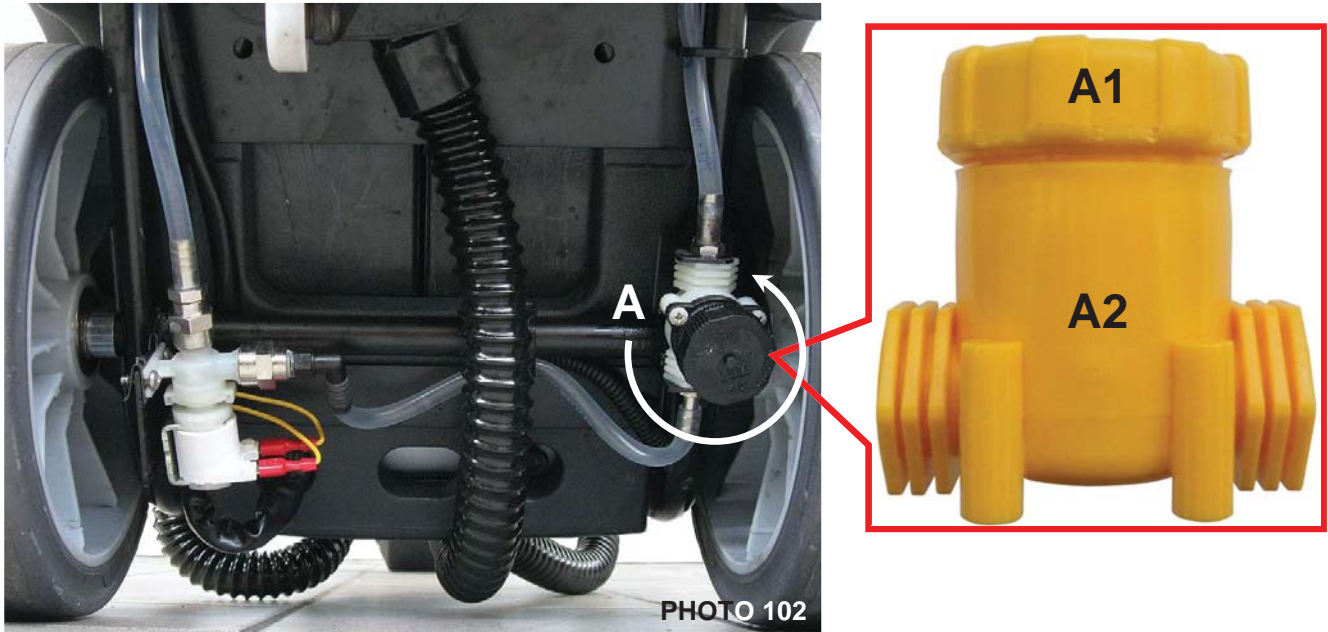

PHOTO 101

Optional solution filter

- 7 Tip the machine up rearwards as instructed above, and identify the optional solution filter A.



- 8 Unscrew the cap A1 from the body A2.
9 Remove the filter A3 from the body A2.
10 Make sure that there are no foreign bodies lodged inside the filter body A2.

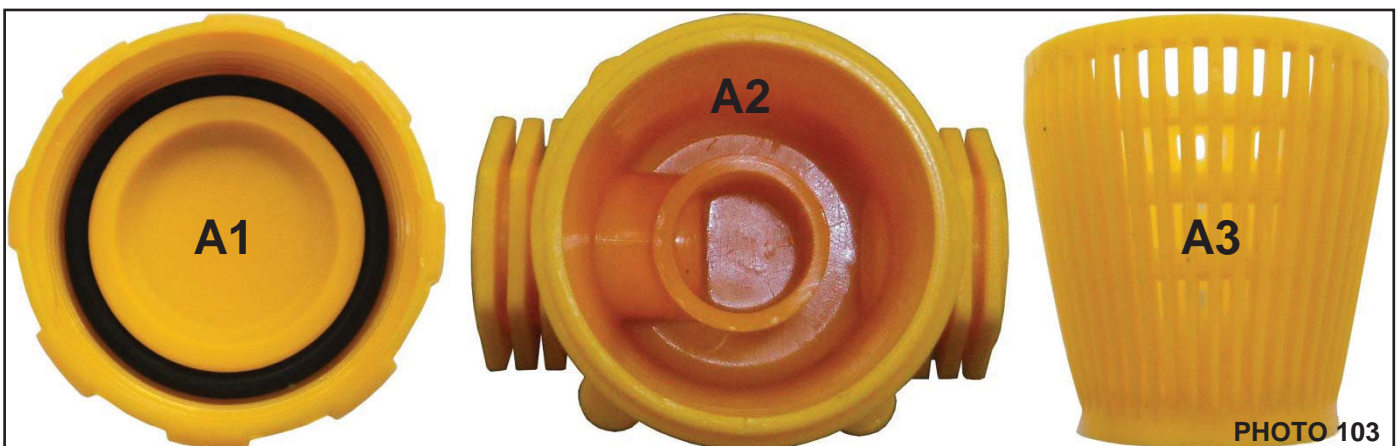

- 11 Clean the filter **A3** by running water from the outside towards the inside. Use a small brush to remove any stubborn dirt.
- 12 Fit the filter **A3** in the body **A2**, then screw the cap **A1** back on to the body **A2**.

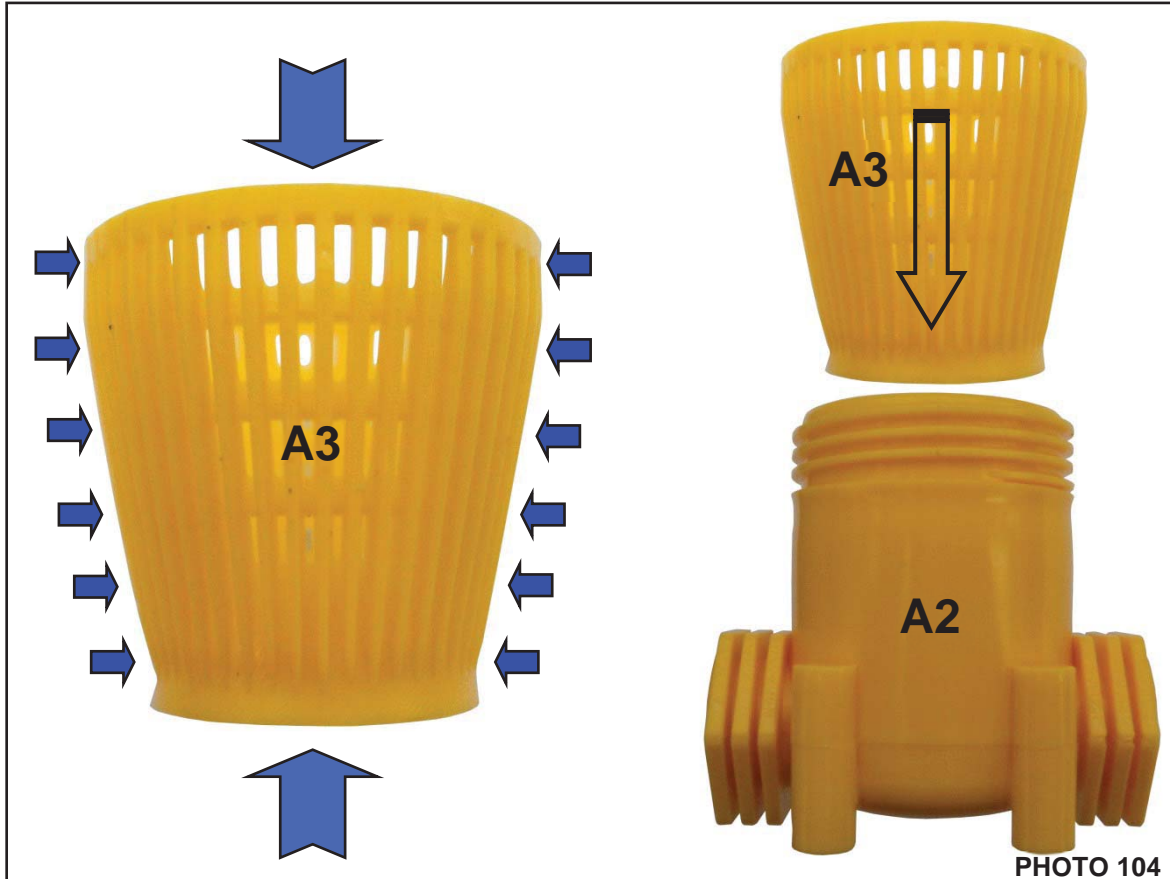

Replacing / fitting the solution filter

- 13 If it ever proves necessary to replace the entire filter **A**, take care to fit the new filter the right way around. The arrow on the bottom of the filter body indicates the direction of flow.
- 14 To fit the optional solution filter, place the filter **A** between the two mounting brackets, and fix it in place by means of the two straight hose unions. Apply a drop of sealant or liquid Teflon to the threads of the unions.

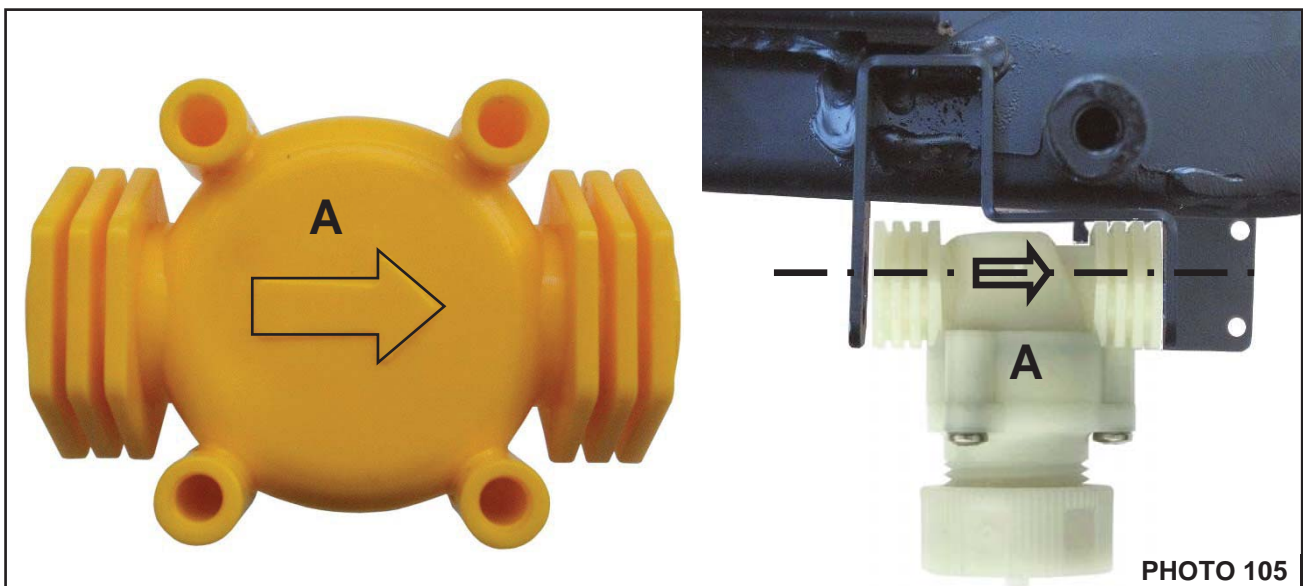



PLDC04626

REVISION 00

March 11, 2022

TECHNICAL DEPT.

Stavale

Cleaning and replacing the solution dispensing cock

- 15** If little or no solution comes out even when the dispensing cock **B** is completely open, dirt may have built up at the inlet to the cock.
- 16** The cock **B** can be cleaned either by blowing compressed air through it to free any obstruction, or by removing the cock and physically removing the dirt.
- 17** Cleaning with compressed air is obviously the easiest method. To do so, either blow compressed air into the tank (without applying too much pressure) to blow any dirt out through the cock's outlet, or blow into the cock's outlet. This latter method, however, will blow dirt into the tank, so the tank must then be emptied and rinsed.
- 18** Move the machine to the tank draining area to clean the solution dispensing cock **B**.
- 19** Disconnect the clear hose **C** from the union **D** of the cock **B**.
- 20** Rapidly open and close the cock **B** a few times, then leave it open.

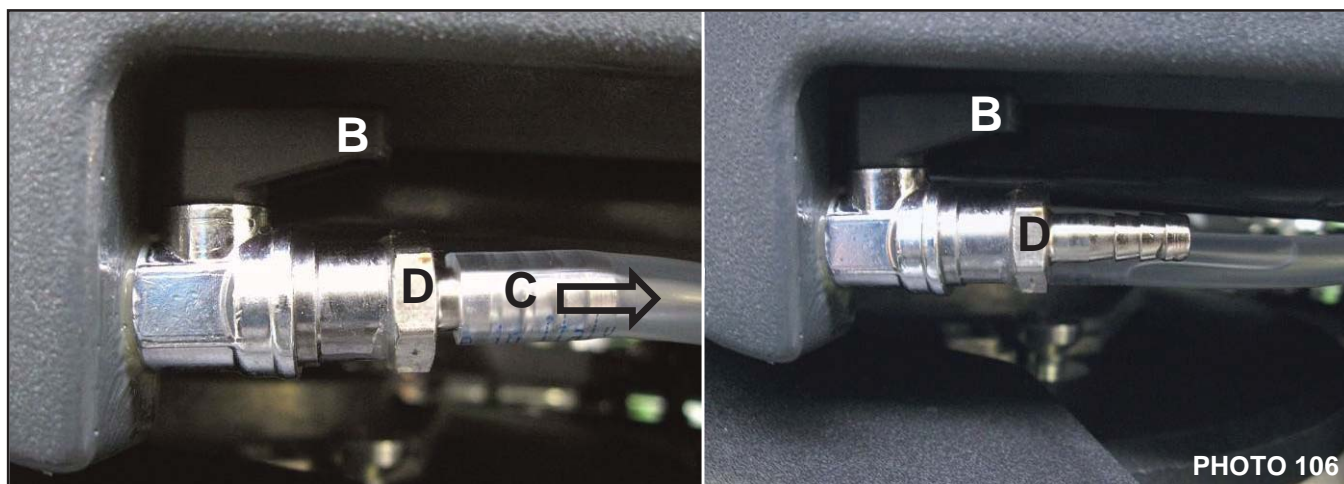

- 21** Position the compressed air gun at either of the two holes **E** in the cap of the solution tank, and close the other with a finger.
- 22** Blow air into the tank to pressurise it, without applying excess pressure, until any obstruction in the cock **B** is expelled from the outlet. If this does not work, blow air into the union **D** on the cock **B**.

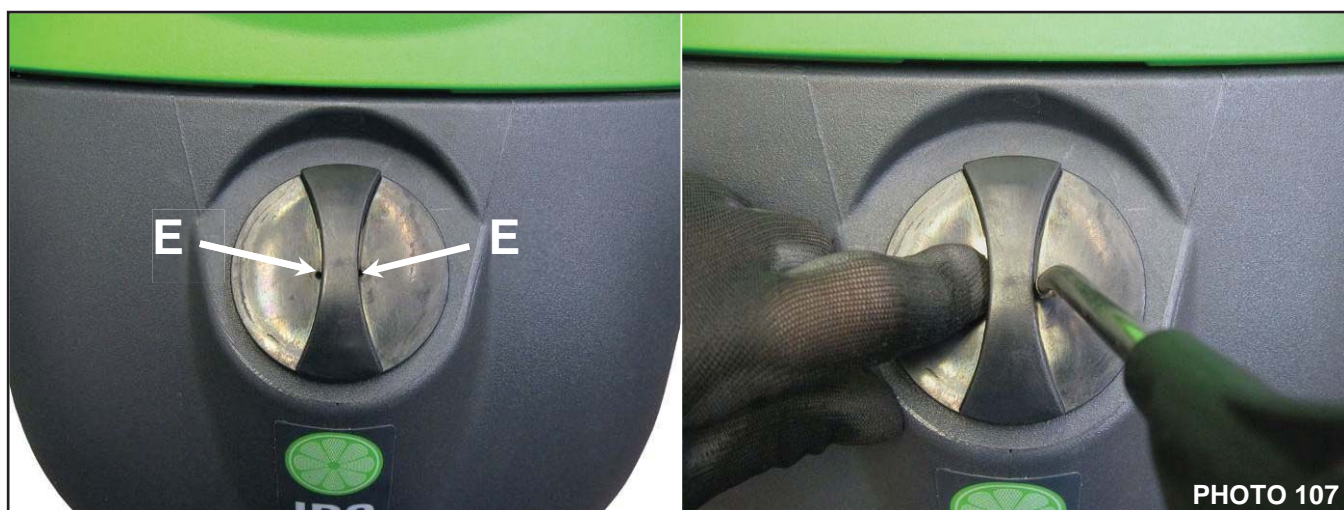

23 If even this fails to dislodge the obstruction, gently push a small screwdriver through the cock **B**.

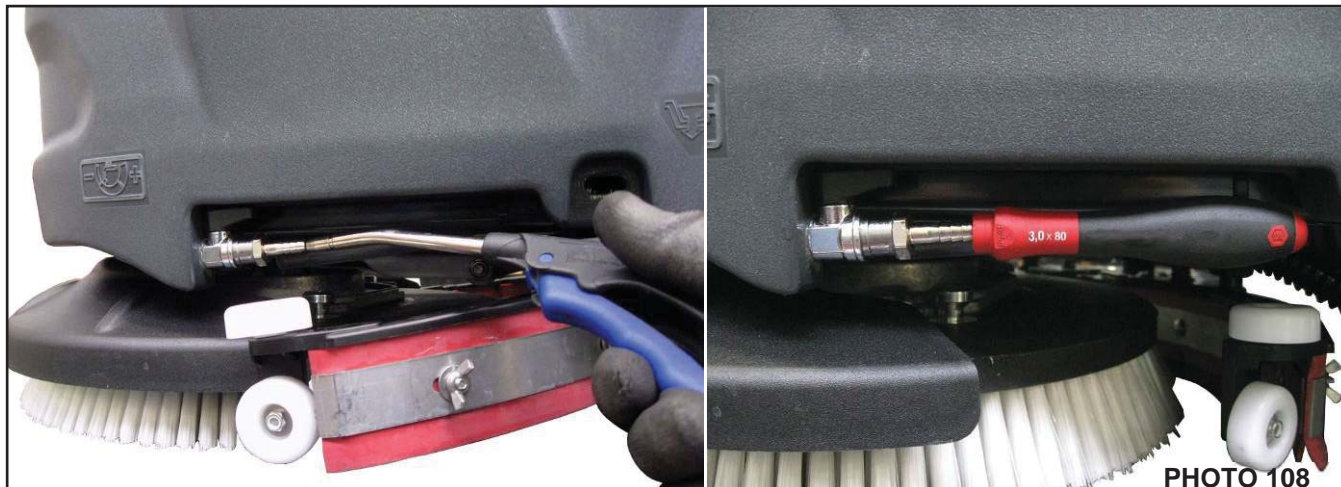

- 24** After blowing air into the cock, empty the solution tank through its drain plug and rinse the tank to remove any dirt deposited inside it.
- 25** If the problem persists, the cock **B** must be replaced. Remove the cock from the solution tank.
- 26** Turn the cock's lever **B1** to the open position to allow the cock to turn.
- 27** Remove the clear hose from the cock's hose union, then use a 14 mm spanner to unscrew the cock **B** from the solution tank.

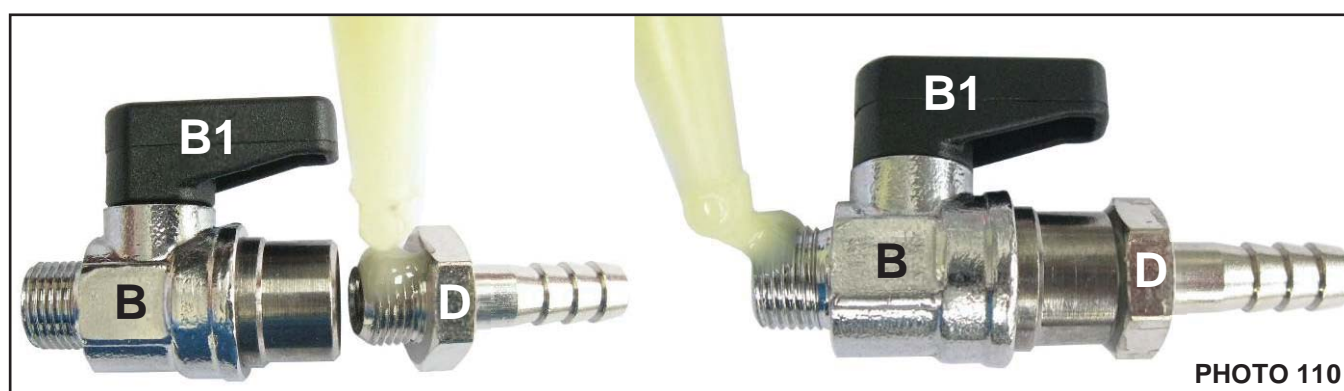

Reassembly

- 1** To fit a new cock **B**, repeat the steps for disassembly in reverse order.
- 2** When re-fitting cock **B** after cleaning, or when fitting a new cock, apply a drop of sealant to the threads of the cock **B** and to those of the union **D**.
- 3** Take care when screwing the cock **B** into the tank. The lever **B1** must come to rest at the top.



PLDC04626

REVISION 00

March 11, 2022

TECHNICAL DEPT.

Stavale

D FUNCTION CONTROL CARD, POWER CONTROL CARD, AND BATTERY CHARGER

👉 WARNING!

Go to the designated draining area and empty the solution and collection tanks using the drain plugs and the hoses provided.

Position the machine on a flat floor, and place wedges under the wheels to stop it moving.

Switch the machine off and disable all functions by pressing the “On–Off” button on the control panel.

Disconnect the machine’s electrical system by removing the main fuse F1, or by disconnecting the terminals from the battery poles (battery powered machines), or by removing the plug from the mains power socket (mains powered machines).

i INFORMATION

Important information

In this Service Manual, the terms RIGHT and LEFT are used to indicate the sides of the machine. They always refer to the direction of travel.

In this Service Manual, the machine version (CS16 B = battery, CS16 C = corded) may appear between brackets “()”. This indicates that the instruction in question refers only to the version specified.



D1 FUNCTION CONTROL CARD AND POWER CONTROL CARD

i On “B” type battery and “C” type cord machines, the function control card receives its power from the power control card via a flat cable. The function control card controls the machine’s functions (suction motor, brush motor, solenoid valve) via the same flat cable.

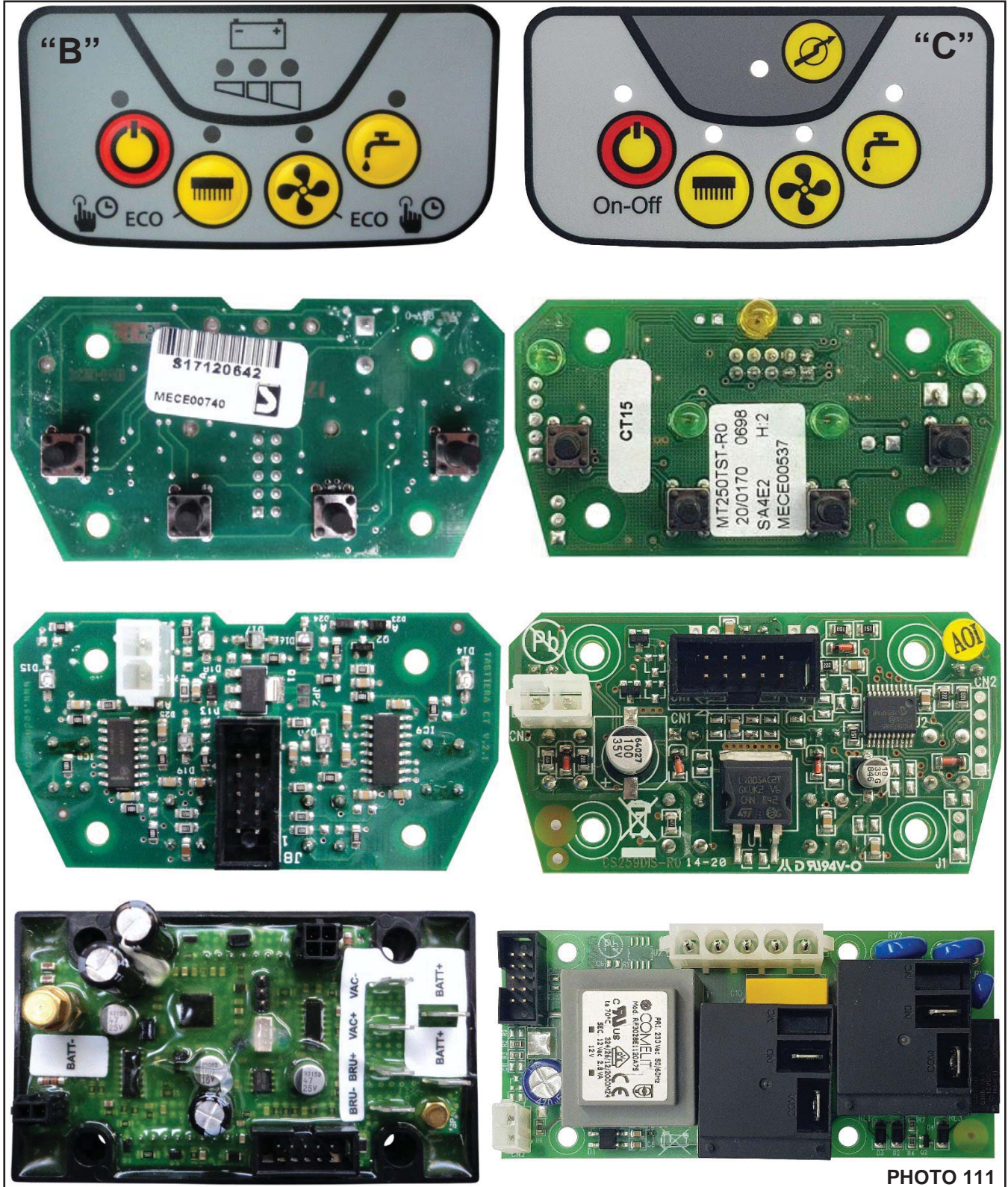

PHOTO 111



PLDC04626

REVISION 00

March 11, 2022

TECHNICAL DEPT.

Stavale

D1.1 Replacing the function control card on “B” and “C” Machines

Disassembly

- 1 Move the machine to the tank draining area, and completely empty the collection tank.
- 2 Take the machine to a flat, dry floor area.
- 3 Lift up and remove the recovery tank to gain access to the fuse holder A.

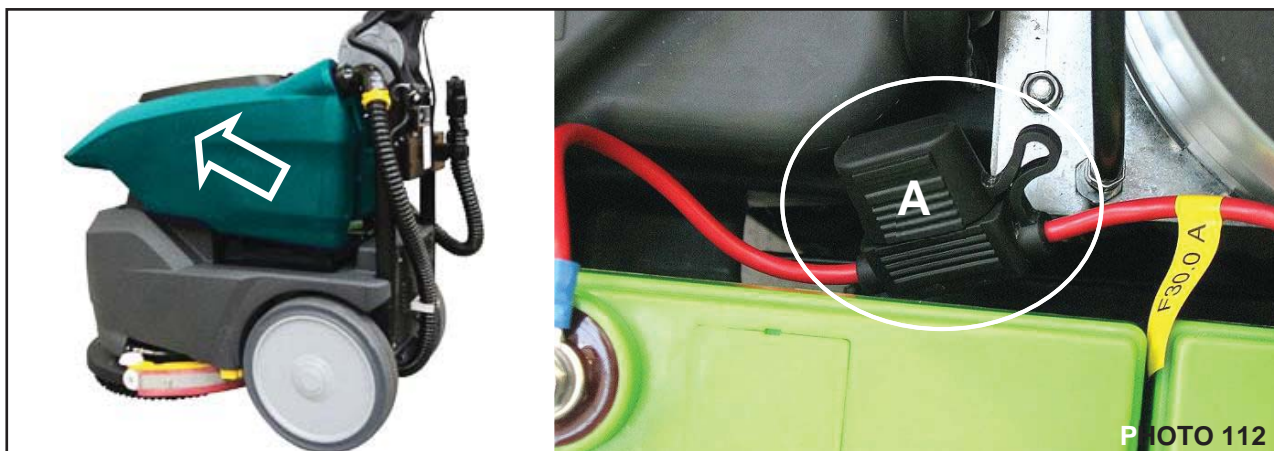

- 4 Remove the fuse A1 from the fuse holder A to isolate the machine's electrical system from the batteries.
- 5 Unscrew 12 of 14 the screws B1 that assemble the two half-shells that make up the handle B.

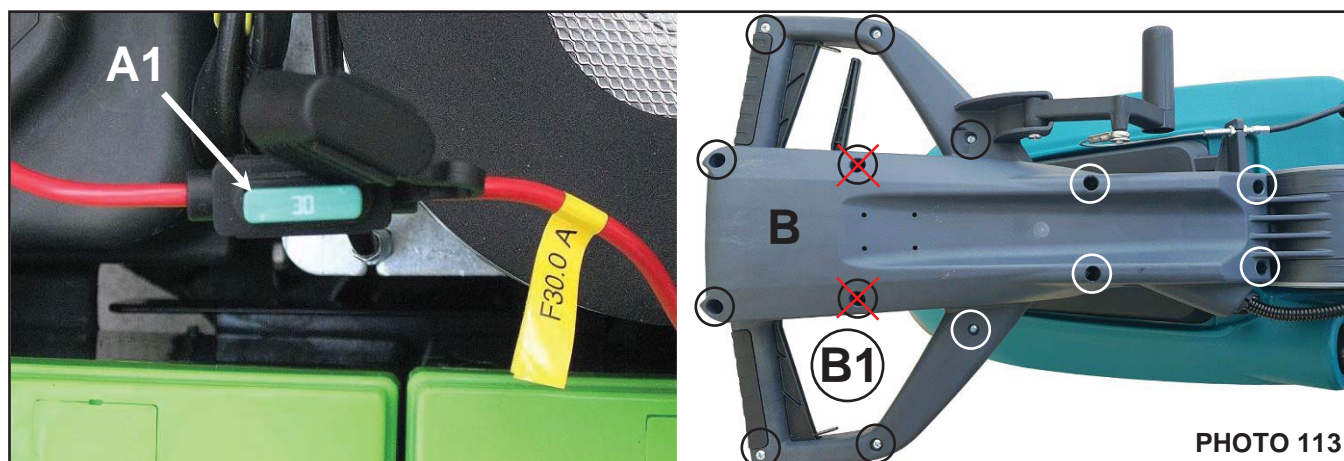

- 6 Rotate the handle 180°, unscrew the last screws and remove the front half-shell.

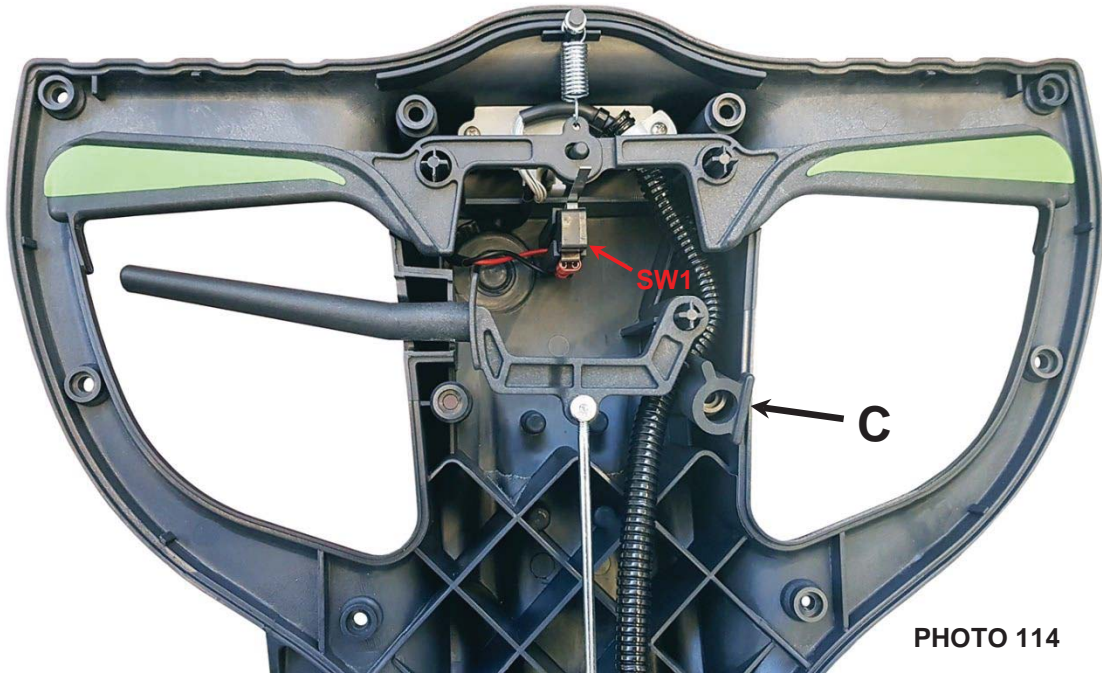

- 7 Remove the operating levers to reach the plastic latch that locks the board in place.
 8 Unscrew the two screws that secure the retainer and the corrugated pipe clamp of the flat cable.

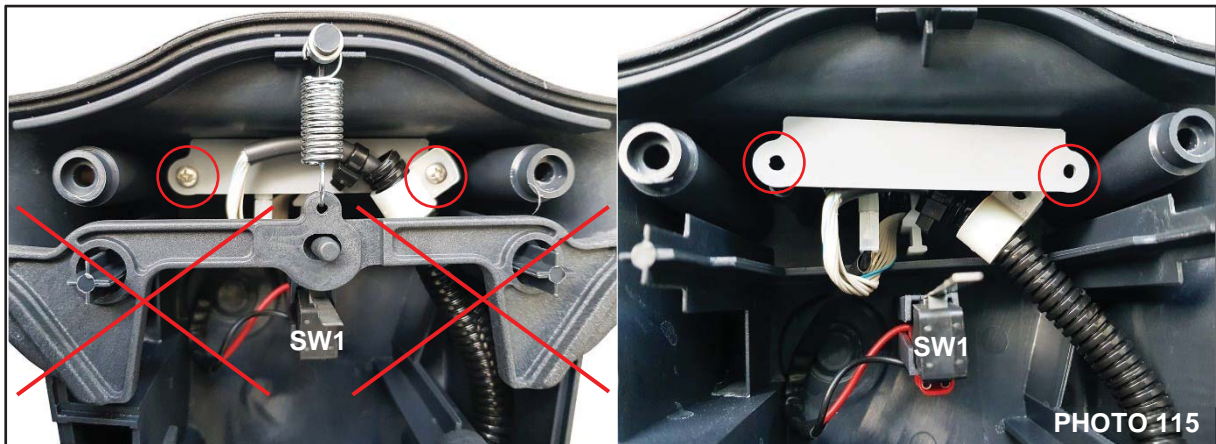

- 9 Move the clip that locks the flat cable connector to one side to allow the plank board to be removed.
 10 Pull out the dashboard card, disconnect it, and replace it with a new one.

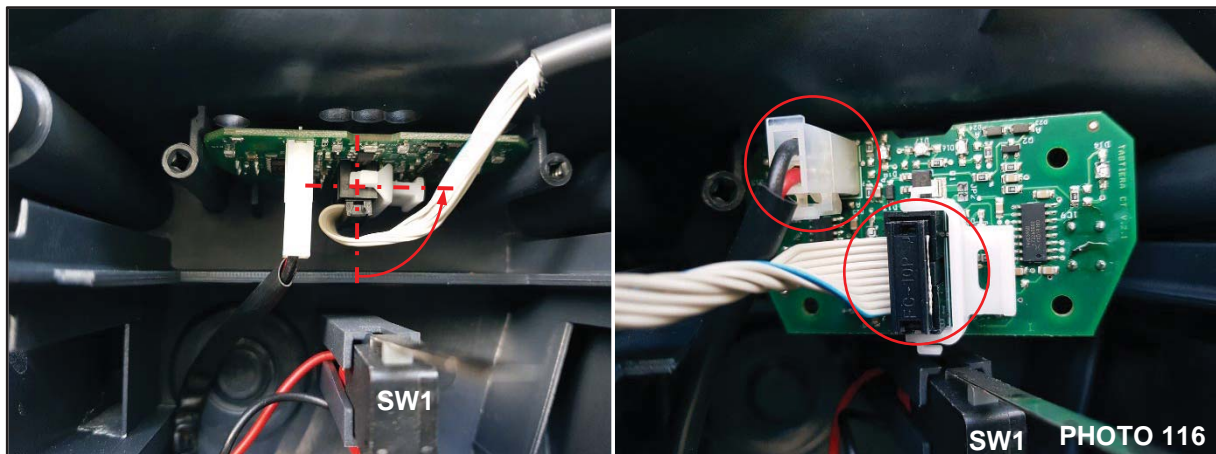



PLDC04626

REVISION 00

March 11, 2022

TECHNICAL DEPT.

Stavale

Disassembly, "Cord" type machines

- 1 Take the machine to a flat, dry floor area.
- 2 Make sure that the power indicator **D** on the control panel shows that the machine is switched off.
- 3 **Make sure that the machine's mains power cable is disconnected from the electricity supply.**
- 4 Remove the function control board by following the instructions previously described.



Reassembly

- 1 Replace the function control card with a new one of the same type and part number.
- 2 To fit the new function control card, repeat the steps for disassembly in reverse order.
- 3 Verify proper placement of cable retainer **C** and cable grommet before mounting the front half shell.

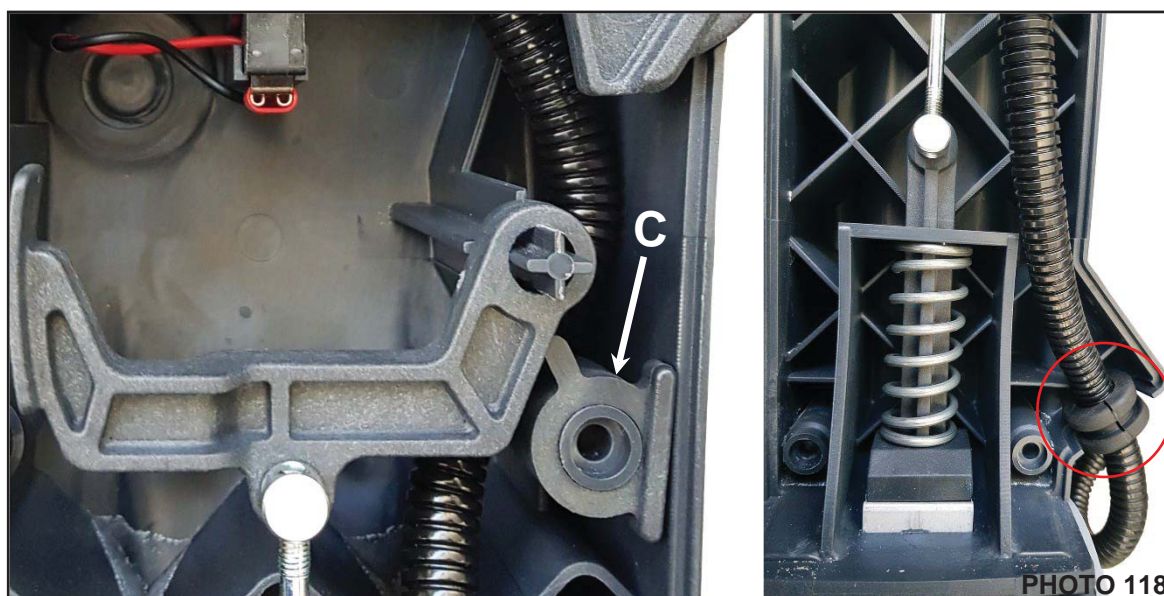



PLDC04626

REVISION 00

March 11, 2022

TECHNICAL DEPT.

Stavale

D1.2 Testing the function control card on “B” and “C” machines

i The function control card is powered via the power control card, at 24 V on “B” type battery machines and at 12 V on “C” type mains machines. Via its flat cable, the function control card controls the machine’s actuators (brush motor, suction motor, solenoid valve). It also constantly monitors motor functioning by measuring current draw and MOS-FET temperature readings, and cuts out power if necessary.

Check flat cable and PIN-OUT connectors multipole boards.

☞ Take careful note of the numbering of the pins on the function control card and power control card. Pin 1 is identified by an arrow on the connector and/or on the function control card. Pin numbering increments alternating between the rows, so that all odd numbers are on one row and all even numbers on the other.

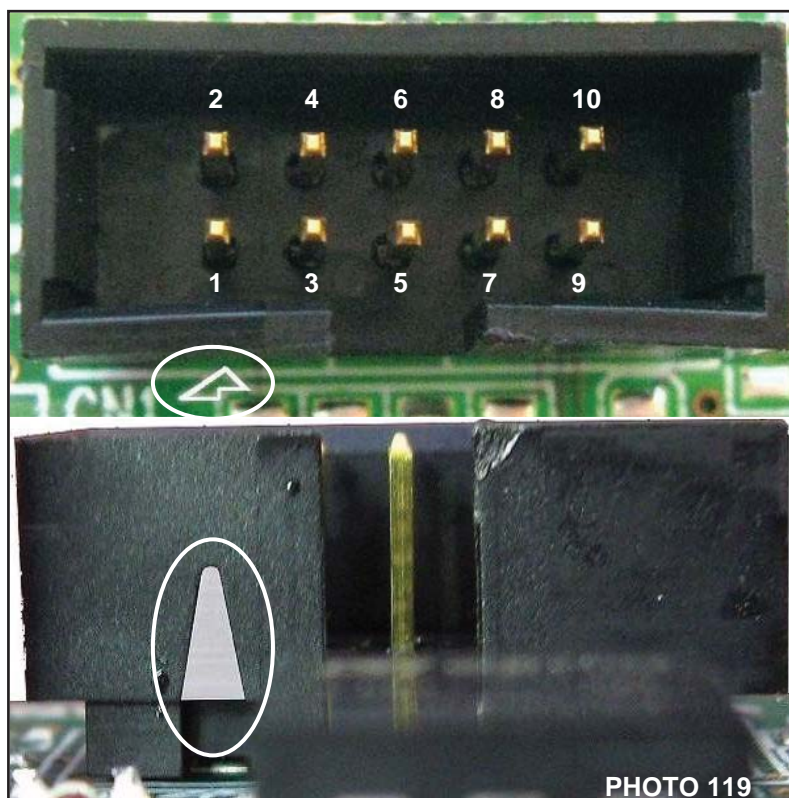

1 Set the digital multimeter to the continuity function and check the integrity of the 10 poles of the flat cable.

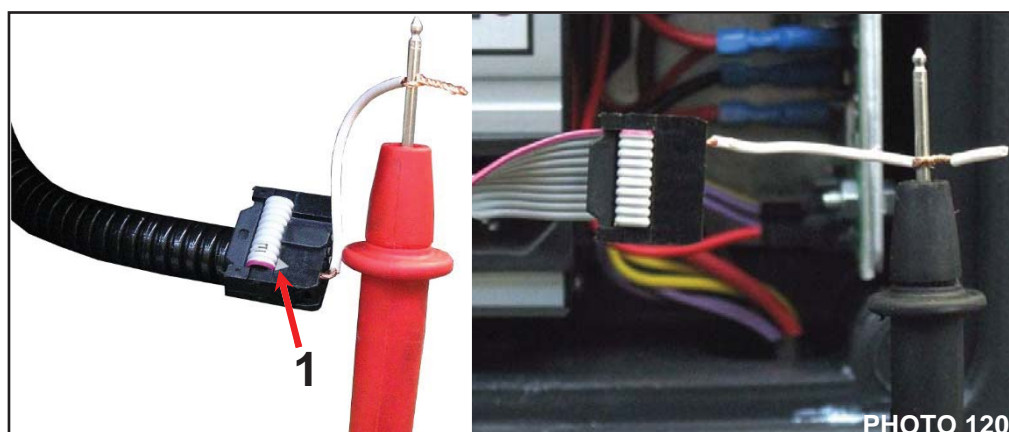

Replacing the flat cable

- 2 Remove the 30 Amp power fuse in the case of “Battery” type battery machines, or unplug the power cable in the case of “Cord” type mains machines.
- 3 The procedure for replacing the flat cable is similar for both “B” and “C” type machines. Disconnect and remove the function control card as instructed above.
- 4 Remove the rear cover from the power compartment as instructed above.
- 5 Disconnect the flat cable from the power control card.
- 6 Use a scissors to cut the connector off the flat cable so that the cable can be pulled through the sheath.
- 7 Secure a length of wire to the end of the old cable with insulating tape.

i The cable is supplied headed on both sides in order to perform the integrity check of the same.

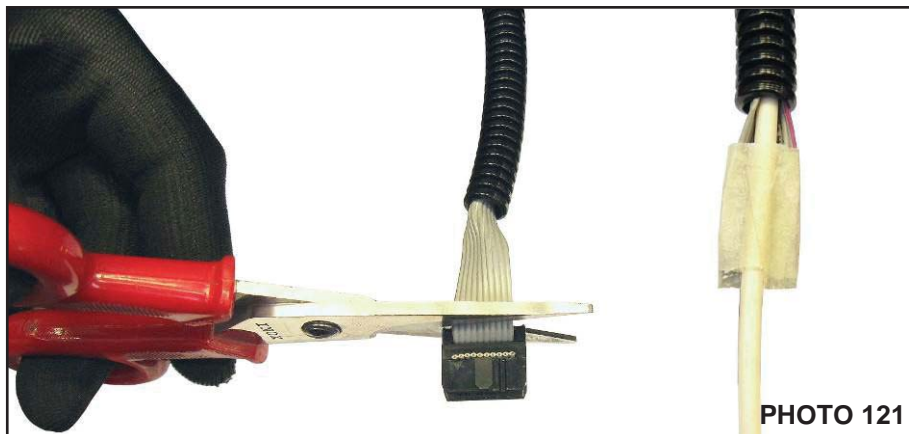

- 8 Pull the old flat cable through the sheath from the control panel end.
- 9 The new part consists of a flat cable, a sheath and a connector **A**. The connector comes in three parts, two pre-assembled and one to be fitted on the machine.

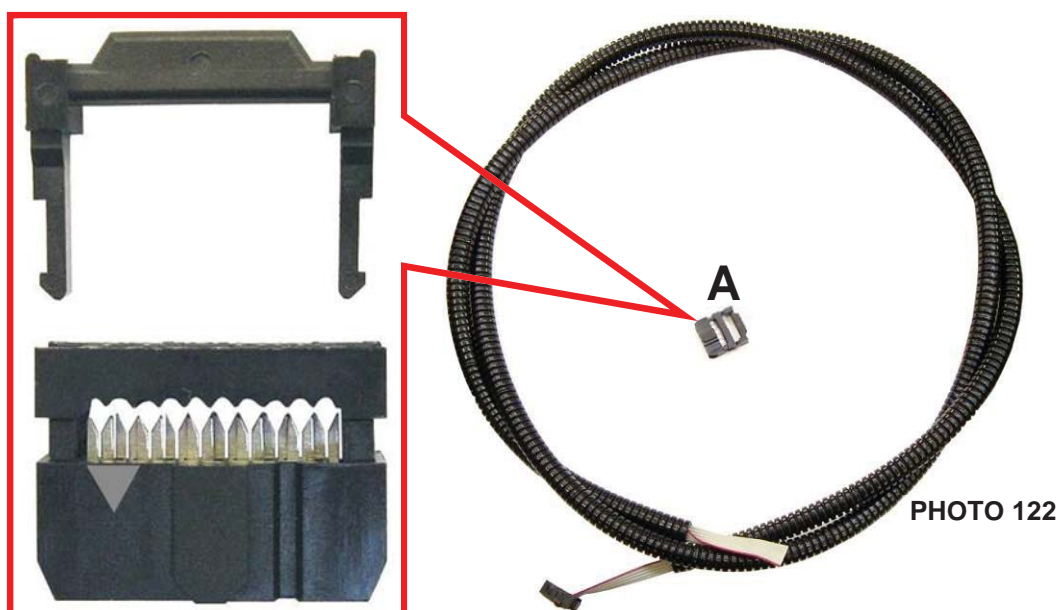

- 10 Attach the length of wire to the end of the new flat cable and pull it through the sheath to the power control card.
- 11 Fit the new connector I to the flat cable, taking care to align the wires correctly. The flat cable must be perfectly perpendicular to the connector A, and the red stripe on the cable must align with pin 1 on the connector A, identified by the arrow.
- 12 Push the outer part of the connector A firmly home until the side clips click into place.

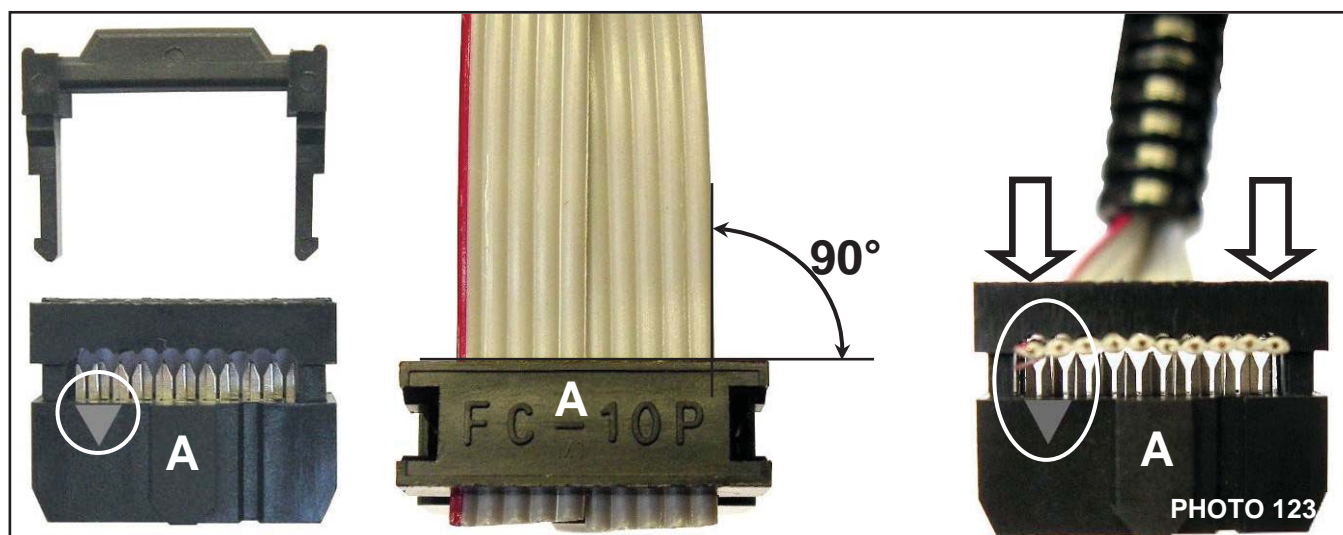

- 13 Fold the flat cable over the connector and fix it in place with the push-in clip (the third part of the connector).

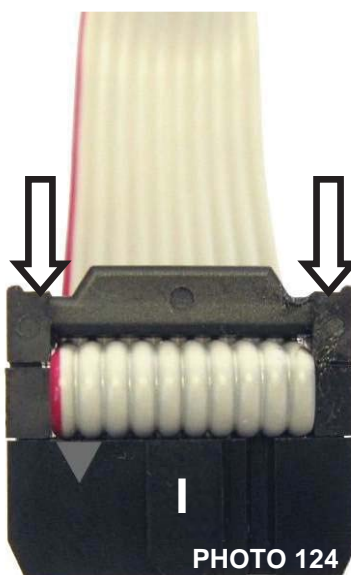

- 14 Connect the connector to the power control card. Put the cover back on the power compartment. Reassemble the function control card.



D1.3 Replacing the power control card on “B” type machines

Disassembly

WARNING



THE BOARDS ARE SET BY DEFAULT FOR THE CS16.

FOLLOW THE INSTRUCTIONS TO CORRECTLY PROGRAM THE MODEL

- 1 Move the machine to the tank draining area, and completely empty the collection tank.
- 2 Move the machine to a flat, dry floor. For convenience, use a fork lift if one is available.
- 3 Disconnect the suction hose **A** and arrange safely it under the machine.
- 4 Remove the collection tank from the machine if you have not already done so.
- 5 Remove the four screws **B** and remove the rear cover from the power compartment.



- 6 Identify the two bolts **C** securing the power unit to the solution tank.
- 7 Disconnect the battery charger from the machine harness, white connector and red cylindrical connectors.
- 8 Pull the bracket with battery charger and power card out of the dedicated compartment.





PLDC04626

REVISION 00

March 11, 2022

TECHNICAL DEPT.

Stavale

- 9 Disassemble the battery charger from the bracket by unscrewing the two bolts D to access the power board.
- 10 Disconnect the power board from the machine wiring.
- 11 Use a flat-blade screwdriver to remove the latch from the flat cable connector.

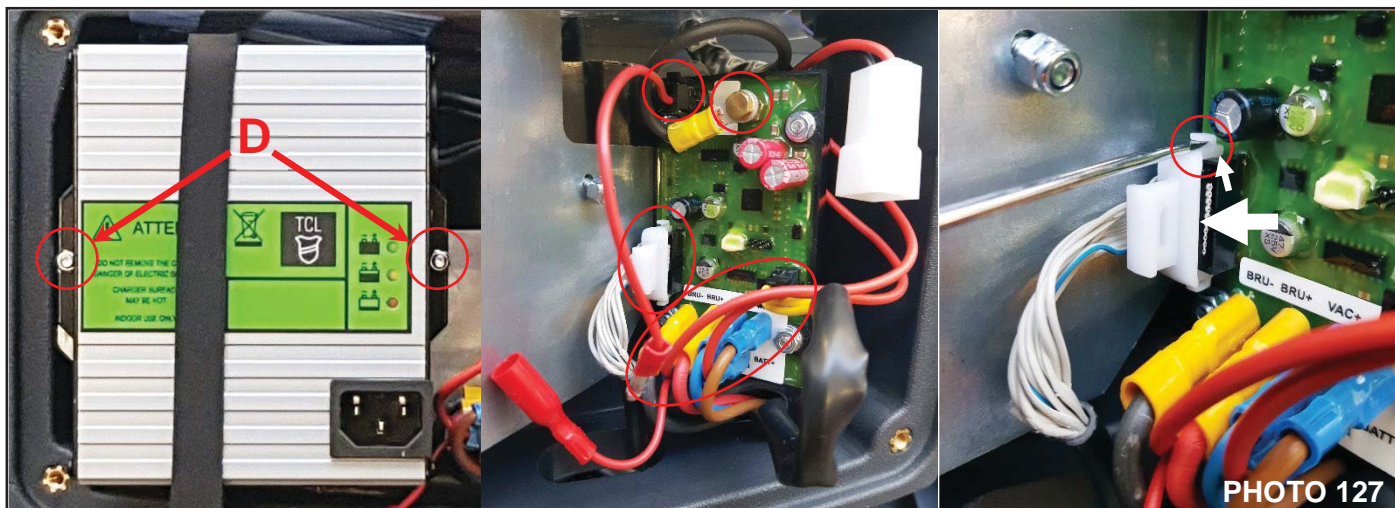

- 12 Unscrew the four bolts and remove the power board from the bracket for replacement.

Assembly

- 1 **WARNING:** It is mandatory to apply thermal conductive paste on the back of the power board to allow correct heat dissipation.
- 2 Replace the board with a new one and tighten the four bolts E to a maximum torque of 3 Nm - 26.55 lbf-in.





PLDC04626

REVISION 00

March 11, 2022

TECHNICAL DEPT.

Stavale

- 3 Proceed with connecting the electrical wiring.
- 4 Tighten screw **E** with a maximum torque of 3 Nm - 26.55 lbf-in.

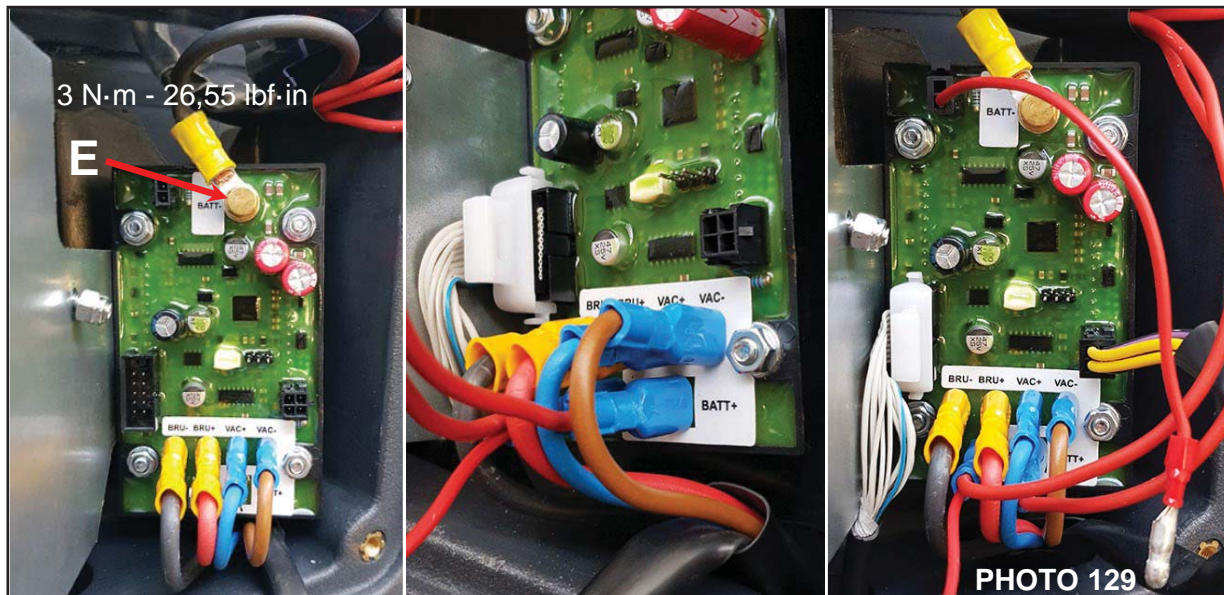

- 5 Replace the battery charger on the bracket and tighten screws **D** to a maximum torque of 3 Nm -26.55 lbf-in.
- 6 Reposition the bracket complete with battery charger in the dedicated compartment and fasten it to the tank.

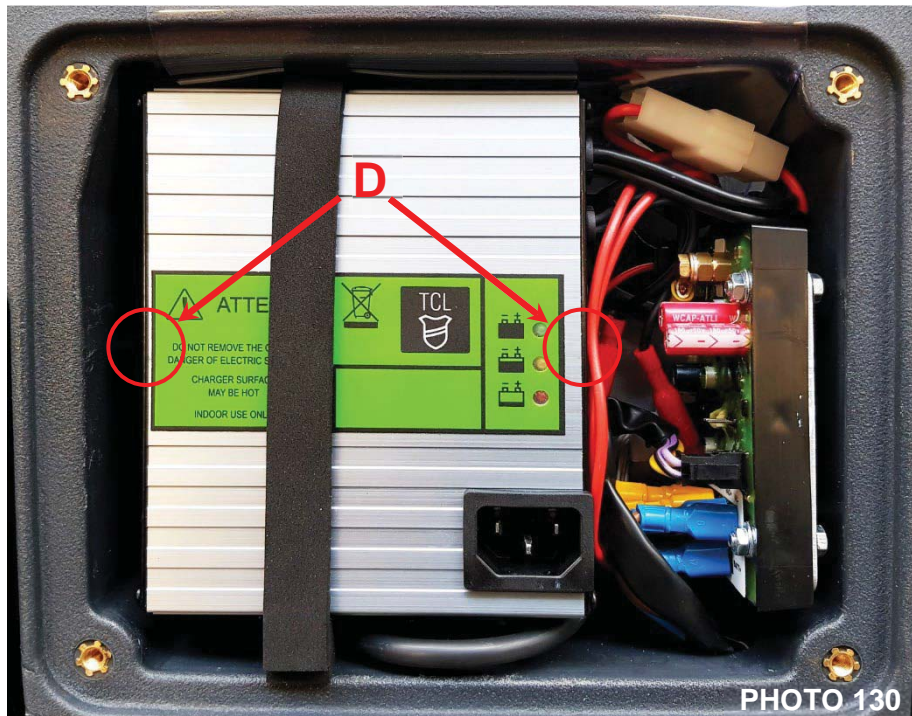

Reassembly

- 1 To fit the new power control card, repeat the steps for disassembly in reverse order.
- 2 Always apply thermally conductive paste between the back of the power control card and the power unit mounting plate.
- 3 Tighten the four bolts **E** to a maximum torque of 3 Nm - 26.55 lbf-in.
Tighten the bolts **D** to a maximum torque of 3 Nm - 26.55 lbf-in.

BOARD PROGRAMMING

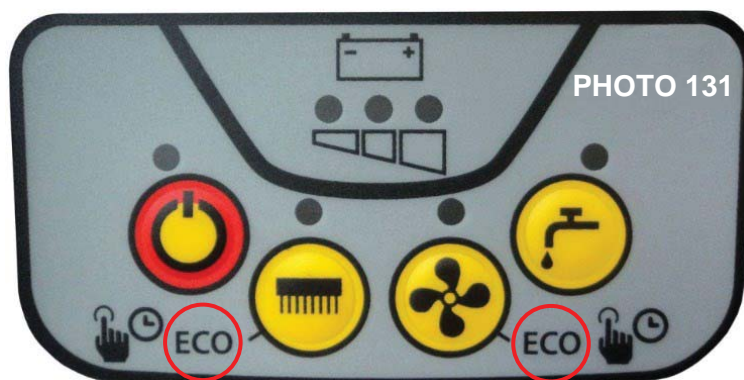

i The dashboard board, as well as the power board, is mounted on different types of machines. In addition to controlling the machine functions and displaying errors, it has the parameters of all the machines on which it is mounted stored in its memory. Consequently, if it is replaced, it must be programmed for the type of machine on which it is mounted.

On the CS16 this operation does not need to be carried out as the default cards are programmed for the latter.

ECO FUNCTION

i The ECO function, independently selectable for the brush motor and the suction motor, allows to reduce the supply voltage of the motors with the result of increasing the working time and reducing the noise level of the machine.

The electronic board stores the last setting to memory even if the machine is switched off.

Activate/deactivate ECO function:

- 1 Switch the machine on using the "On-Off" button.
- 2 Activate the *brush control lever*, then press the *brush button* until the corresponding LED starts flashing; power to the brush motor will be reduced.
- 3 Activate the *brush control lever*, then press the *suction motor button* until the corresponding LED starts flashing; power to the suction motor will be reduced.



PLDC04626

REVISION 00

March 11, 2022

TECHNICAL DEPT.

Stavale

D1.4 Testing the power control card on “B” type machines

The power control card supplies the function control card with power and signals for the current draw of the brush and suction motors. The function control card uses these signals to generate LED error code on the control panel and to disconnect power if current draw exceeds maximum limits. The power control card drives the brush and suction motors via MOS-FETs to provide a soft-start ramp.

i *The power control card also provides the function control card with signals for MOS-FET temperature, to prevent these components from overheating when the motors are running. Maximum permitted temperature is 150° C. If this limit is exceeded, the function control card commands the power control card to disconnect power to the affected motor.*

Testing the suction motor

- 1 If the suction motor fails to operate when suction is switched on at the control panel, test the following components.
- 2 Use a pair of cables of adequate size to connect the suction motor directly to the batteries. If the motor runs, check the power supply from the power control card.

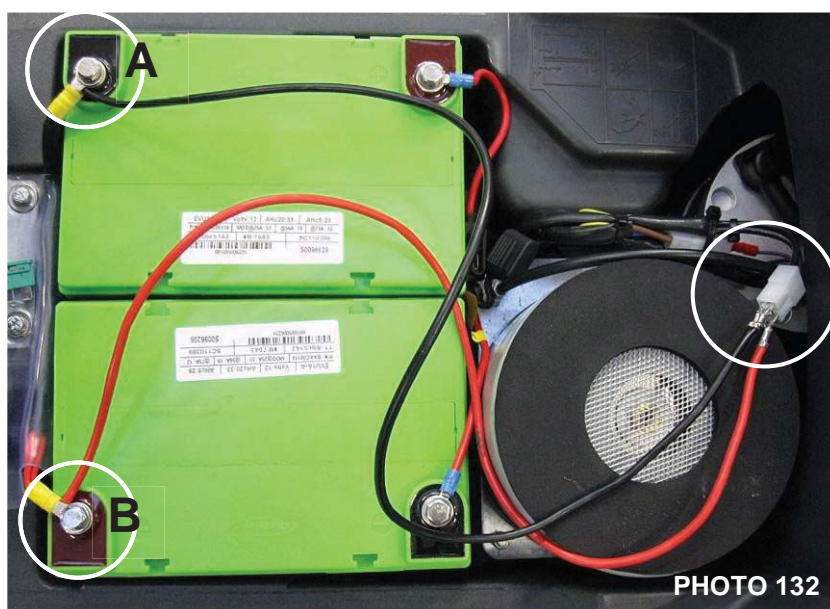

- 3 Use a digital multimeter able to read voltage (V).
- 4 Measure the voltage of power from the batteries to the power control card with the black negative probe on the dedicated contact F4, and the red positive probe on the fast-in F1. Voltage between these points must be identical to voltage across the battery terminals A – B. If voltage is correct, check the continuity of the cables powering the suction motor.





5 Use a digital multimeter able to read electrical resistance in Ohms.

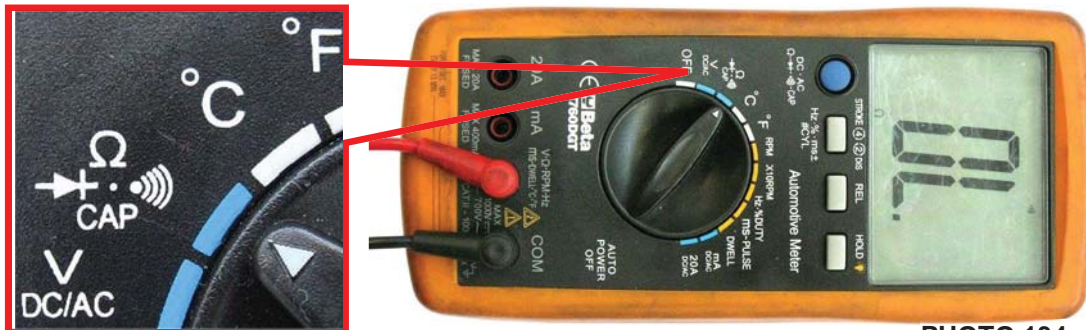

PHOTO 134

6 Use the digital multimeter to check the continuity of both power cables from the power control card to the suction motor.

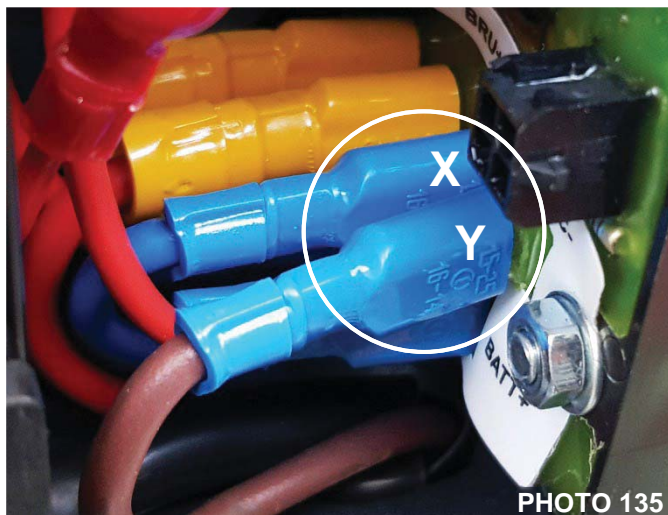

PHOTO 135

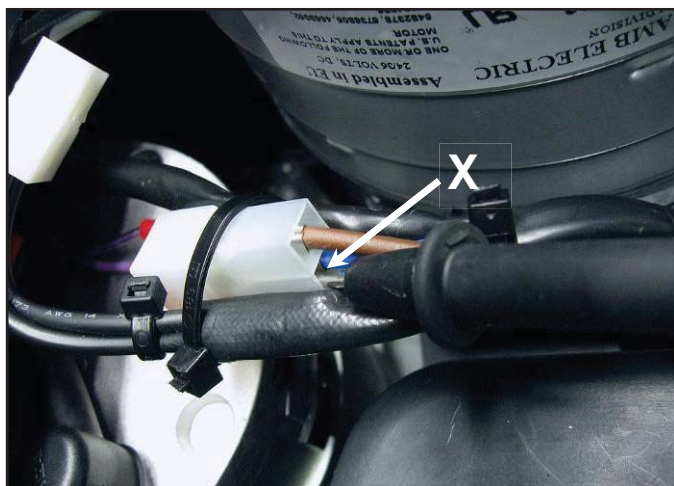
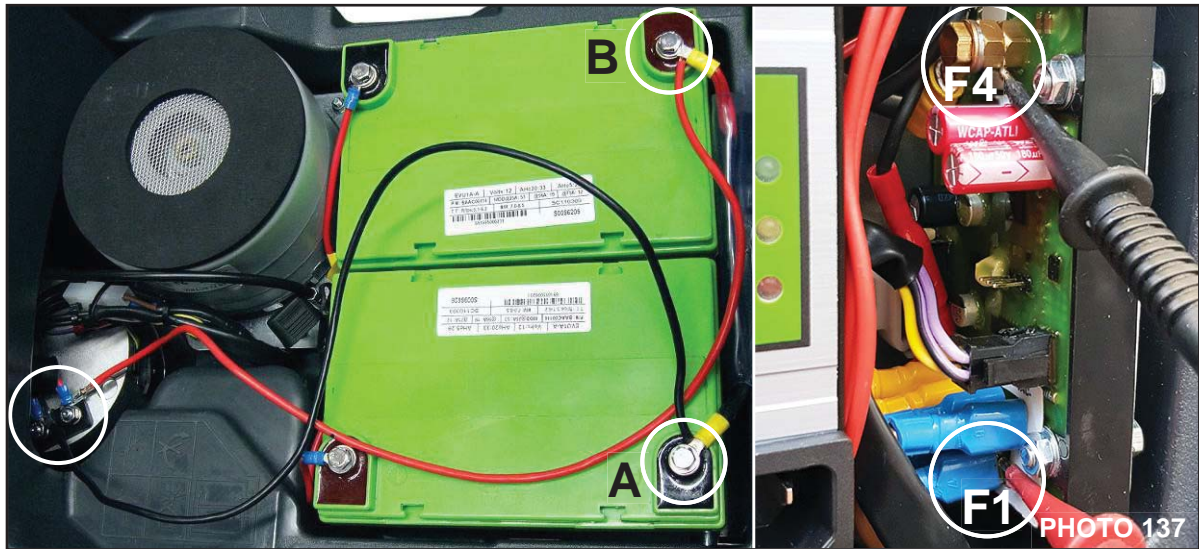

PHOTO 136

7 If the above tests find no faults, remove and replace the power card with a new one.

Testing the brush motor

- 8 If the brush motor fails to operate when switched on at the control panel, test the components in the circuit. Start by testing the motor's thermal cutout, as instructed in section A2.4.
- 9 Raise the brush off the floor and remove it. Using a pair of cables of adequate size, connect the brush motor directly to the batteries. If the motor runs, first test the power supply from the batteries to the power control card as instructed in steps 3 and 4 above. If voltage is reaching the card, test the cables to the motor for continuity.



- 10 Use a digital multimeter able to read electrical resistance in Ohms (Ω).

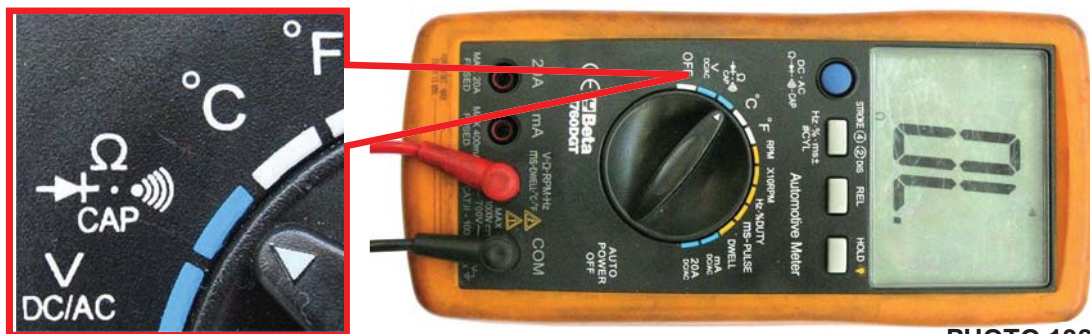

PHOTO 138

- 11 Use the digital multimeter to check the continuity of both power cables from the power control card to the brush motor.



PHOTO 139



PLDC04626

REVISION 00

March 11, 2022

TECHNICAL DEPT.

Stavale

D1.5 Replacing the power control card on “Cord” type machines

WARNING! RISK OF ELECTRIC SHOCK

Disassembly

- 1 Move the machine to the tank draining area, and completely empty the collection tank.
- 2 Move the machine to a flat, dry floor. For convenience, use a fork lift if one is available.
- 3 **Make sure that the machine’s mains power cable is disconnected from the electricity supply to avoid all risk of electric shock.**
- 4 Disconnect the suction hose from the collection tank. Lift up and remove the collection tank.
- 5 Locate the waterproof box containing the power control card.

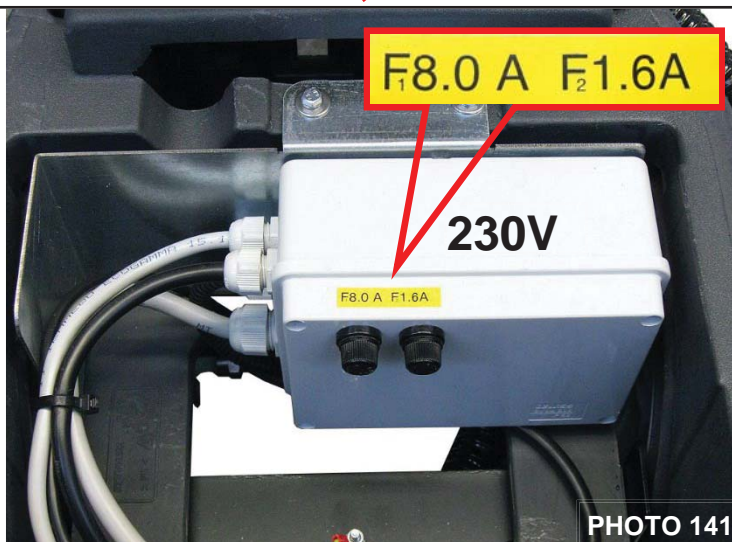

- 6 Unscrew the two bolts **A** fixing the box’s mounting plate to the solution tank.
- 7 Arrange the box so that you can remove its cover without pulling on the cables going into it.
- 8 Unscrew the four screws **B** securing the cover to the box.

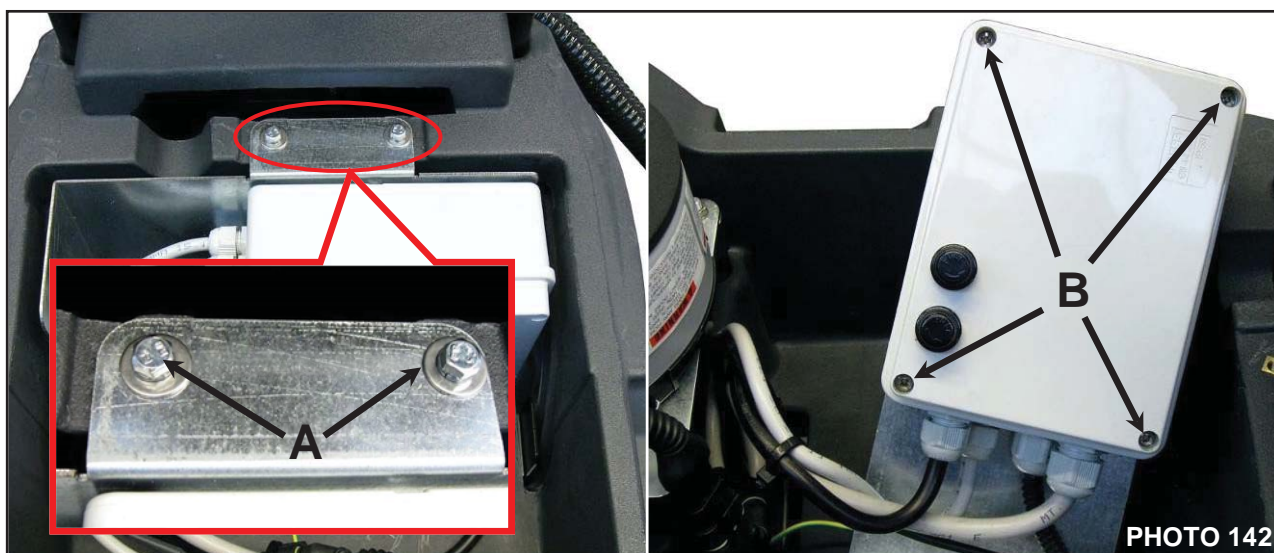



- 9 Identify the connectors you need to disconnect to remove the power control card from the waterproof box.
- 10 Disconnect the black wire **C1** and the brown wire **C2** (common) for the suction motor, and the grey wire **D1** and brown wire **D2** (common) for the brush motor. Disconnect the connector **CN2** of the brush motor's thermal cutout, the connector **CN3** of the flat cable, and the connector **J3** supplying power to the function control card and solenoid valve.

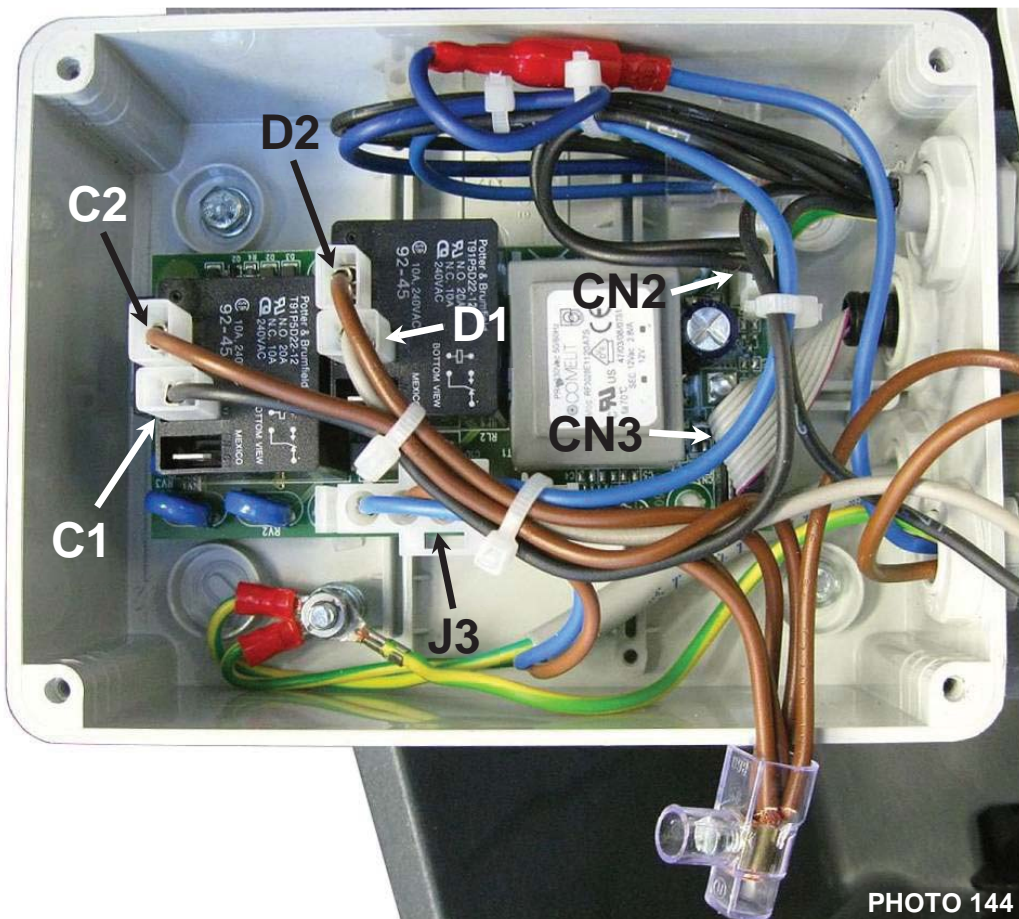

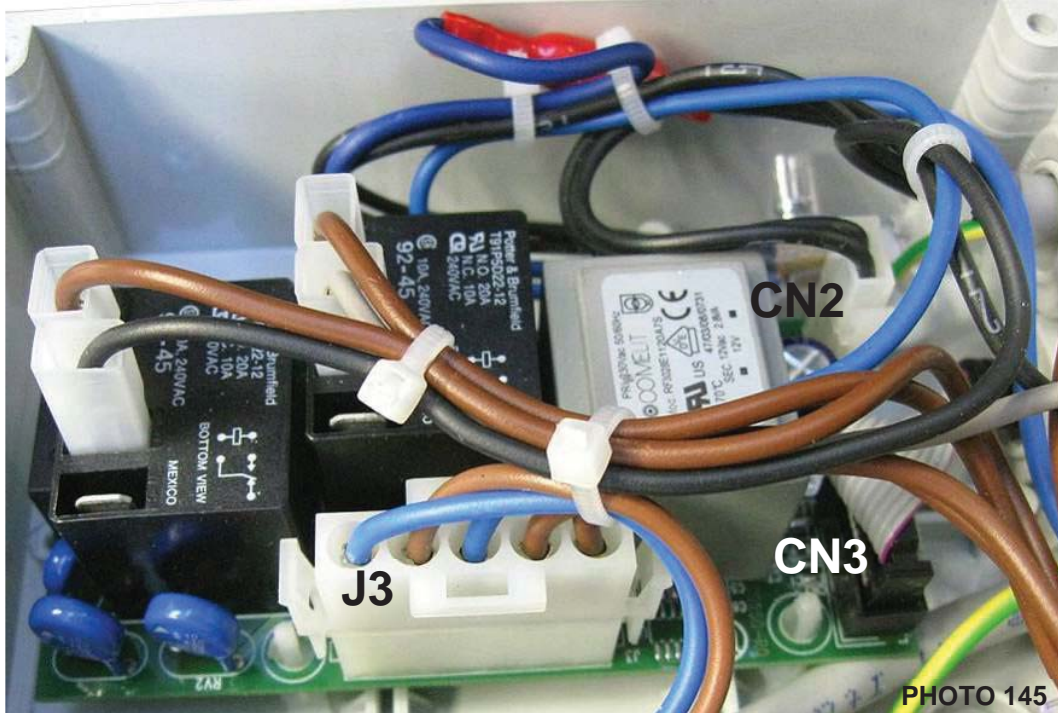

- 11 Once all the connectors have been disconnected, remove the power control card from the box.
- 12 Use a long nose pliers to release the four plastic clips **E** holding the power control card in place and lift the card out to remove it.

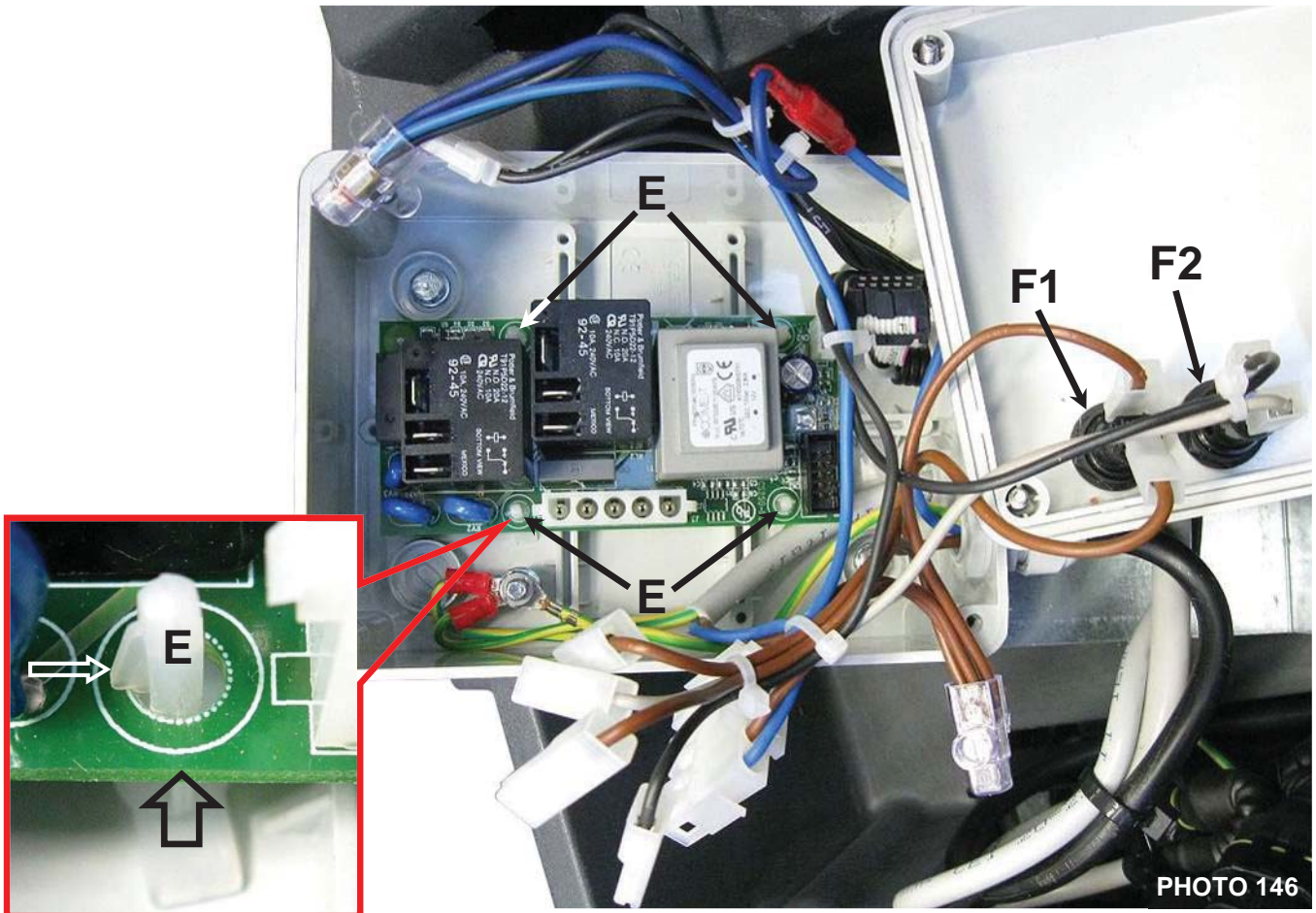



- 13** Take care not to damage the connections to the fuses. The fuse **F1** (8 A for 230 V machines, is the main fuse, and protects the motors and all main functions. The fuse **F2** (1.6 A for the 230 V protects only the brush motor and is connected in series to the fuse **F1**.
- 14** Replace the power control card with a new one, making quite sure that the transformer power rating is identical to the old card (230 V), since all functions depend on the transformer output (12 V).

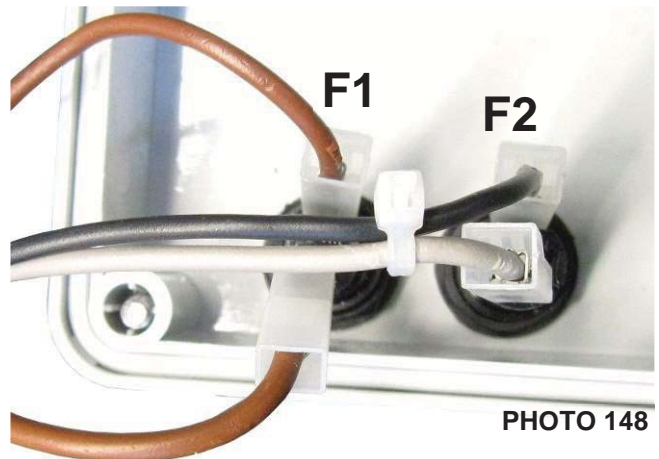

Reassembly

- 1** Replace the power control card with a new one, making quite sure that the transformer power rating is identical.
- 2** To fit the new power control card, repeat the steps for disassembly in reverse order.

D1.6 Testing the power control card on “C” type machines

WARNING! RISK OF ELECTRIC SHOCK



Make quite sure that the power cable is disconnected from the electricity supply before starting to test the power control card. Disconnect all connectors from the card and remove the card from the waterproof box before starting testing.

Inspection and testing

- 1 Make sure that the machine’s mains power cable is disconnected from the electricity supply.
- 2 Remove the power control card as instructed in the previous section before starting testing, in order to avoid possible false readings.
- 3 Inspect the card visually for signs of burning.
- 4 The components most at risk of burning out are the MOV suppressors fitted on the inputs to the three relays to protect the power users.

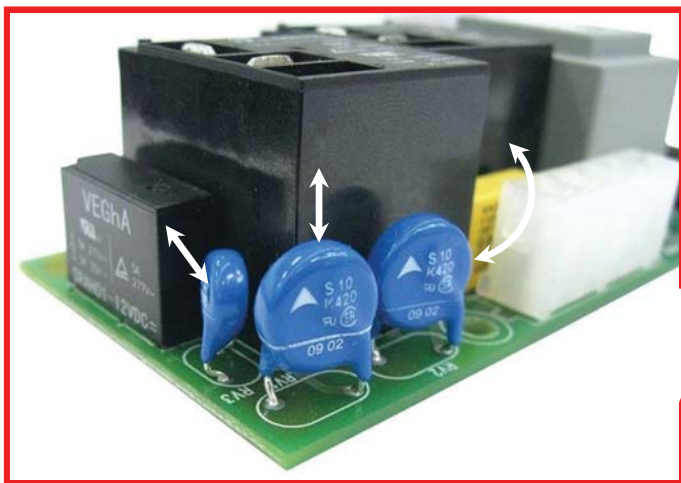

- 5 If there are no signs of card components having burned out, visually inspect the capacitor **A** downstream from the transformer. If the upper part of the capacitor is swollen, it could well have lost its efficiency and be interfering with the correct functioning of the power control card.

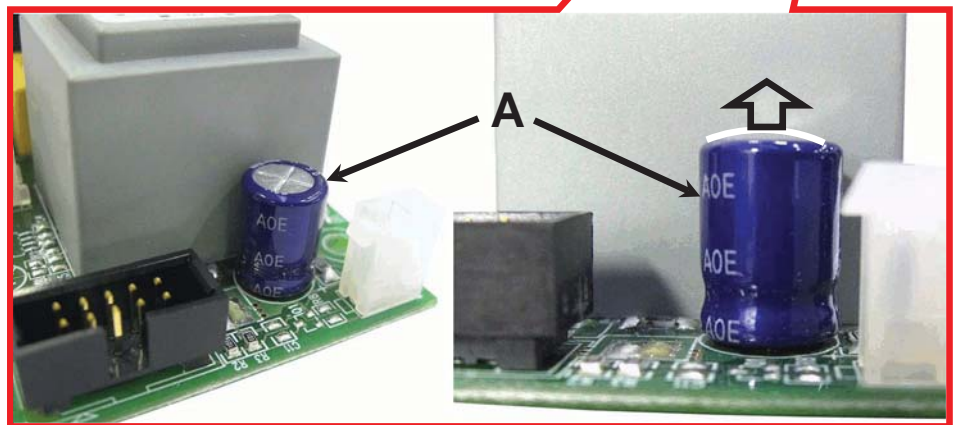

230 V power control cards

- 6 If there are no signs of any burned components and the capacitor is not swollen, measure the resistance of the transformer windings. The transformer is the most important component on the power control card as it generates the low voltage for the function control card and the three relays for the suction motor, brush motor and solenoid valve.
- 7 Use a digital multimeter able to read electrical resistance in Ohms (Ω).

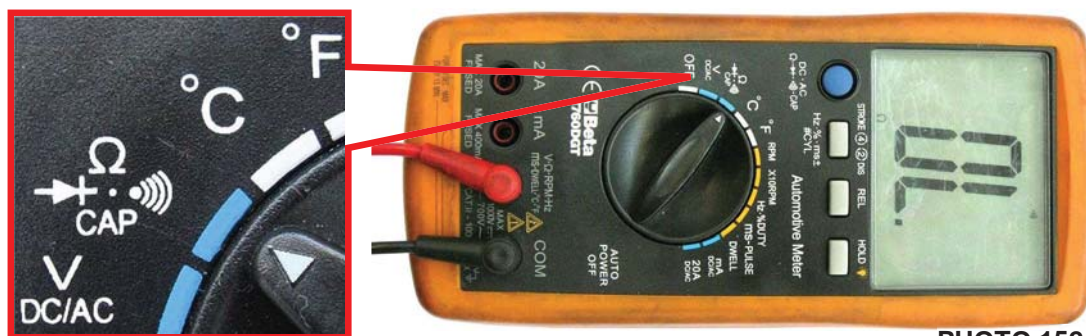
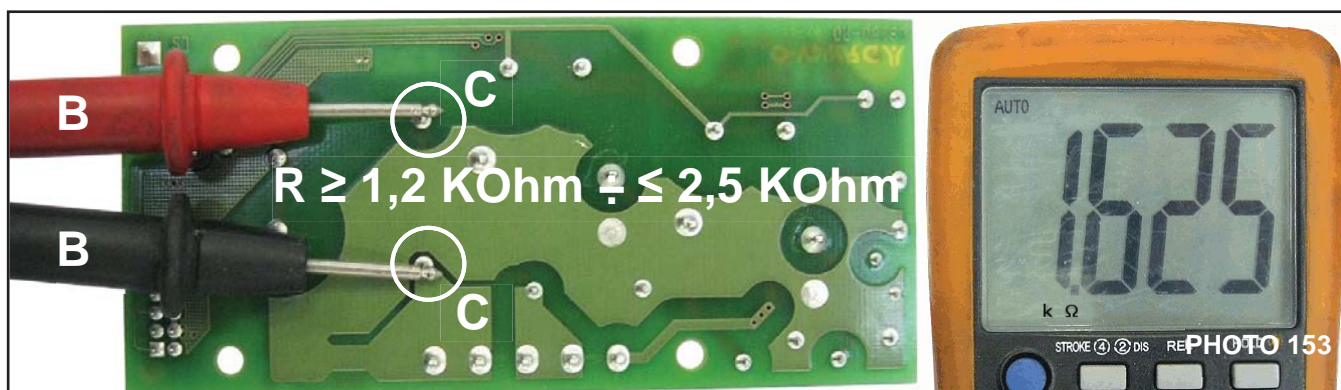

PHOTO 152

Testing the 230 V primary windings

- 8 Use a digital multimeter able to measure resistance in Ohms. Measure the resistance of the transformer's primary winding. Connect the two probes **B** of the multimeter to the two ends of the transformer's primary winding. (The position is irrelevant.)
- 9 The resistance in Ohms (Ω) must lie between 1.2 KOhm and 2.5 KOhm (1200 Ohm and 2500 Ohm).



- 10 If the measured resistance lies outside this range, the winding is defective. This will cause the entire power control card to malfunction. The entire card must therefore be replaced to restore correct functioning.
- 11 If the measured resistance lies within the specified limits, proceed to measure the resistance of the transformer's secondary winding.

Testing the 12 V secondary windings (on a 230 V machine)

- 12** Use a digital multimeter able to measure resistance in Ohms. Measure the resistance of the transformer's secondary winding. Connect the two probes **B** of the multimeter to the two ends **D** of the transformer's secondary winding. (The position is irrelevant.)
- 13** The resistance R in Ohms (Ω) must lie between 10 Ohm and 30 Ohm.

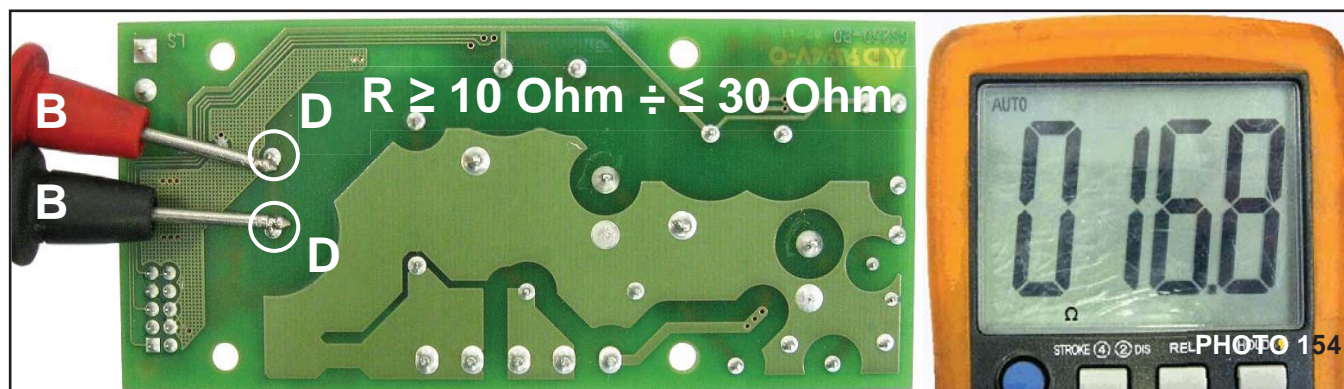

- 14** If the measured resistance lies outside this range, the winding is defective. This will cause the entire power control card to malfunction. The entire card must therefore be replaced to restore correct functioning.
- 15** If the measured resistance lies within the specified limits, proceed to the next tests.

Measuring the resistance of the relay coils



The power control cards powers the brush and suction motors via relays, energised by the function control card. The relay coils are energised at 12 V DC. The relays are therefore theoretically interchangeable. The solenoid valve relay is also powered at 12 V DC.

- 16 The last operation required is to measure the resistance of the coil in the relay for the brush motor or suction motor. Only the coil of the relay for the malfunctioning motor need be tested.

Measuring resistance in the brush motor or suction motor relay coil.

- 17 Use a digital multimeter able to read electrical resistance in Ohms (Ω).

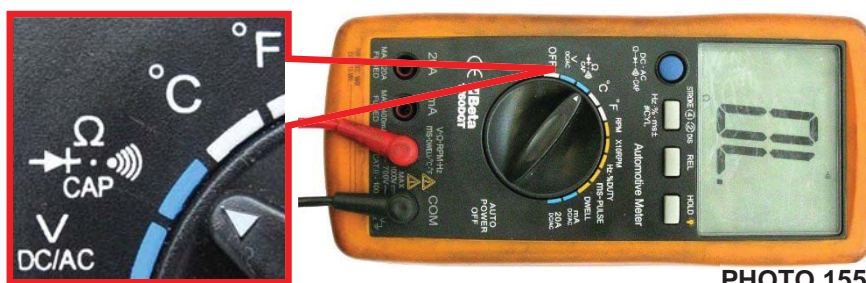

PHOTO 155

- 18 Use a digital multimeter able to measure resistance in Ohms. Measure the resistance of the relay's coil. Connect the probes **B** of the multimeter to the two ends **G** of the brush motor relay coil, or to the two ends **H** of the suction motor relay coil.
- 19 The resistance R in Ohms (Ω) must lie between 100 Ohm and 200 Ohm.



PHOTO 156

- 20 If the measured resistance lies outside this range, the relay coil is defective. This will prevent the brush motor or suction motor from starting up. Replace the entire power control card.



Testing for continuity in cables

- i** If the measurements performed on the power control card have revealed no problems, test the continuity of the power cables to the motors and solenoid valve.

In the following tests, there must be no breaks in continuity in any cable.

- 21** Make sure that the machine's mains power cable is disconnected from the electricity supply.
- 22** Remove the waterproof power box from the solution tank.
- 23** Remove the cover of the box to access the power control card.
- 24** Disconnect the waterproof electrical connections to the motors and solenoid valve.

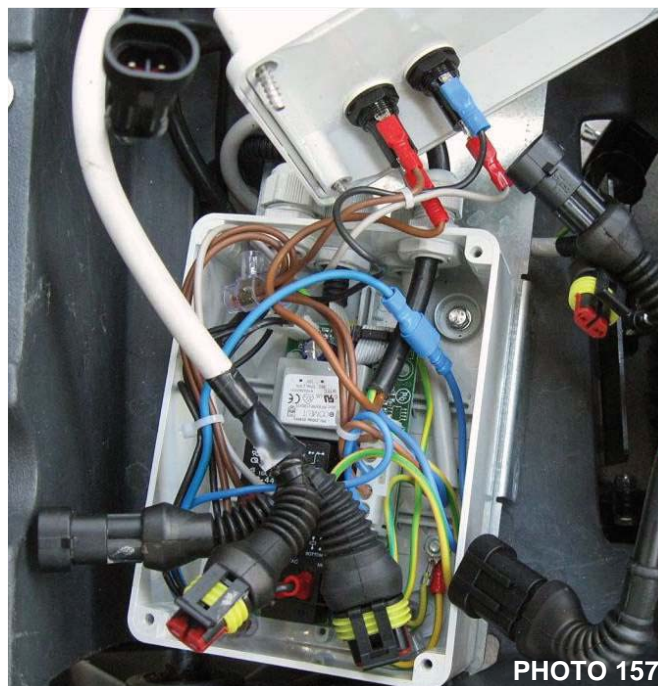

- 25** To facilitate measurements at the connectors, remove the plastic clips covering the metal pins.
- 26** Take care to identify the black wires correctly. These are identified by numbers printed on the insulating sheath.

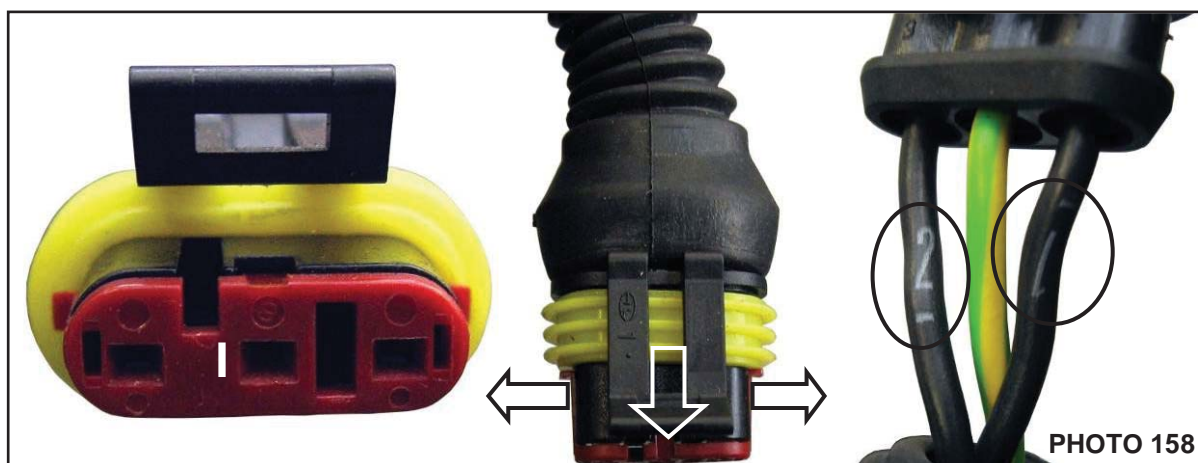

- 27** If it proves impossible to test for continuity at the fast-ons of the brush motor and suction motor relays, disconnect the fast-ons from the relays one at a time to test for continuity.



PLDC04626

REVISION 00

March 11, 2022

TECHNICAL DEPT.

Stavale

Testing the brush motor cables for continuity

- 28** First of all test the cable of the brush motor for continuity. This is easily identified as it is the only cable with a three way connector. Connect the red positive probe of the digital multimeter to the fast-on of the grey wire, and the black negative probe to black wire number 2, pin 3.

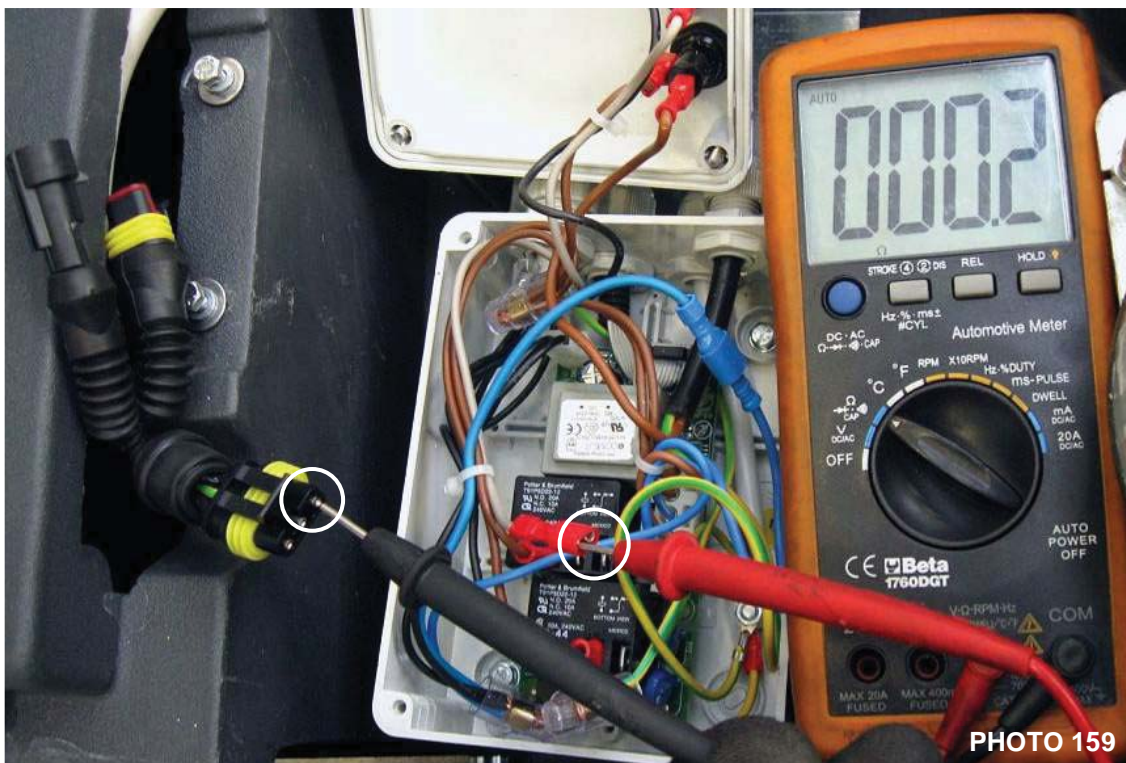

- 29** Now test black wire number 1. Move the black negative probe from pin 3 to black wire number 1, pin 1. Move the red positive probe from the fast-on to the common connector.

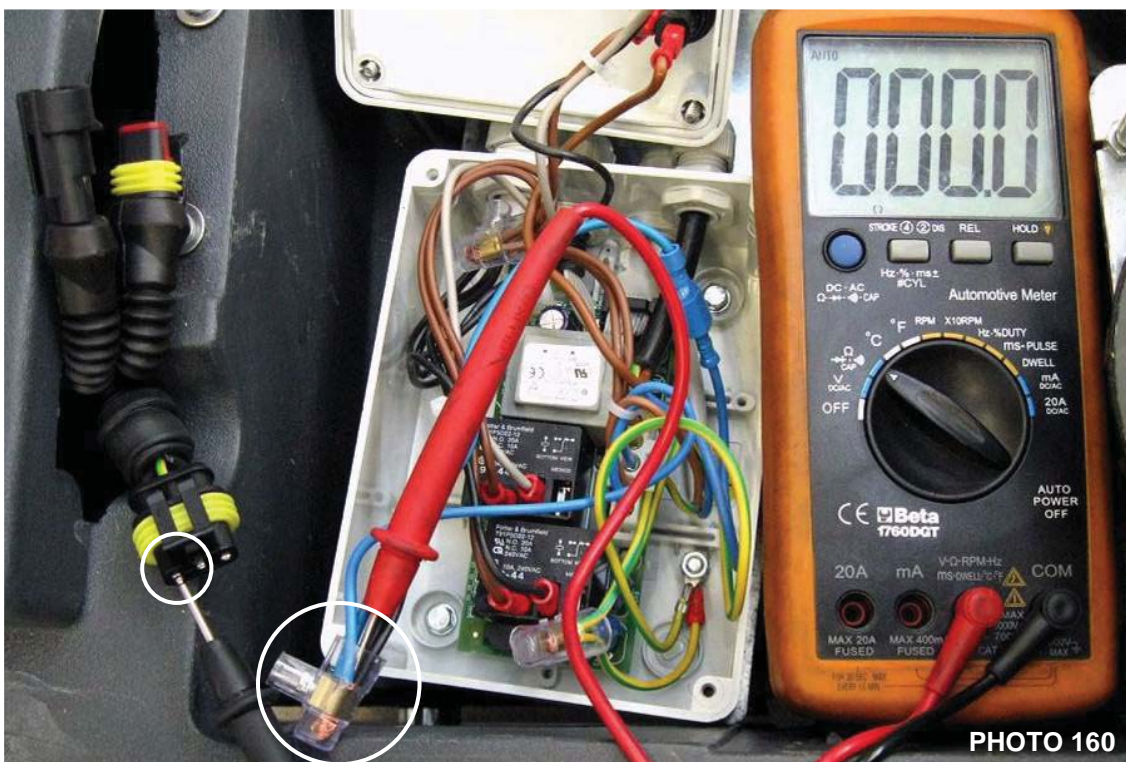



PLDC04626

REVISION 00

March 11, 2022

TECHNICAL DEPT.

Stavale

- 30** Now test the third, ground wire. Though this does not influence the functioning of the brush motor, its continuity is important for safety purposes. Move the black negative probe to the connector's central **pin 2**. Move the red positive probe to the common connector ground connector, recognisable for its yellow-green wires.

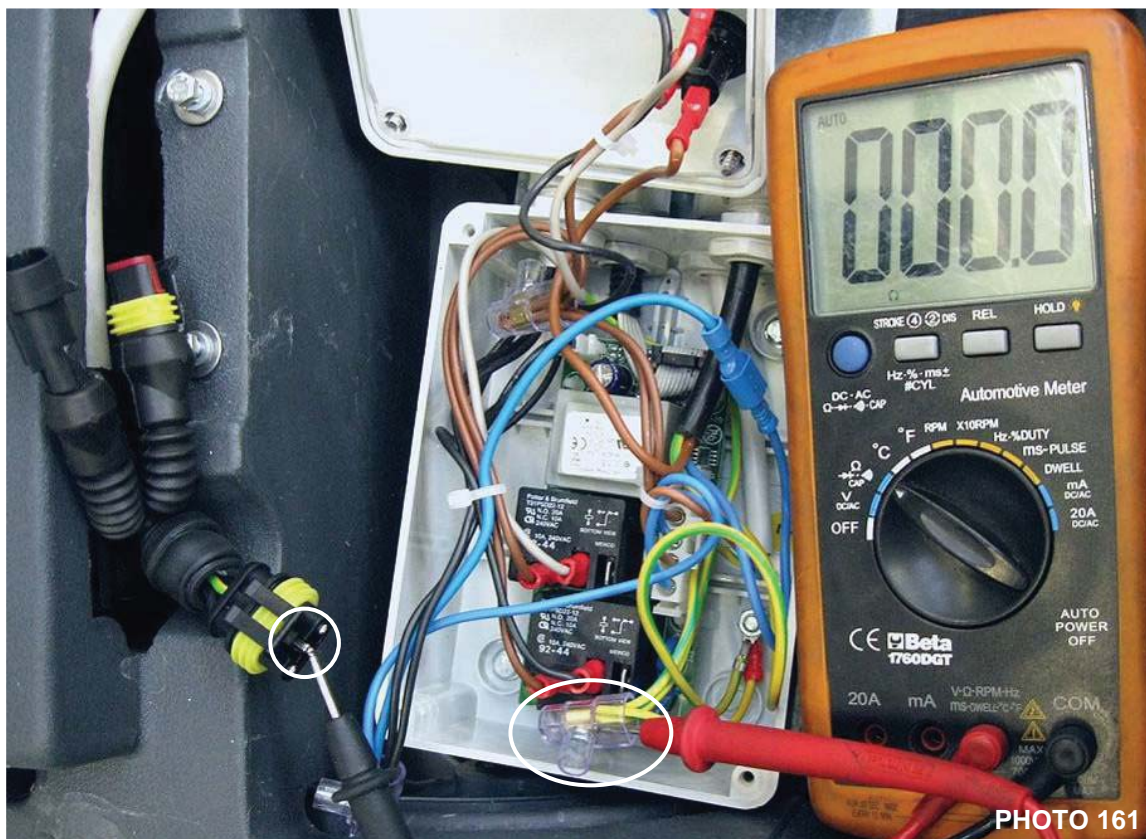



Testing the suction motor cables for continuity

- 31** Check the continuity of the suction motor cables. Move the black negative probe from the brush motor connector to **pin 2** on the male two-pin suction motor connector. Move the red positive probe to the fast-on of the black wire to the suction motor relay.

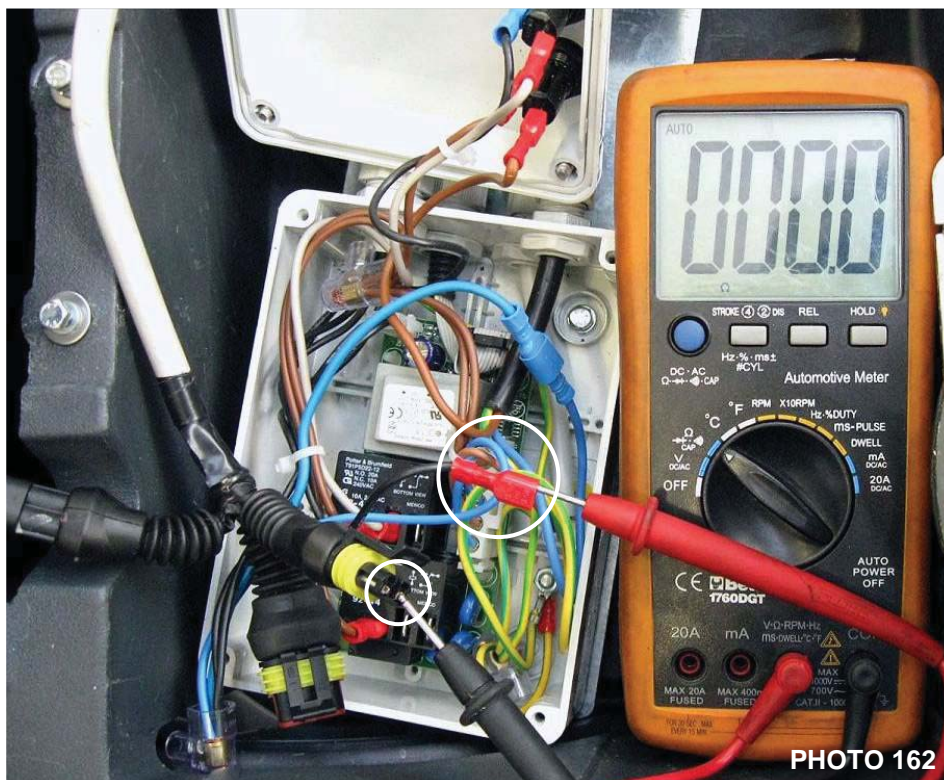

- 32** Move the black negative probe to **pin 1** of the same connector, and move the red positive probe from the fast-on to the common connector for the blue and black wires.

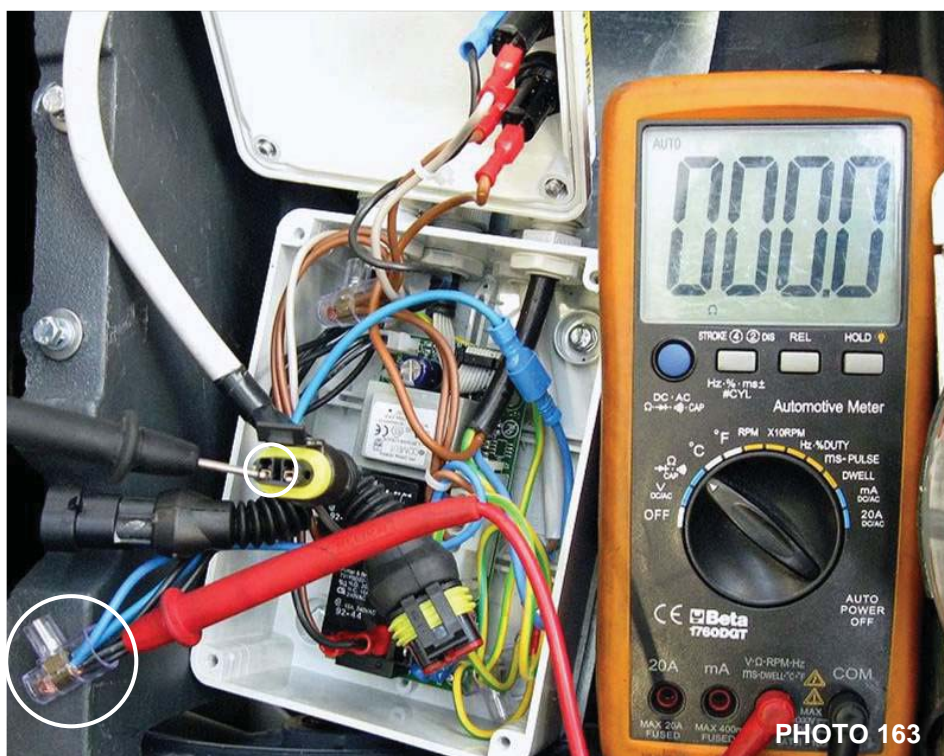

Testing the solenoid valve cables for continuity

- 33** Check the continuity of the solenoid valve cables. Connect the red positive probe to the common connector of the blue and black wires. Connect the black negative connector to **pin 2** of the solenoid valve's black connector.

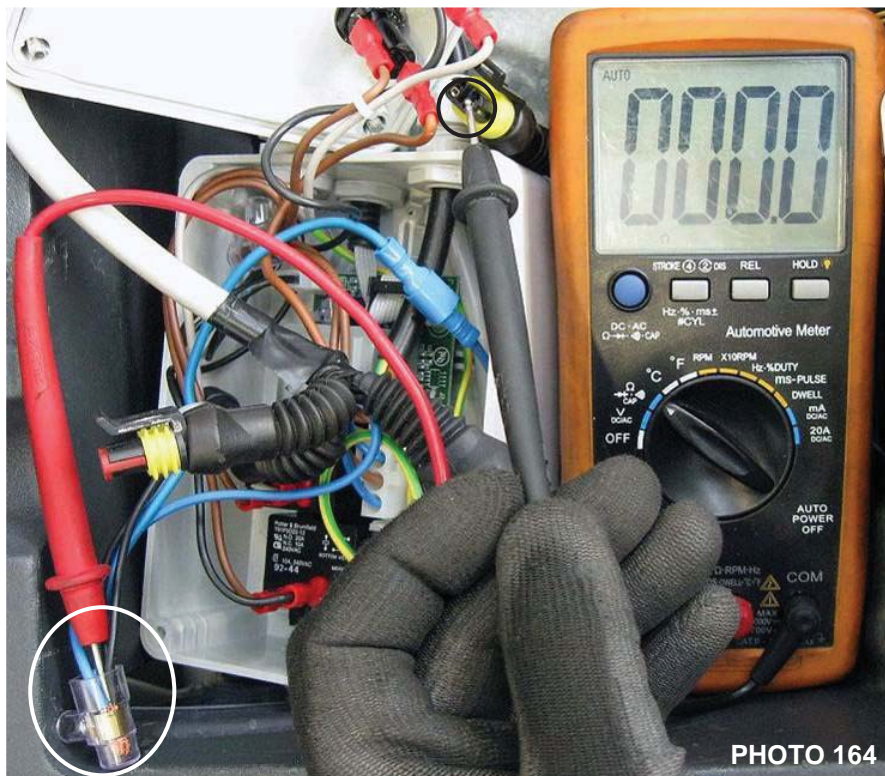

- 34** Move the red positive probe to the blue wire, **pin 5**, in the connector to the card, and move the black negative probe to **pin 1** of the solenoid valve's black connector.

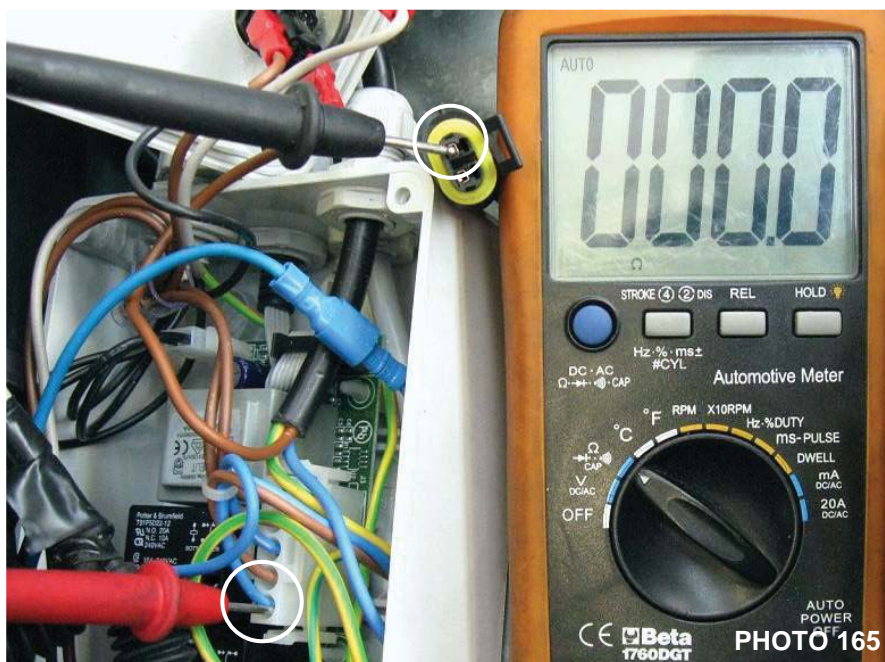

- 35** On completion of all tests, re-connect the various cable



D2 BATTERY CHARGER

The battery charger is an advanced, high frequency electronic unit. It is designed to function at any supply voltage between 100 and 240 V AC. The charging process is entirely microprocessor controlled. Battery charging is therefore unaffected by variations in supply voltage. The charging cycle begins with a soft-start and ends with an automatic reset when the batteries are full charged. The minimum voltage difference required to initiate charging is 2V. The battery charger also incorporates an output relay to protect it against reversed polarity, short circuit, over-voltage, and other hazards. Any malfunction is signalled by a red or yellow flashing LED.

The battery charger's operating principle is extremely simple. When it is switched on, the battery charger tests the batteries to ascertain their level of charge. Whether the charge cycle begins or not depends on battery voltage. If the batteries are disconnected from the battery charger, the red LED flashes. If the batteries are properly connected to the battery charger, the red LED lights after about one second, and the relay energises to begin the first phase of the charge cycle, at a fixed high current. Battery voltage is constantly monitored. When the required voltage is reached, charging current drops to a predetermined level, at which point the second phase of the charge cycle begins, identified by the yellow LED lit. During this phase, charge current remains stable while voltage rises a little. If the batteries are disconnected during the course of the charge cycle, the battery charger resets itself after a few seconds ready for the next charge cycle. When the batteries reach the required level of charge, the battery charger ends the charge cycle and the green LED lights. Depending on the selected charge end state, the battery charger will either stop charging completely or will maintain a trickle charge to keep the batteries charged.



PHOTO 166

D2.1 Replacing the battery charger

 ***If battery charging problems are encountered on a machine, before you replace the battery charger, test whether it is functioning correctly or not. The problem may well be that the batteries are no longer holding their charge. Use a digital multimeter able to read both direct current voltage (Vdc) and direct current amperage (Adc).***

Test 1

 ***Measure the voltage of the batteries, then measure that supplied by the battery charger. Check that the Vdc voltage of the charger exceeds that of the batteries.***

- 1 Move the machine to the tank draining area, and completely empty the collection tank.
- 2 Move the machine to a flat, dry floor, if possible with a power socket nearby.
- 3 Lift up and remove the collection tank.
- 4 With the battery charger disconnected from the mains supply, measure the voltage of the batteries.
- 5 Now plug the battery charger into the mains power socket and check that the voltage read by the multimeter starts to rise compared to that read from the batteries.

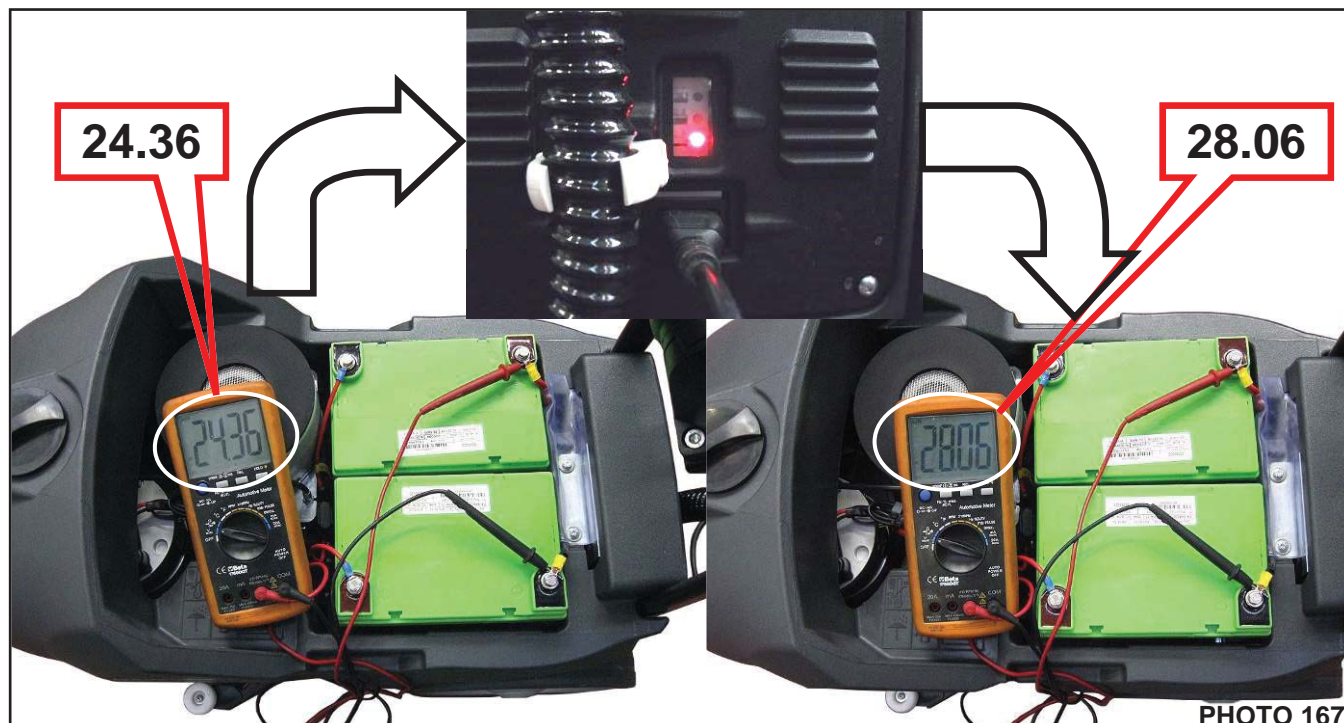



PLDC04626

REVISION 00

March 11, 2022

TECHNICAL DEPT.

Stavale

9 If the battery charger passes both the above tests, replace the batteries with identical new ones.

 ***It is important to replace the batteries with identical ones, as the charging curve of the battery charger is designed for the specific type of battery fitted to the machine.***

10 If the battery charger fails either or both of the above tests, proceed as instructed below to replace it.

Disassembly

11 Move the machine to a flat, dry floor. For convenience, use a fork lift if one is available.

12 Disconnect the suction tube **A** and arrange safely it under the machine.

13 Remove the collection tank from the machine if you have not already done so.

14 Remove the four screws **B** and remove the rear cover from the power compartment.



15 Identify the two bolts **C** securing the power unit to the solution tank.

16 Pull the power unit out from the left of the machine to access the battery charger.



- 17 Disconnect the two pin connector **D** to the batteries and the two bullet connectors **E** to the power control card. (This connection disables machine functioning while the batteries are under charge.)
- 18 With the battery charger disconnected, identify the two nuts **F1** and **F2** securing the battery charger to the power unit's mounting plate. Loosen the nut **F1**, without removing it.



- 19 Remove the second nut **F2** and detach the battery charger from the power unit mounting plate.
- 20 Replace the battery charger with a new one, identical to the one just removed.



Reassembly

 **Before fitting the new battery charger, configure it to suit the machine's batteries, as instructed in section D2.2.**

- 1 To fit the new battery charger, repeat the steps for disassembly in reverse order.
- 2 Configure the new battery charging before fitting it to the power unit.
- 3 Connect up the new battery charger correctly. (The connectors are of different types and cannot be misconnected.)
- 4 If the two pin connector **D** does not make proper contact, the red LED on the battery charger flashes when you try to charge the batteries. If the bullet connectors **E** do not make proper contact, the control panel will not light, as the function control card will not receive any power.



PLDC04626

REVISION 00

March 11, 2022

TECHNICAL DEPT.

Stavale

Warnings & Suggestions



A relay inside the battery charger disconnects power to the machine's control system for the duration of the charge cycle, to prevent the machine being switched on or operated. This avoids loads being applied to the batteries, which the charger's electronics could interpret as malfunctions, resulting in the recharge cycle being interrupted. It is obvious therefore that power to the machine's control system depends not only on the presence of the battery charger, but on the correct functioning of this relay.



If the relay malfunctions, it can prevent the machine from being switched on even with the battery charger disconnected from the mains supply. In this case the battery charger will have to be removed and replaced. To carry on using the machine in such circumstances, the battery charger can be temporarily bypassed.

Bypassing the battery charger

- 1 Remove the cover from the power compartment as instructed above.
- 2 Disconnect the two red bullet connectors **E**. There is no need to remove the power unit mounting plate from the solution tank. Also disconnect the two pin connector **D**.
- 3 Move the two connectors **E1** from the battery charger (one male and one female) out of the way. Connect together the other two connectors **E2**. This connects the power control card directly to the batteries. With the machine connected in this way, and with the two pin connector **D** disconnected, the battery charger will be unable to recharge the batteries. Also, if the battery charger is plugged into the mains, the yellow LED will flash to indicate that the batteries are disconnected.



- 4 Replace the malfunctioning battery charger as soon as possible and remove the bypass.

D2.2 Configuring the battery charger

 *The battery charger is configured in the factory to work with the specific type of batteries installed on the machine. If a new battery charger has to be fitted, configure it in the same way as the old one, as instructed below. If the batteries are replaced with batteries of another type, the battery charger will have to be reconfigured to suit the new type of battery, as instructed below.*

 *Sulla macchina sono previsti tre tipi di carica batterie diversi a seconda del tipo di batterie montate in origine e dal paese d'importazione. Sono riconoscibili dal tipo di batteria montate sulla macchina o dall'etichetta presente sul carica batterie o dal connettore per la ricarica delle batterie.*

Disassembly

- 1 If the battery charger is installed in the machine, remove it from the power compartment as instructed above, and take it to the work bench.
- 2 If the battery charger is new and has been obtained as a replacement part, it should be pre-configured for the type of batteries on the machine. The correct configuration should nevertheless be checked. Take the battery charger to the work bench to check or configure it.
- 3 Identify the plastic cap over the hole through which the configuration DIP switches are accessible. The cap is on the same side as the connection cables.
- 4 Lever off the cap with a flat blade screwdriver.





PLDC04626

REVISION 00

March 11, 2022

TECHNICAL DEPT.

Stavale

Battery charger for EXIDE GEL battery

- The battery charger fitted to the machine can be recognised both by the batteries fitted as original equipment and by the label on the side of the battery charger cooling fan. The batteries are labelled with GEL technology and the charger is always labelled with the type of charge: **IUIa – GEL**.

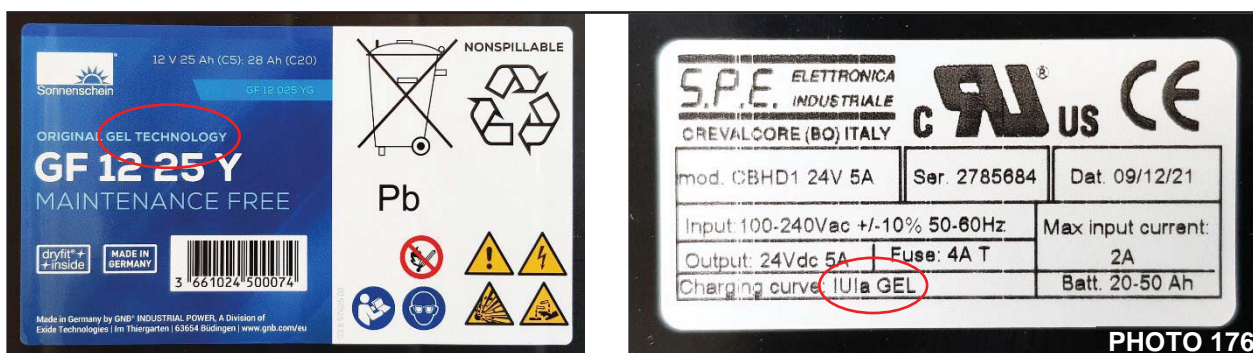

- The charger is naturally set up to charge Exide's GEL batteries, but this model can also be set up to charge Discover's AGM and Acid batteries.
- Identify the two battery charger configuration DIP switches (SW1 – SW2).
 - Only switch **DP1** and **DP2** of the DIP switch **SW2** needs to be checked or changed. For the machine's standard Exide GEL batteries, **DP1** and **DP2** must be set **OFF** (default setting).

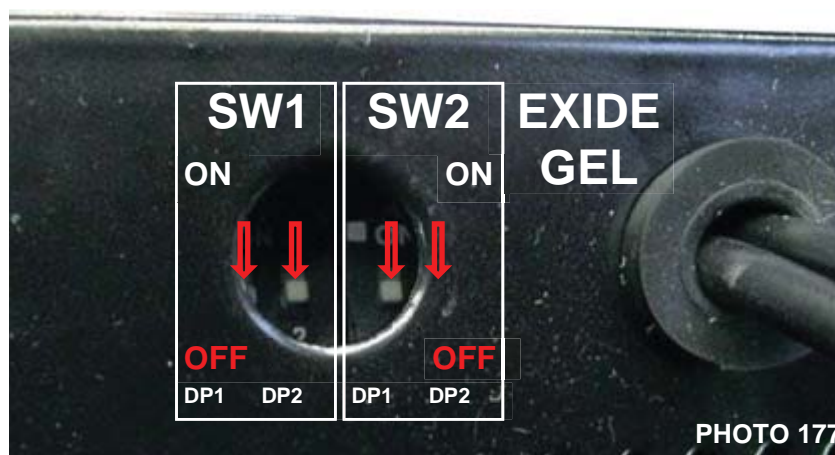



7 The figure below illustrates the settings of both DIP switches SW1 and SW2, with the cap removed. The figure shows the default setting for the CS16.

Default DIP switch settings for the CS16 whit Exide battery

**CS 16
IUIa -GEL
for
Exide
Battery**

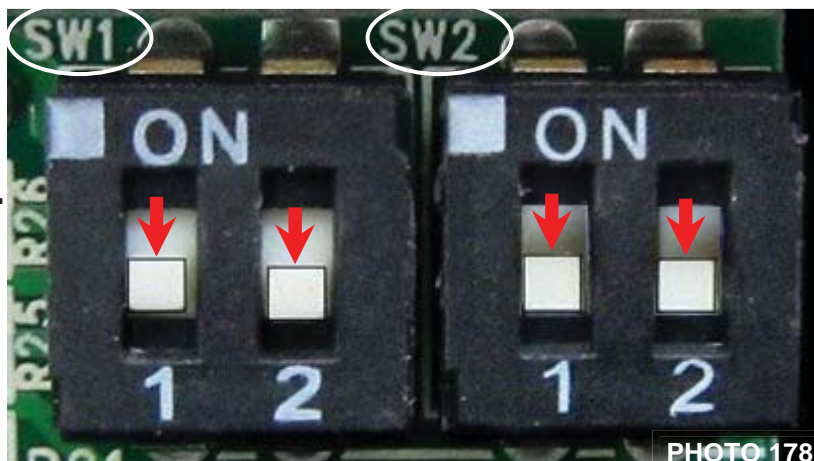

SW1				SW2	
DP1		DP2		DP1	DP2
Charge current		End of charge state		IUIa – GEL for GEL batteries of Exide-Sonnenschein and Haze	
OFF	Maximum charge current 5 A	OFF	Floating charge at 27.6 V	OFF	OFF

8 As explained above, if the machine’s standard batteries are replaced with others of a different type, the battery charger must be reconfigured to suit the new batteries. To do so, proceed as instructed below.

Changing the battery charger DIP switch settings to suit non-standard batteries

SW1				SW2		
DP1		DP2		DP1	DP2	Charging Curve
Charge current		End of charge state				
ON	Half charge current 2.5 A	ON	STOP at end of charging	ON	ON	IUIa – AGM for DISCOVER AGM batteries
				OFF	ON	
OFF	Maximum charge current 5 A	OFF	Floating charge at 27.6 V	ON	OFF	IUIa – ACD for Wet batteries
				OFF	OFF	IUIa – GEL for GEL batteries of Exide-Sonnenschein and Haze



PLDC04626

REVISION 00

March 11, 2022

TECHNICAL DEPT.

Stavale

Battery charger for DISCOVER AGM battery

The battery charger mounted on the machine can be identified both by the batteries mounted as original equipment and by the label on the cable outlet side of the battery charger.

The batteries are labelled with DRY CELL AGM technology and the charger is labelled with the type of charge: IU1a - AGM DISCO.



PHOTO 179

The charger is naturally set up to charge Discover AGM batteries, but it can also be switched to charge generic Gel or AGM batteries.

9 Identify the two battery charger configuration DIP switches (SW1 – SW2).

10 Only switch DP1 and DP2 of the DIP switch SW2 needs to be checked or changed. For the machine's standard Discover AGM batteries, DP1 and DP2 must be set ON (default setting).

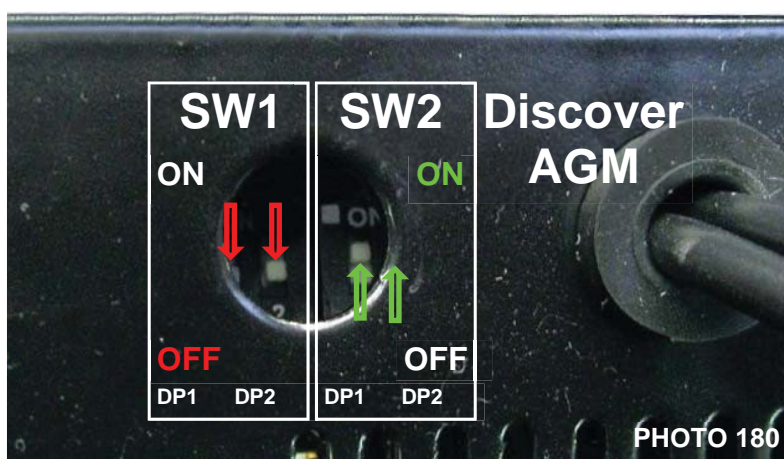

PHOTO 180



11 The figure below illustrates the settings of both DIP switches SW1 and SW2, with the cap removed. The figure shows the default setting for the CS16.

DIP switch settings for the AGM Discover batteries

**CS16
 IU1a
 Discover
 AGM
 batteries**

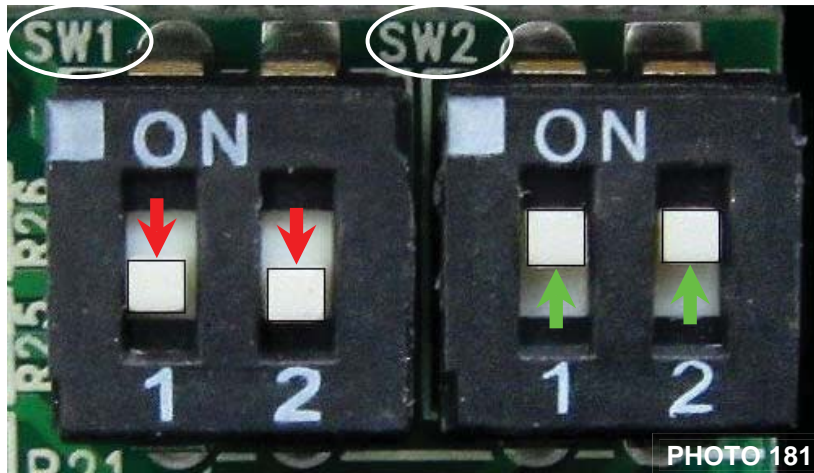

SW1				SW2			
DP1		DP2		DP1		DP2	
Charge current		End of charge state		Charge curve		Battery voltage	
OFF	Maximum charge current 5 A	OFF	Floating charge at 27.6 V	ON	IU1a – AGM specific curve for standard DISCOVER AGM batteries	ON	TCL disabled

12 As explained above, if the machine’s standard batteries are replaced with others of a different type, the battery charger must be reconfigured to suit the new batteries. To do so, proceed as instructed below.

Changing the battery charger DIP switch settings to suit non-standard batteries

SW1				SW2			
DP1		DP2		DP1		DP2	
Charge current		End of charge state		Charge curve		Battery voltage	
ON	Half charge current 2.5 A	ON	STOP at end of charging	ON	IU1a – AGM specific curve for standard DISCOVER AGM batteries	ON	TCL disabled
OFF	Maximum charge current 5 A	OFF	Floating charge at 27.6 V	OFF	IUU0 – GEL for GEL type and generic AGM batteries	OFF	TCL enabled



PLDC04626

REVISION 00

March 11, 2022

TECHNICAL DEPT.

Stavale

Battery charger for DISCOVER AGM battery with SBS mini

The battery charger mounted on the machine is recognizable by the type of connector used for connection to the batteries. The connector used is an Anderson SBS mini with a metal cable clamp. In this case the batteries used are Discover DRY CELL AGM and the charging curve of the charger is IU1a - AGM DISCO, which is specific to the batteries fitted.

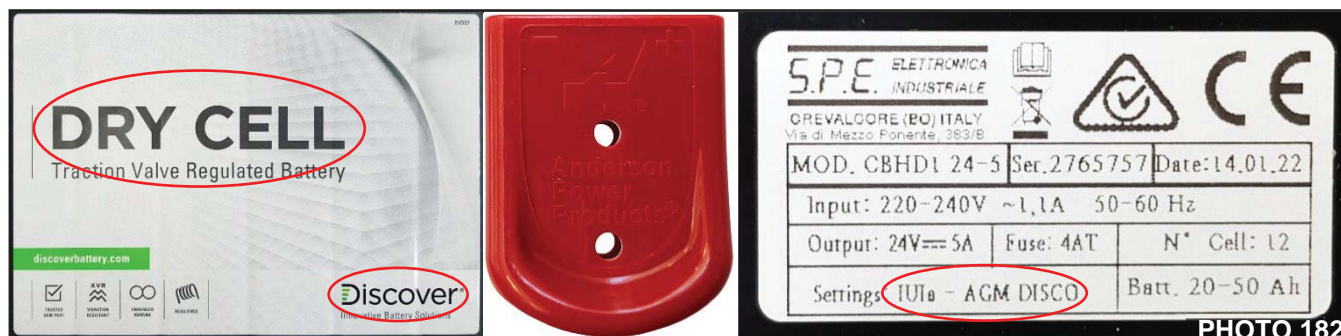

The charger is naturally set up to charge Discover AGM batteries, but it can be switched to charge general Gel or AGM batteries.

13 Identify the two battery charger configuration DIP switches (SW1 – SW2).

14 Only switch DP1 and DP2 of the DIP switch SW2 needs to be checked or changed. For the machine's standard Discover AGM batteries, DP1 and DP2 must be set ON (default setting).

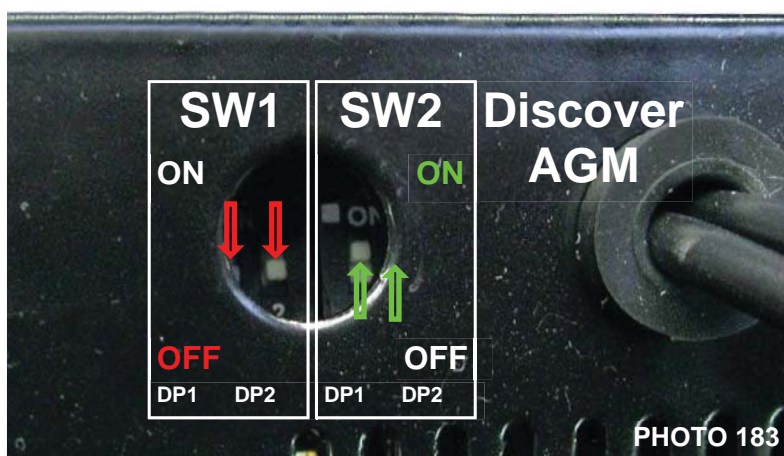



15 The figure below illustrates the settings of both DIP switches SW1 and SW2, with the cap removed. The figure shows the default setting for the CS16.

DIP switch settings for the AGM Discover batteries

**CS16
IU1a
Discover
AGM
batteries**

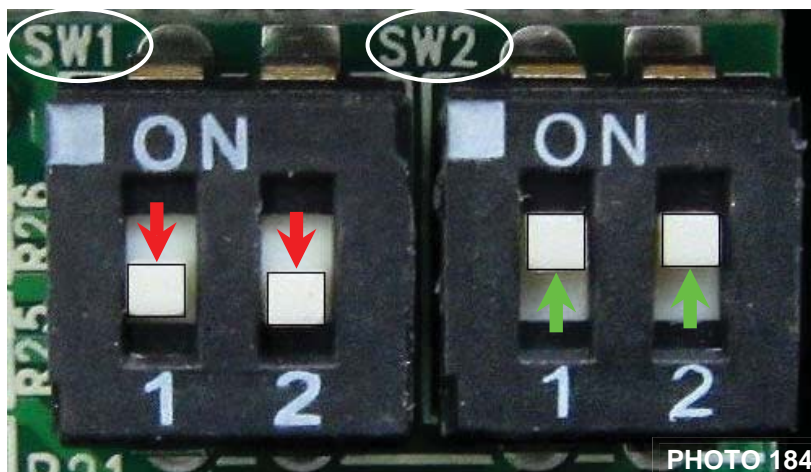

SW1				SW2			
DP1		DP2		DP1		DP2	
Charge current		End of charge state		Charge curve		Battery voltage	
OFF	Maximum charge current 5 A	OFF	Floating charge at 27.6 V	ON	IU1a – AGM specific curve for standard DISCOVER AGM batteries	ON	TCL disabled

16 As explained above, if the machine’s standard batteries are replaced with others of a different type, the battery charger must be reconfigured to suit the new batteries. To do so, proceed as instructed below.

Changing the battery charger DIP switch settings to suit non-standard batteries

SW1				SW2			
DP1		DP2		DP1		DP2	
Charge current		End of charge state		Charge curve		Battery voltage	
ON	Half charge current 2.5 A	ON	STOP at end of charging	ON	IU1a – AGM specific curve for standard DISCOVER AGM batteries	ON	TCL disabled
OFF	Maximum charge current 5 A	OFF	Floating charge at 27.6 V	OFF	IUU0 – GEL for GEL type and generic AGM batteries	OFF	TCL enabled



PLDC04626

REVISION 00

March 11, 2022

TECHNICAL DEPT.

Stavale

- 17 The “**Charge current**” setting depends on the capacity of the batteries in Amperes. In the case of the CS16 it is recommended not to change the setting to 5A. A lower charging current (2.5A) would lengthen the charging time too much with the risk of not being able to charge them completely.
- 18 The “**End of charge state**” setting depends on the recommendations issued by the battery manufacturer. If the manufacturer makes no recommendations, set the DIP switch to deliver a trickle charge on completion of charging.
- 19 The “**Charge curve**” setting is the most important of all, as the wrong setting can compromise not only the duration of charging but the life of the batteries too. The type of battery is shown on the battery case. There are three main types of battery: “Pb-Acd” lead-acid, “AGM” sealed acid, and “Gel” with gel-covered plates.
- 20 The battery charger shows the charge curve setting by means of the LEDs on its front panel, every time a charge cycle begins.
- 21 The GREEN LED flashes twice to indicate a setting for gel or AGM batteries.
- 22 The RED LED flashes twice to indicate a setting for Pb-Acd (LEAD-ACID) batteries.

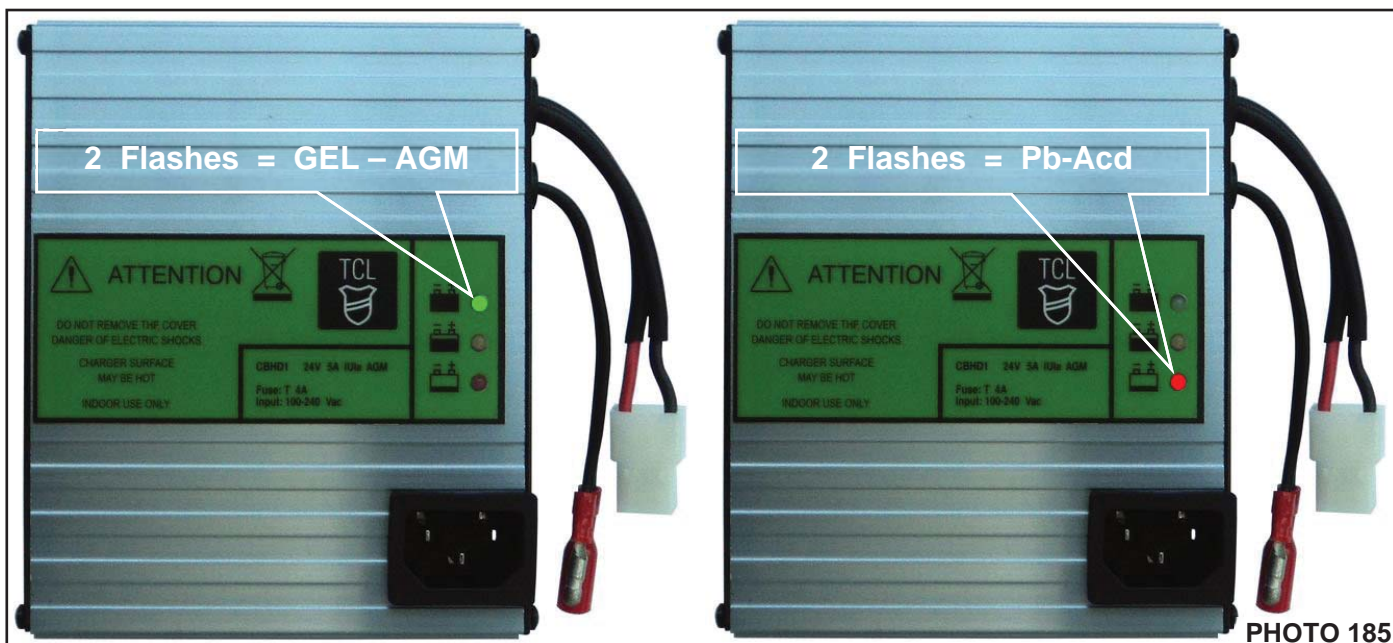
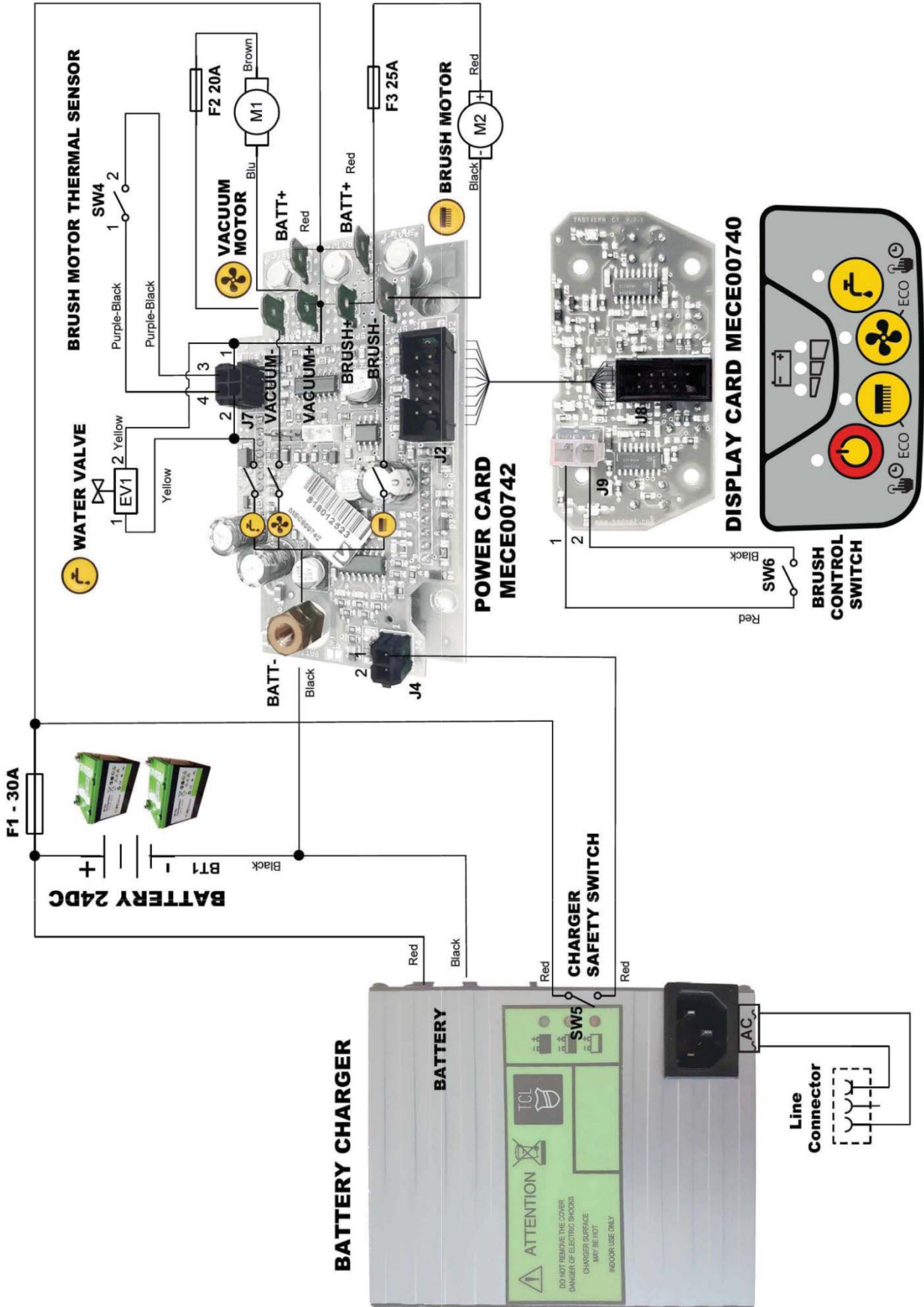

PHOTO 185



D3 D4 ELECTRICAL WIRING DIAGRAMS

D3.1 Electrical wiring diagram for the type battery version





D3.2 Electrical wiring diagram for the type Cord version

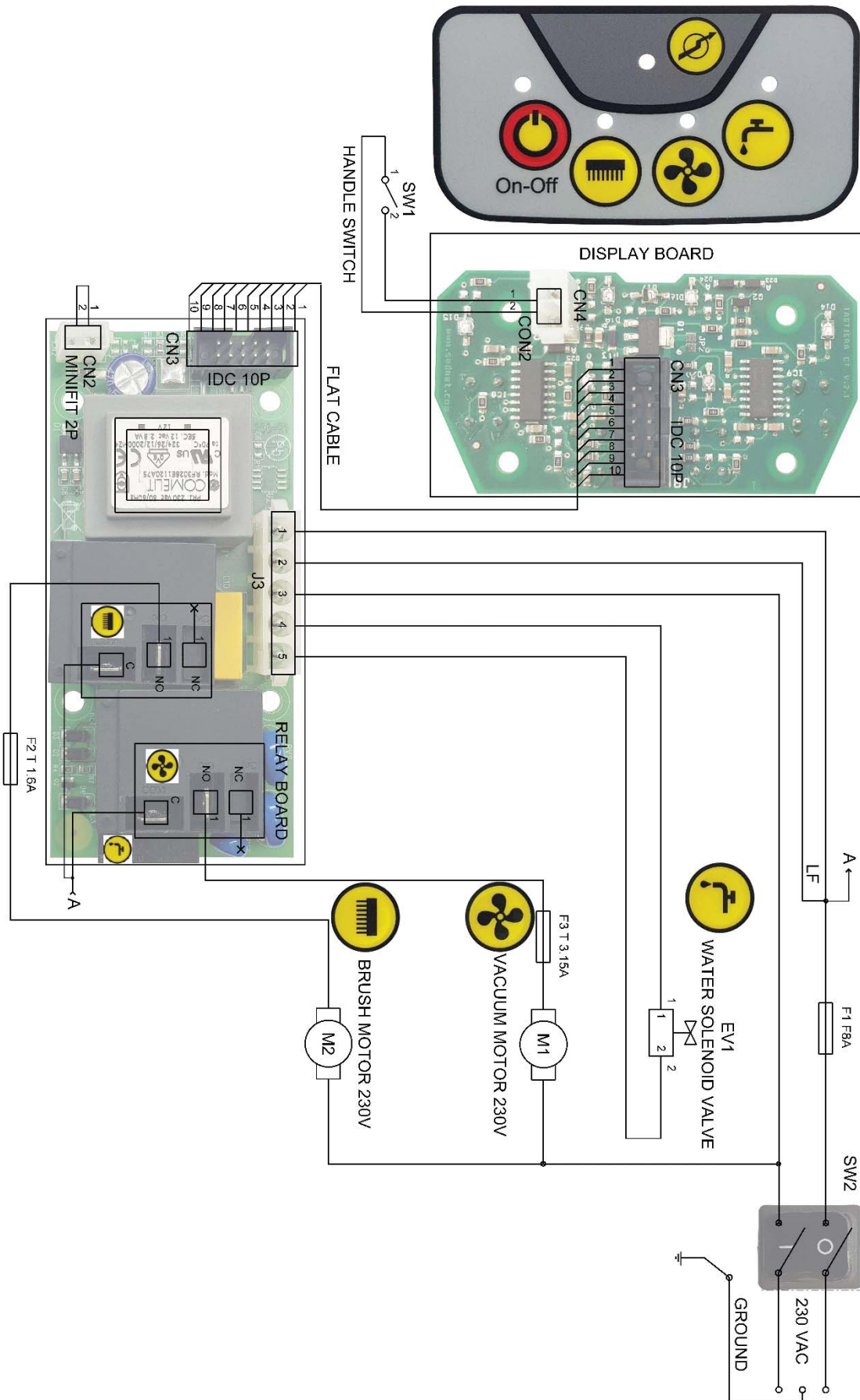



PLDC04626

REVISION 00

March 11, 2022

TECHNICAL DEPT.

Stavale

E

ERROR CODES - TROUBLESHOOTING

👉 WARNING!

Go to the designated draining area and empty the solution and collection tanks using the drain plugs and the hoses provided.

Position the machine on a flat floor, and place wedges under the wheels to stop it moving.

Switch the machine off and disable all functions by pressing the “On–Off” button on the control panel.

Disconnect the machine’s electrical system by removing the main fuse F1, or by disconnecting the terminals from the battery poles (battery powered machines), or by removing the plug from the mains power socket (mains powered machines).

i INFORMATION

Important information

In this Service Manual, the terms **RIGHT** and **LEFT** are used to indicate the sides of the machine. They always refer to the direction of travel.

In this Service Manual, the machine version (**CS16 B** = battery, **CS16 C** = corded) may appear between brackets “()”. This indicates that the instruction in question refers only to the version specified.



E1 DISPLAY OF ERROR CODES

E1.1 Error codes for the function control card on “B” type machines

i In conjunction with the power control card, the function card controls the brush and suction motors and monitors the level of battery charge. Functioning status is shown by the LEDs on the control panel.

i The “On-Off” button needs to be pressed for only 0.1 seconds to switch the machine on, but has to be held down for 4 seconds to switch it off. When the machine is switched on, the function control card performs a self-test of all functions. The self-test lasts for 1.7 seconds. During this period, all function LEDs (brush, suction, solution dispensing solenoid valve) remain lit.

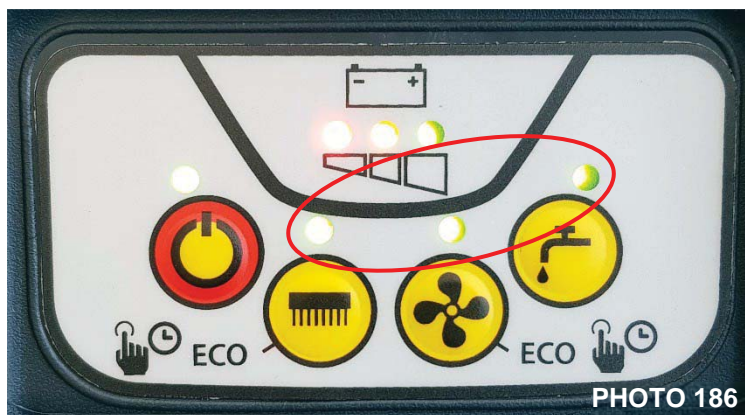

BATTERY CHARGE STATE:

LEDs	LED state	Battery voltage
Red LED + Yellow LED + Green LED	Fixed light	≥ 23.3 Volts
Red LED + Yellow LED	Fixed light	23.3 to 22.5 Volts
Red LED	Fixed light	22.5 to 21.9 Volts
Red LED	Flashing	21.9 to 21.5 Volts
—	Off	21.5 to 21.4 Volts
—	Off – functions stop after 20 secs.	21.4 to 0 Volts

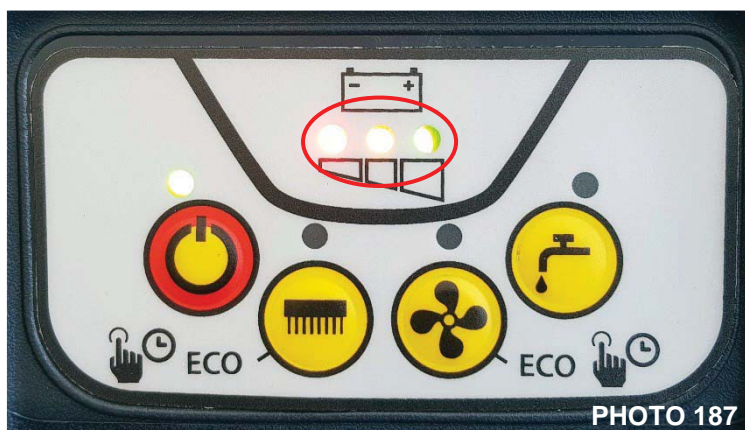



PLDC04626

REVISION 00

March 11, 2022

TECHNICAL DEPT.

Stavale

Brush motor alarms

Brush motor current limit (Amperes) exceeded.



The power control card powers the brush motor via MOS-FETs to provide a soft-start ramp. The card also imposes a current draw limit and cuts out power to the motor if it draws too much current.



If the current draw limit is exceeded (there are actually three thresholds), the power control card disconnects power to the brush motor to shut it down, and warns of this by slowly flashing the brush LED on the control panel.



To restore power to the brush motor and re-start work, simply switch the machine off and back on again using the "On-Off" button.

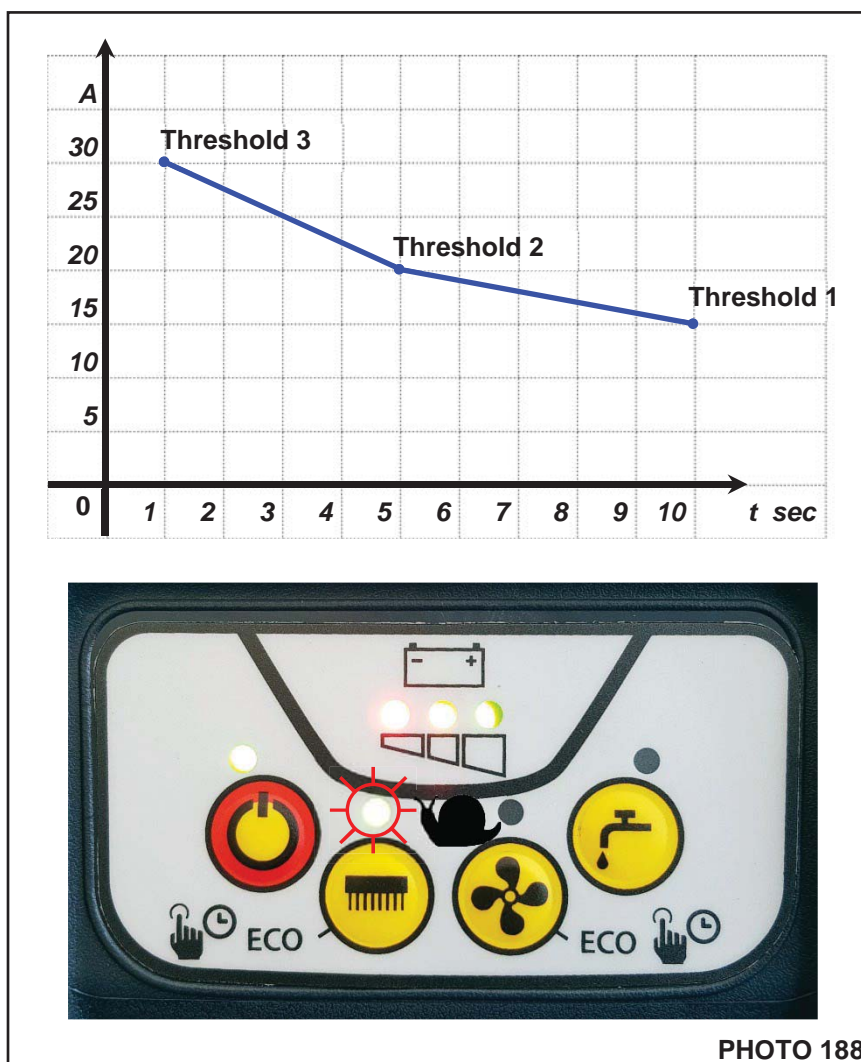



PLDC04626



REVISION 00

March 11, 2022

TECHNICAL DEPT.



Stavale

Brush motor MOS-FET temperature limit exceeded.

-  The power control card also monitors the operating temperature of the MOS-FETs to prevent them burning out. Maximum operating temperature is set at 150° C.
-  If this temperature (150° C) is exceeded, the power control card disconnects power to the brush motor and warns of this by rapidly flashing the brush LED on the control panel.
-  To restore power to the brush motor, switch the machine off using the “On-Off” button, wait for the temperature of the MOS-FETs to fall below 150° C, then switch the machine back on using the “On-Off” button.



Brush motor short circuit

-  The power control card checks for short circuits when the brush motor is switched on.
-  If a short circuit is detected when the button is pressed to switch the brush motor on, the power control card locks the functioning of the brush motor and warns of this by flashing the brush LED quickly in series of two flashes.
-  To restore functioning, check to see if the fault lies in the cables to the brush motor, and if it does not, replace the brush motor.





PLDC04626

REVISION 00

March 11, 2022

TECHNICAL DEPT.

Stavale

Brush motor thermal cutout tripped

- i** The power control card monitors the state of the brush motor's thermal cutout.

Important

THE INTERVENTION OF THE THERMAL CUTOUT IS NOT SHOWN ON THE CONTROL PANEL.

- i** If the control panel shows no alarm condition, but the brush motor does not turn after the button has been pressed and the lever pulled in, the brush motor's thermal cutout may have tripped as a result of the motor overheating, or fuse F3 is interrupted.

- i** The thermal cutout resets itself automatically. Simply release the operating lever and wait a few minutes for the temperature of the motor to fall, if it is the fuse that is broken, replace it.

- i** If the motor still does not turn after it has cooled to ambient temperature or just above, bypass the thermal cutout.

Disconnect the thermal cutout by disconnecting its bullet connectors, and connect together the two male and female bullet connectors on the wiring harness. Test the functioning of the motor.



- i** If the brush motor functions normally at ambient temperature with the thermal cutout bypassed, replace the thermal cutout as instructed in section A2.4.



PLDC04626

REVISION 00

March 11, 2022

TECHNICAL DEPT.

Stavale

Functioning of the thermal protector

The thermal protector incorporated in the electric motor prevents it from reaching high temperatures and being irreversibly damaged. Thermal protectors are usually installed on the hottest parts of the motor, near the motor's carbon brushes, or in the cover over the carbon brushes. The thermal protectors installed in the brush motors of IPC scrubber driers may easily encounter operating temperatures between 80° C and 110° C. Thermal protectors operate in much the same way as an NC (Normally Closed) switch. They open when their calibrated temperature is reached and disconnect power (via a relay or contactor or electronic card) to the motor.

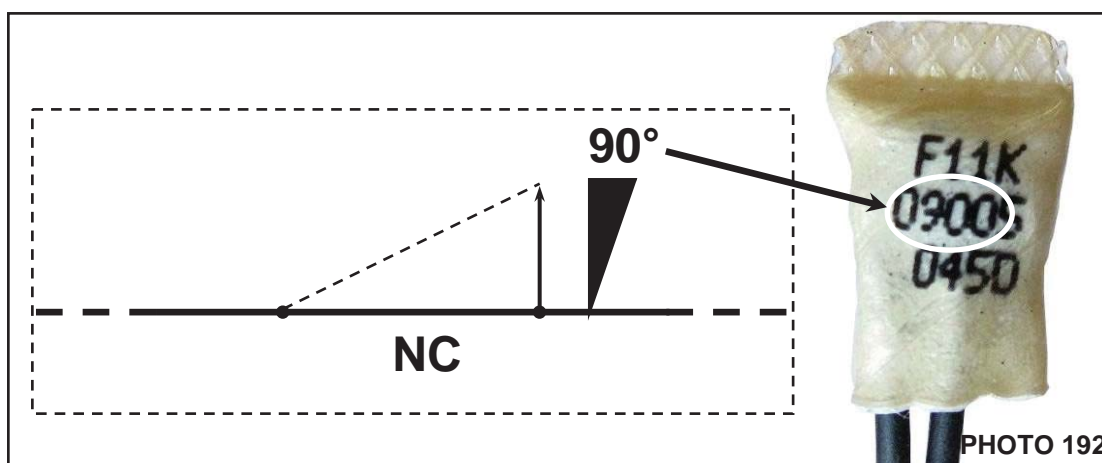



PLDC04626

REVISION 00

March 11, 2022

TECHNICAL DEPT.

Stavale

Suction motor alarms

Suction motor current limit (Amperes) exceeded.



The power control card powers the suction motor via MOS-FETs to provide a soft-start ramp. The card also imposes a current draw limit and cuts out power to the motor if it draws too much current.

Current draw limit = Maximum current draw of 30A for maximum time of 2 seconds.



If the current draw limit is exceeded, the power control card disconnects power to the suction motor to shut it down, and warns of this by slowly flashing the suction LED on the control panel.



To restore power to the suction motor and re-start work, simply switch the machine off and back on again using the "On-Off" button.

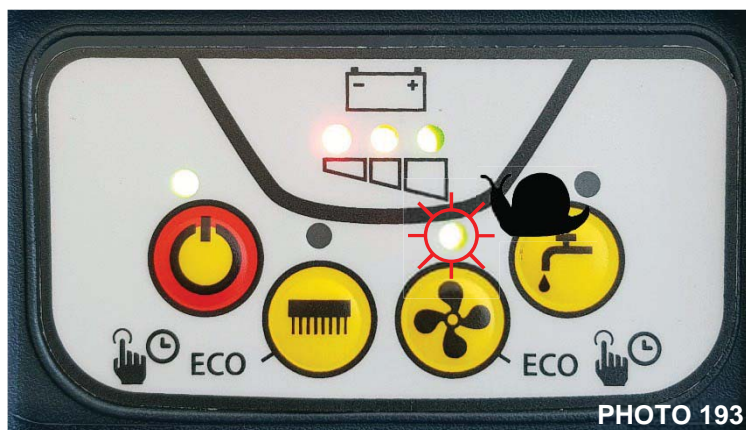

Suction motor MOS-FET temperature limit exceeded.



The power control card also monitors the operating temperature of the MOS-FETs to prevent them burning out. Maximum operating temperature is set at 150° C.



If this temperature (150° C) is exceeded, the power control card disconnects power to the suction motor and warns of this by rapidly flashing the suction LED on the control panel.



To restore power to the suction motor, switch the machine off using the "On-Off" button, wait for the temperature of the MOS-FETs to fall below 150° C, then switch the machine back on using the "On-Off" button.

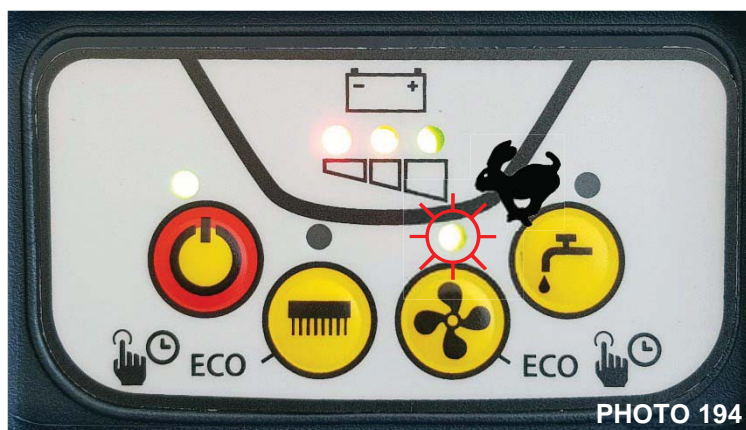



PLDC04626

REVISION 00

March 11, 2022

TECHNICAL DEPT.

Stavale

E2 TROUBLESHOOTING

E2.1 Troubleshooting

E2.1.1 The control panel LEDs do not light

1	Check battery voltage (B type) or the presence of mains power (C type).	A Recharge or replace the batteries (B type). Plug the machine into the mains power supply (C type). B If the batteries are charged or the machine already connected to the mains power supply, go to step 2.
2	Check the main fuse F1 (30 Amps on B type, 8 Amps on C type).	A If the fuse is burnt out, replace it. B If the fuse is intact, go to step 3.
3	Check that the function control card is receiving power from the power control card via the flat cable.	A If the function control card is receiving power correctly, replace it with a new card. B If the function control card is not receiving power, go to step 4.
4	Check the continuity of the flat cable.	A If continuity is broken, repair or replace the flat cable. B If continuity is OK, go to step 5.
5	Check the correct functioning of the power control card (type B or type C).	A If the power control card (type B or type C) is not working, replace it.

E2.1.2 The brush does not rotate on "B" type battery versions

1	Check the voltage of the batteries as shown by the control panel LEDs or as measured at the battery terminals.	A If the batteries are discharged, recharge them or replace them. B If the batteries are charged, go to step 2.
2	Check the 30 Amp main fuse F1 or F3 25A fuse motor brush.	A If the fuse F1 or F3 is burnt out, replace it. B If the fuse is intact, go to step 3.
3	Check the condition and functioning of the thermal protector, and by-pass it if necessary.	A If the thermal protector is defective, replace it. B If the thermal protector is working, go to step 4.
4	Check whether the brush motor functions when connected directly to the batteries.	A If the brush motor does not function, go to step 5. B If the brush motor functions, go to step 6.
5	Check the condition of the motor's carbon brushes.	A If the carbon brushes are worn, replace them. B If the carbon brushes are in good condition, replace the brush motor.
6	Check the continuity of the power cables to the brush motor.	A If continuity is broken in one or more cables, replace the cable or cables concerned. B If continuity is OK, go to step 7.
7	Check the functioning of the power control card.	A If the power control card is not functioning correctly, replace it. B If the power control card is functioning correctly, go to step 8.
8	Check the correct functioning of the function control card.	A If the function control card is not functioning correctly, replace it. B If the function control card is functioning correctly, go to step 9.
9	Check the continuity of the flat cable.	A If continuity is broken, replace the flat cable, B If continuity is OK, replace the power control card and/or function control card.



PLDC04626

REVISION 00

March 11, 2022

TECHNICAL DEPT.

Stavale

E2.1.3 The brush does not rotate on “C” type mains machines

1	Check the LED on the control panel to see whether power is reaching it.	<p>A Plug the machine into the mains power supply.</p> <p>B If the machine is already connected to the mains power supply, go to step 2.</p>
2	Check the 8 Amp main fuse F1 and the 1.6 Amp fuse F2.	<p>A If any fuse is burnt out, replace it.</p> <p>B If the fuses are intact, go to step 3.</p>
3	Check the condition of the motor's carbon brushes.	<p>A If the carbon brushes are worn, replace them.</p> <p>B If the carbon brushes are in good condition, go to step 4.</p>
4	Check the continuity of the power cables to the brush motor.	<p>A If continuity is broken in one or more cables, replace the cable or cables concerned.</p> <p>B If continuity is OK, go to step 5.</p>
5	Check the functioning of the power control card.	<p>A If the power control card is not functioning correctly, replace it.</p> <p>B If the power control card is functioning correctly, go to step 6.</p>
6	Check the correct functioning of the function control card.	<p>A If the function control card is not functioning correctly, replace it.</p> <p>B If the function control card is functioning correctly, go to step 7.</p>
7	Check the continuity of the flat cable.	<p>A If continuity is broken, replace the flat cable,</p> <p>B If continuity is OK, replace the power control card and/or function control card.</p>

E2.1.4 There is no suction

1	Check that the suction hose is correctly connected to the union on the squeegee unit. See section B2.2.	<p>A If the hose is not correctly connected, connect it.</p> <p>B If the hose is correctly connected, go to step 2.</p>
2	Check that suction hose is correctly connected to the collection tank, that the seal is effective and that the hose is in good condition, with no cracks or holes.	<p>A If the hose is not correctly connected, connect it. If the hose is damaged, replace it.</p> <p>B If the hose is correctly connected and in good condition, go to point 3.</p>
3	Check the efficiency of the seal around the cap of the collection tank, especially at the point of contact. See section B3.3.	<p>A If the seal is worn or damaged, or if it fails to mate snugly around the opening, repair or replace the seal.</p> <p>B If the seal is in good condition, go to step 4.</p>
4	Check that the collection tank is seated correctly on the seal of the suction motor and that this seal is in good condition. See sections B1.3, B1.4.	<p>A If the collection tank is not seated correctly, arrange it accordingly.</p> <p>B If the collection tank is correctly seated, go to step 5.</p>
5	Check that the suction motor is functioning correctly. See sections B1.1, B1.2.	<p>A If the suction motor is not functioning correctly, perform the checks in section E2.1.5.</p> <p>B If the suction motor is functioning correctly, check the flaps of the squeegee unit for wear or damage.</p>



PLDC04626

REVISION 00

March 11, 2022

TECHNICAL DEPT.

Stavale

E2.1.5 The suction motor is not working on “B” type battery powered machines

1	Check the voltage of the batteries as shown at the control panel LEDs or as measured at the battery terminals.	A If the batteries are discharged, recharge them or replace them. B If the batteries are charged, go to step 2.
2	Check the 30 Amp main fuse F1 or F2 20A for vacuum motor.	A If the fuse F1 or F2 is burnt out, replace it. B If the fuse is intact, go to step 3.
3	Check whether the suction motor functions when connected directly to the batteries.	A If the suction motor does not function, go to step 4. B If the suction motor functions, go to step 5.
4	Check the condition of the motor's carbon.	A If the carbon brushes are worn, replace them. B If the carbon brushes are in good condition, replace the suction motor.
5	Check the continuity of the power cables to the suction motor.	A If continuity is broken in one or more cables, replace the cable or cables concerned. B If continuity is OK, go to step 6.
6	Check the functioning of the power control card.	A If the power control card is not functioning correctly, replace it. B If the power control card is functioning, go to step 7.
7	Check the correct functioning of the function control card.	A If the function control card is not functioning correctly, replace it. See section D1.1. B If the function control card is functioning correctly, go to step 8.
8	Check the continuity of the flat cable.	A If continuity is broken, replace the flat cable, B If continuity is OK, replace the power control card and/or function control card.

E2.1.6 The suction motor is not working on “C” type mains powered machines

1	Check the LED on the control panel to see whether power is reaching it.	A If no power is present, plug the machine into the mains power supply. B If the machine is already connected to the mains power supply, go to step 2.
2	Check the 8 Amp main fuse F1 or F3 3,15A for vacuum motor.	A If the fuse F1 or F3 is burnt out, replace it. B If the fuse is intact, go to step 3.
3	Check the condition of the motor's carbon brushes.	A If the carbon brushes are worn, replace them. B If the carbon brushes are in good condition, go to step 4.
4	Check the continuity of the power cables to the suction motor.	A If continuity is broken in one or more cables, replace the cable or cables concerned. B If continuity is OK, go to step 5.
5	Check the functioning of the power control card.	A If the power control card is not functioning, replace it. B If the power control card are functioning, go to step 6.
6	Check the correct functioning of the function control card.	A If the function control card is not functioning correctly, replace it. B If the function control card is functioning correctly, go to step 7.
7	Check the continuity of the flat cable.	A If continuity is broken, replace the flat cable, B If continuity is OK, replace the power control card and/or function control card.



PLDC04626

REVISION 00

March 11, 2022

TECHNICAL DEPT.

Stavale

E2.1.7 Solution is not being dispensed

1	Check that there is solution in the solution tank.	<p>A If the solution tank is empty, fill it.</p> <p>B If the solution tank is full, go to step 2.</p>
2	Check that the dispensing cock under the solution tank is fully open.	<p>A If the dispensing cock is closed, open it fully.</p> <p>B If the dispensing cock is already open, go to step 3.</p>
3	Disconnect the clear hose from the dispensing cock under the solution tank and check that solution comes out.	<p>A If no solution comes out, clean the dispensing cock and the solution tank.</p> <p>B If solution comes out, go to step 4.</p>
4	Check that the solution filter is clean.	<p>A If the filter is dirty, clean it.</p> <p>B If the filter is clean, go to step 5.</p>
5	Check that the solenoid valve is clean.	<p>A If the solenoid valve is dirty, clean it.</p> <p>B If the solenoid valve is clean, go to point 6.</p>
6	Check that the solenoid valve is functioning correctly.	<p>A If the solenoid valve is not functioning correctly, replace it.</p> <p>If the solenoid valve is functioning correctly, clean out all hoses between the solution tank and the squeegee unit.</p> <p>B Check the continuity of the power cables to the solenoid valve.</p>



PLDC04626

REVISION 00

March 11, 2022

TECHNICAL DEPT.

Stavale

EDITIONS - UPDATES TECHNICAL SERVICE MANUAL

<i>EDITION No.</i>	<i>DATE</i>
<i>Edition 00.</i> 1 Approval and publication of manual in English.	<i>11/03/2022</i>
<i>Edition 0X.</i> 1	<i>00/00/0000</i>
<i>Edition 0X.</i> 1	<i>00/00/0000</i>
<i>Edition 0X.</i>	<i>00/00/0000</i>