



i-mop[®] Lite Charger



User manual

Model part No. : 1263273

Tennant Company

10400 Clean Street, Eden Prairie,
MN 55344-2650
Telephone: (800) 553-8033
Internet: www.tennantco.com

To view, print, download the parts manual visit:
www.tennantco.com/manuals



Revision: 00 (08/2022)

THANK YOU FOR PURCHASING THE i-mop® Lite CHARGER

Please read the important safety information and user instructions in this manual carefully before using the charger for the first time. This manual contains important information. Please keep it safe for future reference.

CONTENTS

- P. 02 Product description
- P. 02 Function
- P. 02 Image of device label
- P. 03 Safety instructions
- P. 04 Health hazards
- P. 04 First aid
- P. 04 Contents
- P. 04 Voltage specification
- P. 05 Initial setup
- P. 06 Technical data and service
- P. 06 Environment
- P. 06 Warranty
- P. 06 Troubleshooting

PRODUCT DESCRIPTION

Product identification
Product name: Charger
Model number: FY2105000 (1263273)



IMAGE OF DEVICE LABEL

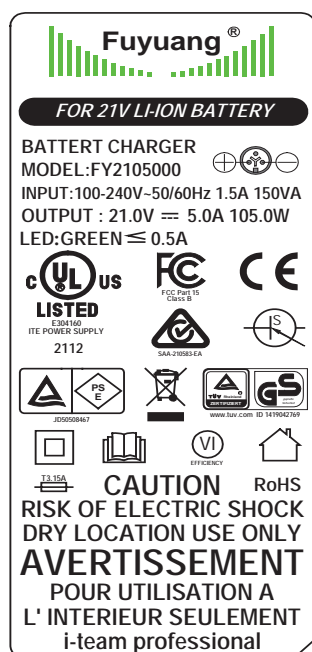

FUNCTION

This charging device is intended for use as a charger for i-mop® Lite Li-ion batteries only.

Battery specifications:

Battery operation: Lithium-ion
Rated capacity: 12.48Ah Quantity: 1x

SAFETY INSTRUCTIONS

Your safety and the safety of others is important. Safe operation of this charger is an important responsibility. In addition to the information in this operating manual, you must also comply with all statutory safety and accident prevention regulations.

Do not use the charger:

- Before you have read and understood this operating manual.
- Around flammable dusts, liquids or vapors.
- Around flammable liquids such as gasoline, oil, acids or other volatile substances.
- Outdoors or in a potentially explosive atmosphere.
- If it is dirty or wet.
- Over plug sockets, to prevent electric shock.
- If any parts are damaged or have been removed.
- If you are under 18.



DANGER

Flammable materials may cause an explosion or fire.



WARNING

Flammable materials may cause an explosion or fire.



CAUTION!

- Only charge original imop Lite lithium-ion batteries-other batteries may explode, causing personal injury and property damage.
- Inspect the power cable regularly for signs of damage.
- Do not use the charger in an enclosed cabinet. Use only in a ventilated room.
- Do not use the charger if it is damaged.
- If the charger power cable is damaged, it must be replaced by a charger power cable supplied by the manufacturer.
- Protect the charger against moisture and keep it in a dry place.
- The charger is suitable for indoor use only. Do not use outdoors.
- Do not use the charger if it is wet.
- Do not expose the charger to rain.
- Only charge the batteries if the temperature is between 5°C~40°C / 41°F~104°F
- Mains voltage must correspond to the voltage specified on the charger name plate.
- Do not use the charger in a potentially explosive atmosphere.
- Do not carry the charger by the power cable.
- Do not touch the power cable or plug in the charger if you have wet hands.
- Do not remove the plug by pulling on the power cable. Hold the plug and not the cable when unplugging it from the socket.
- Do not cover the charger during use.
- Do not open the charger. Repairs should be carried out only by personnel authorized by the manufacturer.
- Do not charge a damaged battery.
- Do not charge batteries if they are wet – batteries may only be charged when dry.
- Do not use the charger to charge non-rechargeable batteries.
- Do not leave batteries connected to the charger. Remove them when they are fully charged.
- Batteries should not be stored or charged in direct sunlight.
- Batteries should not be charged in an unventilated area where the temperature is above 30°C/86°F.



HEALTH HAZARDS

- The chemicals in the batteries are located inside a sealed container.
- They pose a chemical hazard only if batteries are misused or damaged.
- Skin and eye contact with electrolytes and lithium should be avoided.
- Contact with a damaged or leaking battery can result in chemical burns.

FIRST AID

If you come into contact with battery chemicals, do the following:

Eyes

- Flush the eyes with plenty of water for at least 15 minutes, holding the upper and lower eyelids open from time to time.
- Seek medical attention.



Inhalation

- Leave the area in which the contact occurred immediately and seek fresh air. Use oxygen if available.
- Seek medical attention.

Ingestion

- Give the person at least two glasses of milk or water. Induce vomiting if the patient is conscious.
- Seek medical attention.

CONTENTS

1		1x charger
2		1x Battery Charger AC cable UL
3		1x Manual

Ensure that no items are missing and compare contents with the above list. If one of the items listed is missing, contact your imop® Lite dealer.

VOLTAGE SPECIFICATION

- The working range is 12.5~21 Volt (= 0–100%).

To prolong battery life, it is recommended to remove the batteries from the charger when it is not used for more than 2 days.

INITIAL SETUP

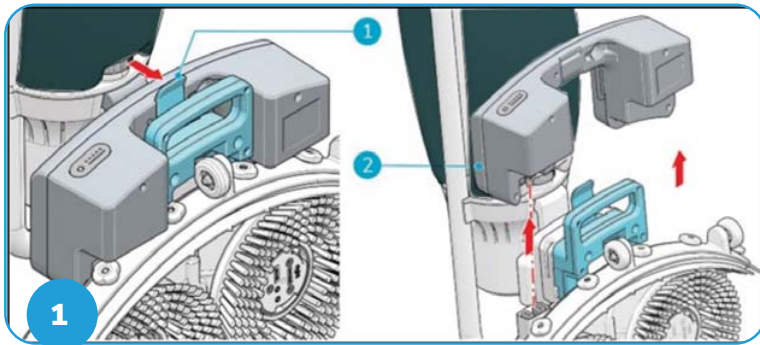

1. Take off the battery of the i-mop® Lite.

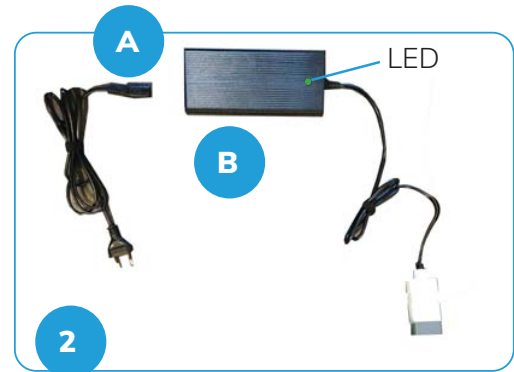

2. Please connect the power cable (A) to the AC Power supply (B) first. Then connect power supply to wall power.

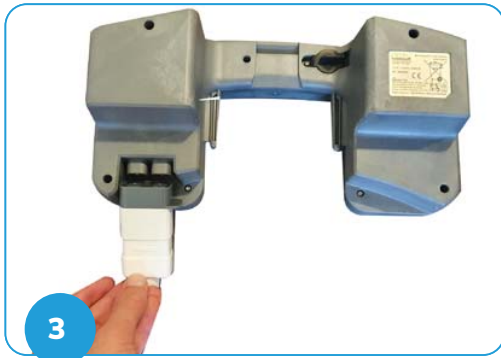

3. Please connect the 2 pin connector to the battery. It will only fit correctly in one direction. (C in figure 4)

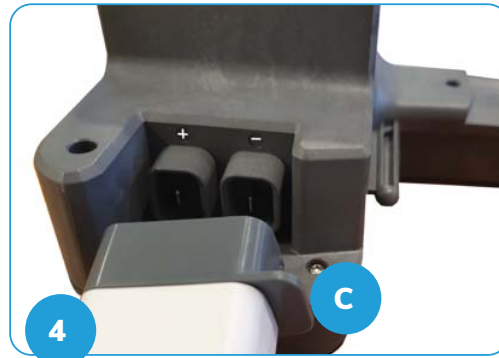

4. Positive (+) and negative (-) are indicated on the battery.



5. Or scan for instruction video

- 1) Connect the power supply to wall power
- 2) A green LED will light to indicate that there is power to the power supply
- 3) Connect the two pin connector to the imop lite battery
- 4) A red LED will light to indicate that the battery is being charged
- 5) When the battery is fully charged, a green led will light.

DISPLAY		
Status	Red LED	Green LED
Standby	Off	On
Charging	On	Off
Bat. Full	Off	On
Fault	FLASH ALTERNATELY	

To charge batteries:

- Universal input: 100~240 50/60 Hz
- Output with short circuit-proof protection function. (In standby mode, the output voltage must be 0 V. This also protects against electric shock when batteries are connected to the charger.)
- The charger is designed to ensure that batteries cannot be inserted with the polarity reversed.
- When the charging current falls below 500 mA, the battery is fully charged. The green LED switches ON.
- If a fully charged battery is left in the charging station for a long period and the battery voltage falls to 20.5 V, the charger will recharge the battery automatically.

NOTE:

BMS (Battery Management System)

- The i-mop® Lite battery includes a built-in BMS for safety
- In the event that the machine experiences overvoltage, the BMS will deactivate battery function for safety.

TECHNICAL DATA

SPECIFICATIONS	METRIC	IMPERIAL
DIMENSIONS (LxWxH)	154x60x36 mm	5.98 x 2.3 x 1.48 inches
INPUT	AC 100~240 V 1.5A MAX 50/60 HZ, CLASS II	AC 100~240 V 1.5A MAX 50/60 HZ, CLASS II
OUTPUT	DC 21.5 A	DC 21.5 A
WEIGHT	0.5 KG	1.1 lbs
PACKAGING DIMENSION (if separately packed) (LxWxH)	180x70x66 mm	7.09 x 2.75 x 2.59 inches

ENVIRONMENT



The packaging material is recyclable. Please do not dispose of it with household waste. Please recycle it. Old appliances contain valuable materials which can be recycled.

Rechargeable battery packs contain materials which should not be disposed of in landfill. Please dispose of old appliances and batteries at the appropriate collection points.

WARRANTY

Please register your i-mop® Lite to ensure that we will repair any faults in your equipment free of charge during the warranty period, provided that such faults are due to defective materials or manufacturing defects. To make a warranty claim please contact your dealer or nearest authorized customer service center. Please provide proof of purchase. Please refer to the Tennant warranty information card for details.

TROUBLESHOOTING

PROBLEMS	SOLUTIONS
The battery will not charge.	<ol style="list-style-type: none">1. Check all cables and the polarity of the connection.2. Ensure the charger is plugged in to the wall.
The red led flashes after 8 hours.	Disconnect the battery from the charger.