

DC Electronic Load

PEL-3000(H) Series

USER MANUAL

VERSION: 2.00



ISO-9001 CERTIFIED MANUFACTURER

GW INSTEK

This manual contains proprietary information, which is protected by copyright. All rights are reserved. No part of this manual may be photocopied, reproduced or translated to another language without prior written consent of Good Will company.

The information in this manual was correct at the time of printing. However, Good Will continues to improve products and reserves the rights to change specification, equipment, and maintenance procedures at any time without notice.

Good Will Instrument Co., Ltd.
No. 7-1, Jhongsing Rd., Tucheng Dist., New Taipei City 236, Taiwan.

Table of Contents

SAFETY INSTRUCTIONS	3
GETTING STARTED	7
PEL-3000(H) Series Introduction	9
Accessories.....	11
Appearance.....	14
First Time Use Instructions	25
OPERATION	51
Basic Operation	54
Basic Configuration	66
Advanced Configuration Settings	73
Step Resolution Configuration	80
Protection Settings	83
System Settings	92
Go-NoGo	97
Save Recall	100
FUNCTION MENU	113
Function Menu Overview	114
Program	120
Sequence	128
OCP Test Automation	147
OPP Test Automation	154
BATT Test Automation	160
MPPT.....	169
EXTERNAL CONTROL	182
Analog Control	183
Parallel Operation	204







REMOTE CONTROL	211
Interface Configuration	212
FAQ	234
APPENDIX	236
Replacing the Dust Filter	238
Replace the Clock Battery.....	239
GPIB Installation	240
Ethernet Card Installation	241
PEL-3000(H) Default Settings	242
Frame Control Connector Contacts	245
Operating Mode Description	259
Operating Area	264
PEL-3000 Specifications	271
PEL-3000H Specifications	283
PEL-3000(H) Dimensions	295
Declaration of Conformity.....	298
INDEX	300

S SAFETY INSTRUCTIONS

This chapter contains important safety instructions that you must follow during operation and storage. Read the following before any operation to insure your safety and to keep the instrument in the best possible condition.

Safety Symbols

These safety symbols may appear in this manual or on the instrument.

	WARNING	Warning: Identifies conditions or practices that could result in injury or loss of life.
	CAUTION	Caution: Identifies conditions or practices that could result in damage to the instrument or to other properties.
		DANGER High Voltage
		Attention Refer to the Manual
		Earth (ground) Terminal
		Frame or Chassis Terminal
		Do not dispose electronic equipment as unsorted municipal waste. Please use a separate collection facility or contact the supplier from which this instrument was purchased.

Safety Guidelines

General Guideline



CAUTION

- Do not place any heavy object on the instrument. Note: Only 2 units can be stacked vertically.
- Avoid severe impact or rough handling that leads to damaging the instrument.
- Do not discharge static electricity to the instrument.
- Use only crimped wires, not bare wires, for the terminals.
- Do not block the cooling fan opening.
- Do not disassemble the instrument unless you are qualified.
- The equipment is not for measurements performed for CAT II, III and IV.

(Measurement categories) EN 61010-1:2010 specifies the measurement categories and their requirements as follows.

- Measurement category IV is for measurement performed at the source of low-voltage installation.
- Measurement category III is for measurement performed in the building installation.
- Measurement category II is for measurement performed on the circuits directly connected to the low voltage installation.
- 0 is for measurements performed on circuits not directly connected to Mains.
- Do NOT position the equipment so that it is difficult to disconnect the appliance inlet or the power plug.
- If the equipment is used in a manner not specified by the manufacturer, the protection provided by the equipment may be impaired.

Power Supply	<ul style="list-style-type: none">• AC Input voltage range: 100-120VAC/200-240VAC (90-132VAC/180-250VAC)• Frequency: 47-63Hz• Power: PEL-3021(H): 90VA Max PEL-3041(H): 110VA Max PEL-3111(H): 190VA Max PEL-3211(H): 230VA Max• To avoid electrical shock connect the protective grounding conductor of the AC power cord to an earth ground.• To avoid electric shock, the power cord protective grounding conductor must be connected to ground. No operator serviceable components inside. Do not remove covers. Refer servicing to qualified personnel.
Cleaning	<ul style="list-style-type: none">• Disconnect the power cord before cleaning.• Use a soft cloth dampened in a solution of mild detergent and water. Do not spray any liquid.• Do not use chemicals containing harsh material such as benzene, toluene, xylene, and acetone.
Operation Environment	<ul style="list-style-type: none">• Location: Indoor, no direct sunlight, dust free, almost non-conductive pollution (Note below)• Temperature: 0°C to 40°C• Humidity: 0 to 85% RH• Altitude: <2000m• Overvoltage category II

(Pollution Degree) EN 61010-1:2010 specifies the pollution degrees and their requirements as follows. The instrument falls under degree 2.

Pollution refers to “addition of foreign matter, solid, liquid, or gaseous (ionized gases), that may produce a reduction of dielectric strength or surface resistivity”.

- Pollution degree 1: No pollution or only dry, non-conductive pollution occurs. The pollution has no influence.
- Pollution degree 2: Normally only non-conductive pollution occurs. Occasionally, however, a temporary conductivity caused by condensation must be expected.
- Pollution degree 3: Conductive pollution occurs, or dry, non-conductive pollution occurs which becomes conductive due to condensation which is expected. In such conditions, equipment is normally protected against exposure to direct sunlight, precipitation, and full wind pressure, but neither temperature nor humidity is controlled.

Storage environment

- Location: Indoor
- Temperature: -20°C to 70°C
- Humidity: <90% RH

Disposal



Do not dispose this instrument as unsorted municipal waste. Please use a separate collection facility or contact the supplier from which this instrument was purchased. Please make sure discarded electrical waste is properly recycled to reduce environmental impact.

G E T T I N G S T A R T E D

This chapter provides a brief overview of the PEL-3000(H), the package contents, instructions for first time use and an introduction to the front panel, rear panel and GUI.



PEL-3000(H) Series Introduction	9
Model Line Up	9
Main Features	10
Accessories	11
Package Contents	13
Appearance	14
Front Panel	14
PEL-3021/ PEL-3041	14
PEL-3021H/ PEL-3041H	14
PEL-3111	15
PEL-3111H	15
PEL-3211(H) Booster Pack	15
Rear Panel	19
PEL-3021/ PEL-3041	19
PEL-3021H/ PEL-3041H	19
PEL-3111	20
PEL-3111H	20
PEL-3211 Booster Pack	20

PEL-3211H Booster Pack	21
Display	24
First Time Use Instructions	25
Rack Mount Kits	25
Power Up and Self Test	28
Load Default Settings	28
Setting the Date and Time	29
Load Wiring	29
Load Wire Connections	33
Using the Front Panel Input Terminals	34
Using the Rear Panel Input Terminals	35
Using the Terminal Cover (PEL-011)	36
Using the Terminal Cover (PEL-013)	38
Using the Terminal Cover	40
Using the Monitor Out Cover (Only for PEL-3021H, PEL-3041H, PEL-3111H)	41
Remote Sense	42
Firmware Update	43
Conventions	45
Help Menu	50

PEL-3000(H) Series Introduction

The PEL-3000(H) Series is a family of high performance DC electronic loads positioned to test a wide range of different power sources. The DC electronic loads are fully programmable to simulate anything from basic static loads to complex dynamic loads. With the ability to operate independently or in parallel, the PEL-3000(H) Series is extremely robust and capable of molding to any test environment.

Please note that throughout this manual the term “PEL-3000(H)” refers to any one of the models in the series lineup, unless specifically stated otherwise.

Model Line Up

There are a total of 3 DC electronic load models and 1 booster pack model.

Model	Voltage (DC)	Current	Power
PEL-3021(H)	0V-150V(0V-800V)	35A(8.75A)	175W
PEL-3041(H)	0V-150V(0V-800V)	70A(17.5A)	350W
PEL-3111(H)	0V-150V(0V-800V)	210A(52.5A)	1050W

Booster Model	Voltage (DC)	Current	Power
PEL-3211(H)	0V-150V(0V-800V)	420A(105A)	2100W

Main Features

Performance	<ul style="list-style-type: none">• High slew rates of up to 16A/μS(PEL-3111(H)) for a fast response speed• High capacity when used in parallel: 5250W, 1050A(262.5A) (PEL-3111(H) \times 5)/ 9450W, 1890A(472.5A) (PEL-3111(H) + PEL-3211(H) \times 4)• High resolution - 16 bit
Features	<ul style="list-style-type: none">• 7 operating modes: CC, CV, CR, CP, CC+CV, CR+CV, CP+CV• Independent and parallel operation• Fully programmable with normal and fast sequences• Soft start• Dynamic mode• OCP, OVP and other protection features• Remote sense• Integrated meter• Rack-mountable• Load booster
Interface	<ul style="list-style-type: none">• USB, RS232, LAN(option) and GPIB(option)• External voltage or resistance control• Front panel trigger out BNC• Front panel voltage/current monitoring BNC• Analog external control• Rear panel voltage/current monitoring

Accessories

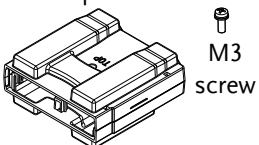
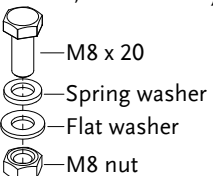
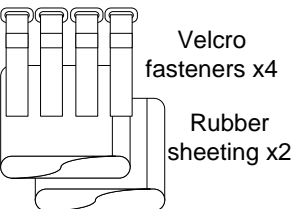
Standard Accessories	Part number	Description
		Quick Start Guide
		User / Programming manual CD
	Region dependent	Power cord
	PEL-011	Load input terminal Cover
		 <p>M3 screw</p>
	PEL-012	Terminal fittings: 2 sets of bolts/nuts/springs/washers (type: M8), Terminal Cover x1 (only for PEL-3000H series), Monitor Out Cover x 1 (only for PEL-3021H, PEL-3041H, PEL-3111H)
		 <p>M8 x 20 Spring washer Flat washer M8 nut</p>
	PEL-013	Flexible terminal cover: 2x rubber sheeting, 4x Velcro fasteners. (For PEL-3211 (H) only)
		 <p>Velcro fasteners x4 Rubber sheeting x2</p>

PEL-014 J1/J2 Protection plug x2 (It is installed on the device)



61SF-062104N1 Front terminal washers
—Spring washer (M6) x2

GTL-255 300mm Frame Link Cable (for linking units that are stacked).Note that this accessories is optional for the PEL-3021 (H)/ 3041 (H).

Optional Accessories	Part number	Description
	3813-030D0501	CR123A 3V lithium battery for clock.
	GRA-413-E	Rack mount bracket for booster PEL-3211 (H) (EIA)
	GRA-413-J	Rack mount bracket for booster PEL-3211 (H) (JIS)
	GRA-414-E	Rack mount frame for PEL-3021 (H), PEL-3041 (H), PEL-3111 (H)/EIA
	GRA-414-J	Rack mount frame for PEL-3021 (H), PEL-3041 (H), PEL-3111 (H)/JIS
	GTL-248	GPIB cable, 2.0m
	GTL-246	USB cable, Type A - Type B
	PEL-010	Dust Filter
	PEL-004	GPIB card
	PEL-005	Connect Cu Plate
	PEL-006	Connect Cu Plate
	PEL-007	Connect Cu Plate
	PEL-008	Connect Cu Plate
	PEL-009	Connect Cu Plate
	PEL-018	LAN card

Package Contents

Check the contents before using the instrument.

Opening the box

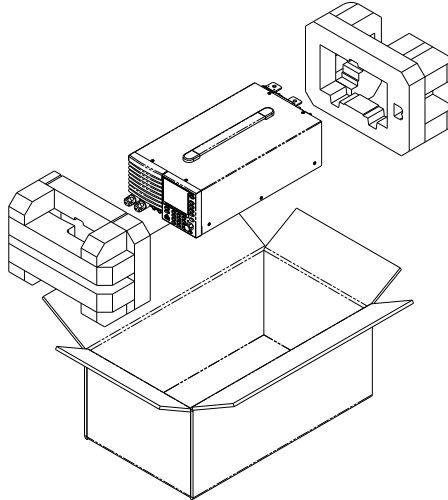

Contents (single unit)

- Main unit
- Quick Start manual
- User / Programming manual CD
- Terminal fittings
- Power cord x1 (region dependent)
- Calibration certificate

Appearance

Front Panel

PEL-3021/ PEL-3041

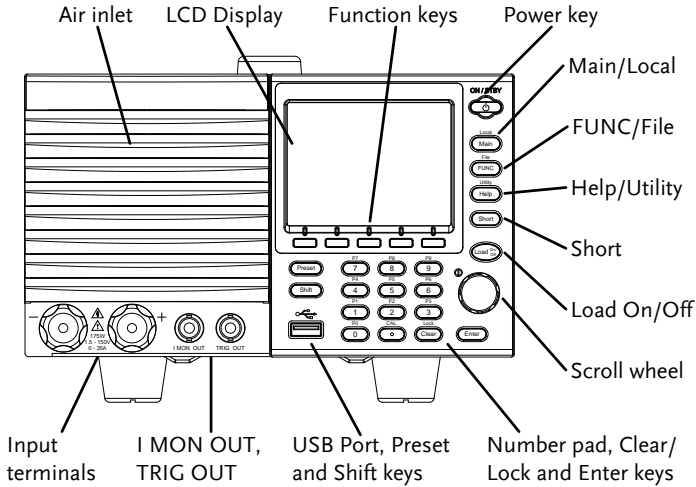

PEL-3021H/ PEL-3041H

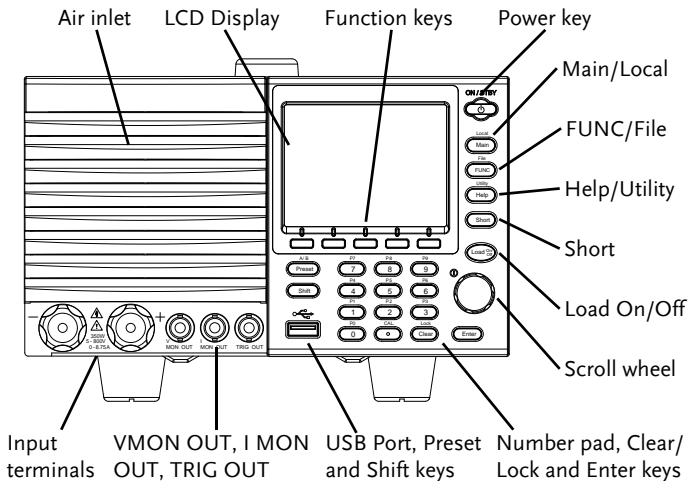

PEL-3111

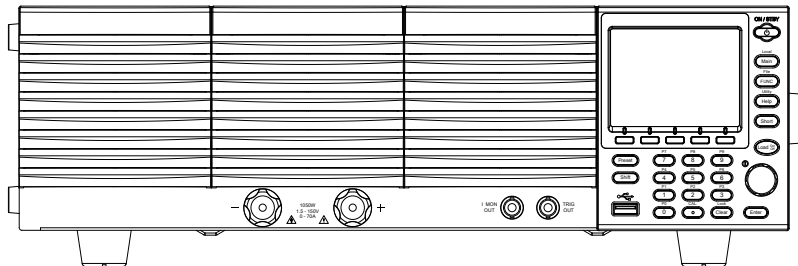

PEL-3111H

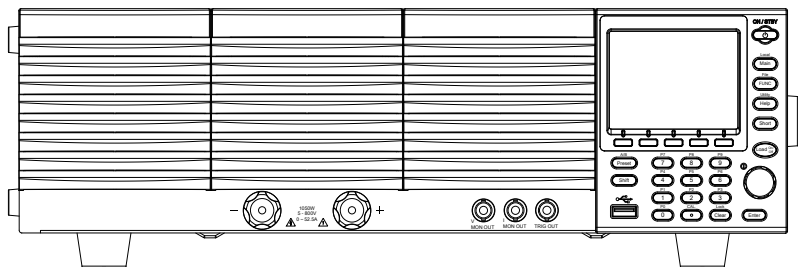

PEL-3211 (H) Booster Pack

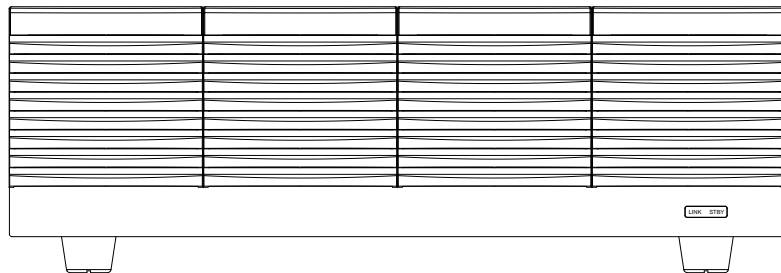

Air Inlet	The air inlet has a removable dust filter
LCD display	3.5 inch LCD display
Function keys	

The function keys directly correspond to the soft menu keys at the bottom of the display.

ON/STBY ON / STBY

 Turns the unit on or puts the unit into standby mode. Use the power switch on the rear panel to turn the unit off.

Main/Local Main

Local (Shift + Main): Puts the instrument back into local mode from remote mode.

Shift + Main

FUNC/File FUNC

File (Shift + FUNC): Accesses the file system.

Shift + FUNC

Help/Utility Help

Utility (Shift + Help): Access the utility menu.

Shift + Help

Short Short

Pressing the Short key will simulate shorting the input terminals.

The Short key will be lit when active.

Load on/off Load ^{On/}Off

Turns the load on or off.

The Load On/Off key will be lit when active.

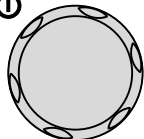
Scroll wheel ① 

Use the scroll wheel to navigate the menu system or to edit parameters. See page 45 for usage details.

Enter  Press the Enter key to select highlighted menu items.

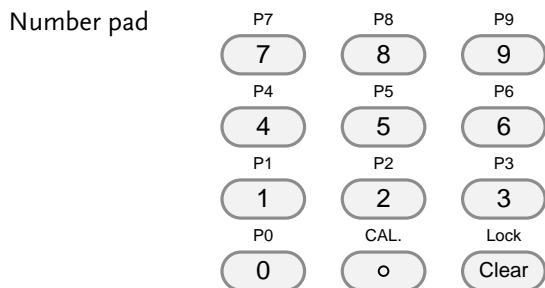



Number pad: Used to enter numerical values.

P0-P9 (Preset + Number keys): Loads one of 10 preset settings.

Clear/Lock  Clear: Clears the current parameter values.

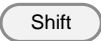
Lock (Shift + Clear): Locks the front panel keys and selector knob.

Shift  Shift: Used in conjunction with other keys to select secondary functions.

Preset  Used in conjunction with the number pad to save or load preset settings P0 to P9.

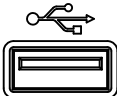
USB Port  USB A port. Used for save and recall functions.

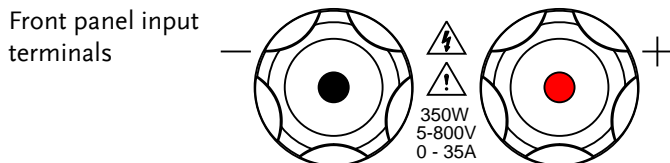

Negative terminal. Positive terminal.

IMON Out



I MON OUT

Current monitor BNC terminal:
Output connector used to monitor the current by outputting a voltage. An output voltage of 1V (10V for PEL-3000H) corresponds to the full scale current for the H and L ranges. 0.1V (1V for PEL-3000H) corresponds to the full scale current in the M range.

VMON Out



V MON OUT

Voltage monitor BNC terminal:
Output connector used to monitor the voltage by outputting a voltage. An output voltage of 8V corresponds to the full scale voltage.

TRIG OUT



TRIG OUT

Trigger out BNC terminal:
Outputs a pulse signal during sequence or dynamic operation. The trigger signal has a 5V output with a pulse width of a least 2 μ s and an impedance of 500 Ω .

LINK/STBY
Indicator
(PEL-3211(H))

LINK STBY

The LINK and STBY indicators indicate when the booster pack is properly connected and when the power has been turned on, respectively.

Rear Panel

PEL-3021/ PEL-3041

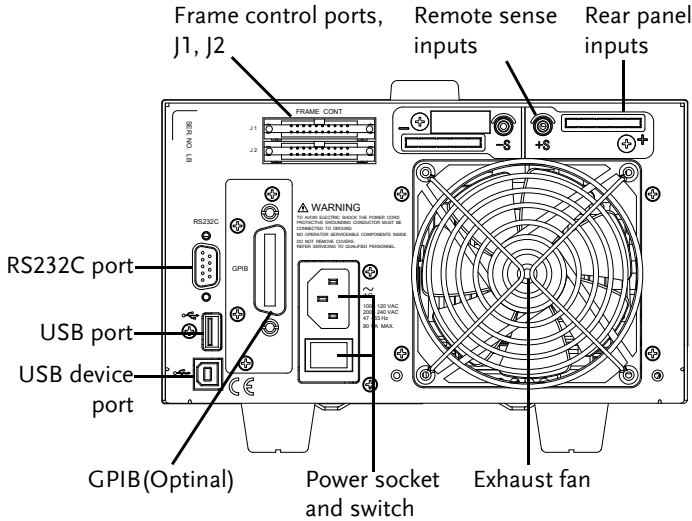

PEL-3021H/ PEL-3041H

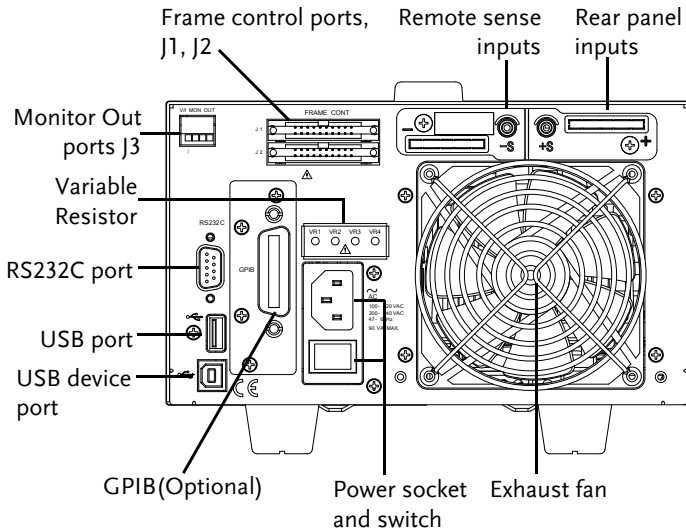

PEL-3111

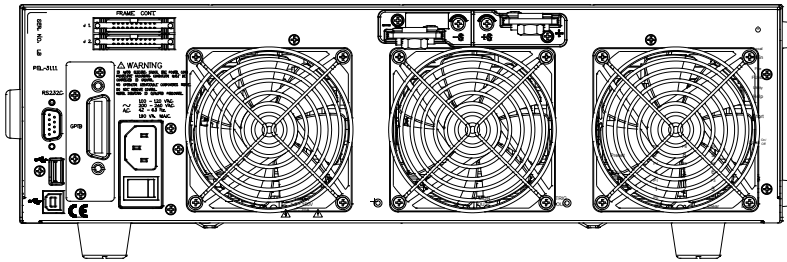

PEL-3111H

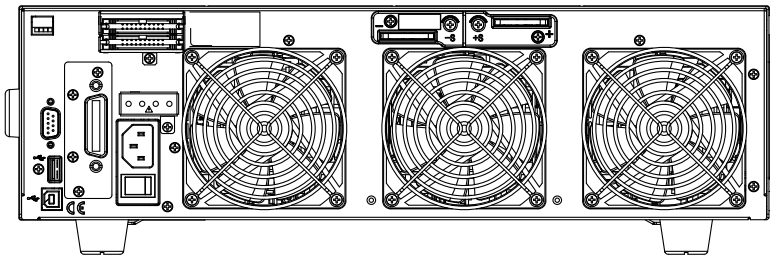

PEL-3211 Booster Pack

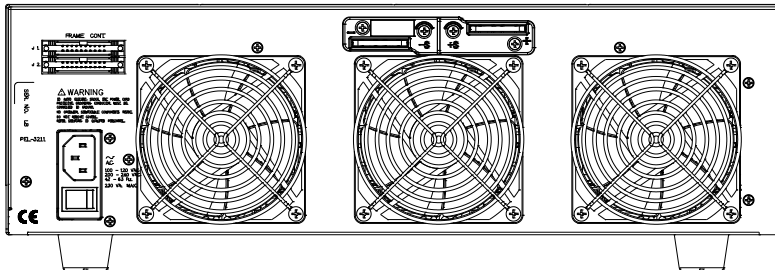

PEL-3211H Booster Pack

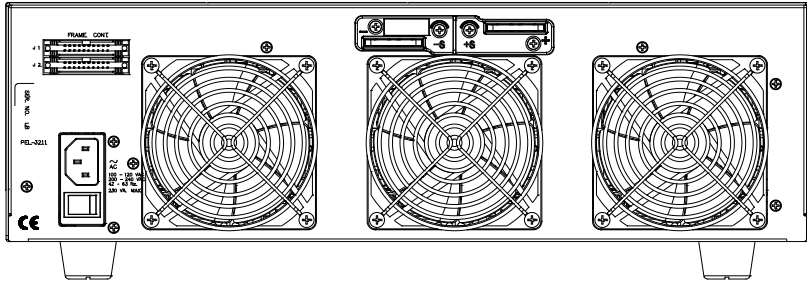

RS232C port

The USB B, RS232C and GPIB port are used for remote control.

GPIB port

USB B port

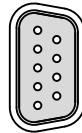
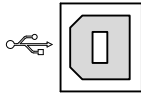

USB B port

RS232C 9 pin DSUB port.

GPIB 24 pin female.

Frame control ports, J1, J2

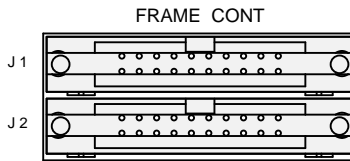

J1: The J1 connector is assigned to external control.

J2: The J2 connector is used for parallel operation control.

Monitor Out
ports J3

EXT.CONT

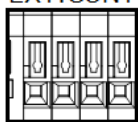

J3: The J3 connector is assigned to current and voltage monitor out.

Variable Resistor

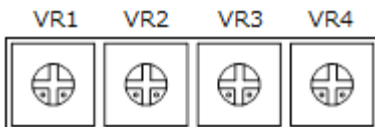

The variable resistors are used to adjust the full scale and offset setting for the input value of the external control sources such as voltage or resistance.

Exhaust fan

The exhaust fan is used to expel the heat from the unit. Please ensure there is at least 20cm distance between any object and the fan.

Rear Panel Input
terminals

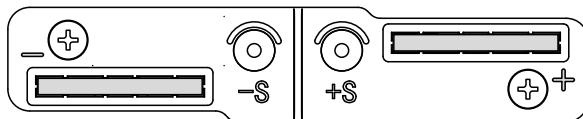

Rear Panel Input Terminals. Electrically connected to the front panel input terminals. Accepts M8 bolts or M4/M3 sized screws. See page 35 for connection details.

Remote Sensing
Terminals

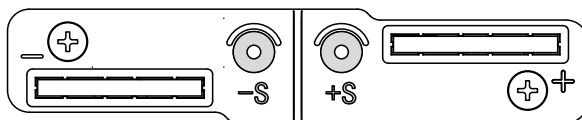

Sensing terminals for remote sense. See page 36.

Accepts M3 sized screws.

Power Socket

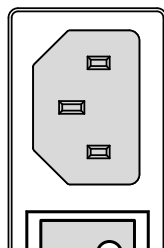

Power Socket:
100-120V, 200-240V
47-63Hz.

Power Switch

Turns the unit on/off.

USB A

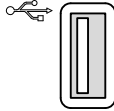

USB A Slave port. USB 1.1/2.0

LAN port



Ethernet port for controlling the PEL-3000(H) remotely.

Display

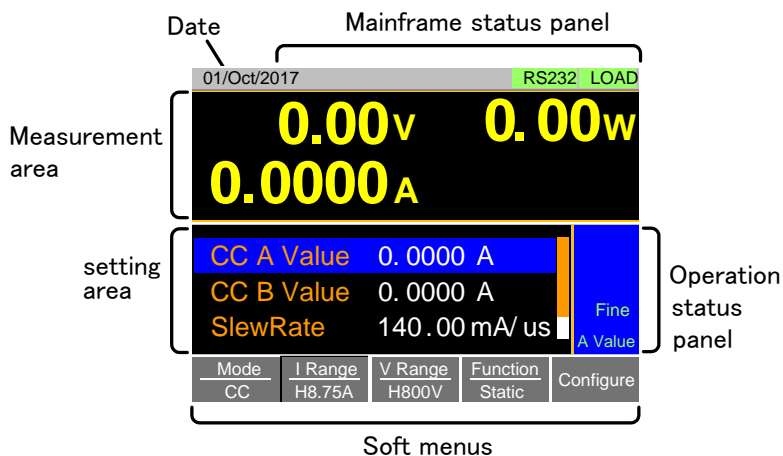

Setting area	The setting area is used to display and edit the settings for the current mode/function.
Measurement area	Displays the voltage, current and power values.
Date	Displays the date.
Mainframe status panel	The mainframe status panel displays the status of the load, remote control and short function. When an icon is green it indicates that the function is off. When the icon is orange, the function is on.
Operation Status Panel	This status panel is used to display the status of the current mode.
Soft-keys	The soft-key menus are used to select different functions or parameters.

First Time Use Instructions

Use the procedures below when first using the PEL-3000(H) to install the rack mount kit, power up the instrument, set the internal clock, restore the factory default settings and check the firmware version. Lastly, the Conventions section will introduce you to the basic operating conventions used throughout the user manual.

Rack Mount Kits

Description The PEL-3000(H) has a number of rack mount options for installation. The GRA-413 rack mounts are suitable for the PEL-3211(H) booster pack. The GRA-414 rack mounts are capable of holding 1x PEL-3111(H) or 2x PEL-3021(H)/3041(H) units.

For installation details, please see the GRA-413 and GRA-414 Rack Mount Assembly Manual.

Please see your distributor for which rack mount is suitable for your application.

GRA-413-E
(EIA standard)

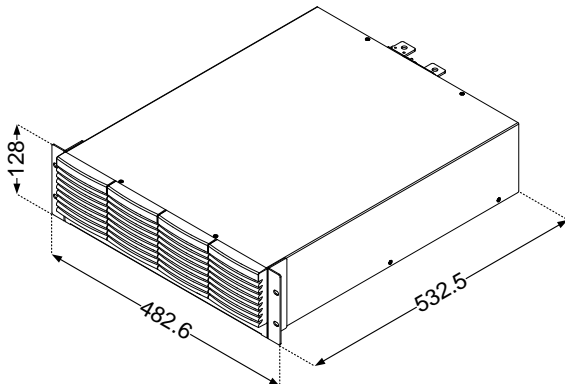
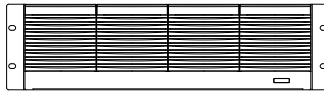

GRA-413-J
(JIS standard)

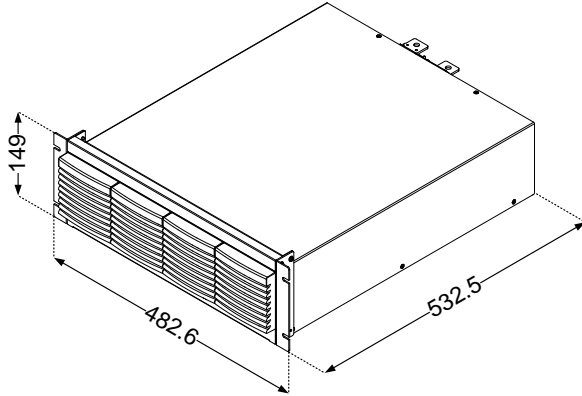
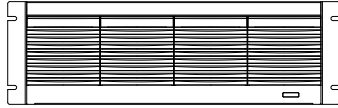

GRA-414-E
(EIA standard)

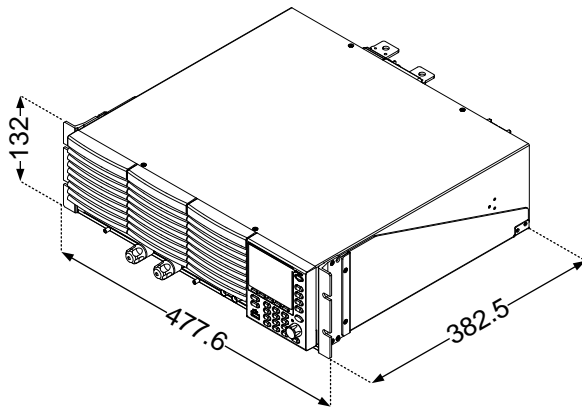
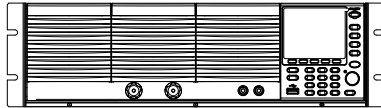

GRA-414-J
(JIS standard)

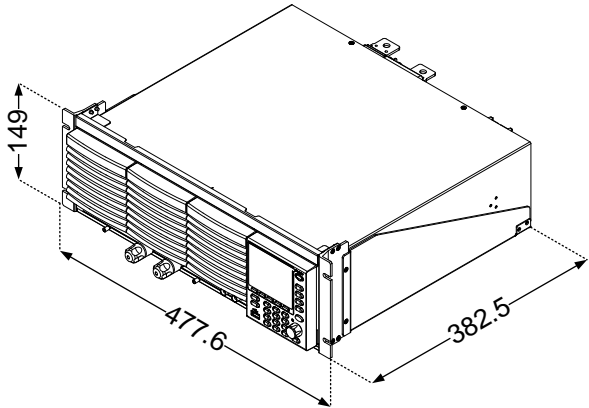
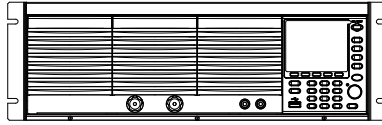

Power Up and Self Test

Steps

1. Insert the AC power cord into the power socket.

Turn the external power switch on.
(O → -)

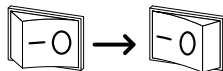

If the unit doesn't turn on, press the On/Standby key.

- The ON/STBY key will go from standby (red) to on (green).

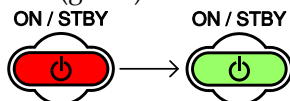

The unit will show the splash screen and then load the settings from when the unit was last powered down.



Note



If the PEL-3000(H) fails to start up properly or does not turn on, please see your local distributor.

Load Default Settings

Description

When first using the PEL-3000(H), recall the factory default settings to ensure the unit is in a known state. See page 241 for a list of the default settings.

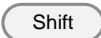
Operation

2. Press  + .
Select *Media/Default*[F1].
Select *Factory Default*[F2].



Setting the Date and Time

Description The date and time settings are used to time-stamp files when saving files.

- The date is shown on top of the display.

Operation

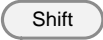
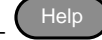
1. Press  +  > *Time Set[F4]* to set the date and time.

Settings: Month, Day, Year, Hour, Minute

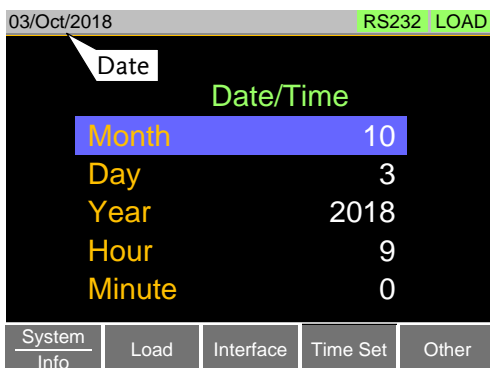

Load Wiring

Wire Gauge considerations

Before connecting the unit to a power source, the wire gauge must be taken into account. Load wires must be large enough to resist overheating when a short-circuit condition occurs as well as to maintain a good regulation. The size, polarity and length of a wire are all factors in determining if a wire will withstand short circuiting.

Wires that are selected must be large enough to withstand a short circuit and limit voltage drops to no more than 2V per wire. Use the table below to help make a suitable selection.

AWG Gauge	Conduct or Diameter mm	Ohms per km	Max amps for chassis wiring
0000	11.684	0.16072	380
000	10.4038	0.2027	328
00	9.26592	0.25551	283
0	8.25246	0.32242	245
1	7.34822	0.40639	211
2	6.54304	0.51266	181
3	5.82676	0.64616	158
4	5.18922	0.81508	135
5	4.62026	1.02762	118
6	4.1148	1.29593	101
7	3.66522	1.6341	89
8	3.2639	2.0605	73
9	2.90576	2.59809	64
10	2.58826	3.27639	55
11	2.30378	4.1328	47
12	2.05232	5.20864	41
13	1.8288	6.56984	35
14	1.62814	8.282	32
15	1.45034	10.44352	28
16	1.29032	13.17248	22
17	1.15062	17.60992	19
18	1.02362	20.9428	16
19	0.91186	26.40728	14
20	0.8126	33.292	11

	21	0.7239	41.984	9
--	----	--------	--------	---

Load Line Inductance Considerations When using the PEL-3000(H) load generator, voltage drop and voltage generated due to load line inductance and current change must be taken into account. Extreme changes in voltage may exceed the minimum or maximum voltage limits. Exceeding the maximum voltage limit may damage the PEL-3000(H).

To determine the voltage generated, the following equation can be used.

$$E = L \times (\Delta I / \Delta T)$$

E= voltage generated
 L=load line inductance
 ΔI = change of current (A)
 ΔT = time (us)

Load line inductance (L) can be approximated as 1uH per 1 meter of wire. ($\Delta I / \Delta T$) is the slew rate in A/us.

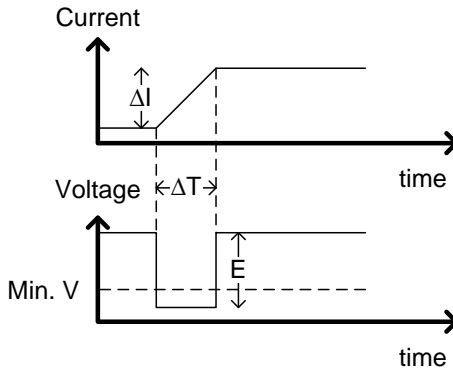

The diagram above shows how changes in current can affect voltage.

- Limiting Load line inductance** Load line inductance can be reduced in two ways.
1. Ensure load wires are as short as possible and twist the positive and negative load wires together.
 2. Current change can be limited by limiting the

slew rate or response speed when switching in CR and CC mode.

“Twisted pair” will be shown on any connection diagram where the load wires should be twisted together.

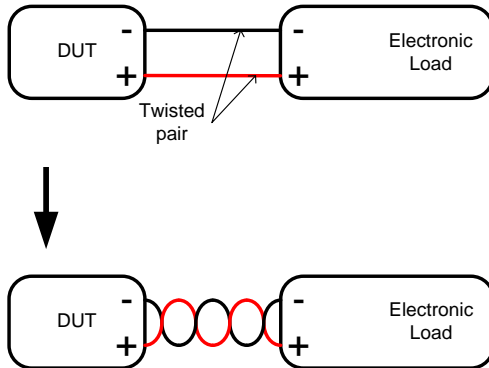

Load Wire Connections

Description The PEL-3000(H) has input terminals on both the front and rear panels.

Follow the procedures below for all load connections. Please adhere to the following precautions to ensure your safety and to protect the unit from damage.

- Connection**
1. When connecting the PEL-3000(H) to the DUT, make sure that the polarity of the connection between the DUT and the unit matches.
 2. Ensure that the maximum input voltage is not exceeded. The maximum input voltage is 150(800) volts.

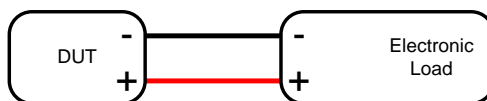

Caution

If the polarity to the input terminals is reversed, the reverse voltage protection function is tripped. The reverse voltage protection function is tripped when reverse voltages greater than -0.3V are detected.

Do not touch any of the input terminals when the voltage is applied to an input terminal.

Connecting the input terminals to the wrong polarity can damage the DUT or the PEL-3000(H).

The front panel and rear panel input terminals are physically connected. Any voltage that is input to one set of terminals will also appear on the other set of terminals.

Using the Front Panel Input Terminals

Description The front panel input terminals feature polarity-distinct caps and accept M6 sized crimped terminals.

 **Caution** The front panel input terminals on the PEL-3000(H) are physically connected to the rear panel terminals.

- Steps**
1. Turn the power off from the rear panel or put the unit into standby mode.
 2. Turn the power off from the DUT.
 3. Connect the load wires to the input terminals:
 - Connect the positive (+) input terminal on the load generator to the high potential output of the DUT.
 - Connect the negative (-) input terminal to the low potential output of the DUT.

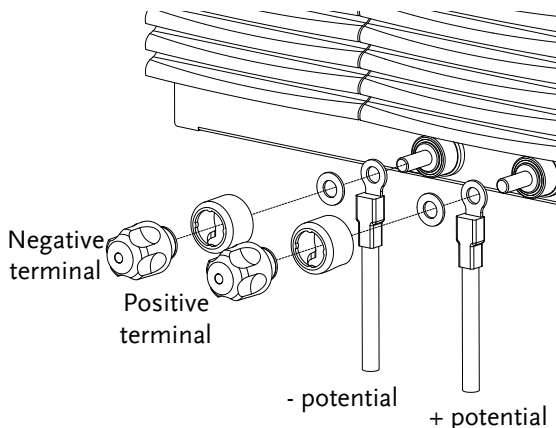

Using the Rear Panel Input Terminals

Description The rear panel input terminals accept up to M8-sized crimped terminals. The rear terminals come with a load input terminal cover for safety.



Caution

The front panel input terminals on the PEL-3000(H) are physically connected to the rear panel terminals.

Steps

1. Turn the power off from the rear panel or put the unit into standby mode.
2. Turn the power off from the DUT.
3. Connect the load wires to the input terminals:
 - Connect the positive (+) input terminal on the load generator to the high potential output of the DUT.
 - Connect the negative (-) input terminal to the low potential output of the DUT.

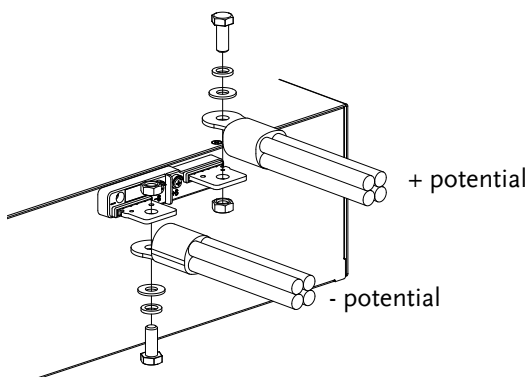

Using the Terminal Cover (PEL-011)

Description The rear panel terminal cover should be used to prevent electric shock. The rear panel terminal covers should always be used when connecting a load to the rear panel terminals. As the front panel and rear panel terminals are physically connected, the terminal cover should also be used as a safety measure when a DUT is connected to the front terminals



Caution

Ensure the power is off before making any connections to the PEL-3000(H).



Note

In the following diagrams, the cable wiring is not shown for clarity.

1. Remove the screw holding the top cover to the bottom cover.

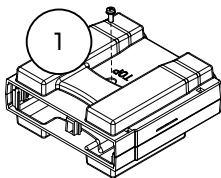

2. Line-up the bottom cover with the notches in the output terminals.
3. Place the top terminal cover over the bottom cover.

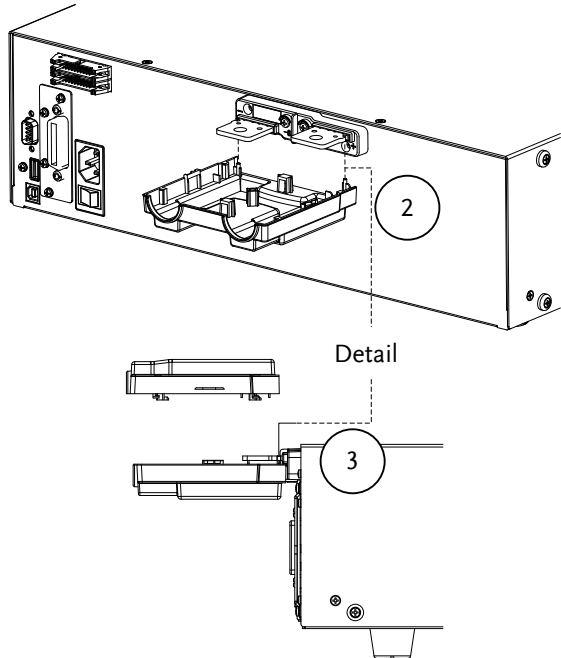

4. Use your thumb to slide the terminal covers shut, as shown in the diagram below.

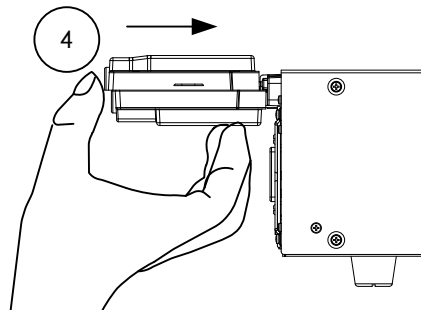

5. When the top and bottom covers are flush, reinsert the screw that was removed in step 1.

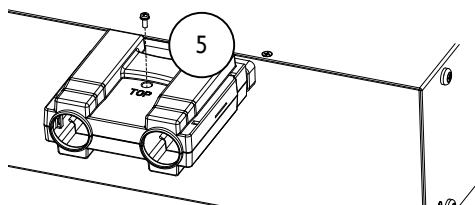

Using the Terminal Cover (PEL-013)

Description The flexible rear panel terminal cover should be used when the load wiring becomes too thick to be used with the PEL-011 terminal cover. This is especially true when using the load generators in parallel. Like the PEL-013 terminal cover, the PEL-011 is used to prevent electric shock. The rear panel terminal covers should always be used when connecting a load to the rear panel terminals.

 **Caution**

Ensure the power is off before making any connections to the booster pack.

6. Wrap the insulation sheets around the terminals and load cables, as shown below. Make sure the terminals and any exposed wires are covered by the sheets.

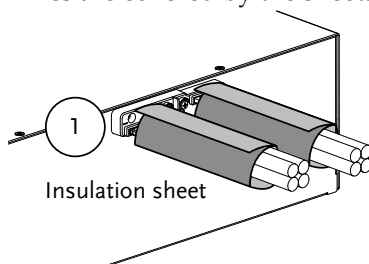

7. Secure the insulation sheets using the supplied velcro fasteners. 2 fasteners should be used for each sheet.

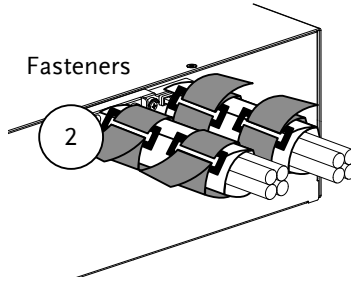

Using the Terminal Cover

Description After connection is finished, please lock terminal cover to avoid electric shock when using the frame control terminal for PEL-3000H series.

If connection is needed, please unlock terminal cover, If connection isn't needed, please lock terminal cover to avoid electric shock for PEL-3000 series.

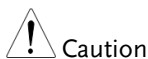

Ensure the power is off before making any connections to the booster pack.

Install the terminal cover as shown in the picture below (for PEL-3000H series).

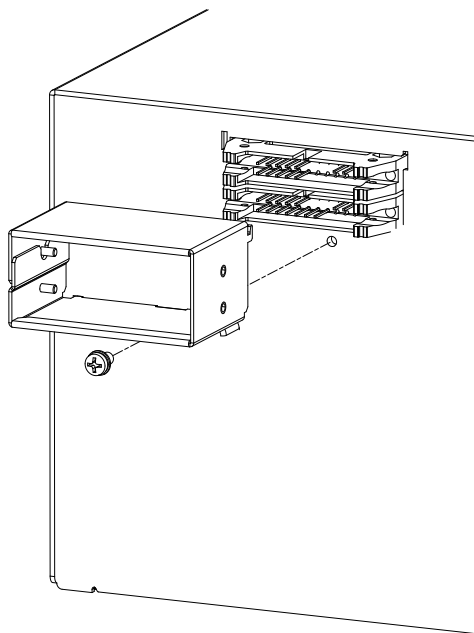

Install the terminal cover as shown in the picture below (for PEL-3000 series).

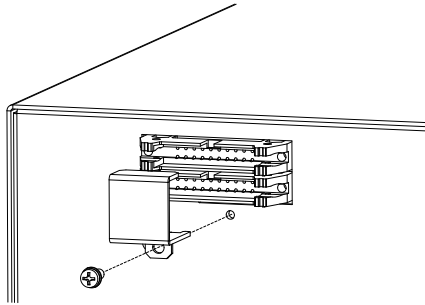

Using the Monitor Out Cover (Only for PEL-3021H, PEL-3041H, PEL-3111H)

Description After connection is finished, please lock monitor out cover to avoid electric shock when using the monitor out ports.

 **Caution**

Ensure the power is off before making any connections to the booster pack.

Install the monitor out cover as shown in the picture below.

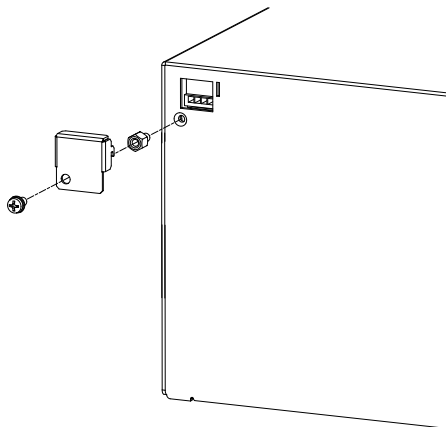

Remote Sense

Description Remote sense can be used to help compensate for long cable length. The longer the cable, the higher the potential resistance and inductance, therefore a short cable is best. Twisting the cable can help reduce induced inductance and using the Vsense terminals compensates the voltage drop seen across the load leads, especially leads with higher resistance. This is useful when used in CV, CR or CP mode.

- Steps**
1. Turn the power off from the rear panel or put the unit into standby mode.
 2. Turn the power off from the DUT.
 3. Connect the sense wires to the sense terminals:
 - Connect the positive sense (+S) terminal to the high potential output of the DUT.
 - Connect the negative sense (-S) terminal to the low potential output of the DUT.

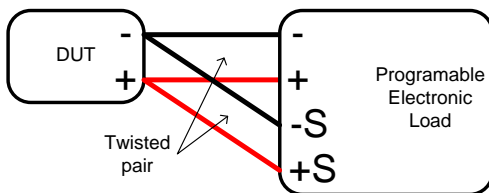



Firmware Update



Description The PEL-3000(H) allows the firmware to be updated by end-users. Before using the PEL-3000(H), please check the GW Instek website or ask your local distributor for the latest firmware.

System version Before updating the firmware, please check the firmware version.

Operation

1. Press  +  .
2. Select System/Info[F1].
3. The System information is listed on the display.
 - Model: PEL-3000(H) model number.
 - Serial Number: XXXXXXXX
 - Firmware Ver.: Firmware version number.
 - Website address.
4. To view other system information, press *System[F1]* and select *Memo*.

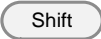

- Update Firmware
1. Insert a USB drive into the USB port. Ensure the USB drive has the firmware file located in the root directory.
 2. Press  + .
 3. Select USB with the *Media[F1]* soft-key.
 4. Press the *File Utility[F5]* soft-key.
 5. Select the *.UPG upgrade file and press *Select[F1]* twice. Once to select the file and once to confirm.
 6. Wait for the update to complete and reset the power when prompted.
-

**Note**

Do not turn the load generator off or remove the USB memory when the firmware is being read or upgraded.

Conventions

The following conventions are used throughout the user manual. Read the conventions below for a basic grasp of how to operate the PEL-3000(H) menu system using the front panel keys.

Soft Menu keys The F1 to F5 function keys at the bottom of the display correspond directly to the soft-menu keys on top.

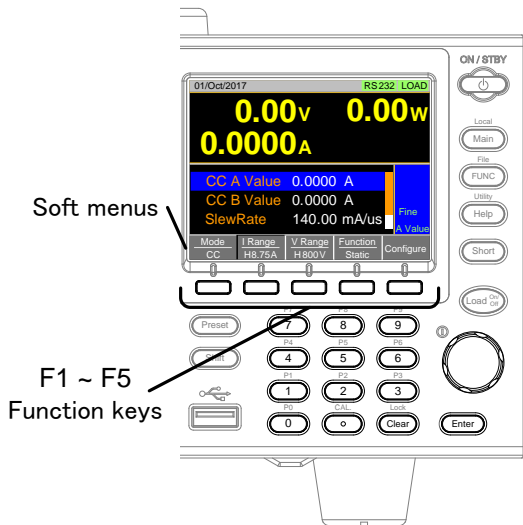

Select Sub Menu Configure

Pressing this type of soft-menu key will enter a submenu.

Toggle Parameter or State Function/Item



Parameter or State

This type of soft-menu icon has the function/item on the top of the label and the selected setting or mode on the bottom of the label.

Repeatedly press the associated function key (F1-F5) to cycle through each setting. For example, repeatedly pressing the *Mode* soft-menu key will cycle through the CC, CR, CV and CP modes.

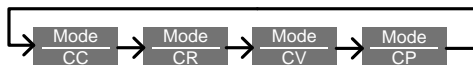

For some parameters, a popup window will also appear. Selection of the setting is the same. Repeatedly pressing the relevant function key (F1-F5) will cycle through each setting. The selection on the popup window will also be reflected on the label.

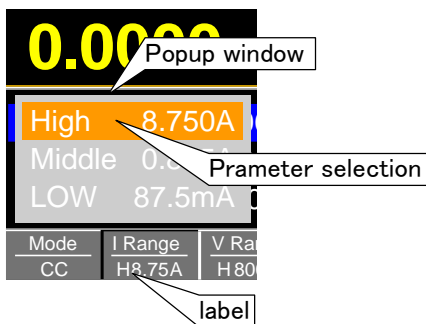

Parameter Input The scroll wheel, Enter key and number pad can be used to edit parameter values.

Number pad

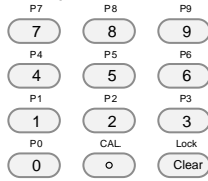

Scroll wheel



Enter key

1. Use the scroll wheel to move the cursor to the desired parameter.
- A scroll bar is shown when there are additional parameters off-screen.

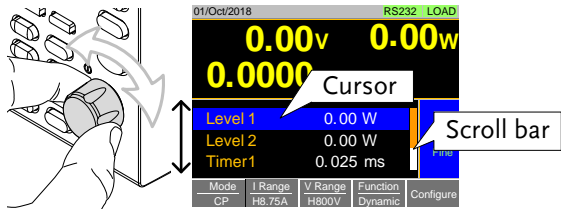

2. Press the Enter key to select the parameter. The parameter will become highlighted in white

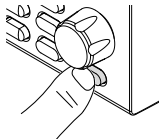

3. Then use the number pad* or scroll wheel** to edit the parameter value.

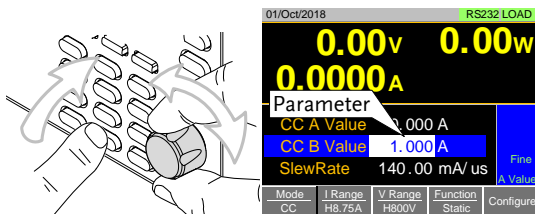

4. Press the Enter key again to finish editing the parameter value.

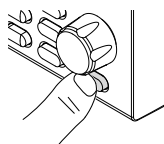

Clearing a Value* *When editing a parameter with the number pad, pressing the **Clear** key will restore the parameter to the previous value.

Using the Scroll Wheel to Edit a Parameter** **To edit a parameter using the scroll wheel, simply turn the scroll wheel. Clockwise increases the value, counterclockwise decrease the value.

Pressing the scroll wheel when a parameter is highlighted allows you to change the step resolution. There are two different step resolution methods: Step Mode and Cursor Mode. Step Mode: This is the default step resolution method and will only be available to use when it is applicable (Indicated by *Fine* or *Coarse* in the Operation Status panel).

When a parameter is highlighted (step 3 above) pressing the scroll wheel will toggle the step resolution between fine and coarse. For details on how to set the step resolution, see page 81.

The screenshot shows the instrument's display with the following data:

- 01/Oct2018 (Date)
- RS232 LOAD (Mode)
- 0.00v (Voltage)
- 0.00w (Power)
- 0.0000A (Current)
- CC A Value 0.000 A
- CC B Value 1.000 A (highlighted)
- SlewRate 140.00 mA/us
- Mode: CC
- I Range: H8.75A
- V Range: H800V
- Function: Static
- Configure

Annotations in the image:

- "Highlighted parameter" points to the "CC B Value" field.
- "Coarse/Fine adjustment" points to the "Fine A Value" button.

Cursor Mode: This method must first be enabled before it can be used. Pressing the scroll wheel when a parameter is highlighted allows you to set the step resolution by a digit value. An orange line will appear under the currently selected digit value. Repeatedly pressing the scroll wheel moves to the next digit. See page 80 for details.

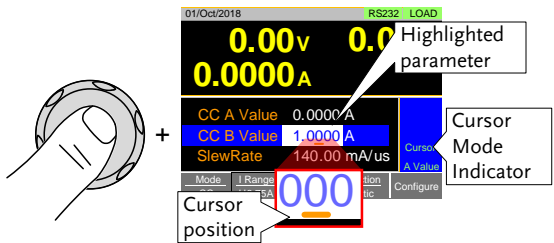

Entering Alphanumeric Characters

When renaming files, creating memos or notes, you will be required to enter alphanumeric characters when the character entry screen appears.

- Only alphanumeric characters as well as space [], underscore [_] and minus [-] characters allowed.
1. Use the scroll wheel to move the cursor to the desired character.

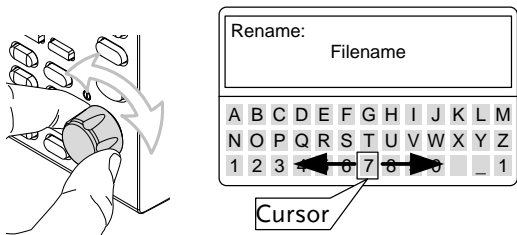

2. Press the **Enter** key or *Enter Character*[F1] to select a character.

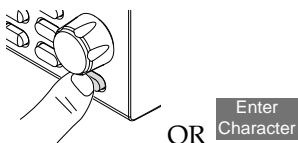

3. To delete a character, press *Back Space*[F2].
4. To save the file name or memo, press *Save*[F3].

Help Menu

When any function key has been pressed or when a menu has been opened, the HELP key can be used to display a detailed description.

- Help Selection
1. Press any function key or soft-menu key.
 2. Press  to see the help contents on that particular function key or menu.
 3. Use the scroll to navigate the help contents.
 4. Press the *Exit[F5]* key to exit the help menu.

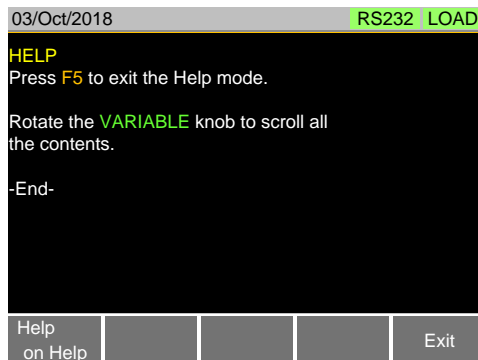

O PERATION

Basic Operation	54
CC Mode	54
CR Mode	56
CR Units	57
CV Mode	58
CP Mode	59
+CV Mode	61
Turning on the Load	62
Shorting the Load	62
Safety Short	63
Short Key Configuration	64
Short Function Enable/Disable	65
Locking the Front Panel Controls	65
Basic Configuration	66
Select the Switching Function	66
Select the Display Units for Dynamic Mode Levels	68
Select the Switching Time Configuration for Dynamic Mode	69
Slew Rate	70
CV, +CV Mode Response Speed	71
CC, CR and CP Mode Response Speed	72
Advanced Configuration Settings	73
Soft Start	73
Von Voltage Settings	74
Von Voltage	74
Von Latch	75
Von Delay	76
Timer Functions	76
Count Time	76
Cut Off Time	77
Auto Load Configuration	78
Load Off (Mode) and Load Off (Range)	79
Step Resolution Configuration	80
Cursor Mode Configuration	80

Step Mode Configuration	81
Protection Settings	83
OCP	83
OPP	84
UVP	85
UVP Ring Time	86
OVP	88
UnReg	89
Para	90
RVP	91
System Settings	92
Sound Settings	92
Speaker Settings	92
Alarm Tone Settings	93
Display Settings	93
Contrast and Brightness	93
Control Settings	94
Language Settings	94
Input/Output Trigger Settings	94
Trigger In Delay	94
Trigger Out Width	95
Measure Average	95
RVP Load Off	96
Go-NoGo	97
Setting the Go-NoGo Limits	97
Running a Go-NoGo Test	98
Save Recall	100
File Structure	100
File Types	101
Saving Files to Internal Memory	102
Saving Files to USB Memory	104
Recalling Files from Internal Memory	106
Recalling Files from USB Memory	107
Recall Memory Safety Setting	109
File Utility	109
Preset	111
Quick Preset Save	111
Quick Preset Recall	111
Default Settings	112
Factory Default Settings	112
User's Default Setting	112
Function Menu Overview	114
Select a Function	114

Turning on the Load with the Selected Function	116
Complete Ring Time	117
NSEQ Timer	118
Program	120
Program Overview.....	120
Create a Program	122
Create a Program Chain.....	125
Running a Program or Chain.....	126
Sequence	128
Normal Sequence Overview	128
Timing Edit Configuration.....	132
Data Edit Configuration	134
Running a Normal Sequence	135
Fast Sequence Overview.....	138
Timing Edit Configuration.....	142
Data Edit Configuration	143
Running a Fast Sequence.....	145
OCP Test Automation	147
OPP Test Automation	154
BATT Test Automation	160
MPPT.....	169
Edit Tracking of MPPT function.....	173
Auto Load of MPPT function.....	174
Data file of test result.....	179

Basic Operation

The PEL-3000(H) supports 7 main operating modes:

CC, CC+CV;

CR, CR+CV;

CV;

CP, CP+CV

CC Mode

Description	In Constant Current Mode the load units will sink the amount of current programmed. Regardless of the voltage, the current will stay the same. For more details on CC mode, please see the Appendix on page 259.
-------------	--



Warning

If you change the mode or the range when the load is already on, the load will be turned off automatically.

Operation

1. Make sure the load is off.
2. Press  .
3. Select CC mode with the *Mode[F1]* soft-key.
4. Select the current range with the *I Range[F2]* soft-key.

Range: High, Middle, Low

5. Select the voltage range with the *V Range[F3]* soft-key.

Range: High, Low

6. Set the current level parameters using the scroll wheel and number pad.
 - For Static mode, set *CC A Value* and/or *CC B Value*.
 - For Dynamic mode, set *Level1* and *Level2*.
 - The maximum and minimum current levels depend on the selected ranges.
7. To add CV mode to CC mode (CC+CV), see page 61.
8. Set the remaining basic configuration settings such as the slew rate, and switching function settings. See page 66 for details.

Display

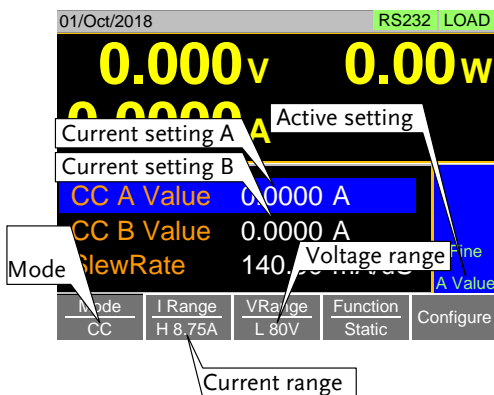

 Note

Basic CC mode configuration is complete. See page 66 for more configuration options.

The current range and voltage range applies to all the operating modes.

CR Mode

Description In Constant Resistance Mode, the unit will maintain a constant resistive load by varying the current. CR mode uses ohms, Ω (resistance) or siemens, S (conductance) for the setting units. For more details on CR mode, see the appendix on page 260.



Warning

If you change the mode or the range when the load is already on, the load will be turned off automatically.

Operation

1. Make sure the load is off.
2. Press  .
3. Select CR mode with the *Mode[F1]* soft-key.
4. Select the current range with the *I Range[F2]* soft-key.

Range: High, Middle, Low

5. Select the voltage range with the *V Range[F3]* soft-key.

Range: High, Low

6. Set the resistance or conductance level parameters using the scroll wheel and number pad.
 - For Static mode, set *CR A Value* and/or *CR B Value*.
 - For Dynamic mode, set *Level1* and *Level2*.
 - The maximum and minimum conductance/resistance levels depend on the selected current range.
 7. To add CV mode to CR mode (CR+CV), see page 61.
 8. Set the remaining basic configuration settings
-

such as the slew rate, and switching function settings. See page 66 for details.

Display

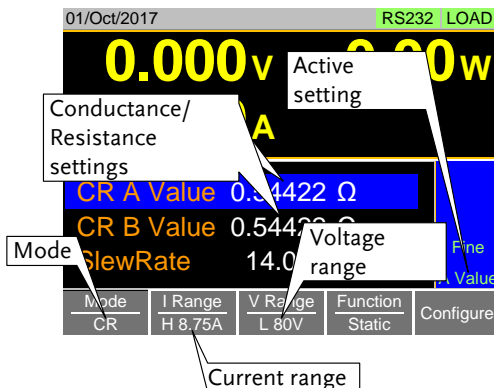

Note

Basic CR mode configuration is complete. See page 66 for more configuration options.

The current range and voltage range applies to all the operating modes.

CR Units

Description

The CR setting units can be set to ohm (Ω) or millisiemens (mS).

Operation

1. Make sure the load is off.
2. Press **Main** > *Configure*[F5] > *Other*[F2] and set the *CR Unit* setting.

Range: Ω , mS

CV Mode

Description In Constant Voltage Mode, the unit will maintain a constant voltage. In CV mode you set the constant voltage level. For more details on CV mode, see the appendix on page 263.



Warning

If you change the mode or the range when the load is already on, the load will be turned off automatically.

Operation

1. Make sure the load is off.
 2. Press  .
 3. Select CV mode with the *Mode[F1]* soft-key.
 4. Select the current range with the *I Range[F2]* soft-key.

 Range: High, Middle, Low
 5. Select the voltage range with the *V Range[F3]* soft-key.

 Range: High, Low
 6. Set the voltage level parameters using the scroll wheel and number pad.
 - Set CV A Value and/or CV B Value.
 - The maximum and minimum voltage levels depend on the selected voltage range.
 7. Set the remaining basic configuration settings such as the response settings. See page 66 for details.
-

Display

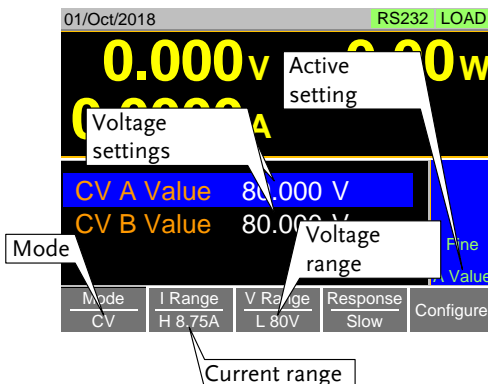

Note

Basic CV mode configuration is complete. See page 66 for more configuration options.

The current range and voltage range applies to all the operating modes.

CP Mode

Description

In Constant Power Mode, the unit will maintain a constant power by varying the current. For more details on CP mode, see the appendix on page 262.



Warning

If you change the mode or the range when the load is already on, the load will be turned off automatically.

Operation

1. Make sure the load is off.

2. Press  .

3. Select CP mode with the *Mode*[F1] soft-key.

4. Select the current range with the *I Range*[F2] soft-key.

Range: High, Middle, Low

5. Select the voltage range with the *V Range*[F3] soft-key.

Range: High, Low

6. Set the power level parameters using the scroll wheel and number pad.
 - For Static mode, set *CP A Value* and/or *CP B Value*.
 - For Dynamic mode, set *Level1* and *Level2*.
 - The maximum and minimum power levels depend on the selected current range.
 - For static mode, the parameter that is set last becomes the “active” setting. This will be shown in the Operation Status Panel.
7. To add CV mode to CP mode (CP+CV), see page 61.
8. Set the remaining basic configuration settings such as the slew rate, and timer settings. See page 66 for details.

Display

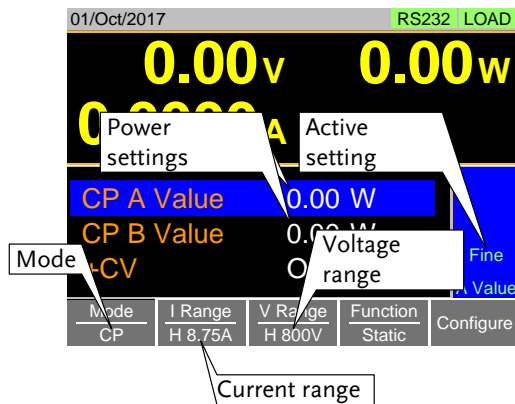

 Note

Basic CP mode configuration is complete. See page 66 for more configuration options.

The current range and voltage range applies to all the operating modes.

+CV Mode

Description +CV mode can be added to CC, CR and CP mode.

- The +CV settings apply to all applicable modes.

Operation

- Make sure the load is off.
- Press **Main** and select to Mode, I Range and V Range.
- Set the +CV voltage level. (You may need to scroll down to the +CV setting)

Range: OFF - rated voltage+5%

Display

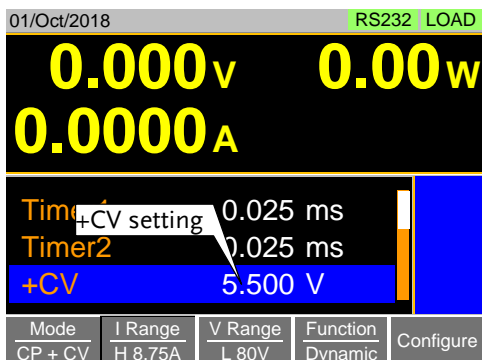

Note

The +CV settings apply to all the applicable operating modes.

For example: The +CV settings made in CR mode will be carried over to the +CV settings in CC and CP mode.





Note

+CV settings cannot be controlled with external control. (The external control is not possible only in +CV settings)

See page 185 for +CV settings with external control

Turning on the Load

- Description
1. The load can be turned on and off by pressing the  key.
 - The  key will turn orange when the load is “on”.
 - The LOAD icon in the Main Frame status panel will turn orange when the load is on.



Note

- The load can be set to automatically turn on at start up. See page 78.
- The load can be turned on via remote control. See the programming manual.
- The load can be turned on via external control. See page 194.
- By default the load will automatically turn off if the range or operating mode (CC, CV, CR, CP) is changed. To disable this behavior, Set *Load Off (Mode)* and *Load Off (Range)* to the *OFF* setting. See page 79 for details.



Display



Shorting the Load

- Description
- The Short key can be used to simulate a short circuit of the load input terminals. A short circuit is simulated by:
- Setting the current to the maximum value in CC mode.
 - Setting the resistance to the minimum value in CR mode.

- Setting the voltage to the minimum value in CV mode.
- Setting the power to the maximum value in CP mode.
- When the load is shorted, the external controller also sends a short signal. See page 200 for usage details.

- Operation
1. The short function can be turned on and off by pressing the  key.
 - The  key will turn red when the short function is active.
 - The Short icon will appear when the short function is active.

Display

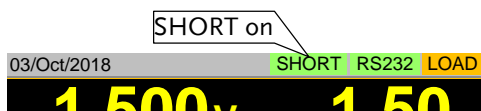

If the load is already off, pressing the Short key will turn the load on (shorted) at the same time. Pressing the Short key again will also turn the load off again as well.

If the load is already on and the Short key is pressed, then when the Short key is pressed again the load will remain on (the electronic load will return to its previous load condition).



The Short key will be disabled if the Short Function setting is turned off. See page 64 for details.

Safety Short

- Description
- When activated, the safety short function only allows the short key to be used when the load is already on.

Operation	<ol style="list-style-type: none"> Press  > <i>Configure</i>[F5] > <i>Other</i>[F2] and set the <i>Short Safety</i>. <ul style="list-style-type: none"> When set to OFF, the load can be shorted at anytime. When set to ON, the load can only be shorted when the load is already on.
Short (Safety): OFF, ON	

 **Note** The Short Safety setting will be grayed out if Short Function is set to OFF. See page 64 for details.

Short Key Configuration

Description	<p>The Short key can be configured to Toggle or Hold. By Default the Short key is set to Toggle.</p> <ul style="list-style-type: none"> Toggle: Pressing the Short key will toggle the shorting function on or off. Hold: Holding the short key will short the load.
Operation	<ol style="list-style-type: none"> Press  > <i>Configure</i>[F5] > <i>Other</i>[F2] and set the <i>Short Key</i> setting.
Range: Toggle, Hold	

 **Note** The Short Key setting will be grayed out if Short Function is set to OFF. See page 64 for details.

Short Function Enable/Disable

Description	The short key can be disabled to prevent the operator accidentally shorting the load.
Operation	<ol style="list-style-type: none"> Press Main > <i>Configure</i>[F5] > <i>Other</i>[F2] and set the <i>Short Function</i>. When set to OFF, the Short key is disabled and all short configuration options in the Main>Configure>Other menu are also disabled. When set to ON, the Short key is enabled.
Short Function: OFF, ON	

Locking the Front Panel Controls

Description	The keys and scroll wheel on the front panel can be locked to prevent settings from being changed.
Operation	<ol style="list-style-type: none"> The keys can be locked and unlocked by pressing Shift + Clear^{Lock}. LOCK will appear in the Mainframe status panel when the keys are locked. The Load On/Off key will not be locked if the load is on.
Display	LOCK will appear in the Mainframe status panel when the keys are locked.

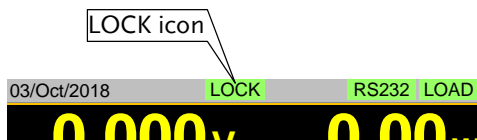

Basic Configuration

The basic configuration settings are the common configuration settings that are used for each operating mode. After selecting a basic operating mode (CC, CR, CV or CP mode), the slew rate, switching function, response rate and other common parameters should be configured.

Select the Switching Function

Description The PEL-3000(H) has two switching function, static and dynamic. The switching function allows the PEL-3000(H) to switch between two preset levels. Static mode can only switch between the two levels manually, while Dynamic mode switches between each level automatically based on a timer.

- Static mode: A Value, B Value
- Dynamic mode: Level1, Level2

When the unit is set to static mode, only one value (A Value or B Value) can be active at a time. The active value is shown in the Operation Status Panel.

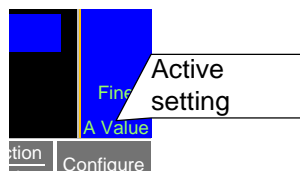

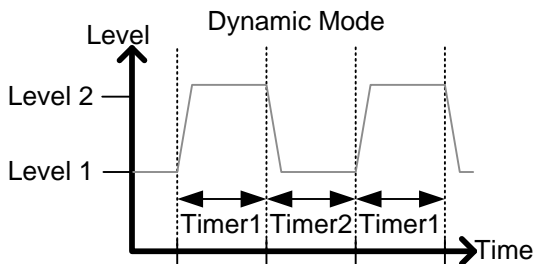

When the unit is set to dynamic mode, the unit will switch between Level1 and Level2 based on the Timer1 and Timer2 parameters, shown below.



Note

Dynamic mode is not available for CV mode.

Operation

1. Make sure the load is off.
2. Press  .
3. Select Dynamic or Static mode with the *Function[F4]* soft-key.
 - A different switching function can be set for CC, CR and CP mode.
4. For dynamic mode, set the Timer1 and Timer2 parameters using the scroll wheel and number pad.
 - Timer1 sets the Level1 on-time.
 - Timer2 sets the Level2 on-time.
 - Take the slew rate settings into consideration when setting the timers.
 - The frequency of the dynamic switching is output via the TRIG OUT BNC.
5. In the static mode, select either value A or value B as the “active” value for execution followed by pressing the  +  .
 - The “active” value will be shown in the Operation Status Panel.
 - The load can be “on” when switching between A Value and B Value.

Display:
Static Mode

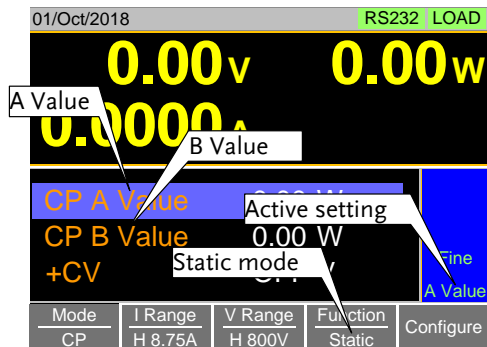

Display:
Dynamic Mode

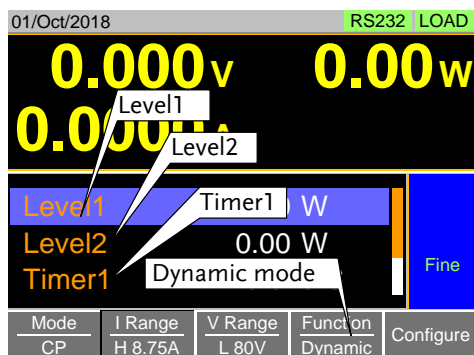

Select the Display Units for Dynamic Mode Levels

Description

When Dynamic mode is selected, the Level1 and Level2 values can be set to either discrete values or as a percentage of a set value.

- The setting applies to all applicable operation modes.
- By default the units are set to Value.
- When Percent is chosen, 100% = 100% of the Set power, current or resistance value.

- Operation
1. Make sure the load is off.
 2. Press **Main** > *Configure*[F5] > *Other*[F2] and set the *Dyna. Level* setting.

Range: Value, Percent

Display:
Percent Setting

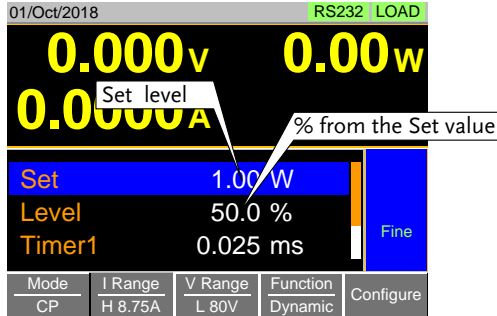

Example

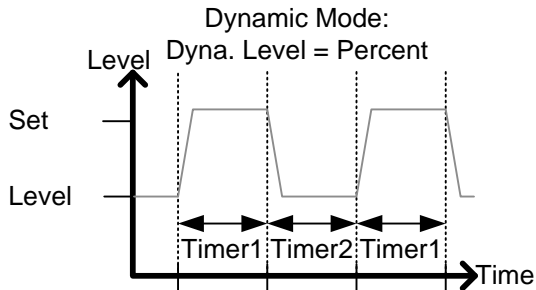

Select the Switching Time Configuration for Dynamic Mode

Description

The switching time for dynamic mode can be configured to switch between two preset on-times (Timer1, Timer2) or by setting a switching frequency and duty cycle.

- Operation
1. Press **Main** > *Configure*[F5] > *Other*[F2] and set the *Dyna. Time* setting.

Range: T1/T2, Freq. Duty

Slew Rate

Description The current slew rate can be set for CC and CR mode. The slew rate setting is used to limit the change in current when switching.

For static mode, only a single slew rate can be set.

- Operation**
1. Make sure the load is off.
 2. Press  .
 3. Set the slew rate(s) using the scroll wheel and number pad.
 - For static mode, only a single slew rate can be set.
 - For dynamic mode, set both the rising and falling slew rates.
 - Take the timer settings into consideration when setting the slew rates.

Display

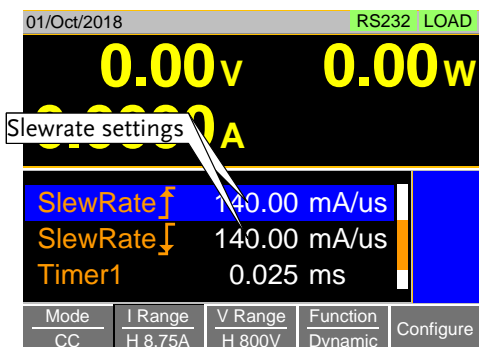

CV, +CV Mode Response Speed

Description	<p>The response speed setting is the response speed for the negative feedback control of the load current when used in CV, +CV mode. Response speed settings are only applicable to CV, +CV mode.</p> <ul style="list-style-type: none">• A response speed that is too fast could cause the unit to be unstable.• Reducing the response speed can improve stability.
Operation	<ol style="list-style-type: none">1. Make sure the load is off.2. Press . Make sure the unit is in CV mode by using the <i>Mode</i>[F1] soft-key.3. Select the response speed with the <i>Response</i>[F4] soft-key. <hr/> <p>Range: Slow, Fast (Fast, 6, 5, 4, 3, 2, 1, slow)</p> <p>CV mode: The response speed settings Fast, 6, 5, 4 are all the same for CV mode.</p> <p>+CV mode: The response speed settings 5 and 4 are the same for CV mode. The response speed settings Slow and 1 is the same.</p> <hr/>

Display

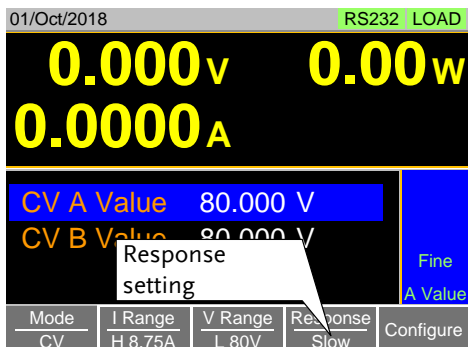

CC, CR and CP Mode Response Speed

Description By default, the “normal current response” speed is set to 1/1. The response speed can be reduced to 1/2, 1/5, 1/10.

- Reducing the current response speed can affect other settings such as the slew rate and soft start settings.

Operation

1. Make sure the load is off.
2. Press **Main** > *Configure*[F5] > *Other*[F2] and set the *Response* parameter.

Range: $\frac{1}{1}$, $\frac{1}{2}$, $\frac{1}{5}$, $\frac{1}{10}$

Advanced Configuration Settings

Use the advanced configuration settings to configure settings other than those described in the basic configuration chapter.

Soft Start

Description The soft start setting is used to limit the amount of input current at start-up or from when the Von Voltage threshold is tripped.

- The soft start setting only applies to CC, CR and CP mode (CP mode only for PEL-3000 series).

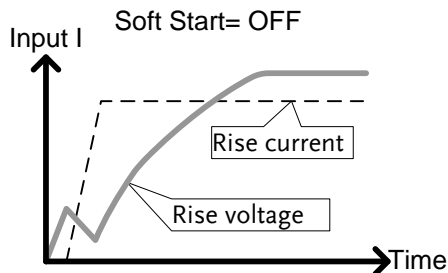
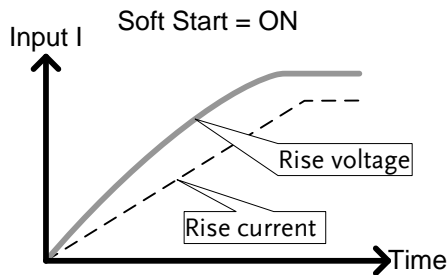

Operation

1. Press **Main** > *Configure*[F5] > *Other*[F2] and set the *Soft Start* time.

Range: OFF, 1-200ms for PEL-3000
OFF, 3-200ms for PEL-3000H

Von Voltage Settings

Von Voltage

Description The Von Voltage is the threshold voltage at which the load module will start to sink current.

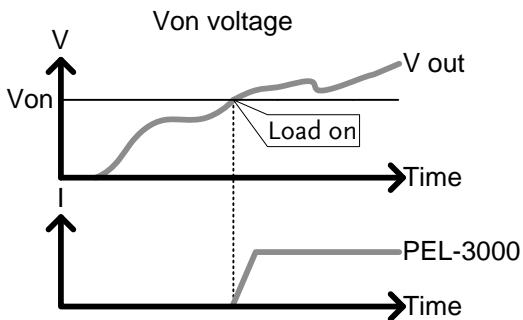

Operation 2. Press **Main** > *Configure*[F5] > *Other*[F2] and set the *Von Voltage* level.

Range: Von Voltage: 0.00-rating voltage

Von Latch

Description When Von Latch is set to ON, the load will continue to sink current after being “latched”, even if the voltage drops below the Von Voltage threshold level.

When Von Latch is set to OFF, the load will turn off when the voltage drops below the Von Voltage threshold level.

By default Von Latch is set to OFF.

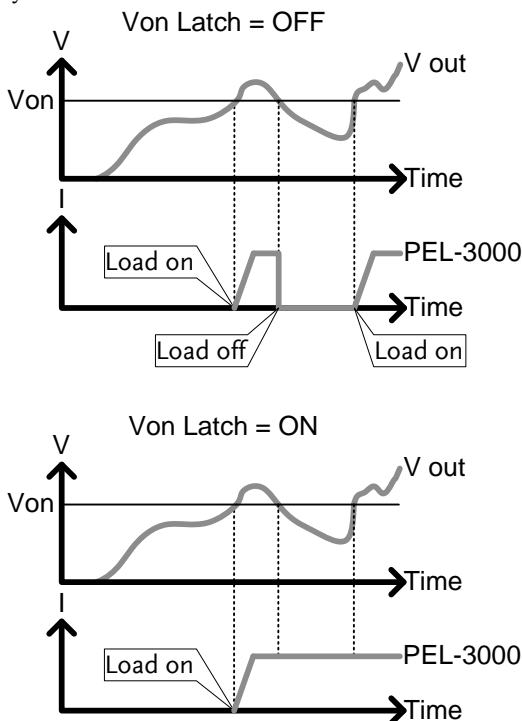

Operation

1. Press **Main** > *Configure*[F5] > *Other*[F2] and set the *Von Latch* setting.

Range: Von Latch: OFF, ON

Von Delay

Description Von Delay is the amount of time the unit will wait before turning the load on after the Von Voltage threshold has been latched. This will prevent overshoot current from affecting the Von Voltage threshold.

Operation 1. Press  > *Configure*[F5] > *Other*[F2] and set the *Von Delay* time.

Range: Von Delay: OFF, 2.0-60ms(CC, CV, CP mode)
OFF, 5.0-60ms (2.0-60ms) (CR mode)



Note

CR mode can have the delay time set separately from the other modes (called *Von Delay -CR* when in CR mode).

Timer Functions

Count Time

Description When Count Time is set to on, it will count the elapsed time from when the load was turned on to when it was turned off.

- This function is applicable to manual and automatic shutdown (such as from protection functions such as UVP etc.)
- The elapsed time will be shown in the display Measurement area.

Operation 1. Press  > *Configure*[F5] > *Other*[F2] and turn the *Count Time* on or off.

Range: ON, OFF

Display

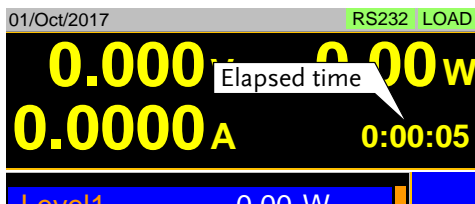

Cut Off Time

Description

The Cut Off Time function will turn the load off after a set-amount of time. After the load has been turned off, a popup screen will display the voltage level when the load was turned off.

Operation

1. Press **Main** > *Configure*[F5] > *Other*[F2] and set the *Cut Off Time*.

Range: OFF, 1 second - 999 hours:59 minutes:59 seconds

Display

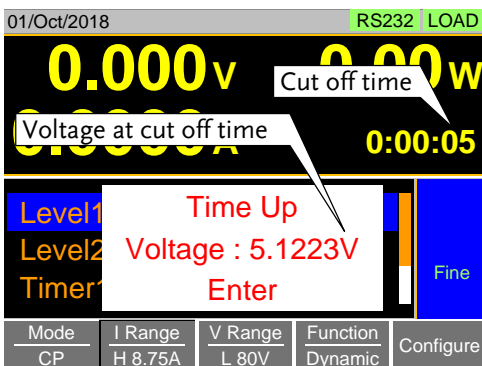



Auto Load Configuration

Description The PEL-3000(H) can be configured to automatically load the last program, normal sequence, fast sequence or load setting at startup.

By default, this setting is disabled.

Operation

1. Press  +  > Load[F2].
 2. Turn *Auto Load On* or *Off*.
 - When set to OFF, the Auto Load setting is disabled.
 3. Select the *Auto Load On* configuration.
 - This will select whether the PEL-3000(H) will automatically load the last program, normal sequence, fast sequence or load settings.
-

Auto Load On: Load, Prog, NSeq, FSeq

Load Off (Mode) and Load Off (Range)

Description By default the load will automatically turn off when the either the operating mode (CC, CV, CR, CP) or the range (I range, V range) is changed.

To allow the load to stay on when the operating mode is changed, set the *Load Off (Mode)* setting to *OFF*.

To allow the load to stay on when the current or voltage range is changed, set the *Load Off (Range)* setting to *OFF*.

By default, these settings are set to *ON*.

Operation

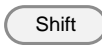
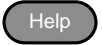
1. Press  +  > *Load*[F2].
 2. Select *Load Off (Mode)* setting.
 - When set to *OFF*, the load will stay on when the operating mode is changed.
-

Load Off (Mode): OFF, ON

3. Select *Load Off (Range)* setting.
 - When set to *OFF*, the load will stay on when the range is changed.
-

Load Off (Range): OFF, ON

Step Resolution Configuration

There are two different ways to set the resolution when using the scroll wheel to edit parameters. Step Mode and Cursor Mode. Step Mode is the default method. Only one mode can be active at a time; When one mode is active, the other mode is deactivated.

Cursor Mode Configuration

Description Cursor mode allows you to edit the selected parameter one digit at a time. When editing a parameter, pressing the scroll wheel determines which digit is selected. Turning the scroll wheel will then edit the parameter by the step resolution of the digit.

See the Conventions section on page 45 for operation details.

Operation

1. Press **Main** > *Configure*[F5] > *Next Menu*[F4] > *Knob*[F2] and set the *Status* setting is set to *Cursor*.

Display

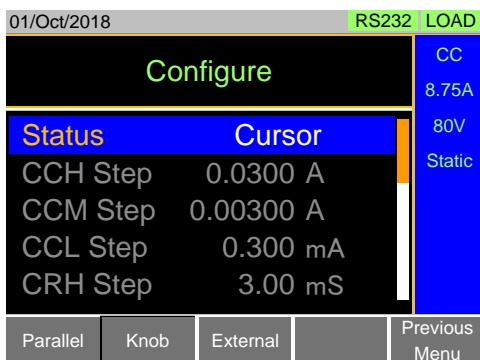

Step Mode Configuration

Description When set to Step Mode, the voltage, current, resistance and power settings can have the step resolution configured. The step resolution refers to the step resolution of the coarse adjustment for these settings. The fine adjustment cannot be configured.

See the Conventions section on page 45 for details on how to switch between coarse and fine adjustment modes.

Settings The step resolution of each setting is configured separately for each current range.

Settings	Description
CCH Step	CC mode, IRange = High
CCM Step	CC mode, IRange = Middle
CCL Step	CC mode, IRange = Low
CRH Step	CR mode, IRange = High
CRM Step	CR mode, IRange = Middle
CRL Step	CR mode, IRange = Low
CVH Step	CV mode, VRange = High
CVL Step	CV mode, VRange = Low
CPH Step	CP mode, IRange = High
CPM Step	CP mode, IRange = Middle
CPL Step	CP mode, IRange = Low

Operation

1. Press **Main** > *Configure*[F5] > *Next Menu*[F4] > *Knob*[F2] and make sure the *Status* setting is set to *Step*.
2. Set the desired step resolution settings. (The step resolution settings are only available when *Status=Step (coarse/fine)*)
 - For example if the step resolution for CCM Step is 0.5A, then the resolution can be incremented in 0.5A steps.

Display

01/Oct/2018		RS232 LOAD	
Configure			
Status	Step (coarse/fine)		CC
CCH Step	0.0300 A		8.75A
CCM Step	0.00600 A		80V
CCL Step	0.300 mA		Static
CRH Step	3.00 mS		
Parallel	Knob	External	Previous Menu

Protection Settings

The Protection settings are used to prevent damage to the unit or the DUT by excessive current, voltage or power.

An alarm is generated and a message is displayed on the screen when a protection setting is tripped. When an alarm is activated, the load is turned off (or limited), and the ALARM STATUS pin of the J1 connector on the rear panel (pin 16) turns on (open collector output by a photocoupler). The protection settings can be used regardless of whether the remote sense connections are used or not.

OCP

Description	<p>For OCP, the PEL-3000(H) can be configured to either limit the current or turn off the load.</p> <p>The OCP levels can be set to 10% higher than the rating current.</p>
Operation	<p>1. Press  > <i>Configure</i>[F5] > <i>Protection</i>[F1] and set the <i>OCP Level</i> and <i>OCP Setting</i>.</p> <hr/> <p>Range: OCP Level: Rating current + 10%</p> <p> OCP Setting: LIMIT, Load Off</p>
Alarm	<ul style="list-style-type: none"> • When <i>OCP Setting</i> is configured to <i>Load Off</i>, a message will be displayed on the screen when OCP is tripped. The Enter key must be pressed to clear the alarm message. • When configured to <i>LIMIT</i>, OCP will be displayed on the screen when the OCP is tripped and the current will be limited to the <i>OCP Level</i> setting.

Display

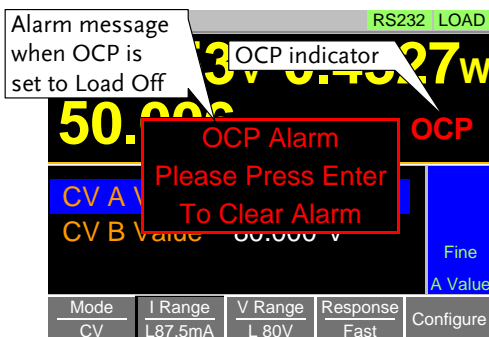

OPP

Description

For OPP, the PEL-3000(H) can be configured to either limit the power or turn off the load.

The OPP levels can be set to 10% higher than the rating power.

Operation

1. Press **Main** > *Configure*[F5] > *Protection*[F1] and set the *OPP Level* and *OPP Setting*.

Range: OPP Level: Rating power + 10%
 OPP Setting: LIMIT, Load Off

Alarm

- When *OPP Setting* is configured to *Load Off*, a message will be displayed on the screen when OPP is tripped. The Enter key must be pressed to clear the alarm message.
- When configured to *LIMIT*, OPP will be displayed on the screen when the OPP is tripped and the power will be limited to the *OPP Level* setting.

Display

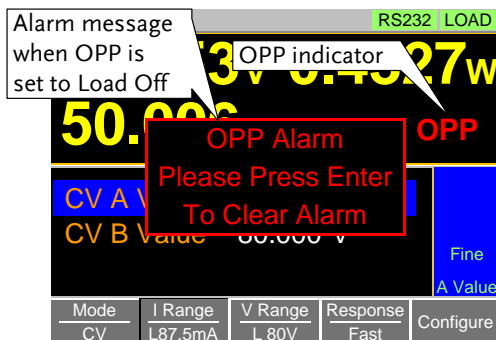

UVP

Description If the UVP is tripped, the PEL-3000(H) will turn off the load.

The UVP levels can be set from 0V to 10% higher than the rating voltage.

Operation

1. Press **Main** > *Configure*[F5] > *Protection*[F1] and set the *UVP Level*.

Range: UVP Level: OFF, 0-Rating voltage + 10%

Alarm

- The UVP indicator and a message will only appear on the screen when the input voltage is below the UVP level. The Enter key must be pressed to clear the alarm message.
- To clear the UVP indicator, remove the cause of the under voltage - i.e., increase the input voltage.

Display

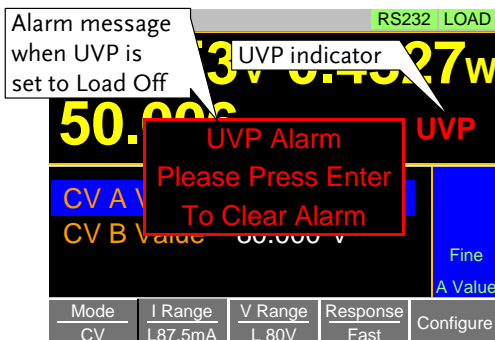

UVP Ring Time

Description The UVP Ring Time settings allows the UVP alarm to keep sounding for a user-set amount of time after the UVP has been tripped.

The alarm will continue ringing for the set amount of time even if the voltage rises back above the UVP level~ unless the alarm is cleared manually.

Operation 1. Press **Main** > *Configure*[F5] > *Protection*[F1] and set the *UVP Ring Time*.

Range: UVP Ring Time: OFF, 0-600s

Alarm

- When the voltage dips below the UVP level, the UVP indicator and message will appear on the screen. The UVP buzzer will sound if UVP Ring Time is set. Under this scenario the following outcomes are possible:
 1. Pressing the Enter key will clear the message and the buzzer. The UVP indicator will remain on the display until the voltage level rises back above the UVP level.
 2. If the UVP Ring Time is allowed to elapse, the buzzer will stop. However the UVP indicator and message will remain on screen until the voltage increases and the message is cleared.
 3. If the voltage rises back above the UVP level, the UVP indicator will be cleared from the display but the buzzer will continue to sound until the UVP Ring Time has elapsed and the message will remain until it has been cleared.

Display

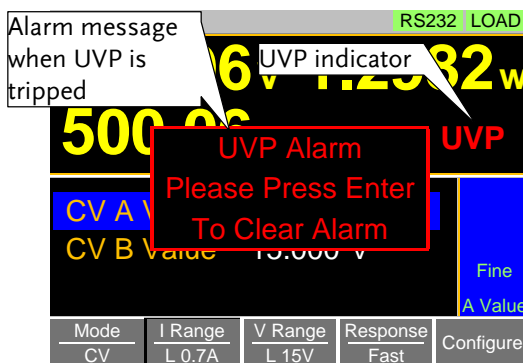

OVP

Description If the OVP is tripped, the PEL-3000(H) will turn off the load.

The OVP levels can be set from 0V to 10% higher than the rating voltage.

Operation 1. Press **Main** > *Configure*[F5] > *Protection*[F1] and set the *OVP Level*.

Range: OVP Level: OFF, 0-Rating voltage + 10%



Note

To turn OVP off, set the OVP voltage greater than the current rating voltage + 10%.

- Alarm**
- The OVP indicator and a message will only appear on the screen when the input voltage is below the UVP level. The Enter key must be pressed to clear the alarm message.
 - To clear the OVP indicator, remove the cause of the over voltage - i.e., reduce the input voltage.

Display

UnReg

Description The UnReg error message will appear on the display when the electronic load is operating in an unregulated state.

- Alarm**
- The UnReg indicator will appear on the display when the set load is inadequate for the source.
 - To clear the UnReg indicator, increase the load or reduce the load requirements.
-

Display

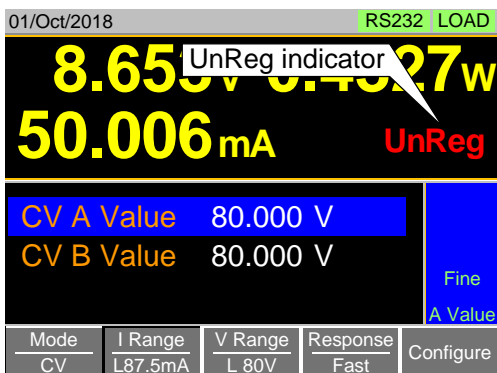

Para

Description The Para error message will appear on the display when the PEL-3000(H) is used in parallel and if an error is produced.

- Alarm**
- The Para error message indicates one of the following possible conditions: UnReg, ROCP, OTP.
 - To clear the Para indicator, remove the cause of the alarm.

Display

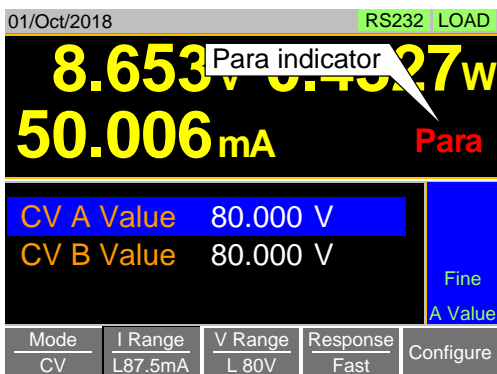

RVP

Description If the RVP is tripped, the PEL-3000H Series will turn off the load.

- Alarm**
- The RVP error message indicates when the terminal voltage is negative.
 - The Enter key must be pressed to clear the alarm message.

Display

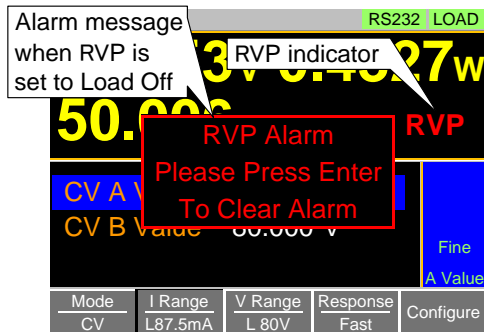

System Settings

The following section covers a number of miscellaneous system settings such as:

- Speaker settings
- Display settings
- Alarm tone settings
- Input control settings
- Language settings
- Input/output trigger settings



All system settings are accessible in the Utility menu.

Sound Settings

Speaker Settings

Description	Turns the speaker sound on or off for the user interface, such as key press tones and scrolling tones.
-------------	--



Operation

1. Press  +  > Other[F5].
2. Set the *Speaker* settings on or off.
 - When set to OFF, the speaker setting will not disable the tones for Go-NoGo or protection alarms.

Alarm Tone Settings

Description The alarm tone for the unit can be turned on or off in the utility menu. The alarm tone can be set separately for the protection settings (OCP, OPP, UVP, OVP), Go-NoGo testing or for when the unit is operating in an unregulated state (see page 89).

Operation

1. Press  +  > *Other*[F5].
 2. Set the alarm tone settings on or off.
 - The alarm tone settings ignore the *Speaker* setting.
-



Alarm Tone:	ON, OFF
UnReg Tone:	ON, OFF
Go_NoGo Tone:	ON, OFF

Display Settings

Contrast and Brightness

Description Sets the contrast level.

Operation

1. Press  +  > *Other*[F5].
 2. Set the *Contrast* and *Brightness* settings.
-

Range:	Contrast: 3 - 13 (low - high)
	Brightness: 50 - 90 (low - high)



Control Settings

Description The Knob Type setting determines if values are updated immediately as they are edited or if they are only updated after the Enter key is pressed.

The *Updated* setting is applicable for when the load is already on and the user wishes to change the set values (current, voltage, etc.) in realtime.

The *Old* setting will only update the values after the Enter key is pressed.

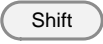
Operation



1. Press  +  > *Other*[F5].
2. Set the *Knob type* and *Slave knob* settings.

Range: Knob type: Updated, Old

Language Settings

Description The PEL-3000(H) supports only English.

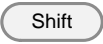
Operation

1. Press  +  > *Other*[F5].
2. Set the *Language* setting.

Supported languages: English

Input/Output Trigger Settings

Trigger In Delay

Description The Trig In Delay setting determines how long to delay any action after a trigger is received.

Operation

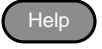

1. Press  +  > *Other*[F5].
2. Set the *Trig In Delay* setting.

Range: 0.01~100ms, Default: 0.01ms

Trigger Out Width

Description The Trigger Out Width setting sets the trigger output signal's pulse width.

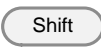
Operation

1. Press  +  > *Other*[F5].
2. Set the *Trig Out Width* setting.

Range: 2.5~5000.0μs, Default: 10μs

Measure Average

Description The Measure Average setting is used to set the speed of the measurement display. The setting has three modes. They are slow, normal and fast

The default mode for Measure Average setting is slow.

Operation

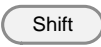
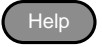
1. Press  +  > *Other*[F5].
2. Set the *Measure Average* setting.



Slow	Average 64 times; Display spend time:1280ms
Normal	Average 16 times; Display spend time:320ms
Fast	Average 4 times; Display spend time:320ms
Default	Slow mode

RVP Load Off

Description When the input terminal detects reverse voltage, a warning message will be displayed and the RVP Load Off setting can be set to turn on or off the load as well. The setting has two modes. They are ON and OFF.

The default mode for RVP Load Off setting is ON.

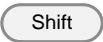
Operation

1. Press  +  > *Other*[F5].

2. Set the *Load Off* setting.

ON	When the input terminal detects the reverse voltage, a warning message will be displayed on the screen and the load will be turned off.
----	---

OFF	When the input terminal detects the reverse voltage, a warning message will be displayed on the screen but the load will not be turned off.
-----	---

Go-NoGo

The Go-NoGo configuration is used to create pass/fail limits on the voltage or current input. If the voltage/current exceeds the pass/fail limits, an alarm will be output.

The Go-NoGo configuration can be used with the Program function to create complex pass/fail tests.

Setting the Go-NoGo Limits

Description	The Go-NoGo setting limits can be set as either discrete high & low values or as a percentage offset from a center value.						
Operation	<ol style="list-style-type: none"> 3. Press  > <i>Configure</i>[F5] > <i>Go-NoGo</i>[F3]. 4. Select <i>Entry Mode</i> and choose how to set the pass/fail limits. <ul style="list-style-type: none"> • Value will allow you to set the limits as discrete values. • Percent will allow you to set the limits as a percentage offset from a center value. 5. If <i>Entry Mode</i> was set to <i>Value</i>, Set the <i>High</i> & <i>Low</i> limit values. 						
	<hr/> <table style="width: 100%; border-collapse: collapse;"> <tr> <td style="width: 150px;">High:</td> <td>0-rating current/voltage</td> </tr> <tr> <td>Low:</td> <td>0-rating current/voltage</td> </tr> </table> <hr/>	High:	0-rating current/voltage	Low:	0-rating current/voltage		
High:	0-rating current/voltage						
Low:	0-rating current/voltage						
	<ol style="list-style-type: none"> 6. If <i>Entry Mode</i> was set to <i>Percent</i>, Set the <i>Center</i> voltage/current and <i>High</i>, <i>Low</i> % values. <hr/> <table style="width: 100%; border-collapse: collapse;"> <tr> <td style="width: 150px;">Center:</td> <td>0-rating current/voltage</td> </tr> <tr> <td>High:</td> <td>0-100% of center voltage/current</td> </tr> <tr> <td>Low:</td> <td>0-100% of center voltage/current</td> </tr> </table> <hr/>	Center:	0-rating current/voltage	High:	0-100% of center voltage/current	Low:	0-100% of center voltage/current
Center:	0-rating current/voltage						
High:	0-100% of center voltage/current						
Low:	0-100% of center voltage/current						

7. Set the Delay Time.
 - The delay time setting will delay activating the Go-NoGo testing by a specified amount of time.
 - The delay setting can compensate for startup oscillation and other instabilities during startup.

Delay Time 0.0-1.0 seconds (0.1s resolution)

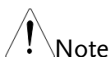

Note

When the Main settings are saved or recalled, the Go-NoGo settings are also saved/recalled. See the Save/Recall chapter for details, page 100.

Running a Go-NoGo Test

Description Go-NoGo test results are displayed in the measurement panel.

- GO indicates pass (good).
- NG indicates fail (no good).

Operation

1. Press **Main** > *Configure[F5]* > *Go-NoGo[F3]*.
2. Set *SPEC Test* to ON.
 - When SPEC Test is ON, SPEC will appear in the Operation Status Panel. This means the unit is ready for Go-NoGo testing.
3. Turn the load on.
 - The test starts from the time the load was turned on + the Delay Time.

Display:
GO

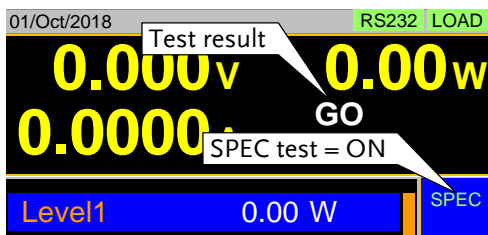

Display:
NG

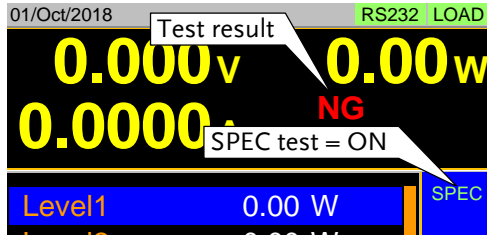

Save Recall

The PEL-3000(H) can save and recall system settings, preset data, memory data, Go-NoGo settings as well as normal and fast sequences to internal memory or to USB.

File Structure

Description The PEL-3000(H) file system can save files to internal memory (Media | Memory) and external memory (Media | USB).

To save or recall Memory, Setup or Preset data, the PEL-3000(H) uses a three tier system where files are saved or recalled in the following order:

Active settings <> Internal memory <> USB.

This can be best described in the picture below.

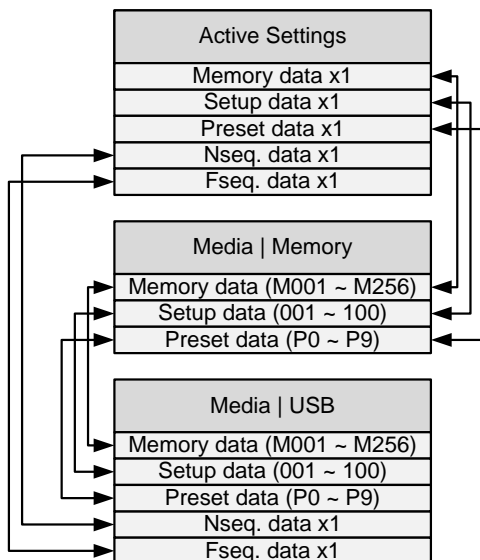

Example To load Preset Data P7 from USB, you must first load Preset Data P0-P9 to internal memory, then from internal memory load Preset P7 to be the

active preset setting.

For normal and fast sequences however, files can be saved or recalled directly to/from USB memory.

File Types

Memory Data	<p>Memory data contains general settings and is used for creating programs. Memory Data contains the operating mode, range, response and Go/NoGo settings. Memory data can be stored both internally and externally to USB. Preset data and Memory data store the same contents.</p>
	<p>Internal Format M001 - M256</p> <p>External Format model no_file no.M example: 3021(H)_01.M</p>
Setup Data	<p>Setup data contains all general configuration settings, protection settings, program and program chain settings, as well as parallel configuration settings.</p>
	<p>Internal Format 1 - 100</p> <p>External Format model no_file no.S example: 3021(H)_00.S</p>
Preset Data	<p>Preset Data contains the same settings as the Memory Data. Preset Data contains the operating mode, range, response and Go-NoGo settings.</p>
	<p>Internal Format P0 - P9</p> <p>External Format model no_file no.P example: 3021(H)_00.P</p>
NSeq Data	<p>NSeq Data contains the Normal Sequence settings.</p>
	<p>Internal Format None</p> <p>External Format model no_file no.N example: 3021(H)_00.N</p>
FSeq Data	<p>FSeq Data contains the Fast Sequence settings.</p>

Internal Format	None
External Format	model no_file no.F example: 3021 (H)_00.F

Saving Files to Internal Memory

Description When saving Memory, Setup or Preset Data to internal memory, the currently active setting is saved to one of the internal memory slots.

Memory Data has 256 memory slots, Setup Data has 100 memory slots and Preset Data has 10 memory slots.

Memory Data Example

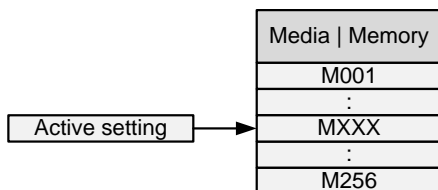

Display

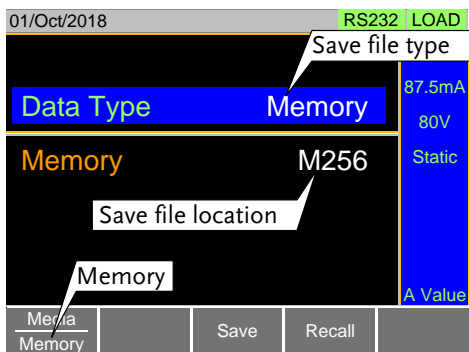

Operation

1. Press **Shift** + **File FUNC**.
2. Select **Memory** with the *Media[F1]* soft-key.
3. Select the *Data Type* and choose the type of file to save.

Data Type: Memory Data, Setup Data,
Preset Data

4. Select which internal memory location to save the file.
-

Memory: M001 - M256

Setup Memory: 1 - 100

Preset: P0 - P9

5. Press *Save*[F3] to save.

- Save Ok will be displayed when the save has been completed.
-



Note

Normal Sequence and Fast Sequence data cannot be recalled from or saved to an internal memory slot.

Saving Files to USB Memory

Description When saving files to USB memory, all the memory locations from the selected data type are saved as a single file to the USB file path directory.

Memory Data Example

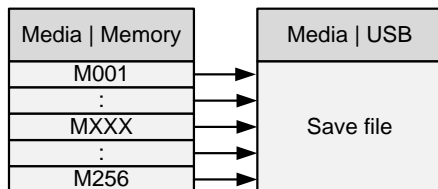

For example, Memory Data M001 to M256 are saved to a single file on USB.

Display

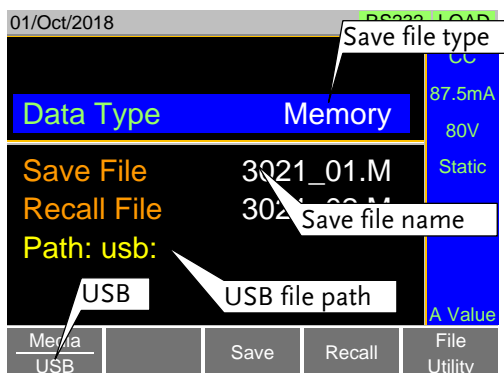

Operation

1. Insert a USB drive into the USB port.
 2. Press **Shift** + **FUNC**.
 3. Select USB with the *Media*[F1] soft-key.
 4. Select the *Data Type* and choose the type of file to save.
- Data Type:** Memory Data, Setup Data, Preset Data, NSeq, FSeq

-
5. Select *Save File* and choose a save filename.
 - Turn the scroll wheel to increase/decrease the file number.
-

Memory:	Model_file number.M
Setup Memory:	Model_file number.S
Preset:	Model_file number.P
NSeq:	Model_file number.N
FSeq:	Model_file number.F

6. Press *Save[F3]* to save.
 - The file will be saved to the USB file path.
 - Save Ok will be displayed when the save has been completed.
 - If saving-over an existing file you will be asked to confirm the save. Press *Save[F3]* to confirm.
-

- | | |
|----------------|--|
| File Utilities | <ol style="list-style-type: none">7. Press <i>File Utility[F5]</i> to access the file utility. See page 109 for details.<ul style="list-style-type: none">• Change the USB path.• Rename files or create directories. |
|----------------|--|

Recalling Files from Internal Memory

Description When recalling Memory, Setup or Preset Data from the internal memory slots, the recalled file becomes the active setting.

Memory Data has 256 memory slots, Setup Data has 100 memory slots and Preset Data has 10 memory slots.

Memory Data Example

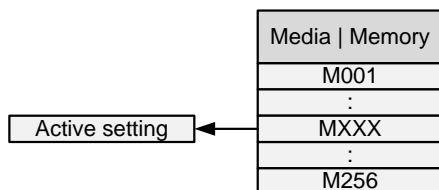

Display

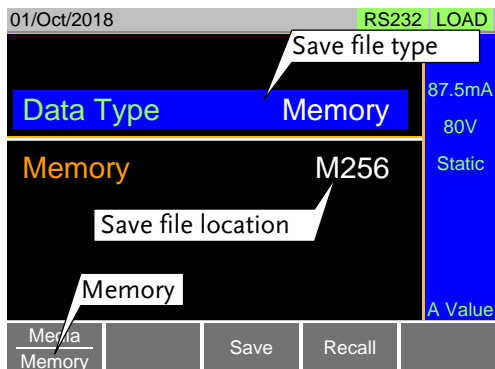

Operation

1. Press **Shift** + **File FUNC**.
2. Select *Memory* with the *Media[F1]* soft-key.
3. Select the *Data Type* and choose the type of file to recall.

Data Type: Memory Data, Setup Data, Preset Data

4. Select which memory slot to recall from.

Memory:	M001 - M256
Setup Memory:	1 - 100
Preset:	P0 - P9

5. Press *Recall*[F4] to recall.

- For Memory Data and Preset Data, a popup window will appear. Press the  key to confirm the recall.



Note

Normal Sequence and Fast Sequence data cannot be recalled from or saved to an internal memory slot. They can, however, be recalled directly from USB memory. See the next section below for details.

Recalling Files from USB Memory

Description When recalling Memory, Setup or Preset files from USB memory, a single file from the USB drive will overwrite all the existing memory slots for the selected data type.

For Normal or Fast Sequence files, the recalled file becomes the active setting as these types of files don't have an internal memory slot.

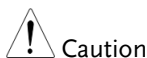

Caution

You can only recall files from the same model.

Memory Data Example

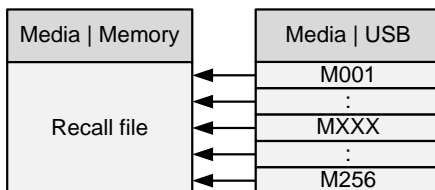

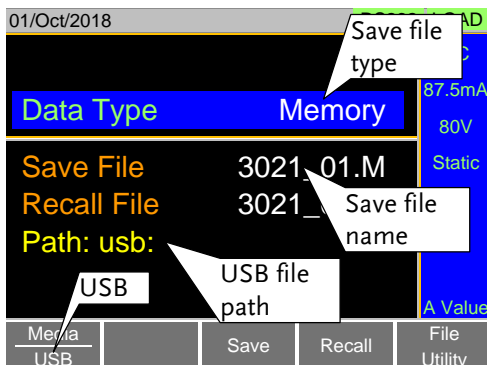

For example, if the file 3021(H)_01.M is recalled, all the Memory Data from M001 to M256 will be overwritten.

Display



Operation

1. Insert a USB drive into the USB port.

2. Press  + .
3. Select *USB* with the *Media[F1]* soft-key.
4. Select the *Data Type* and choose the type of file to recall.

Data Type: Memory Data, Setup Data,
 Preset Data, NSeq, FSeq

5. Select *Recall File* and choose a filename.
 - Turn the scroll wheel to increase/decrease the file number.

Memory: Model_file number.M
 Setup Memory: Model_file number.S
 Preset: Model_file number.P
 NSeq: Model_file number.N
 FSeq: Model_file number.F

6. Press *Recall[F4]* to recall.
 - Recall Ok will be displayed when the recall has been completed.

File Utilities	<p>7. Press <i>File Utility</i>[F5] to access the file utility. See page 109 for details.</p> <ul style="list-style-type: none"> • Change the USB path. • Rename files or create directories.
----------------	---



Caution

If “Machine Type Error” is displayed it indicates that the file that you are trying to recall originated from a different model. You can only recall files from the same model.

Recall Memory Safety Setting

Description	By default when you try to recall <i>preset settings</i> from internal memory, a message will appear asking you to press the Enter key to confirm. This is the standard safety measure to ensure that the wrong setting is not recalled. This safety measure can be disabled by setting the Mem. Recall setting to “Direct”.
Operation	1. Press  > <i>Configure</i> [F5] > <i>Other</i> [F2] and set the <i>Mem. Recall</i> setting.

Range: Safety, Direct



Note

This setting only applies when recalling preset settings from internal memory, either by using the Presets keys (P0 - P9) or by using the File menu. See page 111 and 106.

File Utility

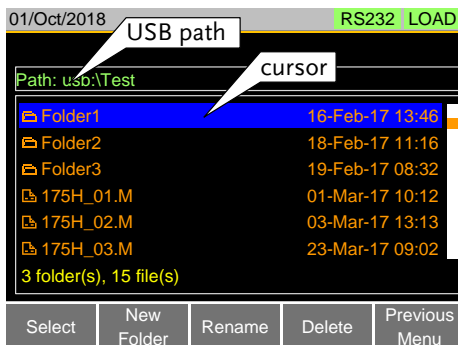

Description	<p>The file utility allows you to create new folders, rename files and set the USB path directory.</p> <p>It is only available for use with the USB external memory.</p>
-------------	--

Display

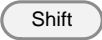

Access the File Utilities Menu

1. Insert a USB drive into the USB port.

2. Press  +  > *File Utility*[F5].
 - The file utilities screen appears.

Create a new Folder

1. Press *New Folder*[F2] to create a new folder.
 - Use the on-screen display to enter the filename.
 - A maximum of 8 characters.

Rename a Folder

1. Use the scroll wheel to move the cursor to the file/folder you wish to rename.
2. Press *Rename*[F3].
 - Use the on-screen display to enter the filename.
 - A maximum of 8 characters.

Delete File or Folder

1. Use the scroll wheel to move the cursor to the file/folder you wish to delete.
2. Press *Delete*[F4].
3. Press *Delete*[F4] again to confirm the deletion.



Preset

The Preset key is used to save and recall preset settings from the front panel quickly. The presets have the same contents as memory data, this includes the operating mode, range, configuration settings and Go-NoGo settings.

Quick Preset Save

Description The current settings can be saved to P0 - P9 using the Preset key and the number pad.





Operation

1. Press  and hold  -  until a beep is heard.
 - The beep indicates that the setting was saved to the selected preset.

Quick Preset Recall

Description Presets P0 to P9 can be recalled quickly by using the Preset key and the number pad.

Operation



1. Press  +  - .
2. Press  to confirm the recall when a popup window appears.
3. Press  again to deactivate the preset key.

Default Settings

Factory Default Settings

Description The factory default settings can be recalled at any time. See page 241 for a list of the factory default settings.



Operation

1. Press  + .
2. Select Default with the *Media[F1]* soft-key.
3. Press Factory Default[F2].
4. Press *Factory Default[F2]* again to confirm.

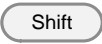

User's Default Setting

Description The currently active settings can be set as the "User's Default" settings.

Save User's Default Setting

1. Press  + .
 2. Select *Default* with the *Media[F1]* soft-key.
 3. Press Save[F3].
 - The User's Default is saved immediately.
-

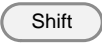
Recall User's Default Setting

1. Press  + .
2. Select *Default* with the *Media[F1]* soft-key.
3. Press Recall[F4].
4. Press *Recall[F4]* again to confirm.
 - A User's Default must be saved first before it can be recalled.

F FUNCTION MENU

Function Menu Overview	114
Select a Function	114
Turning on the Load with the Selected Function	116
Complete Ring Time	117
NSEQ Timer	118
Program	120
Program Overview	120
Create a Program	122
Create a Program Chain	125
Running a Program or Chain	126
Sequence	128
Normal Sequence Overview	128
Timing Edit Configuration	132
Data Edit Configuration	134
Running a Normal Sequence	135
Fast Sequence Overview	138
Timing Edit Configuration	142
Data Edit Configuration	143
Running a Fast Sequence	145
OCP Test Automation	147
OPP Test Automation	154
BATT Test Automation	160

Function Menu Overview

The Function menu can be used as a quick access hub to the Program, Normal Sequence, Fast Sequence, OCP, OPP or BATT menus.

It is also used to set Function specific settings:

- Function Select.
- Complete Ring Time.
- NSEQ Timer.

Select a Function

Description The Function Select option is used to turn a Program, Normal Sequence, Fast Sequence, OCP, OPP or BATT Test function on or off. Before one of these functions is turned on, they should be configured beforehand. See page 120, 128, 147 to configure Programs, Sequences or the OCP function, respectively.

Function Select Screen

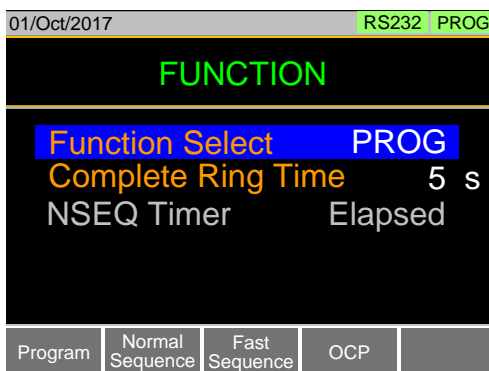

Operation

1. Press  .
2. Select *Function Select* and choose a function to

turn on or choose to turn off the last function.

Range OFF, PROG, NSEQ, FSEQ, OCP





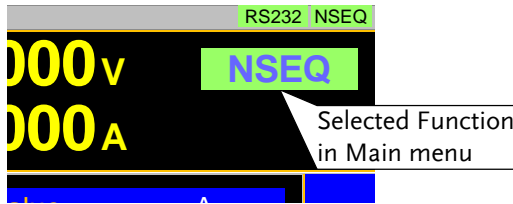

Note

- After a function is selected, it is then “turned on”.
- **PROG**, **NSEQ**, **FSEQ**, **OCP**, **OPP** or **BATT** will appear at the top of the display when the selected function is on.
- When in the Main menu, the **PROG**, **NSEQ**, **FSEQ** or **OCP** icon will appear prominently on the display to remind the operator that a function is still on. A normal load cannot be turned on when a Function mode is turned on.

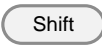

- Be sure to turn the selected function off to return to normal operation.

Turning on the Load with the Selected Function

- Description
- When a function is turned on, the load can be turned on (with the selected function) by pressing  + . This can be done at anytime.
 - The  key will turn orange when the load is "on".
 - The load can be turned off again by pressing the  key.
 - The **PROG**, **NSEQ**, **FSEQ** or **OCP** icon turns orange when the load is turned on.
 - The selected function will need to be turned off before a "normal" load operation can be performed.

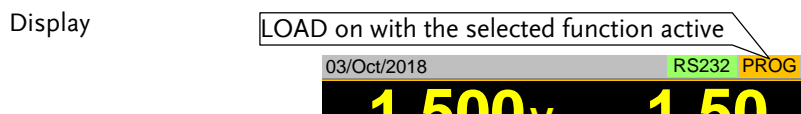

Complete Ring Time

Description The Complete Ring Time function turns the alarm on for a user-set amount of time after a program, sequence or OCP function has finished.

Function Select Screen

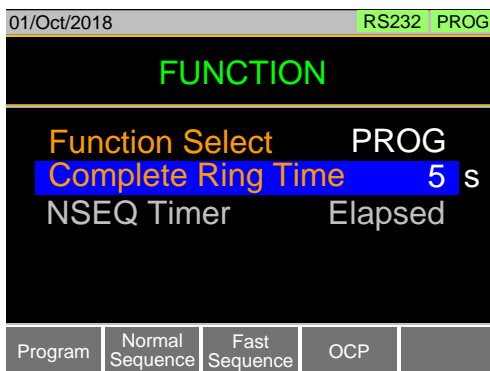

Operation

1. Press .
2. Select *Complete Ring Time* and select how long the alarm should ring after a function has completed.

Range OFF, 1 ~ 600s, Infinity

Default Off

- The Complete Ring Time setting applies to all the functions.



Note

The alarm may not sound if Alarm Tone is turned off in the Utility>Other menu. See page 93 for setting details.

NSEQ Timer

Description The NSEQ Timer setting determines whether the timer for the Normal Sequence function displays the elapsed time or the remaining time for both the current step and the overall test time for the sequence.

Function Select Screen

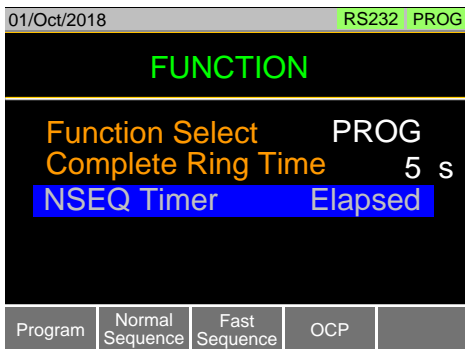

Operation

1. Press  .
2. Select *NSEQ Timer* and select whether the current step and total test time is displayed as elapsed time or remaining time.

Range	Elapsed, Remaining
Default	Elapsed

Display example

The screenshot shows a test equipment display with the following information:

- Top left: 01/Oct/2018
- Top right: RS232 NSEQ
- Center: 0.000v, 0.00w, 0.0000A, 0:00:05
- Bottom left: Run N.Sec 0:00:05
- Bottom right: Seq. No: 01, Step: 0001
- Bottom left button: Continue

Callouts on the screen:

- Callout 1 (pointing to 0:00:05): Elapsed or remaining time for the total test time
- Callout 2 (pointing to 0:00:05): Elapsed or remaining time for the current step

Note

When the total test time is >1000 hours, then the total test time will always be displayed as the elapsed time.

Program

The PEL-3000(H) can create programs that are designed to step-through up to 16 pre-set load operations. The program function is a powerful tool that can allow you to perform a number of different operations in succession.

- The execution time of each step is user-defined.
- Programs can be chained together to make larger programs.
- Up to 16 programs can be created for a program chain.

See page 100 for saving load operations.

Program Overview

Description	<p>When you run a program, you are essentially executing up to 16 different load operations consecutively. Each of the different load operations are “steps” in the program. A program starts at step 01 and ends at step 16.</p> <ul style="list-style-type: none">• A program recalls the operating mode, range, static/dynamic mode, response speed and other settings of each step from stored memory. It also recalls the Go-NoGo settings.• The same memory settings can be used for multiple steps.• The execution time of each step is configurable.• Applies the Go-NoGo settings for each step.• Each step must be executed in order.• Each step can be configured to automatically go to the next step or wait for confirmation from the user before proceeding to the next step.• Individual steps can be skipped.• Programs can be linked together to make program chains.
-------------	--

- Program chains need not be executed in order.
- There are 16 steps to a program.
- There are up to 16 programs to a chain.

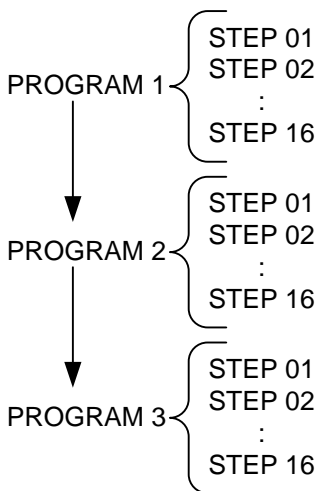

Setting Overview A program contains the following settings for each step:

- **Memory:** the memory location of the load operation for the selected step (M001-M256).
- **Run:** Designates the run setting for the step (Auto, Manual, Skip).
- **On-Time:** Sets the run time of the test.
- **Off-Time:** Sets the off time between steps.
- **P/F-Time:** Sets the testing pass/fail delay time for Go/No Go testing.
- **Short-Time:** Sets the shorting time for the step, if any.

Timing Diagram for Single Step Below is a timing diagram of a single step in a program.

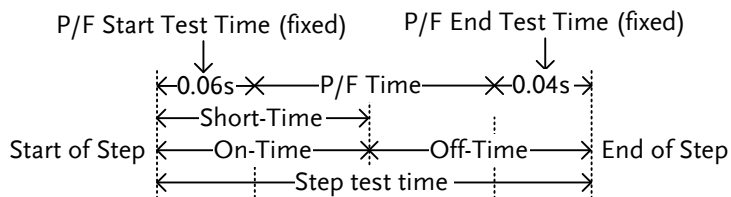

Create a Program



Note

Before creating a program, the settings for each step must first be created and saved to internal memory (M001-M256). See the save recall chapter for further details, page 100.

Program Setting
Display Overview

The screenshot shows the 'Timing Edit for Program' screen. The display is divided into several sections:

- Top Section:** Shows 'PROG: 01' and 'STEP: 01'. Callouts point to 'Program number' and 'Step number in selected program'.
- Middle Section:** Displays settings for 'Memory M001', 'Run: Skip', 'On-Time: 0.1', 'Off-Time: Off', 'P/F-Time: Off', and 'Short-Time: Off'.
- Bottom Section:** Shows navigation buttons: 'Program Off', 'Cl', 'Program settings', 'Recall Default', and 'Program settings'.

Operation

- Press **FUNC** > *Program*[F1].
 - Note that *Program*[F1] is off by default.
- Select *PROG* and select a program number to edit.

PROG 01 - 16

- Select a *STEP* in the selected program.

STEP 01 - 16

4. Select *Memory* and select which memory location to load for the selected step.
 - Settings loaded from the memory location will be used for the selected step.
 - The same memory location can be used for multiple steps.

Memory M001 - M256

5. Set the *Run* setting for the step.
 - By default RUN is set to Skip.
 - The Auto setting will automatically start and go onto the next step.
 - The Manual setting will wait for the user to press *Next[F2]* before running the step.

Run Skip, Auto, Manual

6. Choose the *On-Time* in seconds.
 - The on-time setting determines how long the load is turned on for the selected step.
 - The on-time is defined as the total test time minus the off-time.

On-Time 0.1 - 60 seconds

7. Choose the *Off-Time* in seconds.
 - The off-time setting determines how long the load is turned off between the end of the current step and the start of the next step.
 - The off-time is defined as the total test time minus the on-time.

Off-Time Off, 0.1 - 60 seconds

8. Choose the *P/F-Time* (pass/fail time) in seconds.
 - The P/F-Time refers to the P/F delay time. This delay time includes the 0.06 P/F start test time, as shown in the timing diagram on page 121.

P/F-Time Off, 0.0 - 119.9 seconds

9. Set the *Short-Time* in seconds.

- Has the same action as pressing the short key.
See page 62 for details about shorting the load.
-

Short-Time Off, 0.1 seconds - On-Time

10. Repeat steps 3 to 9 for all the steps in the program.

- A maximum of 16 steps per program can be created.
- Steps that are not configured are set to "Skip" by default.

11. Press *Save[F3]* to save the program and all the steps in the program.

- The program will be saved to internal memory.
 - See the *Save/Recall* chapter on details on how to save to Setup memory.
-

Recall Default

12. Pressing *Recall Default[F4]* will recall the default settings for each program/step. See page 241 for details.

Create a Program Chain



Note

Before creating a program chain, make sure a number of programs have already been saved. These will be used to create the program chain.

Chain Setting
Display Overview

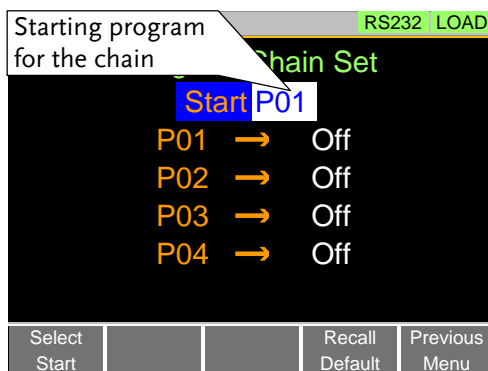

Operation

1. Press **FUNC** > *Program*[F1] > *Chain*[F2].
 - It may be necessary to load the programs from Setup memory if they were not created in the current session.
2. If *Start* is not selected yet, press *Select Start*[F1] and select which program will be used to start the program chain.

Start: P01 - P16

3. Select *P01* and choose which program will be linked to *P01*.
 - Selecting OFF will end the chain after *P01*.
 - Selecting *P01* will create an infinite chain.
 - Chains need not be linked in sequential order.

P01: OFF, P01 - P16

4. Repeat step 3 for any remaining programs in the chain.

5. Press *Save* to save the program chain to internal memory.
6. Pressing *Recall Default*[F4] will reset the chain to the default settings. See page 241 for details.
 - Recall Default[F4] will essentially clear the program chain.

Running a Program or Chain

Description	A program or program chain is run the same way as a normal load.
-------------	--

- | | |
|-----------|---|
| Operation | <ol style="list-style-type: none"> 1. Press  > <i>Program</i>[F1]. 2. Turn program mode on by setting <i>Program</i>[F1] to On. <ul style="list-style-type: none"> • PROG will appear at the top of the display when <i>Program</i> is On. 3. Turn the load on. <ul style="list-style-type: none"> • The program/chain starts immediately. • The PROG icon turns orange when the load is turned on. 4. When a program/chain is running the screen displays which program, step and memory is currently active. <ul style="list-style-type: none"> • Press <i>Pause</i>[F1] to suspend a test, press <i>Continue</i>[F1] to resume. • Press <i>Next</i>[F2] to run the next step if its <i>Run</i> setting was set to <i>Manual</i>. 5. When a program/chain has finished running, a list of the Go-NoGo results for each step are displayed. <ul style="list-style-type: none"> • Press <i>Exit</i>[F5] to exit. |
|-----------|---|

Display:
Program/Chain
Running

01/Oct/2018 RS232 PROG

0.000V 0.00W

0.0000A

Run Program

Program No: 01

Step(Memory) 01(001) GO

Conti

Step that is currently running.

Memory number of current step.

Go-NoGo result for the step

Display:
Program/Chain
Finished

03/Oct/2018 RS232 PROG

Run Program Detail Result

Program	Step	Result
1	1	GO
1	2	GO
1	3	NG

Exit

Sequence

The PEL-3000(H) supports both programs and sequences. The essential difference between programs and sequences is that programs can use different operating modes for each step while sequences use the same operating mode throughout the whole sequence. In effect sequences are used to create complex load simulations.

There are two different types of Sequences, Normal Sequences and Fast Sequences.

Normal sequences can define the execution time and slew rate of each step.

On the other hand the execution time for each step in a fast sequence is fixed to the rate (Time Base setting) set by the user.

Normal Sequence Overview

Description	<p>A normal sequence is comprised of a user-defined number of steps that when executed in sequence can be used to simulate a DC load.</p> <ul style="list-style-type: none">• Up to 1000 discrete steps can be configured using normal sequences.• Each normal sequence can have a memo note attached to it.• Normal Sequences can be looped up to 9999 discrete times or for an infinite amount of times.• Normal sequences can be configured to hold a set voltage, current, power or resistance at the end of the load.• Normal Sequences can be linked together in a chain.
-------------	---

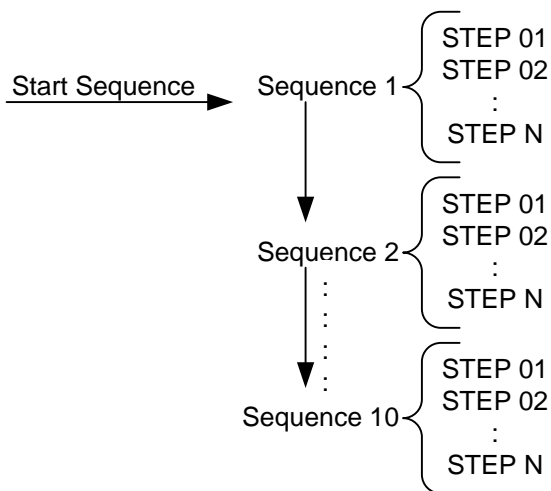

Description Normal Sequence configuration is split into Timing Edit configuration and Data Edit configuration.

Timing Edit configuration is used to configure the actual sequences, such as mode, range, loops and chains.

Data Edit configuration is used to create the actual steps used in each sequence.

See below for a description of each.

Timing Edit Overview A Normal Sequence contains the following timing settings for each sequence:

Setting	Setting Range	Description
Start	S01 - S10	Sets which sequence is used to start a chain of Normal Sequences.
Seq.No	S01 - S10	Sets the current sequence to edit.

Memo	12 characters	A user-created note for the currently selected sequence.
Mode	CC, CR, CV, CP	Operating mode for the sequence. +CV mode is supported.
Range	ILVL	Low I range, low V range
	IMVL	Middle I range, low V range
	IHVL	High I range, low V range
	ILVH	Low I range, high V range
	IMVH	Middle I range, high V range
	IHVH	High I range, high V range
Loop	Infinite, 01 - 9999	Sets the amount of times to loop the selected sequence.
Last Load	OFF, ON	Set the load condition after the end of the sequence.
Last	Value	The setting value of the load for when Last Load = ON.
Chain	Off, S01-S10	Sets the next sequence in the chain, when not set to off.

Data Edit Overview Each step in a normal sequence contains the following setting parameters:

Setting	Setting Range	Description
Step	0001 - 1000	<p>Selects/displays the current step in the sequence.</p> <ul style="list-style-type: none"> The number of available steps is dependent on the number of steps added using the <i>Insert Point</i>[F1] functions.

Value		The current, voltage, power or resistance setting for the selected operating mode.
Time	0.05ms - 999h:59m	Sets the step time for the selected step.
Load	ON, OFF	Turns the load on or off for the selected step.
RAMP	ON, OFF	When turned on the current transition is evenly ramped from the start of the step to the end of the step. When turned off the current transition is stepped.

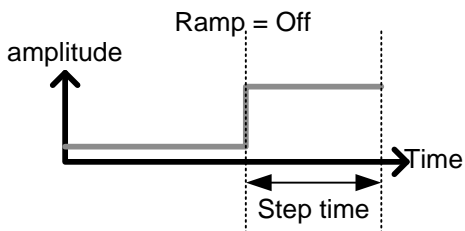
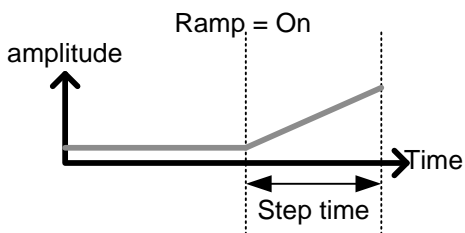

TRIG OUT	ON, OFF	When TRIG OUT is set to ON, a trigger signal is output from the TRIG OUT BNC terminal at the start of the step. See page 201 for details.
----------	---------	---

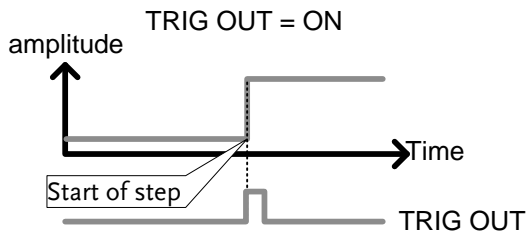

PAUSE	ON, OFF	Pause: Inserts a pause at the end of the step. When paused, the unit will pause at the end of the step current/voltage/resistance/power level. The sequence can be resumed by pressing <i>Next</i> [F2] or by using an external trigger signal (page 199).
-------	---------	--

Timing Edit Configuration

Edit Timing Display

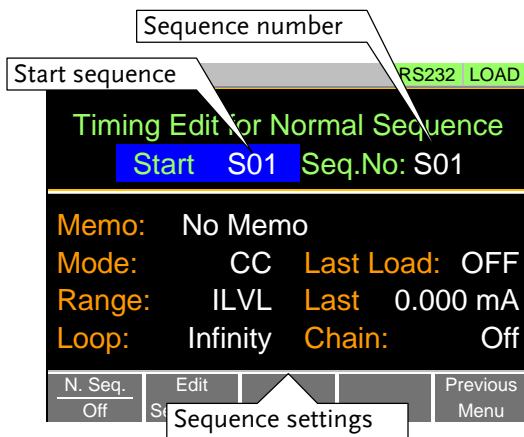

Operation

1. Press **FUNC** > *Normal Sequence*[F2].
 - Note that *N. Seq.*[F1] is off by default.
2. Select *Start* and select the number of the starting sequence.

Start: S01 - S10

3. Select a *Seq. No.* and select which sequence to edit.
-

Seq. No.: S01 - S10

4. Set the following parameters for the currently selected sequence. See page 128 for details on each parameter.

- Memo
- Mode
- Range
- Loop
- Last Load
- Last
- Chain

5. Press *Save[F3]* to save the timing settings for the currently selected sequence.

Sequence Timing configuration is complete.

- Go to Data Edit to edit the steps used in the Normal Sequences. See page 134.
- Go to Running a Normal Sequence to run the normal sequence. See page 135.

Data Edit Configuration

Data Edit Display

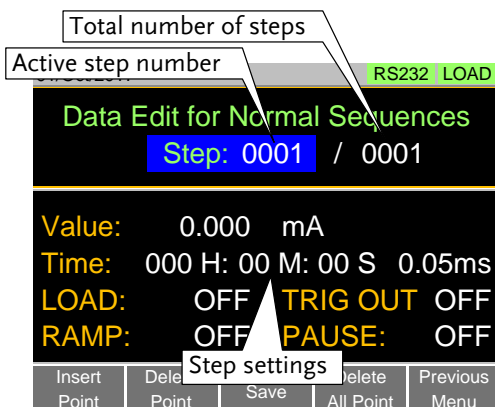

Operation

1. Press **FUNC** > *Normal Sequence*[F2] > *Edit Sequence*[F2].
2. Select *Seq.No.* and select the sequence you wish to edit.

Start: S01 - S10

3. Press *Edit Sequence* [F2] to enter the Data Edit configuration menu.
 - Note that when there no steps in the current sequence the Data Edit for Normal Sequence settings are blank.
4. Press *Insert Point*[F1] to add a step to the sequence after the current step.
 - Every time *Insert Point* is pressed the *Step* parameter is incremented.
 - The inserted point becomes the current step.
5. Set the following parameters for the currently selected step. See the Data Edit Overview on page 130 for configuration details.
 - Value

- Time
 - LOAD
 - RAMP
 - TRIG OUT
 - PAUSE
6. If you wish to edit a previously inserted point/step, use the *Step* parameter.
 - Steps can only be selected after they have already been inserted.

Steps 0001 - 1000

7. The currently selected step can be deleted using the *Delete Point*[F2] function.
8. After all the steps for the sequence are complete, press *Save*[F3] to save the steps.

Data Edit for Normal Sequence configuration is complete.

- Go to Timing Edit for Normal Sequences to edit the sequence. Page 132.
 - Go to Running a Normal Sequence to run the normal sequence. Page 135.
-

Running a Normal Sequence

Description Unlike a normal static or dynamic load, a load created with the Normal Sequence function is turned on by pressing the Shift and Load keys.

Operation 1. Press  > *Normal Sequence*[F2].



2. Turn normal sequence mode on by setting *N. Seq.*[F1] to *On*.

- **NSEQ** will appear at the top of the display when *N. Seq.* is *On*.

- The Normal Sequence function can also be turned on from the FUNC menu. See page 114 for details.

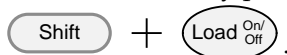
3. Turn the load on by pressing



- The  key will turn orange when the load is "on".
 - The load can be turned off again by pressing the  key.
 - The normal sequence/chain starts immediately.
 - The **NSEQ** icon turns orange when the load is turned on.
4. When a normal sequence/chain is running, the screen displays which sequence, step and loop are currently active. It also displays the elapsed or remaining test time and elapsed/remaining time of the current step.
- Sequences can be paused by pressing Pause [F1] and resumed again by pressing Continue [F1].
 - If no steps have been created "No N.Seq." will be displayed on the screen.
 - "Sequence Complete" will be displayed at the end of the sequence.
-

Display:
Sequence/Chain
Running

01/Oct/2018

Current step readback measurements

RSZ3Z NSEQ

0.000V 0.00V

0.0000A 0:00:46

Run N.Seq. 0:00:05

Seq. No: 01

Step: 0003

Loop: 0001

Elapsed or remaining time for the total test time

Current sequence, step and loop number

Step elapsed/remaining time

 Note

The combined test time for all sequences will be displayed as *elapsed test time* if the elapsed time is >1000 hours, else the *remaining test time* will be displayed.

Fast Sequence Overview

Description A fast sequence is comprised of a user-defined number of steps that can be executed at a high frequency. Unlike normal sequences, each step in a fast sequence has the same execution time (time base).

- This mode is only available for CC and CR mode.
- Up to 1000 discrete steps can be configured using fast sequences.
- Each fast sequence can have a memo note attached to it.
- Fast Sequences can be looped up to 9999 discrete times or for an infinite amount of times.
- Fast sequences can be configured to hold a set current or resistance at the end of the load.
- No ramping function can be used with the Fast Sequence function.

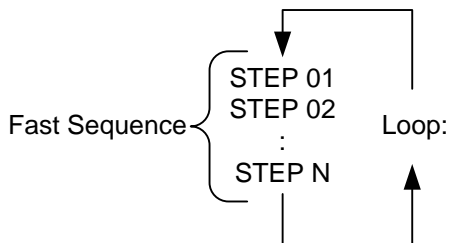

Description Fast Sequence configuration is split into Timing Edit configuration and Data Edit configuration.

Timing Edit configuration is used to configure all the settings that are common to all the steps of the fast sequence. This includes settings such as the mode, range, loops and time base.

Data Edit configuration is used to create the actual steps used in each sequence.

See below for a description of each.

Timing Edit Overview A Fast Sequence contains the following timing settings for each sequence:

Setting	Setting Range	Description
Memo	12 characters	A user-created note for the currently selected sequence.
Mode	CC, CR	Operating mode for the sequence.
Range	ILVL	Low I range, low V range
	IMVL	Middle I range, low V range
	IHVL	High I range, low V range
	ILVH	Low I range, high V range
	IMVH	Middle I range, high V range
	IHVH	High I range, high V range
Loop	Infinity, 01 - 9999	Sets the amount of times to loop the selected sequence.
Last Load	OFF, ON	Set the load condition after the end of the sequence.
Last	0.000000	The load setting for when Last Load is set to ON.

RPTSTEP	0001 - 1000	Last step number (0001-1000) per loop
Time Base	0.025 - 600ms	Sets the step execution time.
Data Edit Overview	Each step in a fast sequence contains the following setting parameters:	

Setting	Setting Range	Description
Step	0001 - 1000	<p>Selects/displays the current step in the sequence.</p> <ul style="list-style-type: none"> The number of available steps is dependent on the number of steps added using the <i>Ins. Point[F1]</i> functions. A minimum of 3 steps.
Value		The current or resistance setting for the selected operating mode.
TRIG OUT	ON, OFF	When TRIG OUT is set to ON, a trigger signal is output from the TRIG OUT BNC terminal at the start of the step. See page 201 for details.

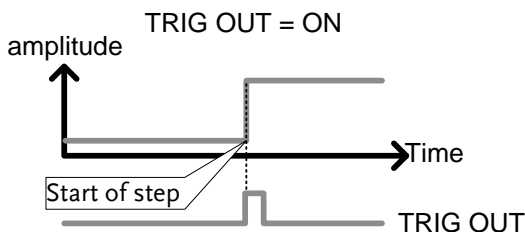

FILL Overview	The FILL function is used to evenly step up the current or resistance value settings from a starting step to a finishing step.
---------------	--

The Fill Function can be used before or after points are added to the fast sequence.

- Before: Will pre-fill each value within the fill range when a new step is added.
- After: Will post-fill each value within the fill range.

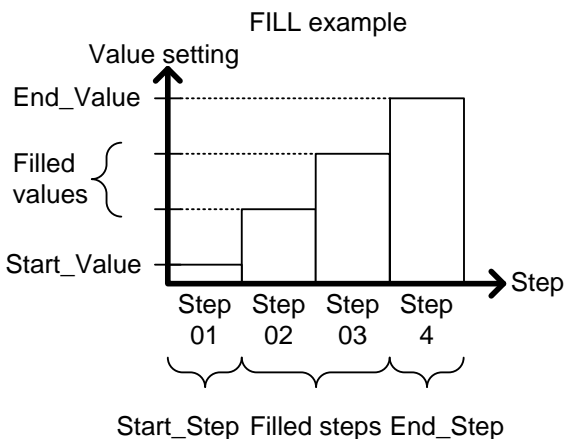

Setting	Setting Range	Description
Start_Value		Sets the current or resistance value for the starting step.
End_Value		Sets the current or resistance value for the ending step.
Start_Step	0001 - 1000	Sets the starting step number.
End_Step	0001 - 1000	Sets the ending step number.

Timing Edit Configuration

Edit Timing
Display

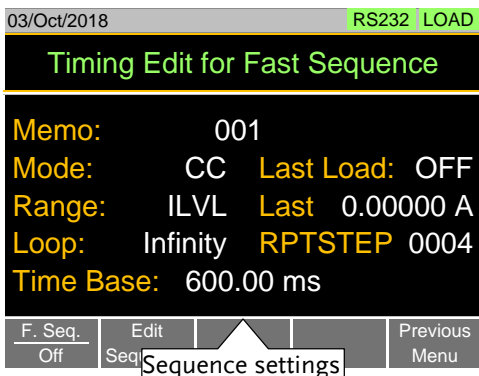

Operation

1. Press **FUNC** > *Fast Sequence*[F3].
 - Note that *F. Seq.*[F1] is off by default.
2. Set the following parameters for the fast sequence. See page 137 for details on each parameter.
 - Memo
 - Mode
 - Range
 - Loop
 - Time Base
 - Last Load
 - Last
 - RPTSTEP

Save

3. Press *Save*[F3] to save the timing settings for the fast sequence.

Sequence Timing configuration is complete.

- Go to Data Edit to edit the steps used in the Fast Sequence. Page 143.
- Go to Running a Fast Sequence to run the fast sequence. Page 145.

Data Edit Configuration

Data Edit Display

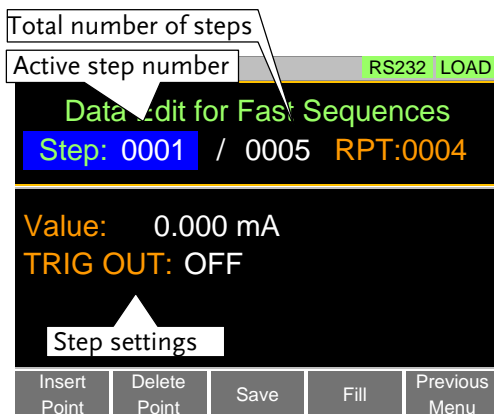

FILL Display

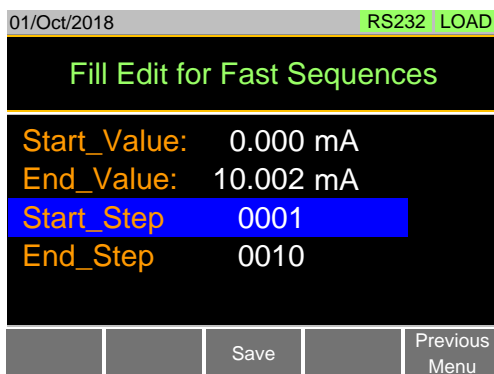

Operation

1. Press **FUNC** > *Fast Sequence*[F3] > *Edit Sequence*[F2] to enter the Data Edit configuration menu.
2. Press *Insert Point*[F1] to add a step to the

sequence.

- Every-time *Insert Point* is pressed the *Step* parameter is incremented.
 - The newly inserted “point” becomes the active step.
3. Set the following parameters for the currently selected step. See page 137 for configuration details.
 - Value
 - TRIG OUT
 4. If you wish to edit a previously added point/step, use the *Steps* parameter.
 - Steps can only be selected after they have already been added.

Steps 0001 - 1000(RPTSTEP)

5. The currently selected step can be deleted using the *Delete Point[F2]* function.
 - There cannot be less than 3 steps for fast sequences.
-

Fill Function

6. Press *FILL[F4]* to use the fill function. Set the fill parameters:
 - Start_Value
 - End_Value
 - Start_Step
 - End_Step

The fill function can be used any number of times.





Save

7. After all the steps for the sequence are complete, press *Save[F3]* to save the steps.

Data Edit for Fast Sequences configuration is complete.

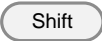
- Go to Timing Edit for Fast Sequences to edit the sequence. Page 142.
- Go to Running a Fast Sequence to run the fast sequence. Page 145.

Running a Fast Sequence

Description	Unlike a normal static or dynamic load, a Fast Sequence load is turned on by pressing the Shift and Load keys.
Operation	<ol style="list-style-type: none"> 1. Press  > <i>Fast Sequence</i>[F3]. 2. Turn fast sequence mode on by setting <i>F. Seq.</i>[F1] to <i>On</i>. <ul style="list-style-type: none"> • FSEQ will appear at the top of the display when <i>F. Seq.</i> is <i>On</i>. 3. Turn the load on by pressing  + . <ul style="list-style-type: none"> • The  key will turn orange when the load is “on”. • The load can be turned off again by pressing the  key. • The fast sequence/chain starts immediately. • The FSEQ icon turns orange when the load is turned on. 4. When a fast sequence is running, the screen displays which step and loop is currently active. <ul style="list-style-type: none"> • “<i>Sequence Complete</i>” will be shown on the display at the end of the sequence.

Display:
Fast Sequence
Running

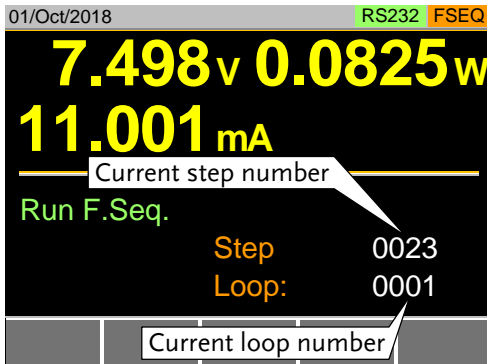

OCP Test Automation

Background The OCP test function creates an automatic test to test the OCP of power supply products.

This test will test to see when the over current protection of a power supply is tripped and return the measurements for the voltage and current when the over current protection was tripped. The PEL-3000(H) also has a user-defined cutoff setting in the event that the power supply OCP fails.

The diagram below shows an example of the OCP Test Automation function:

Example The test current increases from a starting value (Start C) to an end value (End C). The current increases in steps (set by Step_C) with a set step time (set by Step_T) until the power supply's OCP is tripped or the End C current level is reached.

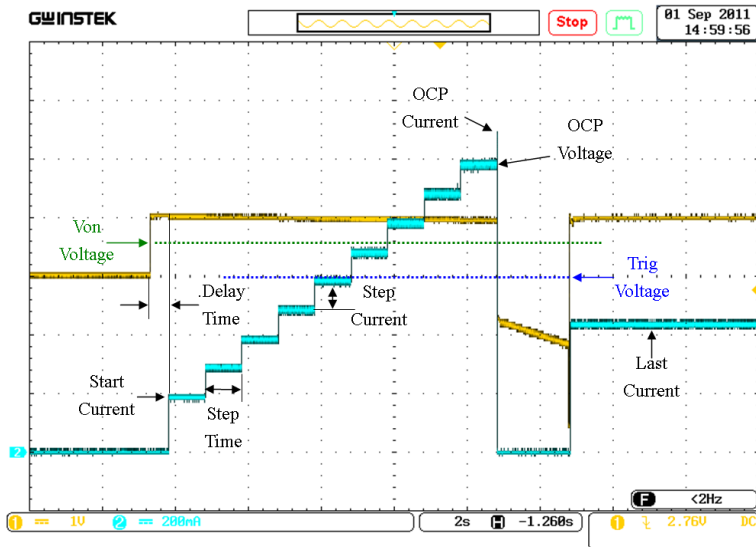

Parameters	OCP. No	Selects one of 12 OCP test setup memories.
	Memo	A user-created note for the currently selected OCP function.
	Range	High(CC Mode High), Middle(CC Mode Middle) and Low(CC Mode Low)
	Start Current (Start C)	Starting current value for the test.
	End Current (End C)	The current value that will end the test. The value must be higher than the OCP value of the DUT you are testing. This parameter is used as a fail-safe for if the over current protection of the DUT fails. If the measured current is reaches End Current value it would then indicate that the power supply OCP failed.
	Step Current (Step_C)	Sets the step resolution of the current.
	Step Time (Step_T)	Sets the execution time of each step. (50ms ~ 1600s)
	Trig Delay Time (Delay)	Sets a delay corresponding to the time a Trig Voltage can be expected after each step Current is applied (the delay time must be less than the Step time). (0ms ~ 160s)

Trig Voltage (Trig_V)	Sets the trigger to a level needed to see when the power supply OCP has been triggered. When the power supply OCP has been triggered, its voltage output will reset. The voltage trigger level is used to test to see if the voltage output has been reset.
Last Current (Last_C)	Sets the final current value after OCP has been tripped. This is the steady-state current draw after the OCP has been tripped.



Note

This mode can only be used under CC mode.

Panel operation

- Press **FUNC** > *OCP[F4]*.

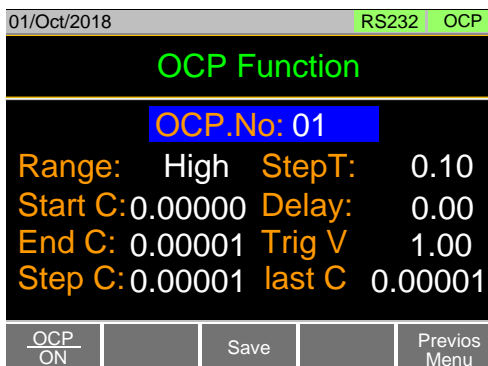



- Select Channel
 - Select *OCP, No:* and select a test setup memory.

OCP, No: 1 ~ 12

-
3. Set the following parameters for the selected test setup above:
 - Memo
 - Range
 - Start C
 - End C
 - Step_C
 - Step_T
 - Delay
 - Trig_V
 - Last_C
 4. Press the *Save[F3]* to save the selected test setup.
-

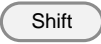
Start OCP

5. Press *OCP[F1]* to turn the OCP function on if it is off.
 6. The OCP function can be started by turning the load on by pressing  +  .
 - The test current will increase from the Start C value to the End C value in steps according to the Step C value, until the test has finished.
 - The test will start running when the power supply voltage is greater than the Trig V voltage.
-

Example: OCP
Function running

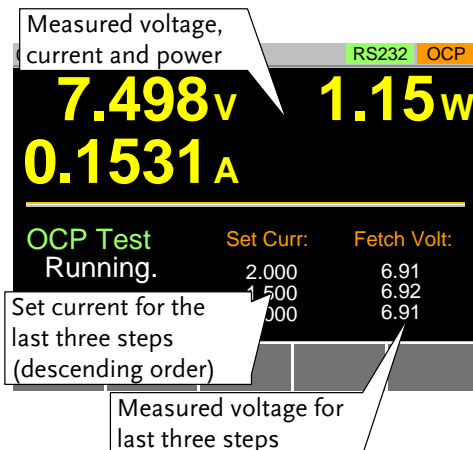

Results:

Power Source
OCP tripped

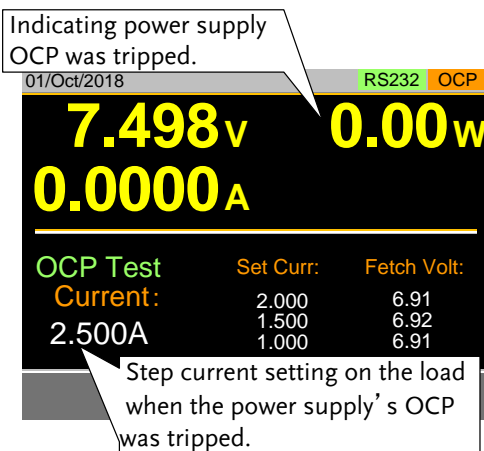

The OCP Test will return the current setting of the last step when the power supply's OCP was tripped.

Power Source
OCP time out

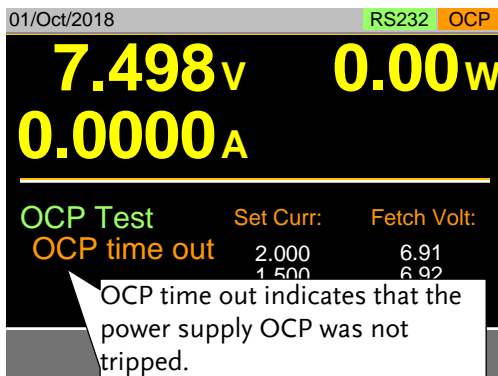

OCP time out will occur if the power supply's OCP fails to trigger. This is determined when the measured voltage is less than Trig V and the measured current is greater than End C.

Power Source
Config Error

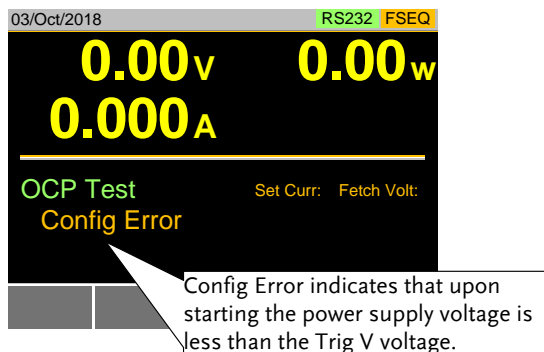

Config Error indicates that the power supply voltage is less than the Trig V voltage setting after the test has started. This can indicate that the power supply output is not on or that the power supply output or Trig V is incorrectly configured.

Note

In addition to the OCP settings as described above, the Trig voltage settings must also be set according to the output characteristics of the DUT.

Save Data

When the Power Source OCP was tripped. Press TEST Result [F1] to view the test result waveform.

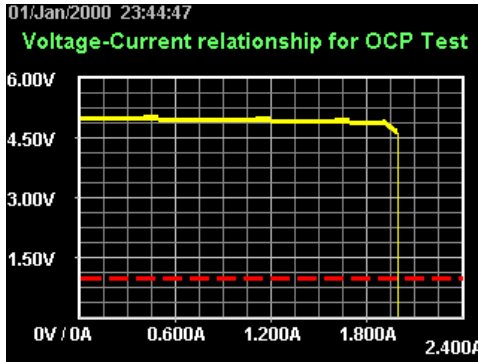

Plug in USB flash drive and press Save [F3] to save the waveform picture.

Press Esc [F1] to exit the waveform view mode.

Press Save [F3] to save the data log to USB flash drive. The file name should be RESULTxx.CSV. The file RESULTxx.CSV can be opened in the computer.

The maximum amount of data to be recorded in the data log is 65536. If data exceeds this limit, the extra data won't be recorded.

	A	B	C	D	E	F
1	<< OCP TEST >>			PEL-3021	v1.32	
2	< PARAMETER of OCP TEST >					
3		OCP No.:		1		
4		(1) Memo:				
5		(2) Range:	Middle			
6		(3) Start Curr:	0.001 A			
7		(4) End Curr:	3.000 A			
8		(5) Step Curr:	0.100 A			
9		(6) Step Time:	0.05 s			
10		(7) Delay Time:	0.00 s			
11		(8) Trig Volt:	1.00 V			
12						
13	< TEST RESULTS >					
14		Start Time:	2000/1/1 23:44			
15		End Time:	2000/1/1 23:44			
16		(1) Test Result:	Complete	OCP :	2.001 A	
17						
18		(2) DATA LISITS(22):				
19		Step No	VOLT(V)	CURR(A)	POWER(W)	
20			0	4.98	0.011	0.05478
21			1	4.98	0.01	0.0498
22			2	4.98	0.103	0.51294
23			3	4.97	0.202	1.00394
24			4	4.96	0.303	1.50288
25			5	4.96	0.403	1.99888

OPP Test Automation

Background

The OPP test function creates an automatic test to test the OPP of power supply products.

This test will test to see when the over power protection of a power supply is tripped and return the measurements for the voltage and current when the over power protection was tripped. The PEL-3000(H) also has a user-defined cutoff setting in the event that the power supply OPP fails.

The diagram below shows an example of the OPP Test Automation function:

Example

The test watt increases from a starting value (Start W) to an end value (End W). The watt increases in steps (set by Step_W) with a set step time (set by Step_T) until the power supply's OPP is tripped or the End W watt level is reached.

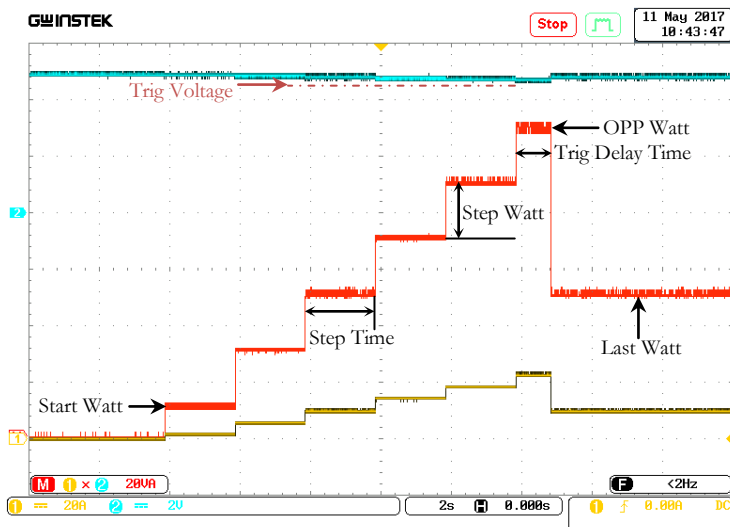

Parameters	OPP. No	Selects one of 12 OPP test setup memories.
	Memo	A user-created note for the currently selected OPP function.
	Range	High(CP Mode High) Middle(CP Mode Middle) Low(CP Mode Low)
	Start Watt (Start W)	Starting watt value for the test.
	End Watt (End W)	The watt value that will end the test. The value must be higher than the OPP value of the DUT you are testing. This parameter is used as a fail-safe for if the over power protection of the DUT fails. If the measured watt is reaches End Watt value it would then indicate that the power supply OPP failed.
	Step Watt (Step W)	Sets the step resolution of the watt.
	Step Time (Step T)	Sets the execution time of each step. (50ms ~ 1600s)
	Trig Delay Time (Delay)	Sets a delay corresponding to the time a Trig Voltage can be expected after each step Watt is applied (the delay time must be less than the Step time)(0ms~160s).

Trig Voltage (Trig V)	Sets the trigger to a level needed to see when the power supply OPP has been triggered. When the power supply OPP has been triggered, its voltage output will reset. The voltage trigger level is used to test to see if the voltage output has been reset.
Last Watt (Last W)	Sets the final watt value after OPP has been tripped. This is the steady-state watt draw after the OPP has been tripped.

Panel operation

1. Press **FUNC** > *Next Manu*[F5]. > *OPP*[F1].

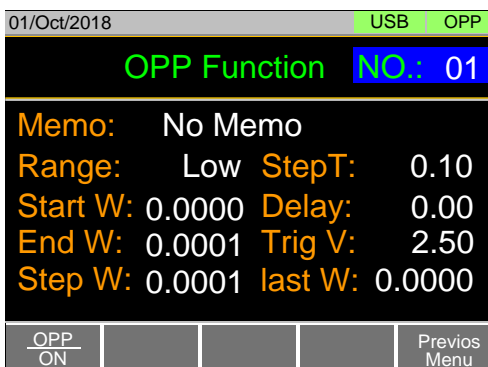

2. Select *OPP. No.*: and select a test setup memory.
 OPP. No: 1 ~ 12

3. Set the following parameters for the selected test setup above:
 - Memo
 - Range
 - Start W
 - End W
 - Step W
 - Step T
 - Delay
 - Trig V
 - Last W
 4. Press the *Save[F3]* to save the selected test setup.
-

Start OPP

5. Press *OPP[F1]* to turn the OPP function on if it is off.
6. The OPP function can be started by turning the load on by pressing



- The test watt will increase from the Start W value to the End W value in steps according to the Step W value, until the test has finished.
 - The test will start running when the power supply voltage is greater than the Trig V voltage.
-

Example: OPP
Function running

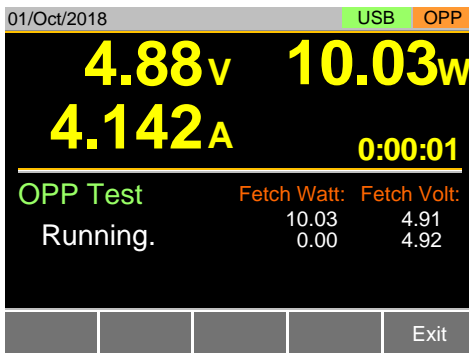

Results:

Power Source
OPP tripped

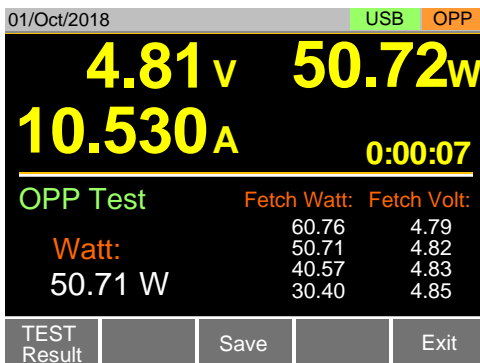

The OPP Test will return the current setting of the last step when the power supply's OPP was tripped.

Power Source
OPP time out

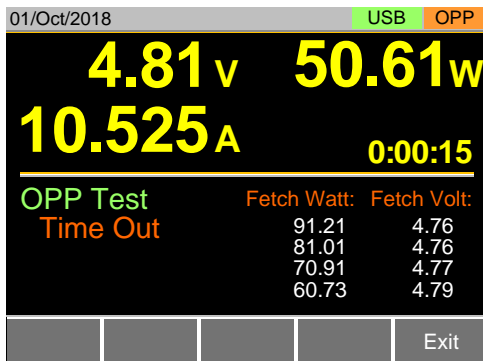

OPP time out will occur if the power supply's OPP fails to trigger. This is determined when the measured voltage is less than Trig V and the measured watt is greater than End W.

Power Source
Config Error

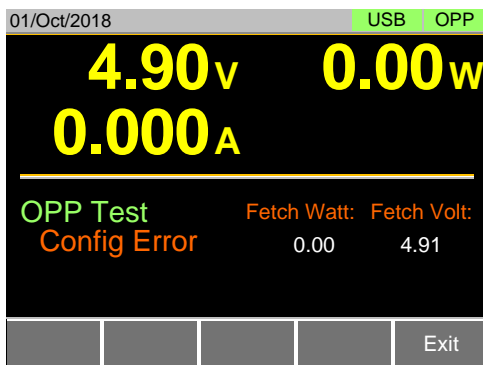

Config Error indicates that the power supply voltage is less than the Trig V voltage setting after the test has started. This can indicate that the power supply output is not on or that the power supply output or Trig V is incorrectly configured.

 Note

In addition to the OPP settings as described above, the Trig voltage settings must also be set according to the output characteristics of the DUT.

Save Data

When the Power Source OPP was tripped. Press TEST Result [F1] to view the test result waveform.

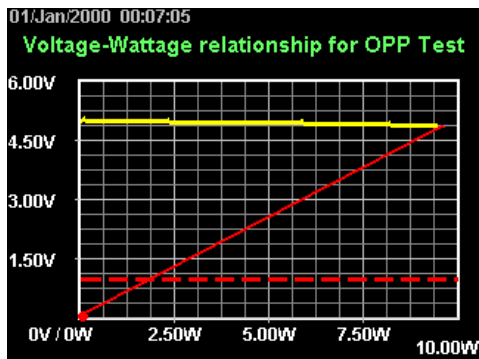

Plug in USB flash drive and press Save [F3] to save the waveform picture.

Press Esc [F1] to exit the waveform view mode.

Press Save [F3] to save the data log to USB flash drive. The file name should be RESULTxx.CSV. The file RESULTxx.CSV can be opened in the computer.

The maximum amount of data to be recorded in the data log is 65536. If data exceeds this limit, the extra data won't be recorded.

	A	B	C	D	E	F
1	<< OPP TEST >>			PEL-3021	v1.32	
2	< PARAMETER of OPP TEST >					
3	OPP No.:		1			
4	(1) Memo:					
5	(2) Range:	Middle				
6	(3) Start Watt:	0.01000 W				
7	(4) End Watt:	15.00000 W				
8	(5) Step Watt:	0.10000 W				
9	(6) Step Time:	0.10 s				
10	(7) Delay Time:	0.00 s				
11	(8) Trig Volt:	1.00 V				
12						
13	< TEST RESULTS >					
14	Start Time:	2000/1/1 00:07				
15	End Time:	2000/1/1 00:07				
16	(1) Test Result:	Complete	OPP :		9.6612 W	
17						
18	(2) DATA LISITS(101):					
19	StepNo	VOLT(V)	CURR(A)	POWER(W)		
20	0	4.98	0.01	0.0498		
21	1	4.98	0.01	0.0498		
22	2	4.98	0.01	0.0498		
23	3	4.98	0.01	0.0498		
24	4	4.98	0.01	0.0498		
25	5	4.99	0.019	0.09481		

BATT Test Automation

Background The BATT test function creates an automatic test to test the discharge of Battery products.

The test will discharge in a fixed mode (CC, CR, CP) and will end after a defined stop point (stop voltage, stop time, stop AH) has been detected. The information about discharge test (discharge time, battery AH, battery WH) can be finally seen on the panel.

The PEL-3000(H) also has a user-defined cutoff setting in the event that the Battery test fails.

The diagram below shows an example of the BATT Test Automation function:

Example The test will run in the specified mode with defined values and will stop when the defined stop values are reached.

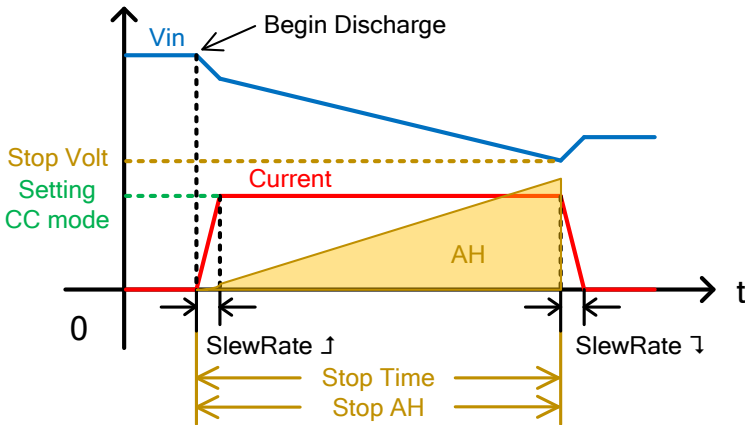

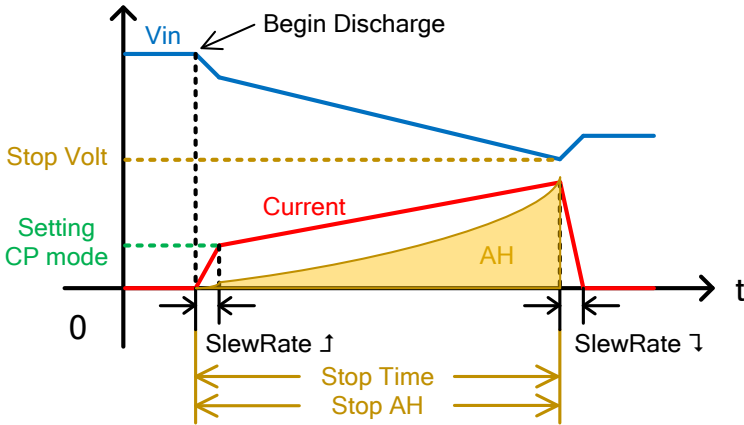
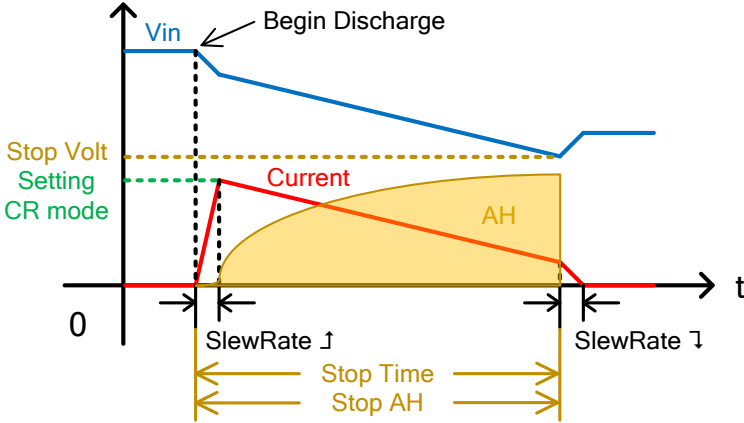

Parameters	BATT No.	Selects one of 12 BATT test setup memories.
	Memo	A user-created note for the currently selected BATT function.
	Mode	Select a discharge operation mode. (CC, CR, CP)
	Range	ILVL(I range low, V range low) IMVL(I range middle, V range low)

	IHVL(I range high, V range low)
	ILVH(I range low, V range high)
	IMVH(I range middle, V range high)
	IHVH(I range high, V range high)
Setting	Sets the values corresponding to the defined discharging mode (CC mode in A, CR mode in mS and CP mode in W).
SlewRate↑	Sets the test rising slew rate in mA/us (not adjustable for CP mode).
SlewRate↓	Sets the test falling slew rate in mA/us (not adjustable for CP mode).
Stop Volt	Sets the voltage at which the test should be interrupted. The value must be lower than the battery start voltage.
Stop Time	Sets the time after which the test should be interrupted (max value is 999h:59m:59s).
Stop AH	Sets the discharged energy rate at which the test should be interrupted (Max value is 9999.99Ah).
Datalog timer	Sets the time interval for data capture. Up to 65,535 data can be saved when running data logging function. When logging data reaches to the maximum amount, it won't be saved and be ignored.

Panel operation

1. Press  > *Next Manu*[F5]. > *BATT*[F2].

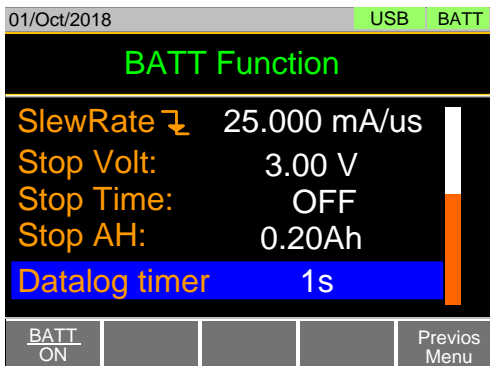
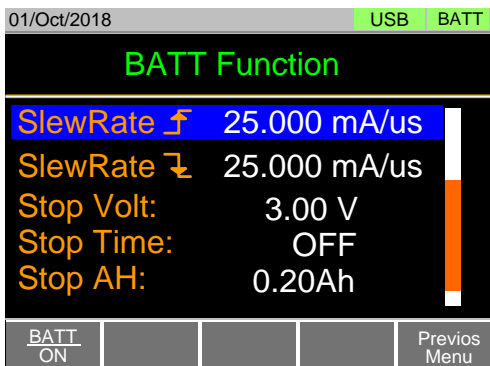
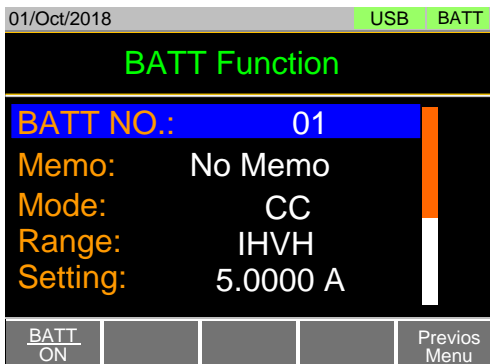

- Set the following parameters for the selected test setup above:

- BATT No.
- Memo
- Mode
- Range
- Setting
- SlewRate↓
- Stop Volt
- Stop Time
- Stop AH
- Datalog timer
- SlewRate↑

3. Press the *Save*[F3] to save the selected test setup.

Start BATT

4. Press *BATT*[F1] to turn the BATT function on if it is off.
5. The BATT function can be started by turning the load on by pressing

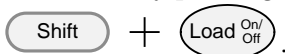

- The discharge test will keep running with its defined mode and values until any of the Stop Voltage, Stop Time or Stop AH settings is detected.

Save Data

When the Battery stop voltage, stop time or stop AH was tripped. Press TEST Result [F1] to view the test result waveform.

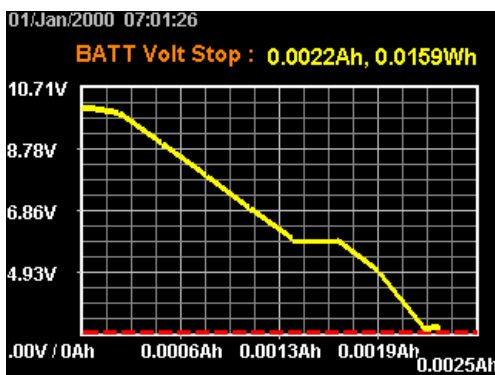

Plug in USB flash drive and press Save [F3] to save the waveform picture.

Press Esc [F1] to exit the waveform view mode.

Press Save [F3] to save the data log to USB flash drive. The file name should be RESULTxx.CSV.

The file RESULTxx.CSV can be opened in the computer.

The maximum amount of data to be recorded in the data log is 65536. If data exceeds this limit, the extra data won't be recorded.

	A	B	C	D	E	F	G
1	<< BATT TEST >>			PEL-3XXX	v1.31.003		
2	< PARAMETER OF BATT TEST >						
3	BATT No.:		1				
4	(1) Memo:						
5	(2) Mode:		CC				
6	(3) Range:		IHVH				
7	(4) Set CC:		1.000 A				
8	(5) Stop Volt:		3.00 V				
9	(6) Stop Time:		0 h	0 m	10 s		
10	(7) Stop AH:		0.20 Ah				
11							
12	< TEST RESULTS >						
13	Start Time:		2000/1/1 07:01				
14	End Time:		2000/1/1 07:01				
15	(1) Test Length:		0 h	0 m	8 s		
16	(2) Recorder Length:		0 h	0 m	8 s		
17	(3) Stop Condition:		Under VOLT				
18	(2) DATA LISITS(9):		Timebase(sec):	1 s			
19	No		VOLT(V)	CURR(A)	POWER(WAH)	WH	
20		0	10.01	0.002	0.02002	0	0
21		1	9.84	0.998	9.82032	0.0002	0.0024
22		2	8.85	0.998	8.89218	0.0005	0.005
23		3	7.85	0.998	7.8343	0.0008	0.0074
24		4	6.85	0.998	6.84628	0.0011	0.0096
25		5	5.87	0.998	5.85826	0.0014	0.0115
26		6	5.85	0.998	5.8383	0.0016	0.0131
27		7	4.86	0.998	4.85028	0.0019	0.0145
28		8	2.86	0.998	2.85428	0.0022	0.0157
29							

Example: BATT
Function running

01/Oct/2018
USB
BATT

4.90v 24.47w
4.994A 0:00:01

0.0024 Ah 0.0019 Wh

Discharging:

CC, IHVH, 5.0000 A
 Stop: 3.00V, 0.20Ah

Exit

Results:
 Battery stop
 Voltage or stop
 time or stop AH
 tripped



The BATT Test will return the information of the last discharge when the Battery stop voltage or stop time or stop AH was tripped.



Note

In addition to the BATT Function settings as described above, the Stop Volt voltage settings must also be set according to the output characteristics of the DUT.

MPPT

Background The MPPT (Maximum Power Point Tracking) function of PEL-3000(H) series can perform IV, PV characteristics and Pmax tracking tests of solar panels.

Note The firmware (Ver.1.32 or later for PEL-3000 and Ver.1.08 or later for PEL-3000H) is compatible with this extended function.

Features of this function It is possible to test the IV and PV characteristics of solar panels.

I-V and P-V characteristic

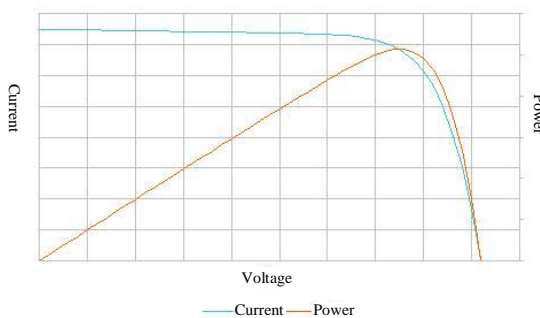

Furthermore, Pmax tracking test can be performed by turning on tracking.

MPPT

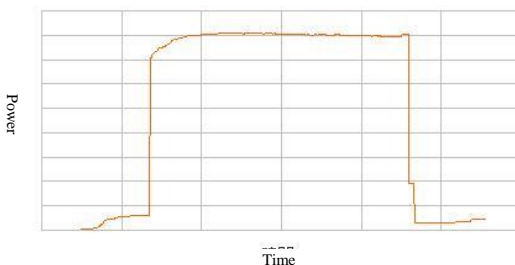

Test data is saved on USB memory. It supports USB memory up to 2GB.

Parameters	MPPT No.	Set one of 12 test patterns.
	Memo	A user-created note for the currently selected BATT function.
	Mode	Select a discharge operation mode. (CC, CV)
	Range	Set the voltage and current range. ILVL(I range low, V range low) IMVL(I range middle, V range low) IHVL(I range high, V range low) ILVH(I range low, V range high) IMVH(I range middle, V range high) IHVH(I range high, V range high)
	Response	Set the response speed of each discharge mode. CV mode: Slow, Fast CC mode: 1, 1/2, 1/5, 1/10
	Sweep Range	Set the conditions for the sweep range. CV mode: Value, Percent CC mode: Value only
	Start V (Start Voltage)	Response appears only in CV mode. Set the start voltage value and its range is from 0V to the maximum of the setting voltage.
	End V (End Voltage)	Response appears only in CV mode. Set the end voltage value and its range is from 0V to the maximum of the setting voltage.
	Step V (Step Voltage)	Response appears only in CV mode. Set the step voltage value and its range is from 0V to half of the maximum of the setting voltage.

Start C (Start Current)	Response appears only in CC mode. Set the start current value and its range is from 0A to the maximum of the setting current.
End C (End Current)	Response appears only in CC mode. Set the end current value and its range is from 0A to the maximum of the setting current.
Step C (Step Current)	Response appears only in CC mode. Set the step current value and its range is from 0A to half of the maximum of the setting current.
Step Time	Set the step time and its range is from 0.01s to 50s.
Detect Short (Short Circuit Detection)	“Disable” only.

Panel operation

1. Press  > Next Manu[F5] > MPPT[F4].

When CV mode is set

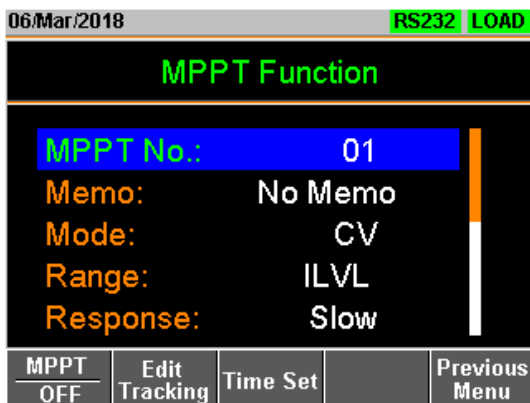

08/Mar/2018 RS232 LOAD

MPPT Function

Sweep Range: Value

Start V: 0.000 V

End V: 0.000 V

Step V: 0.001 V

Step Time: 0.01 s

MPPT OFF	Edit Tracking	Time Set		Previous Menu
-------------	------------------	----------	--	------------------

08/Mar/2018 RS232 LOAD

MPPT Function

Start V: 0.000 V

End V: 0.000 V

Step V: 0.001 V

Step Time: 0.01 s

Detect Short: Disable

MPPT OFF	Edit Tracking	Time Set		Previous Menu
-------------	------------------	----------	--	------------------

When CC mode is set

05/Mar/2018 RS232 MPPT

MPPT Function

MPPT No.: 01

Memo: 2

Mode: CC

Range: ILVL

Response: 1

MPPT ON	Edit Tracking	Time Set		Previous Menu
------------	------------------	----------	--	------------------

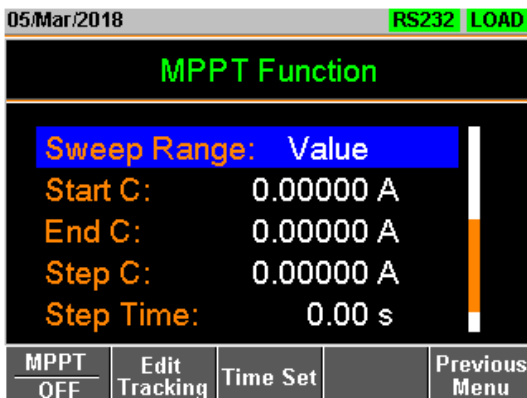

2. Set the following parameters.
 - MPPT No.
 - Mode
 - Response
 - Start C (Start V)
 - Step C (Step V)
 - Detect Short (Disable only)
 - Memo
 - Range
 - Sweep Range
 - End C (End V)
 - Step Time

Edit Tracking of MPPT function

Background	Set tracking the maximum power point of MPPT function.	
Parameters	Tracking	Enable/ Disable tracking the maximum power point of MPPT function.
	Track Step	Set the tracking range (0.01 % to 5.00%).
	Track Step Time	Set the tracking time (0.01s to 2.00 s).

Pmax Detection (Pmax Detection Time Interval)	Set the detection time of Pmax (maximum power point) (OFF, 1m to 60m). Redetecting can also be used when the maximum power point is two.
Measure Interval (Measurement Time Interval)	Set the measurement time interval (1.0s to 60.0s).

Panel operation

- Press **FUNC** > *Next Manu*[F5] > *MPPT*[F4] > *Edit Tracking*[F2].

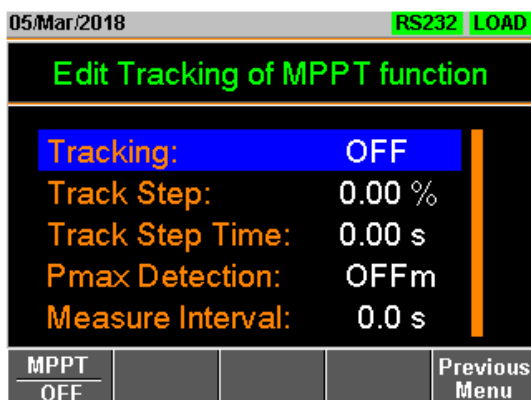

- Set the following parameters.
 - Tracking
 - Track Step
 - Track Step Time
 - Pmax Detection
 - Measure Interval

Auto Load of MPPT function

Background	Set start date and stop date of MPPT test.	
Parameters	Auto Load	Set the date and time of the test. on/off

Disable	Set the tracking range (0.01% to 5.00%).
Only Start	Set start date and time only.
Only Stop	Set stop date and time only.
Enable	Set the start and stop date, start and stop time.

Panel operation

1. Press **FUNC** > *Next Menu*[F5] > *MPPT*[F4] *Time Set*[F3].

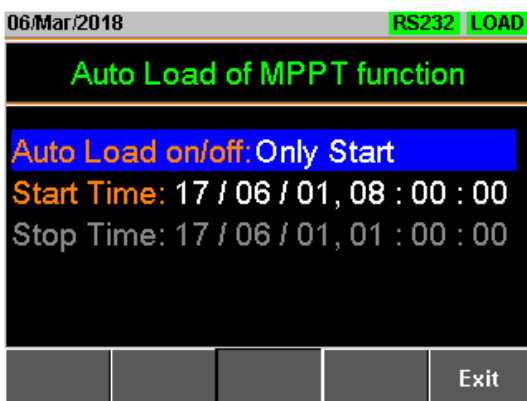
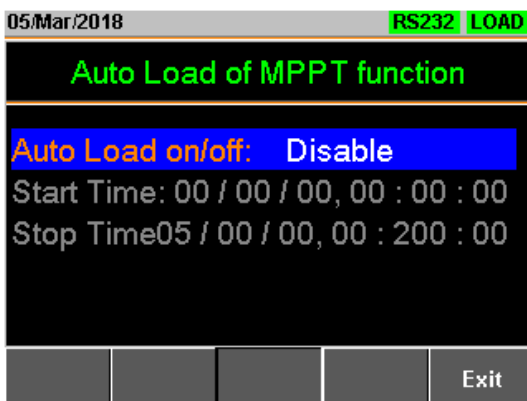

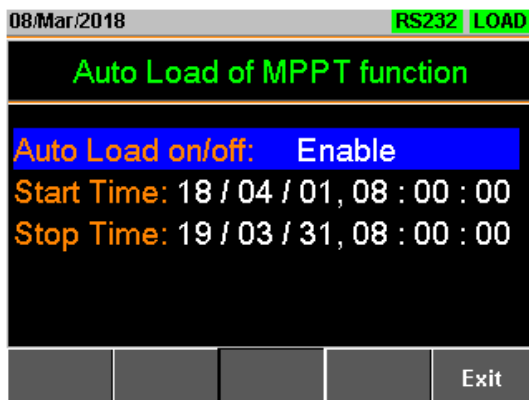
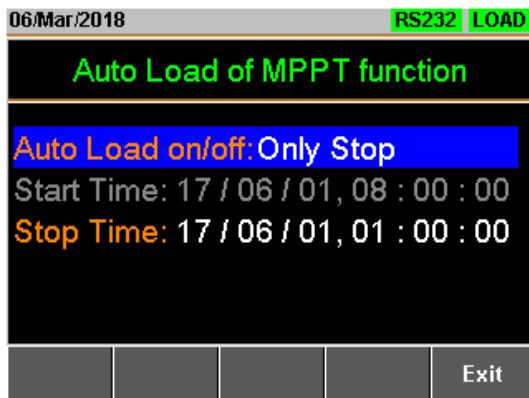

2. Set the following parameters.
 - Auto Load on/off
 - Start Time
 - Stop Time

Start MPPT

1. Insert a USB flash disk into USB port in the front panel.
2. Press MPPT [F1] to enable this function to start the test.
3. Press Shift + Load key to start the test.

Continue testing until the end conditions are met.

Example: MPPT
Function running



Example: MPPT
test results

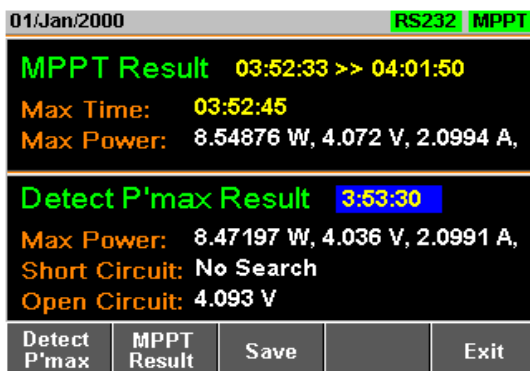

To save the test result data, press Save [F3].

The maximum amount of data to be recorded in the data log is 65536. If data exceeds this limit, the extra data won't be recorded.

To see the graph of the maximum power point tracking test, press Detect P'max [F1].

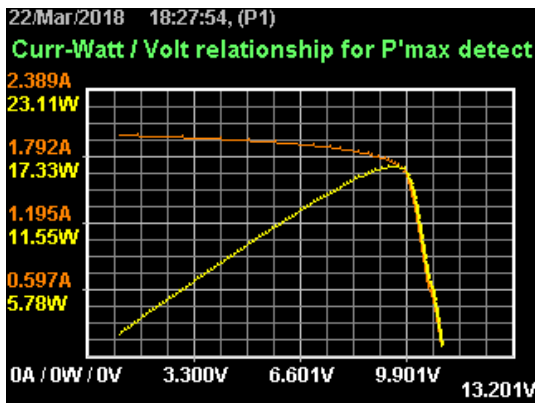

To see the graph of the MPPT exam, Press MPPT Result [F2].

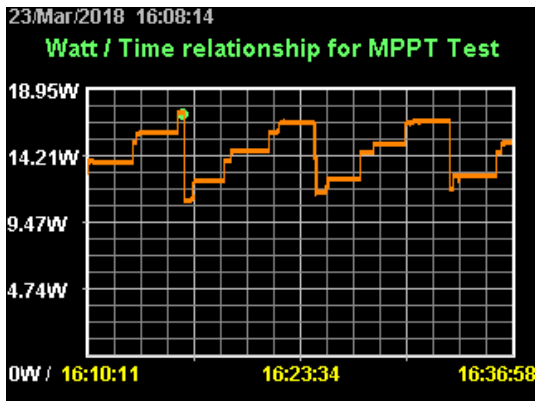

If you want to have a screen shot, press Save [F3]. Press Esc [F1] to exit.

Data file of test result

Background Test result data is saved as a CSV file.

Example: Test conditions and results file

	A	B	C	D	E
1	<< MPPT TEST >>			LSG-175	v1.29.001
2					
3	<DATE>	2018/3/22 18:37			
4	<Pmax Detection Method>				
5		(1)Memo:			
6		(2)Mode:	CV		
7		(3)Range:	I/V/L		
8		(4)Response:	Slow		
9		(5)Sweep Range:	Value		
10		(6)Start Voltage:		1 V	
11		(7)End Voltage:		11 V	
12		(8)Step Voltage:		0.1 V	
13		(9)Step Time:		1 sec	
14		(10)Short Circuit Detection:	Disable		
15	<Hill Climbing Method Tracking>				
16		(11)Tracking:	Enable		
17		(12)Tracking Step Voltage:		1 %	
18		(13)Tracking Step Time:		1 sec	
19		(14)Pmax Detection Time Interval:		1.0 min	
20	<Measurement condition>				
21		(15)Measurement Time Interval:		1 sec	
22					
23	<MPPT TEST RESULTS>				
24		(1)Start Time	2018/3/22 18:37		
25		(2)End Time	2018/3/22 18:43		
26		(3)MAX No.	103		
27		(4)MAX Time	2018/3/22 18:40		
28		(5)MAX Voltage	9.49 V		
29		(6)MAX Current	1.754 A		
30		(7)MAX Power	16.645462 W		

- <DATE> Date of test
- <Pmax Detection Method> Settings contents for Pmax detection (in CV mode).
- <Hill Climbing Method Tracking> Setting contents of the hill climbing method.
- <Measurement condition> Measurement status.
- <MPPT TEST RESULTS> MPPT test results.
 - (1) Start Time Test start time
 - (2) End Time Test end time
 - (3) MAX No. Number of measurement data
 - (4) MAX Time Time when Pmax is maximum
 - (5) MAX Voltage Voltage value when Pmax is maximum
 - (6) MAX Current Current value when Pmax is maximum
 - (7) MAX Power Power value when Pmax is maximum

Example: Results file of IV and PV characteristics test

	A	B	C	D
1				
2	<PMAx DETECTION RESULTS>			
3		(1)Start Time	2018/3/22 18:37	
4		(2)MAX No	86	
5		(3)MAX Voltage	9.6 V	
6		(4)MAX Current	1.719 A	
7		(5)MAX Power	16.502401 W	
8		(6)Short Circuit	No Search	
9		(7)Open Circuit	1 V	
10		(8)DATA Lists	101	
11	No	VOLT(V)	CURR(A)	POWER(W)
12	1	1.1	1.99	2.189
13	2	1.2	1.989	2.3868
14	3	1.3	1.988	2.5844
15	4	1.4	1.987	2.7818
16	5	1.5	1.987	2.9805
17	6	1.6	1.986	3.1776
18	7	1.7	1.985	3.3745
19	8	1.8	1.984	3.5712
20	9	1.9	1.983	3.7677
21	10	2	1.982	3.964
22	11	2.1	1.981	4.1601
23	12	2.2	1.981	4.3582
24	13	2.3	1.98	4.554001
25	14	2.4	1.979	4.7496
26	15	2.5	1.978	4.945
27	16	2.6	1.977	5.140201
28	17	2.7	1.976	5.3352
29	18	2.8	1.973	5.524401
30	19	2.9	1.972	5.718801
31	20	3	1.971	5.913001
32	21	3.1	1.97	6.107001
33	22	3.2	1.969	6.3008
34	23	3.3	1.968	6.494401
35	24	3.4	1.966	6.684401
36	25	3.5	1.965	6.877501
37	26	3.6	1.964	7.070401
38	27	3.7	1.963	7.263101

< PMAx DETECTION RESULTS >

Pmax detection results.

(1) Start Time

Test start time

(2) MAX No.

Data number when Pmax is maximum

(3) MAX Voltage

Voltage value when Pmax is maximum

(4) MAX Current

Current value when Pmax is maximum

(5) MAX Power

Power value when Pmax is maximum

(6) Short Circuit

No search

(7) Open Circuit

Test start voltage

(8) DATA Lists

Number of measurement data

No

Measurement data number

VOLT(V)

Measured voltage value

CURR(A)

Measured current value

POWER(W)

Measured power value

Example: Results
file of MPPT test

	A	B	C
1	(1)Start Time	2018/3/22 19:00	
2	(2)End Time	2018/3/22 19:08	
3	VOLT(V)	CURR(A)	POWER(W)
4	9.501	1.737	16.50324
5	9.501	1.737	16.50324
6	9.501	1.737	16.50324
7	9.501	1.737	16.50324
8	9.548	1.737	16.58488
9	9.548	1.737	16.58488
10	9.524	1.737	16.54319
11	9.547	1.737	16.58314
12	9.57	1.737	16.62309
13	9.57	1.737	16.62309
14	9.583	1.737	16.64567
15	9.583	1.737	16.64567
16	9.577	1.737	16.63525
17	9.582	1.737	16.64394
18	9.587	1.737	16.65262
19	9.587	1.737	16.65262
20	9.589	1.737	16.6561
21	9.589	1.737	16.6561
22	9.589	1.737	16.6561
23	9.589	1.737	16.6561
24	9.589	1.737	16.6561
25	9.588	1.737	16.65436
26	9.588	1.737	16.65436
27	9.588	1.737	16.65436
28	9.588	1.737	16.65436
29	9.588	1.737	16.65436
30	9.588	1.737	16.65436
31	9.588	1.737	16.65436
32	9.588	1.737	16.65436
33	9.588	1.736	16.64477
34	9.587	1.737	16.65262
35	9.587	1.737	16.65262
36	9.587	1.737	16.65262
37	9.588	1.737	16.65436

(1) Start Time Test start time

(2) Stop Time Test end time

VOLT(V) Measured voltage value

CURR(A) Measured current value

POWER(W) Measured power value

EXTERNAL CONTROL

Analog Control.....	183
J1 Connector Overview	183
J3 port (PEL-3021H/PEL-3041H/PEL-3111H)	184
External Voltage Control - Overview	185
External Voltage Control – Operation.....	186
Adjust offset and full scale with variable resistor (PEL-3021H/ PEL-3041H/ PEL-3111H).....	188
External Resistance Control - Overview	190
External Resistance Control – Operation.....	191
Adjust offset and full scale with variable resistor (PEL-3021H/ PEL-3041H/ PEL-3111H).....	194
Turning the Load On using External Control.....	195
Load On/Off Status	197
External Control of the Range	197
I Range Status.....	198
External Trigger Signal	199
External Control of the Alarm	199
Alarm Status	200
Short Control.....	200
Monitor Signal Output.....	201
Trigger Signal Output.....	201
Current Monitor Output.....	202
Voltage Monitor Output (PEL-3021H/PEL-3041H/PEL-3111H)	203
Parallel Operation.....	204
Parallel Capacity, PEL-3021, PEL-3041, PEL-3111.....	204
Parallel Capacity, PEL-3021H, PEL-3041H, PEL-3111H	205
Parallel Capacity, PEL-3211	205
Parallel Capacity, PEL-3211H	206
Connection	206
Configuration.....	208
Turning the Load On.....	210
Disable Parallel Mode	210

Analog Control

The Analog Control subsection describes how to use the J1 Frame Control Connector for voltage or resistance control. The J2 connector, located under the J1 connector is used for parallel control. See page 245 for details about the J1 and J2 connectors.

J1 Connector Overview

Description The J1 External Control Connector is a standard Mil 20 pin connector (OMRON XG4A IDC plug). The connector is used for all analog control. The pins are used to determine what mode is used. See the appendix on page 245 to view the contact pin assignment of the J1 connector.

 **WARNING** Some pins on the frame control connector have the same potential as the front and rear terminals. To prevent electric shock, ensure that the cover for both the J1 and J2 External Control connectors are used when the connectors are not in use.

Pin Assignment

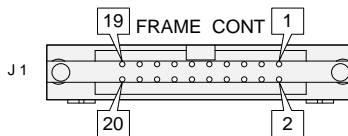

J3 port (PEL-3021H/PEL-3041H/PEL-3111H)

Description

Use wire of 24 to 28 AWG to connect with J3 port. Please peel the coating of a wire approximately 10mm and then insert the wire to the terminal hole while pushing the button on the terminal hole of the J3.

To view the contact pin assignment of the J3, please see page 254 in the appendix chapter.



WARNING

Please insert the wire to the hole of terminal J3 deeply. A conductor part of the wire, please do not come in contact with the frame and conductor part of other wire.

To prevent electric shock, ensure the cover for the J3.

Pin Assignment

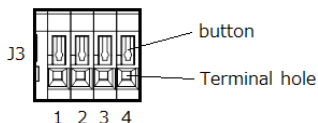

J3 Pin assignment	No	Name	No	Name
		1	I MON OUT	2
	3	A COM	4	A COM

External Voltage Control - Overview

Background External voltage control of the CC, CR, CV, CP and Cx+CP mode is accomplished using the J1 connector on the rear panel. An input voltage of 0-10V corresponds to 0% - 100% of the rated current (CC mode), rated voltage (CV mode), or rated power (CP mode). For CR mode, 0V - 10V corresponds to the maximum resistance - minimum resistance.

Connection When connecting the external voltage source to the J1 connector, use a ferrite core and use twisted pair wiring.

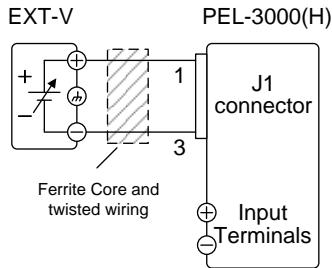

- *Pin1* → EXT-V (+)
- *Pin3* → EXT-V (-)

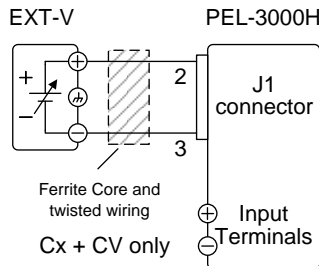

- *Pin2* → EXT-V (+)
- *Pin3* → EXT-V (-)



Note

The input impedance for external voltage control is 10kΩ.

Use a stable voltage supply for the external voltage control.



Caution

When using external voltage control, make sure no more than ±11V is applied across pins 1 and 3. Exceeding this voltage could damage the PEL-3000(H). Exceeding 11.8V will cause an EXT.OV alarm message to appear which also will reset the voltage output to 0V until the external voltage is reduced back down below 11.8V.

Use caution when using pin 3. Pin 3 is directly coupled to the negative input terminal.

External Voltage Control – Operation

Description

External voltage control can be used to control the current, voltage, resistance and power for CC, CR, CV, CP and Cx+CV modes. Configuration for each operating mode is the same.

CC Mode

Input current = rated current × (external voltage/10)

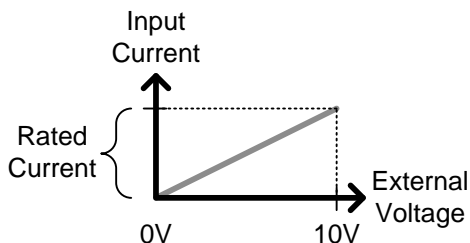

CR Mode Input conductance =
 rated conductance \times (external voltage/10)

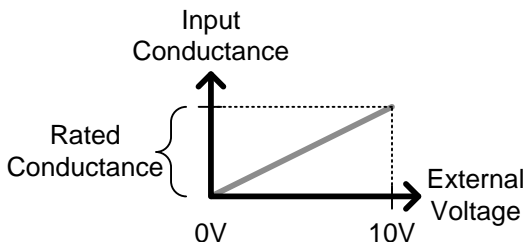

CV Mode Input voltage = rated voltage \times (external
 Cx+CV Mode voltage/10)

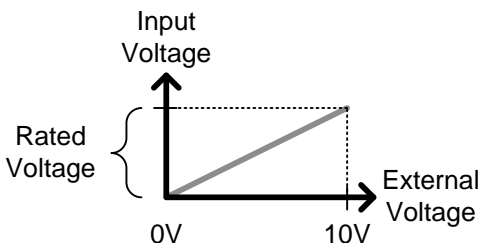

CP Mode Input power = rated power \times (external voltage/10)

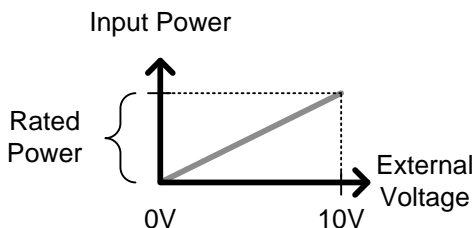

- Operation
1. Turn the power off from the PEL-3000(H) and from the load.
 2. Connect the external voltage across pins 1 and 3 of the J1 connector.
 3. Turn the power on the PEL-3000(H).
 4. Set the operating mode and range.
 - See page 54 for CC mode.

- See page 56 for CR mode.
 - See page 58 for CV mode.
 - See page 59 for CP mode.
7. Press **Main** > *Configure* [F5] > *Next Menu* [F4] > *External* [F3].
 8. Set the *Control* parameter to V.
 - The J1 connector is now ready for external voltage control.

Adjust offset and full scale with variable resistor (PEL-3021H/ PEL-3041H/ PEL-3111H)

Variable Resistor
in rear panel

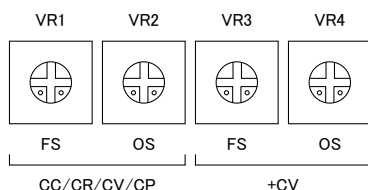

Operation
CC, CR, CV, CP
Mode

1. Apply a voltage of 1V to pin J1-1 based on the level of pin J1-3.
2. Turn VR2 with screwdriver to adjust the value to 10% of the rating in each the operating mode.
3. Apply a voltage of 10V to pin J1-1 based on the level of pin J1-3.
4. Turn VR1 with screwdriver to adjust the value to 100% of the rating in each the operating mode.
5. Apply a voltage of 1V to pin J1-1 based on the level of pin J1-3.
6. Turn VR2 with screwdriver to adjust the value to 10% of the rating in each the operating mode.



Readjustment is needed when you use a different operating mode, current range or voltage range.

Cx+CV mode

1. Apply a voltage of 1V to pin J1-1 based on the level of pin J1-3.
 2. Turn VR4 with screwdriver to adjust the value to 10% of the rating in each +CV mode.
 3. Apply a voltage of 10V to pin J1-2 based on the level of pin J1-3.
 4. Turn VR3 with screwdriver to adjust the value to 100% of the rating in each +CV mode.
 5. Apply a voltage of 1V to pin J1-2 based on the level of pin J1-3.
 6. Turn VR4 with screwdriver to adjust the value to 10% of the rating in each +CV mode.
-



Readjustment is needed when you use a different voltage range.

External Resistance Control - Overview

Background External resistance control of the CC, CR, CV and CP modes is accomplished using the J1 connector on the rear panel.

A resistance of $0\text{k}\Omega$ - $10\text{k}\Omega$ is used to control the input current, voltage, resistance or power on the PEL-3000(H).

The input can be configured to vary in proportion to the external resistance or the inverse. See page 191 for more details on proportional and inverse resistance control.



Note

Exceeding $11.8\text{k}\Omega$ will cause an EXT.OV alarm message which will reset the voltage output to 0 until the external resistance is reduced back down below $11.8\text{k}\Omega$.

Connection

When connecting the external resistance source to the J1 connector, use a ferrite core and use twisted pair wiring.

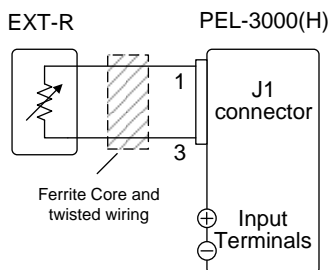

- *Pin1* → EXT-R
- *Pin3* → EXT-R



Note

Use resistors with minimum residual resistance of 50Ω or less.

Note for proportional control: Do not use switches that switch between fixed resistances. Please use continuously variable resistors.

External Resistance Control – Operation

Description External resistance control can be used to control the current, voltage, resistance and power for CC, CR, CV and CP modes. Configuration for each operating mode is the same.

CC Mode Proportional Control:
 Input current = rated current \times (external resistance/10).
 Inverse Control:
 Input current = rated current \times (1 - external resistance/10).

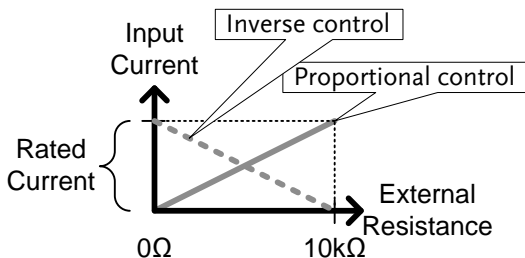

CR Mode

Proportional Control:

Input conductance =
 rated conductance \times (external resistance/10).

Inverse Control:

Input conductance =
 rated conductance \times (1 - external resistance/10).

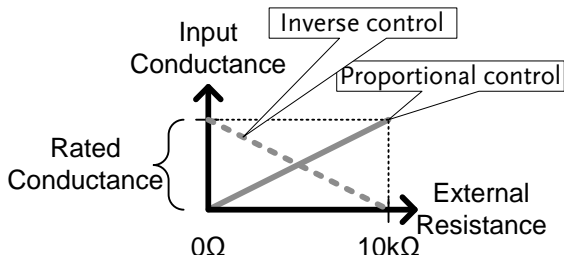

CV Mode

Proportional Control:

Input voltage = rated voltage \times (external resistance/10).

Inverse Control:

Input voltage = rated voltage \times (1 - external resistance/10).

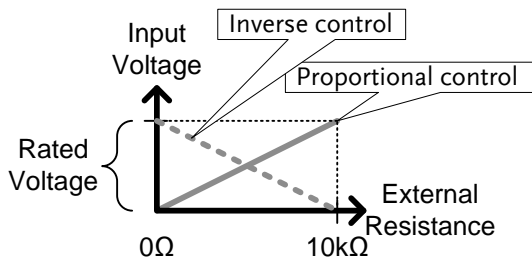

CP Mode

Proportional Control:

Input power = rated power \times (external resistance/10).

Inverse Control:

Input power = rated power \times (1 - external resistance/10).

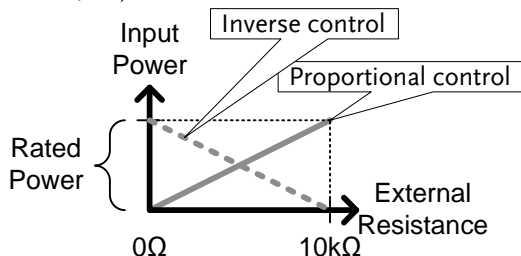

Note

The inverse configuration is recommended for safety reasons. In the event that any of the cables become accidentally disconnected, the current/voltage/power input will drop to the minimum. Under similar circumstances using proportional control, an unexpectedly high input would result.

Operation

1. Turn the power off from the PEL-3000(H) and from the load.
2. Connect the external resistance across pins 1 and 3 of the J1 connector.
3. Turn the power on the PEL-3000(H).
4. Set the operating mode and range.
 - See page 54 for CC mode.
 - See page 56 for CR mode.
 - See page 58 for CV mode.
 - See page 59 for CP mode.
5. Press **Main** > *Configure* [F5] > *Next Menu* [F4] > *External* [F3].
6. Set the *Control* to *R* for proportional control or to *Rinv* for inverse control.

- The J1 connector is now ready for external resistance control.

Adjust offset and full scale with variable resistor (PEL-3021H/
PEL-3041H/ PEL-3111H)

Variable Resistor
in rear panel

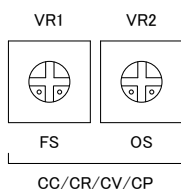

- | | |
|----------------------|--|
| Operation | 1. Connect 1kΩ between J1-1 and J1-3. |
| Proportional control | 2. Turn VR2 with screwdriver to adjust the value to 10% of the rating in each the operating mode. |
| | 3. Connect 10kΩ between J1-1 and J1-3. |
| | 4. Turn VR1 with screwdriver to adjust the value to 100% of the rating in each the operating mode. |
| | 5. Connect 1kΩ between J1-1 and J1-3. |
| | 6. Turn VR2 with screwdriver to adjust the value to 10% of the rating in each the operating mode. |



Note

Readjustment is needed when you use a different operating mode, current range or voltage range.

- | | |
|-----------------|---|
| Inverse control | 1. Connect 9kΩ between J1-1 and J1-3. |
| | 2. Turn VR2 with screwdriver to adjust the value to 10% of the rating in each the operating mode. |
| | 3. Connect 1kΩ between J1-1 and J1-3. |
| | 4. Turn VR1 with screwdriver to adjust the value to 90% of the rating in each the operating mode. |
| | 5. Connect 9kΩ between J1-1 and J1-3. |
| | 6. Turn VR2 with screwdriver to adjust the value |

to 10% of the rating in each the operating mode.



Note

Readjustment is needed when you use a different operating mode, current range or voltage range.

Turning the Load On using External Control

Description The load can be turned on and off with an external switch connected to pins 7 and 12 of the J1 connector.

Pin Inputs Pin 7 of the J1 connector is internally pulled up to 5V with a 10k Ω resistor when the switch is open. Thus when the switch is open, pin 7 is logically high. When the switch is closed, pin 7 is pulled down to the A COM ground level, making pin 7 logically low.

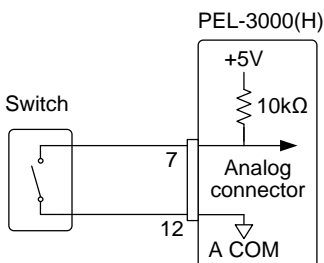

Example

The LoadOn IN setting determines whether the load is turned on when the external switch is closed (low) or open (high).

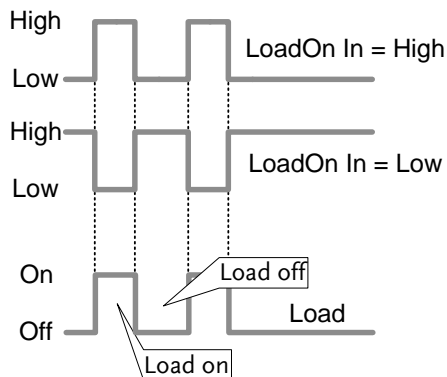

**Operation:
Configuration**

1. Press **Main** > *Configure [F5]* > *Next Menu [F4]* > *External [F3]* and set the *LoadOn IN* setting.
 - Set to Low if you want the load to be turned on when the switch is closed.
 - Set to High if you want the load to turn on when the switch is open.

 **Note**

When external control is used to turn the load off, the load key cannot be used to turn the load on. However the reverse is not true. If the load has been turned on by external control, the load key can be used to turn the load off.

Load On/Off Status

Description Pin 13 (Load On Status) of the J1 connector is used to monitor the load status (on or off).

Pin out The Load On Status pin is a photo-coupled open-collector output.

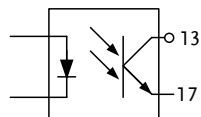

Photocoupler input: 30V max, 8mA, max.

External Control of the Range

Description The range for the present operating mode can be externally controlled when the current range is set to high range.

The range is changed using pins 8, 9 (Range Cont 1 &2) and 12 (A Com) of the J1 connector.

When externally controlling the range, the pin input combination determines which range is chosen.



1. Press  > Configure [F5] > Next Menu [F4] > External [F3] and set the Control setting to V, R or Riv to enable external control.
2. When externally controlling the range, the pin input combination determines which range is chosen.

I Range	Pin 9	Pin 8
H	High	High
M	High	Low
L	Low	High

Pin Inputs Pins 8 and 9 of the J1 connector are internally pulled up to 5V with a 10kΩ resistor when open. When closed, pin 8 and 9 are pulled down to the A COM ground level.

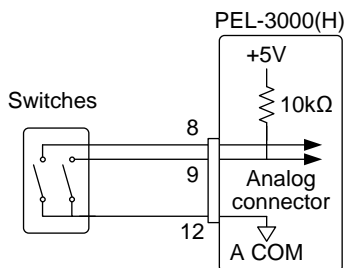

Note The range can only be externally controlled when the IRange has been set to High using the front panel controls.

I Range Status

Description Pins 14 and 15 (Range Status 1& 0) of the J1 connector are used to monitor the IRange status.

The pinout combination determines the range status.

I Range	Pin 15	Pin 14
H	Off	Off
M	Off	On
L	On	Off

Pin out The Range Status pins are photo-coupled open-collector outputs.

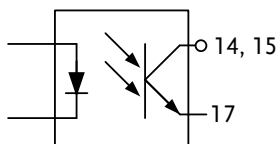

Photocoupler input: 30V max, 8mA, max.

External Trigger Signal

Description Pins 11 and 12 of the J1 connector are the trigger signal inputs. The trigger signal is used to resume a sequence after a pause. This action is useful to synchronize the execution of a sequence with another device.

Pin out Pin 11 of the J1 connector is internally pulled down to A COM with an approx. 50kΩ resistor. To use the trigger input, an active high TTL pulse of 10μs or more is required.

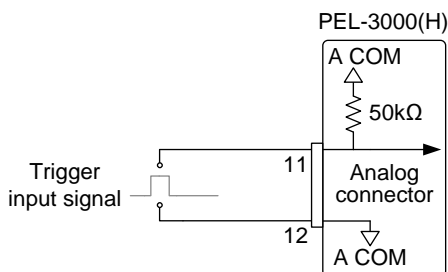

External Control of the Alarm

Description An alarm can be activated/deactivated using external control with the J1 connector (pins 10, 12). When the alarm is activated, an EXT.AL message is also output. The alarm can be activated by an external device or by a parallel slave unit.

The alarm is activated by sending a low-level signal. The operating threshold level is TTL.

Pin Inputs Pin 10 is internally pulled up to 5V with a 10kΩ resistor when open. When closed, pin 10 is pulled down to the A COM ground level.

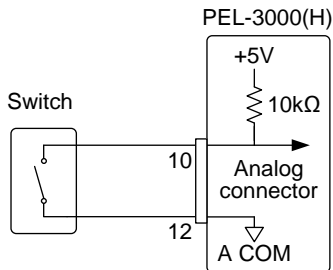

Alarm Status

Description Pins 16 and 17 of the J1 connector are used to monitor whether the alarm is on or off.

Pin out The Alarm Status pin is a photo-coupled open-collector output.

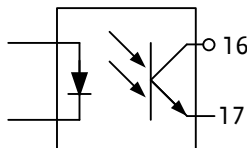

Photocoupler input: 30V max, 8mA, max.

Short Control

Description The Short Signal Out pins (19 and 20) are 30VDC 1A relay contact outputs. These outputs can be used to drive an external relay to physically short the terminal outputs.

Pin Inputs The Short Signal Out pins are normally open until the short function is activated.

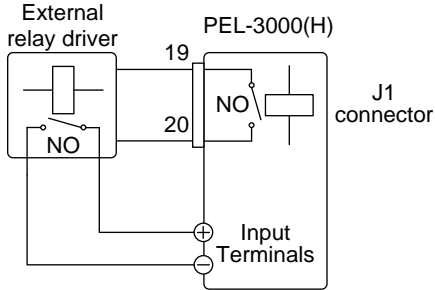

Note

The external relay driver is not a standard accessory. Please provide your own external relay and driver circuit.

Monitor Signal Output

Trigger Signal Output

Description

The trigger output signal is generated every time a switching operation is performed (i.e., Dynamic mode) or when a Fast or Normal Sequence is executed and the TRIG OUT parameter is enabled.

The trigger output signal from TRIG OUT BNC is a 5V pulse of at least 2 μ s with an impedance of 500 Ω . The common potential is connected to the chassis potential. The signal threshold level is TTL.

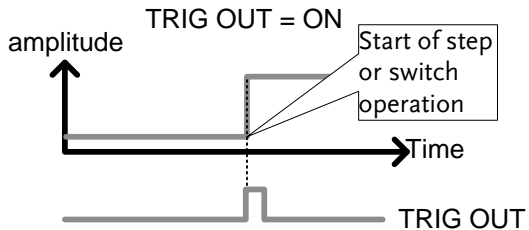

Current Monitor Output

Description The voltage output from the IMON OUT terminal and from the IMON pin on the J3 connector is used to represent the current input level.

The voltage range used to represent the full scale current range from the IMON OUT terminal and from the IMON pin on the J3 connector depends on the current range settings.

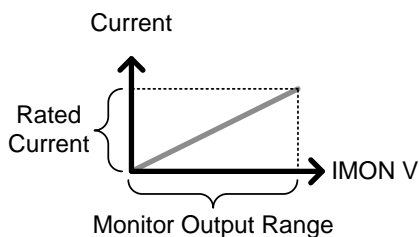

Monitor Connector	Current Range	Monitor Output Range
I MON OUT (BNC)	H, L	0 - 1V
	M	0 - 0.1V
I MON (J3)	H, L	0 - 10V
	M	0 - 1V

I MON OUT BNC Connector The IMON OUT BNC connector outputs a voltage of 0 - 1V for the High and Low current ranges and 0 - 0.1V for the Middle current range. The common potential is connected to the chassis ground potential.

J1 Connector The voltage across pins 2 and 3 outputs a voltage of 0 - 10V for the High and Low current ranges and 0 - 1V for the Middle current range. The common potential is connected to A COM (negative load terminal).

Voltage Monitor Output (PEL-3021H/PEL-3041H/PEL-3111H)

Description The voltage output from the VMON OUT terminal and from the VMON pin on the J3 connector is used to represent the current input level.

The V Range used to represent the full scale current range from the VMON OUT terminal and from the VMON pin on the J3 connector depends on the current range settings.

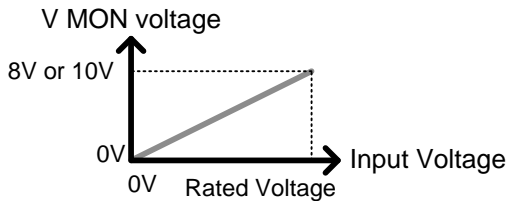

Monitor Connector	Voltage Range	Monitor Output Range
V MON OUT (BNC)	H, L	0 - 8V
V MON (J3)	H, L	0 - 10V

V MON OUT BNC Connector The V MON OUT BNC connector outputs a voltage of 0 - 8V for the High and Low voltage ranges. The common potential is connected to the chassis ground potential.

J3 Connector The voltage across pins 2 and 3 (or 4) outputs a voltage of 0 -10V for the High and Low voltage ranges. The common potential is connected to A COM (negative load terminal).

Parallel Operation

The PEL-3000(H) series can be connected in parallel to increase the total power capacity of a single unit.

The PEL-3000(H) series can operate with up to 5 units in parallel. A single unit is designated as a master unit and any other connected units as slaves.

Only units of the same type and rating can be used in parallel or alternatively, the PEL-3211(H) booster pack can be used as a slave with the PEL-3111(H).

When a master unit is used in parallel mode, to ensure stability, the response speed will drop down to 1/2 if it was originally 1/1. You can however, reset the response speed back (or to another value) in the Main>Configure menu.

Parallel Capacity, PEL-3021, PEL-3041, PEL-3111

Model	Single Unit	2 Units	3 Units	4 Units	5 Units
PEL-3021	150V	150V	150V	150V	150V
	35A	70A	105A	140A	175A
	175W	350W	525W	700W	875W
PEL-3041	150V	150V	150V	150V	150V
	70A	140A	210A	280A	350A
	350W	700W	1050W	1400W	1750W
PEL-3111	150V	150V	150V	150V	150V
	210A	420A	630A	1680A	1050A
	1050W	2100W	3150W	4200W	5250W

Parallel Capacity, PEL-3021H, PEL-3041H, PEL-3111H

Model	Single Unit	2 Units	3 Units	4 Units	5 Units
PEL-3021H	800V	800V	800V	800V	800V
	8.75A	17.5A	26.25A	35A	43.75A
	175W	350W	525W	700W	875W
PEL-3041H	800V	800V	800V	800V	800V
	17.5A	35A	52.5A	70A	87.5A
	350W	700W	1050W	1400W	1750W
PEL-3111H	800V	800V	800V	800V	800V
	52.5A	105A	157.5A	210A	262.5A
	1050W	2100W	3150W	4200W	5250W

Parallel Capacity, PEL-3211

Model	No. of V Units	V	I	Total Sink Current PEL-3111+ PEL-3211	Total Power PEL-3111 + PEL-3211
PEL-3111: Master	x 1	150V	210A	N/A	N/A
	x 1	150V	420A	630A	3150W
PEL-3211: Slave Boosters	x 2	150V	840A	1050A	5250W
	x 3	150V	1260A	1470A	7350W
	x 4	150V	1680A	1890A	9450W



The PEL-3211 booster packs do not have a control panel. They can only be used as slaves with a single PEL-3111 in parallel.

Parallel Capacity, PEL-3211H

Model	No. of Units	V	I	Total Sink Current PEL-3111H+ PEL-3211H	Total Power PEL-3111H + PEL-3211H
PEL-3111H: Master	x 1	800V	52.5A	N/A	N/A
	x 1	800V	105A	157.5A	3150W
PEL-3211H: Slave	x 2	800V	210A	262.5A	5250W
Boosters	x 3	800V	315A	367.5A	7350W
	x 4	800V	420A	472.5A	9450W



Note

The PEL-3211H booster packs do not have a control panel. They can only be used as slaves with a single PEL-3111H in parallel.

Connection

Description

The J1 and J2 connectors are used for control during parallel operation. Up to 5 units can be used in parallel.



Note

Only the rear panel terminals can be used for parallel operation, the front panel terminals have a lower current rating and thus should not be used for parallel operation.

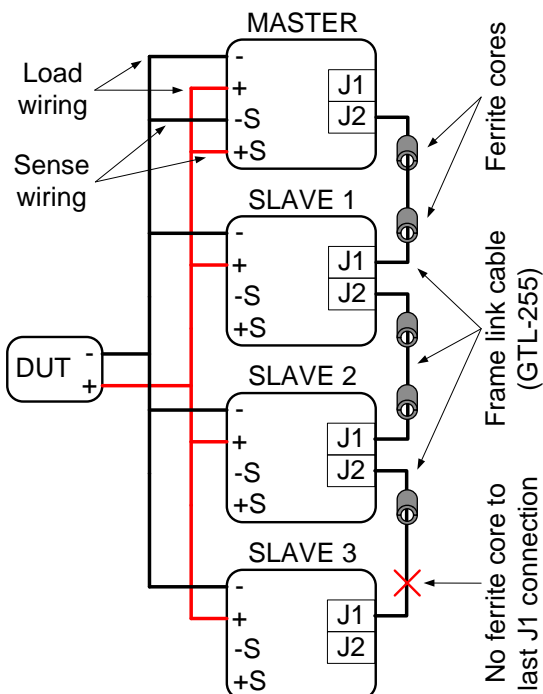

! Cautions

Only the rear terminals can be used for parallel connections.

Make sure all connections are correct before turning on the load. Incorrect connections could damage the units.

Only units of the same type and rating can be used in parallel (except for when the PEL-3211(H) booster pack is used with the PEL-3111(H)).

Ensure that wiring of sufficient gauge is used when using parallel connections.

If using remote sense, only connect the master to the voltage sense terminals.

Configuration

Description	When using the multiple units in parallel all the basic settings are adopted from the master unit.
Operation	<ol style="list-style-type: none"> 1. Make sure all load units are turned off. 2. Make sure the DUT is turned off. 3. Connect the load units to the DUT. <ul style="list-style-type: none"> • Ensure the wire gauge is sufficient to handle the increase in current 4. Connect the Master unit to the slave units via the J1/J2 connectors*. <ul style="list-style-type: none"> • Use the GTL-255 frame link cables • Connect from: Master J2 → Slave1 J1 Slave1 J2 → Slave2 J1 and so on. • Remove one ferrite core from the last frame link cable. Remove the ferrite core that is closest to the J1 connector on the last slave unit. See the diagram below for details. 5. Turn the load units on. 6. On the designated master unit, press  > <i>Configure [F5] > Next Menu [F4] > Parallel[F1]</i>. 7. Set the unit to <i>Master</i> with the <i>Operation</i> setting. 8. Assign the number of attached slave units or booster units with the <i>Parallel</i> and <i>Booster</i> settings. <ul style="list-style-type: none"> • A maximum of 5 units can be used in parallel. <p>A maximum of 4 boosters can be used with a single PEL-3111(H), acting as a master unit.</p>

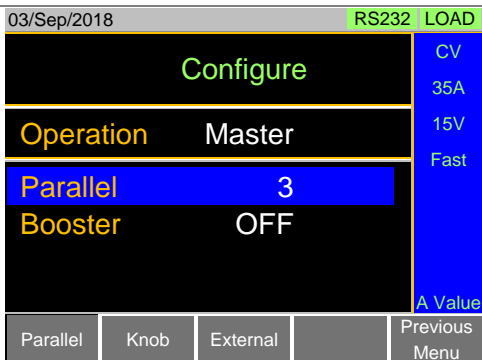

9. On the slave units, press **Main** > *Configure* [F5] > *Next Menu* [F4] > *Parallel*[F1] > and set *Operation* to *Slave*.

 - When in Slave mode, all keys are locked, except for the Scroll wheel and Enter key.



*Failing to remove the last ferrite core from the GTL-255 cable may reduce the stability of the units when used in parallel.

Turning the Load On

Description Operating the PEL-3000(H) Series in parallel mode is the same as for single units.



Note

When using the units in parallel, the load line inductance could be increased or the stability of the units could be reduced. It may be necessary to reduce the response speed setting to increase stability.

1. Turn the slave and master units on.
2. Set the operation mode and settings on the master unit.
 - The master's settings will be used by the slave units.
3. Turn the load on from the Master unit.
 - All measurements will be displayed and updated on the Master unit only.

Disable Parallel Mode

Description To disable parallel mode, each unit must be set as a "Master".

- Operation**
1. Turn the power off on all the units and remove the GTL-255 frame link cables.
 2. Turn the power back.
 3. On each unit, press **Main** > *Configure [F5]* > *Next Menu [F4]* > *Parallel[F1]*.
 4. Set the unit to *Master* with the *Operation* setting.
 5. Turn the *Parallel* and *Booster* settings to *Off*.
-

R

REMOTE CONTROL

This chapter describes basic configuration of IEEE488.2 based remote control. For a command list, refer to the programming manual, downloadable from GW Instek website, www.gwinstek.com

Interface Configuration	212
Configure to USB Remote Interface	212
Configure GPIB Interface.....	212
Configure RS232C	214
RS232C/USB Remote Control Function Check	215
Using Realterm to Establish a Remote Connection	216
GPIB Function Check	219
Configuring Ethernet Connection	222
Socket Server Function Check	225
Web Server Function Check	231

Interface Configuration

Configure to USB Remote Interface



USB configuration	PC side connector	Type A, host
	PEL-3000(H) side connector	Rear panel Type B, slave
	Speed	2.0 (full speed)
	USB Class	USB CDC ACM



Note

Before USB can be used for remote control, it is necessary to install the PEL-3000(H) USB device driver, located on the accompanying User Manual CD.



Operation

1. Connect the USB cable to the rear panel USB B port.
2. Press  +  > *Interface*[F3] and set the *Interface* setting to *USB*.

Configure GPIB Interface

To use GPIB, the optional GPIB port must be installed. See page 240 for installation details.

Operation

1. Ensure the PEL-3000(H) is off before proceeding.
2. Connect a GPIB cable from a GPIB controller to the GPIB port on the PEL-3000(H).
3. Turn the PEL-3000(H) on.
4. Press  +  > *Interface*[F3] and set the *Interface* setting to *GPIB*.

3. Set the GPIB address.

GPIB address 0-30

GPIB constraints

- *Maximum 15 devices altogether, 20m cable length, 2m between each device*
- *Unique address assigned to each device*
- *At least 2/3 of the devices turned On*
- *No loop or parallel connection*

Pin Assignment

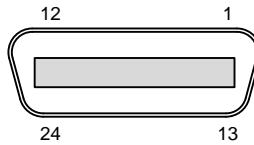

4.

Pin	Signal	Pin	Signal
1-4	Data I/O 1-4	13-16	Data I/O 5-8
5	EOI	17	REN
6	DAV	18	Ground (DAV)
7	NRFD	19	Ground (NRFD)
8	NDAC	20	Ground (NDAC)
9	IFC	21	Ground (IFC)
10	SRQ	22	Ground (SRQ)
11	ATN	23	Ground (ATN)
12	SHIELD Ground	24	Single GND

Configure RS232C

RS232C Configuration	Connector	DB-9, Male
	Baud Rate	2400, 4800, 9600, 19200, 38400
	Stop Bit	1, 2
	Parity	None, Odd, Even

- Operation
1. Connect an RS232C cable from the PC to the rear panel RS232 port.
 2. Press **Shift** + **Help** ^{Utility} > *Interface*[F3] and set the *Interface* setting to RS232.
 3. Set the *Baud Rate*, *Stop Bit* and *Parity* settings.

Pin Assignment

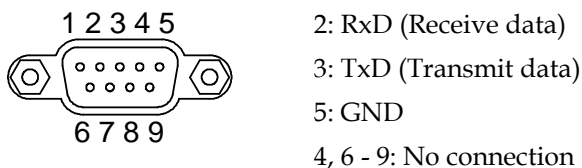

PC Connection Use a null modem connection as shown in the diagram below.

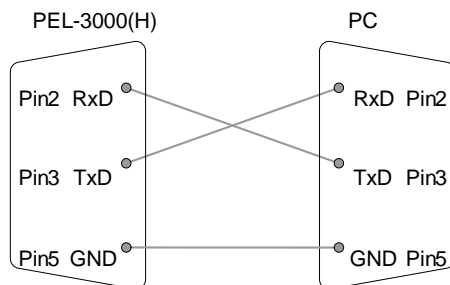

RS232C/USB Remote Control Function Check

Functionality
check

Invoke a terminal application such as Realterm.

For RS-232C, set the COM port, baud rate, stop bit, data bit and parity accordingly.

The USB connection emulates a COM port on the PC. To check the COM settings in Windows, see the Device Manager. For example, for Win 7 go to the Control panel → Hardware and Sound → Device Manager.



Note

If you are not familiar with using a terminal application to send/receive remote commands from the serial port or via a USB connection, please page 216 (Using Realterm to Establish a Remote Connection) for more information.

Run this query command via the terminal after the instrument has been configured for RS-232C/USB remote control (page 214).

*idn?

This should return the Manufacturer, Model number, Serial number, and Firmware version in the following format.

- *GW-INSTEK, PEL-3000(H), XXXXXXXXXXXXX, V.X.X.X*

Manufacturer: GW-INSTEK

Model number : PEL-3000(H)

Serial number : XXXXXXXXXXXXX

Firmware version : V.X.X.X



Note

For further details, please see the programming manual, available on the GW Instek web site @ www.gwinstek.com.

Using Realterm to Establish a Remote Connection

Background Realterm is a terminal program that can be used to communicate with a device attached to the serial port of a PC or via an emulated serial port via USB.

The following instructions apply to version 2.0.0.70. Even though Realterm is used as an example to establish a remote connection, any terminal program can be used that has similar functionality.



Note

Realterm can be downloaded on Sourceforge.net free of charge.

For more information please see <http://realterm.sourceforge.net/>

Operation

1. Download Realterm and install according to the instructions on the Realterm website.
2. Connect the PEL-3000(H) via USB (page 212) or via RS232 (page 214).
3. If using RS232, make note of the configured baud rate, stop bits and parity.
4. Go to the Windows device manager and find the COM port number for the connection. For example, go to the Start menu > Control Panel > Device Manager

Double click the *Ports* icon to reveal the connected serial port devices and the COM port for the each connected device.

If using USB, the baud rate, stop bit and parity settings can be viewed by right-clicking connected device and selecting the *Properties* option.

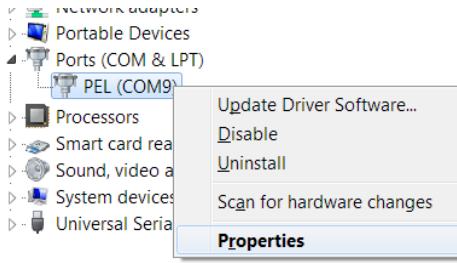

5. Start Realterm on the PC as an administrator.
Click:
Start menu>All Programs>RealTerm>realterm

Tip: to run as an administrator, you can right click the Realterm icon in the Windows Start menu and select the *Run as Administrator* option.

6. After Realterm has started, click on the *Port* tab.
Enter the *Baud*, *Parity*, *Data bits*, *Stop bits* and *Port* number configuration for the connection.
The *Hardware Flow Control*, *Software Flow Control* options can be left at the default settings.
7. Press *Open* to connect to the PEL-3000(H).

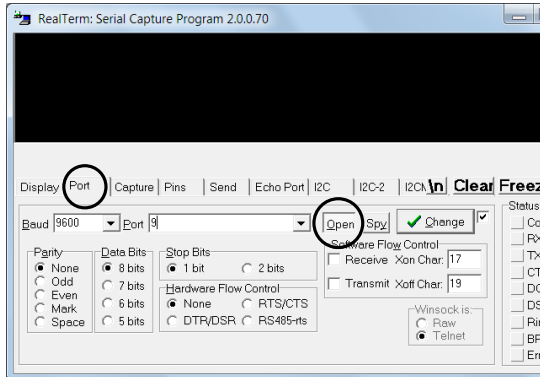

- Click on the *Send* tab.

In the *EOL* configuration, check on the *+CR* and *+LF* check boxes.

Enter the query:

**idn?*

Click on *Send ASCII*.

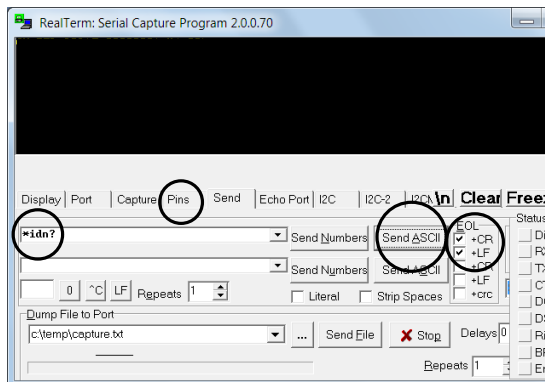

- The terminal display will return the following:
 GW, PEL-3XXX(H),XXXXXXXX,VX.XX.XXX
 (manufacturer, model, serial number, version)
- If Realterm fails to connect to the PEL-3000(H), please check all the cables and settings and try again.

GPIB Function Check

Functionality check Please use the National Instruments Measurement & Automation Controller software to confirm GPIB functionality.

See the National Instrument website,
<http://www.ni.com> for details.



Note

For further details, please see the programming manual, available on the GW Instek web site @ www.gwinstek.com.

Operation

1. Start the NI Measurement and Automation Explorer (MAX) program. Using Windows, press:



Start>All Programs>National Instruments>Measurement & Automation

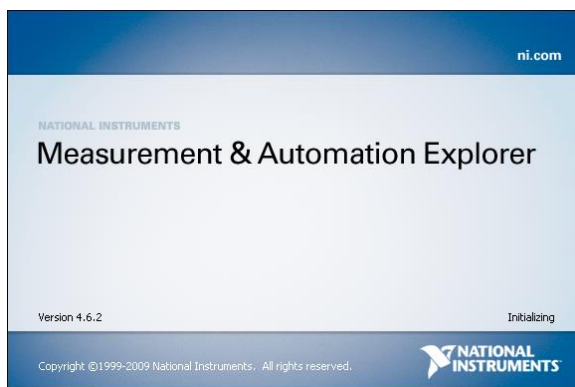

2. From the Configuration panel access;
My System>Devices and Interfaces>GPIB0
3. Press the Scan for Instruments button.

4. In the *Connected Instruments* panel the PEL-3000(H) should be detected as *Instrument 0* with the address the same as that configured on the PEL-3000(H).
5. Double click the *Instrument 0* icon.

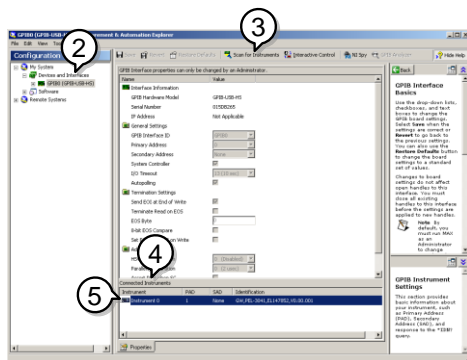

6. Click on *Communicate with Instrument*.
7. In the *NI-488.2 Communicator* window, ensure **IDN?* is written in the *Send String:* text box.

Click on the *Query* button to send the **IDN?* query to the instrument.

8. The *String Received* text box will display the query return:

GW, PEL-3XXX(H),XXXXXXXX,VX.XX.XXX
 (manufacturer, model, serial number, version)

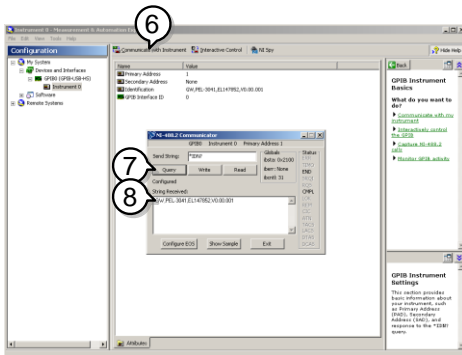

9. The function check is complete.



Note

For USB CDC function check, please refer to the section “RS232 and USB CDC function check” on page 215

Configuring Ethernet Connection

Background When using Ethernet a number of parameters need to be set. These include DHCP On/Off, IP Address, Subnet Mask and Gateway. When setting Ethernet parameters, ensure they match that of the network.

Parameters	DHCP	On/Off			
	IP Address	0~255	0~255	0~255	0~255
	Subnet Mask	None/Odd/Even			
	Gateway	0~255	0~255	0~255	0~255

Configuration This configuration example will configure the PEL-3000(H) socket server.

The following configuration settings will manually assign the PEL-3000(H) an IP address and enable the socket server. The socket server port number is fixed at 2268.

- Steps**
1. Connect an Ethernet cable from the network to the rear panel Ethernet port. You will see the led indicator next to Ethernet port lighting.



Rear panel of PEL-3000 Rear panel of PEL-3000H

2. Power on the PEL-3000(H).

Panel operation 3. Press the Shift Key then the Help key to access the Utility menu.

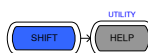

4. Press F3(Interface Menu).

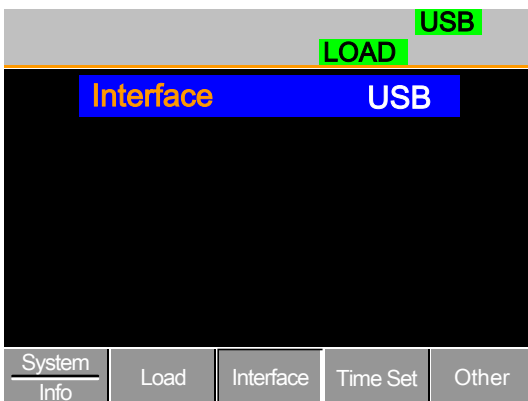

5. If the Interface mode is not Ethernet, use the Selector knob to edit Interface.

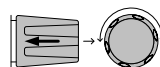

6. Choose Ethernet.



7. Press the Selector knob to confirm.

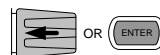

8. The Ethernet Menu appears.

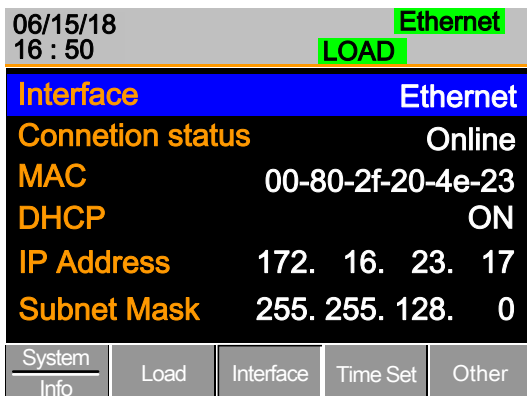

Use the Selector knob to edit DHCP, IP Address, Subnet Mask and Gateway setting.

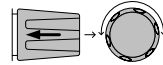

Note

If the DHCP set to ON, the IP Address, Subnet Mask and Gateway settings will be configured by the DHCP Server of the network automatically. These settings will show up after the PEL-3000(H) get the information by DHCP.



Note

If the DHCP set to OFF, make sure the IP address, Subnet Mask, and Gateway settings match that of the network.

Socket Server Function Check

Background To test the socket server functionality, National Instruments Measurement and Automation Explorer can be used. This program is available on the NI website, www.ni.com, via a search for the VISA Run-time Engine page, or “downloads” at the following URL, <http://www.ni.com/visa/>

Requirements Operating System: Windows XP, 7, 8, 10

- Functionality check**
1. Start the NI Measurement and Automation Explorer (MAX) program. Using Windows, press:
Start>All Programs>National Instruments>Measurement & Automation
 2. From the Configuration panel access;
My System>Devices and Interfaces>Network Devices
 3. Press Add New Network Device>Visa TCP/IP Resource...

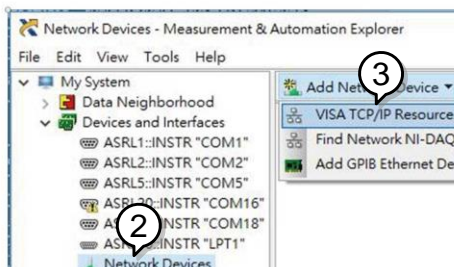

4. Select *Manual Entry of Raw Socket* from the popup window.

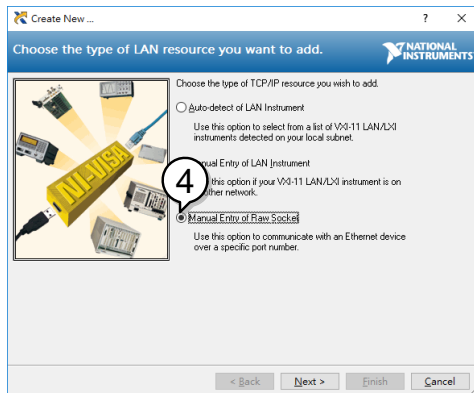

5. Enter the IP address and the port number of the RMX-4000. The port number is fixed at 2268.
6. Click the Validate button.

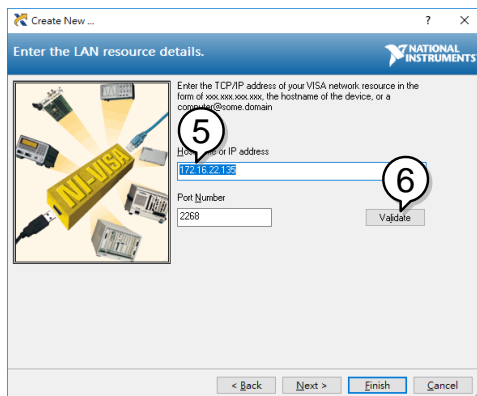

7. A popup will appear if a connection is successfully established. If not, check the Load device IP address configure. Then click OK button and Next button.

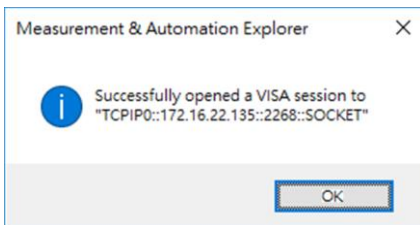

8. Click the Finish button.

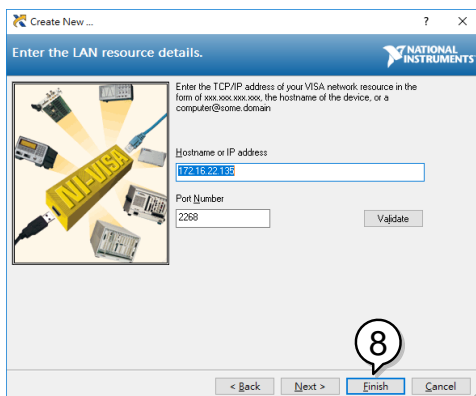

9. You can see the network device is setup successful. Click *Open VISA Test Panel*.

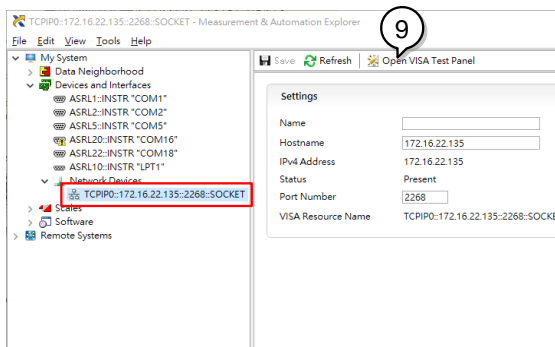

10. In the TCP/IP Settings page. You can see the information of TCP/IP.

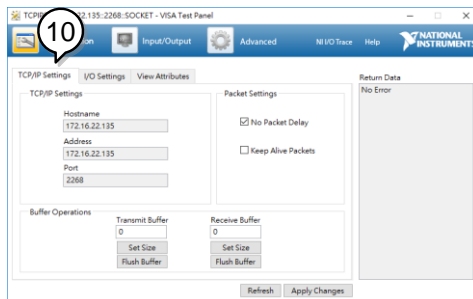

11. Click on I/O Settings.
12. Make sure the *Enable Termination Character* check box is checked, and the terminal character is \n (Value: xA).
13. Click *Apply Changes*.

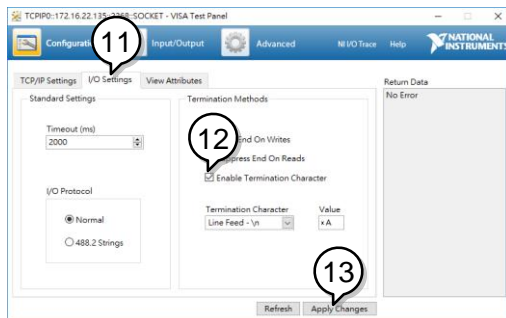

14. Click the *Input/Output* icon.
15. Enter **IDN?\n* in the *Select or Enter Command* dialog box if it is not already.

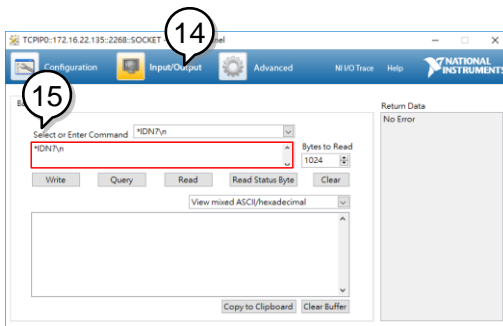

16. Click the *Query* button.

17. The *IDN?\n query will return the Manufacturer, model name, serial number and firmware version in the dialog box.

GW Instek,PEL-3000(H),00000001, V108\n

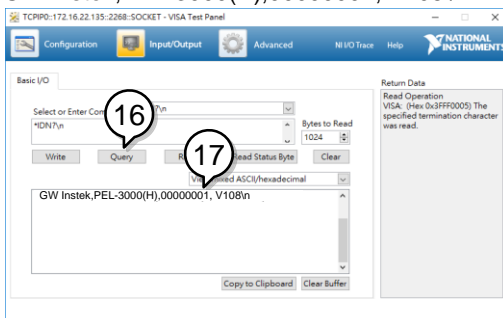

18. You can key in the command “:SYST:ERR\n”

19. Click the *Query* button. You will get the return messagn of error.

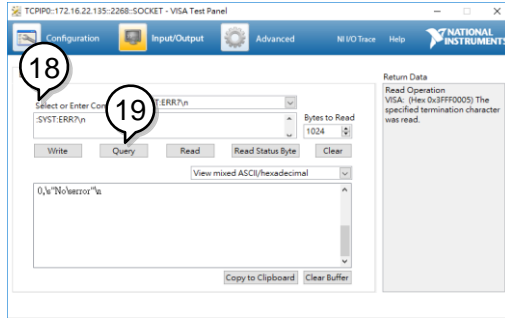

Web Server Function Check

Functionality check

The web server allows you to check the function settings of the PEL-3000(H).

Enter the IP address of the PEL-3000(H) in a web browser.

The web browser interface appears.

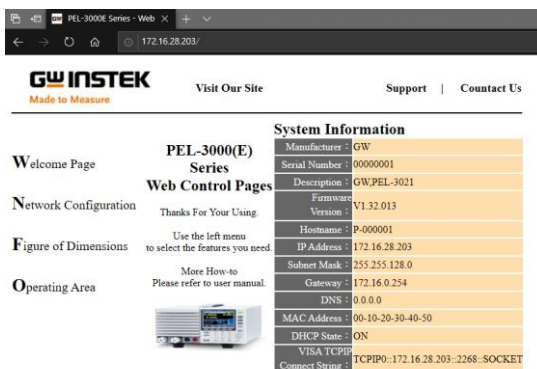

Copyright 2019 © Good Will Instrument Co., Ltd. All Rights Reserved.

The web browser interface allows you to access the following:

- Network configuration settings
- PEL-3000(H) dimensions
- Operating area diagram

You can click the Network Configuration to see the configuration information.

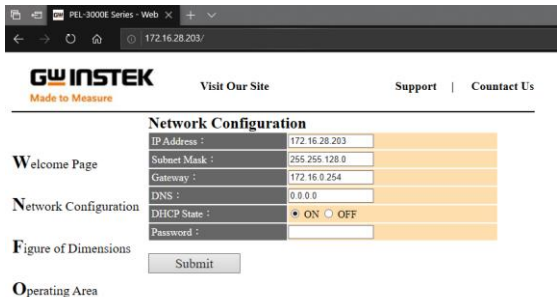

You can click the Figure of dimension to see the device dimensions information.

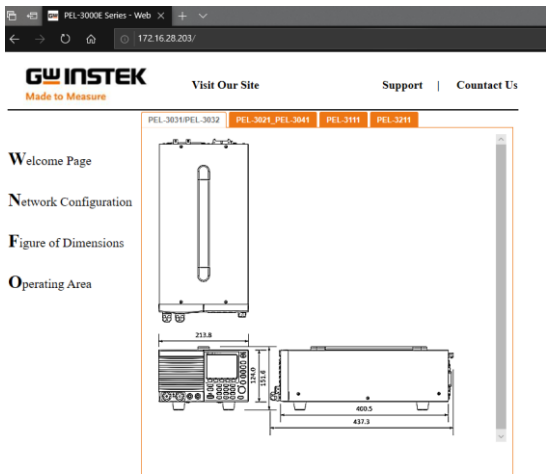

You can click the Operating area to see the Load operating area.

The screenshot displays the web interface for the PEL-3000E Series. The browser address bar shows the URL 172.16.28.203/. The page header includes the GW INSTEK logo with the tagline "Made to Measure", and navigation links for "Visit Our Site", "Support", and "Contact Us".

On the left side, there is a vertical menu with the following items:

- Welcome Page
- Network Configuration
- Figure of Dimensions
- Operating Area

The main content area features a navigation bar with tabs for different models: PEL-3031E, PEL-3032E, PEL-3021, PEL-3041, PEL-3111, and PEL-3211. Below this, there are two graphs:

CC/CV Operating Range High and Low comparing

This graph plots Value (log scale from 0.001 to 1000) against Current (0 to 70). It shows two curves: a blue line for the High Range and a red line for the Low Range. The High Range curve starts at approximately 100 at 0 current and decreases to about 10 at 70 current. The Low Range curve starts at approximately 0.1 at 0 current and increases to about 1 at 70 current.

CP Operating Range High and Low comparing

This graph is partially visible at the bottom of the screenshot, showing Value (log scale from 0.001 to 1000) against Current (0 to 70). It also features High Range (blue) and Low Range (red) curves.

FAQ

- The load voltage indicated on the load module is below expected.
- The front panel keys are not working.
- The load won't turn on.
- The performance does not match the specification

The load voltage indicated on the load module is below expected.

Ensure the load leads are as short as possible, twisted and use the appropriate wire gauge. Ensure that voltage sense is used, this can help alleviate the voltage drop across the load the leads.

The front panel keys are not working.

Check to make sure that the key lock has not been activated. LOCK will be shown on the panel when the screen is locked. Press Shift + Lock to unlock the keys.

The load won't turn on.

If you are using the load key to try to turn the load on and the load won't turn on, it is possible that external control is activated and that the LoadOn In setting is set to low. See page 194 for details.

The performance does not match the specification.

Make sure the device is powered On for at least 30 minutes, within +20°C-+30°C. This is necessary to stabilize the unit to match the specification.

For more information, contact your local dealer or GWInstek at www.gwinstek.com / marketing@goodwill.com.

APPENDIX

Replacing the Dust Filter	238
Replace the Clock Battery.....	239
GPIB Installation	240
Ethernet Card Installation	241
PEL-3000(H) Default Settings	242
Frame Control Connector Contacts	245
J1 Connector.....	245
J2 Connector.....	253
Monitor Out ports J3 (PEL-3021H/PEL-3041H/PEL-3111H)	254
J1 Connector Booster.....	254
J2 Connector Booster.....	257
Operating Mode Description	259
CC Mode	259
CR Mode.....	260
CP Mode.....	262
CV Mode	263
Operating Area	264
PEL-3000 Specifications	271
Rating (Master / Slave)	271
Rating (Booster / Slave).....	271
CC Mode	272
CR Mode.....	273
CV Mode	273
CP Mode.....	274
Slew Rate	274
Meter	275
Dynamic Mode	276
Soft Start.....	278
Remote Sensing.....	278
Protection Function.....	278
Sequence.....	279
Other	279

Analog External Control	280
Front Panel BNC Connector	281
General.....	281
PEL-3000H Specifications	283
Rating (Master / Slave)	283
Rating (Booster / Slave)	283
CC Mode	284
CR Mode	285
CV Mode	285
CP Mode.....	286
Slew Rate	286
Meter	287
Dynamic Mode.....	288
Soft Start.....	290
Remote Sensing.....	290
Protection Function	291
Sequence.....	291
Other.....	292
Analog External Control	292
Front Panel BNC Connector.....	293
General.....	294
PEL-3000(H) Dimensions	295
PEL-3111	295
PEL-3021, PEL-3041	296
PEL-3211	297
Declaration of Conformity.....	298

Replacing the Dust Filter

Background The dust filter should be replaced twice a year. Not replacing the filter will reduce performance and may cause the PEL-3000(H) to malfunction.

- Procedure**
1. Turn the PEL-3000(H) off completely at the rear panel power switch.
 2. Gently lift the grill up from the bottom.

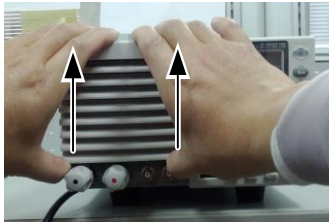

3. Remove the filter from the grill and replace with GW Instek part number: PEL-010.

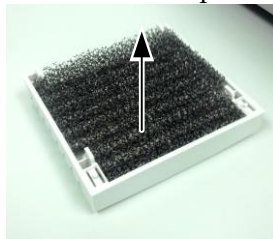

Replace the Clock Battery

Background

The system clock keeps time using a user-replaceable battery.

The battery should be replaced approximately every 3 years.

Battery type: CR123A

Procedure

1. Turn off the PEL-3000(H) and remove the case.
 - First remove the handle by carefully removing the plastic tabs and then unscrewing the two screws connecting the handle to the case.
 - A total of 10 screws should be removed from the case.
2. Remove the battery and replace with the same type and rating.
 - The battery is located on the right hand side, near the rear panel.



GPIB Installation

Background GPIB is an optional extra. The following instructions describe how to install the optional GPIB card if necessary.

- Procedure**
1. Turn off the PEL-3000(H).
 2. Remove the two screws holding the cover on the option bay.
 3. Slide the GPIB card onto the rails in the option bay.
 4. Re-screw the screws back into place.
-

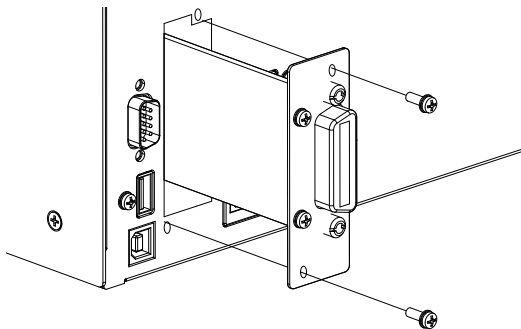

Ethernet Card Installation



WARNING

To avoid static electricity, please use appropriate anti-static work practices.

LAN Card installation

The PEL-3000(H) has ethernet card as a standard.

Steps

1. Ensure the mainframe is disconnected from mains power.
2. Remove the screws from the ethernet card cover plate and remove the cover plate from the rear panel.
3. Slide the ethernet card into the slot and push gently until the back plate is flush with the rear panel.

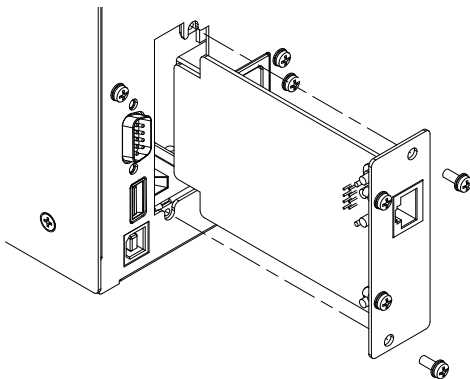

4. Use the screws that were removed from step 1 to secure the ethernet card.

PEL-3000(H) Default Settings

The following default settings are the factory configuration settings for the PEL-3000(H).

Main Settings		
Item	Panel Settings	Setup Memory Settings (all 100 sets)
Current(CC)	0 A	0 A
Conductance(CR)	0 S	0 S
Voltage(CV)	Maximum value	Maximum value
Wattage(CP)	0 W	0 W
+CV	OFF	OFF
Current range	H	H
Voltage range	150 V/800 V	150 V/800 V
Load on/off	Load off	Load off
Operation mode	CC	CC
Slew rate	Maximum value of H range	Maximum value of H range
Preset memories	Settings above in each mode	Settings above in each mode
Main > Configure > Protection		
Item	Panel Settings	Setup Memory Settings (all 100 sets)
OCP Level	Maximum value	Maximum value
OCP Setting	LIMIT	LIMIT
OPP Level	Maximum value	Maximum value
OPP Setting	LIMIT	LIMIT
UVP value	OFF	OFF
OVP value	OFF	OFF
Main > Configure > Other		
Item	Panel Settings	Setup Memory Settings (all 100 sets)
Soft Start	OFF	OFF
Von Voltage	0.00V	0.00V
Von Latch	ON	ON
Von Delay	2.0 ms	2.0 ms
Von Delay-CR	5.0 ms	5.0 ms
Short Key	Toggle	Toggle

Count Time(elapsed time display)	OFF	OFF
Cut Off Time	OFF	OFF
Response	1/1	1/1
Mem.Recall	Safety	Safety
Dyna. Level	Value	Value
Dyna. Time	T1/T2	T1/T2
CR Unit	mS	mS

Main > Configure > Go-NoGo

Item	Panel Settings	Setup Memory Settings (all 100 sets)
SPEC. Test	OFF	OFF
Delay Time	0.0s	0.0s
Entry Mode	Value	Value
High	Maximum Voltage / Maximum Current	Maximum Voltage / Maximum Current
Low	Minimum Voltage / Minimum Voltage	Minimum Voltage / Minimum Voltage

Main > Configure > Next Menu > Parallel

Item	Panel Settings	Setup Memory Settings (all 100 sets)
Operation	Master	Master
Parallel	OFF	OFF
Booster	OFF	OFF

Main > Configure > Next Menu > Knob

Item	Panel Settings	Setup Memory Settings (all 100 sets)
Status	Step	Step
CCH Step	Resolution	Resolution
CCM Step	Resolution	Resolution
CCL Step	Resolution	Resolution
CRH Step	Resolution	Resolution
CRM Step	Resolution	Resolution
CRL Step	Resolution	Resolution
CVH Step	Resolution	Resolution
CVL Step	Resolution	Resolution
CPH Step	Resolution	Resolution
CPM Step	Resolution	Resolution
CPL Step	Resolution	Resolution

Main > Configure > Next Menu > External

Item	Panel Settings	Setup Memory Settings (all 100 sets)
Control	OFF	OFF
+CV Control	OFF	OFF
LoadOn IN	OFF	OFF
Sync-Mode	OFF	OFF

Frame Control Connector Contacts

J1 Connector

Pin name	Pin number	Description
EXT R/V CONT	1	Used for voltage/resistance control of CC, CR, CV and CP mode. 0V to 10V corresponds to 0% to 100% of the rated current (CC mode), rated voltage (CV mode), or rated power (CP mode). 0V to 10V corresponds to the maximum resistance to minimum resistance (CR mode) 0Ω to 10kΩ corresponds to 0% to 100% or 100% to 0% of the rated current (CC mode), rated voltage (CV mode), or rated power (CP mode). 0Ω to 10kΩ corresponds to maximum resistance to minimum resistance or minimum resistance to maximum resistance (CR mode)
IMON (Ext-V In (+) for +CV)	2	Current monitor output 10 V f.s (H/L range) and 1 V f.s (M range) Used for voltage control of Cx+CV mode (For PEL-3000H series only). 0V to 10V corresponds to 0% to 100% of the rated voltage.
A COM	3	Connected to the negative load input terminal on the rear panel.
SUM I MON	4	Used during master/slave operation. Connected to SUM I MON of the J2 connector.
PRL IN+	5	Used during master/slave operation. Connected to PRL OUT+ of the J2 connector.
PRL IN-	6	Used during master/slave operation. Connected to PRL OUT- of the J2 connector.
LOAD ON/OFF CONT	7	Turns on the load with low (or high) TTL level signal Pulled up the internal circuit to 5 V using 10 kΩ.
RANGE CONT 1	8	External range switch input*1 *2
RANGE CONT 0	9	Pulled up the internal circuit to 5 V using 10 kΩ.

ALARM INPUT	10	Activates alarm with low TTL level signal input. Pulled up the internal circuit to 5 V using 10 kΩ.
TRIG INPUT	11	When paused, clears the pause when a low level TTL signal is applied for 10 μ s or longer. Pulled down the internal circuit to A COM using approx. 100kΩ .
A COM	12	Connected to the negative load input terminal on the rear panel.
LOAD ON STATUS	13	Turns on when load is on. Open collector output by a photocoupler.*4
RANGE STATUS 1	14	Range status output*3. Open collector output by a photocoupler.*4
RANGE STATUS 0	15	photocoupler.*4
ALARM STATUS	16	Turns on when an alarm (OVP, OCP, OPP, OTP, RVP, or UVP) is activated or when an external alarm is applied. Open collector output by a photocoupler.*4
STATUS COM	17	STATUS signal common for pins 13 to 16.
RESERVED	18	RESERVED.
SHORT SIGNAL OUT	19	Relay contact output (30 VDC/1 A)
SHORT SIGNAL OUT	20	

*1 Valid only when the front panel settings are H range.

*2 RANGE CONT 0 RANGE CONT 1

H range	1	1
---------	---	---

M range	1	0
---------	---	---

L range	0	1
---------	---	---

*3 RANGE STATUS 0 RANGE STATUS 1

H range	OFF	OFF
---------	-----	-----

M range	OFF	ON
---------	-----	----

L range	ON	OFF
---------	----	-----

*4 The maximum applied voltage of the photocoupler is 30 V; the maximum current is 8 mA.

J2 Connector

Pin name	Pin number	Description
N.C.	1	Not connected.
N.C.	2	Not connected.
N.C.	3	Not connected.
SUM I MON	4	Connect to SUM I MON of the J1 connector.
PRL OUT+	5	Used during master/slave operation. Connected to PRL IN+ of the J1 connector.
PRL OUT-	6	Used during master/slave operation. Connected to PRL IN- of the J1 connector.
LOAD ON/OFF CONT	7	Turns on the load with low (or high) TTL level signal. Pulled up the internal circuit to 5V using 10k Ω .
N.C.	8	Not connected.
SLAVE RANGE CONT	9	Used during master/slave operation. Connected to RANGE CONT 0 of the J1 connector.
N.C.	10	Not connected.
N.C.	11	Not connected.
A COM	12	Connected to the negative load input terminal on the rear panel.
N.C.	13	Not connected.
N.C.	14	Not connected.
N.C.	15	Not connected.
ALARM INPUT	16	Activates an alarm with high (or low) TTL level signal input. Pulled up the internal circuit to 5 V.
A COM	17	Connected to the negative load input terminal.
N.C.	18	Not connected.
A COM	19	Connected the negative load input terminal.
+15V	20	Controls the on/off of the load booster power (cannot be used for multiple purposes).

Monitor Out ports J3 (PEL-3021H/PEL-3041H/PEL-3111H)

Pin name	Pin number	Description
I MON	1	Current monitor output 10V f.s (H/L range) and 1V f.s (M range)
V MON	2	Voltage monitor output 10V f.s
A COM	3	Connected to the negative load input terminal.
A COM	4	Connected to the negative load input terminal.

J1 Connector Booster

Pin name	Pin number	Description
N.C.	1	Not connected.
N.C.	2	Not connected.
A COM	3	Connected to the negative load input terminal.
SUM I MON	4	Connected to SUM I MON of the J2 connector.
PRL IN+	5	Connected to PRL OUT+ of the J2 connector.
PRL IN-	6	Connected to PRL OUT- of the J2 connector.
LOAD ON/OFF CONT	7	Turns on the load with low (or high) TTL level signal.
N.C.	8	Pulled up by the internal circuit to 5 V using 10 kΩ .
RANGE CONT 0	9	External range switch input*1 *2 Pulled up the internal circuit to 5 V using 10 kΩ .
ALARM INPUT	10	Activates an alarm with high (or low) TTL level signal input. Pulled up by the internal circuit to 5 V.
N.C.	11	Not connected.
A COM	12	Connected to the negative load input terminal on the rear panel.
N.C.	13	Not connected.
N.C.	14	Not connected.
N.C.	15	Not connected.
ALARM STATUS	16	Turns on when an alarm (OVP, OCP, OPP, OTP, RVP, or UVP) is activated or when an external alarm is applied. Open collector output by a photocoupler.*3
STATUS COM	17	STATUS signal common for pins 16.
N.C.	18	Not connected.

A COM	19	Connected to the negative load input terminal on the rear panel.
+15V	20	Controls the on/off of the load booster power (cannot be used for multiple purposes).

*1 Valid only when the front panel settings are H range.

*2 RANGE CONT 0

H range 1

M range 1

*3 The maximum applied voltage of the photocoupler is 30 V; the maximum current is 8 mA.

J2 Connector Booster

Pin name	Pin number	Description
N.C.	1	Not connected.
N.C.	2	Not connected.
N.C.	3	Not connected.
SUM I MON	4	Connect to SUM I MON of the J1 connector.
PRL OUT+	5	Used during master/slave operation. Connected to PRL IN+ of the J1 connector.
PRL OUT-	6	Used during master/slave operation. Connected to PRL IN- of the J1 connector.
LOAD ON/OFF CONT	7	
N.C.	8	Not connected.
SLAVE RANGE CONT		

9 Used during
master/slave
operation.
Connected to
RANGE CONT 0 of
the **J1** connector.

N.C.	10	Not connected.
N.C.	11	Not connected.
A COM	12	Connected to the negative load input terminal on the rear panel.
N.C.	13	Not connected.

N.C.	14	Not connected.
N.C.	15	Not connected.
ALARM INPUT	16	Activates an alarm with high (or low) TTL level signal input. Pulled up by the internal circuit to 5 V.
A COM	17	Connected to the negative load input terminal.
N.C.	18	Not connected.
A COM	19	Connected to the negative load input terminal.
+15V	20	Controls the on/off of the load booster power (cannot be used for multiple purposes).

Operating Mode Description

CC Mode

CC Mode When the unit is set to CC mode it will operate as a constant current load when connected to a constant voltage source. This means the unit will sink a designated amount of current, up to the rated power level, regardless of the voltage. This is illustrated below.

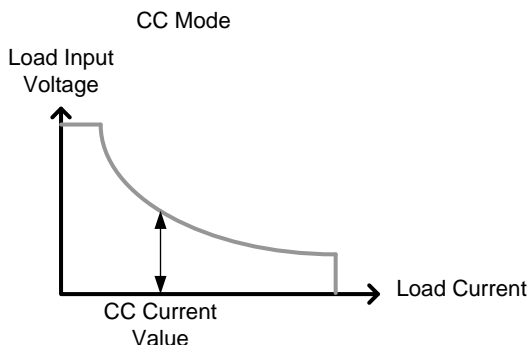

CC+CV Mode When CC+CV mode is enabled, the unit will act as constant current load after the input voltage is greater than the user-defined CV level. At the CV level, the unit works as a constant voltage load. This mode effectively creates a voltage ceiling before the unit operates in CC mode. The diagram below illustrates this.

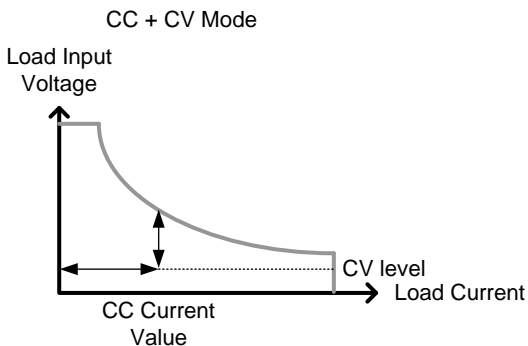

Note that when the source voltage is less than the CV level, no current will flow due to a very high impedance.

CR Mode

CR Mode

When the unit is set to CR mode it will operate as a constant resistance load when connected to a constant voltage (CV) or constant current (CC) source. This means the unit will maintain a set resistance, up to the rated power, regardless of the load voltage or current. When input voltage changes, the unit responds by changing the current load to maintain the set resistance according to ohm's law.

CV source : Load current = Load voltage / CR setting value

CC source : Load voltage = Load current x CR setting value

This is illustrated below.

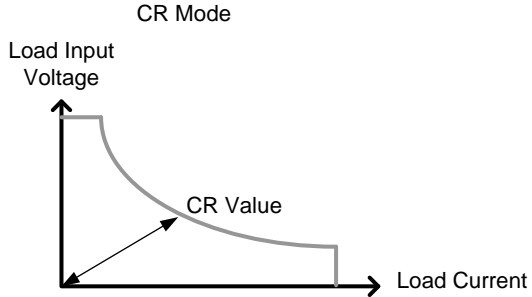

CR+CV Mode

When CR+CV mode is enabled, the unit will act as constant resistive load after the input voltage is greater than the user-defined CV level. At the CV level, the unit works as a constant voltage load. This mode effectively creates a voltage ceiling before the unit operates in CR mode. The diagram below illustrates this.

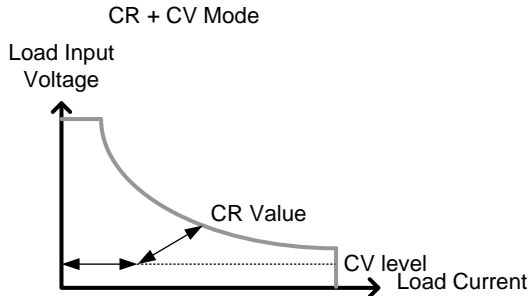

Note that when the source voltage is less than the CV level, no current will flow due to a very high impedance.

CP Mode

CP Mode When the unit is set to CP mode it will operate as a constant power load when connected to a constant voltage source. This means the unit will maintain a set power level, up to the rated current or voltage level, regardless of the input voltage. When input voltage changes, the unit responds by changing the current load to maintain the set power level accordingly ($P=I \times V$). This is illustrated below.

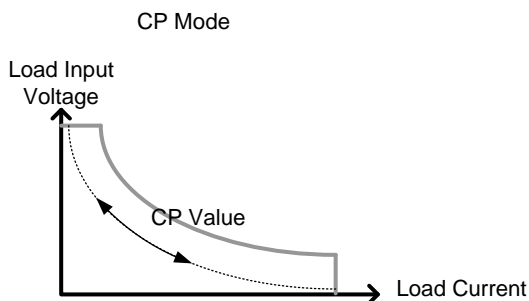

CP+CV Mode When CP+CV mode is enabled, the unit will act as a constant power load after the input voltage is greater than the user-defined CV level. At the CV level, the unit works as a constant voltage load. This mode effectively creates a voltage ceiling before the unit operates in CP mode. The diagram below illustrates this.

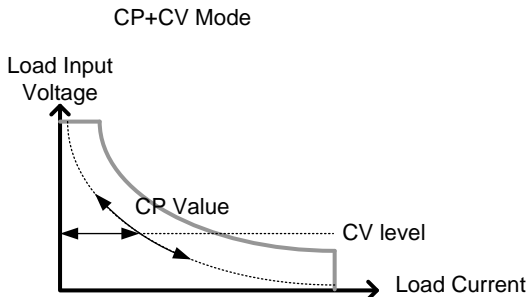

Note that when the source voltage is less than the CV level, no current will flow due to a very high impedance.

CV Mode

CV Mode

When the unit is set to CV mode it will operate as a constant voltage load when connected to a constant current source. This means the unit will maintain a set voltage level, up to the rated power, regardless of the input current. When the source voltage is less than the CV level, no current will flow due to a very high impedance. This is illustrated below.

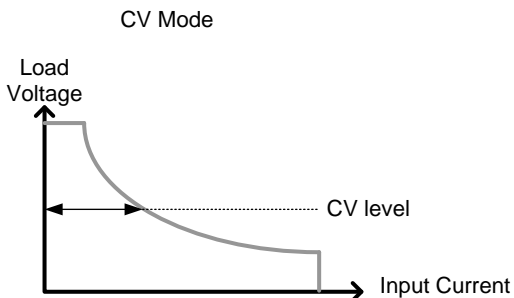

Operating Area

PEL-3021

PEL-3021 High Range Chart

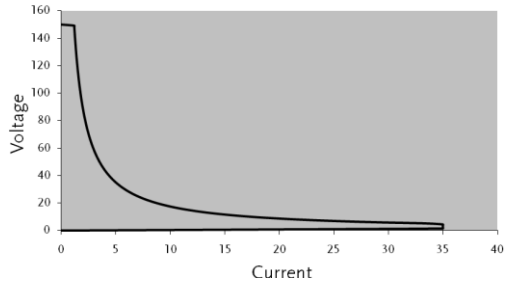

PEL-3021 Middle Range Chart

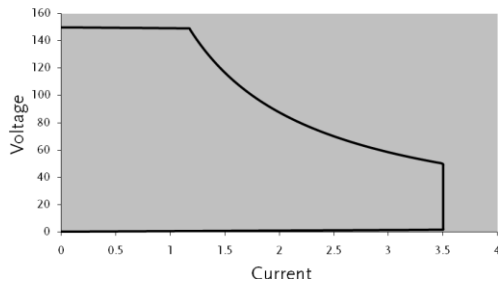

PEL-3021 Low Range Chart

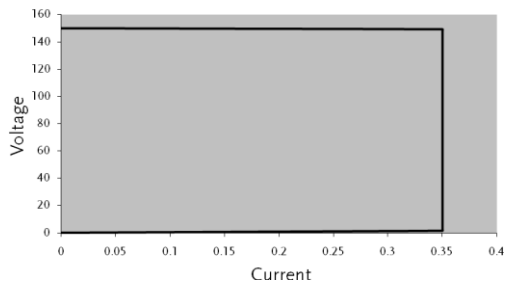

PEL-3041

PEL-3041 High Range Chart

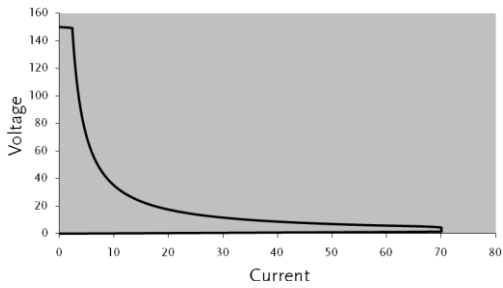

PEL-3041 Middle Range Chart

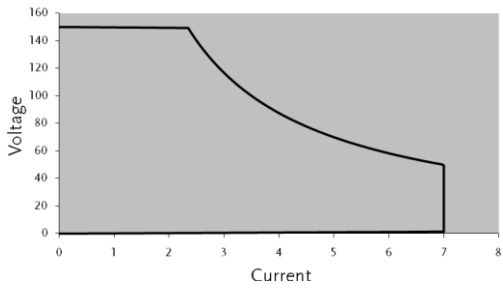

PEL-3041 Low Range Chart

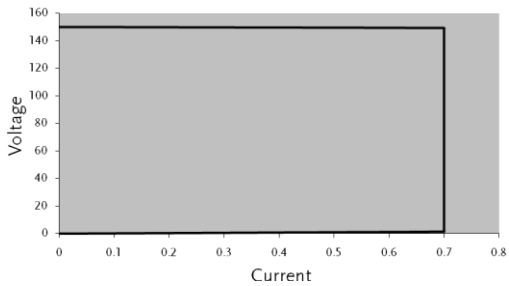

PEL-3111

PEL-3111 High Range Chart

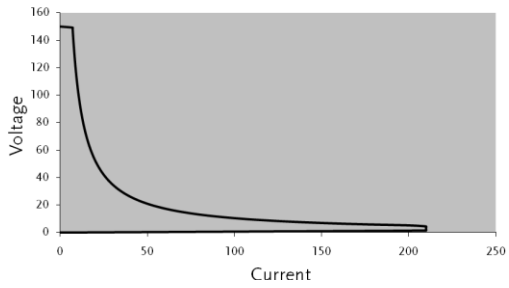

PEL-3111 Low Range Chart

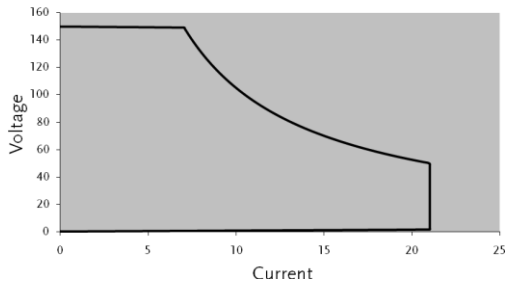

PEL-3111 Low Range Chart

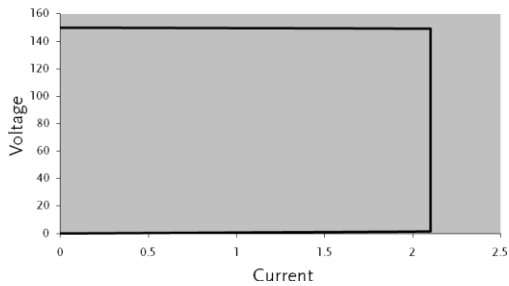

**PEL-3211
Booster Pack**

PEL-3211 High Range Chart

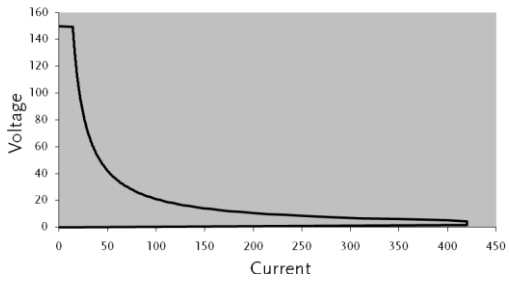

PEL-3021H

High Range Chart

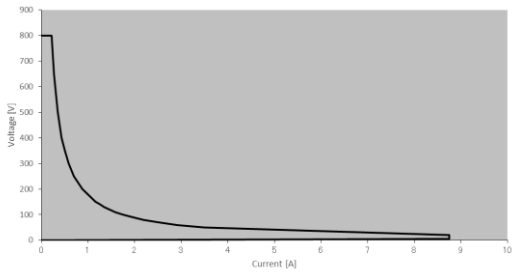

Middle Range Chart

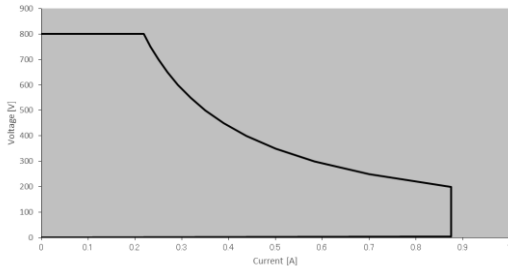

Low Range Chart

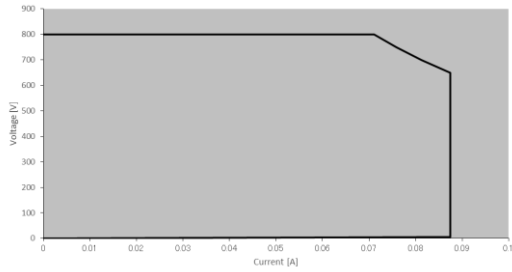

PEL-3041H

High Range Chart

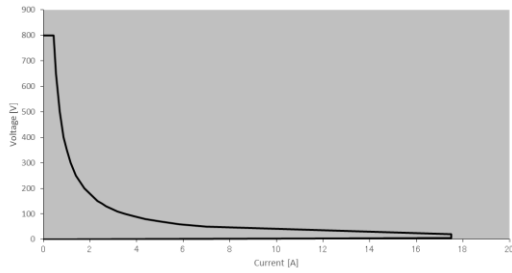

Middle Range Chart

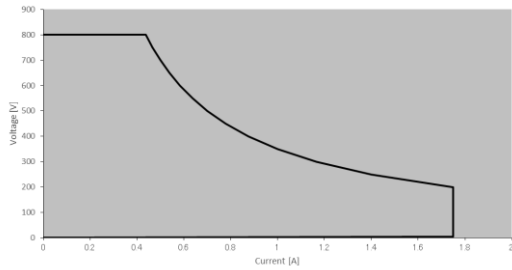

Low Range Chart

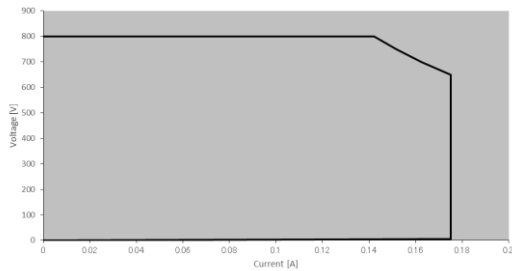

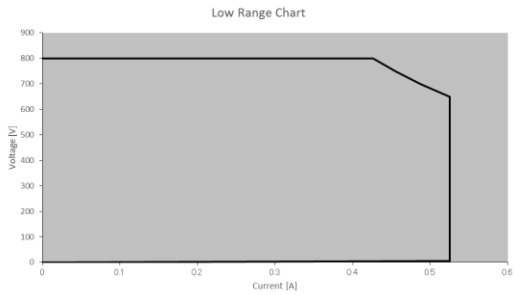
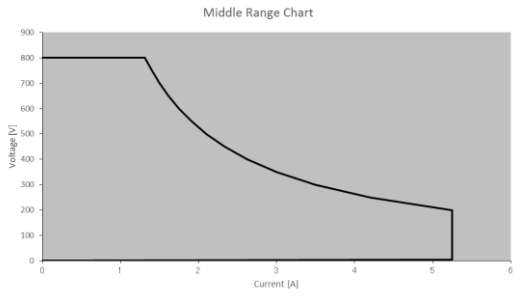
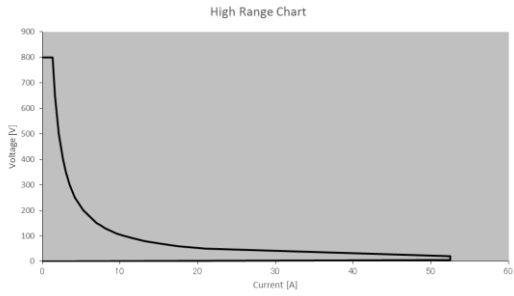
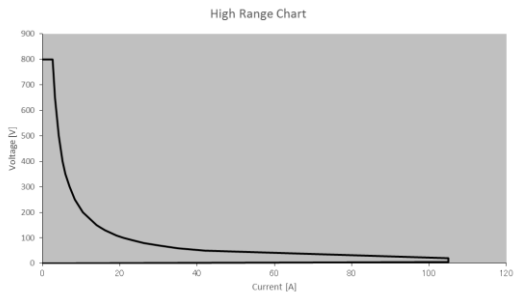
PEL-3111H**PEL-3211H
Booster Pack**

Middle Range Chart

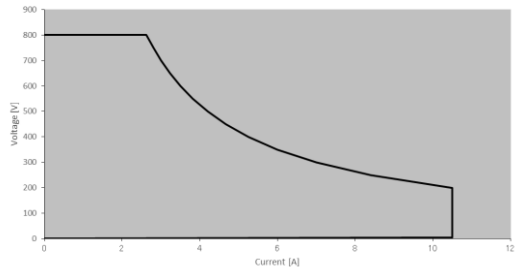

Low Range Chart

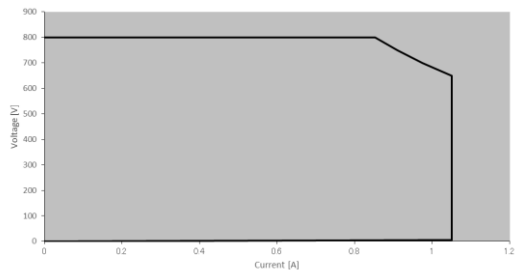

PEL-3000 Specifications

The specifications apply when the PEL-3000 is powered on for at least 30 minutes to warm-up to a temperature of $25^{\circ}\text{C} \pm 5^{\circ}\text{C}$, unless specified otherwise.

All specifications apply when using the rear panel terminals. If the front panel terminals are used or if operating with long cables, remote sense must be connected to the terminals.

In parallel mode: All operation/settings/resolution specifications are N times. This does not include voltage settings and measured values. The maximum slew rate settings also don't change.

N = Number of units in parallel (same model on master)

N = PEL-3111 + 2 x Number of units in parallel (PEL-3211)

Rating (Master / Slave)

Model	PEL-3021	PEL-3041	PEL-3111
Voltage	0V-150V		
Current	35A	70A	210A
Min. Operating Voltage	1.5 V at 35A	1.5 V at 70A	1.5 V at 210A
Power	175W	350W	1050W

Rating (Booster / Slave)

Model	PEL-3211
Voltage	0V-150V
Current	420A
Min. Operating Voltage	1.5 V at 420A
Power	2100W

Current Setting Accuracy

$\pm(1.2\% \text{ of set} + 1.1\% \text{ of f.s})$

M range applies to the full scale of H range.

Note: PEL-3211 only has H or M current ranges.

CC Mode

Model	PEL-3021	PEL-3041	PEL-3111
Operating Range			
H Range	0-35A	0-70A	0A-210A
M Range	0-3.5A	0-7A	0A-21A
L Range	0-0.35A	0-0.7A	0A-2.1A
Setting Range			
H Range	0-36.75A	0-73.5A	0-220.5A
M Range	0-3.675A	0-7.35A	0-22.05A
L Range	0-0.3675A	0-0.735A	0-2.205A
Default Setting			
H Range	0A	0A	0A
M Range	0A	0A	0A
L Range	0A	0A	0A
Resolution			
H Range	1mA	2mA	10mA
M Range	0.1mA	0.2mA	1mA
L Range	0.01mA	0.02mA	0.1mA
Accuracy of Setting			
H, M Range	$\pm(0.2\% \text{ of set} + 0.1\% \text{ of f.s}^{*1}) + V_{in}^{*2}/500 \text{ k}\Omega$		
L Range	$\pm(0.2\% \text{ of set} + 0.1\% \text{ of f.s}) + V_{in}^{*2}/500 \text{ k}\Omega$		
Parallel Operation $\pm(1.2\% \text{ of set} + 1.1\% \text{ of f.s}^{*3})$			
Input Voltage Variation^{*4}			
H Range	$2\text{mA} + V_{in}^{*2}/500\text{k}\Omega$	$4\text{mA} + V_{in}^{*2}/500\text{k}\Omega$	$10\text{mA} + V_{in}^{*2}/500\text{k}\Omega$
M Range	$2\text{mA} + V_{in}^{*2}/500\text{k}\Omega$	$4\text{mA} + V_{in}^{*2}/500\text{k}\Omega$	$10\text{mA} + V_{in}^{*2}/500\text{k}\Omega$
L Range	$0.1\text{mA} + V_{in}^{*2}/500\text{k}\Omega$	$0.2\text{mA} + V_{in}^{*2}/500\text{k}\Omega$	$0.6\text{mA} + V_{in}^{*2}/500\text{k}\Omega$
Ripple			
RMS ^{*5}	3mA	5mA	20mA ^{*7}
P.P ^{*6}	30mA	50mA	100mA ^{*7}

*1 Full scale of H range

*2 V_{in} : input terminal voltage of electronic load

*3 M range applies to the full scale of H range

*4 When the input voltage is varied from 1.5V to 150V at a current of rated power/150V

*5 Measurement frequency bandwidth: 10Hz to 1MHz

*6 Measurement frequency bandwidth: 10Hz to 20MHz

*7 At measurement current of 100A

CR Mode

Model	PEL-3021	PEL-3041	PEL-3111
Operating Range^{*1}			
H Range	23.3336S-400μS (42.857mΩ-2.5kΩ)	46.6672S-800μS (21.428mΩ-1.25kΩ)	140.0016S-2.4mS (7.1427mΩ-416.6667Ω)
M Range	2.33336S-40μS (428.566mΩ-25kΩ)	4.6667S-80μS (214.28mΩ-12.5kΩ)	14.0001S-242.4μS (71.427mΩ-4.16667kΩ)
L Range	0.233336S-4μS (4.28566Ω-250kΩ)	0.46667S-8μS (2.1428Ω-125kΩ)	1.40001S-24.24μS (714.27mΩ-41.6667kΩ)
Setting Range			
H Range	24.5S-0S (40.8163 mΩ-OPEN)	49.0S-0S (20.408 mΩ-OPEN)	147.000S-0S (6.8027 mΩ-OPEN)
M Range	2.45S-0S (408.1633mΩ-OPEN)	4.90S-0S (204.08mΩ-OPEN)	14.7000S-0S (68.0272mΩ-OPEN)
L Range	0.245S-0S (4.08163Ω-OPEN)	0.490S-0S (2.0408Ω-OPEN)	1.4000S-0S (680.2721mΩ-OPEN)
Resolution			
H Range	400μS	800μS	2.4mS
M Range	40μS	80μS	240μS
L Range	4μS	8μS	24μSs
Accuracy of Setting^{*2}			
H, M Range	$\pm(0.5\% \text{ of set}^{*3} + 0.5\% \text{ of f.s}^{*4}) + V_{in}^{*5}/500 \text{ k}\Omega$		
L Range	$\pm(0.5\% \text{ of set}^{*3} + 0.5\% \text{ of f.s}) + V_{in}^{*5}/500 \text{ k}\Omega$		
Parallel Operation	$\pm(1.2\% \text{ of set} + 1.1\% \text{ f.s}^{*4})$		

*1 Siemens[S] = Input current[A] / Input voltage[V] = 1 / resistance[Ω]

*2 Converted value at the input current. At the sensing point during remote sensing under the operating range of the input voltage.

*3 set = V_{in} / R_{set}

*4 f.s = Full scale of High Range

*5 V_{in} = Input terminal voltage of electronic load

CV Mode

Model	PEL-3021	PEL-3041	PEL-3111
Operating Range			
H Range		1.5V-150V	
L Range		1.5V-15V	
Setting Range			
H Range		0V-157.5V	

L Range	0V-15.75V
Resolution	
H Range	10mV
L Range	1mV
Accuracy of Setting*1	
H, L Range	$\pm(0.1 \% \text{ of set} + 0.1 \% \text{ of f.s})$
Input current variation*2	
H Range	50mV
L Range	12mV

*1 At the sensing point during remote sensing under the operating range of the input voltage. It is also applied for the condition of the parallel operation.

*2 With respect to a change in the current of 10 % to 100 % of the rating at an input voltage of 1.5 V (during remote sensing).

CP Mode

Model	PEL-3021	PEL-3041	PEL-3111
Operating Range			
H Range	17.5W -175W	35W-350W	105W -1050W
M Range	1.75W -17.5W	3.5W-35W	10.5W -105W
L Range	0.175W -1.75W	0.35W-3.5W	1.05W -10.5W
Setting Range			
H Range	0W-183.75W	0W-367.5W	0W-1102.5W
M Range	0W-18.375W	0W-36.75W	0W-110.25W
L Range	0W-1.8375W	0W-3.675W	0W-11.025W
Resolution			
H Range	10mW	10mW	100mW
M Range	1mW	1mW	10mW
L Range	0.1mW	0.1mW	1mW
Accuracy of Setting*1	$\pm(0.6 \% \text{ of set} + 1.4 \% \text{ of f.s}^{*2}) + V_{in}^{2*3}/500k\Omega$		

*1 It is not applied for the condition of the parallel operation.

*2 M range applies to the full scale of H range.

*3 V_{in} = Input terminal voltage of electric load.

Slew Rate

Model	PEL-3021	PEL-3041	PEL-3111
Setting Range (CC Mode)			
H Range	2.5mA/ μ s-2.5A/ μ s	5mA/ μ s-5A/ μ s	16.02mA/ μ s-16.002A/ μ s
M Range	250uA/ μ s-250mA/ μ s	500uA/ μ s-500mA/ μ s	1.602mA/ μ s-1.6002A/ μ s
L Range	25uA/ μ s-25mA/ μ s	50 μ A/ μ s-50mA/ μ s	160.2 μ A/ μ s-160.02mA/ μ s

Setting Range (CR Mode)			
H Range	250uA/μs-250mA/μs	500uA/μs-500mA/μs	1.602mA/μs-1.6002A/μs
M Range	25uA/μs-25mA/us	50uA/μs-50mA/us	160.2μA/us-160.02mA/μs
L Range	2.5μA/μs-2.5mA/μs	5uA/μs-5mA/μs	16.02μA/μs-16.002mA/us
Resolution			
Resolution	1mA	2mA	6mA
Setting	250mA/μs-2.5A/μs	500mA/μs-5A/μs	1.6A/μs-16A/μs
Resolution	100μA	200μA	600μA
Setting	25mA/us-250mA/μs	50mA/μs-500mA/μs	160mA/μs-1.6A/μs
Resolution	10μA	20μA	60μA
Setting	2.5mA/us-25mA/μs	5mA/μs-50mA/μs	16mA/μs-160mA/μs
Resolution	1μA	2μA	6μA
Setting	250uA/μs-2.5mA/μs	500uA/us-5mA/μs	1.6mA/us-16mA/μs
Resolution	100nA	200nA	600nA
Setting	25μA/μs-250μA/μs	50uA/μs-500uA/μs	160μA/us-1.6mA/μs
Resolution	10nA	20nA	60nA
Setting	2.5μA/μs-25μA/μs	5μA/μs-50uA/μs	16μA/μs-160μA/μs
Accuracy of Setting*1			
±(10% of set + 5μs)			

*1 Time to reach from 10 % to 90 % when the current is varied from 2 % to 100 % (20 % to 100 % in M range) of the rated current.

Meter

Model	PEL-3021	PEL-3041	PEL-3111
Voltmeter			
H Range	0.00V-150.00V		
L Range	0.000V-15.000V		
Accuracy	±(0.1 % of rdg + 0.1 % of f.s)		
Ammeter			
H Range	0.000A-35.000A	0.000A-70.000A	0.00A-210.00A
M Range	0.0000A-3.5000A	0.0000A-7.0000A	0.000A-21.000A
L Range	0.00mA-350.00mA	0.00mA-700.00mA	0.0mA-2100.0mA
Accuracy	±(0.2 % of rdg + 0.3 % of f.s*1)		
Accuracy	Parallel Operation: ±(1.2% of rdg +1.1% of f.s)		
Wattmeter			
H, M Range	0.00W-175.00W	0.00W-350.00W	0.00W-1050W
L(CC/CR/CV mode)	0.000W-52.500W	0.000W-105.000W	0.00W-315.00W
L(CP mode)	0.0000W- 1.7500W	0.0000W- 3.5000W	0.000W- 10.500W

Temperature Coefficient per °C	
Voltmeter	100ppm
Ammeter	200ppm

*1 M range applies to the full scale of H range.

Dynamic Mode

Model	PEL-3021	PEL-3041	PEL-3111
Operating Mode	CC, CR and CP		
T1 & T2	0.025ms - 10ms / Res: 1μs 10ms - 60s / Res: 1ms		
Accuracy	± 100ppm of setting		
Frequency Range (Freq./Duty)	1Hz -20kHz		
Frequency Resolution	1Hz-9.9Hz 0.1Hz 10Hz-99Hz 1Hz 100Hz-990Hz 10Hz 1kHz-20kHz 100Hz		
Frequency Accuracy of Setting	(0.5% of set)		
Duty Cycle of Setting (Freq./Duty)	1% -99% , 0.1% step		
The minimum time width is 10μs. Between 1kHz and 20kHz, the maximum duty cycle is limited by the minimum time width.			
Slew Rate Setting Range (CC Mode)			
H Range	2.5mA/μs-2.5A/μs	5mA/μs-5A/μs	16.mA/μs-16.A/μs
M Range	250uA/μs-250mA/μs	500uA/μs-500mA/μs	1.6mA/μs-1.6A/μs
L Range	25uA/μs-25mA/μs	50uA/μs-50mA/μs	160uA/μs-160mA/μs
Slew Rate Setting Range (CR Mode)			
H Range	250uA/μs-250mA/μs	500uA/μs-500mA/μs	1.6mA/μs-1.6A/μs
M Range	25uA/μs-25mA/μs	50uA/μs-50mA/μs	160uA/μs-160mA/μs
L Range	2.5uA/μs-2.5mA/μs	5uA/μs-5mA/μs	16uA/μs-16mA/μs
Slew Rate Resolution			
Resolution	1mA	2mA	6mA
Setting	250mA/μs-2.5A/μs	500mA/μs-5A/μs	1.6A/μs-16A/μs
Resolution	100μA	200μA	600μA
Setting	25mA/μs -250mA/μs	50mA/μs-500mA/μs	160mA/μs-1.6A/μs
Resolution	10μA	20μA	60μA

Setting	2.5mA/μs -25mA/μs	5mA/μs-50mA/μs	16mA/μs-160mA/μs
Resolution	1μA	2μA	6μA
Setting	250uA/μs-2.5mA/μs	500uA/μs -5mA/μs	1.6mA/μs -16mA/μs
Resolution	100nA	200nA	600nA
Setting	25μA/μs-250μA/μs	50uA/μs-500uA/μs	160μA/μs -1.6mA/μs
Resolution	10nA	20nA	60nA
Setting	2.5μA/μs-25μA/μs	5μA/μs-50uA/μs	16μA/μs-160μA/μs
Slew Rate Accuracy of Setting*1			
±(10% of set + 25μs)			

*1 Time to reach from 10 % to 90 % when the current is varied from 2 % to 100 % (20 % to 100 % in M range) of the rated current.

Current Setting Range

H Range	0-35.7A	0-71.4A	0-214.2A
M Range	0-3.57A	0-7.14A	0-21.42A
L Range	0-0.357A	0-0.714A	0-2.142A

Current Resolution

H Range	1mA	2mA	10mA
M Range	0.1mA	0.2mA	1mA
L Range	0.01mA	0.02mA	0.1mA

Current Accuracy

±0.4% F.S

Resistance Setting Range

H Range	24.5S-0S (40.8163 mΩ-OPEN)	49.0S-0S (20.408 mΩ-OPEN)	147.000S-0S (6.8027 mΩ-OPEN)
M Range	2.45S-0S (408.1633mΩ-OPEN)	4.90S-0S s (204.08mΩ-OPEN)	14.70000S-0S (68.0272mΩ-OPEN)
L Range	0.245S-0S (4.08163Ω-OPEN)	0.490S-0S (2.0408Ω-OPEN)	1.4000S-0S (680.2721mΩ-OPEN)

Resistance Resolution

H Range	400μS	800μS	2.4mS
M Range	40μS	80μS	240μS
L Range	4μS	8μS	24μS

Resistance Accuracy of setting (R set(S) > 0.03% of f.s)

H, M Range	±(0.5 % of set*1 + 0.5 % of f.s*2) + Vin*3/500 kΩ
L Range	±(0.5 % of set*1 + 0.5 % of f.s) + Vin*3/500 kΩ

*1 set = Vin / Rset

*2 f.s = Full scale of High Range

*3 Vin = Input terminal voltage of Electronic Load

Power Operating Range

H Range	17.5W -175W	35W-350W	105W-1050W
M Range	1.75W-17.5W	3.5W-35W	10.5W-105W
L Range	0.175W-1.75W	0.35W-3.5W	1.05W-10.5W

Setting Range			
H Range	0W-183.75W	0W-367.5W	0W-1102.5W
M Range	0W-18.375W	0W-36.75W	0W-110.25W
L Range	0W-1.8375W	0W-3.675W	0W-11.025W
Resolution			
H Range	10mW	10mW	100mW
M Range	1mW	1mW	10mW
L Range	0.1mW	0.1mW	1mW
Accuracy of Setting ^{*1}			
$\pm(0.6\% \text{ of set} + 1.4\% \text{ of f.s.}^{*2}) + V_{in}^{2*3}/500k\Omega$			

*1 It is not applied for the condition of the parallel operation.

*2 M range applies to the full scale of H range.

*3 V_{in} = Input terminal voltage of electronic load.

Soft Start

Operation Mode	
CC, CR and CP	
Selectable Time Range	
1- 200 ms/Res: 1ms	
Time Accuracy	
$\pm(30\% \text{ of set} + 100\mu\text{s})$	

Remote Sensing

Voltage that can be Compensated	
2V for a single line	

Protection Function

Model	PEL-3021	PEL-3041	PEL-3111
Overvoltage protection(OVP)			
Turns off the load at 110% of the rated voltage			
Overcurrent protection(OCP)			
0.03-38.5A 0.06A-77A 0.2A-231A			
or 110% of the maximum current of each range			
Load off or limit selectable			
Overpower protection(OPP)			
0.1W - 192.5W 0.1W - 385W 1W - 1155W			
or 110% of the maximum power of each range			
Load off or limit selectable			

Overheat protection(OTP)	Turns off the load when the heat sink temperature reaches 105 °C (PEL-3211:115°C)
Undervoltage protection(UVP)	Turns off the load when detected. Can be set in the H range of 0.01V to 165V or Off. Can be set in the L range of 0.001V to 16.5V or Off.
Reverse voltage protection(RVP)	By diode. Turns off the load when an alarm occurs.
Rating overcurrent protection (ROCP)	An ROCP message will be produced when the input current range is greater than 110% of the rated operating current range (I range).
Rating overpower protection (ROPP)	An ROPP message will be produced when the input power range is greater than 110% of the rated operating power range.
Front panel input rating overcurrent protection (F.ROCP)	An F.ROCP message will be produced when the front panel input current range is greater than 77A (Typical).

Sequence

Normal Sequence	
Operation mode	CC, CR, CV or CP
Maximum number of steps	1000
Step Execution Time	0.05ms – 999 h 59 min
Time resolution	0.05 ms (0.05 ms – 1 min)/100 ms (1 min – 1 h)/1 s (1 h – 10 h)/10 s (10 h – 100 h)/1 min (100 h – 999 h 59 min)
Fast Sequence	
Operation mode	CC or CR
Maximum number of steps	1000
Step Execution Time	25 μs – 600 ms
Time resolution	1 μs (25μs -60ms) /10μs (60.01ms -600ms)

Other

Elapsed Time Delay	Measures the time from load on to load off. On/Off selectable. Measures from 1 s up to 999 h 59 min 59 s
Auto Load Off Timer	Automatically turns off the load after a specified time elapses. Can be set in the range of 1 s to 999 h 59 min 59 s or off

Communication Function	
GPIB	IEEE std. 488.1-1978 (partial support) SH1, AH1, T6, L4, SR1, DC1, DT1. Supports the SCPI and IEEE std. 488.2-1992 command set Sets panel functions except the power switch and reads measured values
RS-232C	D-SUB 9-pin connector (conforms to EIA-232-D) Sets panel functions except the power switch and reads measured values Supports the SCPI and IEEE std. 488.2-1992 command set Baud rate: 2400, 4800, 9600, 19200, 38400 bps Data length: 8-bit, Stop bit: 1, 2-bit, Parity bit: None, Odd, Even.
USB	Conforms to USB 2.0 Specifications and USB-CDC ACM Sets panel functions except the power switch and reads measured values Communication speed 12 Mbps (Full speed)

Analog External Control

Load on/off Control Input	Turn on the load with low (or high) TTL level signal
Load on Status Output	On when the load is on (open collector output by a photocoupler)
Range Switch Input	Switch ranges L, M, and H using a 2-bit signal
Range Status Output	Outputs range L, M, or H using 2-bit signal (open collector output by a photocoupler)
Trigger Input	Clear the sequence operation pause with a high TTL level signal for 10 μ s or more.
Alarm Input	Activate alarm with low TTL level signal input
Alarm Status Output	On when OVP, OCP, OPP, OTP, UVP, RVP, or when an external alarm input is applied (open collector output by a photocoupler)
Short Signal Output	Relay contact output (30 VDC/1 A)
External Voltage Control	Operates in CC, CR, CP, or CV mode 0 V to 10 V correspond to 0 % to 100 % of the rated current (CC mode), rated voltage (CV mode), or rated power (CP mode).

0 V to 10 V correspond to maximum resistance to minimum resistance (CR mode)
External Resistance Control
Operates in CC, CR, CP, or CV mode
0 Ω to 10 kΩ correspond to 0 % to 100 % or 100 % to 0 % of the rated current (CC mode), rated voltage (CV mode), or rated power (CP mode).
0 Ω to 10 kΩ correspond to maximum resistance to minimum resistance or minimum resistance to maximum resistance (CR mode)
Current Monitor Output
10 V f.s (H or L range) and 1 V f.s (M range)
Parallel Operation Input
Signal input for one-control parallel operation
Parallel Operation Output
Signal output for one-control parallel operation
Load Boost Power Supply Control
Power on/off control signal for the load booster

Front Panel BNC Connector

TRIG OUT
Trigger output: Approx. 5V pulse width: Approx. 2.5μs, output impedance: Approx. 500 Ω
Outputs a pulse during sequence operation and switching operation.
I MON OUT
Current monitor output
1V f.s (H or L range) and 0.1V f.s (M range)

General

Model	PEL-3021	PEL-3041	PEL-3111	PEL-3211
Input Range	90VAC ~ 132VAC / 180VAC ~ 250VAC Single-phase			
Inrush Frequency	47~63Hz			
Power (max)	90VA	110VA	190VA	230VA
Inrush Current	45A Max			

Input Resistance (Load OFF)				
500kΩ				
Insulation Resistance				
Primary to input terminal: 500 VDC, 20MΩ or more.				
Primary to chassis: 500 VDC, 20MΩ or more.				
Input terminal to chassis: 500 VDC, 20MΩ or more.				
Withstand Voltage				
Primary to input terminal: No abnormalities at 1500 VAC for 1 minute.				
Primary to chassis: No abnormalities at 1500 VAC for 1 minute.				
Input terminal to chassis: No abnormalities at 1500 VAC for 1 minute.				
Dimensions(mm)				
	213.8(W)	213.8(W)	427.8(W)	427.7(W)
	x124(H)	x124(H)	x124(H)	x127.8(H)
	x400.5(D)	x400.5(D)	x400.5(D)	x553.5(D)
Weight				
Maximum	Approx.6kg	Approx.7kg	Approx. 17kg	Approx. 23kg

PEL-3000H Specifications

The specifications apply when the PEL-3000H is powered on for at least 30 minutes to warm-up to a temperature of $25^{\circ}\text{C} \pm 5^{\circ}\text{C}$, unless specified otherwise.

All specifications apply when using the rear panel terminals. If the front panel terminals are used or if operating with long cables, remote sense must be connected to the terminals.

In parallel mode: All operation/settings/resolution specifications are N times. This does not include voltage settings and measured values. The maximum slew rate settings also don't change.

N = Number of units in parallel (same model on master)

N = PEL-3111H + 2 x Number of units in parallel (PEL-3211H)

Rating (Master / Slave)

Model	PEL-3021H	PEL-3041H	PEL-3111H
Operating Voltage	0V~800V	0V~800V	0V~800V
Current	8.75A	17.5A	52.5A
Min. Operating Voltage	5V at 8.75A	5V at 17.5A	5V at 52.5A
Power	175W	350W	1050W

Rating (Booster / Slave)

Model	PEL-3211H
Operating Voltage	0V~800V
Current	105A
Min. Operating Voltage	5V at 105A
Power	2100W

Current Setting Accuracy	
	$\pm(1.2\% \text{ of set} + 1.1\% \text{ of f.s})$
	M range applies to the full scale of H range.

CC Mode

Model	PEL-3021H	PEL-3041H	PEL-3111H
Operating Range			
H Range	0-8.75A	0-17.5A	0-52.5A
M Range	0-875mA	0-1.75A	0-5.25A
L Range	0-87.5mA	0-175mA	0-525mA
Setting Range			
H Range	0-9.1875A	0-18.375A	0-55.126A
M Range	0-918.75mA	0-1.8375A	0-5.5126A
L Range	0-91.875mA	0-183.75mA	0-0.55126A
Default Setting			
H Range	0A	0A	0A
M Range	0A	0A	0A
L Range	0A	0A	0A
Resolution			
H Range	0.3mA	0.6mA	2mA
M Range	0.03mA	0.06mA	0.2mA
L Range	0.003mA	0.006mA	0.002mA
Accuracy of Setting			
H, M Range	$\pm(0.2\% \text{ of set} + 0.1\% \text{ of f.s}^{*1}) + Vin^{*2}/3.24M\Omega$		
L Range	$\pm(0.2\% \text{ of set} + 0.1\% \text{ of f.s}) + Vin^{*2}/3.24M\Omega$		
Parallel Operation	$\pm(1.2\% \text{ of set} + 1.1\% \text{ of f.s}^{*3})$		
Input Voltage Variation^{*4}			
H Range	$20mA + Vin^{*2}/3.24M\Omega$	$20mA + Vin^{*2}/3.24M\Omega$	$20mA + Vin^{*2}/3.24M\Omega$
M Range	$20mA + Vin^{*2}/3.24M\Omega$	$20mA + Vin^{*2}/3.24M\Omega$	$20mA + Vin^{*2}/3.24M\Omega$
L Range	$2mA + Vin^{*2}/3.24M\Omega$	$2mA + Vin^{*2}/3.24M\Omega$	$2mA + Vin^{*2}/3.24M\Omega$
Ripple			
RMS ^{*5}	2mA	4mA	12mA
P.P ^{*6}	20mA	40mA	120mA

*1 Full scale of H range

*2 Vin: input terminal voltage of electronic load

*3 M range applies to the full scale of H range

*4 When the input voltage is varied from 5V to 800V at a current of rated power/800V

*5 Measurement frequency bandwidth: 10Hz to 1MHz

*6 Measurement frequency bandwidth: 10Hz to 20MHz

CR Mode

Model	PEL-3021H	PEL-3041H	PEL-3111H
Operating Range^{*1}			
H Range	1.75S~30 μ S (571m Ω ~33.3k Ω)	3.5S~60 μ S (285m Ω ~16.6k Ω)	10.5S~180 μ S (95.2m Ω ~5.55k Ω)
M Range	175mS~3 μ S (5.71 Ω ~333k Ω)	350mS~6 μ S (2.85 Ω ~166k Ω)	1.05S~18 μ S (952m Ω ~55.5k Ω)
L Range	17.5mS~0.3 μ S (57.1 Ω ~3.33M Ω)	35mS~0.6 μ S (28.5 Ω ~1.66M Ω)	105mS~1.8 μ S (9.52 Ω ~555k Ω)
Setting Range			
H Range	1837.5mS~0mS (0.54422 Ω ~OPEN)	3675mS~0mS (0.27211 Ω ~OPEN)	11025mS~0mS (0.09070 Ω ~OPEN)
M Range	183.75mS~0mS (5.44218 Ω ~OPEN)	367.5mS~0mS (2.72109 Ω ~OPEN)	1102.5mS~0mS (0.90703 Ω ~OPEN)
L Range	18.375mS~0S (54.4218 Ω ~OPEN)	36.75mS~0mS (27.2109 Ω ~OPEN)	110.25mS~0mS (9.07029 Ω ~OPEN)
Resolution			
H Range	30 μ S	60 μ S	180 μ S
M Range	3 μ S	6 μ S	18 μ S
L Range	0.3 μ S	0.6 μ S	1.8 μ S
Accuracy of Setting^{*2}			
H, M Range	$\pm(0.5\% \text{ of set}^{*3} + 0.5\% \text{ of f.s}^{*4}) + \text{Vin}^{*5}/3.24\text{M}\Omega$		
L Range	$\pm(0.5\% \text{ of set}^{*3} + 0.5\% \text{ of f.s}) + \text{Vin}^{*5}/3.24\text{M}\Omega$		
Parallel Operation	$\pm(1.2\% \text{ of set} + 1.1\% \text{ f.s}^{*4})$		

^{*1} Siemens[S] = Input current[A] / Input voltage[V] = 1 / resistance[Ω]

^{*2} Converted value at the input current. At the sensing point during remote sensing under the operating range of the input voltage.

^{*3} set = Vin / Rset

^{*4} f.s = Full scale of High Range

^{*5} Vin = Input terminal voltage of electronic load

CV Mode

Model	PEL-3021H	PEL-3041H	PEL-3111H
Operating Range			
H Range		5V~800V	
L Range		5V~80V	
Setting Range			
H Range		0V~840V	
L Range		0V~84V	

Resolution	
H Range	20mV
L Range	2mV
Accuracy of Setting*1	
H, L Range	$\pm(0.2\% \text{ of set} + 0.2\% \text{ of f.s})$
Input current variation*2	
H Range	80mV
L Range	80mV

*1 At the sensing point during remote sensing under the operating range of the input voltage. It is also applied for the condition of the parallel operation.

*2 With respect to a change in the current of 10 % to 100 % of the rating at an input voltage of 5V (during remote sensing).

CP Mode

Model	PEL-3021H	PEL-3041H	PEL-3111H
Operating Range			
H Range	17.5W -175W	35W-350W	105W -1050W
M Range	1.75W -17.5W	3.5W-35W	10.5W -105W
L Range	0.175W -1.75W	0.35W-3.5W	1.05W -10.5W
Setting Range			
H Range	0W-183.75W	0W-367.5W	0W-1102.5W
M Range	0W-18.375W	0W-36.75W	0W-110.25W
L Range	0W-1.8375W	0W-3.675W	0W-11.025W
Resolution			
H Range	10mW	10mW	100mW
M Range	1mW	1mW	10mW
L Range	0.1mW	0.1mW	1mW
Accuracy of Setting*1			
$\pm(0.6\% \text{ of set} + 1.4\% \text{ of f.s}^{*2}) + V_{in}^{2*3}/3.24M\Omega$			

*1 It is not applied for the condition of the parallel operation.

*2 M range applies to the full scale of H range.

*3 V_{in} = Input terminal voltage of electric load.

Slew Rate

Model	PEL-3021H	PEL-3041H	PEL-3111H
Setting Range (CC Mode)			
H Range	0.1400mA/ μ s ~ 140.0mA/ μ s	0.280mA/ μ s ~ 280.0mA/ μ s	0.840mA/ μ s ~ 840.0mA/ μ s

M Range	0.01400mA/μs ~ 14.000mA/μs	0.0280mA/μs ~ 28.00mA/μs	0.0840mA/μs~ 84.00mA/μs
L Range	1.400μA/μs ~ 1400.0uA/μs	2.80μA/μs ~ 2800uA/μs	0.00840mA/μs ~ 8.400mA/μs
Setting Range (CR Mode)			
H Range	0.01400mA/μs ~ 14.000mA/μs	0.0280mA/μs ~ 28.00mA/μs	0.0840mA/μs~ 84.00mA/μs
M Range	0.001400mA/μs ~ 1.4000mA/μs	0.00280mA/μs ~ 2.800mA/μs	0.00840mA/μs ~ 8.400mA/μs
L Range	0.1400μA/μs ~ 140.00μA/μs	0.280uA/μs ~ 280.0μA/μs	0.000840mA/μs ~ 0.8400mA/μs
Resolution			
Resolution	50μA	100μA	300μA
Setting	14mA~140mA/μs	28mA~280mA/μs	84mA~840mA/μs
Resolution	5μA	10μA	30μA
Setting	1.4mA~14mA/μs	2.8mA~28mA/μs	8.4mA~84mA/μs
Resolution	0.5μA	1μA	3μA
Setting	140μA~1.4mA/μs	280μA~2.8mA/μs	840μA~8.4mA/μs
Resolution	50nA	0.1μA	0.3μA
Setting	14μA~140μA/μs	28μA~280μA/μs	84μA~840μA/μs
Resolution	5nA	10nA	30nA
Setting	1.4μA~14μA/μs	2.8μA~28μA/μs	8.4μA~84μA/μs
Resolution	0.5nA	1nA	3nA
Setting	0.14μA~1.4μA/μs	0.28μA~2.8μA/μs	0.84μA~8.4μA/μs
Accuracy of Setting^{*1}			
±(10% of set + 25μs)			

^{*1} Time to reach from 10 % to 90 % when the current is varied from 2 % to 100 % (20 % to 100 % in M range) of the rated current.

Meter

Model	PEL-3021H	PEL-3041H	PEL-3111H
Voltmeter			
H Range	0.00V ~ 800.00V		
L Range	0.000V ~ 80.000V		
Accuracy	±(0.1 % of rdg + 0.1 % of f.s)		
Ammeter			
H Range	0.000A-8.7500A	0.000A-17.500A	0.00A-52.500A
M Range	0.0000A-875.00mA	0.0000A-1.7500A	0.000A-5.2500A
L Range	0.00mA-87.500mA	0.00mA-175.00mA	0.0mA-525.00mA
Accuracy	±(0.2 % of rdg + 0.3 % of f.s ^{*1})		
Accuracy	Parallel Operation: ±(1.2% of rdg +1.1% of f.s)		

Wattmeter			
H, M Range	0.00W-175.00W	0.00W-350.00W	0.00W-1050W
L(CC/CR/ CV mode)	0.000W-56.875W	0.000W-113.75W	0.00W-341.25W
L(CP mode)	0.0000W- 1.7500W	0.0000W- 3.5000W	0.000W- 10.500W
Temperature Coefficient per °C			
Voltmeter			100ppm
Ammeter			200ppm

*1 M range applies to the full scale of H range.

Dynamic Mode

Model	PEL-3021H	PEL-3041H	PEL-3111H
Operating Mode			
CC, CR and CP			
T1 & T2			
0.025ms - 10ms/ Res: 1µs; 10ms - 60s/ Res: 1ms			
Accuracy			
± 100ppm of setting			
Frequency Range (Freq./Duty)			
1Hz -20kHz			
Frequency Resolution			
1Hz-9.9Hz	0.1Hz		
10Hz-99Hz	1Hz		
100Hz-990Hz	10Hz		
1kHz-20kHz	100Hz		
Frequency Accuracy of Setting			
(0.5% of set)			
Duty Cycle of Setting (Freq./Duty)			
1% -99% , 0.1% step			
The minimum time width is 10µs. Between 1kHz and 20kHz, the maximum duty cycle is limited by the minimum time width.			
Slew Rate Setting Range (CC Mode)			
H Range	0.1400mA/µs ~ 140.0mA/µs	0.280mA/µs ~ 280.0mA/µs	0.840mA/µs ~ 840.0mA/µs
M Range	0.01400mA/µs ~ 14.000mA/µs	0.0280mA/µs ~ 28.00mA/µs	0.0840mA/µs~ 84.00mA/µs
L Range	1.400µA/µs ~ 1400.0uA/µs	2.80µA/µs ~ 2800uA/µs	0.00840mA/µs ~ 8.400mA/µs
Slew Rate Setting Range (CR Mode)			
H Range	0.01400mA/µs ~ 14.000mA/µs	0.0280mA/µs ~ 28.00mA/µs	0.0840mA/µs~ 84.00mA/µs

M Range	0.001400mA/μs ~ 1.4000mA/μs	0.0280mA/μs ~ 2.800mA/μs	0.00840m/μs ~ 8.400mA/μs
L Range	0.1400μA/μs ~ 140.00μA/μs	0.280μA/μs ~ 280.0μA/μs	0.000840mA/μs~0.84 00mA/μs
Slew Rate Resolution			
Resolution	50μA	100μA	300μA
Setting	14mA~140mA/μs	28mA~280mA/μs	84mA~840mA/μs
Resolution	5μA	10μA	30μA
Setting	1.4mA~14mA/μs	2.8mA~28mA/μs	8.4mA~84mA/μs
Resolution	0.5μA	1μA	3μA
Setting	140μA~1.4mA/μs	280μA~2.8mA/μs	840μA~8.4mA/μs
Resolution	50nA	0.1μA	0.3μA
Setting	14μA~140μA/μs	28μA~280μA/μs	84μA~840μA/μs
Resolution	5nA	10nA	30nA
Setting	1.4μA~14μA/μs	2.8μA~28μA/μs	8.4μA~84μA/μs
Resolution	0.5nA	1nA	3nA
Setting	0.14μA~1.4μA/μs	0.28μA~2.8μA/μs	0.84μA~8.4μA/μs
Slew Rate Accuracy of Setting*1			
±(10% of set + 25μs)			

*1 Time to reach from 10 % to 90 % when the current is varied from 2 % to 100 % (20 % to 100 % in M range) of the rated current.

Current Setting Range			
H Range	0-9.1875A	0-18.375A	0-55.126A
M Range	0-918.75mA	0-1.8375A	0-5.5126A
L Range	0-91.875mA	0-183.75mA	0-0.55126A
Current Resolution			
H Range	0.3mA	0.6mA	2mA
M Range	0.03mA	0.06mA	0.2mA
L Range	0.003mA	0.006mA	0.02mA
Current Accuracy			
±0.4% F.S			
Resistance Setting Range			
H Range	1837.50mS~0mS (0.54422 Ω ~OPEN)	3675.00mS~0mS (0.27211 Ω ~OPEN)	11025.0mS~0mS (0.09070Ω~OPEN)
M Range	183.750mS~0mS (5.44218Ω~OPEN)	367.500mS~0mS (2.72109Ω~OPEN)	1102.50mS~0mS (0.90703Ω~OPEN)
L Range	18.3750mS~0mS (54.4218Ω~OPEN)	36.7500mS~0mS (27.2109Ω~OPEN)	110.250mS~0mS (9.07029Ω~ OPEN)
Resistance Resolution			
H Range	30μS	60μS	180μS
M Range	3μS	6μS	18μS
L Range	0.3μS	0.6μS	1.8μS

Resistance Accuracy of setting (R set(S) > 0.03% of f.s)			
H, M Range	$\pm(0.5 \% \text{ of set}^{*1} + 0.5 \% \text{ of f.s}^{*2}) + \text{Vin}^{*3}/3.24\text{M}\Omega$		
L Range	$\pm(0.5 \% \text{ of set}^{*1} + 0.5 \% \text{ of f.s}) + \text{Vin}^{*3}/3.24\text{M}\Omega$		
*1 set = Vin / Rset			
*2 f.s = Full scale of High Range			
*3 Vin = Input terminal voltage of Electronic Load			
Power Operating Range			
H Range	17.5W -175W	35W-350W	105W-1050W
M Range	1.75W-17.5W	3.5W-35W	10.5W-105W
L Range	0.175W-1.75W	0.35W-3.5W	1.05W-10.5W
Setting Range			
H Range	0W-183.75W	0W-367.5W	0W-1102.5W
M Range	0W-18.375W	0W-36.75W	0W-110.25W
L Range	0W-1.8375W	0W-3.675W	0W-11.025W
Resolution			
H Range	10mW	10mW	100mW
M Range	1mW	1mW	10mW
L Range	0.1mW	0.1mW	1mW
Accuracy of Setting^{*1}			
$\pm(0.6 \% \text{ of set} + 1.4 \% \text{ of f.s}^{*2}) + \text{Vin}^{*3}/3.24\text{M}\Omega$			

*1 It is not applied for the condition of the parallel operation.

*2 M range applies to the full scale of H range.

*3 Vin = Input terminal voltage of electronic load.

Soft Start

Operation Mode	CC and CR
Selectable Time Range	3- 200 ms/Res: 1ms
Time Accuracy	$\pm(30\% \text{ of set} + 100\mu\text{s})$

Remote Sensing

Voltage that can be Compensated	2V for a single line
--	----------------------

Protection Function

Model	PEL-3021H	PEL-3041H	PEL-3111H
Overvoltage protection(OVP)			
Turns off the load at 110% of the rated voltage			
Overcurrent protection(OCP)			
	0.0060A-9.6252A	0.0120A-19.2504A	0.050A-57.750A
or 110% of the maximum current of each range			
Load off or limit selectable			
Overpower protection(OPP)			
	0.1W - 192.5W	0.1W - 385W	1W - 1155W
or 110% of the maximum power of each range			
Load off or limit selectable			
Overheat protection(OTP)			
Turns off the load when the heat sink temperature reaches 105 °C (PEL-3211H:115°C)			
Undervoltage protection(UVP)			
Turns off the load when detected. Can be set in the H range of 0.1V to 840V or Off. Can be set in the L range of 0.01V to 84V or Off.			
Reverse voltage protection(RVP)			
By diode. Turns off the load when an alarm occurs.			
Rating overcurrent protection (ROCP)			
An ROCP message will be produced when the input current range is greater than 110% of the rated operating current range (I range).			
Rating overpower protection (ROPP)			
An ROPP message will be produced when the input power range is greater than 110% of the rated operating power range.			
Front panel input rating overcurrent protection (F.ROCP)			
An F.ROCP message will be produced when the front panel input current range is greater than 77A (Typical).			

Sequence

Normal Sequence	
Operation mode	CC, CR, CV or CP
Maximum number of steps	1000
Step Execution Time	0.05ms – 999 h 59 min
Time resolution	0.05 ms (0.05 ms – 1 min)/100 ms (1 min – 1 h)/1s (1 h – 10 h)/10s (10 h – 100 h)/1 min (100 h – 999 h 59 min)

Fast Sequence	
Operation mode	CC or CR
Maximum number of steps	1000
Step Execution Time	25 μ s – 600 ms
Time resolution	1 μ s(25 μ s -60ms) /10 μ s(60.01ms -600ms)

Other

Elapsed Time Delay	
	Measures the time from load on to load off. On/Off selectable. Measures from 1 s up to 999 h 59 min 59 s
Auto Load Off Timer	
	Automatically turns off the load after a specified time elapses. Can be set in the range of 1 s to 999 h 59 min 59 s or off
Communication Function	
GPIB	IEEE std. 488.1-1978 (partial support) SH1, AH1, T6, L4, SR1, DC1, DT1. Supports the SCPI and IEEE std. 488.2-1992 command set Sets panel functions except the power switch and reads measured values
RS-232C	D-SUB 9-pin connector (conforms to EIA-232-D) Sets panel functions except the power switch and reads measured values Supports the SCPI and IEEE std. 488.2-1992 command set Baud rate: 2400, 4800, 9600, 19200, 38400 bps Data length: 8-bit, Stop bit: 1, 2-bit, Parity bit: None, Odd, Even.
USB	Conforms to USB 2.0 Specifications and USB-CDC ACM Sets panel functions except the power switch and reads measured values Communication speed 12 Mbps (Full speed)

Analog External Control

Load on/off Control Input	
	Turn on the load with low (or high) TTL level signal
Load on Status Output	
	On when the load is on (open collector output by a photocoupler)
Range Switch Input	
	Switch ranges L, M, and H using a 2-bit signal
Range Status Output	
	Outputs range L, M, or H using 2-bit signal (open collector output by a photocoupler)

Trigger Input	Clear the sequence operation pause with a high TTL level signal for 10 μ s or more.
Alarm Input	Activate alarm with low TTL level signal input
Alarm Status Output	On when OVP, OCP, OPP, OTP, UVP, RVP, or when an external alarm input is applied (open collector output by a photocoupler)
Short Signal Output	Relay contact output (30 VDC/1 A)
External Voltage Control	Operates in CC, CR, CV, CP, or Cx+CV mode 0 V to 10 V correspond to 0 % to 100 % of the rated current (CC mode), rated voltage (CV, Cx+CV mode), or rated power (CP mode). 0 V to 10 V correspond to maximum resistance to minimum resistance (CR mode)
External Resistance Control	Operates in CC, CR, CP, or CV mode 0 Ω to 10 k Ω correspond to 0 % to 100 % or 100 % to 0 % of the rated current (CC mode), rated voltage (CV mode), or rated power (CP mode). 0 Ω to 10 k Ω correspond to maximum resistance to minimum resistance or minimum resistance to maximum resistance (CR mode)
Current Monitor Output	10 V f.s (H or L range) and 1 V f.s (M range)
Parallel Operation Input	Signal input for one-control parallel operation
Parallel Operation Output	Signal output for one-control parallel operation
Load Boost Power Supply Control	Power on/off control signal for the load booster

Front Panel BNC Connector

TRIG OUT	Trigger output: Approx. 5V pulse width: Approx. 2.5 μ s, output impedance: Approx. 500 Ω Outputs a pulse during sequence operation and switching operation.
----------	---

I MON OUT
Current monitor output 10V f.s (H or L range) and 1V f.s (M range)
V MON OUT
Voltage monitor output 8V f.s

General

Model	PEL-3021H	PEL-3041H	PEL-3111H	PEL-3211H
Input Range	90VAC~132VAC/180VAC~250VAC Single-phase			
Inrush Frequency	47~63Hz			
Power (max)	90VA	110VA	190VA	230VA
Inrush Current	45A Max			
Input Resistance (Load OFF)	3.24MΩ			
Insulation Resistance	Primary to input terminal: 1000 VDC, 20MΩ or more. Primary to chassis: 1000 VDC, 20MΩ or more.			
Withstand Voltage	Primary to input terminal: No abnormalities at 1500 VAC for 1 minute. Primary to chassis: No abnormalities at 1500 VAC for 1 minute.			
Dimensions(mm)	213.8(W) x124(H) x400.5(D)	213.8(W) x124(H) x400.5(D)	427.8(W) x124(H) x400.5(D)	427.7(W) x127.8(H) x553.5(D)
Weight	Maximum Approx. 9kg Approx. 10kg Approx. 20kg Approx. 28kg			

PEL-3000(H) Dimensions

PEL-3111

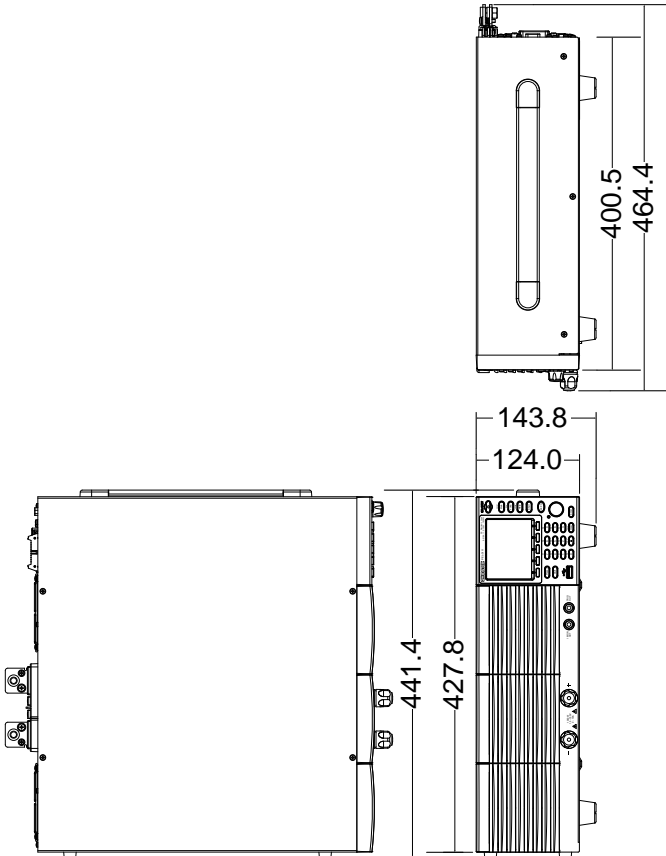

PEL-3021, PEL-3041

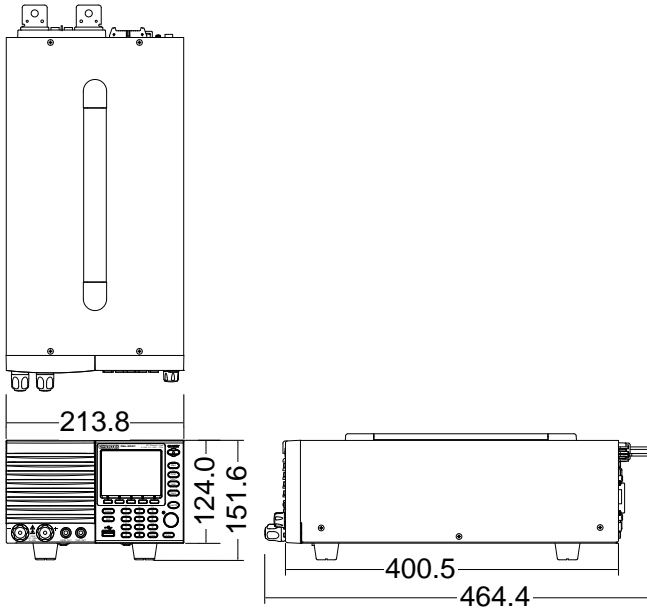

PEL-3211

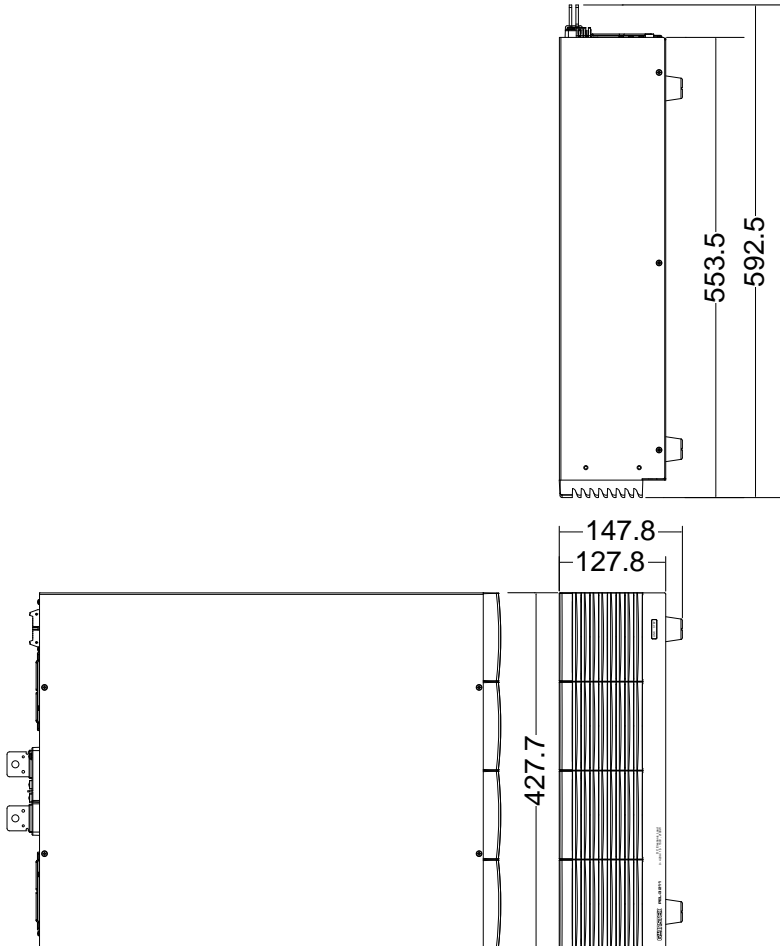

Declaration of Conformity

We

GOOD WILL INSTRUMENT CO., LTD.

declare that the below mentioned product

Type of Product: **Programmable Electronic Load**

Model number: **PEL-3021, PEL-3041, PEL-3111**

Slave module: **PEL-3211**

satisfies all the technical relations application to the product within the scope of council:

Directive: 2014/30/EU; 2014/35/EU; 2011/65/EU; 2012/19/EU

The above product is in conformity with the following standards or other normative documents:

◎ **EMC**

EN 61326-1 EN 61326-2-1 EN 61326-2-2: 2013	Electrical equipment for measurement, control and laboratory use -- EMC requirements (2013)
Conducted & Radiated Emission EN55011: 2009+A1: 2010	Electrical Fast Transients EN 61000-4-4: 2012
Current Harmonics EN 61000-3-2: 2014	Surge Immunity EN 61000-4-5: 2006
Voltage Fluctuations EN 61000-3-3: 2013	Conducted Susceptibility EN 61000-4-6: 2014
Electrostatic Discharge EN 61000-4-2: 2009	Power Frequency Magnetic Field EN 61000-4-8: 2010
Radiated Immunity EN 61000-4-3: 2006 +A1:2008+A2:2010	Voltage Dip/ Interruption EN 61000-4-11: 2004

◎ **Safety**

Low Voltage Equipment Directive 2014/35/EU	
Safety Requirements	EN 61010-1: 2010 EN 61010-2-030: 2010

GOOD WILL INSTRUMENT CO., LTD.

No. 7-1, Jhongsing Road, Tucheng Dist., New Taipei City 236, Taiwan

Tel: +886-2-2268-0389

Fax: +866-2-2268-0639

Web: www.gwinstek.com

Email: marketing@goodwill.com.tw

GOOD WILL INSTRUMENT (SUZHOU) CO., LTD.

No. 521, Zhujiang Road, Snd, Suzhou Jiangsu 215011, China

Tel: +86-512-6661-7177

Fax: +86-512-6661-7277

Web: www.instek.com.cn

Email: marketing@instek.com.cn

GOOD WILL INSTRUMENT EURO B.V.

De Run 5427A, 5504DG Veldhoven, The Netherlands

Tel: +31(0)40-2557790

Fax: +31(0)40-2541194

Email: sales@gw-instek.eu

We

GOOD WILL INSTRUMENT CO., LTD.

declare that the below mentioned product

Type of Product: **Programmable Electronic Load**

Model number: **PEL-3021H, PEL-3041H, PEL-3111H**

Slave module: **PEL-3211H**

satisfies all the technical relations application to the product within the scope of council:

Directive: 2014/30/EU; 2014/35/EU; 2011/65/EU; 2012/19/EU

The above product is in conformity with the following standards or other normative documents:

© **EMC**

EN 61326-1 EN 61326-2-1 EN 61326-2-2: 2013	Electrical equipment for measurement, control and laboratory use -- EMC requirements (2013)
Conducted & Radiated Emission EN55011: 2009+A1: 2017 Class A	Electrical Fast Transients IEC 61000-4-4: 2012
Current Harmonics EN 61000-3-2: 2014	Surge Immunity IEC 61000-4-5: 2014+AMD1: 2017
Voltage Fluctuations EN 61000-3-3: 2013	Conducted Susceptibility IEC 61000-4-6: 2013 COR1: 2015
Electrostatic Discharge IEC 61000-4-2: 2008	Power Frequency Magnetic Field IEC 61000-4-8: 2009
Radiated Immunity IEC 61000-4-3: 2006 +AMD2: 2010	Voltage Dip/ Interruption IEC 61000-4-11: 2004+AMD1: 2017

© **Safety**

Low Voltage Equipment Directive 2014/35/EU	
Safety Requirements	EN 61010-1: 2010 EN 61010-2-030: 2010

GOOD WILL INSTRUMENT CO., LTD.

No. 7-1, Jhongsing Road, Tucheng Dist., New Taipei City 236, Taiwan

Tel: +886-2-2268-0389

Fax: +866-2-2268-0639

Web: www.gwinstek.com

Email: marketing@goodwill.com.tw

GOOD WILL INSTRUMENT (SUZHOU) CO., LTD.

No. 521, Zhujiang Road, Snd, Suzhou Jiangsu 215011, China

Tel: +86-512-6661-7177

Fax: +86-512-6661-7277

Web: www.instek.com.cn

Email: marketing@instek.com.cn

GOOD WILL INSTRUMENT EURO B.V.

De Run 5427A, 5504DG Veldhoven, The Netherlands

Tel: +31(0)40-2557790

Fax: +31(0)40-2541194

Email: sales@gw-instek.eu

INDEX

Accessories	11	Declaration of conformity	298, 299
Advanced configuration		Default settings	242
Alarm tone	93	operation.....	112
Auto Load	78	User	112
Control settings	94	Display diagram	24
Count time	76	Disposal instructions.....	6
Cut off time	77	Disposal symbol.....	3
Display.....	93	Dynamic mode frequency	69
Dyna. Time.....	69	EN61010	
Go-NoGo.....	97	Measurement category.....	4
Language.....	94	Pollution degree.....	6
Load Off (Mode).....	79	Environment	
Load Off (Range).....	79	Safety instruction	5
OCP.....	83	Ethernet	
OPP	84	sockets	222
OVP.....	88	External control	
Protection settings.....	83	Alarm	199
Short enable/disable.....	65	Alarm status	200
Short(safety).....	63	Current monitor.....	202, 203
Soft start.....	73	Current status.....	198
Speaker	92	Load status	197
Step resolution.....	80	Overview	183
System settings	92	Resistance control	190
Trigger	94	Short control.....	200
UVP.....	85	Trigger.....	199
Von delay	76	Trigger signal output.....	201
Von latch	75	Turning the load on.....	195
Von voltage.....	74	Voltage control	185
Alarm Tone	93	External control.....	182
Analog connector		FAQ	234
pin assignment	183, 184	Fast Sequence	
Baud rate configuration.....	222	Configuration	142
Caution symbol	3	Data edit.....	143
CC Response speed	72	Overview	138
Cleaning the instrument.....	5	Run	145
Conventions	45	File Utility	109
CP Response speed	72	Firmware update	43
CR Response speed	72	First time use instructions	25
CV Response rate	71		

Front panel diagram.....	14	PEL-3211	267, 269
Function		Operating mode	
Count Time.....	118	CC	259
Load	116	CC+CV	259
Ring Time	117	CP	262
Select	114	CP+CV.....	262
Go_NoGo Tone	93	CR	260
GPIB card installation	241	CR+CV	261
GPIB installation.....	240	CV	263
Ground		Operation	54
Symbol	3	+CV mode.....	61
Help	50	CC mode	54
Input terminals		CC Response speed.....	72
Front.....	34	CP mode.....	59
Rear	35	CP Response speed	72
Terminal cover	36, 40, 41	CR mode.....	56
PEL-013	38	CR Response speed.....	72
Installation		CR units.....	57
GPIB card.....	241	CV mode	58
Interface configuration		CV Response rate	71
Baud Rate	222	Dynamic mode	66
RS232.....	222	Dynamic mode units	68
Knob configuration		panel lock	65
Cursor	80	Short key	62
Step.....	81	Short key configuration.....	64
Load default settings	28	Slew rate.....	70
Load wiring	31	Staticmode	66
Connection	33	Turning the load on	62
Main features.....	10	OPP alarm	84
Mainframe operation		OVP alarm	88
OCP test automation147, 154, 161, 169, 173, 174, 179		Package contents	13
Marketing		Parallel error	90, 91
Contact.....	235	Parallel operation	
Memory Recall		Capacity	204, 205
safety setting	109	Capacity with boosters	205, 206
Monitor signal output	201	Configuration	208
Normal Sequence		Connection.....	206
Configuration.....	132	Disable.....	210
Data edit	134	Overview.....	204
Overview	128	Turning the load on	210
Run.....	135	Power supply	
OCP alarm	83	Safety instruction	5
OCP test automation147, 154, 161, 169, 173, 174, 179		Power up	28
Operating area		Power up	111
PEL-3021	264, 267	Presets	
PEL-3041	265, 268	Save/Recall.....	111
PEL-3111	266, 269	Program	
		Chain	125, 137

Configuration	119, 122	Recall from USB	107
Overview	120	Recall Safety	109
Run	126	Save to internal memory	102
Rack mount installation	25	Save to USB	104
Rear panel diagram	19	Sequence	128
Remote control	211	Service operation	
Ethernet function check	231	About disassembly	4
GPIB configuration	212	Contact	235
RS232C configuration	214	Setting the date and time	29
sockets configuration	222	Short enable/disable	65
sockets function check	225	Socket server function check ..	225
USB configuration	212	Specifications	
Remote control function check	215	Dimensions	295
GPIB	219	Frequency	271, 283
Realterm	216	PEL-3211	271, 283
Remote sense	42	Trigger	94
Replace the clock battery	239	UnReg alarm	89
Replace the dust filter	238	Unreg Tone	93
Restore default settings	111	UVP alarm	85
RS232 configuration	222	UVP alarm time	86
Safety short	63	Warning symbol	3
Save/Recall	100	Web server function check	231
File types	101	Wire gauge	30
Presets	111	Theory	31
Recall from memory	106		