

Electrical Safety Analyzer

GPT-10000 Series

USER MANUAL



ISO-9001 CERTIFIED MANUFACTURER

GW INSTEK

This manual contains proprietary information, which is protected by copyright. All rights are reserved. No part of this manual may be photocopied, reproduced or translated to another language without prior written consent of Good Will company.

The information in this manual was correct at the time of printing. However, Good Will continues to improve products and reserves the rights to change specification, equipment, and maintenance procedures at any time without notice.

Good Will Instrument Co., Ltd.
No. 7-1, Jhongsing Rd., Tucheng Dist., New Taipei City 236, Taiwan.

Table of Contents

SAFETY INSTRUCTIONS	5
GETTING STARTED.....	9
GPT-10000 Series Overview	10
Front Panel Overview	15
Rear Panel Overview	19
Set Up.....	22
OPERATION	29
Menu Tree.....	31
Test Lead Connection.....	36
Manual Tests	39
Special MANU Test Mode (000)	98
Sweep Function.....	100
Automatic Tests	103
System Settings	128
EXTERNAL CONTROL	175
External Control Overview.....	176
REMOTE CONTROL.....	182
Interface Configuration	183
Command Syntax	188
Command List	191
Error Messages.....	257
FAQ.....	259
APPENDIX.....	262
Fuse Replacement.....	262
Tester Errors	263

Factory Default Parameters	266
GPT-10000 Specifications	268
GPT-15001/15002/15003 Dimensions	276
GPT-15004 Dimensions.....	277
GPT-12001/12002/12003 Dimensions	278
GPT-12004 Dimensions.....	279
Certificate Of Compliance	280
INDEX.....	281

S SAFETY INSTRUCTIONS

This chapter contains important safety instructions that you must follow during operation and storage. Read the following before any operation to ensure your safety and to keep the instrument in the best possible condition.

Safety Symbols

These safety symbols may appear in this manual or on the instrument.



WARNING

Warning: Identifies conditions or practices that could result in injury or loss of life.



CAUTION

Caution: Identifies conditions or practices that could result in damage to the instrument or to other properties.



DANGER High Voltage



Attention Refer to the Manual



Protective Conductor Terminal



Frame or Chassis Terminal



Earth (ground) Terminal



Do not dispose electronic equipment as unsorted municipal waste. Please use a separate collection facility or contact the supplier from which this instrument was purchased.

Safety Guidelines

General Guideline



CAUTION

- Do not place any heavy object on the instrument.
- Avoid severe impact or rough handling that leads to damaging the instrument.
- Do not discharge static electricity to the instrument.
- Use only mating connectors, not bare wires, for the terminals.
- Do not block the cooling fan opening.
- Do not disassemble the GPT-10000 unless you are qualified.

Position Guideline



WARNING

- The rear position of the GPT-10000 should be placed in an area with easy accessible for power disconnection, that is, unplugging the power cord with ease.
- Keep away from the device under test which connects with the GPT-10000 when test is underway. In addition, while test is ongoing, never touch the device under test, the GPT-10000 as well as other relevant units.
- Any inappropriate manner that is unspecified by the manufacturer may result in irreversible harms or impaired protection by the GPT-10000.

(Measurement categories) EN 61010-1:2010 specifies the measurement categories and their requirements as follows. The GPT-10000 does not fall under category II, III or IV.

- Measurement category IV is for measurement performed at the source of low-voltage installation.
- Measurement category III is for measurement performed in the building installation.
- Measurement category II is for measurement performed on the circuits directly connected to the low voltage installation.

Power Supply



WARNING

- AC Input voltage range:
AC 100V – 240V \pm 10%
- Frequency: 50Hz/60Hz
- To avoid electrical shock connect the protective grounding conductor of the AC power cord to an earth ground.

Cleaning the GPT-10000

- Disconnect the power cord before cleaning.
- Use a soft cloth dampened in a solution of mild detergent and water. Do not spray any liquid.
- Do not use chemicals containing harsh material such as benzene, toluene, xylene, and acetone.

Operation Environment

- Location: Indoor, no direct sunlight, dust free, almost non-conductive pollution (Note below)
- Relative Humidity: \leq 70% (no condensation)
- Altitude: < 2000m
- Temperature: 0°C~40°C

(Pollution Degree) EN 61010-1:2010 specifies the pollution degrees and their requirements as follows. The GPT-10000 falls under degree 2.

Pollution refers to “addition of foreign matter, solid, liquid, or gaseous (ionized gases), that may produce a reduction of dielectric strength or surface resistivity”.

- Pollution degree 1: No pollution or only dry, non-conductive pollution occurs. The pollution has no influence.
- Pollution degree 2: Normally only non-conductive pollution occurs. Occasionally, however, a temporary conductivity caused by condensation must be expected.
- Pollution degree 3: Conductive pollution occurs, or dry, non-conductive pollution occurs which becomes conductive due to condensation which is expected. In such conditions, equipment is normally protected against exposure to direct sunlight, precipitation, and full wind pressure, but neither temperature nor humidity is controlled.

Storage environment

- Location: Indoor
- Temperature: -10°C to 70°C
- Relative Humidity: $\leq 85\%$ (no condensation)

Disposal



Do not dispose this instrument as unsorted municipal waste. Please use a separate collection facility or contact the supplier from which this instrument was purchased. Please make sure discarded electrical waste is properly recycled to reduce environmental impact.

G E T T I N G S T A R T E D

This chapter describes the safety analyzer in a nutshell, including its main features and front / rear panel introduction. After going through the overview, please read the safety considerations in the Set Up chapter.

GPT-10000 Series Overview	10
Series lineup	10
Lineup Overview	11
Main Features	11
Accessories	12
Package Contents	14
Front Panel Overview	15
GPT-12001/12002/12003/12004/15001/15002/15003/15004	15
Rear Panel Overview	19
GPT-12001/12002/12003/12004/15001/15002/15003/15004	19
Set Up	22
Tilting the Stand	22
Line Voltage Connection and Power Up	23
Installing the Optional LAN/GPIB Card	24
Workplace Precautions	25
Operating Precautions	26
Basic Safety Checks	28

GPT-10000 Series Overview

Series lineup

The GPT-10000 Series Safety Analyzers are AC/DC withstanding voltage, insulation resistance, ground bond and continuity safety analyzers.

By and large, GPT-10000 Series has 2 major categories, one is GPT-12XXX models, and the other is GPT-15XXX models. The subordinate models of 2 categories share the same test functions but with different specifications. We use the term “X” for the 2nd digit of model names described below to stand for both 2 categories in common.

The GPT-1X001 is AC withstanding voltage and continuity tester, the GPT-1X002 is AC/DC withstanding voltage and continuity tester and the GPT-1X003 is AC/DC withstanding voltage, insulation resistance and continuity tester. The GPT-1X004 includes all the test functions of the other models, plus the ground bond testing. See the following Lineup Overview for more details.

The GPT-10000 Series can store up to 100 manual tests, as well as run up to 10 manual tests sequentially as an automatic test, allowing the safety analyzers to accommodate any number of safety standards, including IEC, EN, UL, CSA, GB, JIS and others.

Note: Throughout this user manual, the terms ACW, DCW, IR, GB and CONT refer to AC Withstanding, DC Withstanding, Insulation Resistance, Ground Bond and Continuity testing, respectively.

Lineup Overview

Model name	ACW	DCW	IR	GB	CONT
GPT-12001	✓				✓
GPT-12002	✓	✓			✓
GPT-12003	✓	✓	✓		✓
GPT-12004	✓	✓	✓	✓	✓
GPT-15001	✓*				✓
GPT-15002	✓*	✓			✓
GPT-15003	✓*	✓	✓		✓
GPT-15004	✓*	✓	✓	✓	✓

- Short Current > 200mA

Main Features

- Performance
- ACW: 0.05kV~5kVAC
 - DCW: 0.05kV~6kVDC
 - IR: 50V~1200V (50V steps)
 - GB: 3A~32A
 - CONT: 100mA (fixed)

- Features
- Ramp up time control
 - Ramp down time control
 - Safety discharge
 - 100 test conditions (MANU mode)
 - 100 automatic tests (AUTO mode)
 - Over temperature, voltage and current protection
 - Pass, Fail, Test, High Voltage and Ready indicators
 - PWM output (90% efficiency, increased reliability)
 - Interlock (configurable)
 - Rear panel output
-

- Interface
- Remote control start/stop interface terminal
 - RS232/USB interface for programming
 - Optional GPIB interface for programming
 - Optional LAN interface for programming
 - Signal I/O port for pass/fail/test monitoring and start/stop control/interlock

Accessories

Standard Accessories	Part number	Description
	GHT-115x1	Test lead
	Region dependent	Power cord
	GTL-215x1	GB test lead (GPT-12004/GPT-15004 only)
	GHT-119	Remote terminal cable
	N/A	Interlock key

Optional Accessories	Part number	Description
	GHT-205	High Voltage Test Probe
	GHT-113	High Voltage Test Pistol
	GTL-232	RS232C cable
	GTL-248	GPIB cable
	GTL-246	USB cable (A to B type)
	GRA-440	Rack Adapter Panel (19", 4U) (GPT-12000/15000 only)
Options	Part number	Description
	GPT-10KG1	GPIB card
	GPT-10KL1	LAN card

Package Contents

Check the contents before using the GPT-10000 series.

Opening the box

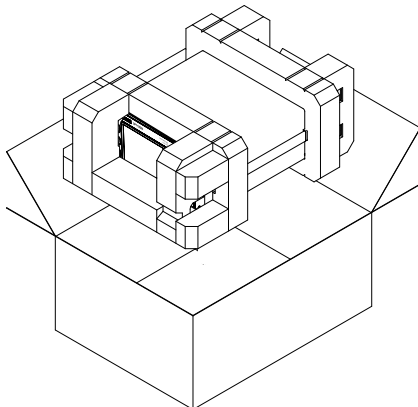

Contents (single unit)

- GPT-10000 unit
- Quick Start Guide
- User manual CD
- CTC (Calibration Traceable Certificate)
- Power cord x1 (region dependent)
- GHT-115 test leads x1
- GTL-215 GB test leads x1 (GPT-12004/GPT-15004 only)
- GHT-119 Remote terminal cable
- Interlock key

Note

Keep the packaging, including the box, polystyrene foam and plastic envelopes should the need arise to return the unit to GW Instek.



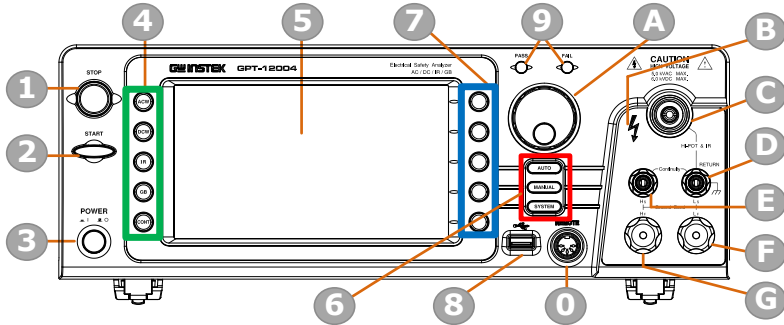

Front Panel Overview

GPT-12001/12002/12003/12004/15001/15002/15003/15004

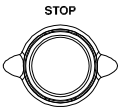
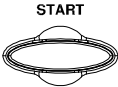
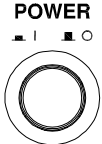

Item	Description
------	-------------

- 1 STOP Button
- 2 START Button
- 3 POWER Switch
- 4 Test Function Keys (Green Zone)
- 5 Display
- 6 Mode Keys (AUTO, MANUAL, SYSTEM in Red Zone)
- 7 Soft Keys (Blue Zone)
- 8 USB A-Type Host Port
- 9 PASS/FAIL Indicators
- 0 REMOTE Terminal
- A Scroll Wheel
- B HIGH VOLTAGE Indicator
- C HIGH VOLTAGE Output Terminal
- D SENSE L & RETURN Terminal
- E SENSE H & Output Terminal
- F SOURCE L (GPT-12004/GPT-15004 only)
- G SOURCE H (GPT-12004/GPT-15004 only)

- STOP button**  The STOP button is used to stop/cancel tests. The STOP button will also put the safety analyzer in the READY status to begin testing.
- START button**  The START button is used to start tests. The START button can be used to start tests when the tester is in the READY status. Pressing the START button will put the tester in the TEST status.
- POWER switch**  Turns the power on. The safety tester will always start up with the setting which was performed and executed from the last test.
- Test Function Keys** The keys indicate the 5 testing functions including ACW, DCW, IR, GB and CONT. Pressing one of the keys enters the function settings.
- Display** 7" Color TFT LCD display in 800 X 480 resolution
- AUTO button**  Press to enter the AUTO test mode.
- MANUAL button**  Press to enter the MANUAL test mode.
- SYSTEM button**  Press to enter the SYSTEM mode.
- Soft Keys** The Soft keys correspond to the menu keys directly above on the main display.

USB Host Port

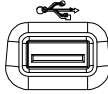

It can connect with USB flash drive for data and log import/export and for firmware update. Also, it is able to connect with USB disk for screenshot hardcopy and barcode scanner for convenient tests.

Pass/Fail indicators

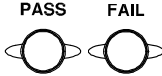

The PASS and FAIL indicators light up upon a PASS or FAIL test result at the end of a manual test or automatic test.

REMOTE terminal



The REMOTE terminal is used to connect to a remote controller.

Scroll wheel



The scroll wheel is used to edit parameter values.

HIGH VOLTAGE indicator



The HIGH VOLTAGE indicator will light up red when an output terminal is active. Only after the test has finished or stopped will the indicator turn off.

HIGH VOLTAGE output terminal

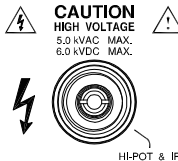

The HIGH VOLTAGE terminal output is used for outputting the testing voltage in ACW, DCW and IR tests. The terminal is recessed for safety. This terminal is used in conjunction with the RETURN terminal.



WARNING

USE EXTREME CAUTION.

Do not touch the **HIGH VOLTAGE** terminal during testing.

RETURN terminal

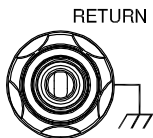

The RETURN terminal is used for ACW, DCW, IR and CONT tests.

OUTPUT and RETURN terminals

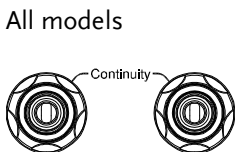

The OUTPUT terminal (red) and RETURN terminal (black) are used for CONT (Continuity) test.

SENSE H/L and SOURCE H/L terminals

GPT-12004,
GPT-15004 only

The SENSE H, SENSE L, SOURCE H and SOURCE L, terminals are used for GB (Ground Bond) test.

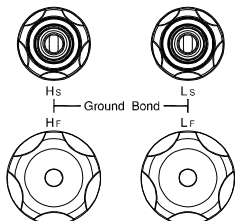





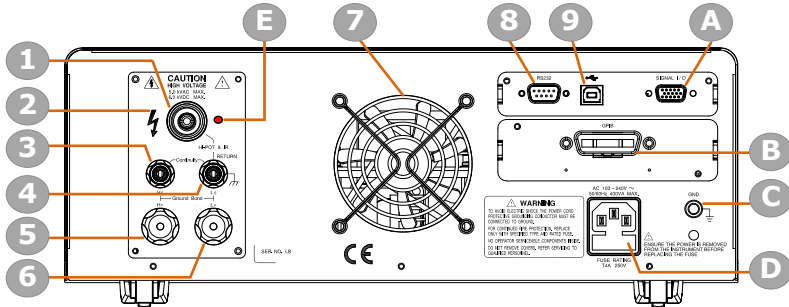

Rear Panel Overview

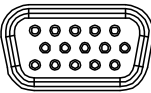
GPT-12001/12002/12003/12004/15001/15002/15003/15004

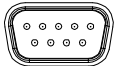

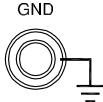
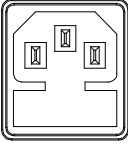
Item	Description
1	HIGH VOLTAGE Output Terminal
2	HIGH VOLTAGE Indicator
3	SENSE H & Output Terminal
4	SENSE L & RETURN Terminal
5	SOURCE H (GPT-12004/GPT-15004 only)
6	SOURCE L (GPT-12004/GPT-15004 only)
7	Fan
8	RS-232 Port
9	USB B-Type Interface Port
A	Signal I/O Port
B	GPIB Port/Ethernet LAN Port (Optional)
C	GND
D	AC Mains Input (Power Cord Socket)
E	HIGH VOLTAGE pilot lamp

- | | | |
|----------------------|--|--|
| SIGNAL I/O port | <p>SIGNAL I/O</p>  | <p>The SIGNAL I/O port is used to monitor the tester status (PASS, FAIL, TEST) and input (START/STOP signals). It is also used with the Interlock key.</p> |
| USB B-Type port |  | <p>The USB B-Type port is used for remote control.</p> |
| RS232 interface port | <p>RS232</p>  | <p>The RS-232 port is used for remote control.</p> |
| Fan/Fan Vents |  | <p>Exhaust fan. Allow enough room for the fan to vent. Do not block the fan openings.</p> |
| GND | <p>GND</p>  | <p>Connect the GND (ground) terminal to the earth ground.</p> |
| AC Mains Input | <p>AC 100 - 240V ~
50/60Hz 400VA MAX.</p>  <p>FUSE RATING
T4A 250V</p> | <p>AC Mains Input for Power Cord Socket: 100 - 240 VAC ±10%.</p> <p>The fuse holder contains the AC mains fuse. For fuse replacement details, see page 45.</p> |
| Optional LAN port | <p>LAN</p>  | <p>Optional LAN port for remote control.</p> |
| Optional GPIB port | <p>GPIB</p>  | <p>Optional GPIB interface for remote control.</p> |

HIGH VOLTAGE output terminal



CAUTION
HIGH VOLTAGE
5.0 kVAC MAX.
6.0 kVDC MAX.



The HIGH VOLTAGE terminal output is used for outputting the testing voltage in ACW, DCW and IR tests. The terminal is recessed for safety and used in conjunction with the RETURN terminal.

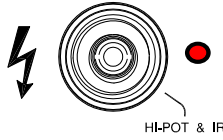

WARNING

USE EXTREME CAUTION. Do not touch the HIGH VOLTAGE terminal during testing.

HIGH VOLTAGE pilot lamp



The HIGH VOLTAGE pilot lamp will light up red when an output terminal is active. Only after the test has finished or stopped will the lamp turn off.

RETURN terminal

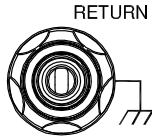

The RETURN terminal is used for ACW, DCW, IR and CONT tests.

OUTPUT and RETURN terminals

All models

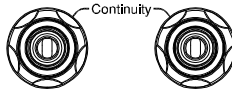

The OUTPUT terminal (red) and RETURN terminal (black) are used for CONT (Continuity) test.

SENSE H/L and SOURCE H/L terminals

GPT-12004,
GPT-15004 only

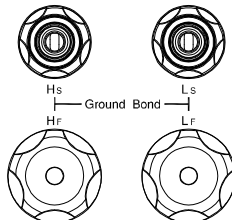

The SENSE H, SENSE L, SOURCE H and SOURCE L, terminals are used for GB (Ground Bond) test.

Set Up

Tilting the Stand

Horizontal position

Place the unit on a flat surface horizontally.

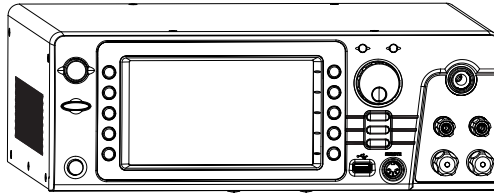

Tilt stand position

Gently pull the 2 stands out from the bottom and the unit will be placed in the tilt stand position.

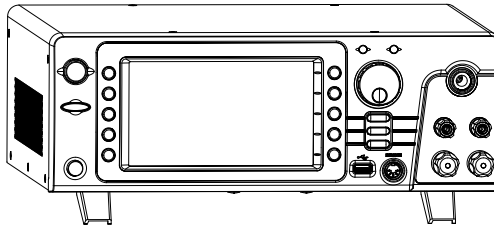

Line Voltage Connection and Power Up

Background The GPT-10000 accepts line voltages of 100 - 240V at 50Hz or 60Hz.

Steps 1. Connect the power cord to the AC Mains Input socket on the rear panel.

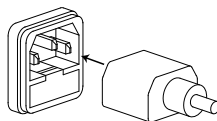

2. If the power cord does not have an earth ground, ensure the ground terminal is connected to an earth ground.

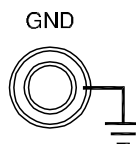

Ensure the power cord is connected to an earth ground. Failure could be harmful to the operator and instrument.

3. Press the Power button.

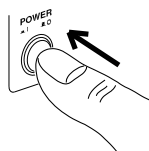

4. When the unit is powered up, the display will show the last time parameters in either MANU or AUTO test mode as shown below.

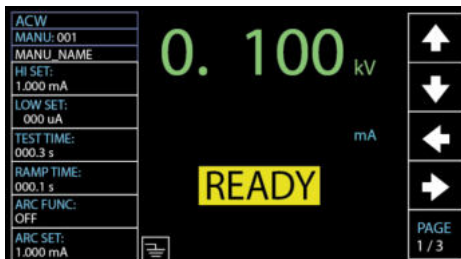

Installing the Optional LAN/GPIB Card

Background The optional LAN/GPIB is a user-installable option. Follow the instructions below to install the GPIB card.

 **WARNING** Before installing optional GPIB/LAN card ensure the GPT-10000 is turned off and disconnected from power.

Steps 1. Remove screws from the rear panel cover plate.

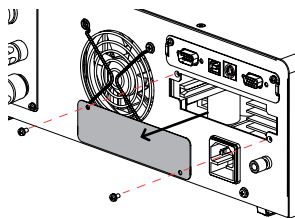

2. Insert the GPIB/LAN card into the opening of rear panel. Push the card gently until it is fully inserted followed by fastening the screws.

GPIB Card

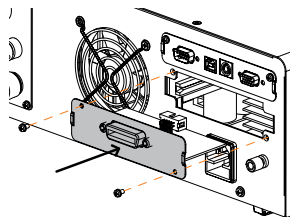

LAN Card

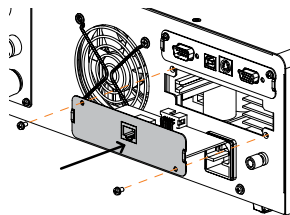

Workplace Precautions

Background The GPT-10000 is a high voltage instrument that outputs dangerous voltages. The following section describes precautions and procedures that must be followed to ensure a safe work environment.



WARNING

The GPT-10000 generates voltages in excess of 5kVAC or 6kVDC. Follow all safety precautions, warnings and directions given in the following section when using the instrument.

1. Only technically qualified personnel should be allowed to operate the safety analyzer.
2. The operating workplace must be fully isolated, especially when the instrument is in operation. The instrument should be clearly labeled with appropriate warning signage.
3. The operator should not wear any conductive materials, jewelry, badges, or other items, such as wrist watches.
4. The operator should wear insulation gloves for high voltage protection.
5. Ensure the earth ground of the line voltage is properly grounded.
6. Ensure any devices that are adversely affected by magnetic fields are not placed near the tester.

Operating Precautions

Background The GPT-10000 is a high voltage instrument that outputs dangerous voltages. The following section describes precautions and procedures that must be followed to ensure that the tester is operated in a safe manner.



The GPT-10000 generates voltages of up to 5kVAC or 6kVDC. Follow all safety precautions, warnings and directions given in the following section when using the instrument.

1. Never touch the safety analyzer, lead wires, terminals, probes and other connected equipment when the tester is testing.
2. Do not turn the safety analyzer on and off quickly or repeatedly. When turning the power off, please allow a few moments before turning the power back on. This will allow the protection circuits to properly initialize.

Do not turn the power off when a test is running, unless in an emergency.

3. Only use those test leads supplied with the instrument. Leads with inappropriate gauges can be dangerous to both the operator and the instrument.
For GB testing, never use the Sense leads on the SOURCE terminals.
4. Do not short the HIGH VOLTAGE terminal with ground. Doing so could charge the chassis to dangerously high voltages.

5. Ensure the earth ground of the line voltage is properly grounded.
6. Only connect the test leads to the HIGH VOLTAGE/SOURCE H/SENSE H terminals before the start of a test. Keep the test leads disconnected at all other times.
7. Always press the STOP button when pausing testing.
8. Do not leave the safety analyzer unattended. Always turn the power off when leaving the testing area.
9. When remotely controlling the safety analyzer, ensure adequate safety measures are in place to prevent:
 - Inadvertent output of the test voltage.
 - Accidental contact with the instrument during testing. Ensure that the instrument and DUT are fully isolated when the instrument is remotely controlled.
10. Ensure an adequate discharge time for the DUT.

When DCW or IR tests are performed, the DUT, test leads and probes become highly charged. The GPT-10000 has discharge circuitry to discharge the DUT after each test. The time required for a DUT to discharge depends on the DUT and test voltage.

Never disconnect the safety analyzer before a discharge is completed.

Basic Safety Checks

Background The GPT-10000 is a high voltage device and as such, daily safety checks should be made to ensure safe operation.

1. Ensure all test leads are not broken and are free from defects such as cracks or splitting.
 2. Ensure the safety analyzer is always connected to an earth ground.
 3. Test the safety analyzer operation with a low voltage/current output:
Ensure the safety analyzer generates a FAIL judgment when the HIGH VOLTAGE and RETURN terminals are shorted (using the lowest voltage/current as the testing parameters).
-



Do not use high voltages/currents when the HIGH VOLTAGE and RETURN terminals are shorted. It may result in damage to the instrument.

OPERATION

Menu Tree	31
Menu Tree Overview	32
Test Lead Connection	36
ACW, DCW, IR Connection.....	36
GB Connection.....	37
CONT Connection.....	38
Manual Tests	39
Setting the Test Function.....	40
Choose/Recall a Manual Test Number.....	41
Creating a MANU Test File Name.....	42
Setting the Upper and Lower Limits	43
Setting the Test Time	45
Setting the Ramp Up Time.....	47
Setting the Ramp Down Time	49
Setting the Test Voltage or Test Current	51
Setting the Test Frequency	53
Setting a Reference Value.....	54
Setting an Initial Voltage	55
Setting the Wait Time	57
Setting the ARC Function.....	59
Setting MAX HOLD.....	62
Setting PASS HOLD.....	63
Setting IR Mode	64
Setting GND OFFSET	66
Setting GB Contact	68
Zero Check for the Test Leads.....	70
Setting the Grounding Mode.....	73
Setting Contact Check.....	80
Setting ACW & DCW Mode Filter	82

Setting IR Mode Filter.....	84
Screenshot Hardcopy.....	86
Running a MANU Test.....	88
PASS / FAIL MANU Test.....	93
Special MANU Test Mode (000).....	98
Sweep Function.....	100
Automatic Tests.....	103
Choose/Recall an AUTO Test.....	104
Creating an AUTO Test File Name.....	105
Adding a Step to the AUTO Test.....	106
Continuous AUTO Tests.....	108
AUTO Test Page Editing.....	110
Running an Automatic Test.....	116
Automatic Test Results.....	122

Menu Tree

This section describes the overall structure of the operation statuses and modes for the GPT-10000 safety analyzers. The testers have two main testing modes (MANU, AUTO), one system mode (SYSTEM) and 5 main operation statuses (READY, TEST, PASS, FAIL and STOP).

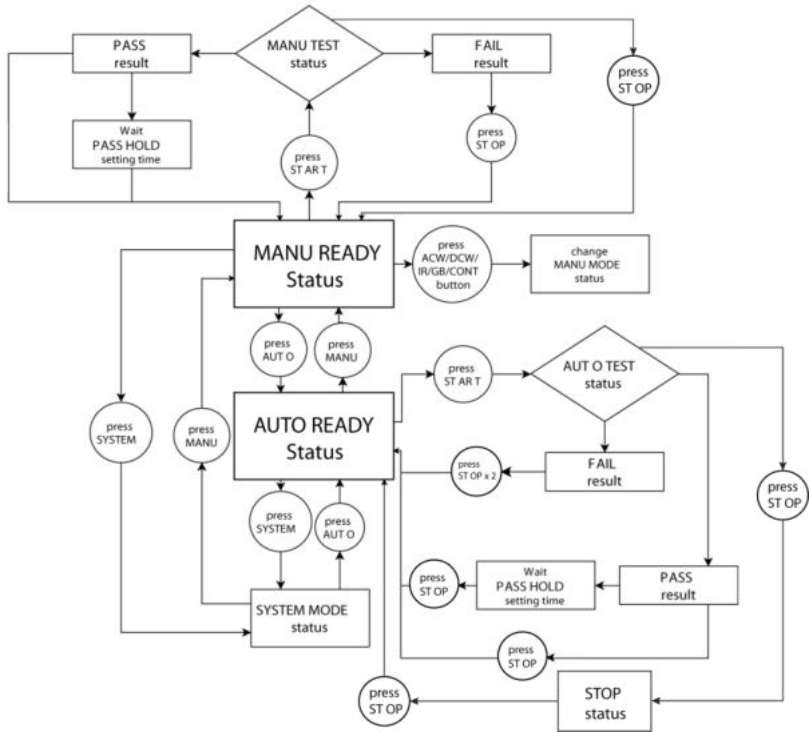

Menu Tree Overview

MANU Mode MANU mode is used to create and/or execute a single test. Only under MANU mode can parameters be edited for each manual test.

MANU mode

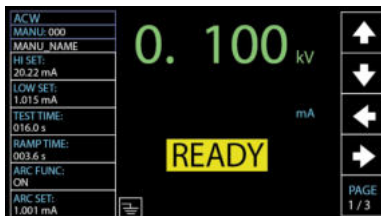

AUTO Mode AUTO mode indicates that the tester is automatic, which consists of a sequential AUTO test of up to 10 MANU steps. Also, several groups of AUTO tests can be further interconnected for an advanced AUTO test.

AUTO mode

AUTO: 001	AUTO_NAME		00101			↑
MANU TEST	V/I	HI SETTING	LOW SETTING	STEP	HOLD	
001	DCW	0.100kV	1.000mA	000	uA	P.C/F.C
002	ACW	0.100kV	1.000mA	000	uA	P.C/F.C
026	IR	0.050kV	49.99GΩ	001.0MΩ		P.C/F.C

SYSTEM Mode

System mode covers the Display Set, Buzzer, Interface, Control, System Time, Data Initialize, Information, Statistics, USB Disk and CONTACT CHK settings. These settings are system-wide and applied to both MANU and AUTO tests.

SYSTEM mode



READY Status (Yellow Color)

When the tester is in READY status of MANU or AUTO test, it is ready to begin testing. Pressing the START button will begin testing and put the tester into TEST status. Pressing the AUTO key will change from MANU - READY status to AUTO - READY status and vice versa.

READY status in MANU test

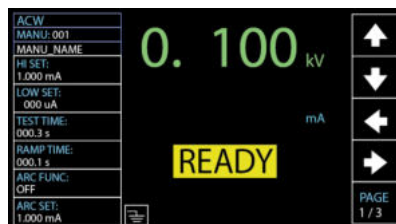

READY status in AUTO test

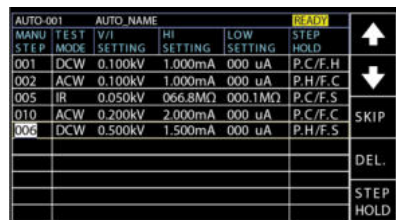

Test Lead Connection

This section describes how to connect the GPT-10000 to a DUT for withstanding, insulation resistance, ground bond as well as continuity testing.

ACW, DCW, IR Connection

Background

ACW, DCW and IR tests use the HIGH VOLTAGE terminal and RETURN terminal with the GHT-115 test leads.

ACW, DCW, IR Connection

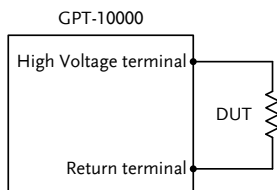

Steps

1. Turn the power off on the safety analyzer.
2. Connect the high voltage test lead (red) to the HIGH VOLTAGE terminal and screw firmly into place.
3. Connect the return test lead (white with holder) into the RETURN terminal and screw the protector bar into place, as shown below.

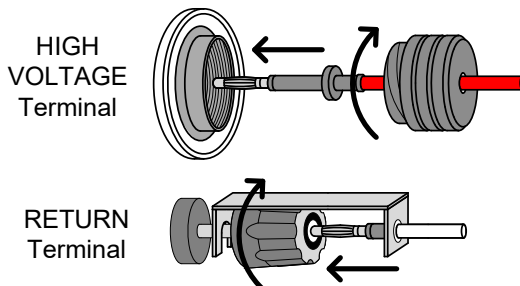

GB Connection

Background GB tests use the SENSE H/L and SOURCE H/L terminals with the GTL-215 test leads.

GB Connection

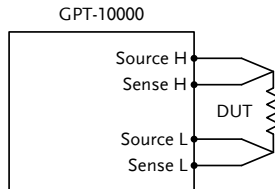

- Steps**
1. Turn the power off on the safety analyzer.
 2. Connect the Sense H lead to the SENSE H terminal.
 3. Connect the Sense L lead to the SENSE L terminal.
 4. Connect the Source H lead to the SOURCE H terminal.
 5. Connect the Source L lead to the SOURCE L terminal.

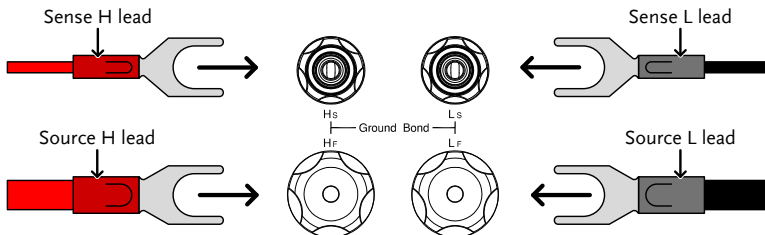

CONT Connection

Background

CONT tests use the OUTPUT and RETURN terminals with the GTL-115 test leads.

CONT Connection

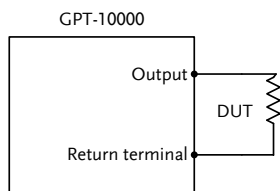

Steps

1. Turn the power off on the safety analyzer.
2. Connect the OUTPUT test lead (white) to the OUTPUT terminal.
3. Connect the RETURN test lead (white with holder) into the RETURN terminal and screw the protector bar into place, as shown below.

OUTPUT Terminal

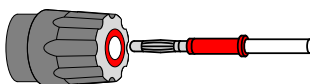

RETURN Terminal

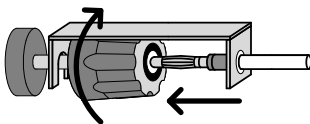

Manual Tests

This section describes how to create, edit and run a *single* ACW, DCW, IR, GB and CONT manual tests. Each Manual setting described in this chapter *only applies to the selected* manual test – *no other manual tests are affected*.

Each manual test can be stored/recalled to/from one of 100 memory locations. Each stored manual test can be used as a test step when creating an AUTO test (page 100).

- Setting the Test Function → from page 40.
- Choose/Recall a Manual Test Number → from page 41.
- Creating a MANU Test File Name → from page 42.
- Setting the Upper and Lower Limits → from page 43.
- Setting the Test Time → from page 45.
- Setting the Ramp Up Time → from page 47.
- Setting the Ramp Down Time → from page 49.
- Setting the Test Voltage or Test Current → from page 51.
- Setting the Test Frequency → from page 53.
- Setting a Reference Value → from page 54.
- Setting an Initial Voltage → from page 55.
- Setting the Wait Time → from page 57.
- Setting the ARC Function → from page 59.
- Setting MAX HOLD → from page 62.
- Setting PASS HOLD → from page 63.
- Setting IR Mode → from page 64.
- Setting GND OFFSET → from page 66.
- Setting GB Contact → from page 68.
- Zero Check for the Test Leads → from page 70.
- Setting the Grounding Mode → from page 73.
- Setting Contact Check → from page 80.
- Setting IRMode Filter → from page 82.
- Screenshot Hardcopy → from page 82.
- Running a MANU Test → from page 88.
- PASS / FAIL MANU Test → from page 93.
- Special MANU Test Mode (000) → from page 98.
- Sweep Function → from page 100.

Setting the Test Function

Background There are five test functions, AC Withstand, DC Withstand, Insulation Resistance, Ground Bond and Continuity tests.

- Steps**
1. If the tester is in AUTO or SYSTEM mode, press the **MANUAL** key to put the tester into MANU mode.
 2. To choose the test function, press the ACW, DCW, IR, GB or CONT key on the front panel.





3. The key of selected test function is lit, and the test function selected is shown on the upper-left corner of the display.

Selected Test Function



Choose/Recall a Manual Test Number

Background ACW, DCW, IR, GB and CONT tests can only be created and edited in the MANU mode. MANU number 001 to 100 can be saved and thus be loaded when editing/creating a MANU test or AUTO test. MANU number 000 is a special mode. See page 98 for details on the special mode.

- Steps**
1. If the tester is in AUTO or SYSTEM mode, simply press the MANUAL key to switch to MANU mode. 
 2. Use the scroll wheel to choose the MANU number. 
- MANU # 001~100
(MANU# 000 is a special mode)

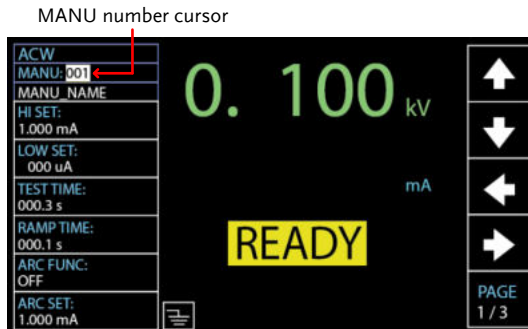

 **Note**

Manual number can only be selected or recalled when the “READY” status shows on the screen. If the “FAIL” status appears, it is required to press STOP key first before selecting or recalling procedure.

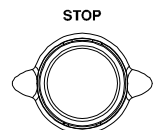

Creating a MANU Test File Name

Background Each manual test can have a user-defined name (default: MANU_NAME) up to 10 characters long. See the available list of characters below.

Character List

0	1	2	3	4	5	6	7	8	9	_
A	B	C	D	E	F	G	H	I	J	K
L	M	N	O	P	Q	R	S	T	U	V
W	X	Y	Z	a	b	c	d	e	f	g
h	i	j	k	l	m	n	o	p	q	r
s	t	u	v	w	x	y	z			

- Steps**
1. Press the UP / DOWN arrow soft-keys to bring the cursor to the MANU_NAME (default name) field. The characters table will appear in the right hand accordingly.

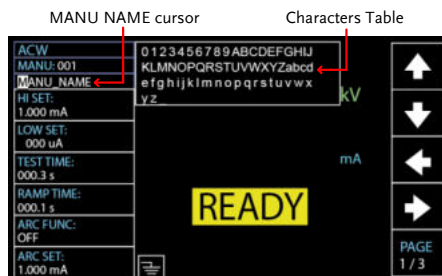

2. Use the scroll wheel to scroll through the available characters.



3. Press the LEFT / RIGHT arrow soft-keys to move the cursor to the next character.



4. The MANU test file name is set when the cursor is moved to another setting.

Setting the Upper and Lower Limits

Background There is both a LOW and HI judgment setting. When the measured value is below the LOW SET setting, the test will be judged as FAIL. When the value exceeds the HI SET setting the test will be judged as FAIL. Any measurement between the LOW SET and HI SET setting is judged as PASS. The LOW SET limit cannot be made greater than the HI SET limit.

- Steps**
1. Press the UP / DOWN arrow soft-keys to bring the cursor to the HI SET setting.

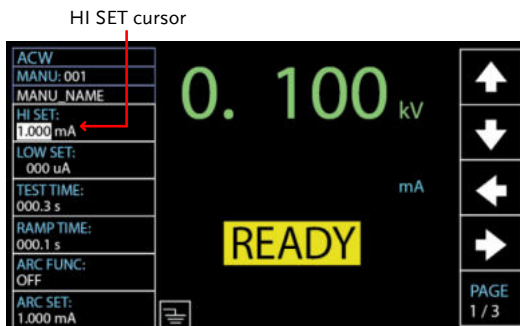
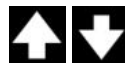

2. Use the scroll wheel to set the HI SET limit.



ACW (HI)	001 μ A~42.00mA (GPT-12XXX) 001 μ A~110.0mA (GPT-15XXX)
DCW (HI)	001 μ A~11.00mA (GPT-12XXX) 001 μ A~21.00mA (GPT-15XXX)
IR (HI)	000.2M Ω ~50.00G Ω , OFF
GB (HI)	000.1m Ω ~650.0m Ω
CONT (HI)	00.01 Ω ~80.00 Ω

- Press the UP / DOWN arrow soft-keys to bring the cursor to the LOW SET setting.

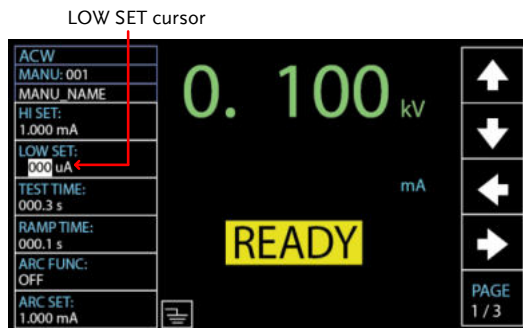

- Use the scroll wheel to set the LOW SET limit.



ACW (LOW)	000 μ A~41.99mA (GPT-12XXX)
	000 μ A~109.9mA (GPT-15XXX)
DCW (LOW)	000 μ A~10.99mA (GPT-12XXX)
	001 μ A~20.99mA (GPT-15XXX)
IR (LOW)	000.1M Ω ~49.99G Ω
GB (LOW)	000.0m Ω ~649.9m Ω
CONT (LOW)	00.00 Ω ~79.99 Ω



Note

*Please note that the resolution of the measured value depends on the resolution of HI SET setting.



Note

The LOW SET setting is limited by the HI SET setting. The LOW SET limit cannot be greater than the HI SET limit.

When setting the current, be aware that a maximum of 200VA can be set for ACW and 50W for DCW, respectively in terms of GPT-12XXX series.

As for GPT-15XXX series, a maximum of 500VA can be set for ACW and 100W for DCW, respectively.

Setting the Test Time

Background

This setting is used to set the test time for a test. The test time determines how long the test voltage or current is applied to the DUT. This test time does not include RAMP UP time or RAMP DOWN time (note: GB and CONT do not have RAMP UP or RAMP DOWN). The test time can be set from 0.3 seconds to 999.9 seconds for ACW, DCW, IR, GB and CONT, with a resolution of 0.1 seconds for all modes. Also, the test time can be turned off when using the ACW or DCW test functions.

Each test has a RAMP UP and RAMP DOWN time (except GB and CONT), respectively. Refer to page 47 & 49 for more details.

Output Voltage Timing Chart (Resistive load)

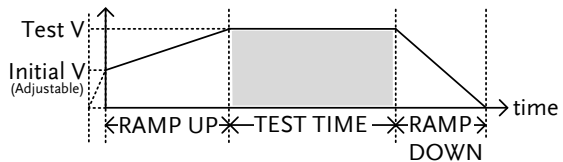

Steps

1. Press the UP / DOWN arrow soft-keys to bring the cursor to the TEST TIME setting.

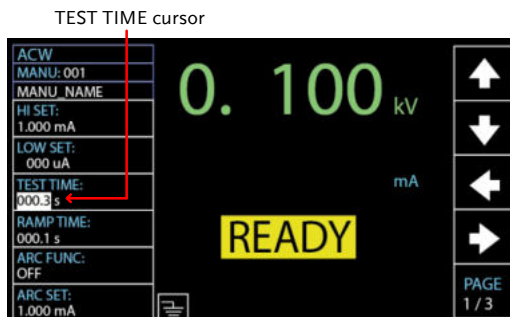

- Use the scroll wheel to set the TEST TIMER value.



ACW	OFF, 000.3s~999.9s
DCW	OFF, 000.3s~999.9s
IR	000.3s~999.9s
GB	000.3s~999.9s
CONT	000.3s~999.9s



Note

With the ACW test function, when the test current is beyond 30mA, the Ramp Up Time + Test Time cannot exceed 240 seconds. At this current level, the tester also needs to pause after a test for a time equal to or greater than the output time.

Turn Off Test Time

When in either ACW or DCW test, the TEST TIME can be turned off, which means the test without test time will last infinitely until FAIL judgment occurs.

Identical with the regular setting for TEST TIME, turn off the timer by using the scroll wheel to set OFF for TEST TIME value.



TEST TIME OFF



Setting the Ramp Up Time

Background

The Ramp Up time is the total time taken for the tester to reach the test voltage level. The Ramp Up time can be set from 000.1 to 999.9 seconds. The Ramp Up time is only applicable for ACW, DCW and IR tests.

Output Voltage Timing Chart (Resistive load)

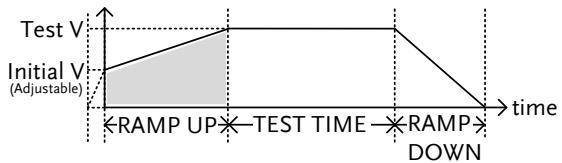

Steps

1. Press the UP / DOWN arrow soft-keys to bring the cursor to the RAMP TIME setting.

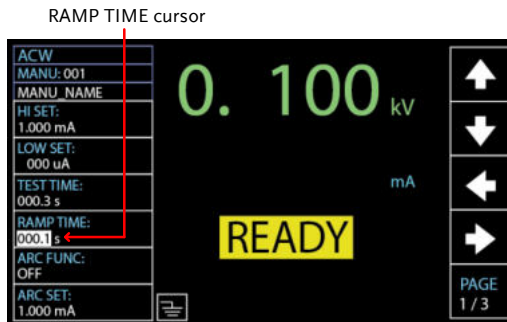

2. Use the scroll wheel to set the RAMP TIME value.



ACW	000.1s~999.9s
DCW	000.1s~999.9s
IR	000.1s~999.9s

Ramp Time
Duration
Indicator

After pressing START to begin a test with set RAMP TIME, a section at the lower right corner of display shows the counting duration of RAMP TIME, which will run to the set value followed by the test time. See the screenshot shown below.

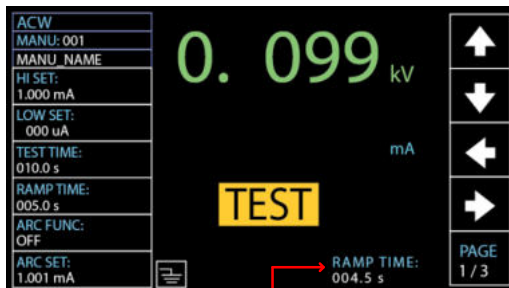

RAMP TIME duration indicator

Setting the Ramp Down Time

Background

The Ramp Down time is the time taken for tester to gradually lower down output test voltage from the set highest level to zero volt. The Ramp Down time can be set from 000.0 to 999.9 seconds. The Ramp DOWN time is only applicable for ACW, DCW and IR tests.

Output Voltage Timing Chart (Resistive load)

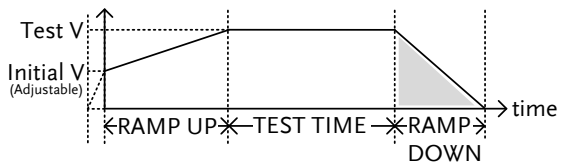

Steps

1. Press the PAGE soft-key to move to the 2/3 page where RAMP DOWN setting appears for ACW, DCW and IR.



2. Press the UP / DOWN arrow soft-keys to bring the cursor to the RAMP DOWN setting.

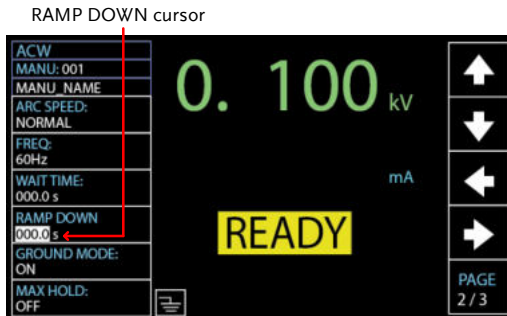
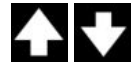

3. Use the scroll wheel to set the RAMP DOWN value.



ACW	000.0s~999.9s
DCW	000.0s~999.9s
IR	000.0s~999.9s

Ramp Down
Duration
Indicator

After the set TEST TIME is fully completed, a section at the lower right corner of display shows the counting duration of RAMP DOWN, which will run to the set value by user. See the screenshot shown below.

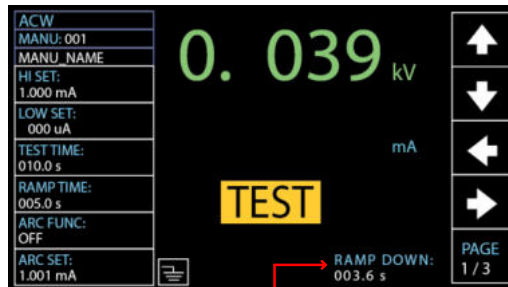

RAMP DOWN duration indicator

Setting the Test Voltage or Test Current

Background The test voltage can be set from 0.050kV to 5.1kV for ACW, 0.050kV to 6.1kV for DCW and 0.050 to 1.2kV for IR (50V steps*). For GB tests the test current can be set from 3A to 33A. As for CONT test, the test current is fixedly set at the default value of 100mA.

- Steps**
1. Press the UP / DOWN arrow soft-keys to bring the cursor to the voltage or ampere setting depending on selected test function.

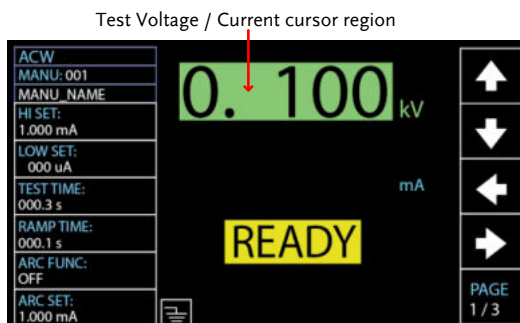
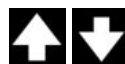

2. Use the scroll wheel to set the test voltage or ampere level.



ACW	0.050kV ~ 5.1kV ¹
DCW	0.050kV ~ 6.1kV ²
IR	0.05kV ~ 1.2kV (50V steps)
GB	3.00A ~ 33.00A
CONT	100mA ³

- ¹ At least 0.3 seconds is needed to reach a set voltage of 50V/10mA.
 - ² At least 0.3 seconds is needed to reach a set voltage of 50V/2mA.
 - ³ Test current for CONT is fixed at 100mA
-



Note

When setting the current, be aware that a maximum of 200VA can be set for ACW and 50W for DCW, respectively in terms of GPT-12XXX series.

As for GPT-15XXX series, a maximum of 500VA can be set for ACW and 100W for DCW, respectively.

The ground bond voltage (GBV) is calculated as the HI SET limit x Test Current.

Setting the Test Frequency

Background A test frequency of 60Hz or 50Hz can be set, regardless of the input line voltage. The test frequency setting only applies to ACW and GB tests.

 **Note** The test frequency can only be set for ACW or GB tests.

Steps 1. Press the PAGE soft-key to move to the 2/3 page where **FREQ** setting appears for ACW. 

As for GB test, the **FREQ** setting shows in the 1/2 page directly. 

2. Press the UP / DOWN arrow soft-keys to bring the cursor to the **FREQ** setting. 

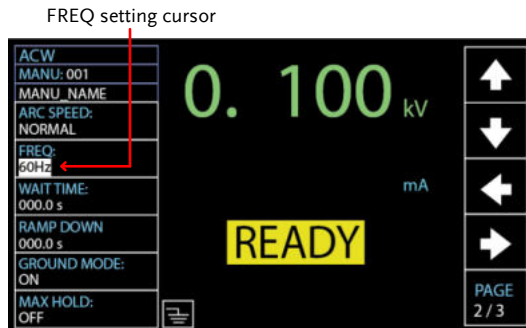



3. Use the scroll wheel to set the test frequency. 

ACW, GB 50Hz, 60Hz

Setting a Reference Value

Background The REF VALUE acts as an offset. The REF VALUE is subtracted from the measured current (ACW, DCW) or measured resistance (IR, GB, CONT).

Steps 1. Press the PAGE soft-key to move to the 3/3 page where REF VALUE setting appears for ACW and DCW. 

As for IR and GB, the REF VALUE setting shows in the 2/2 page. 

The REF VALUE setting appears in the 1/1 page directly for CONT. 

2. Press the UP / DOWN arrow soft-keys to bring the cursor to the REF VALUE setting. 

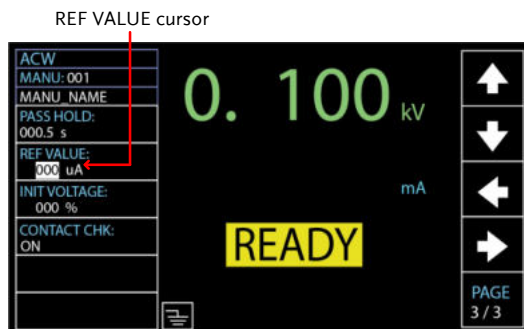

3. Use the scroll wheel to set the REF value. 

ACW	000uA~ 41.99mA (GPT-12XXX) *HI SET + REF value \leq 42.00mA 000uA~ 109.9mA (GPT-15XXX) *HI SET+REF value \leq 110.0mA
DCW	000uA~ 10.99mA (GPT-12XXX) *HI SET + REF value \leq 11.00mA 000uA~ 20.99mA (GPT-15XXX) *HI SET+REF value \leq 21.00mA
IR	000.0M Ω ~50.00G Ω
GB	000.0m Ω ~650.0m Ω *ISET x (HI SET + REF value) is no greater than 7.2V
CONT	00.00 Ω ~80.00 Ω *ISET(100mA) x (HI SET + REF value) is no greater than 8V



Note

For IR test, a reference value of tester can be automatically created via the GND OFFSET function. See page 66 for details.

For GB and CONT tests, a reference value of test lead can be automatically created via the ZERO CHECK function. See page 70 for details.

Setting an Initial Voltage

Background

In essence, the test voltage for both ACW and DCW will gradually and linearly rise up, from zero, to the target set voltage in accord with the set RAMP TIME ahead of the TEST TIME.

Nevertheless, under certain circumstances, user may have preferences on the percentage of starting test voltage. Therefore, the INIT VOLTAGE provides another alternative for different applications on user side.

It is easy to set a preferred percentage of the test voltage in the INIT VOLTAGE setting and the starting test voltage will commence from the value corresponding to the set percentage relative to the target test voltage.



Note

INIT VOLTAGE setting is only applicable to both ACW and DCW tests.

Steps

1. Press the PAGE soft-key to move to the 3/3 page where the INIT VOLTAGE setting appears for ACW and DCW.



2. Press the UP / DOWN arrow soft-keys to bring the cursor to the INIT VOLTAGE setting.

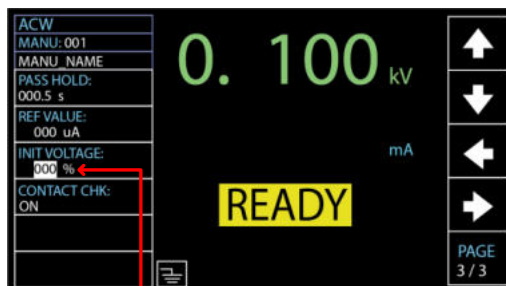

INIT VOLTAGE cursor

3. Use the scroll wheel to set the percentage of INIT VOLTAGE.



INIT VOLTAGE 000% ~ 099%

Setting the Wait Time

Background

The Wait Time refers to the pending time before FAIL judgment appears. By default, FAIL judgment appears when test has reached 0.3 second at the earliest manner. However, when user sets 1.0 second for Wait Time on the tester with 0.5 second of Ramp Up time and 1.0 second of Test Time, the FAIL judgment will be shown when Test Time has reached 0.5 second. In short, Wait Time is the pending duration which dominates the priority over both Ramp UP time and Test Time in terms of timing of FAIL judgment.

The WAIT TIME is only applicable for ACW, DCW and IR tests.

Steps

1. Press the PAGE soft-key to move to the 2/3 page where WAIT TIME setting appears for ACW and DCW.



As for IR test, the WAIT TIME setting shows in the 1/2 page.



2. Press the UP / DOWN arrow soft-keys to bring the cursor to the WAIT TIME setting.



WAIT TIME cursor



- Use the scroll wheel to set the WAIT TIME value.



ACW	000.0s~999.9s
DCW	000.0s~999.9s
IR	000.0s~999.9s

Wait Time Indicator

While the WAIT TIME is set, the indicator of WAIT TIME will be shown on the display in the set duration during a test progress for clear identification for user.

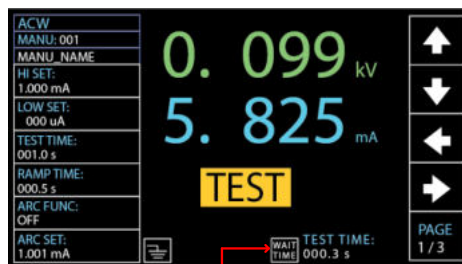

WAIT TIME indicator



Note

During the Wait Time, if test voltage is beyond the set voltage by 1.1 times, test will be stopped immediately in case of overvoltage issue.

During the Wait Time, if test current is beyond the maximum currents of each unit as follows, test will be stopped immediately in case of overcurrent issue.

	GPT-12000	GPT-15000
ACW	40mA	100mA
DCW	10mA	20mA

Setting the ARC Function

Background

ARC detection, otherwise known as flashover detection, detects fast voltage or current transients that are not normally detected. Arcing is usually an indicator of poor withstanding insulation, electrode gaps or other insulating problems that cause temporary spikes in current or voltage during ACW and DCW testing.

There are three ARC detection settings: OFF, ON & CONT, ON & STOP.

The ON & CONT setting will detect arcs over the ARC current level and continue the test, the ON & STOP setting will stop the test when an arc is detected.

ARC mode settings only apply to both ACW and DCW tests.

Steps

1. Press the UP / DOWN arrow soft-keys to bring the cursor to the ARC FUNC setting.

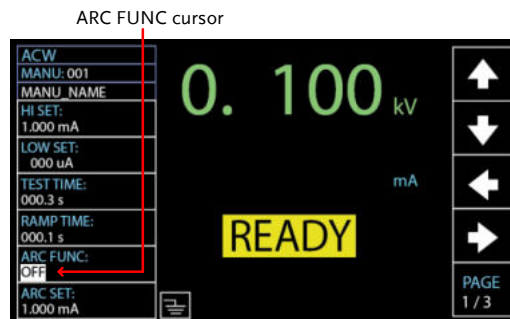
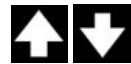

2. Use the scroll wheel to set the ARC modes setting.



ARC MODES: OFF, ON & CONT, ON & STOP

- If the ARC MODE was set to either ON & CONT, or ON & STOP, the ARC current level can be edited. Press the DOWN arrow soft-key to bring the cursor to the ARC SET setting field.

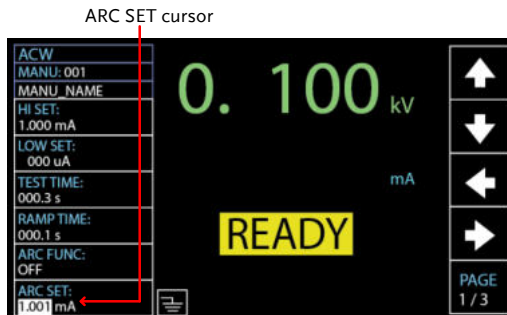

- Use the scroll wheel to edit the ARC SET level.



ACW	1.000mA~80.00mA (GPT-12XXX)
	1.000mA~200.0mA (GPT-15XXX)
DCW	1.000mA~20.00mA (GPT-12XXX)
	1.000mA~40.00mA (GPT-15XXX)



Note

The ARC SET level should be greater than or equal to the HI SET value.

- If the ARC MODE was set to either ON & CONT, or ON & STOP, the ARC speed, which indicates the threshold for width of detected ARC, can be edited. Press the PAGE soft-key to move to the 2/3 page where ARC SPEED setting appears for ACW and DCW.



- Press the UP / DOWN arrow soft-keys to bring the cursor to the ARC SPEED setting field.

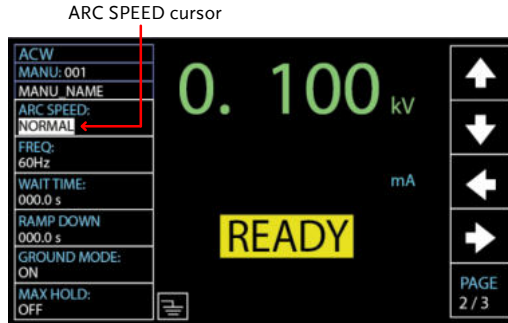
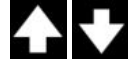

- Use the scroll wheel to select the ARC SPEED modes.



ARC SPEED	FAST	Threshold for the narrowest width of detected arc, which is the most sensitive manner.
	NORMAL	Threshold for the general width of detected arc.
	SLOW	Threshold for the widest width of detected arc, which is the manner of high tolerance.

Setting MAX HOLD

Background

The MAX HOLD setting will hold the maximum current measured in the ACW and DCW tests or the maximum resistance measured in the IR and GB tests.

For instance, when running an IR test with 120 seconds of test time and MAX HOLD enabled, the highest resistance measured in the 30 seconds of the test time will be retained on display until the next largest value. If there is no further maximum resistance occurred, the value measured in 30 seconds will be remained till the end of the test of 120 seconds.

Steps

1. Press the PAGE soft-key to move to the 2/3 page where MAX HOLD setting appears for ACW and DCW.



As for IR and GB, the MAX HOLD setting shows in the 2/2 page.



2. Press the UP / DOWN arrow soft-keys to bring the cursor to the MAX HOLD setting.

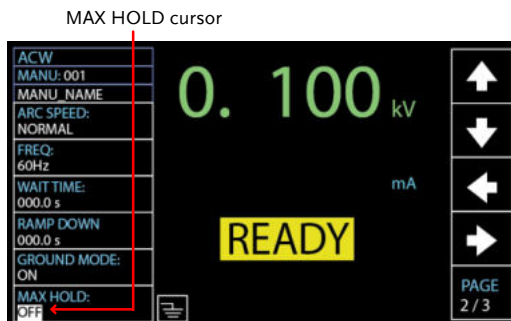

- Use the scroll wheel to set MAX HOLD.



MAX HOLD OFF, ON

Setting PASS HOLD

Background The PASS HOLD setting refers to the holding duration after PASS judgment is shown on the display. When the PASS HOLD setting is set, a PASS judgment is held until the set duration is fully reached.



The PASS HOLD setting only applies to MANU tests. This setting is ignored when running AUTO test.

Steps

- Press the PAGE soft-key to move to the 3/3 page where PASS HOLD setting appears for ACW.



And it is the 2/3 page where PASS HOLD setting appears for DCW.



As for IR and GB, the PASS HOLD setting shows in the 2/2 page.



The PASS HOLD setting appears in the 1/1 page directly for CONT.



- Press the UP / DOWN arrow soft-keys to bring the cursor to the PASS HOLD setting.



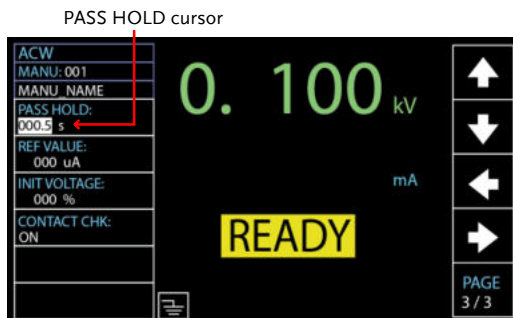

- Use the scroll wheel to set PASS HOLD duration.



PASS HOLD 000.0s ~ 999.9s, ON



- The STOP key can be pressed at any time in the set duration of PASS HOLD to promptly halt the set PASS HOLD duration. In short, user can stop, if necessary, the duration of PASS HOLD any time.
- When ON is selected, the duration of PASS HOLD will remain indefinitely until the STOP key is further pressed.

Setting IR Mode

Background

The IR MODE setting, which contains three options, STOP ON FAIL, STOP ON PASS, TIMER, only applies to IR test.

When IR MODE is set to STOP ON FAIL, the tester will show the FAIL judgment, if available, in the 0.3 second of test time at the earliest manner, regardless of the set test time.

When set to PASS ON FAIL, the tester will show the PASS judgment, if available, in the 0.3

second of test time at the earliest manner, regardless of the set test time.

The TIMER mode will run a test in a full course completely in accordance with the set test time, whether the final judgment is PASS or FAIL.



Note

If the DUT is under the situation of abnormal measurement, e.g., short circuit, the FAIL judgment of SHORT warning, though TIMER is set, will appear in the early manner regardless of the set test time.

Steps

1. Press the PAGE soft-key to move to the 2/2 page where IR MODE setting appears for IR test.



2. Press the UP / DOWN arrow soft-keys to bring the cursor to the IR MODE setting.

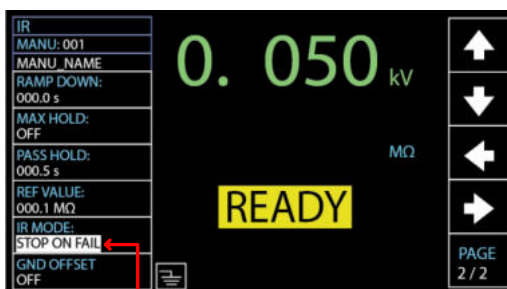

IR MODE cursor

3. Use the scroll wheel to set the IR MODE.





IR MODE STOP ON FAIL
 STOP ON PASS
 TIMER

Setting GND OFFSET

Background The GND OFFSET is used to determine the offset resistance of the tester. When a GND OFFSET is performed, the reference is automatically set to the measured resistance.

 **Note** GND OFFSET setting is only applicable to IR test.

- Steps**
1. Press the PAGE soft-key to move to the 2/2 page where GND OFFSET setting appears for IR testing. 
 2. Press the UP / DOWN arrow soft-keys to bring the cursor to the GND OFFSET setting. When selecting ON, the ZERO CHECK indicator will be shown on the display. 



GND OFFSET cursor ZERO CHECK indicator

3. Press the START button to perform the GND OFFSET. The resistance of the tester, after the GND OFFSET has finished, will be added into the REF VALUE field as the display shown below.

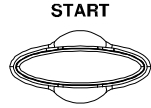

Resistance of the tester

Setting GB Contact

Background Basically, GB test has no ramp up time and thus starts from the set test time by user directly. However, due to some cases where a buffer time before test time is in fact required for GB test, e.g., in conveyor where DUTs are tested for GB by batches and certain buffer duration needed for test leads or jigs connecting with DUTs, the GB CONTACT setting practically allows user to apply to customized scenarios when necessary occurs.

 **Note** GB CONTACT setting is only applicable to GB test.

Steps

1. Press the UP / DOWN arrow soft-keys to bring the cursor to the GB CONTACT setting.

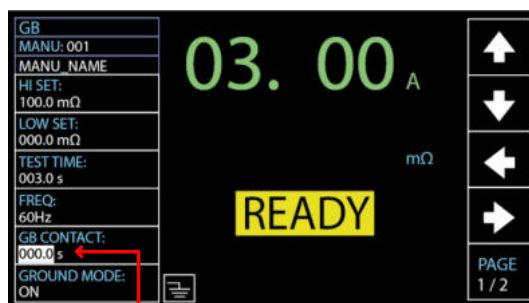

GB CONTACT cursor

2. Use the scroll wheel to set the value of GB CONTACT



GB CONTACT 000.0 s ~ 999.9 s

GB CONTACT
Duration
Indicator

After every parameter including GB CONTACT is well set, press START to begin the GB test. A section at the lower right corner of display shows the counting duration of GB CONTACT, which will run to the set value followed by the test time. See the screenshot shown below.

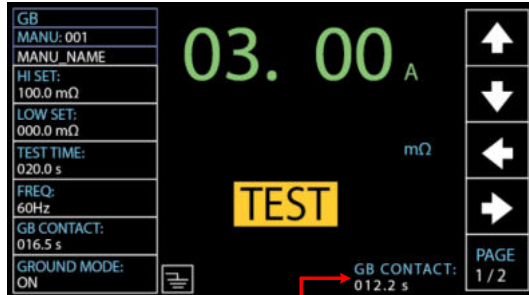

GB CONTACT duration indicator

Zero Check for the Test Leads

Background The Zeroing function is used to determine the resistance of the test leads for GB and CONT tests. When a ZERO CHECK is performed, the reference is automatically set to the measured resistance of the test leads.

**Note**

ZERO CHECK setting is only applicable to both GB and CONT tests.

Steps

1. Short the positive and negative alligator clips as shown below.

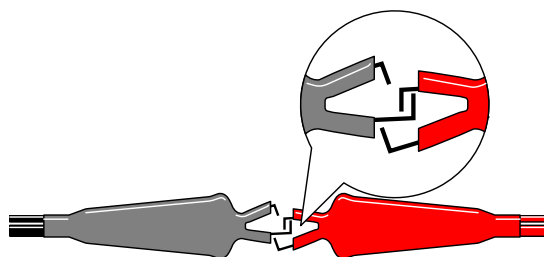

2. Press the PAGE soft-key to move to the 2/2 page where ZERO CHECK setting appears for GB testing.

PAGE
2 / 2

As for CONT, ZERO CHECK setting shows in the 1/1 page directly.

PAGE
1 / 1

3. Press the UP / DOWN arrow soft-keys to bring the cursor to the ZERO CHECK setting. When selecting ON, the ZERO CHECK indicator will be shown on the display.





ZERO CHECK cursor

ZERO CHECK indicator

4. Press the START button to perform the zero check. The resistance of the test leads, after the ZERO CHECK has finished, will be added into the REF VALUE field as the display shown below.

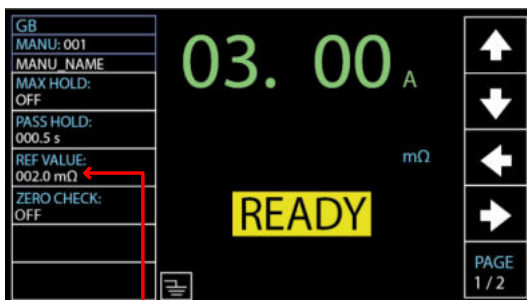
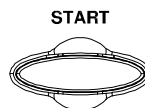

Resistance of the test leads



Note

Remember to replace the test leads to the proper position on the DUT before testing.

FAIL – GBI LOW

If SOURCE H/L terminals are open or poorly connected, the FAIL – GBI LOW status will appear on the screen. Please re-check the connection of SOURCE H/L terminals again.

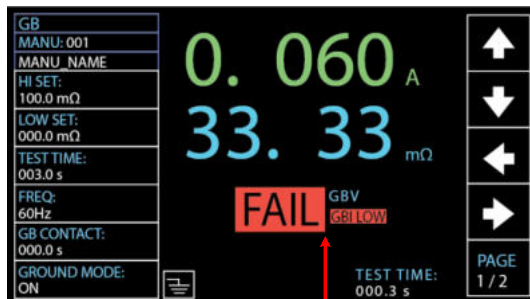

FAIL – GBI LOW status

REF VALUE = 0

Press STOP button to exit and the resistance of test leads were not properly added into the REF VALUE, which shows 000.0 mΩ as shown below. Re-check the connection of SOURCE H/L terminals and press START button again to proceed to the ZERO CHECK procedure.

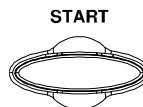

REF VALUE = 0

Setting the Grounding Mode

Background

When GROUND MODE is set to ON, the GPT-10000 grounds the return terminal to the ground. This mode is best for DUTs that are grounded to an earth ground by their chassis, fixtures or operation environment. This mode measures the potential of the HIGH VOLTAGE terminal with respect to earth ground. This means that additional noise which leaks to earth ground will also be measured. This is the safest testing mode, though potentially not as accurate.

When GROUND MODE is set to OFF, the return terminal is floating with respect to the earth ground. This mode is for DUTs that are floating and not directly connected to an earth ground. This is more accurate than when GROUND MODE is set to ON as less noise will be measured. For this reason, this testing mode is able to measure with better stability.

ACW/DCW, GROUND MODE ON, DUT grounded

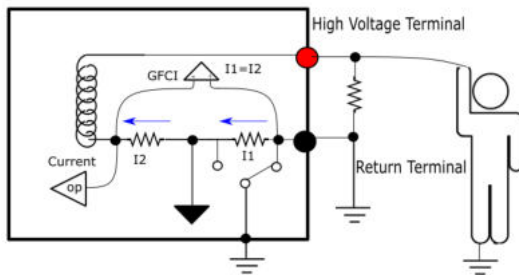

ACW/DCW, GROUND MODE ON, DUT floating

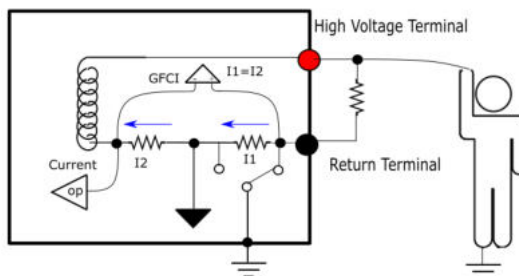

ACW/DCW, GROUND MODE OFF, DUT floating

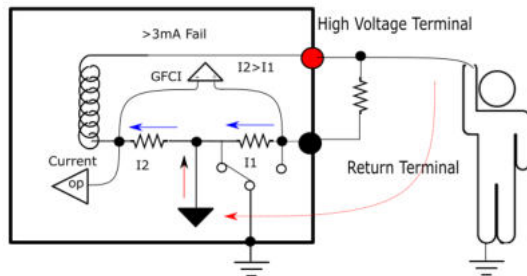

 Note

If the current value, which results from comparison between I1 and I2 current, is above 3mA, once user unexpectedly touches the DUT, the GFCI, Ground Fault Circuit Interrupter, function activates and output will be stopped immediately so that protection mechanism will be well triggered at once.

IR, GROUND MODE ON, DUT grounded

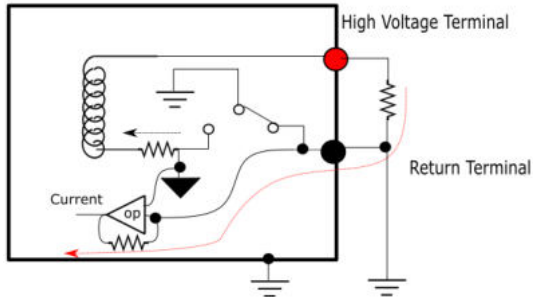

IR, GROUND MODE ON, DUT floating

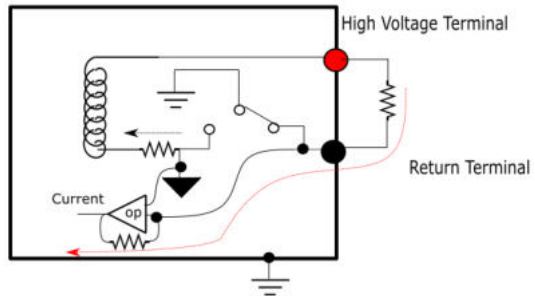

IR, GROUND MODE OFF, DUT floating

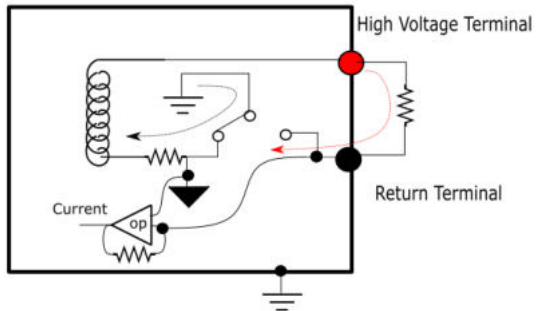

GB, GROUND MODE ON, DUT grounded

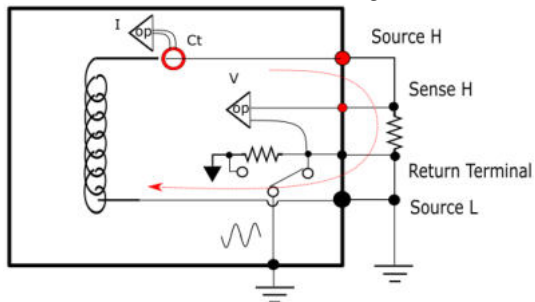

GB, GROUND MODE ON, DUT floating

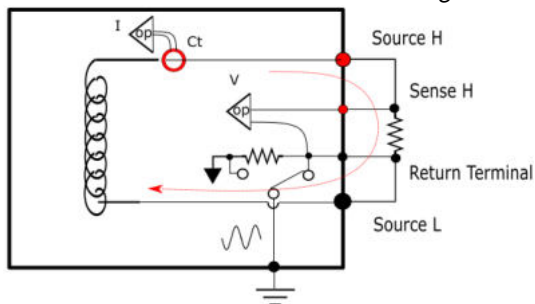

GB, GROUND MODE OFF, DUT floating

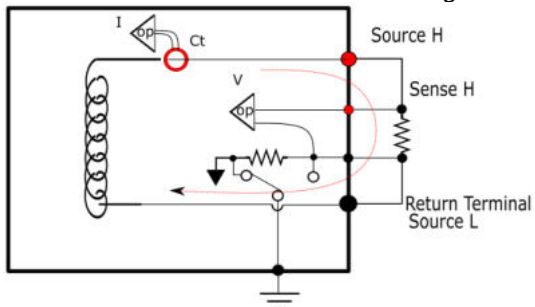

Cont., GROUND MODE ON, DUT grounded

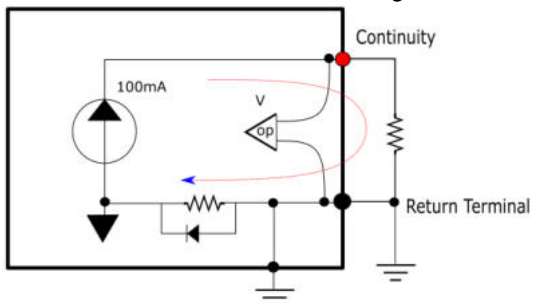

Cont., GROUND MODE ON, DUT floating

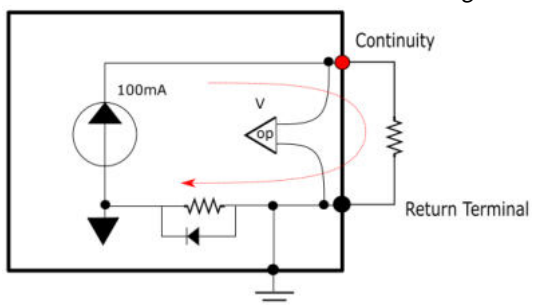

 Note

In terms of Continuity test, it is compulsory to ground the DUT and thus GROUND MODE is ON.

 Warning

When GROUND MODE is set to OFF, the DUT, fixtures or connected instrumentation cannot be grounded. This will short circuit the internal circuitry during a test.

For ACW and DCW tests, if it is not known whether the DUT test setup is grounded or not, always set GROUND MODE to ON.

Only set GROUND MODE to OFF when the DUT is floating electrically.

Steps

1. Press the PAGE soft-key to move to the 2/3 page where GROUND MODE setting appears for ACW and DCW.



As for IR and GB, the GROUND MODE setting shows in the 1/2 page.



2. Press the UP / DOWN arrow soft-keys to bring the cursor to the GROUND MODE setting.



GROUND MODE cursor



3. Use the scroll wheel to set the GROUND MODE.



GROUND MODE OFF, ON

4. The GROUND MODE icon on the display changes accordingly.



GROUND MODE ON



GROUND MODE OFF



Note

Under the IR test mode, when GROUND MODE is ON but test time is set $t < 0.5s$, the error message “TEST TIMR<0.5s” will be shown, by which user is not able to start the IR test mode unless the test time is reset to $> 0.5s$. Refer to page 45 for how to set the test time manually.

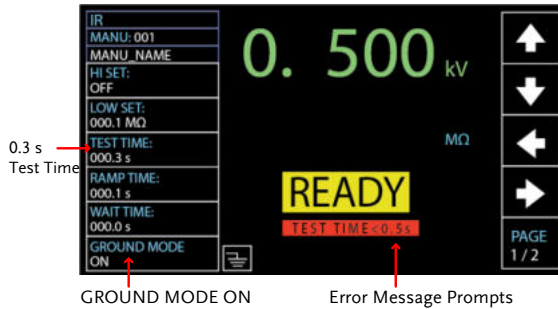

Setting Contact Check

Background

The CONTACT CHK function is used to determine if open circuit or short circuit occurs between the test leads and DUT under the ACW, DCW and IR tests. Before activating this function, it is first required to define a reference value along with relevant thresholds, for which refer to page 172.



Note

CONTACT CHK setting is only applicable to ACW, DCW and IR test modes.

Step

1. Press the PAGE soft-key to move to the 3/3 page where CONTACT CHK setting appears for ACW, DCW and IR tests.
2. Press the UP / DOWN arrow soft-keys to bring the cursor to the CONTACT CHK and turn it ON.

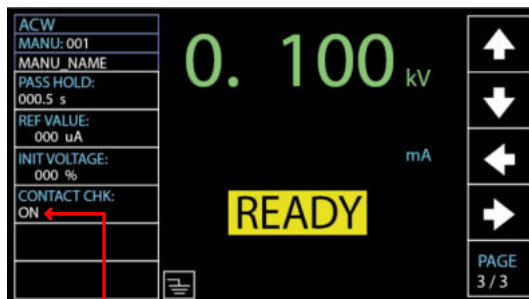

CONTACT CHK ON

- After pressing the START button, the GPT-10000 unit will perform the CONTACT CHK before running a MANU test. If the measured current is lower than the reference value by user-defined percentage, the "OPEN" status appears on the screen. While the measured current is higher than the reference value by user-defined percentage, the "SHORT" status appears instead.

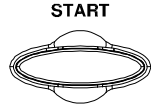

OPEN Status



OPEN Status detected

SHORT Status



SHORT Status detected



The CONTACT CHK will be invalid when reference value is defined less than 30uA, even though CONTACT CHK is turned ON. Refer to page 173 for details of reference value learning.

Setting ACW & DCW Mode Filter

Background Generally, the filter function is available for ACW, DCW and IR tests but the core mechanism varies by different test modes. In terms of ACW/DCW test, it is suggested to enable Filter On for certain applications. Enabling Filter On indicates the activation of software judgment function that judges values by interval of every 100ms in case of instantaneous misjudgment on distorted peak waveforms.



Note

Filter setting is Not available for GB test mode.

Steps

1. Press the PAGE soft-key to move to the 3/3 page where FILTER setting appears for ACW/DCW test.



2. Press the UP / DOWN arrow soft-keys to bring the cursor to the FILTER setting.



3. Use the scroll wheel to select options of FILTER setting.



FILTER

OFF, ON



FILTER Setting ON

4. Press the START button to perform ACW/DCW mode test with the filter setting ON.

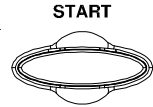

Setting IR Mode Filter

Background The filter function of IR test is used to average tests when unstable resistance issue occurs under capacitive load test.

 **Note** Filter setting is Not available for GB test mode.

Steps 1. Press the PAGE soft-key to move to the 3/3 page where FILTER setting appears for IR test.



2. Press the UP / DOWN arrow soft-keys to bring the cursor to the FILTER setting.



3. Use the scroll wheel to select options of FILTER setting.



FILTER OFF, LEVEL 1 ~ 10

LEVEL 1 To average tests of every 1 second.

LEVEL 10 To average tests of every 10 seconds.



FILTER Setting LEVEL 10

4. Press the START button to perform the test with IR mode filter. The corresponding waveforms of each option are illustrated below.

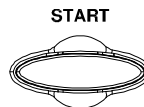

OFF

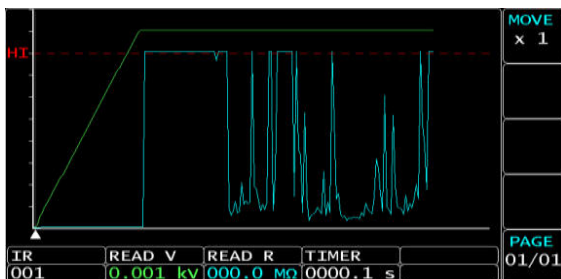

LEVEL 1

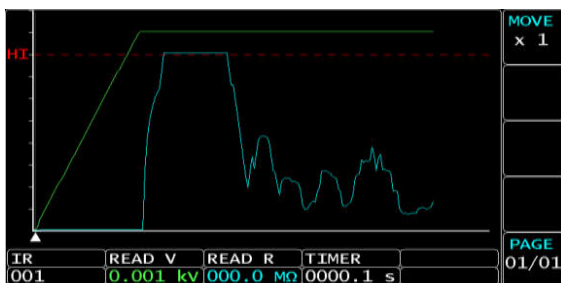

LEVEL 2

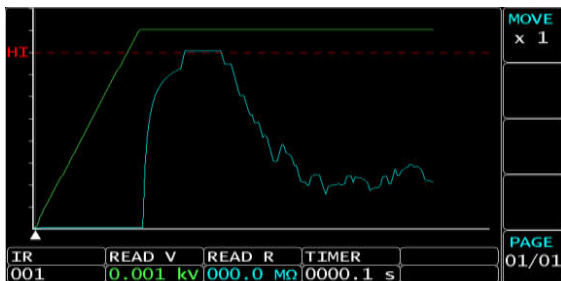

Screenshot Hardcopy

Background When connecting a USB disk to the USB host port on the front panel, it is available to execute hardcopy function, which allows user to capture screenshots from unit. The saved filename to USB disk will be in .bmp format with serial number from 01 ~ 99 (LCDGET01.bmp ~ LCDGET99.bmp) within the directory GPT1X000/SCREEN.

- Steps**
1. Press and hold the SYSTEM key for 2 seconds, and the prompt message will be shown in the upper side describing hardcopy is ongoing.

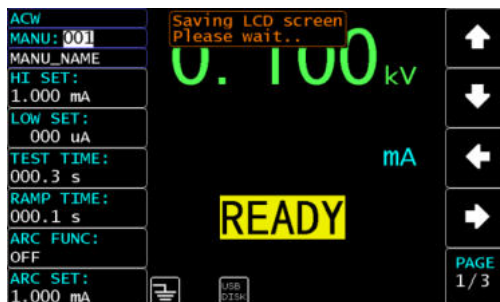

When unit is under test, the hardcopy function will be unavailable in that high voltage output will be influenced if hardcopy is underway.

Upper Limit of
Filename

When the filename upper limit LCDGET99.bmp is reached while doing hardcopy action, an error message will be shown on the display.

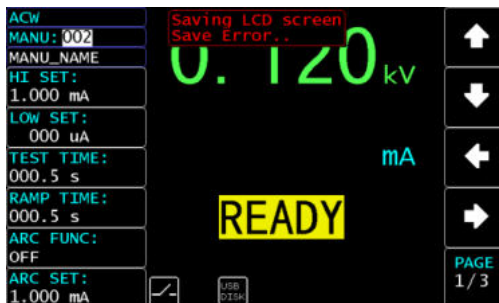

No USB Disk

When no USB disk is connected with unit while doing hardcopy action, an error message will be shown on the display as follows.



Running a MANU Test

Background A test can be run when the tester is in READY status.



Note

The tester cannot start to run a test under the following conditions:

- A protection setting has been tripped; when a protection setting has been tripped the corresponding error message is displayed on the screen. See page 257 for a comprehensive list of the all the setting errors.
 - The INTERLOCK function is ON and the Interlock key is not inserted in the signal I/O port (page 139).
 - The STOP signal has been received remotely.
 - If Double Action is ON, ensure the START button is pressed immediately after the STOP button (<0.5s).
-



Note

When a test is running the voltage output cannot be changed, unless the test is under the special manual mode. See page 98 for details.

Steps 1. Ensure the tester is in READY status for the test to come. Page 33

READY status



2. Press the START button when the tester is in the READY status. The manual test starts accordingly and the tester goes into the TEST status.

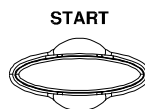

TEST status

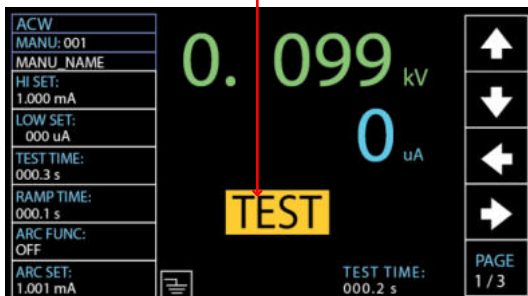

3. The test will start by showing the ongoing ramp up time followed by the ongoing test time and the ongoing ramp down time. The test will continue until the test is finished or stopped.

RAMP UP TIME

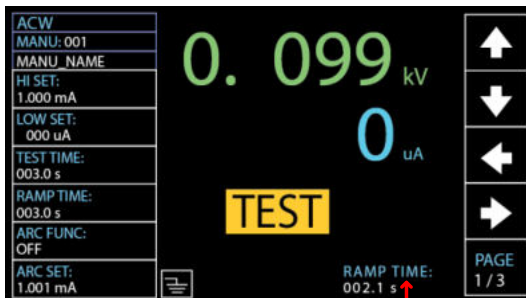

Ongoing RAMP UP TIME

TEST TIME

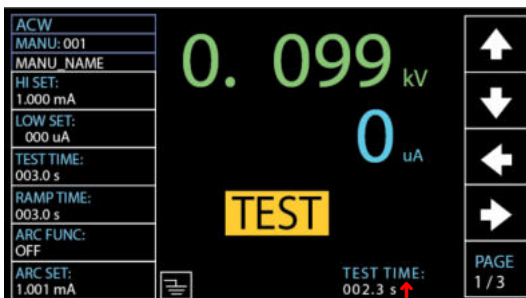

Ongoing TEST TIME

RAMP DOWN TIME

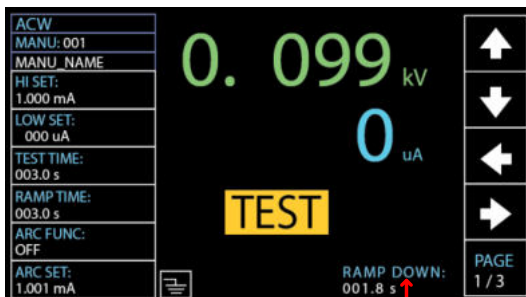

Ongoing RAMP DOWN TIME

 Note

RAMP DOWN time only appears when user has activated it. See page 49 for details.

ACW Example

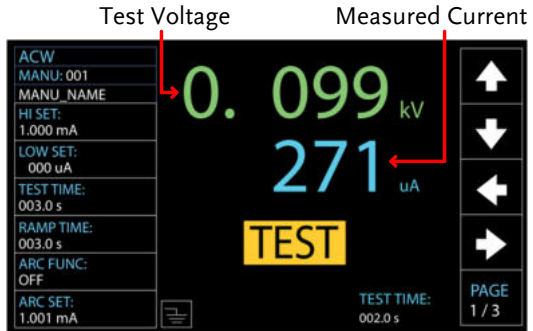

DCW Example

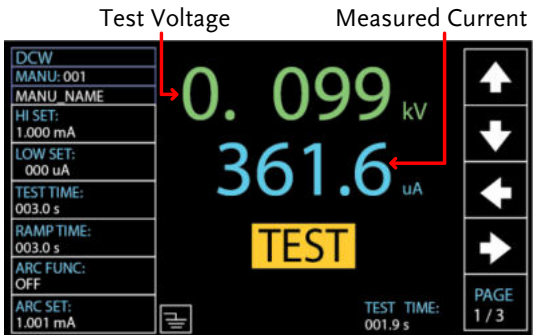

IR Example

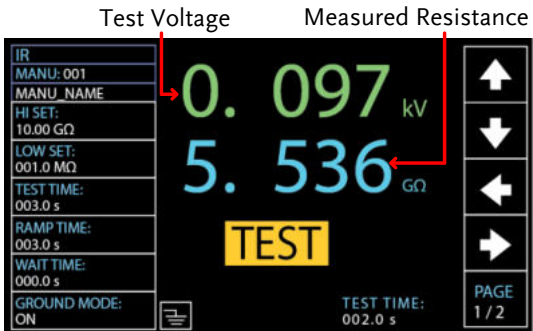

GB Example

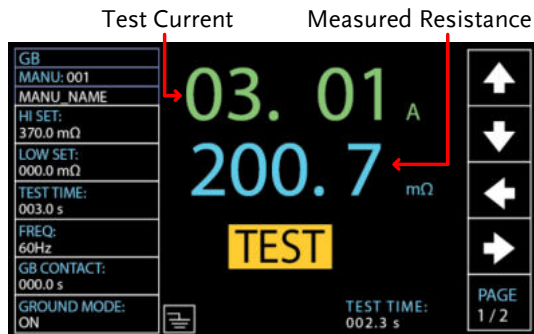

CONT Example

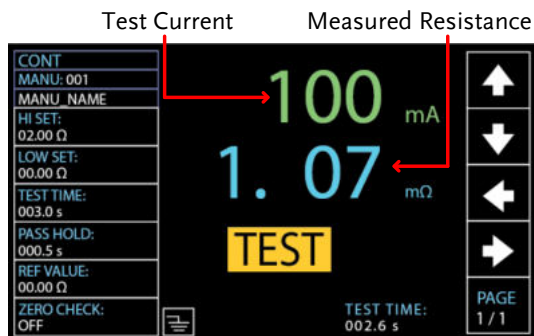

Stop the Test

1. To stop the test at any time when it is running, press the STOP button. The test will stop immediately. When the STOP button is pressed, a judgment is not made and the tester will restore to READY status.

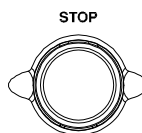

 Note

Do not touch any terminals, test leads or any other connections when the test is on.

PASS / FAIL MANU Test

Background If the test is allowed to run to completion (the test is not stopped or a protection setting is not tripped) then the tester will judge the test as either PASS or FAIL.



Note

The test will be judged PASS when:

- The HI SET and LO SET limits have not been tripped during the test time.

The test will be judged FAIL when:

- Either the HI SET or LO SET limit has been tripped during the test time.
- A protection setting has been tripped during the test time. See page 257 for a list of error messages.

PASS Judgment 1. When the test is judged as PASS, PASS will be displayed on screen, the buzzer will sound and the PASS indicator will be lit green.

PASS



PASS Judgment

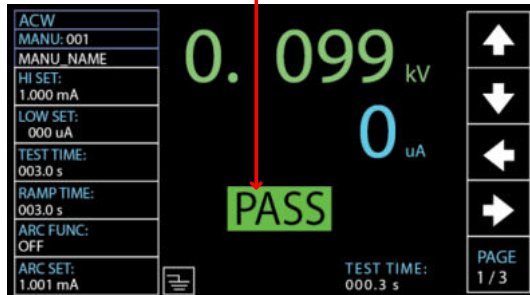

2. The tester will immediately restore back to the READY status after PASS judgment. However, if the PASS HOLD is activated, PASS judgment will persist until the set duration of PASS HOLD is fully met. Refer to page 63 for details.

In addition, pressing the STOP button during the set duration of PASS HOLD can return to READY status immediately.

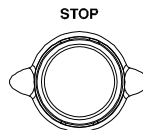

Note

The START button is disabled when the buzzer is beeping.

PASS Timing Diagrams

The timing diagrams below show the ACW, DCW, IR, GB and CONT timing for the START status, TEST status and PASS judgment.

ACW PASS Timing

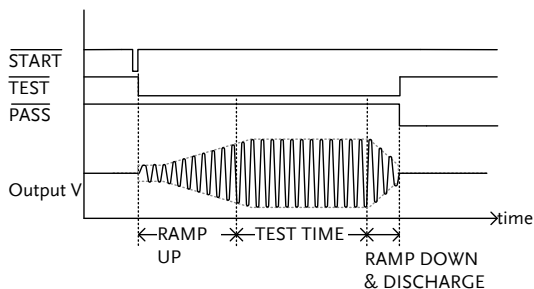

DCW PASS Timing

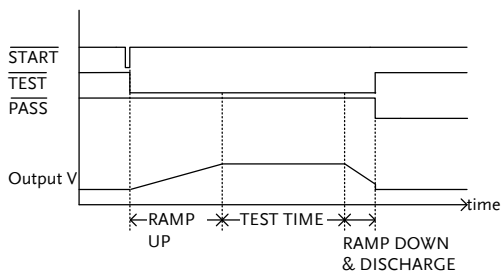

IR PASS Timing

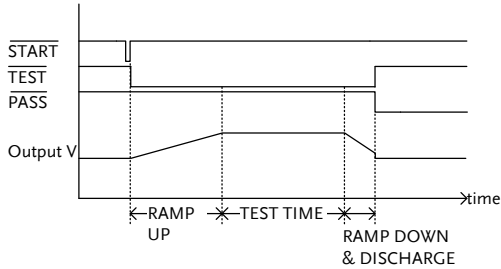

GB PASS Timing

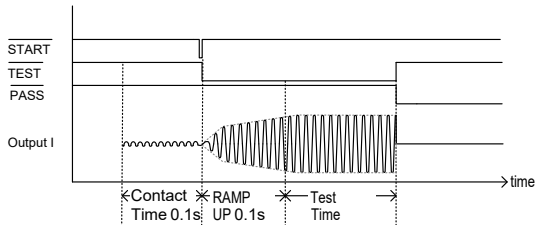

CONT PASS Timing

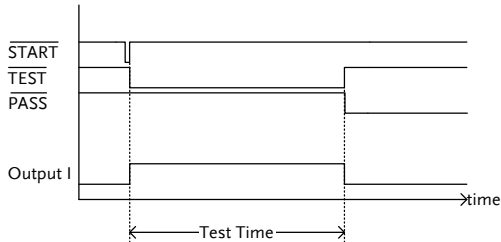

FAIL Judgment

1. When the test is judged as FAIL, FAIL will be displayed on screen, the buzzer will sound and the FAIL indicator will be lit red.

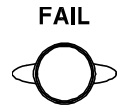

As soon as a test is judged FAIL, power is cut from the terminals.

FAIL Judgment

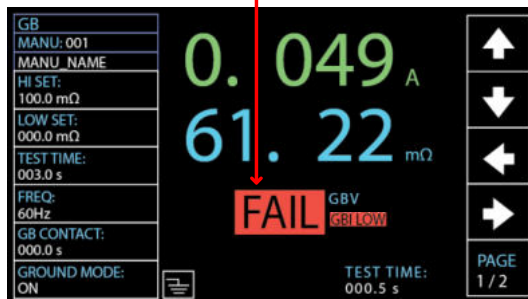

- The FAIL judgment will be held on the display until the STOP button is pressed. Pressing the STOP button will return the tester back to the READY status.

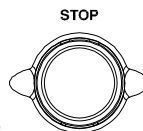

FAIL Timing Diagrams

The timing diagrams below show the ACW, DCW, IR, GB and CONT timing for the START status, TEST status and FAIL judgment.

ACW FAIL Timing

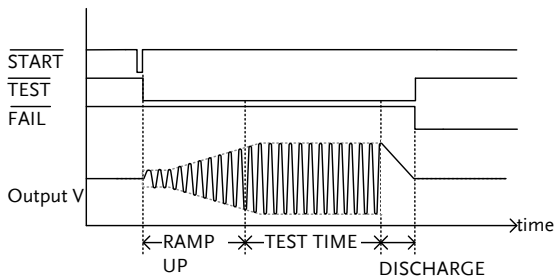

DCW FAIL Timing

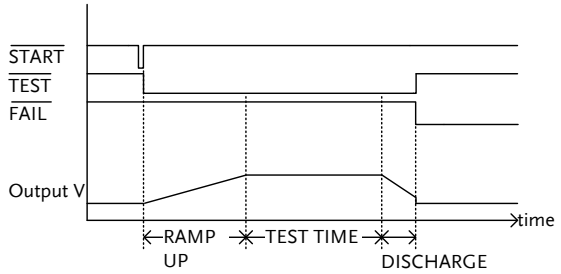

IR FAIL Timing

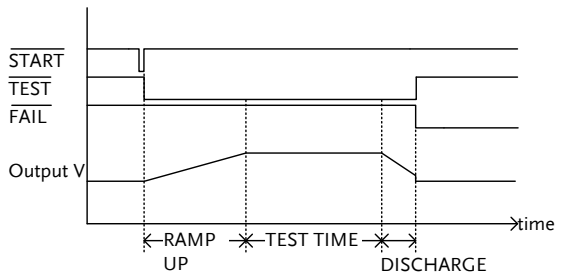

GB FAIL Timing

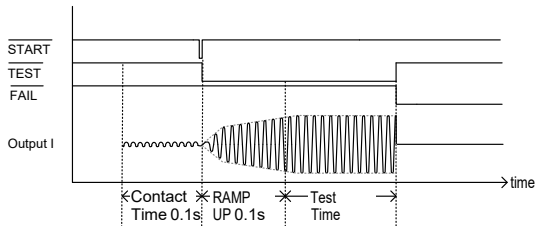

CONT FAIL Timing

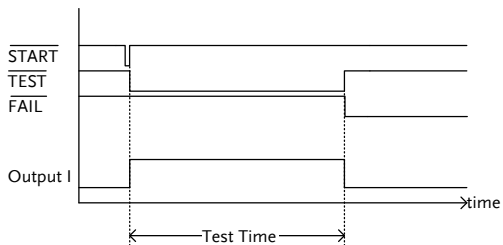

Special MANU Test Mode (000)

Special Test Mode Overview

When MANU number 000 is selected, the special test mode is activated. Under the special test mode, the voltage can be changed during a test in real time (ACW, DCW only). The test function can also be changed when in READY status, unlike under normal operation.

Separate settings can be saved under the special test mode for each of the testing functions: ACW, DCW, IR, GB and CONT. This means different test setups for ACW, DCW, IR, GB and CONT can be saved within the MANU number 000 concurrently.

Steps

1. Choose MANU number 000 to enter the special test mode. Page 41

2. The settings of a previous test can be loaded by pressing the corresponding soft-keys on the front panel.

For example, if you are currently in DCW mode, pressing the ACW key will load the ACW settings that were previously stored in the special manual mode.



3. Set all the necessary parameters for a test and save. Pages 42 ~ 73

Note: A different test setup can be saved for each test function (ACW, DCW, IR, GB and CONT). Below is an example of ACW function in special manual mode.

Special MANU Number 000



- Running the Test
1. In special test mode (000), tests are started and stopped in the same way as for the normal manual test mode. See page 80 for details.

2. If required, the scroll wheel can be used to set the voltage level in real-time as the test is running under either ACW or DCW mode.



ACW	0.050kV ~ 5kV
DCW	0.050kV ~ 6kV

Results

Test judgments are the same as those for the normal manual tests. Please see the PASS/FAIL MANU Test section for details.

Page 93

Sweep Function

Sweep Function Overview

The GPT-10000 Series has access to the sweep mode function, which creates a graph of one of the ACW, DCW, IR, GB or CONT tests in either Manual test or the special MANU mode. The graph will plot the output voltage, current or resistance versus time. After the test has been completed, the test current, voltage or resistance at any point in time can be fetched and viewed in the graph.

Below is an example of the resultant sweep plot of a DCW test where a DC voltage is ramped up to a user-defined level until the HI SET current level has been tripped or the test time runs out.

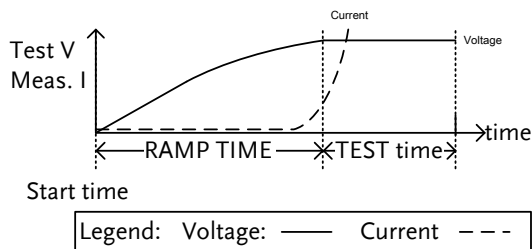

The test items that are plotted on the sweep graph depend on the type of test that is performed.

TEST	Graph Test Items
ACW	Measured voltage, measured current (V, I)
DCW	Measured voltage, measured current (V, I)
IR	Measured voltage, measured resistance (V, R)
GB	Measured current, measured resistance (I, R)
CONT	Measured current, measured resistance (I, R)

Steps of View Sweep Graph

1. When a test has finished, press the corresponding button, e.g., DCW button for DCW test, to view the result of the sweep in an intuitive graph.

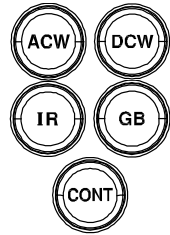

Graph Test Items:		
TEST	GREEN	BLUE
ACW	Measured voltage	Measured current
DCW	Measured voltage	Measured current
IR	Measured voltage	Measured resistance
GB	Measured current	Measured resistance
CONT	Measured current	Measured resistance

DCW Sweep Graph Example

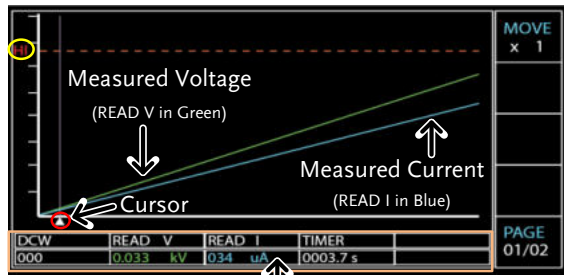

The values of point by cursor

2. Use the scroll wheel to move the cursor on the time axis (red highlight in x-axis). The measured values on the green and blue lines at that particular point in time are shown within the table below (orange highlight). Also, the test function along with the test number is clearly shown within the table. The HI in y-axis (yellow highlight) along with the dotted line in red indicates the HI SET value and the point of tripped time.



Turn Pages

3. The resultant graph will be over 1 page when test time is beyond 650 steps (the interval of each step is 0.1s). In this case, press PAGE soft-key to switch among each page for full graphs.

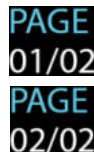

Fast-forward

4. Press the MOVE soft-key before moving the cursor to fast-forward steps by 10 times (x 10), which is practical when steps are many. Press the MOVE soft-key again to return back to the normal "x 1" speed.



Exit the Results Graph

To exit the sweep graph, press the corresponding button again to return back to Manual test.

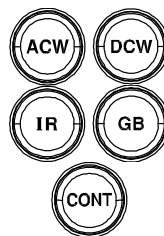

Automatic Tests

This section describes how to create, edit and run automatic tests. Automatic tests allow you to link up to 10 different MANU tests and run them sequentially within a single AUTO test. Each stored MANU test is used as a test step when creating an AUTO test. In addition, up to 5 groups of AUTO test can be interconnected together to present an ever-advanced AUTO tests.

- Choose/Recall an AUTO Test → from page 104
- Creating an AUTO Test File Name → from page 105
- Adding a Step to the AUTO Test → from page 106
- Continuous AUTO Tests → from page 108
- AUTO Test Page Editing → from page 110
- Running an Automatic Test → from page 116
- Automatic Test Results → from page 122

Before operating the GPT-10000 please read the safety precautions as outlined in the Set Up chapter on page 22.

Choose/Recall an AUTO Test

Background The tester must first be put into AUTO mode to create or run automatic tests.

Up to 100 automatic tests can be saved or recalled.

Steps

1. If the tester is in MANU or SYSTEM mode, press the AUTO key on the front panel. This will put the tester into Auto mode.



2. After entering the AUTO mode, first use the scroll wheel to choose the AUTO number.



AUTO # 001~100

AUTO number cursor READY status

AUTO-001		AUTO_NAME				READY
MANU	TEST	V/I	H/I	LOW	STEP	↑
STEP	MODE	SETTING	SETTING	SETTING	HOLD	
						↓
						←
						→

Note

The AUTO number can only be chosen in READY status. If the status is either PASS or FAIL, press the STOP button to restore back to the READY status.

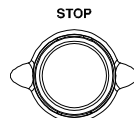

Creating an AUTO Test File Name

Background Each automatic test can have a user-defined test file name (Default: AUTO_NAME) up to 10 characters long. See the character list below for the allowed characters.

Character List

0	1	2	3	4	5	6	7	8	9	_
A	B	C	D	E	F	G	H	I	J	K
L	M	N	O	P	Q	R	S	T	U	V
W	X	Y	Z	a	b	c	d	e	f	g
h	i	j	k	l	m	n	o	p	q	r
s	t	u	v	w	x	y	z			

Steps

1. Use the LEFT/RIGHT arrow soft-keys to move the cursor to the AUTO_NAME (default name) field. The characters table will appear in the right hand accordingly.

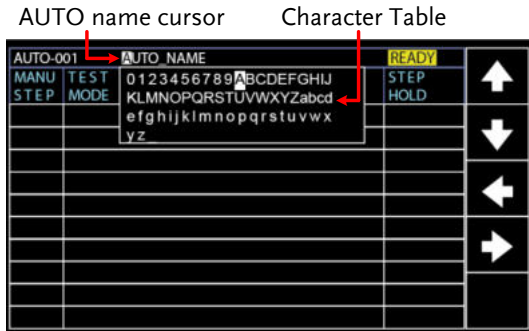

2. Use the scroll wheel to scroll through the available characters.
3. Press the LEFT / RIGHT arrow soft-keys to move the cursor to the next character.



- The AUTO test file name is set when the current AUTO test is saved or when the cursor is moved to another setting.

Adding a Step to the AUTO Test

Background Up to 10 MANU tests (steps) can be added to an automatic (AUTO) test. Each step is added in a sequential order.

- Steps**
- Press the DOWN arrow key to bring the cursor to the MANU STEP number.



MANU STEP number cursor

AUTO-001		AUTO_NAME				READY
MANU STEP	TEST MODE	V/I SETTING	HI SETTING	LOW SETTING	STEP HOLD	
001	DCW	0.100kV	1.000mA	000 uA	P.C/F.C	
						SKIP
						DEL.
						STEP HOLD

- Use the scroll wheel to choose a MANU STEP number to add to the automatic test.



MANU STEP number 001~100, CON

CON It indicates that this group of AUTO test can be connected with the next group. Refer to page 108 for more details.

- Further press the DOWN arrow key followed by using the scroll wheel to choose another MANU STEP number to add to the automatic test.



MANU STEP number cursor (2nd)

AUTO-001		AUTO_NAME			READY
MANU STEP	TEST MODE	V/I SETTING	HI SETTING	LOW SETTING	STEP HOLD
001	DCW	0.100kV	1.000mA	000 uA	P.C/F.C
002	ACW	0.100kV	1.000mA	000 uA	P.C/F.C
					SKIP
					DEL.
					STEP HOLD

- Repeat the previous steps for any other MANU tests that you wish to add to the automatic test.

Continuous AUTO Tests

Background

As mentioned previously, up to 10 MANU steps can be grouped to form an AUTO test and user can designate each step from MANU step number 1 to 100 for an AUTO test. However, it is available to interconnect different AUTO tests together to present a series of AUTO tests.

Steps

1. Follow the steps of “Adding a Step to the AUTO Test” in page 106 first. See the example below where 5 MANU steps have been added into the AUTO-001 group.

AUTO-001		AUTO_NAME				READY	
MANU STEP	TEST MODE	V/I SETTING	HI SETTING	LOW SETTING	STEP HOLD		
001	DCW	0.100kV	1.000mA	000 uA	P.C/F.H		↑
002	ACW	0.100kV	1.000mA	000 uA	P.H/F.C		↓
005	IR	0.050kV	066.8MΩ	000.1MΩ	P.C/F.S		SKIP
010	ACW	0.200kV	2.000mA	000 uA	P.C/F.C		
006	DCW	0.500kV	1.500mA	000 uA	P.H/F.S		
							DEL.
							STEP HOLD

2. Press the DOWN arrow key to bring the cursor to the next MANU STEP field followed by using the scroll wheel to choose CON from the MANU STEP options.



AUTO-001		AUTO_NAME				READY	
MANU STEP	TEST MODE	V/I SETTING	HI SETTING	LOW SETTING	STEP HOLD		
001	DCW	0.100kV	1.000mA	000 uA	P.C/F.H		↑
002	ACW	0.100kV	1.000mA	000 uA	P.H/F.C		↓
005	IR	0.050kV	066.8MΩ	000.1MΩ	P.C/F.S		SKIP
010	ACW	0.200kV	2.000mA	000 uA	P.C/F.C		
006	DCW	0.500kV	1.500mA	000 uA	P.H/F.S		
CON							DEL.
							STEP HOLD

CON is chosen from MENU STEP

- Repeat the step 1 to form another group of AUTO-002 test as the following display shown.

AUTO-002 comprising 3 MANU steps

AUTO-002		AUTO_NAME				READY	↑
MANU STEP	TEST MODE	V/I SETTING	HI SETTING	LOW SETTING	STEP HOLD		
001	DCW	0.100kV	1.000mA	000 uA	P.C/F.H	↓	
002	ACW	0.100kV	1.000mA	000 uA	P.H/F.C		
026	IR	0.150kV	069.8MΩ	000.6MΩ	P.C/F.S		
						SKIP	
						DEL.	
						STEP HOLD	

- After the previous steps, return to the AUTO-001 test page followed by pressing START button for automatic test. The AUTO-002 test will ensue from the end of AUTO-001 test. The continuous AUTO tests are thus established perfectly.

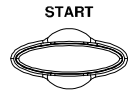

 Note

- Up to 5 groups of AUTO tests can be interconnected. The former 4 groups of AUTO tests, due to CON occupation, owns up to 9 MANU steps, respectively, whereas the last group can own up to 10 MANU steps. Thus, it is 46 MANU steps at the maximum for a continuously interconnected AUTO test.
- The interconnected groups of AUTO test are limited in serial numbers. That is to say, when initializing from AUTO-005, for example, the next group will be definitely AUTO-006 followed by AUTO-007, if available, and so forth up to 5 groups.

AUTO Test Page Editing

Background The AUTO test page contains each added MANU step (up to 10 steps) in order on the list along with the corresponding settings including Test Mode, Test V/I Setting, HI & LOW Settings as well as Step Hold action, respectively. Each step can be skipped, deleted or edited for its Step Hold actions.

Skip a MANU STEP

1. Press the UP / DOWN arrow soft-keys to bring the cursor to the target MANU STEP on list.



Target MANU STEP cursor

AUTO-001		AUTO_NAME				READY
MANU STEP	TEST MODE	V/I SETTING	HI SETTING	LOW SETTING	STEP HOLD	
001	DCW	0.100kV	1.000mA	000 uA	P.C/F.C	↑
002	ACW	0.100kV	1.000mA	000 uA	P.C/F.C	↓
						SKIP
						DEL.
						STEP HOLD

2. Press the SKIP soft-key.
3. The designated MANU STEP will be grayed out in color of setting.



The designated MENU STEP is removed

AUTO-001		AUTO_NAME				READY	↑
MANU STEP	TEST MODE	V/I SETTING	HI SETTING	LOW SETTING	STEP HOLD	↓	
001	DCW	0.100kV	1.000mA	000 uA	P.C/F.C		
							SKIP
							DEL.
							STEP HOLD

Step Hold Editing

1. Press the UP / DOWN arrow soft-keys to bring the cursor to the target MANU STEP on list.



Target MANU STEP cursor

AUTO-001		AUTO_NAME				READY	↑
MANU STEP	TEST MODE	V/I SETTING	HI SETTING	LOW SETTING	STEP HOLD	↓	
001	DCW	0.100kV	1.000mA	000 uA	P.C/F.C		
002	ACW	0.100kV	1.000mA	000 uA	P.C/F.C		
							SKIP
							DEL.
							STEP HOLD

2. Press the STEP HOLD soft-key to bring the cursor to the STEP HOLD setting field.



STEP HOLD cursor

AUTO-001		AUTO_NAME				READY	↑
MANU STEP	TEST MODE	V/I SETTING	HI SETTING	LOW SETTING	STEP HOLD	↓	
001	DCW	0.100kV	1.000mA	000 uA	P.C/F.C		
002	ACW	0.100kV	1.000mA	000 uA	P.C/F.C		
							SKIP
							DEL.
							STEP HOLD

- Use the scroll wheel to choose the options from STEP HOLD setting as listed below.





P.H/F.H Step which is judged PASS will be held until START button pressed by user for next step. Step which is judged FAIL will be held until START button pressed by user for next step.



P.H/F.S Step which is judged PASS will be held until START button pressed by user for next step. The AUTO test will be immediately stopped when Step is judged FAIL.

P.H/F.C Step which is judged PASS will be held until START button pressed by user for next step. The AUTO test will automatically continue although the step is judged FAIL.

P.C/F.H The AUTO test will automatically continue when the step is judged PASS. Step which is judged FAIL will be held until START button pressed by user for next step.

- P.C/F.S The AUTO test will automatically continue when the step is judged PASS. The AUTO test will be immediately stopped when step is judged FAIL.
- P.C/F.C The AUTO test will automatically continue when the step is judged PASS. The AUTO test will automatically continue although the step is judged FAIL.
- 0.1 ~ 999.9 s The step will be held for specified seconds (0.1 ~ 999.9s) until the next step, regardless of PASS or FAIL judgment.
- P.C/F.C  Literally it works identically with the P.C/F.C setting above. However, this setting works on the basis of PREVOLTAGE framework. Refer to the section below on page 115 for details of PREVOLTAGE.
- P.C/F.S  Literally it works identically with the P.C/F.S setting above. However, this setting works on the basis of PREVOLTAGE framework. Refer to the section below on page 115 for details of PREVOLTAGE.

PREVOLTAGE

It indicates that MANU steps set with the options (P.C/F.C , P.C/F.S ) within an AUTO test will be executed in a continuous manner without voltage zeroing. See the conditions below:

1. The PREVOLTAGE of P.C/F.C and P.C/F.S options apply to ACW, DCW and IR test modes only. And only the same mode in continuous MANU steps can constitute the PREVOLTAGE test. For example, the step 1 is IR mode and the step 2 is IR mode as well.
2. When applying INIT VOLTAGE function to several MANU steps within an AUTO test, only the 1st MANU step will be executed.
3. The contact status should be identical among each MANU step. When CONTACT CHK is ON for several MANU steps within an AUTO test, only the 1st MANU step will be executed.
4. The set voltage of following MANU step should be greater than or equal to the previous MANU step. If not, the set voltage of next MANU step will only start after zeroing.
5. The frequency setting should be identical among each MANU step within an AUTO test.
6. When applying RAMP DOWN function to several MANU steps within an AUTO test, only the last MANU step will be executed.
7. When applying CON function to a MANU step within an AUTO test, it is available to interconnect with next AUTO test page for test based on PREVOLTAGE. However, if the 1st MANU step is selected CON in the next AUTO test, the PREVOLTAGE setting will be invalid.
8. If a MANU step is set SKIP within an AUTO test, the following MANU step will not be executed under PREVOLTAGE setting. For example, when MANU step 2 is set SKIP, the AUTO test will start from MANU step 1 under PREVOLTAGE followed by MANU step 3 without PREVOLTAGE setting.

Running an Automatic Test

Background An automatic test can be run when the tester is in READY status.



Note

The tester cannot start to run an AUTO test under the following conditions:

- Any protection modes have been tripped.
- The INTERLOCK function is ON and the Interlock key is not inserted in the signal I/O port (page 180).
- The STOP signal has been received remotely.

If Double Action is ON, ensure the START button is pressed immediately after the STOP button (<0.5s).



Warning

Do not touch any terminals, test leads or the DUT when a test is running.

- Steps**
1. Ensure the tester is in READY status for the AUTO test to come. Page 104

READY status indicator

AUTO-001		AUTO_NAME				READY	↑
MANU	TEST	V/I	HI	LOW	STEP		
STEP	MODE	SETTING	SETTING	SETTING	HOLD		↓
001	DCW	0.100kV	1.000mA	000 uA	P.C/F.H		
002	ACW	0.100kV	1.000mA	000 uA	P.H/F.C		
005	IR	0.050kV	066.8MΩ	000.1MΩ	P.C/F.S		
010	ACW	0.200kV	2.000mA	000 uA	P.C/F.C		
006	DCW	0.500kV	1.500mA	000 uA	P.H/F.S		
							SKIP
							DEL.
							STEP HOLD

2. Press the START button when the tester is in the READY status. The AUTO test starts automatically and the display changes to each MANU TEST in sequence.

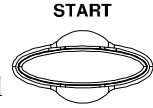

3. Each test will start by showing the ongoing ramp up time followed by the ongoing test time and the ongoing ramp down time. Each test will be tested in sequence until the last test has finished or the test is stopped.



Note

RAMP DOWN time only appears when user has activated it. See page 49 for details.

PASS & FAIL HOLD

1. If P.H (Pass Hold) or F.H (Fail Hold) is set for a MANU STEP, then the tester will “hold” the testing when a PASS or FAIL judgment for that particular MANU STEP occurs. See page 113 for more details.

PASS HOLD Indicator

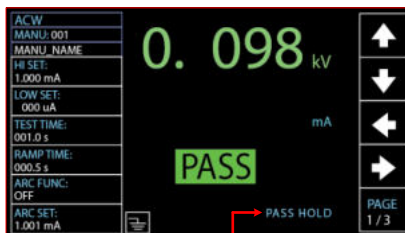

PASS HOLD indicator

FAIL HOLD Indicator

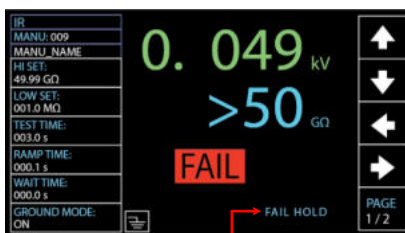

FAIL HOLD indicator

2. The PASS or FAIL indicator on the front panel will also be lit and the buzzer will sound accordingly.



3. To continue to the next MANU STEP after HOLD is displayed on-screen, press the START button.

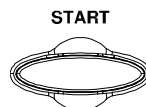

4. To stop the whole AUTO test when HOLD is displayed on-screen, press the STOP button.

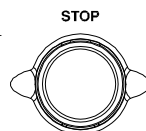



Note

When in HOLD status, only the START and STOP buttons can be pressed, all other keys are disabled.

FAIL STOP

1. If F.S (Fail Stop) is set for a MANU STEP, then the tester will “Stop” the whole AUTO test immediately when a FAIL judgment for that particular MANU STEP occurs. See page 114 for more details.

FAIL STOP Setting

AUTO-001	AUTO_NAME					READY
MANU STEP	TEST MODE	V/I SETTING	I/I SETTING	LOW SETTING	STEP HOLD	
001	DCW	0.100kV	1.000mA	000 uA	P.C/F.C	↑
002	ACW	0.100kV	1.000mA	000 uA	P.C/F.C	↓
026	IR	0.150kV	069.8MΩ	000.6MΩ	P.C/F.S	SKIP
001	DCW	0.100kV	1.000mA	000 uA	P.C/F.C	DEL.
002	ACW	0.100kV	1.000mA	000 uA	P.C/F.C	STEP HOLD

FAIL STOP setting

FAIL HOLD Result Indicator

AUTO test stops in FAIL status

AUTO-001	AUTO_NAME					FAIL
MANU STEP	TEST MODE	READ DATA1	READ DATA2	TEST TIME	TEST RESULT	
001	DCW	0.099kV	000 uA	T000.3s	PASS	
002	ACW	0.099kV	000 uA	T000.3s	PASS	
026	IR	0.049kV	60.00GΩ	T000.3s	FAIL	
001	DCW	0.000kV	000 uA	I000.0s		
002	ACW	0.100kV	000 uA	I000.0s		

FAIL STOP indicator on exact MANU STEP

2. The FAIL indicator on the front panel will also be lit and the buzzer will sound accordingly.



3. When FAIL is displayed on-screen, press the STOP button twice to return to the READY status.

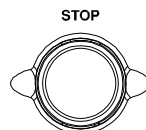

Return to
READY
status

Restore to READY status

AUTO_001		AUTO_NAME				READY	
MANU	TEST	V/I	HI	LOW	STEP	↑	
STEP	MODE	SETTING	SETTING	SETTING	HOLD		
001	DCW	0.100kV	1.000mA	000 uA	P.C/F.C	↓	
002	ACW	0.100kV	1.000mA	000 uA	P.C/F.C		
026	IR	0.150kV	069.8MΩ	000.6MΩ	P.C/F.S	SKIP	
001	DCW	0.100kV	1.000mA	000 uA	P.C/F.C		
002	ACW	0.100kV	1.000mA	000 uA	P.C/F.C	DEL.	
						STEP HOLD	



Note

When in FAIL status, only the STOP button can be pressed, all other keys are disabled.

Stop a
Running Test

- To stop the AUTO test at any time when it is running, press the STOP button. The AUTO test will stop immediately. When the STOP button is pressed, a judgment is not made on the current test and any remaining tests are aborted.

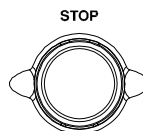

All panel keys except the STOP and START buttons are disabled when the tester has been stopped. All the results up until when the AUTO test was stopped are shown on-screen. See page 122 for more details on automatic test results.

Below is example of an automatic test that has been stopped in the midway. The remaining MANU STEPs are aborted without test results.

Automatic Test Results

Background

If all the test steps are allowed to run to completion (the AUTO test is not stopped or a protection setting is not tripped) then the tester will judge each step as either PASS or FAIL. This is shown as a table after the automatic test has finished running. If the test has been stopped, then any remaining tests will not be run and thus the AUTO test will not finish running.

Overview

AUTO TEST result indicator

AUTO-001		AUTO_NAME					STOP
MANU STEP	TEST MODE	READ DATA1	READ DATA2	TEST TIME	TEST RESULT		
001	DCW	0.099kV	000 uA	T000.3s	PASS		
002	ACW	0.099kV	000 uA	T000.3s	PASS		
001	DCW	0.000kV	000 uA	T000.0s	SKIP		
001	DCW	0.099kV	000 uA	T000.3s	PASS		
002	ACW	0.099kV	000 uA	T000.3s	PASS		
026	IR	0.049kV	60.00GΩ	T000.3s	FAIL		
001	DCW	0.097kV	000 uA	T000.1s	STOP		
002	ACW	0.000kV	000 uA	T000.3s			
						PAGE 1 / 1	

MANU STEP results indicators



Note

The PASS/FAIL/STOP result shown on the top-right corner for an AUTO TEST as a whole depends on the results of all the steps (MANU STEPs) that compose an AUTO TEST:

If Interlock function is enabled but without interlock inserted into Signal I/O port, the Interlock Open message will be shown on top-right corner and AUTO test will be unable to start. Refer to page 152 for details.

STOP Result

Once a MANU STEP is stopped, the AUTO TEST will be presented STOP in its result. In other words, if a MANU STEP is stopped, the entire AUTO TEST is in STOP result, neither PASS nor FAIL judgment. And the remaining MANU STEP(s) will be ignored with blank in test result field.

AUTO TEST STOP result

MANU STEP	TEST MODE	READ DATA1	READ DATA2	TEST TIME	TEST RESULT
001	DCW	0.099kV	000	uA T000.3s	PASS
002	ACW	0.099kV	000	uA T000.3s	PASS
001	DCW	0.000kV	000	uA T000.0s	SKIP
001	DCW	0.099kV	000	uA T000.3s	PASS
002	ACW	0.099kV	000	uA T000.3s	PASS
026	IR	0.049kV	60.00GΩ	T000.3s	FAIL
001	DCW	0.097kV	000	uA T000.1s	STOP
002	ACW	0.000kV	000	uA T000.3s	

PAGE
1 / 1

One of the MANU STEPS was stopped

System Settings



The System settings are system-wide settings that apply to both MANU tests and AUTO tests.

The System menu includes the following settings:

- Display Set settings → from page 129.
- Buzzer Settings → from page 131.
- Interface Settings → from page 133.
- Control settings → from page 139.
- Time Setting settings → from page 153.
- Data Initialize settings → from page 158.
- Information section → from page 161.
- Statistics settings → from page 162.
- USB Disk settings → from page 164.
- Contact Check settings → from page 172.

Display Set Setting

Description The Display Set page includes both brightness level and language settings.

- Steps**
1. Press the SYSTEM button on the front panel when the tester is under READY status in either MANU or AUTO test. 
 2. The SYSTEM page will be shown where DISPLAY SET is on top of the left-side list. Press the ENTER soft-key to enter the setting page. 



3. Use the scroll wheel to set the Brightness level. 



LCD Brightness 1 bar (low) ~ 10 bars (high)

4. Press the UP/DOWN arrow soft-keys to move the cursor to the Language setting followed by using the scroll wheel to set the options of Language setting.



Language options English
 繁體中文 (Traditional Chinese)
 简体中文 (Simplified Chinese)

5. Press the EXIT soft-key to exit from the DISPLAY SET page.



Note

- The changes in DISPLAY SET are saved instantly.
- The AUTO or MANUAL button can be pressed at any time to jump to its belonging page, individually. Alternatively, it is available to promptly return back to the previous page with settings, whether it's AUTO or MANUAL mode, by simply pressing SYSTEM button.

Buzzer Settings

Description The Buzzer settings allow you to set the volume of buzzer sound for PASS/FAIL judgments. Also, it is available to set Key Sound for buttons being pressed.

Steps 1. Press the SYSTEM button on the front panel when the tester is under READY status in either MANU or AUTO test.



2. The SYSTEM page will be shown. Press the UP/DOWN arrow soft-keys to move the cursor to the BUZZER setting.

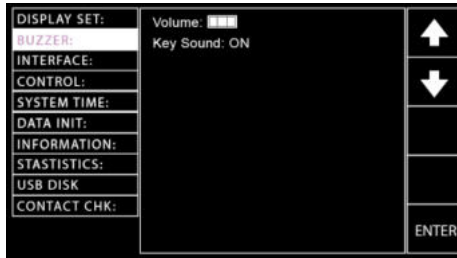
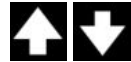

3. Press the ENTER soft-key to enter the Volume setting followed by using the scroll wheel to set the Volume level.





Buzzer Volume 1 bar (low) ~ 3 bars (high)

4. Press the UP/DOWN arrow soft-keys to move the cursor to the Key Sound setting followed by using the scroll wheel to set the Key Sound setting.

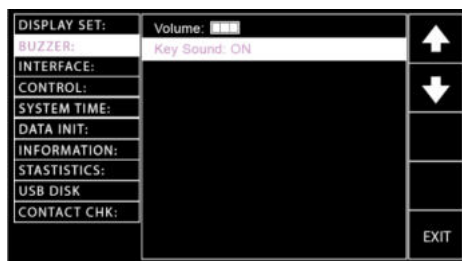
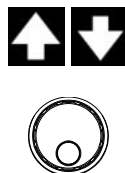

Key Sound ON, OFF

5. Press the EXIT soft-key to exit from the BUZZER page.



 Note

When in the AUTO test, the Buzzer sound only applies to the overall judgment of an AUTO test. There will no Buzzer sound for judgment of each test step within a group of an AUTO test.

 Note

The changes in BUZZER setting are saved instantly.

Interface Settings

Description The interface settings allows user to choose the remote interface configuration. USB, RS232, LAN (optional) and GPIB (optional) can be selected.

Steps

1. Press the SYSTEM button on the front panel when the tester is under READY status in either MANU or AUTO test.



2. The SYSTEM page will be shown. Press the UP/DOWN arrow soft-keys to move the cursor to the INTERFACE setting.

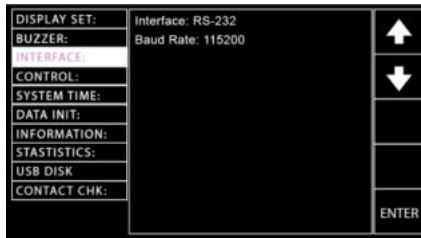

3. Press the ENTER soft-key to enter the Interface setting followed by using the scroll wheel to select the Interface options.

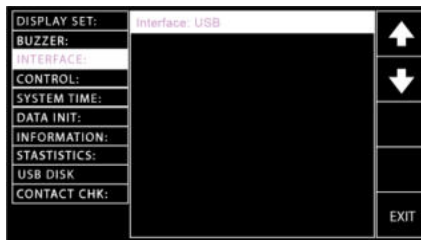

Interface Options

RS-232, USB, GPIB, LAN

- When RS-232 is selected, press the UP/DOWN arrow soft-keys to move the cursor to the Baud Rate setting followed by using the scroll wheel to set the Baud Rate setting.

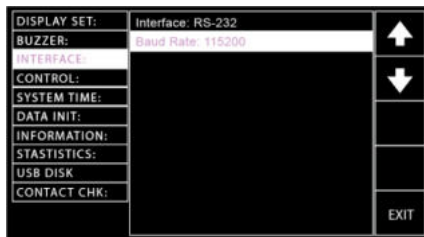
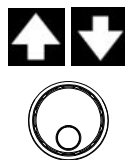

Baud Rate Setting 9600, 19200, 38400,
for RS-232 57600, 115200,

- When GPIB is selected, press the UP/DOWN arrow soft-keys to move the cursor to the Address setting followed by using the scroll wheel to set the Address setting.

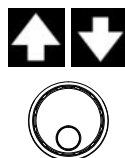

Address Setting for GPIB 00~31

- When LAN is selected, press the UP/DOWN arrow soft-keys to move the cursor to the DHCP setting, which assigns IP address related settings automatically, followed by using the scroll wheel to turn on or off the setting.

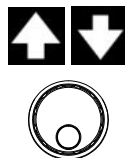

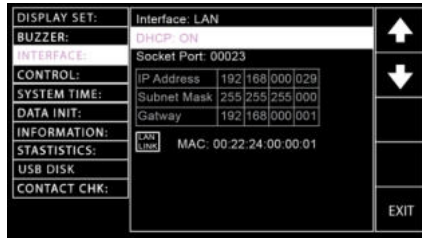

DHCP Setting for LAN ON, OFF



Note

It is required to update firmware up to version 1.06 above prior to LAN interface activation for GPT-12000 series specifically.

Press the UP/DOWN arrow soft-keys to move the cursor to the Socket Port setting followed by using the scroll wheel to designate a target port value.

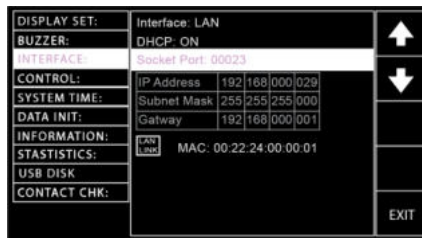

Socket Port Setting for LAN 00000 - 65000

When OFF is selected for DHCP setting, press the UP/DOWN arrow soft-keys to move the cursor to the IP Address, Subnet Mask and Gateway settings individually followed by using the scroll wheel and right, left arrow soft-keys to manually define each setting.



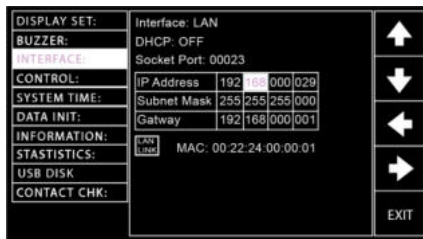

- IP Address Setting 0-255, 0-255, 0-255, 0-255
- Subnet Mask Setting 0-255, 0-255, 0-255, 0-255
- Gateway Setting 0-255, 0-255, 0-255, 0-255

Press the UP/DOWN arrow soft-keys to move the cursor back to the Interface setting followed by pressing the SET soft-key to confirm setting.

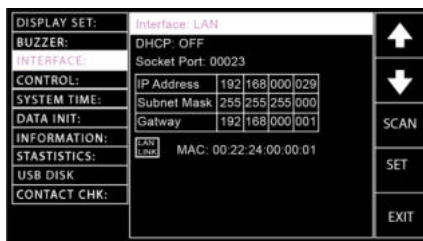
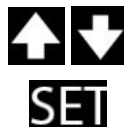

When pressing the SACN soft-key, the unit will scan the LAN card setting thoroughly. In fact, the unit automatically scans at once every time when Interface is changed to LAN setting.



If LAN card with network setting is scanned properly, the “LAN LINK” icon appears. If not, however, the icon doesn’t appear.



When LAN setting is scanned properly and Interface is set as LAN, the “LAN LINK” icon shows as the following figures.

LAN LINK icon in MANU



LAN LINK icon

LAN LINK icon in AUTO

LAN LINK icon

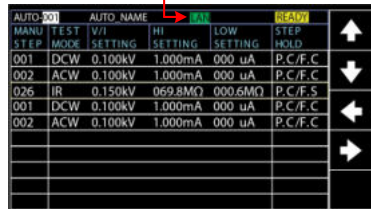

When LAN setting is Not scanned properly and Interface is set as LAN, the “LAN OPEN” icon shows as the following figures.

LAN
OPEN
icon in
MANU

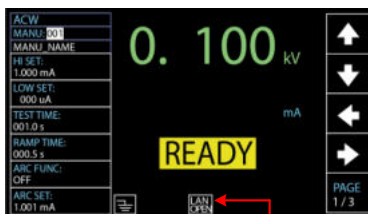

LAN OPEN icon

LAN
OPEN
icon in
AUTO

LAN OPEN icon

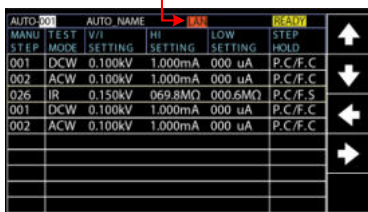

- Press the EXIT soft-key to exit from the INTERFACE page.



Note

Ensure the baud rate settings or GPIB address matches the host machine.



Note

The changes in INTERFACE setting are saved instantly.

Control Settings

Description	<p>The Control settings include 7 options: Control By, Double Action, Key Lock, Interlock, Start Click For 1 Second, Power GND Check and Barcode Function Setting.</p> <ul style="list-style-type: none">• Control By is used to determine how a test is started. Tests can be started via the front panel (START/STOP buttons), from a remote controller or via the SIGNAL I/O port.• The Double Action function is a safety feature used to prevent accidentally starting a test. Normally to start a test, the START button is pressed when the tester is in the READY status. To start a test when Double Action is ON, the STOP button must first be pressed, followed by the START button within 500ms.• Key Lock disables the front panel keys from changing the test number, mode or testing parameters. Only the START & STOP buttons required for testing are not disabled. Also, the SYSTEM button remains functional for user to return back to the system setting.• The Interlock function is a safety feature. The interlock function prevents a test from running, unless the interlock pins on the signal I/O port connector are shorted. The included interlock key can be used for this purpose. See page 181 for details.• The Start Click For 1 Second indicates another safety feature that requires the START button being pressed for 1 second so that a test, whether MANU or AUTO, can be started.
-------------	---

- The Power GND Check detects if the ground terminal from power cord of instrument connects to earth ground properly.
- Barcode Function Setting is a feature which facilitates fast yet convenient MANU and AUTO tests for, in particular, assembly line application. It enables GPT-10000 series, with additional barcode scanner plugged in, to scan barcodes and edit into a list for prompt utilization in diversified tests.

Steps

1. Press the SYSTEM button on the front panel when the tester is under READY status in either MANU or AUTO test.

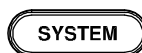

2. The SYSTEM page will be shown. Press the UP/DOWN arrow soft-keys to move the cursor to the CONTROL setting.

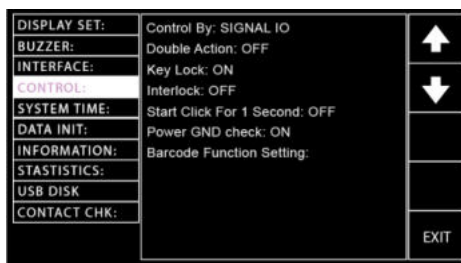
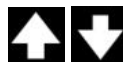

3. Press the ENTER soft-key to enter the Control By setting followed by using the scroll wheel to select the following options.



SIGNAL IO Output PINs (green zone)

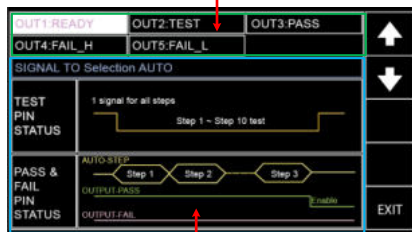

SIGNAL IO Selection for AUTO Test (blue zone)

Press the UP/DOWN arrow soft-keys to move the cursor to target PINs (1~5) followed by using the scroll wheel to select the following 6 options for each pin.

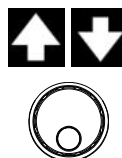

PINs READY, TEST, PASS, FAIL,
Settings FAIL_H, FAIL_L

Further press the UP/DOWN arrow soft-keys to move the cursor to the TEST PIN STATUS followed by using the scroll wheel to select the following 2 options for TEST PIN under AUTO test mode.

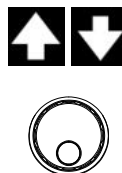

1 signal for all steps It means one signal output of TEST
for all PIN will be delivered to all steps all
steps the way till the end of an AUTO test.

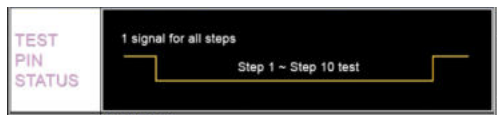

1 signal for each step
for each step

It means one signal output of TEST PIN will be delivered to each step with continuous counters within each interval between each step, which is particularly practical for certain applications.



Further press the UP/DOWN arrow soft-keys to move the cursor to the PASS & FAIL PIN STATUS followed by using the scroll wheel to select the following 2 options for PASS & FAIL PINs under AUTO test mode.

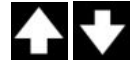

Pass & Fail judgment in final step

Regardless of judgments of each step in an AUTO test, a PASS or FAIL will be given after the whole steps are completed. However, an AUTO test will be stopped in the mid way when F.S is activated. Refer to page 113 for details.

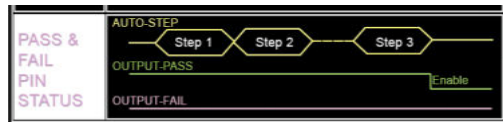

Pass & Fail judgment for each step

Pass or Fail judgment will be given for each step within an AUTO test. By doing so, the judgments of each step can be concretely recognized, individually for user.

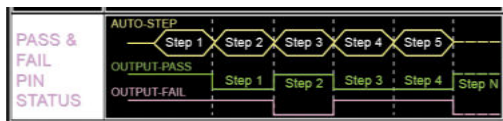

Press the UP/DOWN arrow soft-keys to move the cursor to the Double Action setting followed by using the scroll wheel to set the Double Action setting.

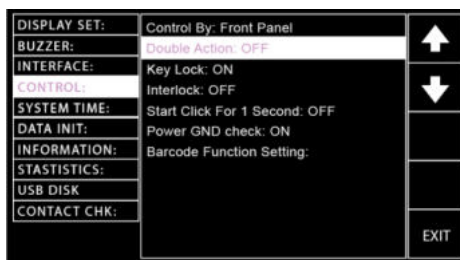

Double Action settings ON, OFF

Press the UP/DOWN arrow soft-keys to move the cursor to the Key Lock setting followed by using the scroll wheel to set the Key Lock setting.

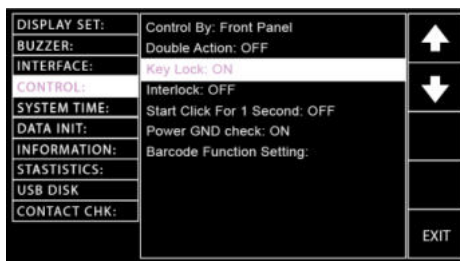

Key Lock settings ON, OFF

4. Press the UP/DOWN arrow soft-keys to move the cursor to the Interlock setting followed by using the scroll wheel to set the Interlock setting.

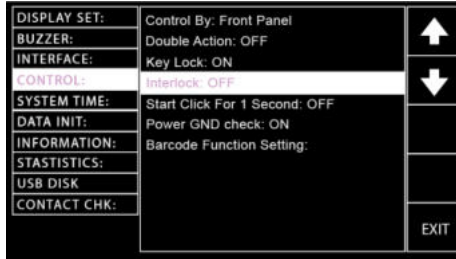

Interlock settings ON, OFF

5. Press the UP/DOWN arrow soft-keys to move the cursor to the Start Click For 1 Second setting followed by using the scroll wheel to set the Start Click For 1 Second setting.

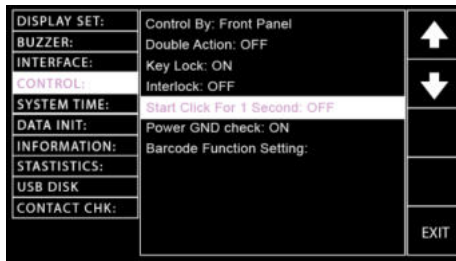
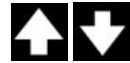

Start Click For 1 Second settings ON, OFF

6. Press the UP/DOWN arrow soft-keys to move the cursor to the Power GND Check setting followed by using the scroll wheel to set the Power GND Check setting.



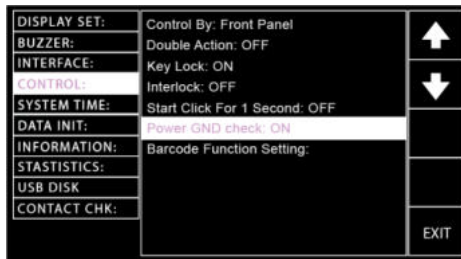

Power GND Check settings ON, OFF

When Power GND Check setting is ON but the instrument doesn't connect to earth ground, the prompt message will appear in either MANU or AUTO mode as the figures below shown.

MANU
MODE



POWER GND FAIL Message

AUTO
MODE

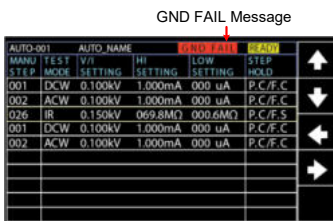

GND FAIL Message

- Press the UP/DOWN arrow soft-keys to move the cursor to the Barcode Function Setting followed by pressing the SET soft-key to enter the specific setting page.



Use the LEFT/RIGHT arrow soft-keys to move the cursor to the TEST NUM followed by using the scroll wheel to determine the number of selected test mode. Refer to page 41 & 104 for test number creation.

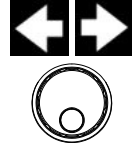

TEST NUM 001 - 100

Further use the LEFT/RIGHT arrow soft-keys to move the cursor to the AUTO TEST followed by using the scroll wheel to turn on or off the auto test function, which indicates the test will start automatically when the matched barcode is scanned later.

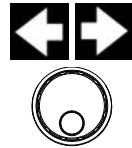

AUTO TEST ON, OFF

The MANU/AUTO NAME column automatically reflects file name corresponding to the existed file name from the selected test number in either mode. Refer to page 42 & 105 for test name creation.

Example of a scanned barcode with complete settings

The scanned barcode is set with AUTO-001 with AUTO TEST ON

PAGE-001		DATA			
BARCODE	TEST MODE	TEST NUM	AUTO TEST	MANU/AUTO NAME	
4710123134556	AUTO	001	ON	AUTO_NAME	↑
					↓
					←
					→
					EXIT

Repeat the above steps to scan more barcodes and edit the ensuing settings if necessary.

Example of multiple scanned barcodes with complete settings

3 scanned barcodes with varied settings in PAGE-001 table

PAGE-001					EDIT
BARCODE	TEST MODE	TEST NUM	AUTO TEST	MANU/AUTO NAME	↑
4710123134556	AUTO	001	ON	AUTO NAME	↓
GPT-9801	MANU	022	OFF	MANU NAME	←
ABC-abc-1234	AUTO	006	ON	AUTO NAME	→
					EXIT

Delete scanned barcode from list

If you want to delete a scanned barcode, use the UP/DOWN arrow soft-keys to move the cursor to the row of target barcode followed by using the LEFT arrow soft-key to move the cursor to the BARCODE column where the target barcode is highlighted. Press the DEL. soft-key to remove it from the table.

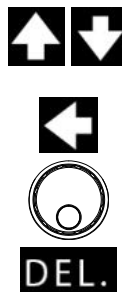

The selected barcode to be removed

PAGE-001					EDIT
BARCODE	TEST MODE	TEST NUM	AUTO TEST	MANU/AUTO NAME	↑
4710123134556	AUTO	001	ON	AUTO NAME	↓
GPT-9801	MANU	022	OFF	MANU NAME	←
ABC-abc-1234	AUTO	006	ON	AUTO NAME	→
					DEL
					EXIT

Delete soft-key

Barcode repeat

When an existed barcode is scanned again, a warning message, "Barcode Repeat" will be shown on the top-right corner with buzzer beep.

Press the EXIT soft-key to exit from the CONTROL page.



Note

The changes in CONTROL setting are saved instantly.



Note

The Double Action setting is ignored when the GPT-10000 is being controlled remotely via the USB, RS232 or GPIB interface.



Note

A beeper sounds twice when an unregistered barcode is scanned. Confirm if target barcode has been registered before barcode test operation.



Note

If a test is started with INTERLOCK ON, but the interlock signal I/O pins are not shorted (either with the included interlock key or manually), the Interlock Open message will be displayed, whether in MANU or AUTO test, to prevent the test from starting for safety reason.

MANU Test

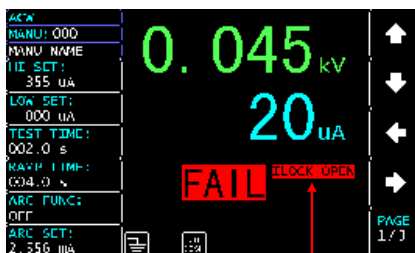

Interlock Open Message

AUTO Test

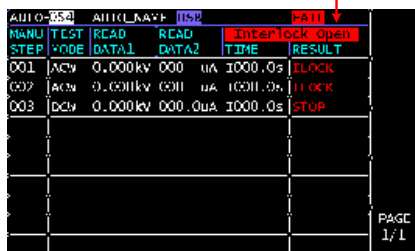

Interlock Open Message

Time Setting

Description The date and time for tester system can be edited under this section. The button cell battery used for system date & time has the lifecycle of approximate 2 years in general. Hence, it is suggested to replace with new battery of the type of CR-2032 every 2 years.

Also, this section provides alert relevant setting, which is specific for calibration.

Steps

1. Press the SYSTEM button on the front panel when the tester is under READY status in either MANU or AUTO test.



2. The SYSTEM page will be shown. Press the UP/DOWN arrow soft-keys to move the cursor to the SYSTEM TIME SETTING.

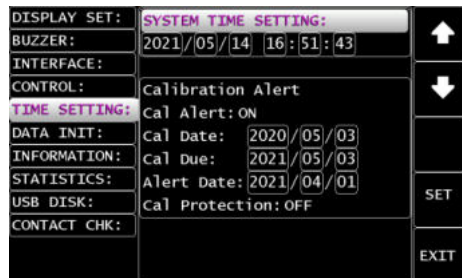

3. Press the ENTER soft-key to enter the Year setting followed by using the scroll wheel to select the Year setting for system. Also, repeat the actions for the rest month, date, hour, minute and second settings.



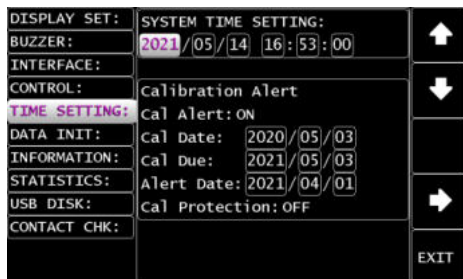

Year setting 2000 ~ 2099
 Month setting 01 ~ 12
 Date setting 01 ~ 31
 Hours setting 00 ~ 23
 Minutes setting 00 ~ 59
 Seconds setting 00 ~ 59

4. Press the UP/DOWN arrow soft-keys to move the cursor to the Cal Alert setting followed by using the scroll wheel to turn On or Off the Cal Alert setting, which indicates if the warning message function for due calibration date is turned or off.

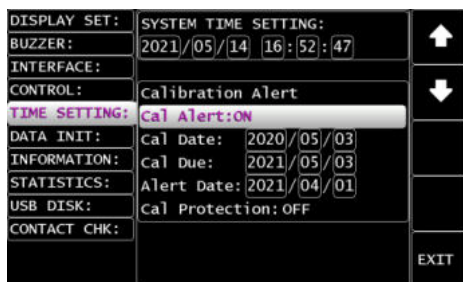

Cal Alert

ON, OFF

When Cal Alert is turned on and the system time is beyond either Cal Date or Cal Due setting, the display will be shown as follows.

MANU Display



AUTO Display

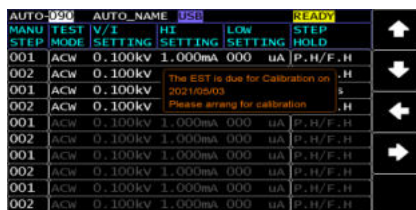

5. Press the UP/DOWN arrow soft-keys to move the cursor to the Cal Date setting followed by using the scroll wheel to set the Cal Date setting, which indicates the date for calibration.

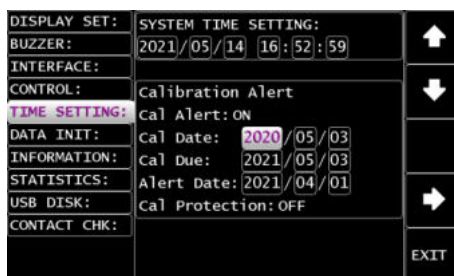

Cal Date 2000 ~ 2099
 01 ~ 12
 01 ~ 31

- Press the UP/DOWN arrow soft-keys to move the cursor to the Cal Due setting followed by using the scroll wheel to set the Cal Due setting, which indicates next due date for calibration.



DISPLAY SET:	SYSTEM TIME SETTING:	
BUZZER:	2021/05/14 16:53:05	↑
INTERFACE:		
CONTROL:	Calibration Alert	↓
TIME SETTING:	Cal Alert: ON	
DATA INIT:	Cal Date: 2020/05/03	
INFORMATION:	Cal Due: 2021/05/03	
STATISTICS:	Alert Date: 2021/04/01	→
USB DISK:	Cal Protection: OFF	
CONTACT CHK:		EXIT

Cal Due 2000 ~ 2099
 01 ~ 12
 01 ~ 31

- Press the UP/DOWN arrow soft-keys to move the cursor to the Alert Date setting followed by using the scroll wheel to set the Alert Date setting, which indicates the pre-alert function for due date of calibration.



DISPLAY SET:	SYSTEM TIME SETTING:	
BUZZER:	2021/05/14 16:53:11	↑
INTERFACE:		
CONTROL:	Calibration Alert	↓
TIME SETTING:	Cal Alert: ON	
DATA INIT:	Cal Date: 2020/05/03	
INFORMATION:	Cal Due: 2021/05/03	
STATISTICS:	Alert Date: 2021/04/01	→
USB DISK:	Cal Protection: OFF	
CONTACT CHK:		EXIT

Alert Date 2000 ~ 2099
 01 ~ 12
 01 ~ 31

8. Press the UP/DOWN arrow soft-keys to move the cursor to the Cal Protection setting followed by using the scroll wheel to set the Cal Protection setting, which indicates if the output protection setting is turned on of off when due date of calibration expires.

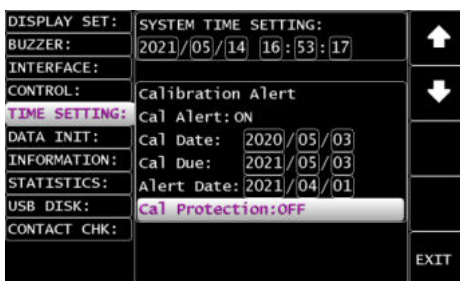

Cal Protection ON, OFF

When Cal Protection is turned on and the system time is beyond either Cal Due or Alert Date setting, the display will be shown as follows in which calibration output protection is effectively activated.

MANU
Display



9. Press the EXIT soft-key to exit from the SYSTEM TIME page.

EXIT





Note



The changes in Time Setting setting are saved instantly.

Data Initialize Settings

Description The settings of AUTO test, MANU test and SYSTEM saved by user can be initialized within this section.

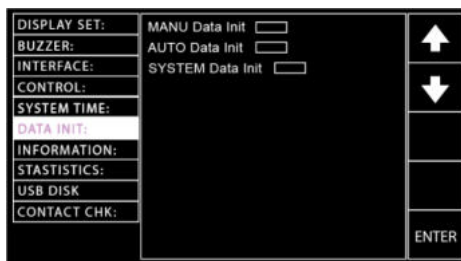
- Steps**
1. Press the SYSTEM button on the front panel when the tester is under READY status in either MANU or AUTO test. 
 2. The SYSTEM page will be shown. Press the UP/DOWN arrow soft-keys to move the cursor to the DATA INIT setting. 



3. Press the ENTER soft-key to enter the Manu Data Init setting followed by pressing the right arrow soft-key for consecutive 3 times to initialize the Manu Data settings.  

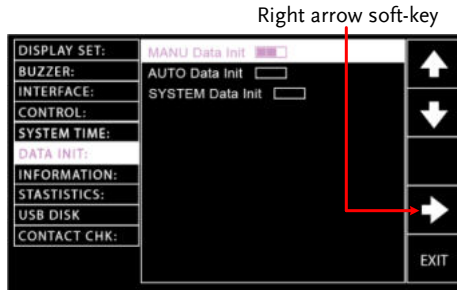

The status bar of Manu Data Init consists of 3 bars, which indicate the initializing action will not be implemented until 3 bars are fully achieved. After the initializing, the “OK” message appears.

4. Press the UP/DOWN arrow soft-keys to move the cursor to the Auto Data Init setting followed by pressing the right arrow soft-key for consecutive 3 times to initialize the Auto Data settings.

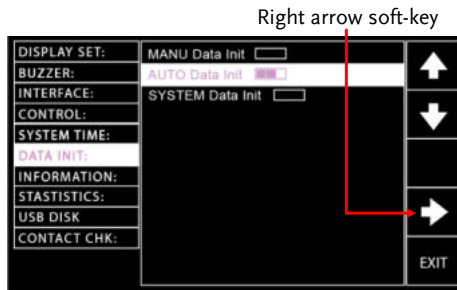
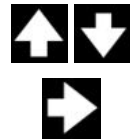

The status bar of Auto Data Init consists of 3 bars, which indicate the initializing action will not be implemented until 3 bars are fully achieved. After the initializing, the “OK” message appears.

5. Press the UP/DOWN arrow soft-keys to move the cursor to the System Data Init setting followed by pressing the right arrow soft-key for consecutive 3 times to initialize the System Data settings.

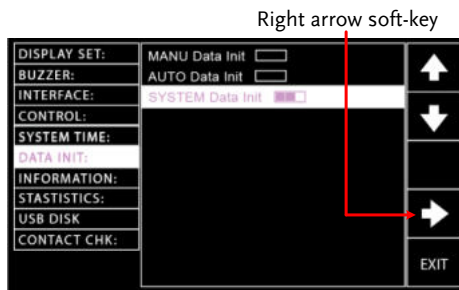
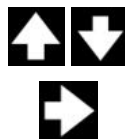

6. Press the EXIT soft-key to exit from the DATA INIT page.



Note

The status bar of System Data Init consists of 3 bars, which indicate the initializing action will not be implemented until 3 bars are fully achieved. After the initializing, the “OK” message appears.

Information Section

Description The Information section here discloses some basic information including model name, firmware version and the available functions.

Steps

1. Press the SYSTEM button on the front panel when the tester is under READY status in either MANU or AUTO test.

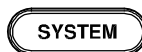

2. The SYSTEM page will be shown. Press the UP/DOWN arrow soft-keys to move the cursor to the INFORMATION section.

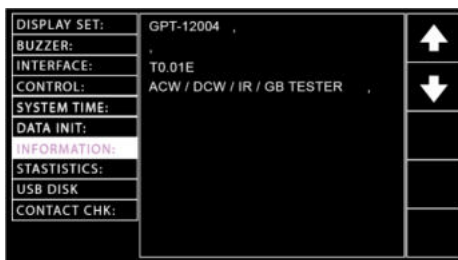

3. The basic information of the tester will be clearly exposed on the screen.

Statistics Settings

Description This section allows user to have a comprehensive overview of not only total test counts including PASS and FAIL amounts, individually, but also the respective counts of each test mode. More than that, user is able to view those data from an intuitive histogram.

Steps

1. Press the SYSTEM button on the front panel when the tester is under READY status in either MANU or AUTO test.



2. The SYSTEM page will be shown. Press the UP/DOWN arrow soft-keys to move the cursor to the STATISTICS setting where PASS and FAIL amounts and TOTAL amounts to date are shown in the green highlight below. Also, the detailed distributions of PASS and FAIL amounts from each test functions are well disclosed for viewing in the blue highlight below.



PASS, FAIL amounts & TOTAL amounts

DISPLAY SET:	TOTAL AMOUNT = 00032		↑	
BUZZER:	PASS AMOUNT = 00023			
INTERFACE:	FAIL AMOUNT = 00009			
CONTROL:	FUNCTION	PASS	FAIL	↓
SYSTEM TIME:	ACW	00003	00002	
DATA INIT:	DCW	00003	00002	
INFORMATION:	IR	00002	00003	
STATISTICS:	GB	00003	00002	
USB DISK	CONT	00012	00000	
CONTACT CHK:				
				ENTER

PASS & FAIL amounts distributions in each test function

3. Press the ENTER soft-key to enter the statistics table. It is available to press the DATA INIT soft-key to initialize the accumulated statistics.



DISPLAY SET:	TOTAL AMOUNT = 00032			↑
BUZZER:	PASS AMOUNT = 00023			
INTERFACE:	FAIL AMOUNT = 00009			
CONTROL:	FUNCTION	PASS	FAIL	↓
SYSTEM TIME:	ACW	00003	00002	
DATA INIT:	DCW	00003	00002	DATA INIT
INFORMATION:	IR	00002	00003	
STATISTICS:	GB	00003	00002	EXIT
USB DISK:	CONT	00012	00000	
CONTACT CHK:				

DATA INIT soft-key



Note

After pressing the DATA INIT soft-key, all the statistics shown on this page will be initialized to 0 and the future tests will be re-accumulated from zero.

4. Press the UP/DOWN arrow soft-keys to move the cursor to the table below. Place the cursor in target test function followed by pressing ANALY soft-key to enter the specific analysis page.



ANALY soft-key

DISPLAY SET:	TOTAL AMOUNT = 00032			↑
BUZZER:	PASS AMOUNT = 00023			
INTERFACE:	FAIL AMOUNT = 00009			
CONTROL:	FUNCTION	PASS	FAIL	↓
SYSTEM TIME:	ACW	00003	00002	
DATA INIT:	DCW	00003	00002	ANALY
INFORMATION:	IR	00002	00003	
STATISTICS:	GB	00003	00002	EXIT
USB DISK:	CONT	00012	00000	
CONTACT CHK:				

Selected target test function

- The distributions of PASS and FAIL statistics are well illustrated in the histogram with table display in which the upper side reads the individual PASS and FAIL amounts for test function. The mid and lower side depicts FAIL amounts in the far-right red strip with number below, whilst the PASS amounts are described in strips of different colors with numbers below indicating the percentage of varied measured values in relation to the set HI & LOW range.

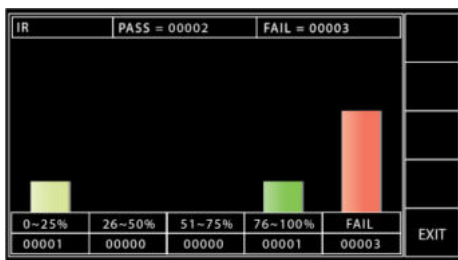

- Press the EXIT soft-key to exit from the STATISTICS page.



USB Disk Settings

Description

The measurements data can be stored in the connected USB disk. In this section user can determine a user-defined name for data to be saved into the inserted USB disk. It is noted that only USB1.1 or 2.0, FAT16 or FAT32, capacity <= 32GB can support this function. Refer to page 15 for details on USB port in the front panel.

Steps

- Press the SYSTEM button on the front panel when the tester is under READY status in either MANU or AUTO test.

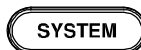

- The SYSTEM page will be shown. Press the UP/DOWN arrow soft-keys to move the cursor to the USB DISK setting.

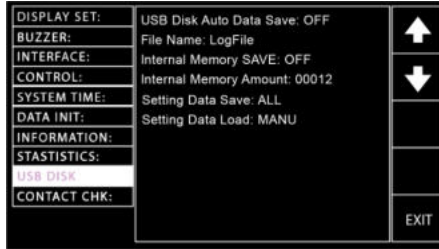
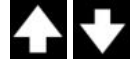

- Press the ENTER soft-key to enter the USB Disk Auto Data Save setting followed by using the scroll wheel to turn on or off the setting, which automatically saves the test data into the inserted USB disk when enabled.



USB Disk Auto Data Save setting ON, OFF

- Press the UP/DOWN arrow soft-keys to move the cursor to the File Name filed, which sets file name for USB Disk Auto Data Save. The characters table will appear beneath accordingly.





Use the scroll wheel to scroll through the available characters.



Press the LEFT / RIGHT arrow soft-keys to move the cursor to the next character and finish the naming.



5. Press the UP/DOWN arrow soft-keys to move the cursor to the Internal Memory SAVE setting followed by using the scroll wheel to turn on or off the setting, which automatically saves the test data into the internal memory of GPT-10000 series when enabled.



Internal Memory SAVE setting ON, OFF

6. Press the UP/DOWN arrow soft-keys to move the cursor to the Internal Memory Amount setting, which displays the total amount of test data.





Note

Only when “Internal Memory SAVE” is enabled can test data be stored into the internal memory amount.

Press the SAVE USB soft-key to save test data into the inserted USB disk. The saved data will be named xxxxxxxx.txt within the directory GPT1X000/MEASURE.



NO USB DISK Warning

If USB disk is Not properly inserted into GPT-10000 series, prompt message “NO USB DISK” pops up.

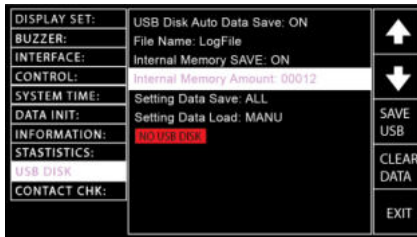

NO TEST DATA Warning

If there is no test data available in internal memory (Amount: 00000), even though USB disk is inserted, prompt message “NO TEST DATA” pops up.

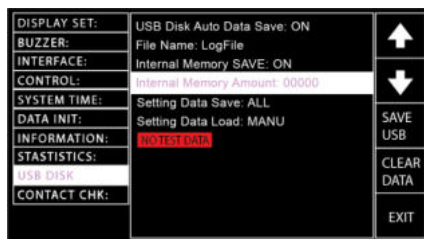

Press the CLEAR DATA soft-key to clear the internal memory amount.



NO TEST DATA Warning

If there is no test data available (Amount: 00000), prompt message “NO TEST DATA” pops up.

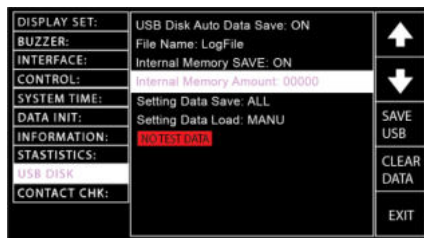

Note

Due to the 30,000 counts capacity limitation on internal memory amount, the warning message is shown on either MANU or AUTO mode when the maximum limitation is reached.

DATA
FULL
in
MANU
Test



Data Full Message

DATA
FULL
in
AUTO
Test

Data Full Message

MANU STEP	TEST MODE	V/I SETTING	HI SETTING	LOW SETTING	STEP HOLD	
AUTO-001						
001	DCW	0.100kV	1.000mA	000 uA	P.C/F.C	↑
002	ACW	0.100kV	1.000mA	000 uA	P.C/F.C	↓
026	IR	0.150kV	069.8MΩ	000.6MΩ	P.C/F.S	
001	DCW	0.100kV	1.000mA	000 uA	P.C/F.C	SKIP
002	ACW	0.100kV	1.000mA	000 uA	P.C/F.C	
						DEL.
						STEP HOLD

- Press the UP/DOWN arrow soft-keys to move the cursor to the Setting Data Save setting, which allows user to save individual data including MANUDATA, AUTODATA and SYSDATA or All data into the USB disk.



Setting Data Save setting

All, MANU,
AUTO, SYSTEM

DISPLAY SET:	USB Disk Auto Data Save: ON	↑
BUZZER:	File Name: LogFile	
INTERFACE:	Internal Memory SAVE: ON	↓
CONTROL:	Internal Memory Amount: 00012	
SYSTEM TIME:	Setting Data Save: ALL	SAVE USB
DATA INIT:	Setting Data Load: ALL	
INFORMATION:		
STATISTICS:		
USB DISK		
CONTACT CHK:		EXIT

Press the SAVE USB soft-key to save selected data into USB disk. The saved data will be named AUTODATA.txt, MANUDATA.txt & SYSTDATA.txt respectively within the directory GPT1X000/SET_DATA.



NO USB DISK Warning

If USB disk is Not properly inserted into GPT-10000 series, prompt message “NO USB DISK” pops up.

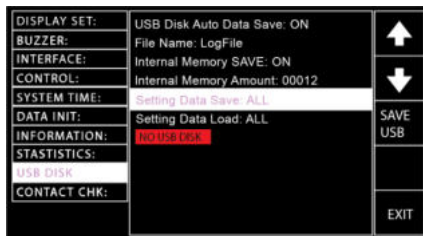

8. Press the UP/DOWN arrow soft-keys to move the cursor to the Setting Data Load setting, which allows user to load individual data including MANUDATA, AUTODAT A and SYSDATA or All data from the USB disk.



Setting Data Load setting All, MANU, AUTO, SYSTEM



Press the USB LOAD soft-key to load the selected data from the USB disk.



OPEN DATA ERROR Warning

If there is no desired data in the USB disk, the prompt message “OPEN XXXXDATA.TXT ERROR” pops up.



9. Press the EXIT soft-key to exit from the USB DISK page.



Note

- The changes in USB DISK setting are saved instantly.
- The System Data Init function under DATA INIT section is Not able to clear Internal Memory Amount. Instead, only CLEAR DATA soft-key can clear internal memory amount completely.

Make sure an USB disk is plugged into GTP-10000 unit before saving measurement data into the disk. Once an USB disk is well inserted, the USB icon, in either MANU or AUTO mode, appears accordingly.

USB icon in MANU



USB Disk Plugged in

USB icon in AUTO

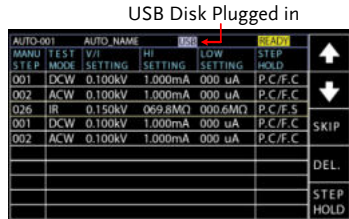

USB Disk Plugged in

Contact Check Settings

Background The CONTACT CHK function is used to determine if open circuit or short circuit occurs between the test leads and DUT under the ACW, DCW and IR tests. The section here allows user to define a reference value via learning process and also to assign Hi limit and Low limit for Short and Open status check, respectively.

Steps

1. Press the SYSTEM button on the front panel when the tester is under READY status in either MANU or AUTO test.



2. The SYSTEM page will be shown. Press the UP/DOWN arrow soft-keys to move the cursor to the CONTACT CHK setting.

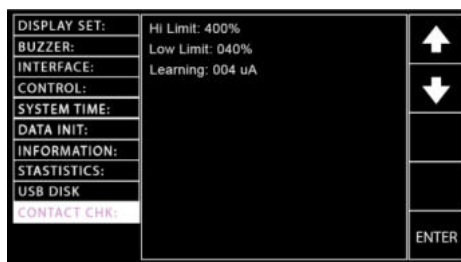

3. Press the ENTER soft-key to enter the Hi Limit setting followed by using scroll wheel to determine an exact scale of Hi Limit threshold that triggers the SHORT status warning.



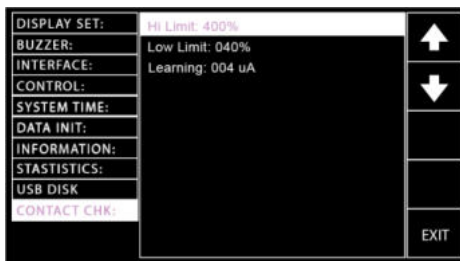

Hi Limit settings OFF, 110% ~ 500%

4. Press the UP/DOWN arrow soft-keys to move the cursor to the Low Limit setting followed by using scroll wheel to determine an exact scale of Low Limit threshold that triggers the OPEN status warning.

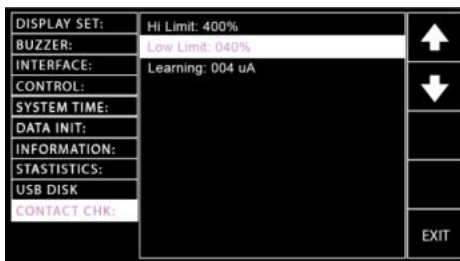
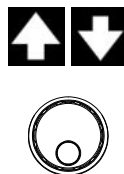

Low Limit settings 10% ~ 90%

5. Press the UP/DOWN arrow soft-keys to move the cursor to the Learning setting followed by pressing the RUN soft-key to obtain the current reference value.

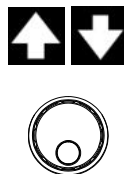



Note

- Prior to RUN the Learning process, be sure to well set up test leads connection between the GPT-10000 unit and the DUT.
- When reference value, for example, is defined as 40uA, and Hi and Low limits are set 400% and 40%, respectively, the OPEN status will be triggered when measured value is less than 16uA. The SHORT status, by contrast, will be triggered while measured value is above 160uA.
- When the reference value is learned below 30uA, the warning message will be shown as following and the CONTACT CHK function will be invalid even though CONTACT CHK is turned ON in MANU mode. Refer to page 80 for details of CONTACT CHK setting.



6. Press the EXIT soft-key to exit from the CONTACT CHK page.



Note

The changes in CONTACT CHK setting are saved instantly.

E XTERNAL CONTROL

The External Control chapter covers the
REMOTE terminal and the SIGNAL I/O port.

External Control Overview	176
Remote Terminal Overview	176
Remote Controller Operation	177
SIGNAL I/O Overview	178
Using the SIGNAL I/O to Start/Stop Tests	180
Using the Interlock Key	181

External Control Overview

The External Control section describes the front panel REMOTE terminal connection and the rear panel SIGNAL I/O port.

Remote Terminal Overview

Overview The REMOTE terminal connector is a standard 5-pin DIN terminal suitable for a remote controller.



WARNING

Keep any cables that are connected to the REMOTE terminal away from the HIGH VOLTAGE and RETURN terminals.

Pin Assignment and Connection

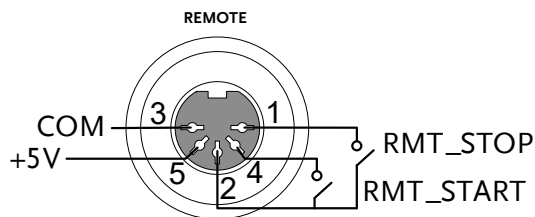

Pin	Pin name	Description
1	RMT_STOP	Remote Stop signal
2	COM	Common line
3	COM	Common line
4	RMT_START	Remote Start signal
5	+5V	+5V Output

Signal Properties

High level input voltage	3.3V~5.0V
Low level input voltage	0~0.8V
Input period	minimum of 1ms

Remote Controller Operation

Description The GPT-10000 accepts external remote controllers with a START and STOP button. To use the REMOTE terminal, the GPT-10000 must first be configured to accept a remote controller.

Operating a remote controller is the same as operating the START and STOP buttons on the front panel.

- Steps**
1. Insert the lead of remote controller into the REMOTE terminal.
 2. Configure the CONTROL option to Page 139 REMOTE in the SYSTEM mode.
 3. The tester will now only be able to start a test using a remote controller.

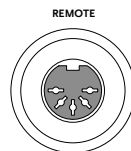

NOTE

Even if the GPT-10000 is configured to use the REMOTE option, the STOP button on the front panel can still be used to stop a test.

4. To return the operation control to the front panel, configure the CONTROL option to Front Panel. Page 139

SIGNAL I/O Overview

Overview The SIGNAL I/O port can be used to remotely start/stop tests and monitor the test status of the instrument.

The SIGNAL I/O port is also used for the interlock function. Refer to page 181 for details.

The SIGNAL I/O port basically uses a DB-15 pin female connector.

Pin Assignment

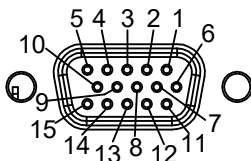

Pin name	Pin	Description
INTERLOCK1	1	When INTERLOCK is ON, a test is only allowed
INTERLOCK2	2	to start when both INTERLOCK pins are shorted.
INPUT_START	3	Start signal input
INPUT_STOP	4	Stop signal input
INPUT_COM	5	Common input line
NC	6	NC
OUTPUT_1	7	OUTPUT1 SIGNAL
OUTPUT_2	8	OUTPUT2 SIGNAL
OUTPUT_3	9	OUTPUT3 SIGNAL
OUTPUT_4	10	OUTPUT4 SIGNAL
OUTPUT_5	11	OUTPUT5 SIGNAL
NC	12	NC
NC	13	NC
NC	14	NC
OUTPUT_COM	15	Common output line

Interlock connection

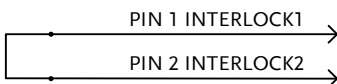

Input Connection

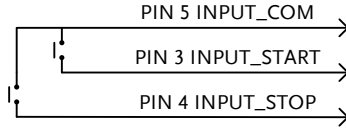

Output Connection

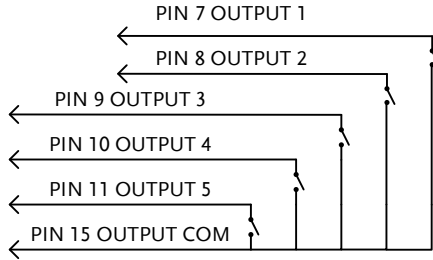

Signal Properties

Input Signals

High level input voltage	5V ~ 32V
Low level input voltage	0V ~ 1V
Low level input current	Maximum of -5mA
Input period	Minimum of 1ms

Output Signals

Output Type	Relay form A
Output Rated Voltage	30VDC
Maximum output current	0.5A

Input Stop and
Input Start
Timing

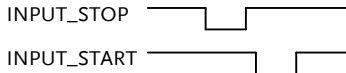

Output Timing

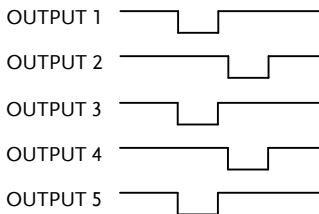

 **Note**

Output is able to be deployed by programming.

Using the SIGNAL I/O to Start/Stop Tests

Background To use the SIGNAL I/O port the CONTROL settings have to be set to SIGNAL IO in the SYSTEM mode.

- Panel operation
1. Set the CONTROL option to SIGNAL IO in the SYSTEM mode. Page 138
 2. Connect the Input/Output signals to the SIGNAL I/O port.
 3. To start the testing, short the INPUT_STOP and INPUT_COM line for a minimum of 1ms to put the tester into READY status.
 4. To start the testing, short the INPUT_START and INPUT_COM lines for a minimum of 1ms.
 5. To stop the testing, temporarily short the INPUT_STOP and INPUT_COM line again.
-



NOTE

Even if the GPT-10000 is configured to use the SIGNAL I/O interface, the STOP button on the front panel can still be used to stop a test.

Using the Interlock Key

Background When the INTERLOCK function is set to ON, tests are only allowed to start when both Interlock pins on the signal I/O port are shorted. Using the Interlock key will short the INTERLOCK1 and INTERLOCK2 pins on the signal I/O port. See page 178 for the Signal I/O pin assignment.

Panel operation 1. Insert the Interlock key into the SIGNAL I/O port on the rear panel.

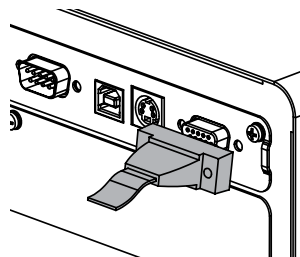

2. Set the Interlock option to ON in the SYSTEM mode. Page 139



Note

With INTERLOCK set to ON, the tester can now only start a test when the Interlock key is connected. Please note that removing the interlock key after starting a test leads to interruption of test.

Set Interlock to OFF to disable this feature.

REMOTE CONTROL

This chapter describes basic configuration of IEEE488.2 based remote control. The remote interface supports USB, RS232 and GPIB.

Interface Configuration	183
Command Syntax	188
Command List	191
Error Messages	257

Interface Configuration

USB Remote Interface

USB Configuration	PC side connector	Type A, host
	GPT-10000 side connector	Rear panel Type B
	USB Class	CDC (communications device class) (VCP, Virtual Com Port)

- Panel operation
1. Connect the USB cable to the rear panel USB B-Type port.



2. Set the Interface to USB from the SYSTEM mode. Page 133
-



Note

When USB is used for remote control, an RS232 port is simulated. Check the Windows Device Manager for the baud rate and other RS232 settings. Check the RS232 configuration below for more details.

Note the baud rate is fixed to 115200 baud when using the USB interface.

RS232 Remote Interface

RS232 Configuration	Connection	Null modem cable
	Baud rate	9600, 19200, 38400, 57600, 115200
	Parity	None
	Data bits	8

Stop bit 1

Flow control None

Pin Assignment

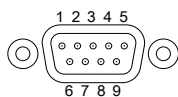

- 1: No connection
- 2: RxD (Receive Data)
- 3: TxD (Transmit Data)
- 4: No connection
- 5: GND
- 6-9: No connection

Connection	PC		Tester	
	DB9 Pin	Signal	Signal	DB9Pin
	2	RxD	TxD	3
	3	TxD	RxD	2
	5	GND	GND	5

Panel operation 1. Connect the Null modem cable to the rear panel RS232 port.

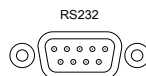

2. Set the Interface to RS-232 from the Page 133 SYSTEM mode.

LAN Remote Interface

LAN Configuration	Connection	RJ-45 cable
	DHCP	ON, OFF
	Socket Port	00000 – 65000
	IP Address	0-255, 0-255, 0-255, 0-255
	Subnet Mask	0-255, 0-255, 0-255, 0-255
	Gateway	0-255, 0-255, 0-255, 0-255
	MAC	XX:XX:XX:XX:XX:XX: (it varies by LAN card)

Panel operation 1. Connect the RJ-45 cable to the rear panel LAN port.



2. Set the Interface to LAN from the SYSTEM mode. Page 133

GPIB Remote Interface

GPIB Configuration	Address	0-31
--------------------	---------	------

Panel operation 1. Connect the GPIB cable to the rear panel GPIB port.



2. Set the Interface to GPIB and set the GPIB address from the SYSTEM mode. Page 133

USB/RS232/LAN/GPIB Remote Control Function Check

Functionality check

Invoke a terminal application such as RealTerm.

To check COM port number and other settings, see the Device Manager in PC. For WinXP; Control panel → System → Hardware tab.

Run this query command via the terminal after the instrument has been configured for USB, RS-232 or GPIB remote control.

*idn?

This should return Model number, Serial number and Firmware version in the format below:

GPT-12004 ,GPT12000 ,V1.00

Model number : GPT-12004

Serial number :8 characters serial number

Firmware version : V1.00

CR, LF, CR+LF can be used as the terminal character when entering queries/commands from a terminal application. Refer to page 190 for details.

RMT Display

When the panel is being remotely controlled via the USB, RS232, LAN or GPIB interfaces, the RMT indicator will be displayed on the screen.

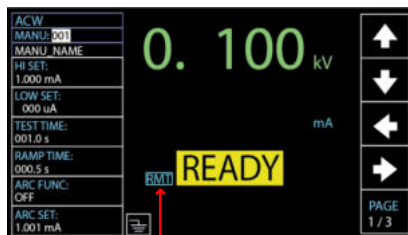

RMT indicator

Err Display

When an incorrect command is sent to the tester, the Err indicator will be displayed on the screen indicating there is an error in command.

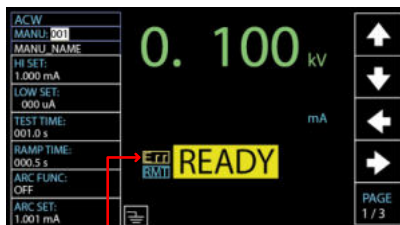

Err indicator

Return to Panel Control

Background

When the instrument is remotely controlled all panel keys except the STOP button are disabled. Receive a stop signal from either mode of Control By (Front Panel, Remote, SIGNAL IO), while the RMT indicator is displayed, or simply send a RMToff command (page 255) to return the instrument back to the READY status.



Note

To put the tester back to the RMT, simply issue another remote control command.

Command Syntax

Compatible Standard	IEEE488.2	Partial compatibility
	SCPI, 1999	Partial compatibility

Command Structure

SCPI commands follow a tree-like structure, organized into nodes. Each level of the command tree is a node. Each keyword in an SCPI command represents each node in the command tree. Each keyword (node) of an SCPI command is separated by a colon (:).

For example, the diagram below shows an SCPI sub-structure and a command example.

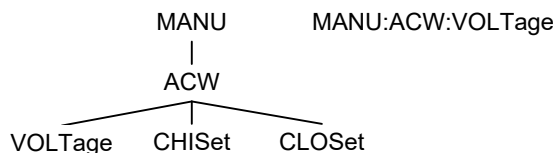

Command types

There are a number of different instrument commands and queries. A command sends instructions or data to the unit and a query receives data or status information from the unit.

Command types

Setting A single or compound command with/without a parameter

Example MANU:STEP 1

<NR3>	floating point	4.5e-1, 8.25e+1
<NRf>	any of NR1, 2, 3	1, 1.5, 4.5e-1
<string>	ASCII text string	TEST_NAME

Message Terminator	CR, LF, CR+LF	Carriage Return, Line feed code, Carriage Return + Line feed code
--------------------	---------------	---



Note

There is an interval, which is 100ms at least, between each command communication. It is normal to see the interval occurred when promptly sending commands in the continuous way.

Command List

System Commands

SYSTem:LCD:BRIGhtness	195
SYSTem:BUZZer:VOLume	196
SYSTem:BUZZer:KEYSound	196
SYSTem:TIme	196
SYSTem:STATistics	197
SYSTem:ANALysis	197
SYSTem:USBDisk:AUTosave.....	198
SYSTem:USBDisk:AMOUnt	198
SYSTem:USBDisk:FILeName.....	198
SYSTem:INTernal:SAVe	199
SYSTem:CONtact:HILimit	199
SYSTem:CONtact:LOWLimit	200
SYSTem:CONtact:LEARning.....	200
SYSTem:ERRor	200
SYSTem:CONtrol:INTerlock.....	202
SYSTem:CAL:ALERT	202
SYSTem:CAL:DATE	202
SYSTem:CAL:DUE	203
SYSTem:ALERT:DATE.....	203
SYSTem:CAL:PROtEction	203
SYSTem:INTernal:MEMory	204

Function Commands

FUNction:TEST	205
MEASure<x>	206
MAIn:FUNction.....	209
TESTok:RETurn	209

Manual Commands

MANU:STEP	212
-----------------	-----

MANU:INITial	212
MANU:NAME.....	213
MANU:RTIME	213
MANU:EDIT:MODE.....	214
MANU:ACW:VOLTage	214
MANU:ACW:CHISet.....	215
MANU:ACW:CLOSet.....	216
MANU:ACW:FILTer	216
MANU:ACW:TTIME	217
MANU:ACW:ARCFunction	218
MANU:ACW:ARCCurrent.....	219
MANU:ACW:ARCSpeed	219
MANU:ACW:FREQuency	219
MANU:ACW:WAITtime.....	220
MANU:ACW:RAMPdown	220
MANU:ACW:GROundmode	221
MANU:ACW:MAXHold.....	221
MANU:ACW:PASShold.....	221
MANU:ACW:REF	222
MANU:ACW:INITvoltage.....	222
MANU:ACW:CONtAct.....	223
MANU:DCW:VOLTage	223
MANU:DCW:CHISet.....	224
MANU:DCW:CLOSet.....	224
MANU:DCW:TTIME	225
MANU:DCW:ARCFunction	226
MANU:DCW:ARCCurrent.....	226
MANU:DCW:ARCSpeed	226
MANU:DCW:WAITtime.....	227
MANU:DCW:RAMPdown	227
MANU:DCW:GROundmode	228
MANU:DCW:MAXHold.....	228
MANU:DCW:PASShold.....	228
MANU:DCW:REF	229
MANU:DCW:INITvoltage.....	229
MANU:DCW:CONtAct.....	230
MANU:DCW:FILTer	230
MANU:IR:VOLTage	231
MANU:IR:RHISet.....	231
MANU:IR:RLOSet.....	231

MANU:IR:TTIME	232
MANU:IR:WAITtime	232
MANU:IR:RAMPdown	232
MANU:IR:GROundmode	233
MANU:IR:MAXHold	233
MANU:IR:PASShold	235
MANU:IR:REF	235
MANU:IR:MODE	236
MANU:IR:CONtact	236
MANU:IR:FILTer	237
MANU:IR:GNDoffset	237
MANU:GB:CURRent	238
MANU:GB:RHISet	238
MANU:GB:RLOSet	239
MANU:GB:TTIME	239
MANU:GB:FREQuency	239
MANU:GB:CONtact	240
MANU:GB:GROundmode	240
MANU:GB:MAXHold	240
MANU:GB:PASShold	241
MANU:GB:REF	241
MANU:GB:ZERocheck	242
MANU:CONtInuity:RHISet	242
MANU:CONtInuity:RLOSet	243
MANU:CONtInuity:TTIME	243
MANU:CONtInuity:PASShold	244
MANU:CONtInuity:REF	244
MANU:CONtInuity:ZEROCHECK	245

Auto Commands

AUTO:STEP	246
AUTO:NAME	247
AUTO:EDIT:ADD	248
AUTO<x>:EDIT:HOLD	249
AUTO<x>:EDIT:SKIP	249
AUTO:EDIT:DEL	250
AUTO:TEST:RETurn	250
AUTO:EDIT:SHOW	251

Sweep Commands

SWEEP:DATA:STAT <u>s</u>	252
SWEEP:DATA:SHOW	252
SWEEP:GRAP <u>h</u> :SHOW	253

Common Commands

*CLS.....	254
*IDN	254
*SRE.....	255

Remote Commands

*RMT <u>o</u> ff	255
------------------------	-----

Special Functions

INT <u>e</u> rlock:PIN.....	256
-----------------------------	-----

System Commands

SYSTem:LCD:BRIGhtness	195
SYSTem:BUZZer:VOLume	196
SYSTem:BUZZer:KEYSound	196
SYSTem:TIME	196
SYSTem:STATistics	197
SYSTem:ANALysis	197
SYSTem:USBDisk:AUTosave.....	198
SYSTem:USBDisk:AMOunt	198
SYSTem:USBDisk:FILeName.....	198
SYSTem:INTernal:SAVe	199
SYSTem:CONtact:HILimit	199
SYSTem:CONtact:LOWLimit	200
SYSTem:CONtact:LEARning.....	200
SYSTem:ERRor	200
SYSTem:CONTRol:INTERlock.....	202
SYSTem:CAL:ALERT	202
SYSTem:CAL:DATE	202
SYSTem:CAL:DUE	203
SYSTem:ALERT:DATE.....	203
SYSTem:CAL:PROtEction	203
SYSTem:INTernal:MEMory	204

SYSTem:LCD:BRIGhtness



Description	Sets the brightness of the LCD display from 1(dark) to 10(bright).
-------------	--

Syntax	SYSTem:LCD:BRIGhtness <NR1>
--------	-----------------------------

Query Syntax	SYSTem:LCD:BRIGhtness?
--------------	------------------------

Parameter/ Return parameter	<NR1> 1 (dark) ~ 10 (bright)
--------------------------------	------------------------------

Example	SYST:LCD:BRIG 10 Sets the display brightness to the brightest 10.
---------	--

SYSTem:BUZZer:VOLume (Set) →
→ (Query)

Description	Sets buzzer volume from 1(low) to 3(high).
Syntax	SYSTem:BUZZer:VOLume <NR1>
Query Syntax	SYSTem:BUZZer:VOLume
Parameter/ Return parameter	<NR1> 1 (low) ~ 3 (high)
Example	SYST:BUZZ:VOLUME 3 Sets the buzzer volume to the highest 3.

SYSTem:BUZZer:KEYSound (Set) →
→ (Query)

Description	Turns the buzzer on or off for key sound.
Syntax	SYSTem:BUZZer:KEYSound {ON OFF}
Query Syntax	SYSTem:BUZZer:KEYSound?
Parameter/ Return parameter	ON Buzzer Key Sound on. OFF Buzzer Key Sound off.
Example	SYST:BUZZ:KEYS ON Turns the buzzer on for key sound.

SYSTem:TIME (Set) →
→ (Query)

Description	Sets or Queries the system time.
Syntax	SYSTem:TIME {TYY_MM_DD_hh:mm:ss}
Query Syntax	SYSTem:TIME?
Parameter/ Return parameter	TYY_MM_D Year (YY)_Month (MM)_Day D_hh:mm:ss (DD)_Hour (hh)_Minute (mm)_Second (ss)
	<string> Returns the system date & time as a string
Example	SYST:TIME T19_12_05_17_10_20 Sets the system time as 2019-12-05 17:10:20

SYSTEM:STATistics

→ Query

Description	Queries the latest statistics of PASS and FAIL.	
Query Syntax	SYSTEM:STATistics?	
Return parameter	<string>	Returns the latest statistics of all the function tests with counts of PASS and FAIL judgments respectively.
Query Example	SYST:STAT? >TOTAL AMOUNT=00071 >PASS AMOUNT=00059 >FAIL AMOUNT=00012 >FUNC,PASS ,FAIL , >ACW ,00026,00009, >DCW ,00000,00000, >IR ,00017,00003, >GB ,00000,00000, >CONT,00016,00000,	

SYSTEM:ANALysis

→ Query

Description	Queries the latest analysis of each test function.	
Query Syntax	SYSTEM:ANALysis {ACW DCW IR GB CONT}	
Return parameter	<string>	Returns the latest analysis of the select test with PASS and FAIL judgments and distributions.
Query Example	SYST:ANAL IR >IR,PASS=00017,FAIL=00003 >000~025%=00003 >026~050%=00000 >051~075%=00000 >076~100%=00014 >FAIL=00003	

SYSTEM:USBDisk:AUTosave

Set →

→ Query

Description	Sets or returns the USB disk auto data save on or off.	
Syntax	SYSTEM:USBDisk:AUTosave {ON OFF}	
Query Syntax	SYSTEM:USBDisk:AUTosave?	
Parameter	ON	Turns the USB disk auto save on.
	OFF	Turns the USB disk auto save off.
Return parameter	ON	USB disk auto save on.
	OFF	USB disk auto save off.
Example	SYST:USB:AUTOSAVE ON Turns USB disk auto save on.	

SYSTEM:USBDisk:AMOut

Set →

→ Query

Description	Saves, clears or returns the amount of tests. When saving, there are 2 results as follows. If no USB disk is inserted, the message “NO USB DISK” shows. If USB disk is inserted properly, the message “SAVE OK” is shown.	
Syntax	SYSTEM:USBDisk:AMOut {SAVE CLEAR}	
Query Syntax	SYSTEM:USBDisk:AMOut?	
Parameter	SAVE	Saves the amount of tests into USB disk.
	CLEAR	Clears the amount of tests from internal memory.
Return parameter	<value>	Returns the amount of tests from internal memory.
Example	SYST:USB:AMOUNT SAVE Saves the amount of tests into USB disk.	

SYSTEM:USBDisk:FILEname

Set →

→ Query

Description	Sets or returns the data file name to be saved into the inserted USB disk. Note only alphanumeric characters (A-Z, a-z, 0-9) and the “_” underscore character can be used to set the file name.
Syntax	SYSTem:USBDisk:FILEname <"string">
Query Syntax	SYSTem:USBDisk:FILEname?
Parameter/ Return parameter	<"String"> 8 character string.
Example	SYST:USB:FILENAME "File1" Sets the data file name to "File1".

Set →

→ Query

SYSTEM:INTERNAL:SAVE

Description	Sets or returns the internal data save on or off.
Syntax	SYSTem:INTERNAL:SAVE {ON OFF}
Query Syntax	SYSTem:INTERNAL:SAVE?
Parameter	ON Turns the internal data save on. OFF Turns the internal data save off.
Return parameter	ON Internal data save on. OFF Internal data save off.
Example	SYST:INTERNAL:SAVE ON Turns internal data save on.

Set →

→ Query

SYSTEM:CONTACT:HILimit

Description	Sets or returns the threshold of Hi Limit scale for contact check function.
Syntax	SYSTem:CONTACT:HILimit {value OFF}
Query Syntax	SYSTem:CONTACT:HILimit?
Parameter	<value> 110% ~ 500% OFF Disables the threshold of Hi Limit scale.
Return parameter	<value> 110% ~ 500% OFF The threshold of Hi Limit scale is disabled.

Example SYST:CONT:HILIMIT 200%

 Sets the threshold of Hi Limit scale as 200% to the reference value.

Set →

SYSTEM:CONTACT:LOWLimit

→ Query

Description Sets or returns the threshold of Low Limit scale for contact check function.

Syntax SYSTEM:CONTACT:LOWLimit {value}

Query Syntax SYSTEM:CONTACT:LOWLimit?

Parameter <value> 10% ~ 90%

Return parameter <value> 10% ~ 90%

Example SYST:CONT:LOWLIMIT 80%

 Sets the threshold of Low Limit scale as 80% to the reference value.

Set →

SYSTEM:CONTACT:LEARNing

→ Query

Description Sets or returns the current reference value for contact check function.

Syntax SYSTEM:CONTACT:LEARNing RUN

Query Syntax SYSTEM:CONTACT:LEARNing?

Parameter RUN Sets the current reference value.

Return parameter <value> Returns the current reference value.

Example SYST:CONT:LEARNING RUN

 The current reference value for contact check is set.

SYSTEM:ERRor

→ Query

Description Returns error code of the previous error. See the error code table below for details.

Query Syntax SYSTEM:ERRor ?

Return parameter	<string>	Returns an error string that includes an error code and an error description.
------------------	----------	---

Error Code Table

Error code, Error description

0, No Error
20, Command Error
21, Value Error
22, String Error
23, Query Error
24, Mode Error
25, TIME OVER 240s
26, DC Over 50W [GPT-12XXX]
26, DC Over 100W [GPT-15XXX]
27, GBV > 7.2V
28, ARC <= HI Set
29, HI Set => ARC
30, Voltage Setting Error
31, Current Setting Error
32, Current HI SET Error
33, Current LO SET Error
34, Resistance HI SET Error
35, Resistance LO SET Error
36, REF Setting Error
37, Frequency Setting Error
38, ARC Setting Error
39, RAMP Time Setting Error
40, TEST Time Setting Error
41, WAIT Time Setting Error
42, RAMP Down Setting Error
43, PASS Hold Setting Error
44, GB Contact Setting Error
45, Setting Over 200W
46, CONT Setting Over 8V
47, Auto Step Add Full
48, This Is The Last Step
49, Learning less than 30uA
50, USB DISK BUSY
51, Filter Setting Error
70, Read Buffer Error

Example 71,Send Buffer Error
 SYST:ERR ?
 >0,No Error
 Returns "0,No Error" as the error message.

SYSTem:CONTRol:INTerlock → Query

Description Returns the status of interlock setting.

Query Syntax SYSTem:CONTRol:INTerlock?

Return parameter On Interlock setting is set On.
 Off Interlock setting is set Off.

Example SYSTem:CONTRol:INTerlock?
 > On
 Returns the interlock setting is set On.

Set →

SYSTem:CAL:ALERT → Query

Description Sets or returns the calibration alert function.

Syntax SYSTem:CAL:ALERT {ON |OFF}

Query Syntax SYSTem:CAL:ALERT?

Parameter ON Turns the calibration alert on.
 OFF Turns the calibration alert off.

Return parameter ON Calibration alert on.
 OFF Calibration alert off.

Example SYST:CAL:ALERT ON
 Sets the calibration alert function ON.

Set →

SYSTem:CAL:DATE → Query

Description Sets or returns the calibration date.

Syntax SYSTem:CAL:DATE {TYY_MM_DD}

Query Syntax SYSTem:CAL:DATE?

Parameter/ TYY_MM_DD Year (YY)_Month (MM)_Day (DD)

Return parameter	<code><string></code>	Returns the calibration date as a string
------------------	-----------------------------	--

Example `SYST:CAL:DATE T21_06_01`
 Sets the calibration date as 2021-06-01.

(Set) →

SYSTEM:CAL:DUE

→ (Query)

Description	Sets or returns the next calibration due date.	
-------------	--	--

Syntax	<code>SYSTEM:CAL:DUE {TYY_MM_DD}</code>	
--------	---	--

Query Syntax	<code>SYSTEM:CAL:DUE?</code>	
--------------	------------------------------	--

Parameter/ Return parameter	<code>TYY_MM_DD</code> <code><string></code>	Year (YY)_Month (MM)_Day (DD) Returns the next calibration due date as a string
--------------------------------	---	--

Example `SYST:CAL:DUE T21_06_01`
 Sets the next calibration due date as 2021-06-01.

(Set) →

SYSTEM:ALERT:DATE

→ (Query)

Description	Sets or returns the pre-alert date for calibration due date.	
-------------	--	--

Syntax	<code>SYSTEM:ALERT:DATE {TYY_MM_DD}</code>	
--------	--	--

Query Syntax	<code>SYSTEM:ALERT:DATE?</code>	
--------------	---------------------------------	--

Parameter/ Return parameter	<code>TYY_MM_DD</code> <code><string></code>	Year (YY)_Month (MM)_Day (DD) Returns the pre-alert date for calibration due date as a string
--------------------------------	---	--

Example `SYST:ALERT:DATE T21_06_01`
 Sets the pre-alert date as 2021-06-01.

(Set) →

SYSTEM:CAL:PROTECTION

→ (Query)

Description	Sets or returns the calibration output protection for calibration due date.	
-------------	---	--

Syntax	SYSTem:CAL:PROTection {ON OFF}	
Query Syntax	SYSTem:CAL:PROTection?	
Parameter	ON	Turns the calibration protection on.
	OFF	Turns the calibration protection off.
Return parameter	ON	Calibration protection on.
	OFF	Calibration protection off.
Example	SYST:CAL:PROT ON Sets the calibration protection function ON.	

SYSTem:INTernal:MEMory → Query

Description	Returns the test result from internal memory of unit.	
Query Syntax	SYSTem:INTernal:MEMory?	
Return parameter	<string>	Returns the test result from internal memory as a string.
Example	SYST:INTERNAL:MEMORY? > Date/Time ,Stp,MOD,Judge, V/A , Reading , Timer ,MA_S,Barcode , 2021-02-24 13:52:08,001,IR ,PASS ,0.049kV, >10Gohm,T=000.3s,A002, ,	

Function Commands

FUNcTION:TEST	205
MEASure<x>	206
MAIN:FUNcTION.....	209
TESTok:RETurn.....	209

FUNcTION:TEST

Set →

→ Query

Description Turns the currently selected test (output) on or off.

When HOLD is displayed on the screen during AUTO tests, use the FUNcTION:TEST command to move on to the next step.

Setting the FUNcTION:TEST command to OFF at the end of a test will also temporarily turn the PASS/FAIL buzzer sound off.

Syntax	FUNcTION:TEST {ON OFF}	
Query Syntax	FUNcTION:TEST?	
Parameter	ON	Turns the test on.
	OFF	Turns the test off.
Return parameter	TEST ON	Test is on.
	TEST OFF	Test is off.
Example	FUNc:TEST ON Turns the output on.	

MEASure<x>

→ **Query**

Description Returns the test parameters & results of the tester in either MANU or AUTO mode.

MANU mode: Returns the test parameters & results of a MANU test.

AUTO mode: Returns the test parameters & results of the selected step (1-50) of the AUTO test.

Return parameters: Function, Status, Test Value1, Test Value2, Test Time.

Query Syntax	MEASure<x>?	
Parameter (MANU mode)		No parameter needed for MANU mode.
Parameter (AUTO mode)	<x>	<NR1>1~50. MANU Step number.
Return parameter	<string>	Returns the test status of the test in the following format: Function, Status, Test Value1, Test Value2, Test Time.
	Function	ACW, DCW, IR, GB, CON
	Status	Refer to the table with affiliated contents below for details
	Test Value1	Voltage+unit
	Test Value2	Current+unit Resistance+unit
	Test Time	I= Initial Time+s R=Ramp Time+s T=Test Time+s D=Ramp Down Time+s

Function	Status	TEST Value1	TEST Value2	TEST TIME
ACW	TEST	X . X X X k V ,	X X X . X u A ,	I = X X X . X s
DCW	READY		X X X u A ,	R
	PASS		X . X X X m A ,	T
IR	FAIL		X X . X X m A ,	D
	ERROR		X X X . X m A ,	
	FAILH	X . X X X k V ,	> 1 0 o h m ,	V<150V and R > 10G
	FAILL		> 2 0 o h m ,	V<500V and R>20G
IR	VOVER		> 5 0 o h m ,	V>=500V and R>50G
	VLOW			
	SHORT		X X . X X G o h m ,	
GB	OPEN		X . X X X G o h m ,	
	TOVER		X X X . X M o h m ,	
	TLOW			
	GFAIL	X X . X X A ,	X X X . X m o h m ,	
CON	ARC		X X . X X m o h m ,	
	STOP		X . X X X m o h m ,	
	HOLDP		R O V E R	
	HOLDF			
CON	HOLDT	1 0 0 . 0 m A ,	X X . X X o h m ,	
			R O V E R	

Status - FAILH

Applied Function: ACW, DCW, IR, GB, CON

Description: Read Data > HI SET

Status - FAILL

Applied Function: ACW, DCW, IR, GB, CON

Description: Read Data < LOW SET

Status - VOVER

Applied Function: ACW, DCW, IR, GB, CON

Description: ACW, DCW, IR: Read V > V set 110%

GB: GBV > 7.2V

CON: Read CONT V > 8V

Status - VLOW

Applied Function: ACW, DCW, IR

Description: Read V < V set 90%

Status - SHORT

Applied Function: ACW, DCW, IR

Description: Read V < 10V

Contact Check LOW Error

Status - IOVER

Applied Function: GB

Description: Read I > I SET 110%

Status - I LOW

Applied Function: GB

Description: Read I < I SET 90%

Status - ARC

Applied Function: ACW, DCW

Description: Read T > ARC Set Current

Status - GFAIL

Applied Function: ACW, DCW, IR

Description: GFCI ERROR

Status - OPEN

Applied Function: ACW, DCW, IR

Description: Contact Check LOW Error

Status - HOLDP

Applied Function: ACW, DCW, IR, GB, CON

Description: When the PASS HOLD is set for AUTO mode, the HOLDP status will be returned after executing MEAS command.

Status - HOLDF

Applied Function: ACW, DCW, IR, GB, CON

Description: When the FAIL HOLD is set for AUTO mode, the HOLDF status will be returned after executing MEAS command.

Status - HOLDT

Applied Function: ACW, DCW, IR, GB, CON

Description: When HOLD TIME is kept running on, the HOLDT status will be returned after executing MEAS command.

Example MEAS?
 (in MANU mode) > CON,FAIL ,100.0mA,99.99 ohm,T=000.1s
 Returns the test result of the current MANU test.

Example MEAS21?
 (in AUTO mode) > DCW,FAIL ,0.004kV, 000.0 uA ,T=000.3s
 Returns the step 21 of the current AUTO test result.

MAIN:FUNCTION

Set →

→ Query

Description Changes the mode between AUTO and MANU.

Syntax MAIN:FUNCTION {MANU|AUTO}

Query Syntax MAIN:FUNCTION ?

Parameter/ MANU Puts the tester mode to MANU.

Return parameter AUTO Puts the tester mode to AUTO.

Example MAIN:FUNC MANU
 Sets the tester to MANU mode.

Set →

→ Query

TESTok:RETurn

Description Turns on or off the "OK" message for test result, which is shown when a test finishes.

Syntax TESTok:RETurn {ON|OFF}

Query Syntax TESTok:RETurn ?

Parameter/ ON Turns on the "OK" message for test result.

Return parameter OFF Turns off the "OK" message for test result.

Example TEST:RETURN ON
 Turns of the OK message return function.

Manual Commands

MANU:STEP.....	212
MANU:INITial	212
MANU:NAME.....	213
MANU:RTIME	213
MANU:EDIT:MODE.....	214
MANU:ACW:VOLTage	214
MANU:ACW:CHISet.....	215
MANU:ACW:CLOSet.....	216
MANU:ACW:FILTer	216
MANU:ACW:TTIME	217
MANU:ACW:ARCFunction	218
MANU:ACW:ARCCurrent.....	219
MANU:ACW:ARCSpeed	219
MANU:ACW:FREQuency	219
MANU:ACW:WAITtime.....	220
MANU:ACW:RAMPdown	220
MANU:ACW:GROundmode	221
MANU:ACW:MAXHold.....	221
MANU:ACW:PASShold.....	221
MANU:ACW:REF	222
MANU:ACW:INITvoltage.....	222
MANU:ACW:CONtact.....	223
MANU:DCW:VOLTage	223
MANU:DCW:CHISet.....	224
MANU:DCW:CLOSet.....	224
MANU:DCW:TTIME	225
MANU:DCW:ARCFunction	226
MANU:DCW:ARCCurrent.....	226
MANU:DCW:ARCSpeed	226
MANU:DCW:WAITtime.....	227
MANU:DCW:RAMPdown	227
MANU:DCW:GROundmode	228
MANU:DCW:MAXHold.....	228
MANU:DCW:PASShold.....	228
MANU:DCW:REF	229
MANU:DCW:INITvoltage.....	229

MANU:DCW:CONtAct.....	230
MANU:DCW:FiLTer.....	230
MANU:IR:VoLTage	231
MANU:IR:RHISet.....	231
MANU:IR:RLOSet.....	231
MANU:IR:TTIME	232
MANU:IR:WAItime.....	232
MANU:IR:RAMPdown	232
MANU:IR:GRoundmode	233
MANU:IR:MAXHold.....	233
MANU:IR:PASShold.....	235
MANU:IR:REF.....	235
MANU:IR:MODE.....	236
MANU:IR:CONtAct.....	236
MANU:IR:FiLTer	237
MANU:IR:GNDoffset	237
MANU:GB:CURRent	238
MANU:GB:RHISet	238
MANU:GB:RLOSet	239
MANU:GB:TTIME	239
MANU:GB:FREQuency	239
MANU:GB:CONtAct	240
MANU:GB:GRoundmode.....	240
MANU:GB:MAXHold	240
MANU:GB:PASShold	241
MANU:GB:REF.....	241
MANU:GB:ZERocheck	242
MANU:CONtInuity:RHISet.....	242
MANU:CONtInuity:RLOSet.....	243
MANU:CONtInuity:TTIME	243
MANU:CONtInuity:PASShold	244
MANU:CONtInuity:REF.....	244
MANU:CONtInuity:ZEROCHECK	245

Set →

→ Query

MANU:STEP

Description	Sets the MANU test number.
Syntax	MANU:STEP <NR1>
Query Syntax	MANU:STEP?
Parameter/ Return parameter	<NR1> 0~100
Example	MANU:STEP 100 Sets the manual test number to 100.

MANU:INITial

Set →

Description Loads the initial (default) settings for the selected MANU test number. The initial settings that are loaded depend on the test function (ACW, DCW, IR, GB or CONT).

Syntax	MANU:INITial					
Initial Settings		Function				
	Parameter	ACW	DCW	IR	GB	CONT
	REF#	000uA	000uA	000.0M Ω	000.0m Ω	00.00Ω
	FREQ	60Hz	X	X	60Hz	X
	HI SET	1.000mA	1.000mA	OFF	100.0m Ω	01.00Ω
	LOW SET	000uA	000uA	000.1M Ω	000.0m Ω	00.00Ω
	I or V	V=0.100 kV	V=0.100 kV	V=0.050 kV	03.00A	100mA
	TEST TIME	000.3s	000.3s	000.3s	000.3s	000.3s
	RAMP TIME	000.1s	000.1s	000.1s	X	X

Example MANU:INITial
Loads the initial settings for the selected MANU number.

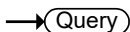
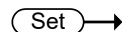

MANU:NAME

Description Sets or returns the test name for the selected manual test. The test must be in MANU mode before this command can be used.
 Note only alphanumeric characters (A-Z, a-z, 0-9) and the “_” underscore character can be used to set the MANU test name.

Syntax MANU:NAME <”string”>

Query Syntax MANU:NAME?

Parameter/Return parameter <”string”> 10 character string.

Example MANU:NAME “test1”
 Sets the manual test name to “test1”.

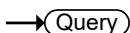
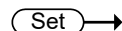

MANU:RTIME

Description Sets or returns the Ramp Up time for ACW, DCW and IR tests in seconds.

Note: An “Err” message will be shown on display if the Ramp Time + Test Time is > 240 seconds when the HI SET limit + REF is ≥ 30mA for GPT-12XXX or HI SET limit + REF is ≥ 80mA for GPT-15XXX. This applies to the ACW function only. An “TIME OVER 240s” message will be returned after using the query command “SYSTem:ERRor ?” in remote control.

Note: When tester is in GB or CONT mode, due to without RAMP TIME setting, only an “Err” message will be shown if issuing this remote command.

Syntax MANU:RTIME <NR2>

Query Syntax MANU:RTIME?

Parameter/Return parameter <NR2> 0.1~999.9 seconds

Example MANU:RTIM 0.5
 Sets the ramp time to half a second.

Set →

MANU:EDIT:MODE

→ Query

Description Sets or returns the mode (ACW, DCW, IR, GB, CONT) of the selected manual test.

Syntax MANU:EDIT:MODE {ACW|DCW|IR|GB|CONT}

Query Syntax MANU:EDIT:MODE?

Parameter/ ACW AC Withstand mode

Return parameter DCW DC Withstand mode

IR Insulation Resistance mode

GB Ground Bond mode

CONT Continuity mode

Example MANU:EDIT:MODE ACW
 Sets the mode to ACW.

Set →

MANU:ACW:VOLTage

→ Query

Description Sets or returns the ACW voltage in kV. The test must first be in ACW mode before this command can be used.

Syntax MANU:ACW:VOLTage <NR2>

Query Syntax MANU:ACW:VOLTage?

Parameter/ <NR2> 0.050 ~ 5.100 (kV)

Return parameter

Example MANU:ACW:VOLT 1
 Sets the ACW voltage to 1 kV.

Set →

→ Query

MANU:ACW:CHISet

Description Sets or returns the ACW HI SET current value in milliamps. The test must first be in ACW mode before this command can be used.

Note: An “Err” message will be shown on display if the Ramp Time + Test Time is > 240 seconds when the HI SET limit + REF is ≥ 30mA for GPT-12XXX or HI SET limit + REF is ≥ 80mA for GPT-15XXX. This applies to the ACW function only. An “TIME OVER 240s” message will be returned after using the query command “SYSTem:ERRor ?” in remote control.

Syntax MANU:ACW:CHISet <NR2>

Query Syntax MANU:ACW:CHISet?

Parameter/	<NR2>	0.001 ~ 42.00 (mA) [GPT-12XXX]
Return parameter		0.001 ~ 110.00 (mA) [GPT-15XXX]

Example MANU:ACW:CHIS 30.0
 Sets the ACW HI SET current to 30 mA.

Set →

→ Query

MANU:ACW:CLOSet

Description Sets or returns the ACW LOW SET current value in milliamps. The LOW SET value must be less than the HI SET value. The test must first be in ACW mode before this command can be used.

The LOW SET range must use the HI SET range. If all the digits in the LOW SET range are outside the HI SET range, an Err message will be produced. All digits outside the HI SET range are ignored and will not be used.

For example:

HI SET value: 30.00

LOW SET value: 30.01 → error

Syntax MANU:ACW:CLOSet <NR2>

Query Syntax MANU:ACW:CLOSet?

Parameter/ Return parameter	<NR2>	0.000 ~ 41.99 (mA) [GPT-12XXX]
		0.000 ~ 110.9 (mA) [GPT-15XXX]

Example MANU:ACW:CLOS 20.0
Sets the ACW LO SET current to 20 mA.

Set →

→ Query

MANU:ACW:FILTer

Description In certain applications, it is suggested to enable Filter On, which indicates the activation of software judgment function that judges values by interval of every 100ms in case of instantaneous misjudgment on distorted waveforms.

Syntax MANU:ACW:FILTer {OFF|ON}

Query Syntax MANU:ACW:FILTer ?

Parameter/ Return parameter	ON	It actually turns Off the hardware Cutoff function and instead turns On the software judgment function.
	OFF	It remains the hardware Cutoff function On.

Example MANU:ACW:FILT ON
 Turns On the software judgment function.

Set →

MANU:ACW:TTIME

← Query

Description Sets or returns the ACW test time in seconds. The test must first be in ACW mode before this command can be used.

Note: An “Err” message will be shown on display if the Ramp Time + Test Time is > 240 seconds when the HI SET limit + REF is ≥ 30mA for GPT-12XXX or HI SET limit + REF is ≥ 80mA for GPT-15XXX. This applies to the ACW function only. An “TIME OVER 240s” message will be returned after using the query command “SYSTem:ERRor ?” in remote control.

Syntax	MANU:ACW:TTIME {<NR2> OFF}	
Query Syntax	MANU:ACW:TTIME?	
Parameter	<NR2>	0.3 ~ 999.9 seconds
	OFF	TIMER OFF
Return parameter	<NR2>	0.3 ~ 999.9 seconds
	TIME OFF	TIMER is OFF

Example MANU:ACW:TTIM 1
 Sets the ACW test time to 1 second.

Set →

→ Query

MANU:ACW:ARCFUNCTION

Description	Sets or returns the ACW ARC function. The test must first be in ACW mode before this command can be used. Note that this command is only workable when ARC SET>HI SET.	
Syntax	MANU:ACW:ARCFUNCTION	
Query Syntax	{OFF ON_CONT ON_STOP}	
	MANU:ACW:ARCFUNCTION?	
Parameter/ Return parameter	OFF	ARC function off
	ON_CONT	ARC function ON & CONT
	ON_STOP	ARC function ON & STOP
Example	MANU:ACW:ARCF OFF Sets the ACW ARC function off.	

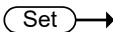
MANU:ACW:ARCCurrent

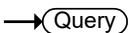

Description Sets or returns the ACW ARC current value in mA. ARC must be enabled before the ARC current can be set. The test must first be in ACW mode before this command can be used.

Syntax MANU:ACW:ARCCurrent <NR2>

Query Syntax MANU:ACW:ARCCurrent?

Parameter/	<NR2>	1.000 ~ 80.00mA [GPT-12XXX]
Return parameter		1.000 ~ 200.0mA [GPT-15XXX]

Example MANU:ACW:ARCC 1.233
Sets the ACW ARC value to 1.233 mA.

MANU:ACW:ARCSpeed



Description Sets or returns the ACW ARC speed. ARC must be enabled before the ARC speed can be set. The test must first be in ACW mode before this command can be used.

Syntax MANU:ACW:ARCSpeed {FAST|NORMAL|SLOW}

Query Syntax MANU:ACW:ARCSpeed?

Parameter/	FAST	ARC speed fast
Return parameter	NORMAL	ARC speed normal
	SLOW	ARC speed slow

Example MANU:ACW:ARCS SLOW
Sets the ACW ARC speed slow.

MANU:ACW:FREQuency



Description Sets or returns the ACW test frequency in Hz. The test must first be in ACW mode before this command can be used.

Syntax	MANU:ACW:FREQuency {50 60}	
Query Syntax	MANU:ACW:FREQuency?	
Parameter/	50	50 Hz
Return parameter	60	60 Hz
Example	MANU:ACW:FREQ 50 Sets the ACW test frequency to 50Hz.	

Set →

MANU:ACW:WAITtime

→ Query

Description	Sets or returns the ACW wait time in seconds. The test must first be in ACW mode before this command can be used.	
Syntax	MANU:ACW:WAITtime <NR2>	
Query Syntax	MANU:ACW:WAITtime?	
Parameter/	<NR2>	0 ~ 999.9 seconds
Return parameter		
Example	MANU:ACW:WAIT 10.1 Sets the ACW wait time to 10.1 s.	

Set →

MANU:ACW:RAMPdown

→ Query

Description	Sets or returns the ACW Ramp Down Time in seconds. The test must first be in ACW mode before this command can be used.	
Syntax	MANU:ACW:RAMPdown <NR2>	
Query Syntax	MANU:ACW:RAMPdown?	
Parameter/	<NR2>	0 ~ 999.9 seconds
Return parameter		
Example	MANU:ACW:RAMP 999.9 Sets the ramp down time to 999.9 seconds.	

MANU:ACW:GROundmode

Set →

→ Query

Description Sets or returns the ACW Ground Mode. The test must first be in ACW mode before this command can be used.

Syntax MANU:ACW:GROundmode {ON|OFF}

Query Syntax MANU:ACW:GROundmode?

Parameter/ ON ACW Ground Mode ON

Return parameter OFF ACW Ground Mode OFF

Example MANU:ACW:GRO OFF
Sets the ACW Ground Mode off.

Set →

→ Query

MANU:ACW:MAXHold

Description Sets or returns the ACW MAX Hold. The test must first be in ACW mode before this command can be used.

Syntax MANU:ACW:MAXHold {ON|OFF}

Query Syntax MANU:ACW:MAXHold?

Parameter/ ON ACW MAX Hold ON

Return parameter OFF ACW MAX Hold OFF

Example MANU:ACW:MAXH OFF
Sets the ACW MAX Hold off.

Set →

→ Query

MANU:ACW:PASShold

Description Sets or returns the duration of ACW PASS Hold in seconds. The test must first be in ACW mode before this command can be used.

Syntax MANU:ACW:PASShold {<NR2>|ON}

Query Syntax MANU:ACW:PASShold?

Parameter/ <NR2> 0 ~ 999.9 seconds

Return parameter ON Indefinite duration

Example **MANU:ACW:PASS 999.9**
 Sets the ACW PASS Hold time to 999.9 seconds.

MANU:ACW:REF

Set →

→ Query

Description Sets or returns the ACW reference value in uA or mA. The test must first be in ACW mode before this command can be used.

The ACW reference value shares the identical limit of HI SET value, which is 42mA at the maximum. For instance, when HI SET value is set 10mA, the reference value can therefore be set up to 32mA.

Note: An “Err” message will be shown on display if the Ramp Time + Test Time is > 240 seconds when the HI SET limit + REF is ≥ 30mA for GPT-12XXX or HI SET limit + REF is ≥ 80mA for GPT-15XXX. This applies to the ACW function only. An “TIME OVER 240s” message will be returned after using the query command “SYSTem:ERRor ?” in remote control.

Syntax **MANU:ACW:REF <NR2>**

Query Syntax **MANU:ACW:REF?**

Parameter/	<NR2>	0.000 ~ 41.99 (mA) [GPT-12XXX]
Return parameter		0.000 ~ 109.9 (mA) [GPT-15XXX]

Example **MANU:ACW:REF 40**
 Sets the ACW reference to 40 mA.

Set →

→ Query

MANU:ACW:INITvoltage

Description Sets or returns the ACW percentage of initial voltage. The test must first be in ACW mode before this command can be used.

Syntax **MANU:ACW:INITvoltage <NR1>**

Query Syntax **MANU:ACW:INITvoltage?**

Parameter/ Return parameter	<code><NR1></code>	0 ~ 99%
--------------------------------	--------------------------	---------

Example `MANU:ACW:INIT 87`
 Sets the ACW Initial Voltage to 87%.

(Set) →

MANU:ACW:CONtact

→ (Query)

Description Sets or returns the CONTACT CHK function on or off.
 Note: An “Err” message will be shown on display if the learned reference value is less than 30uA. An “LEARNING < 30uA” message will be returned after using the query command “SYSTem:ERRor ?” in remote control.

Syntax `MANU:ACW:CONtact {ON|OFF}`

Query Syntax `MANU:ACW:CONtact?`

Parameter/ Return parameter	ON	CONTACT CHK in ACW test ON
	OFF	CONTACT CHK in ACW test OFF

Example `MANU:ACW:CONt OFF`
 Sets the CONTACT CHK off in ACW test.

(Set) →

MANU:DCW:VOLTage

→ (Query)

Description Sets or returns the DCW voltage in kV. The test must first be in DCW mode before this command can be used.
 Note: An “Err” message will be shown on display if the DCW Voltage X (HI SET value + REF) is > 80 watts for GPT-12XXX or the DCW Voltage X HI SET value + REF is > 100 watts for GPT-15XXX. An “DC Over 50W” or “DC Over 100W” message will be returned after using the query command “SYSTem:ERRor ?” in remote control.

Syntax `MANU:DCW:VOLTage <NR2>`

Query Syntax `MANU:DCW:VOLTage?`

Parameter/ Return parameter	<NR2>	0.050 ~ 6.100 (kV)
--------------------------------	-------	--------------------

Example MANU:DCW:VOLT 6
 Sets the DCW voltage to 6 kV.

(Set) →

MANU:DCW:CHISet

→ (Query)

Description Sets or returns the DCW HI SET current value in milliamps. The test must first be in DCW mode before this command can be used.

Note: An "Err" message will be shown on display if the DCW Voltage X (HI SET value + REF) is > 50 watts for GPT-12XXX or the DCW Voltage X HI SET value + REF is > 100 watts for GPT-15XXX. An "DC Over 50W" or "DC Over 100W" message will be returned after using the query command "SYSTem:ERRor ?" in remote control.

Syntax MANU:DCW:CHISet <NR2>

Query Syntax MANU:DCW:CHISet?

Parameter/ Return parameter	<NR2>	0.001 ~ 11.00 (mA) [GPT-12XXX] 0.001 ~ 21.00 (mA) [GPT-15XXX]
--------------------------------	-------	--

Example MANU:DCW:CHIS 5
 Sets the DCW HI SET current to 5mA.

(Set) →

MANU:DCW:CLOSet

→ (Query)

Description Sets or returns the DCW LOW SET current value in milliamps. The LOW SET value must be less than the HI SET value. The test must first be in DCW mode before this command can be used.

The LOW SET range must use the HI SET range. If all the digits in the LOW SET range are outside the HI SET range, an Err will be produced. All digits outside the HI SET range are ignored and will not be used.

For example:

HI SET value: 10.99

LOW SET value: 11.00 → error

Syntax	MANU:DCW:CLOSet<NR2>	
Query Syntax	MANU:DCW:CLOSet?	
Parameter/	<NR2>	0.000 ~ 10.99 (mA) [GPT-12XXX]
Return parameter		0.000 ~ 20.99 (mA) [GPT-15XXX]
Example	MANU:DCW:CLOS 2.00 Sets the DCW LO SET current to 2mA.	

(Set) →

→ (Query)

MANU:DCW:TTIME

Description	Sets or returns the DCW test time in seconds. The test must first be in DCW mode before this command can be used.	
Syntax	MANU:DCW:TTIME {<NR2> OFF}	
Query Syntax	MANU:DCW:TTIME?	
Parameter	<NR2>	0.3 ~ 999.9 seconds
	OFF	TIMER OFF
Return parameter	<NR2>	0.3 ~ 999.9 seconds
	TIME OFF	TIMER is OFF
Example	MANU:DCW:TTIM 1 Sets the DCW test time to 1 second.	

MANU:DCW:ARCFUNCTION

Set →

→ Query

Description	Sets or returns the DCW ARC function. The test must first be in DCW mode before this command can be used. Note that this command is only workable when ARC SET>HI SET.	
Syntax	MANU:DCW:ARCFUNCTION	
Query Syntax	{OFF ON_CONT ON_STOP}	
	MANU:DCW:ARCFUNCTION?	
Parameter/ Return parameter	OFF	ARC function off
	ON_CONT	ARC function ON & CONT
	ON_STOP	ARC function ON & STOP
Example	MANU:DCW:ARCF OFF Sets the DCW ARC function off.	

Set →

→ Query

MANU:DCW:ARCCURRENT

Description	Sets or returns the DCW ARC current value in mA. ARC must be enabled to set the ARC current. The test must first be in DCW mode before this command can be used.	
Syntax	MANU:DCW:ARCCURRENT <NR2>	
Query Syntax	MANU:DCW:ARCCURRENT?	
Parameter/ Return parameter	<NR2>	1.000 ~ 20.00 (mA) [GPT-12XXX]
		1.000 ~ 40.00 (mA) [GPT-15XXX]
Example	MANU:DCW:ARCC 10 Sets the DCW ARC value to 10mA.	

Set →

→ Query

MANU:DCW:ARCSPEED

Description	Sets or returns the DCW ARC speed. ARC must be enabled before the ARC speed can be set. The test must first be in DCW mode before this command can be used.	
-------------	---	--

Syntax	MANU:DCW:ARCSpeed {FAST NORMAL SLOW}	
Query Syntax	MANU:DCW:ARCSpeed?	
Parameter/ Return parameter	FAST	ARC speed fast
	NORMAL	ARC speed normal
	SLOW	ARC speed slow
Example	MANU:DCW:ARCS SLOW Sets the DCW ARC speed slow.	

MANU:DCW:WAITtime

Set →

→ Query

Description	Sets or returns the DCW wait time in seconds. The test must first be in DCW mode before this command can be used.	
Syntax	MANU:DCW:WAITtime <NR2>	
Query Syntax	MANU:DCW:WAITtime?	
Parameter/ Return parameter	<NR2>	0 ~ 999.9 seconds
Example	MANU:DCW:WAIT 10.1 Sets the DCW wait time to 10.1 s.	

Set →

→ Query

MANU:DCW:RAMPdown

Description	Sets or returns the DCW Ramp Down Time in seconds. The test must first be in DCW mode before this command can be used.	
Syntax	MANU:DCW:RAMPdown <NR2>	
Query Syntax	MANU:DCW:RAMPdown?	
Parameter/ Return parameter	<NR2>	0 ~ 999.9 seconds
Example	MANU:DCW:RAMP 999.9 Sets the DCW ramp down time to 999.9 seconds.	

MANU:DCW:GROundmode (Set) →
→ (Query)

Description	Sets or returns the DCW Ground Mode. The test must first be in DCW mode before this command can be used.	
Syntax	MANU:DCW:GROundmode {ON OFF}	
Query Syntax	MANU:DCW:GROundmode?	
Parameter/ Return parameter	ON	DCW Ground Mode ON
	OFF	DCW Ground Mode OFF
Example	MANU:DCW:GRO OFF Sets the DCW Ground Mode off.	

MANU:DCW:MAXHold (Set) →
→ (Query)

Description	Sets or returns the DCW MAX Hold. The test must first be in DCW mode before this command can be used.	
Syntax	MANU:DCW:MAXHold {ON OFF}	
Query Syntax	MANU:DCW:MAXHold?	
Parameter/ Return parameter	ON	DCW MAX Hold ON
	OFF	DCW MAX Hold OFF
Example	MANU:DCW:MAXH OFF Sets the DCW MAX Hold off.	

MANU:DCW:PASShold (Set) →
→ (Query)

Description	Sets or returns the duration of DCW PASS Hold. The test must first be in DCW mode before this command can be used.	
Syntax	MANU:DCW:PASShold {<NR2> ON}	
Query Syntax	MANU:DCW:PASShold?	
Parameter/ Return parameter	<NR2>	0 ~ 999.9 seconds
	ON	Indefinite duration

Example MANU:DCW:PASS 999.9
 Sets the DCW PASS Hold time to 999.9 seconds.

MANU:DCW:REF

Set →

→ Query

Description Sets or returns the DCW reference value in uA or mA. The test must first be in DCW mode before this command can be used.

The DCW reference value shares the identical limit of HI SET value, which is 11mA at the maximum. For instance, when HI SET value is set 5mA, the reference value can therefore be set up to 6mA.

Note: An “Err” message will be shown on display if the DCW Voltage X (HI SET value + REF) is > 50 watts for GPT-12XXX or the DCW Voltage X HI SET value + REF is > 100 watts for GPT-15XXX. An “DC Over 50W” or “DC Over 100W” message will be returned after using the query command “SYSTem:ERRor ?” in remote control.

Syntax	MANU:DCW:REF <NR2>
Query Syntax	MANU:DCW:REF?
Parameter/ Return parameter	<NR2> 0.000 ~ 10.99 (mA) [GPT-12XXX] 0.000 ~ 20.99 (mA) [GPT-15XXX]

Example MANU:DCW:REF 10
 Sets the DCW reference to 10 mA.

MANU:DCW:INITvoltage

Set →

→ Query

Description Sets or returns the DCW percentage of initial voltage. The test must first be in DCW mode before this command can be used.

Syntax	MANU:DCW:INITvoltage <NR1>
Query Syntax	MANU:DCW:INITvoltage?
Parameter/ Return parameter	<NR1> 0 ~ 99%

Example MANU:DCW:INIT 87
 Sets the DCW Initial Voltage to 87%.

Set →

MANU:DCW:CONtact

→ Query

Description Sets or returns the CONTACT CHK function on or off.
 Note: An “Err” message will be shown on display if the learned reference value is less than 30uA. An “LEARNING < 30uA” message will be returned after using the query command “SYSTem:ERRor ?” in remote control.

Syntax MANU:DCW:CONtact {ON|OFF}

Query Syntax MANU:DCW:CONtact?

Parameter/	ON	CONTACT CHK in DCW test ON
Return parameter	OFF	CONTACT CHK in DCW test OFF

Example MANU:DCW:CONt OFF
 Sets the CONTACT CHK off in DCW test.

Set →

MANU:DCW:FILTer

→ Query

Description In certain applications, it is suggested to enable Filter On, which indicates the activation of software judgment function that judges values by interval of every 100ms in case of instantaneous misjudgment on distorted waveforms.

Syntax MANU:DCW:FILTer {OFF|ON}

Query Syntax MANU:DCW:FILTer ?

Parameter/	ON	It actually turns Off the hardware Cutoff function and instead turns On the software judgment function.
Return parameter	OFF	It remains the hardware Cutoff function On.

Example MANU:DCW:FILt ON
 Turns On the software judgment function.



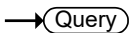

MANU:IR:VOLTage

Description	Sets or returns the IR voltage in kV. The test must first be in IR mode before this command can be used.
Syntax	MANU:IR:VOLTage <NR2>
Query Syntax	MANU:IR:VOLTage?
Parameter/ Return parameter	<NR2> 0.05 ~ 1.2 (0.05kV to 1.2kV: steps of .05)
Example	MANU:IR:VOLT 1 Sets the IR voltage to 1 kV.





MANU:IR:RHISet

Description	Sets or returns the IR HI SET resistance value in MΩ or GΩ. The test must first be in IR mode before this command can be used.
Syntax	MANU:IR:RHISet <NR2> NULL
Query Syntax	MANU:IR:RHISet?
Parameter/ Return parameter	<NR2> 000.2M ~ 999.9M (Ω) 1.000G ~ 9.999G (Ω) 10.00G ~ 50.00G (Ω)
	NULL Sets the HI SET value to OFF.
Example	MANU:IR:RHIS 10M Sets the IR HI SET resistance to 10 MΩ.



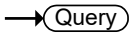

MANU:IR:RLOSet

Description	Sets or returns the IR LO SET resistance value in MΩ or GΩ. The LO SET value must be less than the HI SET value. The test must first be in IR mode before this command can be used.
-------------	---

Syntax	MANU:IR:RLOSet<NR2>
Query Syntax	MANU:IR:RLOSet?
Parameter/ Return parameter	<NR1> 000.1M ~ 999.9M (Ω) 1.000G ~ 9.999G (Ω) 10.00G ~ 50.00G (Ω)
Example	MANU:IR:RLOS 10M Sets the IR LO SET resistance to 10M Ω .

Set →

MANU:IR:TTIME

→ Query

Description	Sets or returns the IR test time in seconds. The test must first be in IR mode before this command can be used.
Syntax	MANU:IR:TTIME <NR2>
Query Syntax	MANU:IR:TTIME?
Parameter/ Return parameter	<NR2> 0.3 ~ 999.9 seconds
Example	MANU:IR:TTIM 1 Sets the IR test time to 1 second.

Set →

MANU:IR:WAITtime

→ Query

Description	Sets or returns the IR wait time in seconds. The test must first be in IR mode before this command can be used.
Syntax	MANU:IR:WAITtime <NR2>
Query Syntax	MANU:IR:WAITtime?
Parameter/ Return parameter	<NR2> 0 ~ 999.9 seconds
Example	MANU:IR:WAIT 10.1 Sets the IR wait time to 10.1 s.

Set →

MANU:IR:RAMPdown

→ Query

Description	Sets or returns the IR Ramp Down Time in seconds. The test must first be in IR mode before this command can be used.
Syntax	MANU:IR:RAMPdown <NR2>
Query Syntax	MANU:IR:RAMPdown?
Parameter/ Return parameter	<NR2> 0 ~ 999.9 seconds
Example	MANU:IR:RAMP 999.9 Sets the IR ramp down time to 999.9 seconds.

MANU:IR:GROundmode

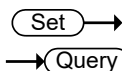

Description	Sets or returns the IR Ground Mode. The test must first be in IR mode before this command can be used.
Syntax	MANU:IR:GROundmode {ON OFF}
Query Syntax	MANU:IR:GROundmode?
Parameter/ Return parameter	ON IR Ground Mode ON OFF IR Ground Mode OFF
Example	MANU:IR:GRO OFF Sets the IR Ground Mode off.

MANU:IR:MAXHold

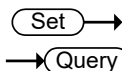

Description	Sets or returns the IR MAX Hold. The test must first be in IR mode before this command can be used.
Syntax	MANU:IR:MAXHold {ON OFF}
Query Syntax	MANU:IR:MAXHold?
Parameter/ Return parameter	ON IR MAX Hold ON OFF IR MAX Hold OFF

Example

MANU:IR:MAXH OFF

Sets the IR MAX Hold off.

MANU:IR:PASShold

Set →

→ Query

Description Sets or returns the duration of IR PASS Hold. The test must first be in IR mode before this command can be used.

Syntax MANU:IR:PASShold {<NR2>|ON}

Query Syntax MANU:IR:PASShold?

Parameter/ <NR2> 0 ~ 999.9 seconds

Return parameter ON Indefinite duration

Example MANU:IR:PASS 999.9

Sets the IR PASS Hold time to 999.9 seconds.

Set →

MANU:IR:REF

→ Query

Description Sets or returns the IR reference value in M Ω or G Ω . The test must first be in IR mode before this command can be used.

Syntax MANU:IR:REF <NR2>

Query Syntax MANU:IR:REF?

Parameter/ <NR2> 000.0M ~ 999.9M (Ω)

Return parameter 1.000G ~ 9.999G (Ω)

10.00G ~ 50.00G (Ω)

Example MANU:IR:REF 900M

Sets the IR reference to 900 M Ω .

MANU:IR:MODE

Set →

→ Query

Description	Sets or returns the IR Mode in IR. The test must first be in IR mode before this command can be used.	
Syntax	MANU:IR:MODE	
Query Syntax	{STOP_ON_FAIL STOP_ON_PASS TIMER}	
	MANU:IR:MODE?	
Parameter/ Return parameter	STOP_ON_FAIL	IR Mode in Stop On FAIL
	STOP_ON_PASS	IR Mode in Stop On PASS
	TIMER	IR Mode in Timer
Example	MANU:IR:MODE TIMER Sets the IR Mode in Timer setting.	

Set →

→ Query

MANU:IR:CONtact

Description	Sets or returns the CONTACT CHK function on or off. Note: An "Err" message will be shown on display if the learned reference value is less than 30uA. An "LEARNING < 30uA" message will be returned after using the query command "SYSTem:ERRor ?" in remote control.	
Syntax	MANU:IR:CONtact {ON OFF}	
Query Syntax	MANU:IR:CONtact?	
Parameter/ Return parameter	ON	CONTACT CHK in IR test ON
	OFF	CONTACT CHK in IR test OFF
Example	MANU:IR:CONt OFF Sets the CONTACT CHK off in IR test.	

Set →

→ Query

MANU:IR:FILTer

Description	Sets or returns the FILTER function for IR test.	
Syntax	MANU:IR:FILT {OFF LEVEL1 LEVEL2 LEVEL3	
Query Syntax	LEVEL4 LEVEL5 LEVEL6 LEVEL7 LEVEL8 LEVEL9 LEVEL10}	
	MANU:IR:FILT?	
Parameter/ Return parameter	OFF	FILTER in IR test Off
	LEVEL 1	FILTER in IR test Level 1
	LEVEL 2	FILTER in IR test Level 2
	LEVEL 3	FILTER in IR test Level 3
	LEVEL 4	FILTER in IR test Level 4
	LEVEL 5	FILTER in IR test Level 5
	LEVEL 6	FILTER in IR test Level 6
	LEVEL 7	FILTER in IR test Level 7
	LEVEL 8	FILTER in IR test Level 8
	LEVEL 9	FILTER in IR test Level 9
	LEVEL 10	FILTER in IR test Level 10
Example	MANU:IR:FILT OFF Sets the FILTER off in IR test.	

Set →

→ Query

MANU:IR:GNDoffset

Description	Sets or returns the GND Offset function for IR test.	
Syntax	MANU:IR:GNDoffset {ON OFF}	
Query Syntax	MANU:IR:GNDoffset?	
Parameter/ Return parameter	ON	GDN Offest in IR test On
	OFF	GDN Offest in IR test Off
Example	MANU:IR:GND OFF Sets the GND Offest off in IR test.	

Set →

MANU:GB:CURRent

→ Query

Description Sets or returns the GB current in A. The test must first be in GB mode before this command can be used.

Syntax MANU:GB:CURRent <NR2>

Query Syntax MANU:GB:CURRent?

Parameter/Return parameter <NR2> 3.00~33.00

Example MANU:GB:CURR 3.00
Sets the GB current to 3.00A.

Set →

MANU:GB:RHISet

→ Query

Description Sets or returns the GB HI SET resistance value in mΩ. The test must first be in GB mode before this command can be used.

Syntax MANU:GB:RHISet <NR2>

Query Syntax MANU:GB:RHISet?

Parameter/Return parameter <NR2> 000.1 ~ 650.0 (mΩ)

Example MANU:GB:RHIS 100.0
Sets the GB HI SET value to 100mΩ.

 **Note**

If the GB current x (HI SET resistance + REF) > 7.2V, an “Err” message will be shown on display. And an “GBV > 7.2V” message will be returned after using the query command “SYSTem:ERRor ?” in remote control.

MANU:GB:RLOSet
 →
 →

Description Sets or returns the GB LOW SET resistance value in mΩ. The LOW SET value must be less than the HI SET value. The test must first be in GB mode before this command can be used.

Syntax MANU:GB:RLOSet<NR2>

Query Syntax MANU:GB:RLOSet?

Parameter/Return parameter <NR2> 0.000 ~ 649.9 (mΩ)

Example MANU:GB:RLOS 50
Sets the GB LO SET resistance to 50mΩ.

MANU:GB:TTIMe
 →
 →

Description Sets or returns the GB test time in seconds. The test must first be in GB mode before this command can be used.

Syntax MANU:GB:TTIMe <NR2>

Query Syntax MANU:GB:TTIMe?

Parameter/Return parameter <NR2> 0.3 ~ 999.9 seconds

Example MANU:GB:TTIM 1
Sets the GB test time to 1 second.

MANU:GB:FREQuency
 →
 →

Description Sets or returns the GB test frequency in Hz. The test must first be in GB mode before this command can be used.

Syntax MANU:GB:FREQuency {50|60}

Query Syntax MANU:GB:FREQuency?

Parameter/Return parameter 50 50 Hz

Return parameter 60 60 Hz

Example MANU:GB:FREQ 50
Sets the GB test frequency to 50Hz.

Set →

MANU:GB:CONtact

→ Query

Description Sets or returns the GB Contact Time in seconds. The test must first be in GB mode before this command can be used.

Syntax MANU:GB:CONtact <NR2>

Query Syntax MANU:GB:CONtact?

Parameter/ Return parameter <NR2> 0 ~ 999.9 seconds

Example MANU:GB:CONtact 999.9
Sets the GB Contact time to 999.9 seconds.

Set →

MANU:GB:GRoundmode

→ Query

Description Sets or returns the GB Ground Mode. The test must first be in GB mode before this command can be used.

Syntax MANU:GB:GRoundmode {ON|OFF}

Query Syntax MANU:GB:GRoundmode?

Parameter/ Return parameter ON GB Ground Mode ON
OFF GB Ground Mode OFF

Example MANU:GB:GRo OFF
Sets the GB Ground Mode off.

Set →

MANU:GB:MAXHold

→ Query

Description Sets or returns the GB MAX Hold. The test must first be in GB mode before this command can be used.

Syntax	MANU:GB:MAXHold {ON OFF}	
Query Syntax	MANU:GB:MAXHold?	
Parameter/ Return parameter	ON OFF	GB MAX Hold ON GB MAX Hold OFF
Example	MANU:GB:MAXH OFF Sets the GB MAX Hold off.	

Set →

→ Query

MANU:GB:PASShold

Description	Sets or returns the duration of GB PASS Hold. The test must first be in GB mode before this command can be used.	
Syntax	MANU:GB:PASShold {<NR2> ON}	
Query Syntax	MANU:GB:PASShold?	
Parameter/ Return parameter	<NR2> ON	0 ~ 999.9 seconds Indefinite duration
Example	MANU:GB:PASS 999.9 Sets the GB PASS Hold time to 999.9 seconds.	

Set →

→ Query

MANU:GB:REF

Description	Sets or returns the GB reference value in mΩ. The test must first be in GB mode before this command can be used. Beware that when ISET x (HIEST + REF) is greater than 7.2V, an “Err” message will be shown on display. And an “GBV > 7.2V” message will be returned after using the query command “SYSTem:ERRor ?” in remote control.	
Syntax	MANU:GB:REF <NR2>	
Query Syntax	MANU:GB:REF?	
Parameter/ Return parameter	<NR2>	0.000 ~ 650.0 (mΩ)

Example MANU:GB:REF 100
 Sets the GB reference to 100 mΩ.

Set →

MANU:GB:ZERocheck

→ Query

Description Performs the zero check function. The test must first be in GB mode and in the Ready Status before this command can be used.

See page 70 for details on the ZERO function.

Syntax MANU:GB:ZERocheck {ON|OFF}

Query Syntax MANU:GB:ZERocheck?

Parameter/	ON	Zero function is active.
Return parameter	OFF	Zero function is not active.

Example MANU:GB:ZER OFF
 Activates the GB ZERO function.

Set →

MANU:CONTInuity:RHISet

→ Query

Description Sets or returns the CONT HI SET resistance value in Ω. The test must first be in CONT mode before this command can be used.

Syntax MANU:CONTInuity:RHISet <NR2>

Query Syntax MANU:CONTInuity:RHISet?

Parameter/	<NR2>	00.01 ~ 80.00 Ω
Return parameter		

Example MANU:CONT:RHIS 30.0
 Sets the CONT HI SET resistance to 30 Ω.

MANU:CONTInuity:RLOSet

Set →

→ Query

Description Sets or returns the CONT LOW SET resistance value in Ω. The LOW SET value must be less than the HI SET value. The test must first be in CONT mode before this command can be used.

The LOW SET range must use the HI SET range. If all the digits in the LOW SET range are outside the HI SET range, an Err message will be produced. All digits outside the HI SET range are ignored and will not be used.

For example:

HI SET value: 10.00

LOW SET value: 10.01 → error

Syntax	MANU:CONTInuity:RLOSet <NR2>
Query Syntax	MANU:CONTInuity:RLOSet?
Parameter/ Return parameter	<NR2> 00.00 ~ 79.99 Ω
Example	MANU:CONT:RLOS 20.0 Sets the CONT LO SET resistance to 20 Ω.

Set →

MANU:CONTInuity:TTIME

→ Query

Description Sets or returns the CONT test time in seconds. The test must first be in CONT mode before this command can be used.

Syntax	MANU:CONTInuity:TTIME <NR2>
Query Syntax	MANU:CONTInuity:TTIME?
Parameter	<NR2> 0.3 ~ 999.9 seconds
Return parameter	<NR2> 0.3 ~ 999.9 seconds
Example	MANU:CONT:TTIM 1 Sets the CONT test time to 1 second.

MANU:CONTInuity:PASShold

Set →

→ Query

Description Sets or returns the duration of CONT PASS Hold. The test must first be in CONT mode before this command can be used.

Syntax MANU:CONTInuity:PASShold {<NR2>|ON}

Query Syntax MANU:CONTInuity:PASShold?

Parameter/ <NR2> 0 ~ 999.9 seconds

Return parameter ON Indefinite duration

Example MANU:CONT:PASS 999.9

Sets the CONT PASS Hold time to 999.9 seconds.

Set →

→ Query

MANU:CONTInuity:REF

Description Sets or returns the CONT reference value in Ω. The test must first be in CONT mode before this command can be used.

Note: when HI SET+REF VALUE is over 80 Ω, an "Err" message will be shown on display. And an "CONT Setting Over 8V" message will be returned after using the query command "SYSTEM:ERRor?" in remote control.

Syntax MANU:CONTInuity:REF <NR2>

Query Syntax MANU:CONTInuity:REF?

Parameter/ <NR2> 00.00 ~ 79.99 Ω

Return parameter

Example MANU:CONT:REF 0.01

Sets the CONT reference to 00.01 Ω.

MANU:CONTinuity:ZEROCHECK

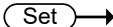
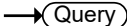
Description Performs the zero check function. The test must first be in CONT mode and in the Ready Status before this command can be used.

See page 70 for details on the ZERO function.

Syntax MANU:CONTinuity:ZEROCHECK {ON|OFF}

Query Syntax MANU:CONTinuity:ZEROCHECK?

Parameter/ ON Zero function is active.

Return parameter OFF Zero function is not active.

Example MANU:CONT:ZEROCHECK OFF

Deactivates the CONT ZERO function.

Auto Commands

AUTO:STEP 246
 AUTO:NAME 247
 AUTO:EDIT:ADD 248
 AUTO<x>:EDIT:HOLD..... 249
 AUTO<x>:EDIT:SKIP 249
 AUTO:EDIT:DEL 250
 AUTO:TEST:RETurn..... 250
 AUTO:EDIT:SHOW 251

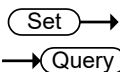

AUTO:STEP

Description	Sets or queries the AUTO number (automatic test number).
Syntax	AUTO:STEP <NR1>
Query Syntax	AUTO:STEP?
Parameter/ Return parameter	<NR1> 1~100
Example	AUTO:STEP 100 Sets the current AUTO number to 100

Set →

→ Query

AUTO:NAME

Description	Sets or returns the AUTO name for the selected automatic test. The test must be in AUTO mode before this command can be used.	
	Note only alphanumeric characters (A-Z, a-z, 0-9) and the “_” underscore character can be used to set the AUTO test name.	
Syntax	AUTO:NAME <"string">	
Query Syntax	AUTO:NAME?	
Parameter/ Return parameter	<"string">	10 character string.
Example	AUTO:NAME "program1" Sets the AUTO name to "program1".	

AUTO:EDIT:ADD

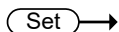

Description	Add the selected MANU test to the current AUTO number.
Syntax	AUTO:EDIT:ADD {<NR1> CON}
Parameter/	<NR1> 1~100
	CON Continuous step
Example	AUTO:EDIT:ADD 7 Adds MANU STEP 007 to the current AUTO number.



Note

An “Err” message will be shown on display when 10 groups have been added into AUTO already and user still sends the command “AUTO:EDIT:ADD”. An “Auto Step Add Full” message will be returned after using the query command SYSTem:ERRor ?.

When “CON” is configured within AUTO and user still sends the command “AUTO:EDIT:ADD”, an “Err” message will be shown on display. An “This Is Last Step” message will be returned after using the query command SYSTem:ERRor ?.

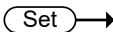
AUTO<x>:EDIT:HOLD



Description	Sets or returns the actions for STEP HOLD of each MANU STEP in AUTO test.	
Syntax	AUTO<x>:EDIT:HOLD {PH_FH PH_FS PH_FC PC_FH PC_FS PC_FC PC_FC_PREVOLT PC_FS_PREVOLT}	
Query Syntax	AUTO<x>:EDIT:HOLD?	
Parameter/	<x>	MAMU step 1 ~ 10
Return parameter	PH_FH	Sets Pass Hold & Fail Hold action
	PH_FS	Sets Pass Hold & Fail Stop action
	PH_FC	Sets Pass Hold & Fail Continue action
	PC_FH	Sets Pass Continue & Fail Hold action
	PC_FS	Sets Pass Continue & Fail Stop action
	PC_FC	Sets Pass Continue & Fail Continue action
Example	<p>AUTO1:EDIT:HOLD PH_FH</p> <p>Sets the Pass Hold & Fail Hold action for MANU STEP 1 in the current AUTO test.</p>	

AUTO<x>:EDIT:SKIP



Description	Sets or returns the SKIP action for each MANU STEP in AUTO test.	
Syntax	AUTO<x>:EDIT:SKIP {ON OFF}	
Query Syntax	AUTO<x>:EDIT:SKIP?	
Parameter/	<x>	Sets MANU STEP from 1 - 10 for skip
Return parameter	ON	Turns SKIP action for the designated MANU STEP on
	OFF	Turns SKIP action for the designated MANU STEP off
Example	<p>AUTO1:EDIT:SKIP ON</p> <p>Enables SKIP function for MANU STEP 1 in AUTO test.</p>	

AUTO:EDIT:DEL

Set →

Description	Deletes the designated MANU STEP within the current AUTO test.	
Syntax	AUTO:EDIT:DEL {<NR1> ALL}	
Parameter	<NR1>	Deletes selected MANU STEP from 1 - 10
	ALL	Deletes all the MANU STEPs
Example	AUTO:EDIT:DEL 3 Deletes the MANU STEP 3 from the current AUTO test.	

AUTO:TEST:RETurn

→ Query

Description	Returns the number of AUTO test and MANU STEP that is being tested currently.	
Query Syntax	AUTO:TEST:RETurn?	
Return parameter	String	The returned string will be in the format of AUTO number followed by MANU STEP number. AUTO-XXX,STEP-XX
Example	AUTO:TEST:RET? AUTO-004,STEP-03 The MANU STEP-03 of AUTO-004 is being tested.	

AUTO:EDIT:SHOW

→ Query

Description Returns all the information of the current AUTO test page.

Query Syntax AUTO:EDIT:SHOW?

Return parameter String The returned strings will be shown in the way almost identical to the contents displayed on an AUTO test page.

Example AUTO:EDIT:SHOW?

```
>AUTO-001 AUTO_NAME
>STEP,MODE,V/I SET,HI SET ,LOW SET,STEP HOLD
>_____
>001 ,ACW ,0.100kV,1.000mA,000 uA,P.C/F.C
>001 ,ACW ,0.100kV,1.000mA,000 uA,P.C/F.C
>001 ,ACW ,0.100kV,1.000mA,000 uA,P.C/F.C
>001 ,ACW ,0.100kV,1.000mA,000 uA,P.C/F.C
>001 ,ACW ,0.100kV,1.000mA,000 uA,P.C/F.C
>001 ,ACW ,0.100kV,1.000mA,000 uA,P.C/F.C
>001 ,ACW ,0.100kV,1.000mA,000 uA,P.C/F.C
>001 ,ACW ,0.100kV,1.000mA,000 uA,P.C/F.C
>001 ,ACW ,0.100kV,1.000mA,000 uA,P.C/F.C
>001 ,ACW ,0.100kV,1.000mA,000 uA,P.C/F.C
>001 ,ACW ,0.100kV,1.000mA,000 uA,P.C/F.C
```

Sweep Commands

SWEEP:DATA:STATus	252
SWEEP:DATA:SHOW	252
SWEEP:GRAPH:SHOW	253

SWEEP:DATA:STATus

→ Query

Description	Returns the basic status of get data.
Query Syntax	SWEEP:DATA:STA?
Return parameter	<String> The returned string will be in the format below: STEP, TEST MODE, V SET, HI SET, TOTAL DATA
Example	SWEEP:DATA:STA? > STEP, MODE, V SET , HI SET , TOTAL DATA 000 , DCW , 0.450kV, 1.700mA, 00076

SWEEP:DATA:SHOW

→ Query

Description	Returns the full measured readings of get data.
Query Syntax	SWEEP:DATA:SHOW<NR1>
Return parameter	<NR1> 0~10000 0 stands for the full steps. 1~10000 indicates the designated step.
Example	SWEEP:DATA:SHOW 0 > TIMER , READ V, READ I 0000.1s , 0.003kV, 007uA 0000.2s , 0.008kV, 026uA 0000.3s , 0.019kV, 064uA 0000.4s , 0.028kV, 095uA 0000.5s , 0.037kV, 126uA 0000.6s , 0.045kV, 153uA

SWEEP:GRAPh:SHOW

Set →

→ Query

Description Displays or turns off Sweep graph on LCD screen. Also Returns if Sweep graph is shown on LCD.

Syntax SWEEP:GRAPh:SHOW {ON|OFF}

Query Syntax SWEEP:GRAPh:SHOW?

Parameter/ Return parameter	ON	To enable Sweep graph on LCD
	OFF	To disable Sweep graph on LCD
	?	Returns if Sweep graph is shown on LCD

Example SWEEP:GRAP:SHOW?
 > OFF
 Sweep graph is Not displayed on LCD screen.

Common Commands

*CLS.....	254
*IDN.....	254
*SRE.....	255

*CLS

Set →

Description	The *CLS command clears the internal registers and error message, if any.
Syntax	*CLS

*IDN

→ Query

Description	Queries the model number, serial number, and firmware version of the tester.		
Query Syntax	*IDN?		
Return parameter	<table> <tr> <td><string></td> <td>Returns the instrument identification as a string in the following format: >GPT-12004 ,GPT12000 ,V1.00 Model number : GPT-12004 Serial number :8 characters serial number Firmware version : V1.00</td> </tr> </table>	<string>	Returns the instrument identification as a string in the following format: >GPT-12004 ,GPT12000 ,V1.00 Model number : GPT-12004 Serial number :8 characters serial number Firmware version : V1.00
<string>	Returns the instrument identification as a string in the following format: >GPT-12004 ,GPT12000 ,V1.00 Model number : GPT-12004 Serial number :8 characters serial number Firmware version : V1.00		

***SRE** → Query

Description AUTO MODE only. Use this command to get measurement step number at the current point in time during AUTO MODE testing.

Query Syntax *SRE?

Return parameter <NR1> 00~50

Example *SRE?
 >5
 The current test step is number 5. This indicates that steps 1~4 have already been completed and the results for those steps can now be retrieved.

Remote Commands

*RMTOff255

***RMTOff** Set →

Description This command can be used to terminate a remote session. When this command is used "RMT" will no longer be displayed on the front panel, indicating that remote mode has been terminated.

Syntax *RMTOff

Special Functions

INTerlock:PIN.....256

INTerlock:PIN → Query

Description	Queries if the physical interlock pin is shorted or not.
Query Syntax	INTerlock:PIN?
Return parameter	<string> Returns: "PIN OFF": Interlock pin is Not shorted. or "PIN ON" Interlock pin is shorted.
Query Example	INT:PIN? >PIN ON Returns the Interlock pin is shorted.

Error Messages

Background The possible error messages returned from SYST:ERR? query are well listed below.

Error	Error Code
No Error	0
Command Error	20
Value Setting Error	21
String Setting Error	22
Query Error	23
MODE Error	24
TIME Error	25
DC Over 50W (GPT-12XXX)	26
DC Over 100W (GPT-15XXX)	26
GBV > 7.2V	27
ARC <= HI Set	28
HI Set => ARC	29
Voltage Setting Error	30
Current Setting Error	31
Current HI Set Error	32
Current LO Set Error	33
Resistance HI Set Error	34
Resistance LO Set Error	35
REF Setting Error	36
Frequency Setting Error	37
ARC Setting Error	38
RAMP Time Setting Error	39
TEST Time Setting Error	40
WAIT Time Setting Error	41
RAMP Down Setting Error	42
PASS Hold Setting Error	43
GB Contact Setting Error	44
Setting Over 200W	45
CONT Setting Over 8V	46
Auto Step Add Full	47
This Is The Last Step	48
Learning less than 30uA	49
USB DISK BUSY	50

Filter Setting Error	51
Read Buffer Error	70
Send Buffer Error	71

F AQ

-
- The tester will not turn on.
 - The panel keys are not working.
 - The measured value of IR, GB or Continuity test does not match the specification.
 - When I press the START button the tester will not start testing?

The tester will not turn on?

Ensure the power cord is connected. Check and make sure the fuse is not blown and properly installed. See page 262.

The panel keys are not working?

Ensure the tester is not in the SIGNAL I/O or Remote Control mode (page 138). If it is, refer to page 187 for how to return to front panel control. Also, if Key Lock is enabled, all panel keys except START and STOP are disabled. Refer to page 139 for details.

The measured value of IR test does not match the specification?

Make sure the tester is powered on for warm-up of at least 30 minutes, within +15°C~+35°C. This is necessary to stabilize the tester to match the specification. After warm-up, please proceed to Contact Check procedure.

The measured value of GB test does not match the specification?

Make sure the tester is powered on for warm-up of at least 30 minutes, within +15°C~+35°C. This is necessary to stabilize the

tester to match the specification. After warm-up, please proceed to Zero Check procedure. Refer to page 70 for details.

The measured value of Continuity test does not match the specification?

Make sure the tester is powered on for warm-up of at least 30 minutes, within +15°C~+35°C. This is necessary to stabilize the tester to match the specification. After warm-up, please proceed to Zero Check procedure. Refer to page 70 for details.

When I press the START button the tester will not start testing?

The tester must first be in the READY status before a test can be started. Ensure the tester displays READY before pressing the START button, page 88 (manual test), 116 (automatic test).

If Double Action is enabled, the START button must be pressed within 0.5 seconds after the STOP button is pressed, otherwise the tester will not start testing.

If Interlock is enabled, the interlock key must be inserted into the signal I/O port on the rear before a test starts. See page 181.

Lastly, if Start Click For 1 Second is enabled, it is required to press and hold the START button for 1 second above to initiate a test. Pressing the START button below 1 second will not start a test.

For more information, contact your local dealer or GWInstek at www.gwinstek.com / marketing@goodwill.com.tw.

APPENDIX

Fuse Replacement

Steps

1. Turn the instrument off.

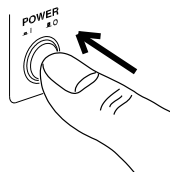

2. Remove the power cord.

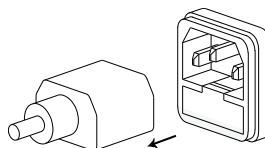

3. Remove the fuse socket using a flat screwdriver.

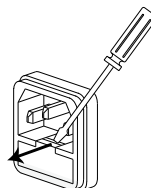

4. Replace the fuse in the fuse holder.

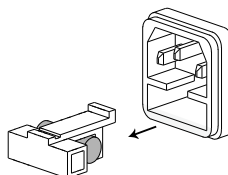

Fuse Rating

GPT-12000

T 4A, 250V

GPT-15000

T 10A, 250V

Tester Errors

The following test error messages highlighted in red may appear on the GPT-10000 display when completing a running test.

Test Error	Description
HI FAIL	Test result is beyond the HI SET value
LOW FAIL	Test result is below the LOW SET value
V OVER	Measured voltage is beyond the set value by 1.1 times
V LOW	Measured voltage is below the set value by 0.9 time
SHORT	Voltage short-circuit detected
GBI OVER	Measured current is beyond the set value by 1.1 times
GBI LOW	Measured current is below the set value by 0.9 time
GBV OVER	Measured GB voltage is beyond 7.2V
CONT V ERR	Measured CONT voltage is beyond 8.0V
ARC ERR	ARC abnormality detected
GFCI ERR	Ground current abnormality detected
SHORT (CONTACT CHK)	CONTACT CHK greater than HI Limit detected
OPEN (CONTACT CHK)	CONTACT CHK lower than LOW Limit detected

The following setup error messages highlighted in red may appear on the GPT-10000 display when abnormality occurs in the settings of MANU steps.

Setup Error	Description
TEST MODE ERROR	Setting error in ACW/DCW
VOLTAGE SET ERROR	Setting error in voltage
CURRENT SET ERROR	Setting error in current
MANU STEP ERROR	Setting error in MANU STEP value
MANU NAME ERROR	Setting error in MANU NAME
HI SET ERROR	Setting error in HI SET value
HISET <= LOWSET	Set value of HI SET is less than or equal to LOW SET value

HISET >= ARC	Set value of HI SET is greater than or equal to ARC SET value
LOW SET ERROR	Setting error in LOW SET
TEST TIME ERROR	Setting error in TEST TIME
RAMP TIME ERROR	Setting error in RAMP TIME
ARC FUNC ERROR	Setting error in ARC FUNC
ARC SET ERROR	Setting error in ARC SET
ARC SPEED ERROR	Setting error in ARC SPEED
FREQ SET ERROR	Setting error in FREQ of ACW/GB
WAIT >= TEST+RAMP	Setting error in WAIT TIME
GB CONTACT ERROR	Setting error in GB CONTACT
RAMP DOWN ERROR	Setting error in RAMP DOWN
GROUND ERROR	Setting error in GROUND MODE
MAX HOLD ERROR	Setting error in MAX HOLD
PASS HOLD ERROR	Setting error in PASS HOLD
REF SET ERROR	Setting error in REF VALUE
GBV OVER	Setting Error in ISET x (HI SET + REF) > 7.2V of GB Mode
INIT VSET ERROR	Setting error in INIT VOLTAGE
IR MODE ERROR	Setting error in IR MODE
DCW OVER 50W (GPT-12XXX)	Setting error in $V * I > 50W$ of DCW Mode
DCW OVER 100W (GPT-15XXX)	Setting error in $V * I > 100W$ of DCW Mode
GB OVER 200W	Setting error in $V * I > 200W$ of GB Mode
ZERO SET ERROR	Setting Error in ZERO CHECK
CONT. TEST V OVER	Setting Error in ISET(100mA) x (HI SET + REF) > 8V of CONT Mode
TIME OVER 240s (GPT-12XXX)	TIME OVER 240s is displayed when, under ACW test mode, HI SET is greater than 30mA and the RAMP TIME plus the TEST TIME setting is > 240 seconds.
TIME OVER 240s (GPT-15XXX)	TIME OVER 240s is displayed when, under ACW test mode, HI SET is greater than 80mA and the RAMP TIME plus the TEST TIME setting is > 240 seconds.

TEST TIME<0.5s	TEST TIME<0.5s is displayed when test time, under IR test mode with Ground mode ON, is below 0.5 second.
CONTACT ERROR	Setting error in CONTACT of ACW, DCW or IR.
LEARNING < 30uA	The learned reference value of CONTACT CHK is less than 30uA and thus CONTACT CHK function will be invalid.
FILTER SET ERROR	Setting error in IR Mode Filter

Factory Default Parameters

DISPLAY SET

Brightness	5
Language	ENGLISH

BUZZER

Volume	3
Key Sound	ON

INTERFACE

Interface	RS-232
Baud Rate	9600

CONTROL

Control By	Front Panel	
	SIGNAL IO -->	OUT1:READY
		OUT2:TEST
		OUT3:PASS
		OUT4:FAIL
		OUT5:FAIL_H
Double Action	OFF	
Key Lock	OFF	
Interlock	OFF	
Start Click For 1 Second	OFF	
Power GND Check	OFF	
Barcode Function Setting	Delete set data of 100 groups	

STATISTICS

TOTAL AMOUNT =	0
PASS AMOUNT =	0
FAIL AMOUNT =	0
ACW PASS DATA	0
ACW FAIL DATA	0
DCW PASS DATA	0
DCW FAIL DATA	0
IR PASS DATA	0
IR FAIL DATA	0
GB PASS DATA	0
GB FAIL DATA	0
CONT PASS DATA	0
CONT FAIL DATA	0

USB DISK

USB Disk Auto Data Save	OFF
File Name	Logfile_
Internal Memory Save	OFF

CONTACT CHK

Hi Limit	200%
Low Limit	50%
Learning	000 μ A

GPT-10000 Specifications

The specifications apply when the GPT-10000 is powered on for at least 30 minutes at 15°C~35°C.

Specifications

General

DISPLAY	7" color LCD	
MEMORY	AUTO/MANU mode 100 memory blocks total	
POWER SOURCE	AC 100V~240V ± 10%, 50Hz/60Hz	
POWER CONSUMPTION	GPT-15XXX	1000VA Max.
	GPT-12XXX	400VA Max.
ACCESSORIES	GPT-15XXX	Power cord x1 Quick Start Guide x1 User Manual x1 (CD) GHT-115 x1 for GPT-15001/2/3 GHT-115 x1, GTL-215 x1 for GPT-15004
	GPT-12XXX	Power cord x1 Quick Start Guide x1 User Manual x1 (CD) GHT-115 x1 for GPT-12001/2/3 GHT-115 x1, GTL-215 x1 for GPT-12004
DIMENSIONS & WEIGHT	GPT-15001	380(W) x 148(H) x 492(D), 17kg (Approx)
	GPT-15002	
	GPT-15003	
	GPT-15004	380(W) x 148(H) x 546(D), 21kg (Approx)
	GPT-12001	
	GPT-12002	380(W) x 148(H) x 436(D), 11kg (Approx)
GPT-12003		
GPT-12004	380(W) x 148(H) x 454(D), 15kg (Approx)	

Environment

Range	Temperature	Humidity
Warranty	15°C ~ 35°C	≤70% (No condensation)
Operation	0°C ~ 40°C	≤70% (No condensation)
Storage	-10°C ~ 70°C	≤85% (No condensation)
Installation Location	Indoors at an amplitude of up to 2000m.	

AC Withstanding Voltage

Output Voltage Range	0.050kV~ 5.000kV ¹	
Output Voltage Resolution	1V	
Output Voltage Accuracy	± (1% of setting +5V) with no load	
Maximum Rated Load(Table1)	GPT-15XXX	500VA (5kV/100mA)
	GPT-12XXX	200VA (5kV/40mA)
Maximum Rated Current	GPT-15XXX	100mA
		0.001mA~10mA(0.05kV≤V≤0.5kV) 0.001mA~100mA(0.5kV<V≤5kV)
	GPT-12XXX	40mA
		0.001mA~10mA(0.05kV≤V≤0.5kV) 0.001mA~40mA(0.5kV<V≤5kV)
Output Voltage Waveform	Sine wave	
Frequency	50 Hz / 60 Hz	
Voltage Regulation	± (1% +5V)[Maximum rated load →no load]	
Voltmeter Accuracy	± (1% of reading+ 5 V)	
Current Measurement Range	GPT-15XXX	0.001mA~100.0mA
	GPT-12XXX	0.001mA~40.00mA
Current Best Resolution	GPT-15XXX	1μA
		1μA (1μA~9.999mA) 10μA(10.00mA~99.99mA) 100μA(100.0mA)
	GPT-12XXX	1μA
		1μA (1μA~9.999mA) 10μA(10.00mA~40.00mA)
Current Measurement Accuracy	± (1.5% of reading+30μA)	
Current Offset	60μA Maximum	
Judgment Accuracy	± (3% of setting+30μA)	
Window Comparator Method	Yes	
ARC DETECT	Yes	
Rise-time Control Function	Yes	
RAMP TIME (Rise Time)	0.1~999.9s	
Fall-time Control Function	Yes	
RAMP DOWN Time	0.0~999.9s	
TIMER (Test Time) ²	OFF, 0.3s~999.9s	
TIMER Accuracy	+/- (100ppm+20ms)	
GND	ON/OFF	
WAIT TIME	0.0~999.9s	

¹ At least ramp 0.3 seconds is needed to reach a set voltage of 50V/10mA.

² Timer can only be turned off when the upper current is set below 30mA. (GPT-12XXX)

³ Timer can only be turned off when the upper current is set below 80mA. (GPT-15XXX)

DC Withstanding Voltage

Output Voltage Range	0.050kV~ 6.000kV ¹	
Output Voltage Resolution	1V	
Output Voltage Accuracy	±(1% of setting +5V) With no load	
Maximum Rated Load	GPT-15XXX	100W(5kV/20mA)
	GPT-12XXX	50W(5kV/10mA)
Maximum Rated Current	GPT-15XXX	20mA
		0.001mA~2mA(0.05kV≤V≤0.5kV)
	GPT-12XXX	10mA
		0.001mA~2mA(0.05kV≤V≤0.5kV)
		0.001mA~10mA(0.5kV<V≤6kV)
Voltmeter Accuracy	± (1% of reading+ 5 V)	
Voltage Regulation	± (1% +5V)[Maximum rated load ->no load]	
Current Measurement Range	GPT-15XXX	0.001mA- 20.00mA
	GPT-12XXX	0.001mA-10.00mA
Current Measurement Best Resolution	GPT-15XXX	0.1μA
		0.1μA (0.1μA~999.9μA)
		1μA (1μA~9.999mA)
	GPT-12XXX	10μA (20.00mA)
		0.1μA
		0.1μA (0.1μA~999.9μA)
		1μA(1μA~9.999mA)
		10μA(10.00mA)
Current Measurement Accuracy	±(1.5% of reading+3μA) when I<1mA	
	±(1.5% of reading+30μA) when I≥1mA	
Current Offset	5μA Maximum	
Judgment Accuracy	± (3% of setting+30μA)	
Window Comparator Method	Yes	
ARC DETECT	Yes	
Rise-time Control Function	Yes	
RAMP TIME (Rise Time)	0.1~999.9s	
Fall-time Control Function	Yes	
RAMP DOWN Time	0.0~999.9s	
TIMER (Test Time)	OFF, 0.3s~999.9s	
TIMER Accuracy	+/- (100ppm+20ms)	
GND	ON/OFF	
WAIT TIME	0.0~999.9s	
Maximum Capacitive Load DC Mode	1μF	

¹ At least ramp 0.3 seconds is needed to reach a set voltage of 50V/2mA.

Insulation Resistance Test

Output Voltage	50V-1200V	
Output Voltage Resolution	50V	
Output Voltage Accuracy	±(1% of setting +5V) with no load	
Resistance Measurement Range	0.1MΩ~50GΩ	
Test Voltage	Measurement Range	Accuracy
50V≤V≤450V	0.1MΩ~1MΩ	5% of reading + 3 count
	1.1MΩ~50MΩ	5% of reading + 1 count
	50.1MΩ~2GΩ	10% of reading + 1 count
500V≤V≤1200V	0.1MΩ~1MΩ	5% of reading + 3 count
	1.1MΩ~500MΩ	5% of reading + 1 count
	500.1MΩ~9.999GΩ	10% of reading + 1 count
	10G~50GΩ	20% of reading + 1 count ¹
Test Voltage	Display Range	
50V≤V≤100V	0.100MΩ~10.00GΩ	
150V≤V≤450V	0.100MΩ~20.00GΩ	
500V≤V≤1200V	0.100MΩ~50.00GΩ	
Voltage regulation	± (1% +5V) [Maximum rated load ->no load	
Voltmeter Accuracy	±(1% of reading +5V)	
Resistance Judgment Range	0.1MΩ~50GΩ	
Test Voltage	Judgment Range	Accuracy
50V≤V≤450V	0.1MΩ~1MΩ	5% of setting + 3 count
	1MΩ~50MΩ	5% of setting + 1 count
	51MΩ~2GΩ	10% of setting + 1 count
500V≤V≤1200V	0.1MΩ~1MΩ	5% of setting + 3 count
	1MΩ~500MΩ	5% of setting + 1 count
	501MΩ~9.999GΩ	10% of setting + 1 count
	10G~50GΩ	20% of setting + 1 count ¹
Short-Circuit Current	10mA max.	
Output Impedance	2kΩ	
Window Comparator Method	Yes	
Rise-time Control Function	Yes	
RAMP TIME (Rise Time)	0.1~999.9s	
Fall-time Control Function	Yes	
RAMP DOWN Time	0.0~999.9s	
WAIT TIME	0.0~999.9s	
TIMER (Test Time)	0.3s~999.9s ²	
TIMER Accuracy	+/- (100ppm+20ms)	
GND	ON/OFF	

NOTE: It is required to implement GND OFFSET action when IR Ground Mode is On.

¹ When IR Ground Mode is On, the maximum 30Gohm measurement range is guaranteed.

² When IR Ground Mode is On, test time starts from 0.5 second.

Ground Bond Test

Output Current Range	3.00A~32.00A
Output Current Accuracy	$\pm(1\% \text{ of setting} + 0.2\text{A})$ when $3\text{A} \leq I \leq 8\text{A}$ $\pm(1\% \text{ of setting} + 0.05\text{A})$ $8\text{A} < I \leq 32\text{A}$
Output Current Resolution	0.01A
Test Voltage	Approximately max. 8VAC (open-circuit)
Frequency	50Hz/60Hz selectable
Ohmmeter Measurement Range	1m Ω ~ 650m Ω

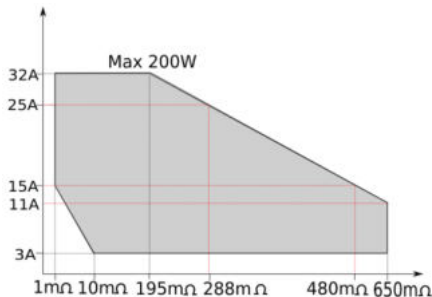

Ohmmeter Measurement Resolution	0.1m Ω
Ohmmeter Measurement Accuracy	$\pm(1\% \text{ of reading} + 2\text{m}\Omega)$
Ohmmeter Judgment Accuracy	$\pm(1\% \text{ of setting} + 2\text{m}\Omega)$
Window Comparator Method	Yes
TIMER (Test Time)	0.3s~999.9s
TIMER Accuracy	+/- (100ppm+20ms)
GND	ON/OFF

Continuity Test

Output Current	100mA(DC)
Ohmmeter Measurement Range	0.10 Ω ~70.00 Ω
Ohmmeter Measurement Resolution	0.01 Ω
Ohmmeter Measurement Accuracy	$\pm(10\% \text{ of reading} + 2\Omega)$
Ohmmeter Judgment Accuracy	$\pm(10\% \text{ of setting} + 2\Omega)$
Window Comparator Method	Yes
TIMER (Test Time)	0.3s~999.9s
TIMER Accuracy	+/- (100ppm+20ms)

Interface

REMOTE (Remote terminal)	Yes
SIGNAL IO	Yes
RS232	Yes
USB (Device)	Yes (USB 2.0)
Rear Output	Yes
USB (Host) for data output port	Yes (USB 2.0)
GPIB	Yes (Optional)
LAN	Yes (Optional)
Barcode Reader USB port	Yes (USB-VCP)

Table 1: Output Limitation in Withstanding Voltage Testing

Function	Upper Current	Pause	Output Time
AC	GPT- 80mA ≤ I ≤ 15XXX	At least as long as the output time	Maximum 240 seconds
	0.001mA ≤ I < 80mA	Not necessary	Continuous output possible
	GPT- 30mA ≤ I ≤ 12XXX	At least as long as the output time	Maximum 240 seconds
DC	0.001mA ≤ I < 30mA	Not necessary	Continuous output possible
	GPT- 0.001mA ≤ I ≤ 15XXX	Not necessary	Continuous output possible
	GPT- 0.001mA ≤ I ≤ 12XXX	Not necessary	Continuous output possible
GB	15A < I ≤ 32A	At least as long as the output time	999.9 seconds
	3A ≤ I ≤ 15A	Not necessary	999.9 seconds

NOTE: Output Time = Ramp Time + Test Time.

Table 2: GPT-10000 capacitive load table

	Test Condition			Maximum Capacitive Load
	Test Voltage DCW	HI-SET Current	RAMP Time ↗	
1	1.000kV	$I \geq 10.00\text{mA}$	$T \geq 1.0\text{s}$	4.7 μF
2	2.000kV	$I \geq 7.00\text{mA}$	$T \geq 1.0\text{s}$	1.65 μF
3	3.000kV	$I \geq 8.00\text{mA}$	$T \geq 1.0\text{s}$	1.32 μF
4	4.000kV	$I \geq 11.00\text{mA}$	$T \geq 1.0\text{s}$	1.32 μF
5	5.000kV	$I \geq 7.00\text{mA}$	$T \geq 1.0\text{s}$	0.66 μF
6	6.000kV	$I \geq 8.00\text{mA}$	$T \geq 1.0\text{s}$	0.66 μF

GPT-15001/15002/15003 Dimensions

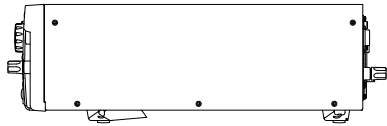
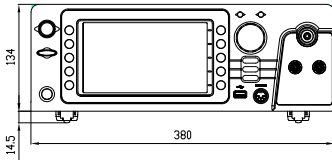
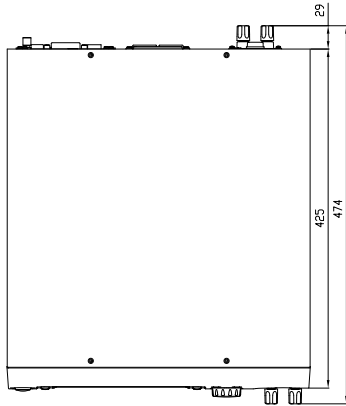

GPT-15004 Dimensions

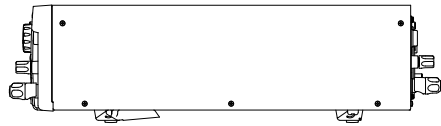
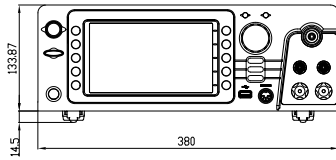
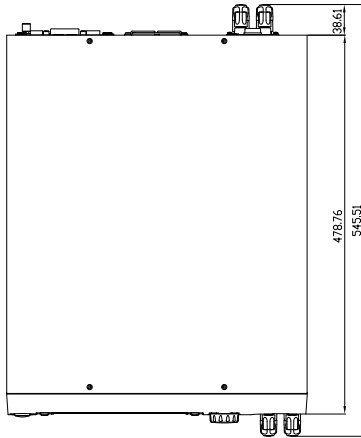

GPT-12001/12002/12003 Dimensions

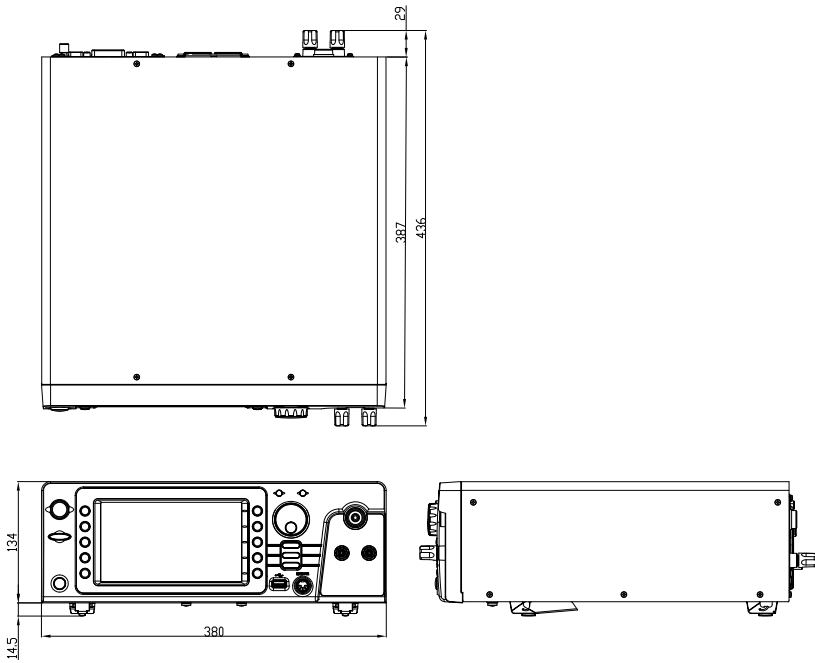

GPT-12004 Dimensions

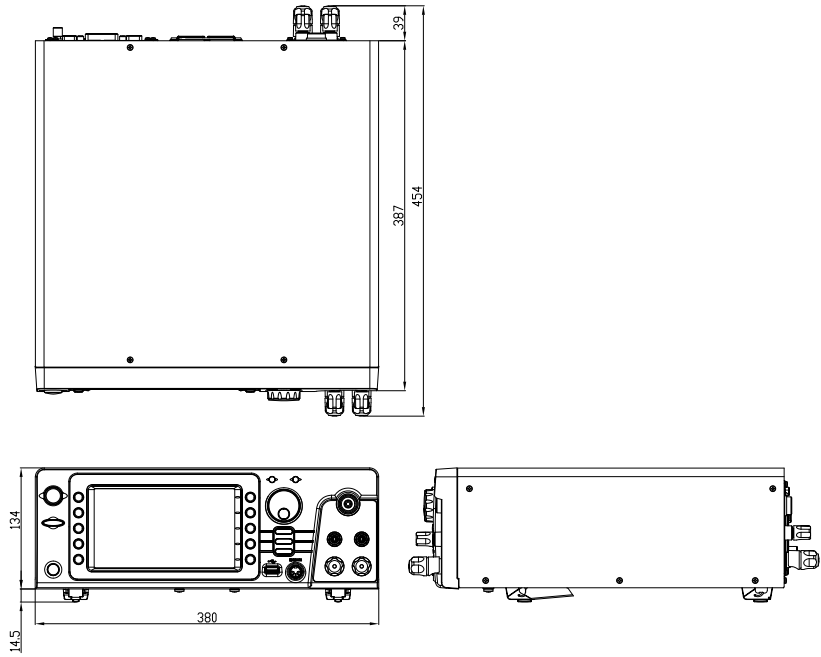

Certificate Of Compliance

We

GOOD WILL INSTRUMENT CO., LTD.

declare that the CE marking mentioned product satisfies all the technical relations application to the product within the scope of council:

Directive: EMC; LVD; WEEE; RoHS

The product is in conformity with the following standards or other normative documents:

© EMC	
EN 61326-1	Electrical equipment for measurement, control and laboratory use -- EMC requirements
Conducted & Radiated Emission EN 55011 / EN 55032	Electrical Fast Transients EN 61000-4-4
Current Harmonics EN 61000-3-2 / EN 61000-3-12	Surge Immunity EN 61000-4-5
Voltage Fluctuations EN 61000-3-3 / EN 61000-3-11	Conducted Susceptibility EN 61000-4-6
Electrostatic Discharge EN 61000-4-2	Power Frequency Magnetic Field EN 61000-4-8
Radiated Immunity EN 61000-4-3	Voltage Dip/ Interruption EN 61000-4-11 / EN 61000-4-34
© Safety	
EN 61010-1 :	Safety requirements for electrical equipment for measurement, control, and laboratory use - Part 1: General requirements

GOODWILL INSTRUMENT CO., LTD.

No. 7-1, Jhongsing Road, Tucheng District, New Taipei City 236, Taiwan

Tel: [+886-2-2268-0389](tel:+886-2-2268-0389)

Fax: [+886-2-2268-0639](tel:+886-2-2268-0639)

Web: <http://www.gwinstek.com>

Email:

marketing@goodwill.com.tw

GOODWILL INSTRUMENT (SUZHOU) CO., LTD.

No. 521, Zhujiang Road, Snd, Suzhou Jiangsu 215011, China

Tel: [+86-512-6661-7177](tel:+86-512-6661-7177)

Fax: [+86-512-6661-7277](tel:+86-512-6661-7277)

Web: <http://www.instek.com.cn>

Email: marketing@instek.com.cn

GOODWILL INSTRUMENT EURO B.V.

De Run 5427A, 5504DG Veldhoven, The Netherlands

Tel: [+31-\(0\)40-2557790](tel:+31-(0)40-2557790)

Fax: [+31-\(0\)40-2541194](tel:+31-(0)40-2541194)

Email: sales@gw-instek.eu

INDEX

- Accessories 12
- Automatic test
 - add test106
 - load.....104
 - page view108, 110
 - results.....122
 - running a test116
 - test file name105
- Caution symbol..... 5
- Cleaning the instrument 7
- Declaration of conformity 280
- Dimensions 276, 277, 278, 279
- Disposal instructions 8
- EN61010
 - measurement category7
 - pollution degree.....8
- Environment
 - safety instruction7
- External control..... 175
 - Interlock key.....181
 - overview176
 - remote operation177
 - remote terminal176
 - signal I/O operation180
 - signal I/O overview178
- FAQ 259
- Front panel diagram..... 15
- GPIO installation 24
- Ground
 - symbol.....5
- Interlock key..... 181
- Line voltage selection..... 23
- List of features..... 11
- Manual tests
 - ARC mode.....59
 - fail mode.....55, 64
 - ground mode.....73
 - max hold.....62
 - overview39
 - pass hold.....63
 - ramp up time.....47, 49, 57
 - results 93
 - running a test.....88
 - special mode..... 98, 100
 - test filename..... 42
 - test frequency 53
 - test function 40
 - test limits.....43
 - test reference.....54
 - test selection.....41
 - test time45
 - test voltage.....51
 - timing diagrams.....94
- Marketing
 - contact261
- Menu tree31
- Operating precautions.....26
- Overview10
- Package contents14
- Power on/off
 - safety instruction.....7
- Rear panel diagram 19
- Remote control 182
 - Command list 191
 - Command syntax 188
 - function check 186
 - interface configuration 183
- Service operation
 - about disassembly.....6
 - contact261
- Specifications268
- Test errors263
- Tilt stand 22
- Utility settings
 - buzzer131
 - Control settings139, 153, 158, 161, 162, 164
 - double action139, 153, 158, 161, 162, 164
 - GPIO.....133
 - interface.....133
 - key lock 139, 153, 158, 161, 162, 164
 - LCD.....129
 - RS232133

start control	139, 153, 158, 161, 162, 164	Workplace precautions 25
USB133	Zeroing	66, 68, 70, 80, 82, 84, 86, 172
Warning symbol 5		