

# Digital Storage Oscilloscope

GDS-3000A Series

---

**USER MANUAL**



ISO-9001 CERTIFIED MANUFACTURER

**GW INSTEK**

This manual contains proprietary information, which is protected by copyright. All rights are reserved. No part of this manual may be photocopied, reproduced or translated to another language without prior written consent of Good Will company.

The information in this manual was correct at the time of printing. However, Good Will continues to improve products and reserves the rights to change specification, equipment, and maintenance procedures at any time without notice.

# Table of Contents

<b>SAFETY INSTRUCTIONS</b> .....	<b>4</b>
<b>GETTING STARTED</b> .....	<b>9</b>
GDS-3000A Series Overview .....	10
Appearance .....	14
Set Up .....	26
Built-in Help .....	35
<b>MEASUREMENT</b> .....	<b>36</b>
Basic Measurement .....	37
Automatic Measurement.....	43
Cursor Measurement .....	59
Math Operation .....	66
<b>ADVANCED CONFIGURATION</b> .....	<b>77</b>
Acquisition .....	80
Segmented Memory Acquisition .....	85
Horizontal View .....	96
Vertical View (Channel).....	104
Bus Key Configuration .....	114
Trigger .....	139
Search.....	176
System Settings .....	184
Display .....	189
<b>ARBITRARY WAVE GENERATOR</b> .....	<b>195</b>
Arbitrary Wave Generator Operation .....	196
<b>POWER ANALYSIS (OPTIONAL)</b> .....	<b>227</b>
Power Analysis Overview .....	229
Power Quality .....	231

---

Switching Loss .....	235
Harmonics .....	240
Ripple .....	250
Inrush .....	252
Modulation .....	254
Safe Operation Area .....	258
Transient .....	262
Efficiency .....	265
B-H curve .....	268
Control Loop Response .....	272
Power Supply Rejection Ratio (PSRR) .....	284
Turn On/Off .....	288
<b>SPECTRUM ANALYZER .....</b>	<b>292</b>
Spectrum Analyzer operation .....	293
<b>APPLICATIONS .....</b>	<b>310</b>
Introduction .....	311
Go-NoGo application .....	314
DVM application .....	319
Data Log application .....	321
Digital Filter application .....	323
Mask application .....	325
FRA application .....	336
<b>SAVE/RECALL .....</b>	<b>341</b>
File Format/Utility .....	342
Create/Edit Labels .....	348
Save .....	351
Recall .....	358
Reference Waveforms .....	363
<b>FILE UTILITIES .....</b>	<b>365</b>
<b>HARDCOPY KEY .....</b>	<b>373</b>



<b>REMOTE CONTROL CONFIG .....</b>	<b>375</b>
Interface Configuration .....	376
Web Server.....	388
<b>MAINTENANCE .....</b>	<b>392</b>
<b>FAQ.....</b>	<b>397</b>
<b>APPENDIX.....</b>	<b>399</b>
Updating the Firmware .....	400
GDS-3000A Series Specifications .....	402
Probe Specifications .....	409
Dimensions .....	410
Certificate Of Compliance .....	411
<b>INDEX .....</b>	<b>412</b>

# S SAFETY INSTRUCTIONS

This chapter contains important safety instructions that you must follow during operation and storage. Read the following before any operation to insure your safety and to keep the instrument in the best possible condition.

## Safety Symbols

These safety symbols may appear in this manual or on the Product name.

---



WARNING

Warning: Identifies conditions or practices that could result in injury or loss of life.



CAUTION

Caution: Identifies conditions or practices that could result in damage to the equipment or to other properties.



DANGER High Voltage



(Note)

Attention required. Refer to the Manual



Protective Conductor Terminal



Earth (ground) Terminal



Do not dispose electronic equipment as unsorted municipal waste. Please use a separate collection facility or contact the supplier from which this instrument was purchased.

## Safety Guidelines

---

General Guideline • Make sure the BNC input voltage does not exceed 300Vrms.



WARNING



CAUTION

- Never connect a hazardous live voltage to the ground side of the BNC connectors. It might lead to fire and electric shock.
- Do not place any heavy object on the GDS-3000A series.
- Avoid severe impact or rough handling that leads to damaging the GDS-3000A series.
- Do not discharge static electricity to the GDS-3000A series.
- Use only mating connectors, not bare wires, for the terminals.
- Do not block the cooling fan opening.
- Do not perform measurement at a power source or building installation (Note below).
- Do not disassemble the GDS-3000A series unless you are qualified.



Note

(Measurement categories) EN 61010-1:2010 specifies the measurement categories and their requirements as follows. The GDS-3000A series falls under category I.

- Measurement category IV is for measurements performed at the source of low-voltage installation.
  - Measurement category III is for measurements performed in the building installation.
  - Measurement category II is for measurements performed on circuits directly connected to the low voltage installation.
  - Measurement category I is for measurement performed on circuits not directly connected to Mains.
-

## Power Supply



## WARNING

- AC Input voltage: 100 - 240V AC, 50 - 60Hz, auto selection. Power consumption: 100W for GDS-3000A series.
  - Connect the protective grounding conductor of the AC power cord to an earth ground, to avoid electrical shock.
- 

Cleaning the  
GDS-3000A  
Series

- Disconnect the power cord before cleaning.
  - Use a soft cloth dampened in a solution of mild detergent and water. Do not spray any liquid.
  - Do not use chemicals containing harsh materials such as benzene, toluene, xylene and acetone.
- 

Operation  
Environment

- Location: Indoor, no direct sunlight, dust free, almost non-conductive pollution (Note below)
- Relative Humidity:  $\leq 80\%$ ,  $40^{\circ}\text{C}$  or below;  $\leq 45\%$ ,  $41^{\circ}\text{C} \sim 50^{\circ}\text{C}$
- Altitude:  $< 2000\text{m}$
- Temperature:  $0^{\circ}\text{C}$  to  $50^{\circ}\text{C}$



## Note

(Pollution Degree) EN 61010-1:2010 specifies the pollution degrees and their requirements as follows. The GDS-3000A series falls under degree 2.

Pollution refers to "addition of foreign matter, solid, liquid, or gaseous (ionized gases), that may produce a reduction of dielectric strength or surface resistivity".

- Pollution degree 1: No pollution or only dry, non-conductive pollution occurs. The pollution has no influence.
  - Pollution degree 2: Normally only non-conductive pollution occurs. Occasionally, however, a temporary conductivity caused by condensation must be expected.
  - Pollution degree 3: Conductive pollution occurs, or dry, non-conductive pollution occurs which becomes conductive due to condensation which is expected. In such conditions, equipment is normally protected against exposure to direct sunlight, precipitation, and full wind pressure, but neither temperature nor humidity is controlled.
-

**Storage environment**

- Location: Indoor
  - Temperature: -10°C to 60°C
  - Humidity: Up to 93% RH (non-condensing) / ≤40°C, up to 65% RH (non-condensing) / 41°C ~ 60 °C
- 

**Disposal**

Do not dispose this instrument as unsorted municipal waste. Please use a separate collection facility or contact the supplier from which this instrument was purchased. Please make sure discarded electrical waste is properly recycled to reduce environmental impact.

## Power cord for the United Kingdom

When using the oscilloscope in the United Kingdom, make sure the power cord meets the following safety instructions.

NOTE: This lead/appliance must only be wired by competent persons



**WARNING: THIS APPLIANCE MUST BE EARTHED**

IMPORTANT: The wires in this lead are coloured in accordance with the following code:

Green/ Yellow:	Earth
Blue:	Neutral
Brown:	Live (Phase)



As the colours of the wires in main leads may not correspond with the coloured marking identified in your plug/appliance, proceed as follows:

The wire which is coloured Green & Yellow must be connected to the Earth terminal marked with either the letter E, the earth symbol  $\oplus$  or coloured Green/Green & Yellow.

The wire which is coloured Blue must be connected to the terminal which is marked with the letter N or coloured Blue or Black.

The wire which is coloured Brown must be connected to the terminal marked with the letter L or P or coloured Brown or Red.

If in doubt, consult the instructions provided with the equipment or contact the supplier.

This cable/appliance should be protected by a suitably rated and approved HBC mains fuse: refer to the rating information on the equipment and/or user instructions for details. As a guide, a cable of 0.75mm<sup>2</sup> should be protected by a 3A or 5A fuse. Larger conductors would normally require 13A types, depending on the connection method used.

Any exposed wiring from a cable, plug or connection that is engaged in a live socket is extremely hazardous. If a cable or plug is deemed hazardous, turn off the mains power and remove the cable, any fuses and fuse assemblies. All hazardous wiring must be immediately destroyed and replaced in accordance to the above standard.

# G E T T I N G   S T A R T E D

This chapter describes the GDS-3000A series in a nutshell, including its main features and front/rear panel. After going through the overview, follow the Set Up section to properly set up the device for first time use. The Set Up section also includes an introduction on how to use this manual effectively.

---

<b>GDS-3000A Series Overview</b> .....	<b>10</b>
Integrated instruments and series lineup.....	10
Main Features.....	10
Accessories .....	12
<b>Appearance</b> .....	<b>14</b>
Front panel .....	14
GDS-3000A 2CH models.....	14
GDS-3000A 4CH models.....	14
Rear Panel and Right side panel.....	22
LCD Display .....	24
<b>Set Up</b> .....	<b>26</b>
Tilt Stand.....	26
Power Up .....	26
First Time Use .....	27
How to Use This Manual.....	30
<b>Built-in Help</b> .....	<b>35</b>

## GDS-3000A Series Overview

### Integrated instruments and series lineup

The GDS-3000A series consists of 4 models. Note that throughout the user manual, the term “GDS-3000A series” refers to all models of the series, unless stated otherwise.

Model name	Frequency bandwidth	Input channels	Max. Real-time Sampling Rate
GDS-3352A	350MHz	2	5GSa/s
GDS-3652A	650MHz	2	5GSa/s
GDS-3354A	350MHz	4	5GSa/s
GDS-3654A	650MHz	4	5GSa/s

### Main Features

#### Features

- 10.2 inch, 800 x 480, WVGA TFT display.
- Available from 350MHz to 650MHz.
- Real-time sampling rate of 5GSa/s max.
- Deep memory: 200M points record length per channel.
- Waveform capture rate of 200,000 waveforms per second.
- Vertical sensitivity: 1mV/div~10V/div @ 1M $\Omega$ ; 1mV/div~1V/div @ 50 $\Omega$
- Segmented Memory: Optimizes the acquisition memory to selectively capture only the important signal details. Up to 490,000 successive waveform segments can be captured with a time-tag resolution of 4ns.
- Waveform Search: Allows the scope to search for a number of different signal events.



- Arbitrary Wave generator: Full-function dual channel arbitrary waveform generator.
  - Spectrum Analyzer: A handy tool to perform signal analysis in the frequency domain.
  - Logic Analyzer (option): Can be used to measure discrete inputs or measure values on various buses.
  - The optional power analysis software provides automatic measurement for a number of advanced measurement types such as power quality, harmonics, ripple, inrush current, etc.
  - Powerful embedded applications such as: Data Logging, Digital Voltmeter, Go-No Go, Mask, Digital filter, FRA etc.
  - On-screen Help.
  - 800M byte SLC internal flash disk.
- 

#### Interface

- USB (USBTMC) device port: rear panel, for remote control.
- USB host device port: front panel, for storage devices
- Ethernet port as standard.
- Probe compensation output with selectable output frequency (1kHz ~ 200kHz).
- Calibration output.
- RS232 DB-9 male connector for remote control
- DB-15 female SVGA output connector
- Optional GPIB interface
- $\pm 12\text{V}/500\text{mA}$  power supply receptacles for current probe (GCP-530/1030) usage.

**Accessories**

Standard Accessories	Description
Power cord	N/A region dependent
GTP-351R	350MHz Passive probe for GDS-3352A/3354A
GTP-501R	500MHz Passive probe for GDS-3652A/3654A
GTL-110	Test lead for AWG, BNC to BNC connector
Optional Accessories	Description
DS3A-16LA	16CH logic analyzer
DS3A-GPIB	GPIB interface (Factory Pre-installed)
GTP-033A	35MHz 1:1 Passive probe
GTP-352R	350MHz 20:1 Passive probe
GDP-025	25MHz High voltage differential probe
GDP-050	50MHz High voltage differential probe
GDP-100	100MHz High voltage differential probe
GCP-300	300kHz/200A Current probe
GCP-500	500kHz/150A Current probe
GCP-530	50MHz/30A Current probe
GCP-1000	1MHz/70A Current probe
GCP-1030	100MHz/30A Current probe
GTL-16LA3A	16-Channel Logic Analyzer Probe
GTL-248	GPIB Cable, Double Shielded, 2000mm
GTL-232	RS-232C cable, 9-pin female to 9-pin female, Null modem for computer
GTL-246	USB 2.0 cable, A-B type cable 4P, 1800mm
GRA-443-E	Rack Adapter Panel
GKT-100	Deskew Fixture
Standard Apps	Description
Go-NoGo	Go-NoGo testing app.

---

DataLog	Waveform or image data logging app.
DVM	Digital Voltmeter app.
Digital Filter	High, low or band pass digital filter for analog inputs.
Mask	Creates shape templates for signal comparison.
Remote Disk	Allows the scope to mount a network share drive.
Demo mode	Demonstration mode that is used with the GDB-03 demo board.
FRA	Frequency Response Analyzer
Optional App	Description
DS3A-PWR	Power Analysis
Drivers, others	Description
Driver	LabVIEW driver

# Appearance

## Front panel

### GDS-3000A 2CH models

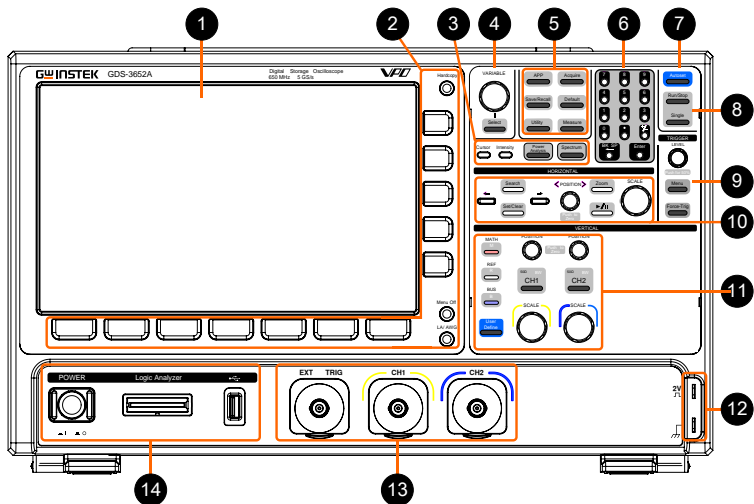

### GDS-3000A 4CH models

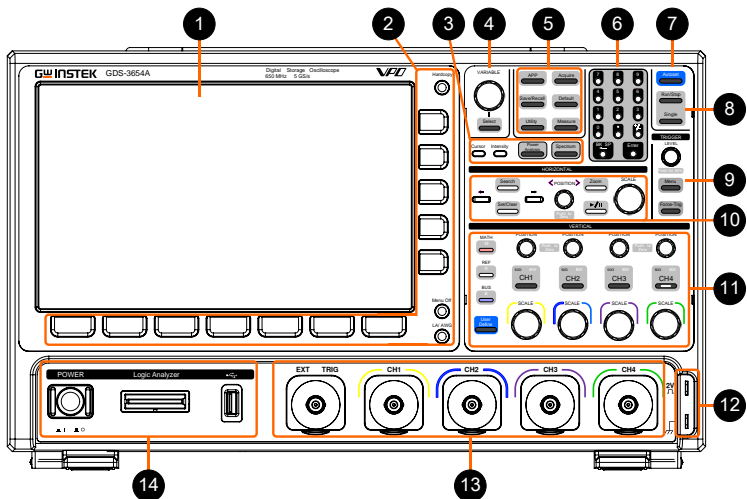

1 LCD Display 10.2" WVGA TFT color LCD, 800 x 480 resolution, wide angle view display.

2 Hardcopy Key **Hardcopy** The Hardcopy key is a quick-save key. For more information see pages 373.



Menu Off Key **Menu Off** Use the Menu Off key to hide the onscreen menu system.



LA/AWG Key **LA/ AWG** This key is used to access installed arbitrary wave generator or optional logic analyzer.



Menu Keys The side menu and bottom menu keys are used to make selections from the soft-menus on the LCD user interface.

To choose menu items, use the 7 Bottom menu keys located on the bottom of the display panel.

To select a variable or option from a menu, use the side menu keys on the side of the panel. See page 30 for details.

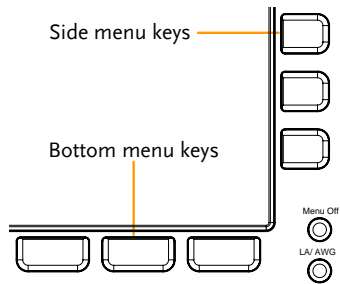

3 Cursor **Cursor** Configures and runs cursor measurements.

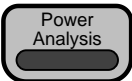

Intensity  Configures the waveform and graticule settings.

Power Analysis  Executes various power analysis functions (optional).

Spectrum  Executes spectrum function.

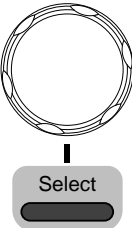
4 VARIABLE Knob and Select Key  The VARIABLE knob is used to increase/ decrease values or to move between parameters.  
The Select key is used to make selections.

5 Function Keys The Function keys are used to enter and configure different functions on the GDS-3000A series.

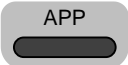

APP  Configures and runs the applications.

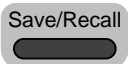

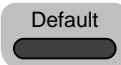

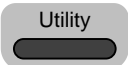

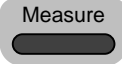
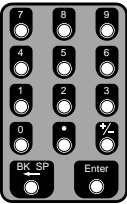
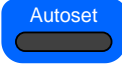
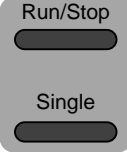
Acquire  Configures the acquisition mode, including Segmented Memory acquisition.

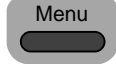
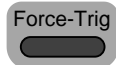
Save/Recall  Used to save and recall waveforms, images, panel settings.

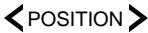
Default  Resets the oscilloscope to the default settings.

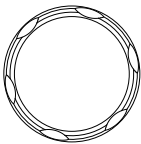
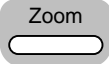
Utility  Configures the Hardcopy key, display time, language, probe compensation and calibration. It also accesses the file utilities menu.

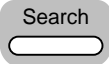
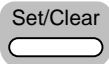
Measure		Configures and runs automatic measurements.
6 Numeric keypad		The numeric keypad is used to enter values and parameters. It is often used in conjunction with the VARIABLE Knob and Select Key.
7 Autoset		Press the Autoset key to automatically set the trigger, horizontal scale and vertical scale.
8 Run/Stop Key		Press to Freeze (Stop) or continue (Run) signal acquisition (page 39). The run stop key is also used to run or stop Segmented Memory acquisition (page 88).
Single		Sets the acquisition mode to single triggering mode.
9 Trigger Controls		The trigger controls are used to control the trigger level and options.
Level Knob		Used to set the trigger level. Push the Level Knob to set the trigger level to the half way point (50%)
Trigger Menu Key		Used to bring up the trigger menu.
Force - Trig		Press to force an immediate trigger of the waveform.

- 10 Horizontal Controls      The horizontal controls are used to set the time base settings, zoom into the waveforms/traces and search for events.
- Horizontal Position       The Position knob is used to position the waveforms/traces horizontally on the display screen. Pressing the knob will reset the position to zero.
- 
- SCALE      SCALE      The Scale knob is used to change the horizontal scale (TIME/DIV).
- 
- Zoom       Press Zoom in combination with the horizontal Position knob.
- Play/Pause       The Play/Pause key allows you to view each search event in succession – to effectively “play” through each search event. It is also used to play through a waveform/trace in zoom mode.
- Search       The Search key accesses the search function menu to set the search type, source and threshold.
- Set/Clear       Use the Set/Clear key to set or clear points of interest when using the search function.
- Search Arrows        Use the arrow keys to navigate the search events.



11 Vertical POSITION

POSITION



Push to Zero

Sets the vertical position of the waveform/trace. Push the knob to reset the vertical position to zero.

SCALE Knob (Vertical)

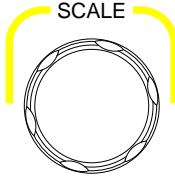

Sets the vertical scale of the channel (TIME/DIV).

Channel Menu Key



Press the CH1~4 key to set and configure the corresponding channel.

Math Key

MATH



Use the Math key to set and configure math functions.

Reference Key

REF



Press the Reference key to set or remove reference waveforms.

BUS Key

BUS



The Bus key is used for bus decode (SPI, UART, I2C, CAN and LIN) configuration.

User Define Key



Provides several predefined function keys as shortcuts. Press the "Utility" key and select "User defined" to select the desired predefined function as shortcut.

12 Probe Compensation Output



The probe compensation output is used for probe compensation. It also has an adjustable output frequency.

By default this port outputs a 2Vpp, square wave signal at 1kHz for probe compensation.

Please see page 187 for details.

Ground Terminal

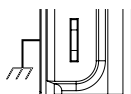

Accepts the DUT ground lead for common ground.

13 External Trigger Input

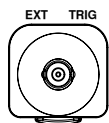

Accepts external trigger signals (page 139).

Input impedance: 1MΩ/50Ω  
 Voltage input: ±15Vpeak for 1MΩ  
 Input impedance; 5Vrms for 50 Ω  
 Input impedance; EXT trigger capacitance: 22pF.

Channel Inputs

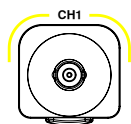

Accepts input signals.  
 Input impedance: 1MΩ/50Ω.  
 Capacitance: 22pF  
 CAT II

14 USB Host Port



Type A, 1.1/2.0 compatible. Used for data transfer.

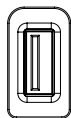

Logic Analyzer



Logic Analyzer probe connector



Power Switch

**POWER**

Used to turn the power on/off.

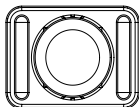

■ I: ON

■ O: OFF

■ I ■ O

Rear Panel and Right side panel

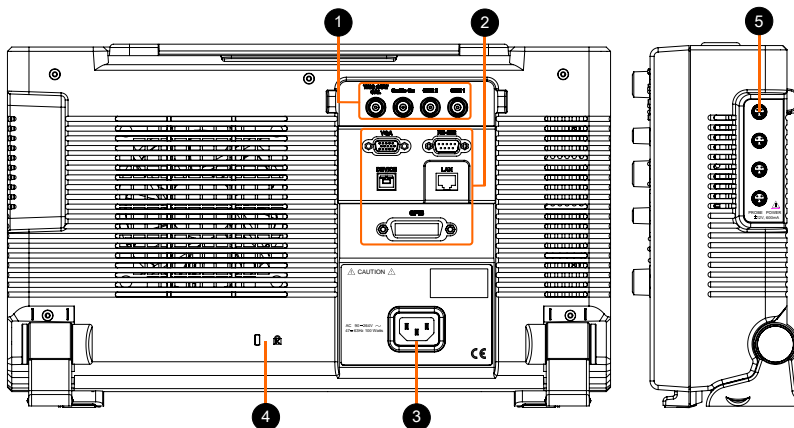

1 Calibration Output

**TRIG OUT/  
CAL**

Outputs the signal for vertical scale accuracy calibration (page 393).



Go-No Go Output

**Go/No Go**

Outputs Go-No Go test results (page 314) as a 500us pulse signal.



AWG Output

**GEN 1**

Output the GEN1 or GEN2 signal from the Arbitrary Wave Generator function. (see page 197).



2 USB (USBTMC) Device Port







The Type B USB (USBTMC) Device Port is used for remote control.

LAN (Ethernet) Port

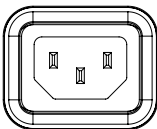

The LAN port is used for remote control over a network or when combined with the Remote Disk app, allows the scope to be mounted to a share disk.







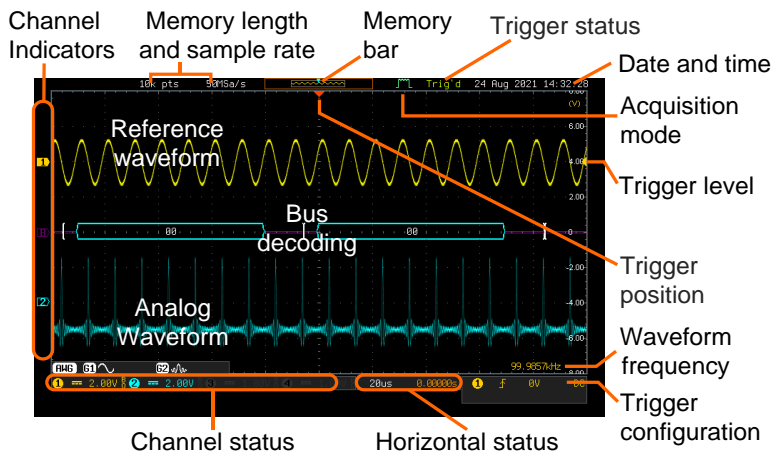

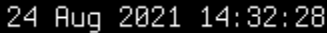

- |            |   |   |
|------------|---|---|
| RS232 port |  | It is used for RS232 remote control             |
| VGA port   |  | Outputs SVGA resolution to an external display. |
| GPIB port  |  | 24 pin female GPIB port.                        |
- 
- |                      |   |  |
|----------------------|---|--|
| 3 Power Input Socket |  | <p>Power cord socket accepts AC mains, 100 ~ 240V, 50/60Hz.</p> <p>For power up sequence, see page 26.</p> |
|----------------------|---|--|
- 
- |                 |   |                                      |
|-----------------|---|--------------------------------------|
| 4 Security Slot |  | Kensington security slot compatible. |
|-----------------|---|--------------------------------------|
- 
- |                           |   |  |
|---------------------------|---|--|
| 5 Power Supply Receptacle |  | +/-12V power supply for current probe usage. |
|---------------------------|---|--|

## LCD Display

Below is a general description of the main display. As the display changes while activating the different functions of the GDS-3000A, please refer to each function sub-chapters of this user manual for more details.



- Analog Waveforms** Shows the analog input signal waveforms.  
 Channel 1: Yellow      Channel 2: Blue
- Bus decoding** Shows serial bus data decoding. The values are displayed in hex or binary.
- Reference waveform** Reference waveform(s) can be displayed for reference, comparison or other operations.
- Channel Indicators** The channel indicators for each activated channels are located at the zero volt level of each signals. Any active channel is shown with a solid color.  
 Example: B Bus indicator(B)  
1 Reference waveform indicator  
M Math indicator
- Trigger Position** Shows the position of the trigger.
- Horizontal Status** Shows the horizontal scale and position.

Date and Time		Current date and time (page 185).
Trigger Level		Shows the trigger level on the graticule.
Memory Bar		The ratio and the position of the displayed waveform compared to the internal memory (page 96).
Trigger Status	<p>Trig'd    Triggered.</p> <p>PrTrig    Pre-trigger.</p> <p>Trig?    Not triggered, display not updated.</p> <p>Stop    Trigger stopped. Also appears in Run/Stop (page 39).</p> <p>Roll    Roll mode.</p> <p>Auto    Auto trigger mode.</p>	For trigger details, see page 139.
Acquisition Mode	<p> Normal mode</p> <p> Peak detect mode</p> <p> Average mode</p> <p> High Resolution mode</p>	For acquisition details, see page 80.
Signal Frequency		Shows the trigger source frequency.
Trigger Configuration		Trigger source, slope, voltage and coupling.
Horizontal Status		Horizontal scale, horizontal position.
Channel Status		Channel 1, DC coupling, 2V/Div, both bandwidth limit, 50 ohm input impedance are on.
		For channel details, see page 104.

# Set Up

## Tilt Stand

**Tilt** To tilt, push the legs outward, as shown below.

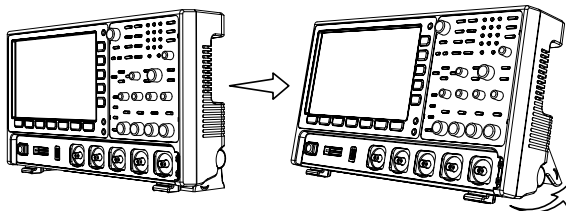

**Stand** To stand the scope upright, push the legs back under the casing as shown below.

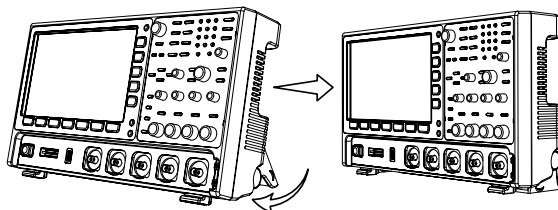

## Power Up

**Requirements** The GDS-3000A series accepts line voltages of 100 ~ 240V at 50 or 60Hz.

**Step** 1. Connect the power cord to the rear panel socket.

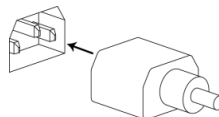



2. Press the POWER key. The display becomes active in ~ 30 seconds.

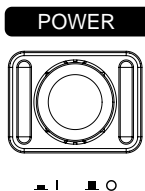

- I: ON
- O: OFF



Note

The GDS-3000A series recovers the state right before the power is turned OFF. The default settings can be recovered by pressing the Default key on the front panel. For details, see page 358.

## First Time Use

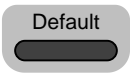
Background	This section describes how to connect, adjust the scale and compensate the probe. Before operating the GDS-3000A series in a new environment, run these steps to make sure the instrument performs at its full potential.	
1. Power On	Follow the procedures on the previous page.	
2. Firmware	Update to the latest firmware.	Page 400
3. Set the Date and Time	Set the date and time.	Page 185
4. Reset System	Reset the system by recalling the factory settings. Press the <i>Default</i> key on the front panel. For details, see page 358.	
5. Connect the probe	<p>Connect the probe that you will use for measurements to the Channel 1 input and to the probe compensation output. This output provides by default a 2V peak to peak, 1kHz square wave for signal compensation.</p> <p>Set the probe attenuation to x10 if the probe has adjustable attenuation.</p>	

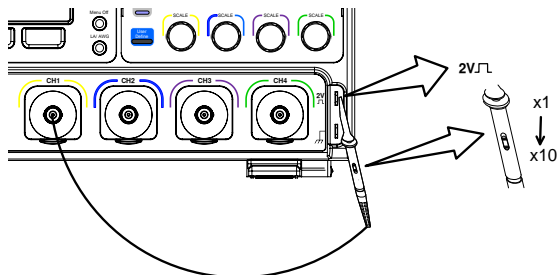

**6. Capture Signal (Autoset)**

Press the *Autoset* key. A square waveform appears on the center of the screen. For Autoset details, see page 38.

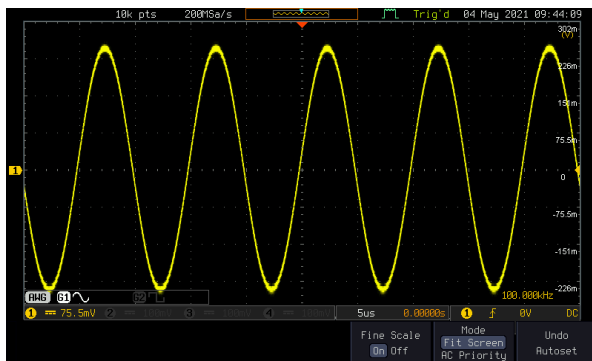
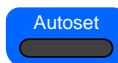

**7. Select Vector Waveform**

3. Press the **UTILITY** key followed by pressing the **DISPLAY** key from the bottom menu, and then set the display type to **Vector**.

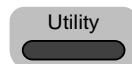

**8. Compensate the probe**

Turn the adjustment point on the probe to make the square waveform as flat as possible.

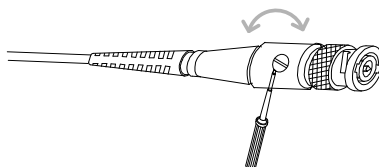
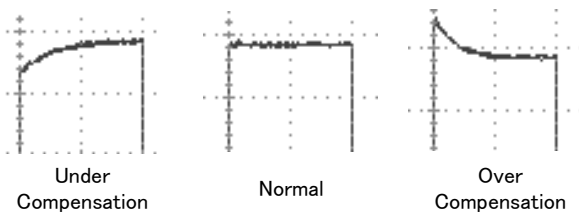

9. Start operations Continue with the other operations.

- Measurement: page 36    Advanced Configuration: page 77
- Using the Spectrum Analyzer: page 292    Applications: page 310
- Save/Recall: page 340    File Utilities: page 365
- Hardcopy key: page 373    Remote Control: page 375
- Maintenance: page 392

## How to Use This Manual

### Background

This section describes the conventions used in this manual to operate the GDS-3000A series.

Throughout the manual any reference to pressing a menu key refers to the keys directly below or beside any menu icons or parameters.

When the user manual says to “toggle” a value or parameter, press the corresponding menu item. Pressing the item will toggle the value or parameter.

Active parameters are highlighted for each menu item. For example in the example below, Coupling is currently set to DC.

If a menu item can be toggled from one value or parameter to another, the available options will be visible, with the current option highlighted. In the example below the slope can be toggled from a rising slope to a falling slope or either slope.

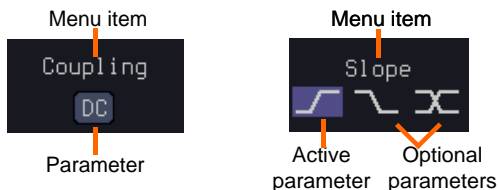

### Selecting a Menu Item, Parameter or Variable

When the user manual says to “select” a value from one of the side menu parameters, first press the corresponding menu key and use the VARIABLE knob to either scroll through a parameter list or to increase or decrease a variable.

Example 1

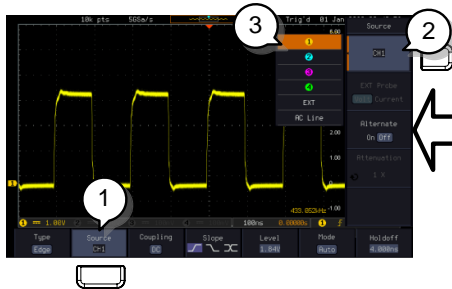

4. Press a bottom menu key to access the side menu.



5. Press a side menu key to either set a parameter or to access a sub menu.

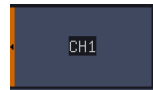

6. If accessing a sub menu or setting a variable parameter, use the VARIABLE knob to scroll through menu items or variables. Use the Select key to confirm and exit.

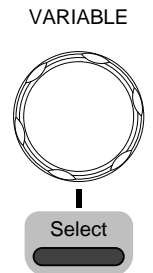

7. Press the same bottom menu key again to reduce the side menu.



Example 2

For some variables, a circular arrow icon indicates that the variable for that menu key can be edited with the VARIABLE knob.

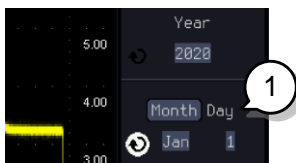

- Press the desired menu key to select it. The circular arrow will become highlighted.



9. Use the VARIABLE knob to edit the value.

- Use the VARIABLE knob to edit the value.

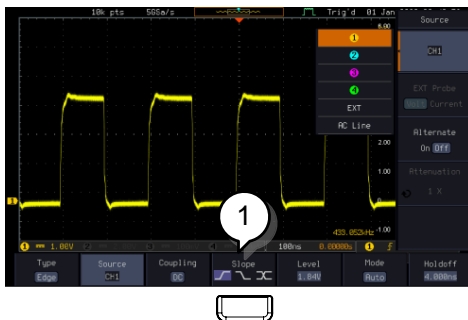

- Press the bottom menu key to toggle the parameter.



10. To reduce the side menu, press the corresponding bottom menu that brought up the side menu.

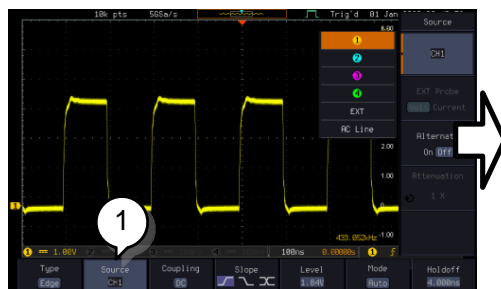

- To reduce the side menu, press the corresponding bottom menu that brought up the side menu.

For example: Press the *Source* soft-key to reduce the Source menu.

Reduce Lower Menu

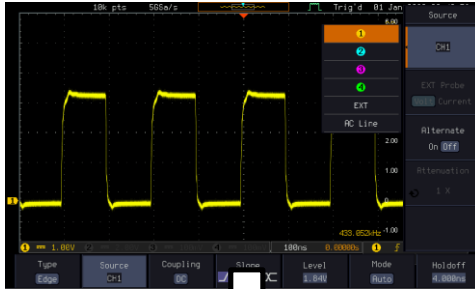

12. Press the relevant function key again to reduce the bottom menu. For example: press the Trigger Menu key to reduce the trigger menu.

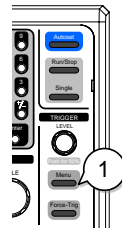

Remove All Menus

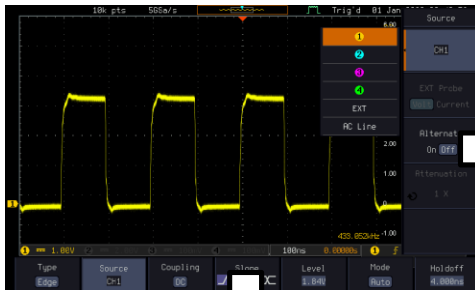

13. Press the *Menu Off* key to reduce the side menu, press again to reduce the bottom menu.

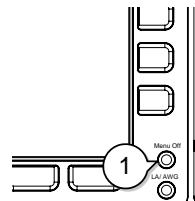

Remove On-Screen Messages

14. The *Menu Off* key can also be used to remove any on screen messages.

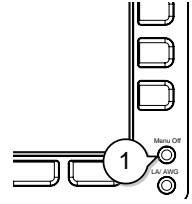



## Built-in Help

Press and hold any key on front panel for few seconds to launch the built-in Help contents. The help menu contains information on how to use the front panel keys.

---

**Panel Operation** Press and hold any key for few seconds to launch introduction of the select key. The display changes to Help mode.

**Example: Help on the Acquire key**

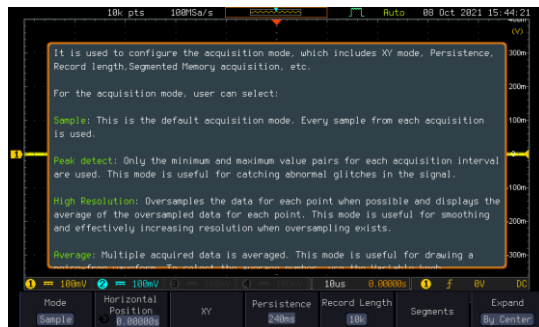

**Exit** Further press any key to close the Help contents shown on screen display.

# M EASUREMENT

<b>Basic Measurement .....</b>	<b>37</b>
Channel Activation.....	37
Autoset .....	38
Run/Stop .....	39
Horizontal Position/Scale.....	40
Vertical Position/Scale .....	42
<b>Automatic Measurement.....</b>	<b>43</b>
Measurement Items.....	43
Add Measurement .....	47
Remove Measurement .....	49
Measurement Shortcuts.....	51
Gated mode .....	53
Display All mode .....	53
High Low Function.....	54
Statistics .....	56
Reference Levels.....	58
<b>Cursor Measurement .....</b>	<b>59</b>
Use Horizontal Cursors.....	59
Use Vertical Cursors .....	62
<b>Math Operation .....</b>	<b>66</b>
Basic Math Overview & Operators.....	66
Addition/Subtraction/Multiplication/Division.....	66
FFT Overview & Window Functions.....	68
FFT Operation.....	69
Advanced Math Overview .....	72
Advanced Math Operation .....	73

## Basic Measurement

This section describes the basic operations required in capturing, viewing and measuring the input signal. For more detailed or more specific operations, see the following chapters.

- Advanced Configuration → from page 77
- Arbitrary Wave Generator → from page 176
- Spectrum Analyzer → from page 227
- Applications → from page 310

Before operating the oscilloscope, please see the Getting Started chapter, page 9.

### Channel Activation

**Activate Channel** To activate an input channel, press a *channel* key.



When activated, the channel key will light up. The corresponding channel menu will also appear.

Each channel is associated with the color shown beside each channel's vertical SCALE dial: CH1: yellow, CH2: blue

When a channel is activated, it is shown above the bottom menu system.

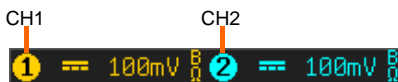

**De-activate Channel** To deactivate a channel, press the corresponding *channel* key again. If the channel menu is not open, press the *channel* key twice (the first press shows the Channel menu).



Default Setup To activate the default state, press *Default* (this will reset the system and recall the factory defaults, see page 358).

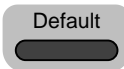

## Autoset

Background The Autoset function automatically configures the panel settings to position the input signal(s) to the best viewing condition. The GDS-3000A series automatically configures the following parameters:

- Horizontal scale
- Vertical scale
- Trigger source channel

There are two operating modes for the Autoset function: Fit Screen Mode and AC Priority Mode.

Fit Screen Mode will fit the waveform to the best scale, including any DC components (offset). AC priority mode will scale the waveform to the screen by removing any DC component.

Panel Operation 1. Connect the input signal to the GDS-3000A series and press the *Autoset* key.

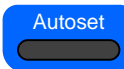

2. The waveform appears in the center of the display.

Before

After



3. To undo Autoset, press *Undo Autoset* from the bottom menu.

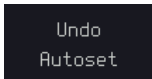

Change modes

4. Choose between *Fit Screen Mode* and *AC Priority Mode* from the bottom menu.

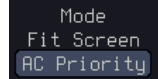

5. Press the *Autoset* key again to use Autoset in the new mode.

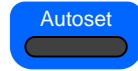

Fit Screen Mode

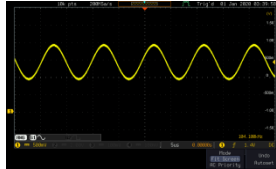

AC Priority

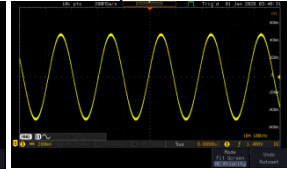

Limitation

Autoset does not work in the following situations:

- Input signal frequency is less than 20Hz
- Input signal amplitude is less than 10mV



Note

The Autoset key does NOT automatically activate the channels to which input signals are connected.

## Run/Stop

Background

By default, the waveform on the display is constantly updated (Run mode). Freezing the waveform by stopping signal acquisition (Stop mode) allows flexible observation and analysis. To enter Stop mode, two methods are available: pressing the Run/Stop key or using the Single Trigger mode.

Stop mode icon



When in Stop mode, the Stop icon appears at the top of the display.

Triggered icon



Freeze Waveform using the Run/Stop Key

Press the *Run/Stop* key once. The Run/Stop key turns red. The waveform and signal acquisition freezes.

Stop:



To unfreeze, press the *Run/Stop* key again. The *Run/Stop* key turns green again.



Freeze Waveform by Single Trigger Mode

Press the *Single* key to go into the Single Trigger mode. The *Single* key turns bright white.



In the Single Trigger mode, the scope will be put into the pre-trigger mode until the scope encounters the next trigger point. After the scope has triggered, it will remain in Stop mode, until the *Single* key is pressed again or the *Run/Stop* key is pressed.

Waveform Operation

The waveform can be moved or scaled in both Run and Stop mode, but in different manners. For details, see page 96 (Horizontal position/scale) and page 104 (Vertical position/scale).

### Horizontal Position/Scale

For more detailed configuration, see page 96.

Set Horizontal Position

The horizontal position knob moves **< POSITION >** the waveform left and right.



Push to Zero

Set Horizontal Position to 0

Pressing the horizontal position knob will reset the horizontal position to 0.



Alternatively, pressing the *Acquire* key and then pressing *Reset H Position to 0s* from the bottom menu will also reset the horizontal position.



As the waveform moves, the display bar on the top of the display indicates the portion of the waveform currently shown on the display and the position of the horizontal marker on the waveform.



**Position Indicator** The horizontal position is shown at the bottom of the display grid to the right.



**Select Horizontal Scale**

To select the timebase, turn the horizontal *SCALE* knob; left (slow) or right (fast).

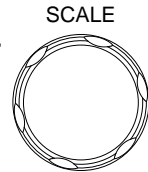

**Range** 1n/div~1000s/div 1-2-5 increments

The scale is displayed to the left at the bottom of the screen.



**Display bar**

The display bar indicates how much of the waveform is displayed on the screen at any given time. Changes to timebase will be reflected on the display bar.

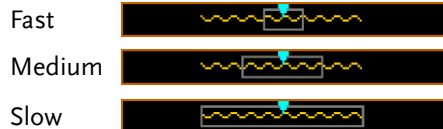

**Stop mode** In the Stop mode, the waveform size changes according to the scale.

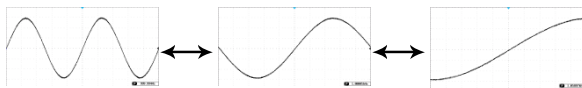

Note

The Sample rate changes according to the timebase and record length. See page 84.

## Vertical Position/Scale

For more detailed configuration, see page 104.

**Set Vertical Position**

To move the waveform up or down, turn the *vertical position knob* for each channel.

Push the *vertical position knob* to reset the position to 0.

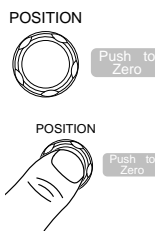

**Run/Stop mode**

The waveform can be moved vertically in both Run and Stop mode.

**Select Vertical Scale**

To change the vertical scale, turn the vertical *SCALE knob*; left (down) or right (up).

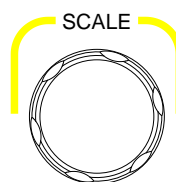

**Range:**

for 1Mohm input 1mV/div~10V/div 1-2-5 increments impedance

for 50ohm input 1mV/div~1V/div 1-2-5 increments impedance

The vertical scale indicator for each channel on the bottom of the display changes accordingly.

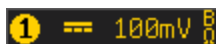

















































# Automatic Measurement



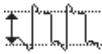
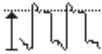

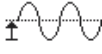







The automatic measurement function measures and updates major items for Voltage/Current, Time, and Delay type measurements.







## Measurement Items

	V/I Measurements	Time Meas.	Delay Meas.
Overview	Pk-Pk  Max  Min  Amplitude  High  Low  Mean  Cycle Mean  RMS  Cycle RMS  Area  Cycle Area  ROVShoot  FOVShoot  RPREShoot  FPREShoot 	Frequency  Period  RiseTime  FallTime  +Width  -Width  DutyCycle  +Pulses  -Pulses  +Edges  -Edges  % Flicker  Flicker Idx 	FRR  FRF  FFR  FFF  LRR  LRF  LFR  LFF  Phase 





Voltage/Current Measurement	Pk-Pk (peak to peak) 	Difference between positive and negative peak. (=max - min)
	Max 	Positive peak.
	Min 	Negative peak.





Amplitude		Difference between the global high value and the global low value, measured over the entire waveform or gated region. (=high – low)
High		Global high voltage. See page 54 for details.
Low		Global low voltage. See page 54 for details.
Mean		The arithmetic mean value is calculated for all data samples as specified by the Gating option.
Cycle Mean		The arithmetic mean value is calculated for all data samples within the first cycle found in the gated region.
RMS		The root mean square of all data samples specified by the Gating option.
Cycle RMS		The root mean square value is calculated for all data samples within the first cycle found in the gated region.
Area		Measures the positive area of the waveform and subtracts it from the negative area. The ground level determines the division between positive and negative areas.

	Cycle Area		The Summation based on all data samples within the first cycle found in the gated region.
	ROVShoot		Rise overshoot
	FOVShoot		Fall overshoot
	RPREShoot		Rise preshoot
	FPREShoot		Fall preshoot
Time Measurement	Frequency		Frequency of the waveform.
	Period		Waveform cycle time. (=1/Freq)
	RiseTime		The time required for the leading edge of the first pulse to rise from the low reference value to the high reference value.
	FallTime		The time required for the falling edge of the first pulse to fall from the high reference value to the low reference value.
	+Width		Positive pulse width.
	-Width		Negative pulse width.
	Duty Cycle		Ratio of signal pulse compared with whole cycle. =100x (Pulse Width/Cycle)

+Pulses		Measures the number of positive pulses.
-Pulses		Measures the number of negative pulses.
+Edges		Measures the number of positive edges.
-Edges		Measures the number of negative edges.
% Flicker		Ratio in percentage of the peak-to-peak value to the sum of peak values.
Flicker Idx		Ratio of the area above the average to the total area during one cycle.

**Delay Measurement**

FRR		Time between: Source 1 first rising edge and Source 2 first rising edge.
FRF		Time between: Source 1 first rising edge and Source 2 first falling edge.
FFR		Time between: Source 1 first falling edge and Source 2 first rising edge.
FFF		Time between: Source 1 first falling edge and Source 2 first falling edge.

LRR		Time between: Source 1 first rising edge and Source 2 last rising edge.
LFR		Time between: Source 1 first rising edge and Source 2 last falling edge.
LRF		Time between: Source 1 first falling edge and Source 2 last rising edge.
LFF		Time between: Source 1 first falling edge and Source 2 last falling edge.
Phase		The phase difference of two signals, calculated in degrees. $\frac{t1}{t2} \times 360^\circ$

### Add Measurement

The *Add Measurement* function allows you to add up to eight automatic measurement items on the bottom of the screen from any channel source.

Add  
Measurement  
Item

1. Press the *Measure* key.
2. Press *Add Measurement* from the bottom menu.

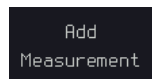
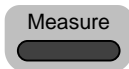

- Choose either a *V/I*, *Time* or *Delay* measurement from the side menu and choose the type of measurement you wish to add.

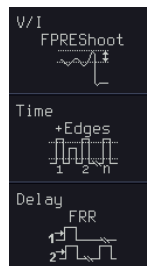

V/I (Voltage/ Current)	Pk-Pk, Max, Min, Amplitude, High, Low, Mean, Cycle Mean, RMS, Cycle RMS, Area, Cycle Area, ROVShoot, FOVShoot, RPREShoot, FPREShoot
Time	Frequency, Period, RiseTime, FallTime, +Width, -Width, Duty Cycle, +Pulses, -Pulses, +Edges, - Edges, %Flicker, FlickerIndex
Delay	FRR, FRF, FFR, FFF, LRR, LRF, LFR, LFF, Phase

- All of the chosen automatic measurements will be displayed in a window on the bottom of the screen. The channel number and channel color indicate the measurement source.  
For the analog inputs: yellow = CH1, blue = CH2.

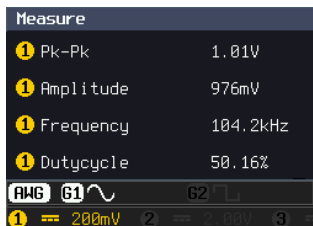

**Choose a Source** The channel source for measurement items can be set either before or when selecting a measurement item.

- To set the source, press either the *Source1* or *Source2* key from the side menu and choose the source.

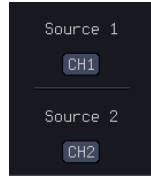

Range Source1: CH1~CH4, Math,  
Source2: CH1~CH4, Math



Note

Source 2 is only applicable to Delay measurements.

### Remove Measurement

Individual measurements can be removed at any time using the Remove Measurement function.

Remove Measurement Item

- Press the *Measure* key.

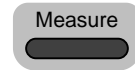

- Press *Remove Measurement* from the bottom menu.

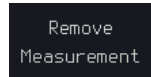

- Press *Select Measurement* and select the item that you want to remove from the measurement list.

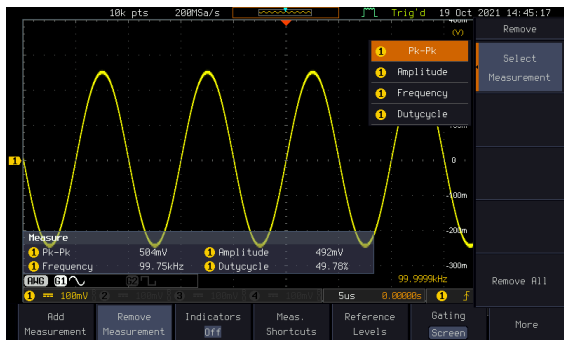
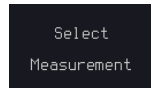

Remove All Items Press *Remove All* to remove all the measurement items.

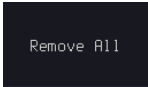

Indicator

1. Press the *Measure* key.
2. Push *Indicators* to visual measurement indicator. User can select measurement of interest from the added list and visualize the result corresponding to the waveform.

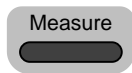

Note

Only one measurement item can be selected to display per time.

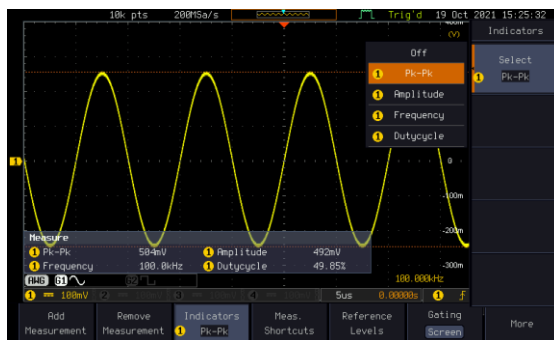



## Measurement Shortcuts

Users can use the Measure Shortcuts function to select the item to be measured, and then store the selected item in Shortcut 1~4, which can be selected to conduct measurements for the same product next time. Users just select the previously stored Shortcut 1~4 without making new selections from Add measurement and all the measurement items will be displayed on the screen to improve the measurement efficiency.

1. Press the *Measure* key.

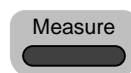

2. Press *Meas. Shortcuts* from the bottom menu.

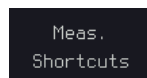

3. Current selected measurement items can be saved for quick use in the future by pressing *Select* key.

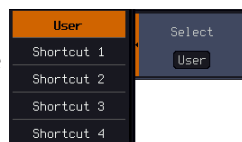

If *User* option is selected, the current measurement item will be changed to this item (*User*) when there is a change in the contents of shortcut key 1~4.

If *Shortcut1~4* is selected, 4 sets of custom measurement item settings can be stored.

Save user to a shortcut

Press *Save User to* key and then select a shortcut to save the current measurement items.



Measure display Press *Display* key and then select whether the measurement item displays in landscape or portrait orientation or turn off the “Measure” display.



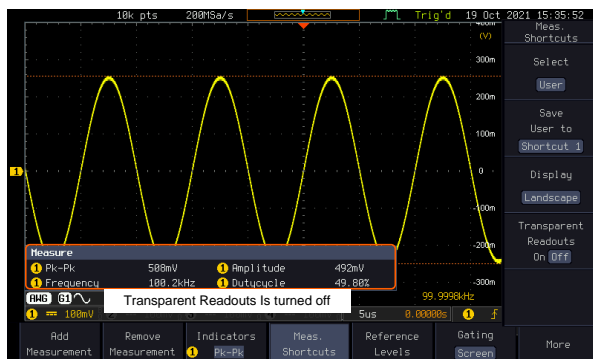
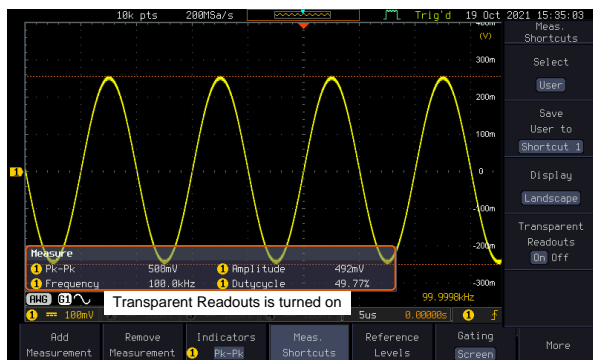
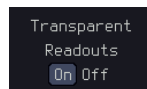

Transparent Readout

Select transparent readout background or turn off this function by press *Transparent Readouts On/Off*.



### Gated mode

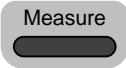

Some automatic measurements can be limited to a “gated” area between cursors. Gating is useful for measuring a magnified waveform or when using a fast time base. The Gated mode has three possible configurations: Off (Full Record), Screen and Between Cursors.

Set Gating Mode	<ol style="list-style-type: none"> <li>1. Press the <i>Measure</i> key.</li> </ol>	
	<ol style="list-style-type: none"> <li>2. Press <i>Gating</i> from the bottom menu.</li> </ol>	
	<ol style="list-style-type: none"> <li>3. Choose one of the gating modes from the side menu: <i>Off (full record)</i>, <i>Screen</i>, <i>Between Cursors</i>.</li> </ol>	

Cursors On Screen	If <i>Between Cursors</i> is selected, the cursor positions can be edited by using the cursor menu.	Page 59
-------------------	---	---------

### Display All mode

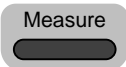
Display All mode shows and updates all items from Voltage and Time type measurements.

View Measurement Results	<ol style="list-style-type: none"> <li>1. Press the <i>Measure</i> key.</li> </ol>	
	<ol style="list-style-type: none"> <li>2. Press the <i>More</i> key.</li> </ol>	

3. Press *Display All* from the bottom menu.



4. Press Source from the side menu and choose a measurement source.



Range CH1~CH2 (or CH4 for 4CH models), Math

5. The results of Voltage and Time type measurements appear on the display.



Remove Measurements

To remove the measurement results, press *OFF*.



Delay Measurements

Delay type measurements are not available in this mode as only one channel is used as the source. Use the individual measurement mode (page 47) instead.

## High Low Function

Background

The High-Low function is used to select the method for determining the value of the High-Low measurement values.

**Auto** Automatically chooses the best high-low setting for each waveform when measuring.

**Histogram** Uses histograms to determine the high-low values. This mode ignores any pre-shoot or overshoot values. This mode is particularly useful for pulse-type waveforms

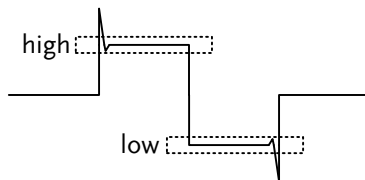

**Min-max** Sets the high-low values as the minimum or maximum measured values.

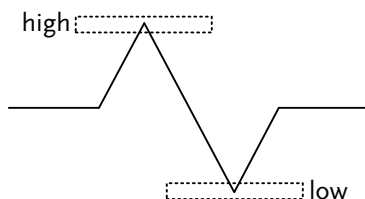

**Set High-Low**

1. Press the *Measure* key.

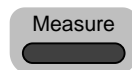

2. Press the *More* key.



3. Press *High-Low* from the bottom menu.

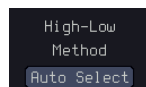

4. Select the type of High-Low settings from the side menu.

High-Low Settings Histogram, Min-Max, Auto

Restore Default High-Low Settings

To return to the default High-Low settings, press *Set to Defaults*.

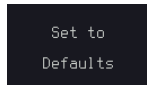

## Statistics

---

Background

The Statistics function can be used to view a number of statistics for the selected automatic measurements. The following information is displayed with the Statistics function:

Value	Currently measured value
Mean	The mean value is calculated from a number of automatic measurement results. The number of samples used to determine the mean can be user-defined.
Min	The minimum value observed from a series of measured results for the selected automatic measurement items.
Max	The maximum value observed from a series of measured results for the selected automatic measurement items.
Standard Deviation	The variance of the currently measured value from the mean. The standard deviation equals the squared root of the variance value. Measuring the standard deviation can, for example, determine the severity of jitter in a signal. The number of samples used to determine the standard deviation can be user-defined.

Panel Operation

1. Press the *Measure* key.

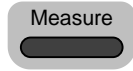

2. Press the *More* key.



3. Select at least one automatic measurement.

Page 47

4. Press *Statistics* from the bottom menu.



5. Set the number of samples to be used in the mean and standard deviation calculations.

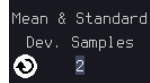

Samples 2~1000

6. Press *Statistics* and turn Statistics on.

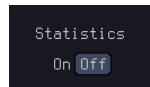

7. The statistics for each automatic measurement will appear at the bottom of the display in a table.

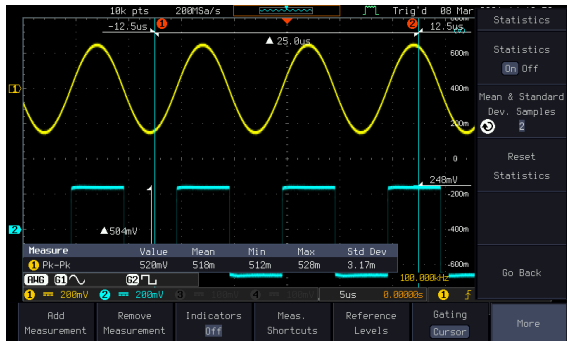

Reset Statistics

To reset the standard deviation calculations, press *Reset Statistics*.

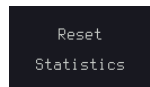

## Reference Levels

**Background** The reference level settings determine the measurement threshold levels for some measurements like the Rise Time measurement.



**High Ref:** Sets the high reference level.

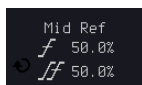

**Mid Ref:** Sets the middle reference for the first and second waveforms.

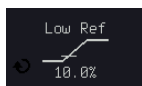

**Low Ref:** Sets the low reference level.

**Panel Operation** 1. Press the *Measure* key.

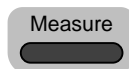

2. Press *Reference Levels* from the bottom menu.

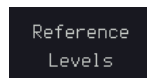

3. Set the reference levels from the side menu. Ensure the reference levels do not cross over.

High Ref      0.0% ~ 100%

Mid Ref        0.0% ~ 100%

0.0% ~ 100%

Low Ref        0.0% ~ 100%

**Default Settings** 4. Press *Set to Defaults* to set the reference levels back to the default settings.

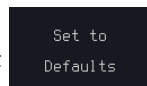





# Cursor Measurement

Horizontal or vertical cursors are used to show the position and values of waveform measurements and math operation results. These results cover voltage, time, frequency and other math operations. When the cursors (horizontal, vertical or both) are activated, they will be shown on the main display unless turned off.

## Use Horizontal Cursors

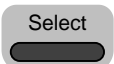
- Panel Operation
1. Press the *Cursor* key once. 
  2. Press *H Cursor* from the bottom menu if it is not already selected. 
  3. When the H Cursor is selected, repeatedly pressing the *H Cursor* key or the *Select* key will toggle which cursor is selected.  or 

Range	Description
∷	Left cursor (1) movable, right cursor position fixed
∷	Right cursor (2) movable, left cursor position fixed
	Left and right cursor (1+2) movable together

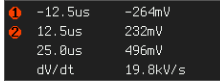
4. The cursor position information appears on the top left hand side of the screen. 
- Cursor 1 Hor. position, Voltage/Current  
 Cursor 2 Hor. position, Voltage/Current  
 Δ Delta (difference between cursors)

dV/dt or dI/dt

- Use the *VARIABLE* knob to move the movable cursor(s) left or right.

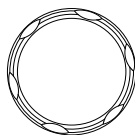

Note

The selected cursor(s) will move along the active waveform. To move along another waveform, select its corresponding channel and press the cursor key again to re-enter the cursor menu.

Select Units

- To change the units of the horizontal position, press *H Unit*.

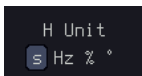

Units S, Hz, % (ratio), °(phase)

Phase or Ratio Reference

- To set the 0% and 100% ratio or the 0° and 360° phase references for the current cursor positions, press *Set Cursor Positions As 100%*.

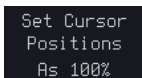

Example

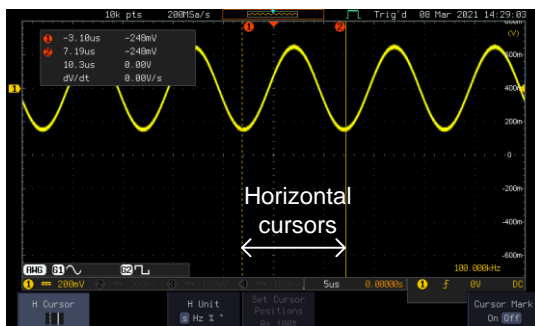

FFT

FFT cursors can use different units. For FFT details, see page 68.

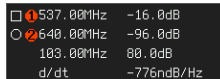

- Cursor 1 Hor. position, dB/Voltage
- Cursor 2 Hor. Position, dB/Voltage
- △ Delta (difference between cursors)
- dV/dt or d/dt

Example

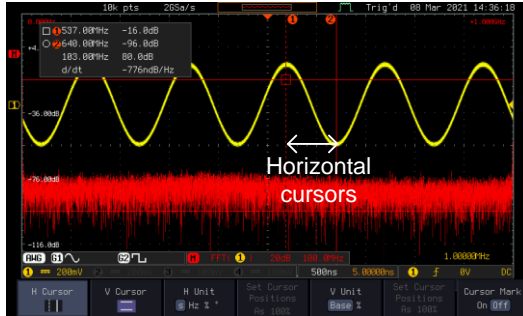

XY Mode

XY mode cursors measure a number of X by Y measurements. See page 81.

(X) Versus (Y)	①	②	Δ
t:	-245ns	545ns	790ns
Rectangular x: y:	72.0mV -120mV	248mV 16.0mV	176mV 136mV
Polar r: θ:	189mV -59.0°	248mV 3.69°	222mV 37.6°
Product x·y:	-8.64mV <sup>2</sup>	3.96mV <sup>2</sup>	23.9mV <sup>2</sup>
Ratio y/x:	-1.66V/V	64.5mV/V	772mV/V

Cursor ① Time, rectangular, polar coordinates, product, ratio.

Cursor ② Time, rectangular, polar coordinates, product, ratio.

Δ Delta (difference between cursors)

Example

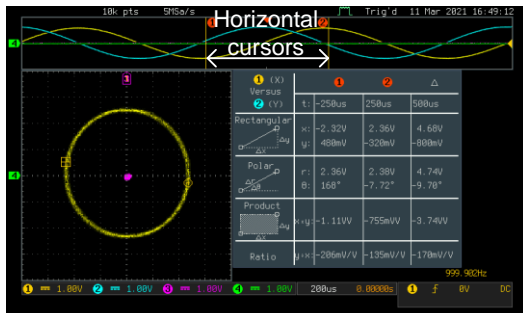

## Use Vertical Cursors

Panel Operation/  
Range

1. Press the *Cursor* key twice.

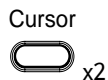

2. Press *V Cursor* from the bottom menu if it is not already selected.



3. When the *V Cursor* is selected, repeatedly pressing the *V Cursor* key or the *Select* key will toggle which vertical cursor is selected.



or

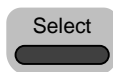

Range



Upper cursor movable, lower cursor position fixed



Lower cursor movable, upper cursor position fixed



Upper and lower cursor movable together

4. The cursor position information appears on the top left hand side of the screen (if the "Cursor Mark" is set to OFF).

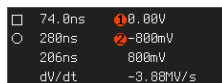

Time: cursor 1, cursor 2



Voltage/Current: cursor1, cursor2



Delta (difference between cursors)

dV/dt or dI/dt

5. Use the *VARIABLE* knob to move the cursor(s) up or down. VARIABLE



Select Units

6. To change the units of the vertical position, press *V Unit*.

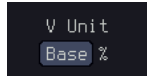

Units      Base (source wave units), % (ratio)

Base or Ratio Reference

7. To set the 0% and 100% ratio references for the current cursor position, press *Set Cursor Positions As 100%*.

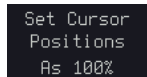

Example

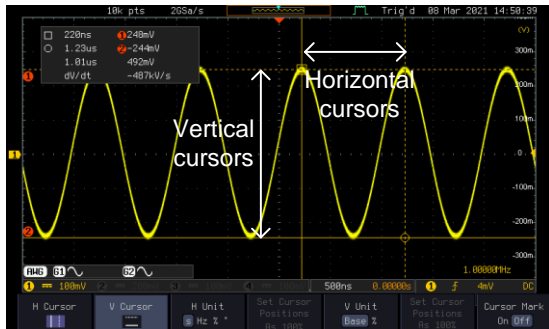

FFT

FFT has different content. For FFT details, see page 68.

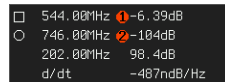

- , ○      Frequency/Time: cursor1, cursor2
- ①, ②      dB/V: cursor1, cursor2
- △      Delta (difference between cursors)
- d/dt

Example

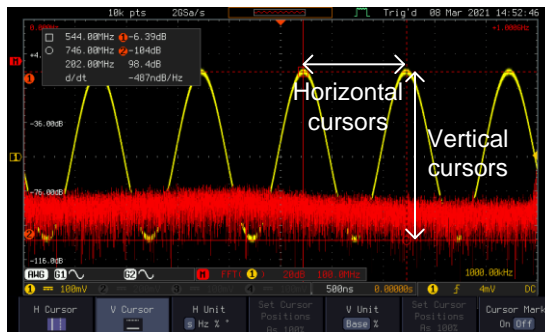

XY Mode

XY mode cursors measure a number of X by Y measurements. See page 81.

	①	②	△
Versus ① (X) ② (Y)	t: -245ns	545ns	790ns
Rectangular 	x: 72.0mV y: -120mV	248mV 16.0mV	176mV 136mV
Polar 	r: 139mV θ: -59.0°	248mV 3.69°	222mV 37.6°
Product 	x*y: -8.64mVV	3.96mVV	23.9mVV
Ratio 	y/x: -1.66V/V	64.5mV/V	772mV/V

- Cursor ① Rectangular, polar co-ordinates, product, ratio.
- Cursor ② Rectangular, polar co-ordinates, product, ratio.
- △ Delta (difference between cursors)

Example

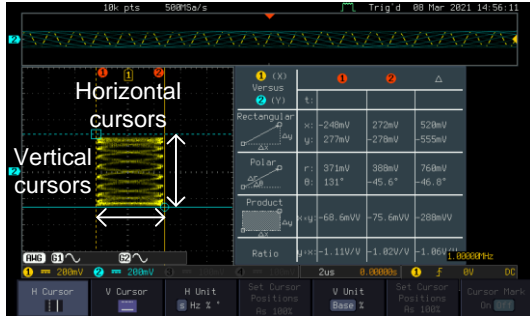

Cursor Mark  
(On/off)

The information of cursor is displayed on cursor when the Cursor Mark function is activated.

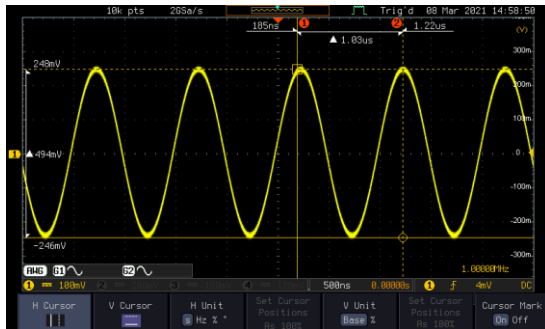



# Math Operation

## Basic Math Overview & Operators

Background	The Math function performs basic math functions (addition, subtraction, multiplication, division) on the input signals or the reference waveforms. The resultant waveform will be shown on the screen in real-time.	
Addition (+)	Adds the amplitude of two signals.	
	Source	CH1~4, Ref1~4
Subtraction (-)	Extracts the amplitude difference between two signals.	
	Source	CH1~4, Ref1~4
Multiplication (×)	Multiplies the amplitude of two signals.	
	Source	CH1~4, Ref1~4
Division (÷)	Divides the amplitude of two signals.	
	Source	CH1~4, Ref1~4

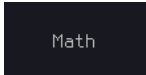
## Addition/Subtraction/Multiplication/Division

Panel Operation	1. Press the <i>Math</i> key.	
	2. Press the <i>Math</i> key on the lower bezel.	
	3. Select <i>Source 1</i> from the side menu.	
	Range	CH1~4, Ref1~4



4. Press *Operator* to choose the math operation.

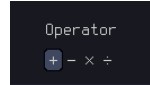

Range +, -, ×, ÷

5. Select *Source 2* from the side menu.



Range CH1~4, Ref1~4

6. The math measurement result appears on the display. The vertical scale of the math waveform appears at the bottom of the screen.



From left: Math function, source1, operator, source2, Unit/div

**Example**

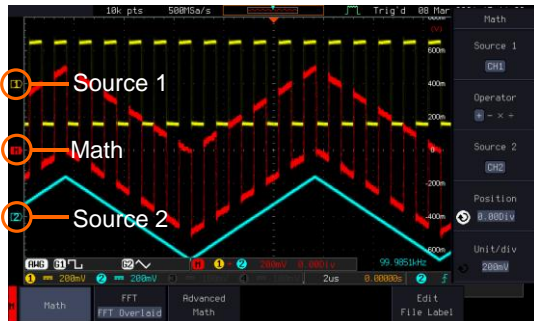

- Position and Unit To move the math waveform vertically, press the *Position* key from the side menu and use the *VARIABLE* knob to set the position.



Range -12.00 Div ~ +12.00 Div

To change the unit/div settings, press *Unit/div*, then use the *VARIABLE* knob to change the unit/div.



The units that are displayed depend on which operator has been selected, and whether the probe for the selected channel has been set to voltage or current.

Operator:	Unit/div:
Multiplication	VV, AA or W
Division	V/V, A/A
Addition/Subtraction	V or A

**Turn Off Math** To turn off the Math result from the display, press the *Math* key again.



## FFT Overview & Window Functions

**Background** The FFT function performs a Fast Fourier Transform on one of the input signals or the reference waveforms. The resultant spectrum will be shown on the screen in real-time. Four types of window function are available: Hanning, Hamming, Rectangular, and Blackman, as described below.

<b>Hanning</b>	Frequency resolution	Good
	Amplitude resolution	Not good
	Suitable for...	Frequency measurement on periodic waveforms

<b>Hamming</b>	Frequency resolution	Good
	Amplitude resolution	Not good

	Suitable for...	Frequency measurement on periodic waveforms
Rectangular	Frequency resolution	Very good
	Amplitude resolution	Bad
	Suitable for...	Single-shot phenomenon (this mode is the same as having no window at all)
Blackman	Frequency resolution	Bad
	Amplitude resolution	Very good
	Suitable for...	Amplitude measurement on periodic waveforms
 Note	For more complete measures and functions in the frequency domain of a signal, please also refer to the Spectrum Analyzer section of the GDS-3000A series on page 227.	

### FFT Operation

Panel Operation 1. Press the *Math* key.

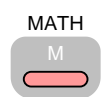

2. Press *FFT* from the bottom menu to select a FFT display mode.

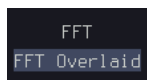

3. FFT contains up to 3 display methods.



**FFT-overlaid**

The time domain waveform overlaps with the FFT waveform.

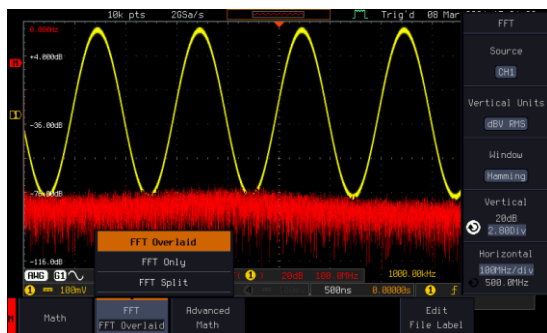

**FFT-only**

Only FFT display is shown.

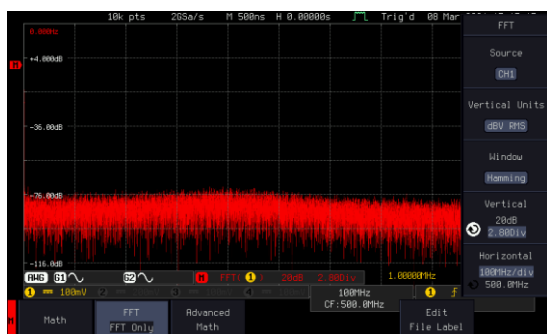

**FFT-split**

The time domain waveform is shown in the upper section, whereas the FFT display is shown in the lower section.

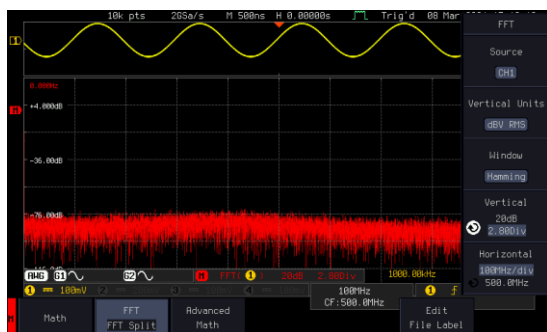

4. Select the *Source* from the side menu.



Range CH1~4, Ref 1~4

5. Press the *Vertical Units* key from the side menu to select the vertical units used.



Range Linear RMS, dBV RMS

6. Press the *Window* key from the side menu and select the window type.



Range Hanning, Hamming, Rectangular, and Blackman.

7. The FFT result represents the frequency-domain representation of a signal. Hence, the horizontal scale changes from time to frequency, and the vertical scale from voltage/current to dB/RMS.

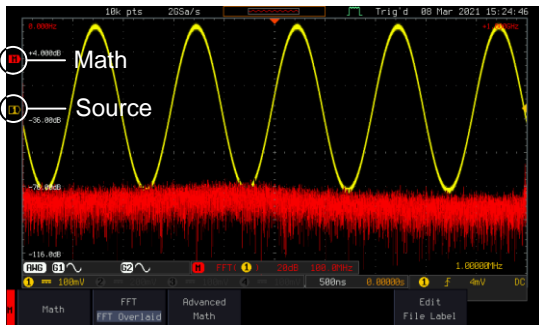

Position and Scale

To move the FFT waveform vertically, press *Vertical* until the *Div* parameter is highlighted and then use the *VARIABLE* knob.



Range -12.00 Div ~ +12.00 Div

To select the vertical scale of the FFT waveform, press *Vertical* until the *dB* or *voltage* parameters are highlighted and then use the *VARIABLE* knob.



Range      2mV~1kV RMS (Linear RMS), 1~20 dB (dB VRMS)

Horizontal Position and Scale

To move the FFT waveform horizontally, press *Horizontal* until the *Frequency* parameter is highlighted and then use the *VARIABLE* knob.



Range      0Hz ~ half of the sampling frequency

To select the horizontal scale of the FFT waveform, press *Horizontal* repeatedly until the *Hz/div* parameter is highlighted and then use the *VARIABLE* knob.



## Advanced Math Overview

Background

The advanced math function allows complex math expressions to be created based on the input sources, reference waveforms or even the automatic measurements available from the *Measure* menu (see page 43).

An overview of each of the major parameters that can be used in the advanced math function are shown below:

Expression

Displays the function expression as it is created.

Source

Selects the source signal.

Source      CH1~4, Ref1~4

Function

Adds a mathematical function to the expression.

	Function	Intg, Diff, log, Ln, Exp, Sqrt, Abs, Rad, Deg, Sin, Cos, Tan, Asin, Acos, Atan
Variable		Adds a user-specified variable to the expression.
	Source	CH1~4, Ref1~4
Operator		Adds an operator or parenthesis to the function expression.
	Operator	+, -, *, /, (, ), !(, <, >, <=, >=, ==, !=,   , &&
Figure		Adds a value to the expression.
	Figure	Integers, floating point, or floating point with exponent values.
Measurement		Adds automatic measurements to the expression. Not all automatic measurements are supported.
	Measurement	Pk-Pk, Max, Min, Amp, High, Low, Mean, CycleMean, RMS, CycleRMS, Area, CycleArea, ROVShoot, FOVShoot, Freq, Period, Rise, Fall, PosWidth, NegWidth, Dutycycle, FRR, FRF, FFR, FFF, LRR, LRF, LFR, LFF, Phase, RPRFShoot, FPRESshoot, +Pulses, -Pulses, +Edges, -Edges

### Advanced Math Operation

Panel Operation 1. Press the *Math* key.



2. Press *Advanced Math* from the bottom menu.

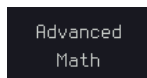

3. Press Edit Expression.

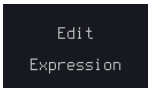

4. The Edit f(x) screen appears. CH1 + CH1 is shown in the expression box as an example at startup.

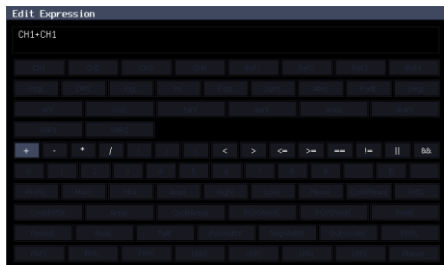

5. Press *Clear* to clear the expression entry area.



6. Use the *VARIABLE* knob and the *Select* key to create an expression.

Use the *VARIABLE* knob to highlight a source, function, variable, operator, figure or measurement in orange.

Press the *Select* key to make the selection.

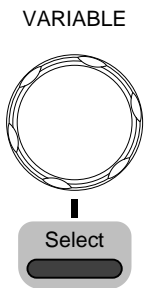

If a particular parameter is grayed out, it indicates that the particular parameter is not available at that time.

Back Space

7. To delete the last parameter press *Back Space*.

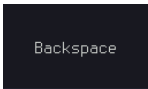



- When the expression is complete, press *OK Accept*.

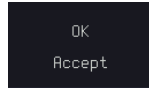

- Load recent expression: It loads the previous expression setting.

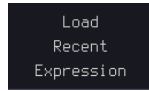

Example:  
CH1 + CH2

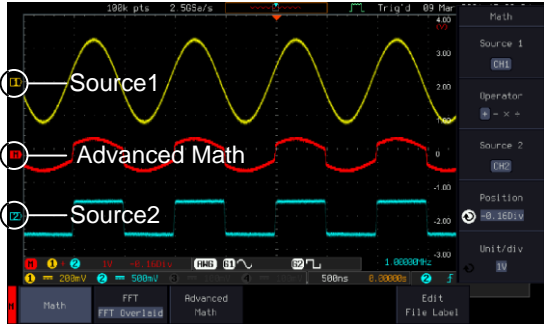

Set the VAR1 & VAR2

- Press *VAR1* or *VAR2* to set VAR1/VAR2 if they were used in the expression created previously.



- Use the numerical keypad on the front panel to set the value of the selected digit.

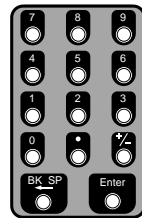

- Use the *VARIABLE* knob to set the exponent of the variable. Input number via pressing the numerical keypad followed by pressing the Enter to confirm.

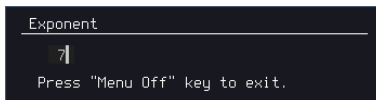

13. Press *menu off* to finish editing VAR1 or VAR2.

Menu Off



Vertical Position and Scale

14. Press *Unit/div* and use the *VARIABLE* knob to set the vertical scale of the math waveform.



15. Press *Position* and use the *VARIABLE* knob to set the vertical position of the math waveform on the display.



Clear Advanced Math

To clear the advanced math result from the display, press the *Math* key again.

MATH



# ADVANCED CONFIGURATION

---

Acquisition .....	80
Select Acquisition Mode.....	80
Show Waveform in XY Mode .....	81
Set the Record Length .....	84
Segmented Memory Acquisition .....	85
Segments Display .....	86
Set the Number of Segments .....	87
Run Segmented Memory.....	88
Navigate Segmented Memory .....	89
Play Through Each Segment.....	90
Measurement on Segments.....	91
Segment Info .....	94
Horizontal View .....	96
Move Waveform Position Horizontally .....	96
Select Horizontal Scale .....	97
Select Waveform Update Mode.....	97
Zoom Waveform Horizontally .....	99
Play/Pause .....	101
Vertical View (Channel) .....	104
Move Waveform Position Vertically.....	104
Select Vertical Scale.....	105
Select Coupling Mode.....	105
Input Impedance .....	106
Invert Waveform Vertically .....	106
Limit Bandwidth.....	107
Fine Scale .....	109
Expand by Ground/Center.....	110
Select Probe Type.....	111
Select Probe Attenuation Level .....	112
Set the Deskew .....	112
Bus Key Configuration .....	114

Bus Display .....	114
Serial Bus Overview .....	115
UART Serial Bus Configuration .....	117
I <sup>2</sup> C Serial Bus Interface .....	119
Serial Bus Interface.....	120
Parallel Bus .....	123
Input Configuration .....	123
Threshold Configuration.....	124
Bus Encoding .....	125
Parallel Bus Event Table .....	125
Adding a Label to the Parallel Bus .....	126
CAN Serial Bus Interface.....	128
LIN Serial Bus Interface.....	129
Bus Encoding.....	130
Threshold configuration.....	131
Serial Bus Event Tables.....	132
Event Tables Format .....	134
Adding a Label to a Bus .....	135
Using Cursors with the Serial Bus .....	137
<b>Trigger .....</b>	<b>139</b>
Trigger Type Overview.....	139
Trigger: types and sources.....	141
Trigger Parameter Overview .....	141
Setup Holdoff Level.....	148
Setup Trigger Mode .....	149
Using the Edge Trigger .....	149
Using Advanced Delay Trigger.....	151
Using Pulse Width Trigger.....	152
Using Video Trigger.....	154
Pulse Runt trigger .....	156
Using Rise and Fall Trigger.....	157
Using the Timeout Trigger .....	158
Using the Bus Trigger .....	160
UART BUS Trigger Settings .....	160
I <sup>2</sup> C Bus Trigger Settings .....	162
SPI Bus Trigger Settings.....	165
CAN Bus Trigger.....	166
LIN Bus Trigger.....	169
Parallel Bus Trigger .....	171
Using the Logic Trigger.....	172
<b>Search.....</b>	<b>176</b>
Configuring Search Events .....	176
Copying Search Event To/From Trigger Events.....	178
Search Event Navigation.....	178

---

Save Search Marks.....	179
Setting/Clearing Single Search Events .....	180
FFT Peak.....	180
<b>System Settings .....</b>	<b>184</b>
Select Menu Language .....	184
View System Information .....	184
Erase Memory .....	185
Erase Disk.....	185
Set Date and Time.....	186
Probe Compensation Frequency .....	187
QR Code Reader Function .....	187
<b>Display .....</b>	<b>189</b>
Display Waveform as Dots or Vectors.....	189
Ruler On/Off.....	189
Set the Intensity Level .....	190
Select Display Graticule .....	193
Freeze the Waveform (Run/Stop) .....	194
Turn Off Menu.....	194

## Acquisition

The Acquisition process samples the analog input signals and converts them into digital format for internal processing.

### Select Acquisition Mode

---

Background	The acquisition mode determines how the samples are used to reconstruct a waveform.
Sample	This is the default acquisition mode. Every sample from each acquisition is used.
Peak detect	Only the minimum and maximum value pairs for each acquisition interval (bucket) are used. This mode is useful for catching abnormal glitches in the signal.
Hi Resolution	Performs boxcar averaging on the samples. This reduces white noise and increases the vertical resolution of the waveform.
Average	Multiple acquired data is averaged. This mode is useful for drawing a noise-free waveform. To select the average number, use the VARIABLE knob.  Average number: 2, 4, 8, 16, 32, 64, 128, 256 and 512

Panel Operation 1. Press the *Acquire* key.

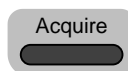

2. To set the Acquisition mode, press *Mode* on the bottom menu.

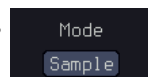

3. Select an acquisition mode from the side menu.
4. If *Average* was chosen, set the number of samples to be used for the average function.

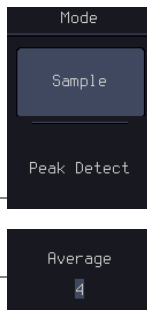

Mode	Sample, Peak Detect, Average
Average sample	2, 4, 8, 16, 32, 64, 128, 256, 512

Example

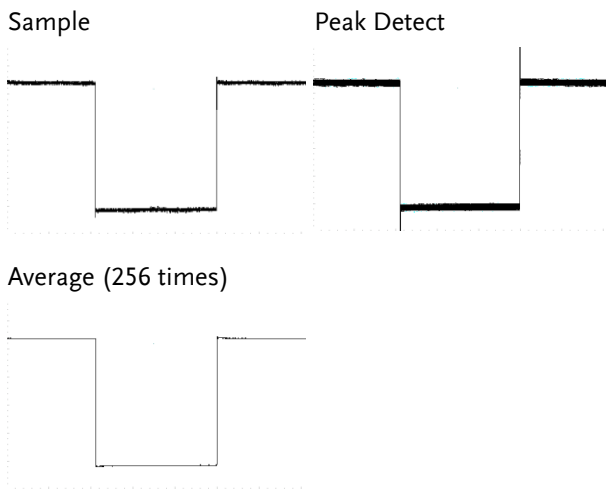

### Show Waveform in XY Mode

Background

The XY mode maps the voltage of channel 1 to the voltage of channel 2. In 4 channel models, the voltage of channel 3 is mapped to the voltage of channel 4. This mode is useful for observing the phase relationship between waveforms.

Reference waveforms can also be used in XY mode. Ref1 is mapped to Ref2 and Ref3 is mapped to Ref4. Using the reference waveforms is the same as using the channel input waveforms.

Connection

1. Connect the signals to Channel 1 (X-axis) and Channel 2 (Y-axis) or Channel 3 (X2-axis) and Channel 4 (Y2-axis)

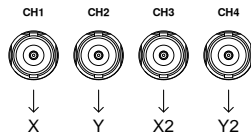

2. Make sure a channel pair is active (CH1 & CH2 or CH3 & CH4). Press the Channel key if necessary. A channel is active if the channel key is lit.



Panel Operation

3. Press the *Acquire* menu key.

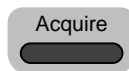

4. Press XY from the bottom menu.

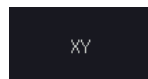

5. Choose *Triggered XY* from the side menu.

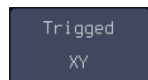

X-Y mode is split into two windows. The top window shows the signals over the full time range. The bottom window shows XY mode.

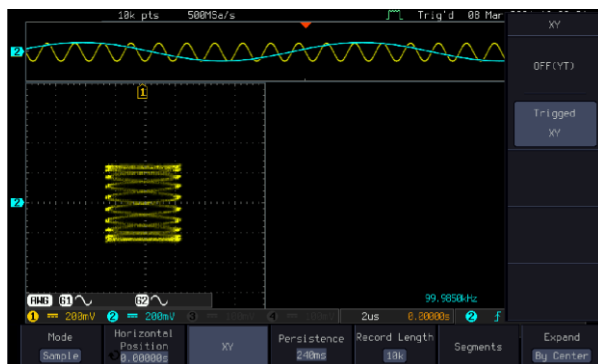



To move the XY waveform position, use the vertical position knob: Channel 1 knob moves the XY waveform horizontally and Channel 2 knob moves the XY waveform vertically. Similarly, the X2 and Y2 axis can be positioned using the channel 3 and channel 4 vertical position knobs.

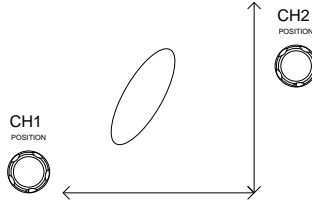



The horizontal position knob and horizontal Scale knob can still be used under the XY mode.

**Turn Off XY Mode** To turn off XY mode, choose *OFF (YT)* mode. 

**Cursors and XY Mode** Cursors can be used with XY mode. See the Cursor chapter for details. [Page 59](#)

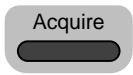
**Persistence** The persistence function allows the GDS-3000A to mimic the trace of a traditional analog oscilloscope. A waveform trace can be configured to “persist” for designated amount of time.

- Panel Operation**
6. Press the *Acquire* menu key. 
  7. To set the persistence time, press the *Persistence* menu button on the bottom bezel. 
  8. Use the *VARIABLE* knob to select a persistence time. 

Time                      Auto, 16ms~4s, Infinite, Off

Clear Persistence    It clears the Persistence effect.

## Set the Record Length

**Background** The number of samples that can be stored is set by the record length. Record length is important in an oscilloscope as it allows longer waveforms to be recorded.

The maximum record length for the GDS-3000A SERIES depends on operating mode. The table below describes the record lengths that are available for each mode.

### Limitation

Record Length	1k	10k	100k	1M	10M	100M	200M
Single Window	✓	✓	✓	✓	✓	✓	✓
Zoom	✗	✓	✓	✓	✓	✓	✓
FFT	✓	✓	✓	✓	✗	✗	✗
Zoom+FFT	✗	✓	✓	✓	✗	✗	✗
Digital Filter	✓	✓	✓	✓	✗	✗	✗
Roll+MATH	✓	✓	✓	✗	✗	✗	✗
Average	✓	✓	✓	✓	✗	✗	✗
Zoom+Average	✗	✓	✓	✗	✗	✗	✗
Segment	✓	✓	✓	✓	✗	✗	✗
LA	✗	✓	✓	✓	✓	✗	✗
HighRes	✓	✓	✓	✓	✓	✓	✗

**Panel Operation** 1. Press the *Acquire* key.

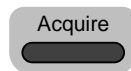

2. Press the *Record Length* key on the bottom menu and choose the record length.



Record length 1k, 10k, 100k, 1M, 10M, 200M



Note

The sampling rate may also be changed when the record length is changed.

## Segmented Memory Acquisition

The advanced segmented memory utility allows the scope memory to be divided into different segments. Each time the scope is triggered, it only acquires data for one segment of memory at a time. This allows you to optimize the scope memory to only perform signal acquisition during important signal events.

For example, for a signal with a number of pulses, normally the oscilloscope will acquire the signal until the acquisition memory of the scope is filled up and then it will re-arm the trigger and then capture again. This could result in a number of events not being captured or captured at a less-than-desired resolution (depending on the horizontal scale and sampling rate). However, the segmented memory function would effectively allow you to capture more of the signal than you would otherwise. The diagrams below illustrate this point.

Normal acquisition mode example:

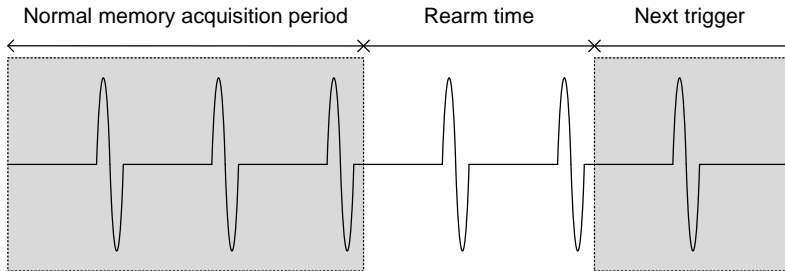

Segmented memory acquisition example:

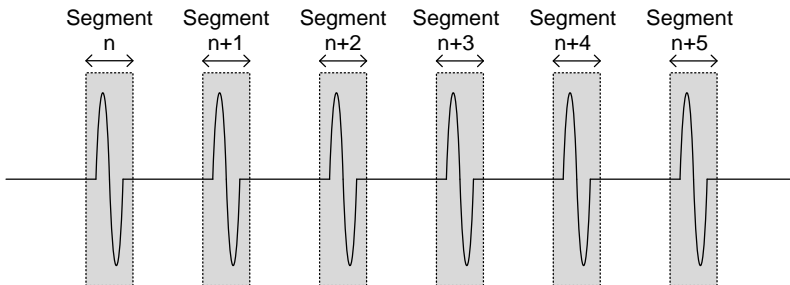

As shown above, the memory is divided into segments to increase the number of events that can be effectively captured with the same acquisition memory. Also notice that the scope doesn't need to rearm the trigger between each segment, this makes the segmented memory function especially useful for high speed signals. The time between each segment is also recorded so that accurate signal timing can also be measured.

The segmented memory function also supports automatic measurements for each segment or statistics for all the captured segments.

The advanced Segment Memory Utility is available for both analog and digital channels.

### Segments Display

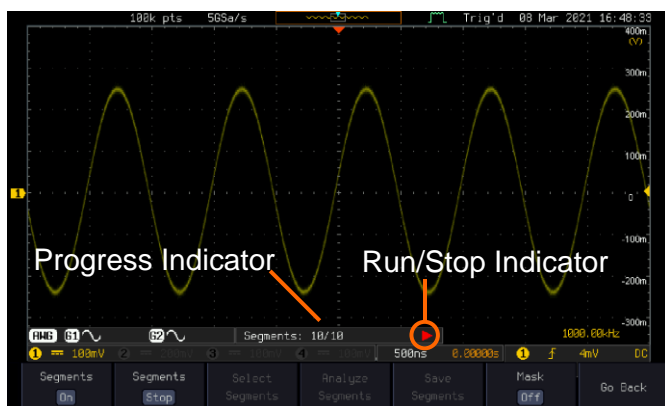

Progress Indicator

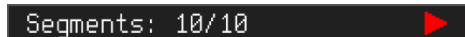

Indicates the number of segments that have to be captured relative to the set number of segments.

Run/Stop Indicator



Stop: The segments have finished acquiring or have been stopped.



Run: The scope is ready to acquire segments.

## Set the Number of Segments

**Background** Before the Segment function can be used, set the trigger settings as appropriate for the signal you wish to use. The number of segments that can be used depends wholly on the record length. See page 84 to set the record length.



Note

Segment supports up to 1M points record length.

Record length	Number of segments
1000 pt.	1 ~ 490,000
10k pt.	1 ~ 49,000
100k pt.	1 ~ 4,900
1M pt.	1 ~ 490

**Panel Operation** 1. Press the *Acquire* key.



2. Press *Segments* on the bottom menu.



3. Press *Select Segments* and set the number of segments from the side menu.



Num of Seg	1~490,000 (record length dependent)
------------	-------------------------------------

Set to Maximum	Sets to the maximum number
----------------	----------------------------

Set to Minimum	Sets to 1 segment
----------------	-------------------



Note

The Select Segments icon is only available when Segments = OFF or when Segments is in the STOP mode (see the section below).

## Run Segmented Memory

**Background** Before the Segmented Memory function can be used, set the trigger settings as appropriate for the signal you wish to use. See page 139 for configuring the trigger settings.

**Run Segments** 1. Toggle *Segments On* from the bottom menu.



2. The scope will automatically start acquiring segments. The progress of the segmented memory capture is shown in the Progress Indicator.
3. The Run Indicator will be shown when in the Run mode and the Segments icon will also indicate that the function is in run mode.

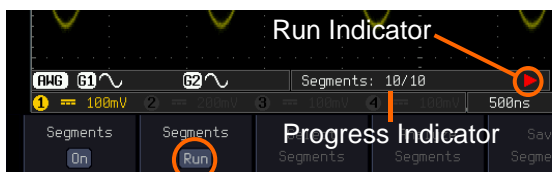

Segment (Run)icon

4. When the scope has finished acquiring segments, press *Segments Run* to toggle the mode to the *Segments Stop* mode.



Alternatively, the *Run/Stop* key can be pressed.

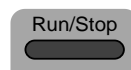

5. The Stop Indicator will be shown when in the Stop mode.

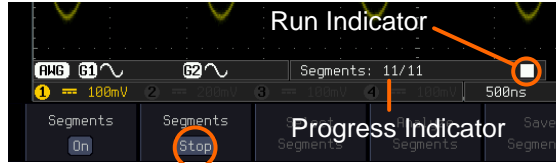

Segment (Stop)icon

The scope is now ready to navigate or analyze the acquired segments.

- Rerun Segmented Acquisition
- To rerun the segments, press the *Segments Stop* key to toggle the mode back to the *Segments Run* mode.



Alternatively, press the *Run/Stop* key again.

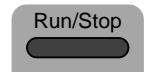

- Repeat steps 3 and 4 in the section above when the segmented acquisition has completed.

## Navigate Segmented Memory

**Background** After the segmented memory acquisitions have been captured you can navigate through each segment one at a time.

- Operation**
- Press *Select Segments* from the bottom menu. This key will be available in the Stop mode.

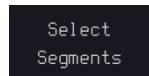

- To navigate to the segment of interest, press *Current Seg* from the side menu and use the VARIABLE knob to scroll to the segment of interest.  
Alternatively, the *Set to Minimum* and *Set to Maximum* keys can be used to jump to the first and last segment respectively.
- The position in time of the selected segment relative to the time of the first segment is shown in the *Segments Time* key.

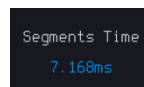

## Play Through Each Segment

---

**Background** When all the segments have been acquired, the play/pause key can be used to play back through each segment.

---

- Operation**
- Make sure the scope is in *Segments Stop* mode. See page 88 for details.
  - Press the *Play/Pause* key to run through the acquired segments in numerical order.
    - Press the Play/Pause key again to pause the playback.
    - When the scope has played through to the last segment, pressing the Play/Pause key again will play through each segment again in reverse order.





## Measurement on Segments

---

Background	<p>The Segmented memory function can be used in conjunction with the automatic measurements configured in the Measurement menu (see page 43).</p> <p>Please note that Digital channels measurements cannot be used in conjunction with the segmented memory.</p>	
Modes	Segments Measure	<p>This function will either perform statistics calculations on the segments or tabulate a list of the measurement results for all the segments.</p>
	Segments Info	<p>Provides configuration information common for all the acquired memory segments.</p>
Segments Measure	<p>The Segments Measure function allows you to view automatic measurements for the segments in statistical bins or as a list displaying the result of each automatic measurement.</p>	
	Statistics	<p>This function will bin the measurement results of a single automatic measurement into a user-defined number of bins. This enables the user to easily view the distribution of the measurement results for a large number of segments.</p>
	Measurement List	<p>Puts all the measurement results for a segment in a list. All the currently selected automatic measurement results are listed. A maximum of 8 automatic measurements can be used with this function.</p>



Note

To use automatic measurements with the segmented memory, automatic measurements must first be selected from the Measure menu before the segmented memory function is run. Note that Digital channels cannot use this function.

Setup

Press the *Measure* key and select any *single* source measurement from the *Add Measurement* menu.

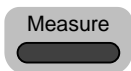

See page 47 for details on how to add automatic measurements.

Operation

1. Press *Analyze Segments* from the Segments menu.

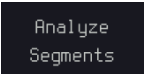

Note

This key will only be available in the Stop mode.

2. Press Segments Measure.



3. Select either the statistics or the measurement list from the side menu.



Statistics List

4. The statics table or measurement list appears on the display.

Note that the more segments that you have, the longer it will take to calculate the statics or list the measurement results.

- For statistic measurements, press *Plot Source* to choose which automatic measurement to use for the statistics calculations. The statistics for only one automatic measurement can be viewed at a time.



- For the measurement list, press *Source* and select the source channel for measurement.



Range CH1 ~ CH4

**Statistics Results** This function will bin the measurement results of the selected automatic measurement into a user-defined number of bins.

**Setup**

- To select the number of bins for the statistics, press *Divided by* and select the number of bins with the Variable knob.



Range 1~20 bins

- Press *Select* and use the *VARIABLE* knob to view the measurement results for each bin.

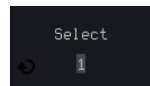

**Example: Statistics**

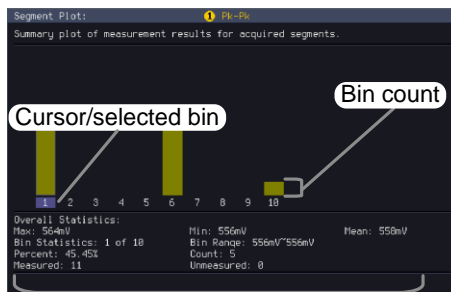

Statistics of currently selected bin

Measurement List      Puts all the measurement results for a segment in a list.

Setup      9. Press *Select* and use the *VARIABLE* knob to scroll through each segment.



Example:  
Measurement List

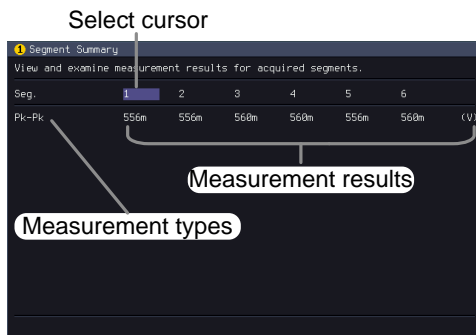

## Segment Info

Operation      1. Press *Analyze Segments* from the bottom menu.

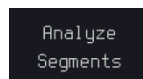

This key will only be available in the Stop mode.

2. Press Segments Info.

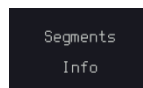

3. A table showing all general setting information for the segmented memory acquisitions is shown on the display.

Info:              Sample rate, Record length,  
                         Horizontal, Vertical

## Segments Info

Samplerate: 565a/s

Record Length: 100k points

Horizontal: 7,167,944ns @ 2us/div

Vertical:  0.000V @ 100mV/div

## Horizontal View

This section describes how to set the horizontal scale, position, and waveform display mode.

### Move Waveform Position Horizontally

Panel Operation The horizontal position knob moves **< POSITION >** the waveform left/right.



Push to Zero

As the waveform moves, a position indicator on the top of the display indicates the horizontal position of the waveform in memory.



Horizontal Position

1. Pushing the horizontal position knob will also reset the position to zero.

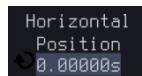

2. It is available to use the numerical keypad to input a desired horizontal position.

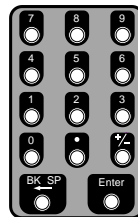

Run Mode

In Run mode, the memory bar keeps its relative position in the memory since the entire memory is continuously captured and updated.

## Select Horizontal Scale

Select Horizontal Scale To select the timebase (time/div), turn the horizontal Scale knob; left (slow) or right (fast).

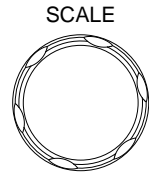

Range 1ns/div ~ 1000s/div, 1-2-5 increment

The timebase indicator updates as the horizontal scale is adjusted.

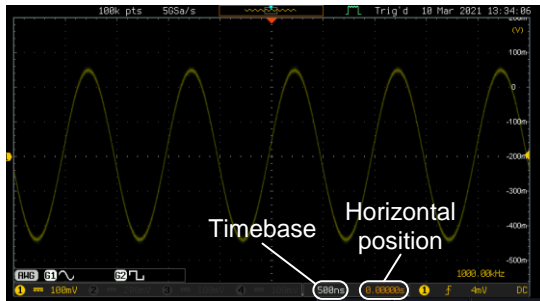

Run Mode In Run mode, the memory bar and waveform size keep their proportion. When the timebase becomes slower, roll mode is activated (if the trigger is set to Auto).

Stop Mode In Stop mode, the waveform size changes according to the scale.

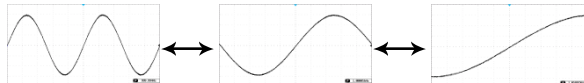

## Select Waveform Update Mode

Background The display update mode is switched automatically or manually according to the timebase and trigger.

Normal	Updates the whole displayed waveform at once. Automatically selected when the timebase (sampling rate) is fast.
	Timebase $\leq 50\text{ms/div}$
	Trigger all modes
Roll Mode	<div style="display: flex; align-items: center;"> <div style="border: 1px solid black; padding: 2px; margin-right: 5px;">Roll</div> <div>Updates and moves the waveform gradually from the right side of the display to the left. Automatically selected when the timebase (sampling rate) is slow.</div> </div>
	Timebase $\geq 100\text{ms/div}$
	Trigger all modes

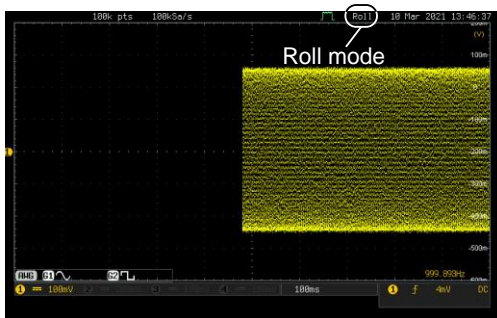

Select Update Mode Manually

1. Press the *Trigger Menu* key.
2. Press *Mode Auto/Normal* key from the bottom menu to let the equipment choose between Auto (Untriggered Roll) and Normal mode.  
The auto (Untriggered Roll) trigger mode enables free-running and roll mode (timebase  $\geq 100\text{ms/div}$ ) acquisitions.

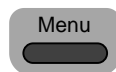



The normal trigger mode enables the equipment which trigger only on valid trigger events. If no trigger occurs, the last waveform record acquired remains on the display. If no last waveform exists, no waveform is displayed.



User can also force the equipment to trigger. To do so, press the *Force-Trig* key on the front panel.

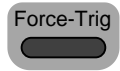

## Zoom Waveform Horizontally

**Background** When in Zoom mode, the screen is split into 2 sections. The top of the display shows the full record length, while the bottom of the screen shows the normal view.

**Panel Operation** 1. Press the *Zoom* key.

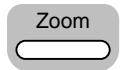

2. The Zoom mode screen appears.

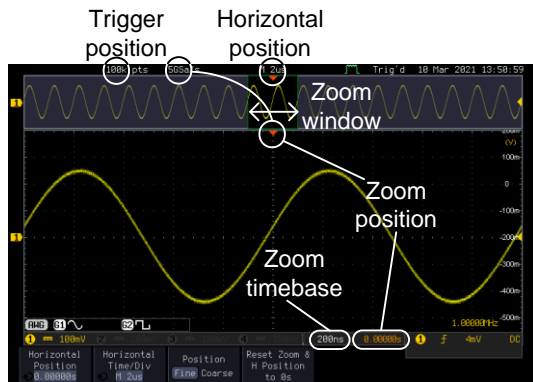

**Horizontal Navigation**

To scroll the waveform left or right, press *Horizontal Position* and use the

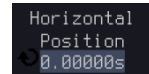

*VARIABLE* Position knob.

VARIABLE

The horizontal position will be shown on the *Horizontal Position* icon.

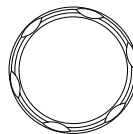

**Horizontal Scale** To change the horizontal scale, press *Horizontal Time/Div* and use the *VARIABLE* Position knob.

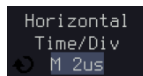

VARIABLE

The scale will be shown on the *Horizontal Time/Div* icon.

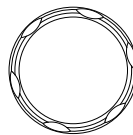

**Zoom**

To increase the zoom range, use the horizontal *Scale* knob.

SCALE

The zoom time base at the bottom of the screen will change accordingly.

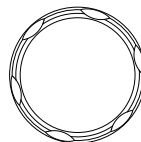

**Move the Zoom Window**

Use the *Horizontal Position* knob to pan the zoom window horizontally.



To reset the zoom position, press the *Horizontal Position* knob.



Push to Zero

The position of the zoom window, relative to the horizontal position is shown at the bottom of the screen next to the Zoom timebase.



**Scroll Sensitivity** To alter the scrolling sensitivity of the zoom window, press the *Zoom Position* key to toggle the scrolling sensitivity

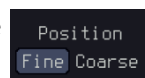

## Sensitivity Fine, Coarse

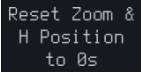
Reset the Zoom & Horizontal Position	To reset both the zoom and horizontal position, press <i>Reset Zoom &amp; H POS to 0s</i> .	
--------------------------------------	---	---

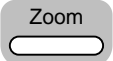
Exit	To go back to the original view, press the <i>Zoom</i> key again.	
------	---	---

## Play/Pause

Background	The Play/Pause key can be used to play through signals in the Zoom mode.
------------	--

Note	If the Segmented memory function is turned on, pressing the play pause key will play through memory segments. See page 90 for more information.
------	---

Panel Operation	1. Press the <i>Play/Pause</i> menu key.	
-----------------	--	---

2. The scope will go into the Zoom Play mode and begin to scroll through the acquisition (from left to right).

The full-record length waveform will be shown at the top and the zoomed section will be shown at the bottom. The Play/Pause indicator shows the play status.

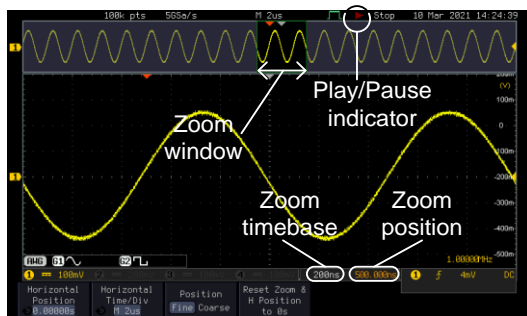

**Zoom**

To increase the zoom range, use the horizontal *Scale* knob.

The zoom time base at the bottom of the screen will change accordingly.

**SCALE**

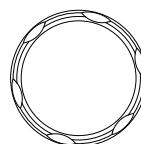

**Scroll Speed**

To alter the scrolling speed of the zoom window, press the *Zoom Position* key to toggle the scrolling speed.

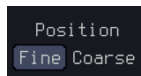

**Sensitivity Fine, Coarse**

Alternatively, use the horizontal position knob to control the scroll speed.

- Turning the Horizontal knob determines the speed and direction of the scrolling.

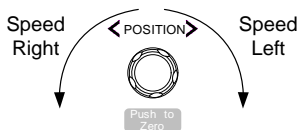

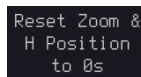

**Reset the Zoom Position**

To reset both the zoom position and horizontal position, press *Reset Zoom & H POS to 0s*.

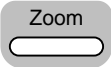

---

Pause	Press the <i>Play/Pause</i> key to pause or resume playing the waveform.	
Reverse Direction	Press the <i>Play/Pause</i> key when at the end of the record length to play back through the waveform in reverse.	
Exit	To exit, press the Zoom key.	

---

## Vertical View (Channel)

This section describes how to set the vertical scale, position, and coupling mode.

### Move Waveform Position Vertically

Panel Operation

1. To move the waveform up or down, turn the *vertical position* knob for each channel.

POSITION



Push to Zero

2. As the waveform moves, the vertical position of the channel indicator appears. Press the lower-right More key from the bottom menu and the vertical position will be shown within the "position/Set to 0".

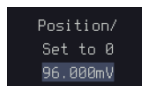
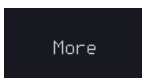

View or Set the Vertical Position

3. Press a channel key followed by pressing More key and the vertical position is shown in the  $\text{Position} / \downarrow \text{Set to 0}$  soft key.

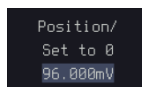
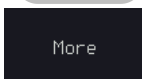
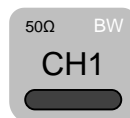

4. To change the position, press  $\text{Position} / \downarrow \text{Set to 0}$  to reset the vertical position or turn the *vertical position* knob to the desired level or press the numerical keypad to directly input a desired value of vertical position.

POSITION



Push to Zero

or

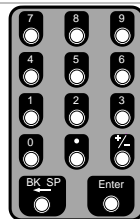

**Run/Stop Mode** The waveform can be moved vertically in both Run and Stop mode.

### Select Vertical Scale

**Panel Operation** To change the vertical scale, turn the vertical SCALE knob; left (down) or right (up).

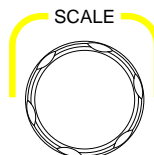

The vertical scale indicator on the bottom left of the display changes accordingly for the specific channel.

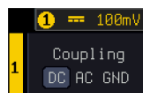

**Range** 1mV/div ~ 10V/div. 1-2-5 increments

**Stop Mode** In Stop mode, the vertical scale setting can be changed.

### Select Coupling Mode

**Panel Operation** 1. Press a *channel* key.

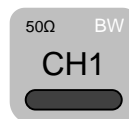

2. Press *Coupling* repeatedly to toggle the coupling mode for the chosen channel.

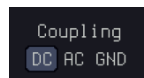

**Range**

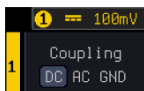

DC coupling mode. The whole portion (AC and DC) of the signal appears on the display.



AC coupling mode. Only the AC portion of the signal appears on the display. This mode is useful for observing AC waveforms mixed with DC signals.



Ground coupling mode. The display shows only the zero voltage level as a horizontal line.

## Input Impedance

**Background** The input impedance of the GDS-3000A series has 2 types of Impedance: 1M & 50. The impedance is displayed in the channel menu.

**View Impedance**

1. Press the *Channel* key.
2. Press *Impedance* repeatedly to toggle between the impedance settings. There are 2 types of Impedance: 1M and 50Ω.
3. Select 50Ω. A small ohm icon “Ω” will be displayed on the screen.

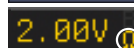
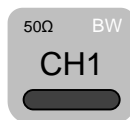

## Invert Waveform Vertically

**Panel Operation**

1. Press the *Channel* key.
2. Press *Invert* to toggle Invert On or Off.

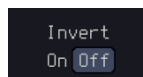
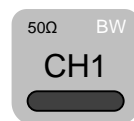





## Limit Bandwidth

**Background**      Bandwidth limitation puts the input signal into a selected bandwidth filter.

This function is useful for cutting out high frequency noise to see a clear waveform shape.

The bandwidth filters available are dependent on the bandwidth of the oscilloscope model.

Also refer to the digital filter application, page 323.

- Panel Operation**
1. Press the *Channel* key.
 
  2. Press *Bandwidth* from the bottom menu. A small bandwidth icon "B" will be displayed on the screen.
 
  3. Choose a bandwidth\* from the side menu.
 

\*Depending on the bandwidth of the oscilloscope.

Range	350MHz models: Full, 20MHz, 100MHz, 200MHz
	650MHz models: Full, 20MHz, 100MHz, 200MHz, 300MHz



Note

The tolerance of bandwidth limit is  $\pm 10\%$

Example

BW Full

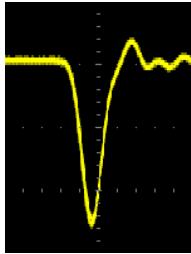

BW Limit 20MHz

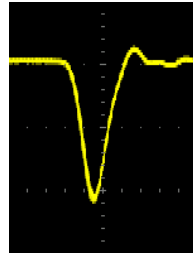

## Fine Scale

Panel Operation 1. Press the *Channel* key.

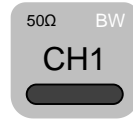

2. Press *More* key from the bottom menu



3. Use the *VARIABLE* knob and the numerical keypad to input a desired value of vertical position.

VARIABLE

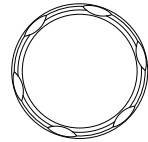

or

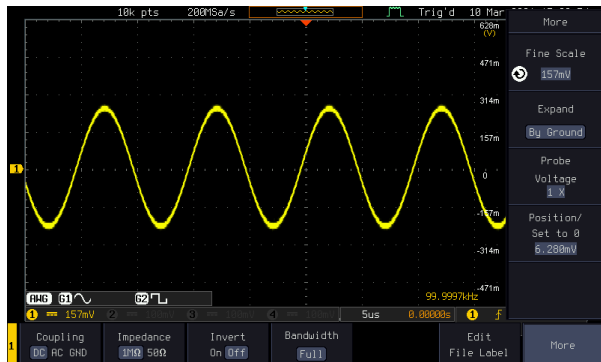
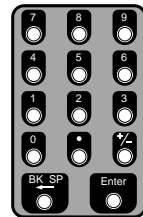

## Expand by Ground/Center

**Background** When the voltage scale is changed, the Expand function designates whether the signal expands from the center of the screen or from the signal ground level. Expand by center can be used to easily see if a signal has a voltage bias. Expand by ground is the default setting.

**Panel Operation** 1. Press a *channel* key.

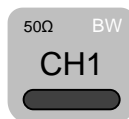

2. Press *Expand* repeatedly to toggle between expand *By Ground* and *Center*.



Range By Ground, By Center

**Example** If the vertical scale is changed when the Expand function is set to ground, the signal will expand from the ground level\*. The ground level does not change when the vertical scale is changed.

If the vertical scale is changed when the Expand function is set to center, the signal will expand from the center of the screen. The ground level will suit to match the signal position.

\*Or from the upper or lower edge of the screen if the ground level is off-screen.

Expand by Ground

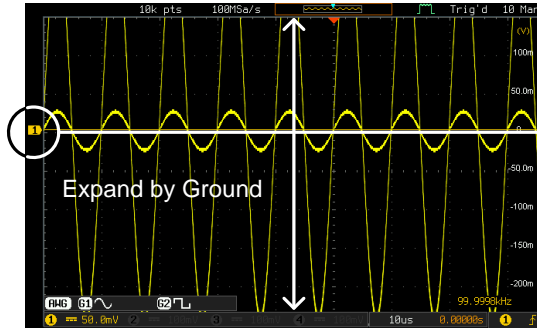

Expand by Center

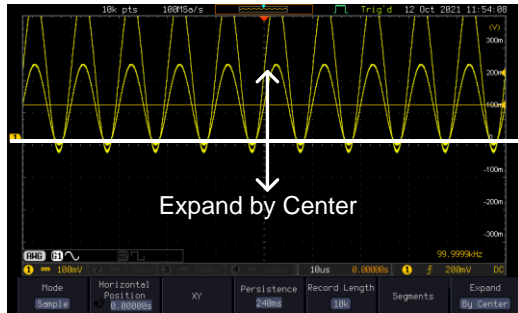

## Select Probe Type

**Background** A signal probe can be set to voltage or current.

- Panel Operation**
1. Press the Channel key.
  2. Press *More* key from the bottom menu
  3. Press *Probe* from the side menu.
  4. Press the *Voltage/Current* soft-key to toggle between voltage and current.

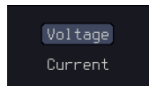
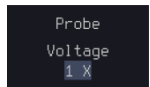
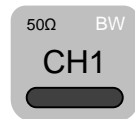

## Select Probe Attenuation Level

**Background** An oscilloscope probe has an attenuation switch to lower the original DUT signal level to the oscilloscope input range, if necessary. The probe attenuation selection adjusts the vertical scale so that the voltage level on the display reflects the real value on a DUT.

**Panel Operation**

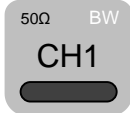
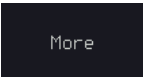
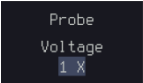
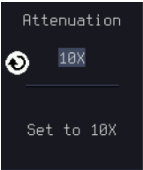
1. Press the *Channel* key.
 
2. Press *More* key from the bottom menu
 
3. Press *Probe* from the side menu.
 
4. Press *Attenuation* on the side menu and use the *VARIABLE* knob to set the attenuation.
 

Alternatively, press *Set to 10X*.

**Range**      1mX ~1kX (1-2-5 step)



Note

The attenuation factor adds no influence on the real signal. It just changes the voltage/current scale on the display.

## Set the Deskew

**Background** The deskew function is used to compensate for the propagation delay between the oscilloscope and the probe.

Panel Operation 1. Press one of the *Channel* keys.

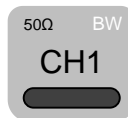

2. Press *More* key from the bottom menu

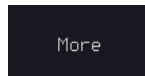

3. Press *Probe* from the side menu.

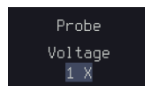

4. Press *Deskew* on the side menu and use the *VARIABLE* knob to set the deskew time.

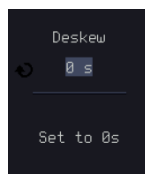

Alternatively, press *Set to 0s* to reset the deskew time.

Range -50ns~50ns, 10ps increments

5. Repeat the procedure for another channel if necessary.

## Bus Key Configuration

The Bus key is used to configure the Serial bus inputs. The Bus menu also features event tables to track and save your bus data. The Bus key is used in conjunction with the Bus trigger (page 160) to decode serial bus signals.

### Bus Display

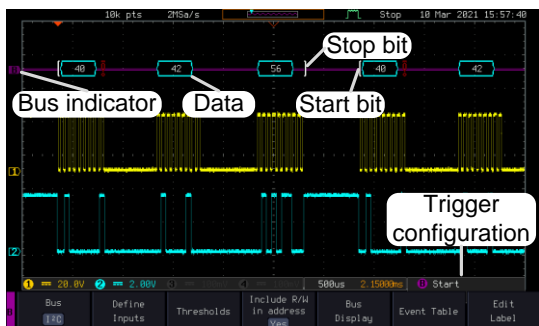

Start Bit/Start of Frame **||** The Start bit is shown as an open bracket (Serial bus data only).

Stop Bit/End of Frame **||** The Stop bit is shown as a closed bracket (Serial bus data only).

Data **40** Data packets/frames/words can be shown in Hex or Binary. The color of the bus data indicates the type of data or the channel the data is coming from, depending on the bus type.

UART: Color of packet = Color of source channel.

I<sup>2</sup>C: Color packet = SDA source channel.

CAN: Purple = Error frame, Data length control (DLC), Overload.



Yellow = Identifier.

Cyan = Data.

Orange = CRC.

Red = Bit stuffing error

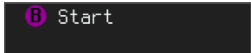

	LIN:	Purple = Break, Sync and Checksum errors, Wakeup Yellow = Identifier, Parity Cyan = Data Red = Error type
Error Indicator/ Missing Ack		If there is an error/missing acknowledgement in decoding the data, a red error indicator will be shown.
Bus Indicator		The Bus indicator shows the bus position. The active bus is shown with a solid color. The VARIABLE knob can be used to horizontally position the Bus indicator when it is active.   Active bus (solid indicator)  Activated bus (transparent indicator)
Trigger Configuration		Shows the bus trigger (B) and the <i>Trigger On</i> settings. Please see page 160.  

## Serial Bus Overview

The Serial Bus includes support for 6 common bus interfaces UART, I<sup>2</sup>C, SPI, Parallel, CAN and LIN. Each interface is fully configurable to accommodate variations in the basic protocols.

Each input can be displayed as binary, hexadecimal or ASCII. An event table can also be created to aid in debugging.

UART	Universal Asynchronous Receiver Transmitter. The UART bus is able to accommodate a wide range of various common UART serial communications. The UART serial bus software is suitable for a number of RS-232 protocol variants.
	Inputs                      Tx, Rx
	Threshold                      Tx, Rx

Configuration	Baud rate, Parity, Packets, End of packets, Input polarity
Trigger On	Tx Start Bit, Rx Start Bit, Tx End of Packet, Rx End of Packet, Tx Data, Rx Data, Tx Parity Error, Rx Parity Error

I <sup>2</sup> C	Inter Integrated Circuit is a two line serial data interface with a serial data line (SDA) and serial clock line (SCLK). The R/W bit can be configured.
Inputs	SCLK, SDA
Threshold	SCLK, SDA
Configuration	Addressing mode, Read/Write in address
Trigger On	Start, Repeat Start, Stop, Missing Ack, Address, Data, Address/Data

SPI The SPI (Serial Interface Peripheral) bus is fully configurable to accommodate the wide variety of SPI interfaces. This bus is only available on 4 channel models.

Inputs	SCLK, SS, MOSI, MISO
Threshold	SCLK, SS, MOSI, MISO
Configuration	SCLK edge, SS logic level, Word size, Bit order
Trigger On	SS Active, MOSI, MISO, MOSI&MISO

CAN The CAN (Controller Area Network) bus is a 2-wire, message-based protocol.

Inputs	CAN Input
Threshold	CAN Input
Configuration	Signal Type, Bit Rate

	Trigger On	Start of Frame, Type of Frame, Identifier, Data, Id & Data, End of Frame, Missing Ack, Bit Stuffing Err.
<hr/>		
LIN	The LIN (Local Interconnect Network) bus is used to decode a wide range of common LIN configurations.	
	Inputs	LIN Input
	Threshold	LIN Input
	Configuration	Bit Rate, LIN Standard, Include Parity Bits with Id
	Trigger On	Sync, Identifier, Data, Id & Data, Wakeup Frame, Sleep Frame, Error

### UART Serial Bus Configuration

The UART bus menu is designed to decode RS-232 and other common RS-232 variants such as RS-422, RS-485. The software configuration is also flexible enough to decode the many proprietary protocols based on RS-232.

Background	<p>Basic RS-232 protocol uses single-ended data transmissions. The signal voltage levels can be high (<math>\pm 15V</math>) and employ active low signaling.</p> <p>High speed variants of RS-232, such as RS-422 and RS-485 use differential signaling and commonly employ low voltage differential signals with active high signaling.</p> <p>Universal Asynchronous Receiver/Transmitter (UART) or RS-232 driver/receiver ICs commonly used for embedded applications typically use active high signaling with standard IC signal levels.</p>
------------	--

Operation

1. Connect each of the bus signals (*Tx*, *Rx*) to one of the oscilloscope's analog or digital channels. Connect the ground potential of the bus to one of the probes' ground clip if you are using the analog channels or to the ground connector of the Digital card if you are using the digital channels.

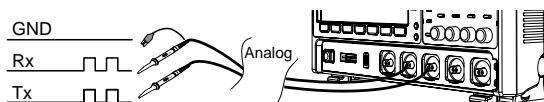

2. Press the *BUS* key.



3. Press *Bus* from the bottom menu and choose the *UART* serial bus on the side menu.

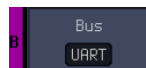

Define Inputs

4. Press *Define Inputs* from the bottom menu.
5. From the side menu choose the *Tx Input* and the *Rx Input* source and the signal polarity.

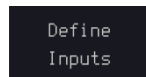

Tx      OFF, CH1~CH4 or OFF

Rx      OFF, CH1~CH4 or OFF

Polarity Normal (High = 0), Inverted (High = 1)

Configuration

The Configure key sets the baud rate, number of data bits and parity.

6. Press *Configure* from the bottom menu.

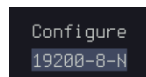

7. From the side menu select the Baud rate, Data bits, Parity, Packets and End of Packet bits.

Fine-tuned Baud Rate	50, 75, 110, 134, 150, 300, 600, 1200, 1800, 2000, 2400, 3600, 4800, 7200, 9600, 14400, 15200, 19200, 28800, 31250, 38400, 56000, 57600, 76800, 115200, 128000, 230400, 460800, 921600, 1382400, 1843200, 2764800
Data Bits	5, 6, 7, 8, 9
Parity	Odd, Even, None
Packets	On, Off
End of Packet (Hex)	00(NUL), OA(LF), OD(CR), 20(SP), FF

### I<sup>2</sup>C Serial Bus Interface

The I<sup>2</sup>C bus is a 2 wire interface with a serial data line (SDA) and serial clock line (SCLK). The I<sup>2</sup>C protocol supports 7 or 10 bit addressing and multiple masters. The scope will trigger on any of the following conditions: a start/stop condition, a restart, a missing acknowledge message, Address, Data or Address & Data frames. The I<sup>2</sup>C trigger can be configured for 7 or 10 bit addressing with the option to ignore the R/W bit as well as triggering on a data value or a specific address and direction (read or write or both).

- Panel operation
1. Connect each of the bus signals (*SCLK*, *SDA*) to one of the oscilloscope's analog or digital channels. Connect the ground potential to one of the probes' ground clip if you are using the analog channels.

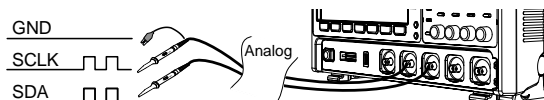

2. Press the *Bus* key.



3. Press *Bus* from the bottom menu and choose *I<sup>2</sup>C* from the bottom menu.

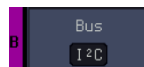

Define Inputs

4. Press *Define Inputs* from the bottom menu.
5. From the side menu choose the *SCLK* input and the *SDA* Input.

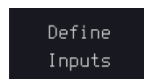

SCLK      CH1~CH4

SDA        CH1~CH4

Include R/W in address

To configure whether you want the R/W bit to be included in the address, press *Include R/W in address* and set to *Yes* or *No* in the side menu.

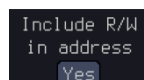

R/W Bit    Yes, No

## Serial Bus Interface

The serial peripheral interface (SPI) is a full duplex 4 wire synchronous serial interface. The 4 signals lines: Serial clock line (SCLK), slave select (SS), Master output/slave input (MOSI, or SIMO) and the Master input/slave output (MISO, or SOMI). The word size is configurable from 4~32 bits (fine-tuned). The SPI triggers on the data pattern at the start of each framing period. This bus is only available on 4 channel models.

- Panel operation
1. Insert each of the bus signals (*SCLK*, *SS*, *MOSI*, *MISO*) to one of the oscilloscope channels.

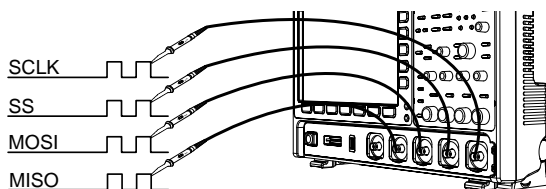

2. Press *Bus* from the bottom menu and choose *I<sup>2</sup>C* from the bottom menu.

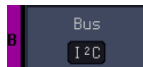

Note

The SPI bus decoding function is only available on 4 channel DSO models.

Define Inputs

3. Press *Define Inputs* from the lower menu.

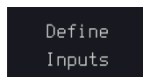

4. From the side menu choose the *SCLK*, *SS*, *MOSI* and *MISO* inputs.

SCLK	CH1~4
SS	CH1~4
MOSI	OFF, CH1~4
MISO	OFF, CH1~4

Set the Threshold

5. Press *Threshold* from the bottom menu.

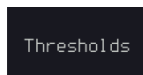

6. Press *Select* from the side menu. Choose *SCLK*, *SS*, *MOSI* or *MISO* line thresholds.



Range	SCLK, SS, MOSI, MISO
-------	----------------------

7. Press *Threshold* from the side menu and configure the threshold.



8. Press the Choose Preset to select the following settings  
 TTL, 5.0V CMOS, 3.3 CMOS, 2.5V COMS, ECL -1.3V, PECL 3.7V, 0V 0V

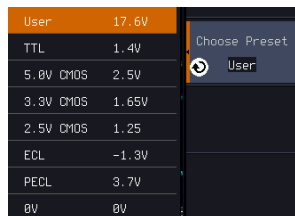

Configuration      The *Configure* menu sets the data line logic level, SCLK edge polarity, word size and bit order.

9. Press *Configure* from the bottom menu.



10. From the side menu select SCLK edge, SS logic level, word Size and Bit order.

SCLK	rising edge , falling edge
SS	Active High, Active Low
Word Size	4~32 bits (fine-tuned)
Bit Order	MS First, LS First

Bus Display      Press Bus Display from the bottom menu and Hex or Binary from the side menu.

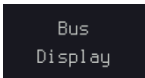

Range      Hex, Binary

Event Table      11. Press *Event Table* from the bottom menu.

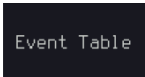

12. Press *Event Table* from the side menu to toggle the event table On or Off.

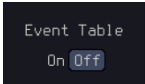

Event      On, Off

13. To save the event table, press *Save Event Table*.

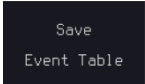



## Parallel Bus Input Configuration

**Background** The digital channels can be configured as a parallel bus. The number of bits that define the bus as well as which bit is used as the bus clock can also be configured.



**Note**

The trigger should also be set to parallel bus. Please see page 165 for details.

**Panel Operation**

1. Press the *Bus* key.

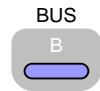

2. Press the *Bus* soft-key and select Parallel from the side menu.

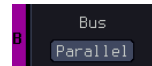

3. Press *Define Inputs* from the bottom menu.

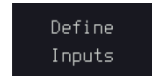

4. Press *Number of Bits* from the side menu and select the number of bits for the data bus.



By default the bus is assigned bits D0, D1, D2 and so on up to the last bit.

5. You may also assign a bit as a clock. This bit will be one of the bits in the bus. To add a clock bit, press *Clock Edge* and select type of clock edge. Selecting *Off* will disable the clock bit.

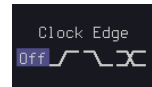

- If you wish to define which channels are assigned to the bus, press *Select Signal* from the side menu and select the bit that wish to assign.

Channel 1 is currently assigned to bit 7.

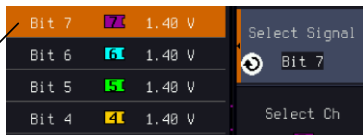

- Next, press *Select Ch* and select which channel is assigned to the bit selected above.

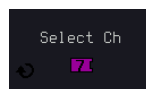

- Repeat steps 6 and 7 for any remaining bits and for the clock, if enabled.

## Threshold Configuration

**Background** The threshold levels for the parallel bus can be set to either a user-defined threshold level or to pre-set threshold.

- Operation**
- Press *Thresholds* from the bottom menu.
  - Press *Select* from the side menu and select a digital channel.
  - Press *Choose Preset* to select a pre-set logic threshold for the selected channel.

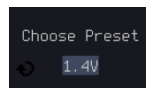

Logic Type	Threshold
TTL	1.4V
5.0V CMOS	2.5V
3.3V CMOS	1.65V
2.5V CMOS	1.25V

ECL	-1.3V
PECL	3.7V
0V	0V
4. Press <i>Threshold</i> to set a user defined threshold for the selected input.	
Range	±10V

## Bus Encoding

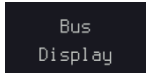
Background	The bus that is displayed on the screen or in the event tables can be set to either hex or binary formats.
Operation	1. Press <i>Bus Display</i> from the Bus menu and choose either Hex or Binary from the side menu. 

## Parallel Bus Event Table

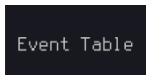
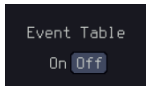
Event Table	The parallel bus event table lists when each data event on the bus occurred. The data is displayed as either hex or binary, depending on the bus display settings.  Event tables can be saved to disk in a CSV format. The files will be named "Event_TableXXXX.CSV", where XXXX is a number from 0000 to 9999. See page 134 for details.
Operation	1. Press Event Table from the bottom menu.   2. Press Event Table from the side menu to turn the event table on or off. 
Event	On, Off

- To save the event table, press *Save Event Table*.

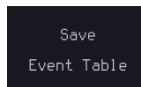

Use the *VARIABLE* knob to scroll through the event table.

Example

Time of event

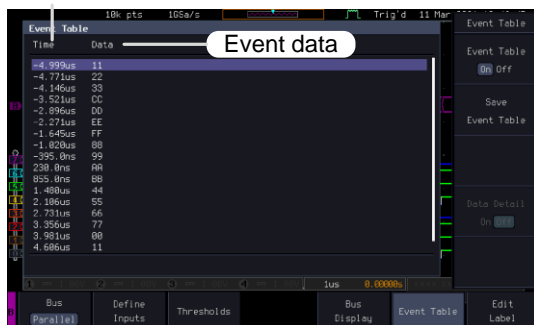

Adding a Label to the Parallel Bus

Background

A label can be added to the parallel bus.

Panel Operation

- To add a label to the bus, press *Edit Labels* from the Parallel Bus menu.
- To choose a preset label, Press *User Preset* from the side menu and choose a label.

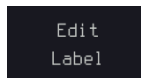

Labels ACK, AD0, ADDR, ANALOG, BIT, CAS, CLK, CLOCK, CLR, COUNT, DATA, DTACK, ENABLE, HALT, INT, IN, IRQ, LATCH, LOAD, NMI

Edit Label

- Press *Edit Character* to edit the current label.
- The Edit Label window appears.

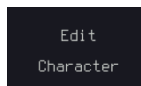

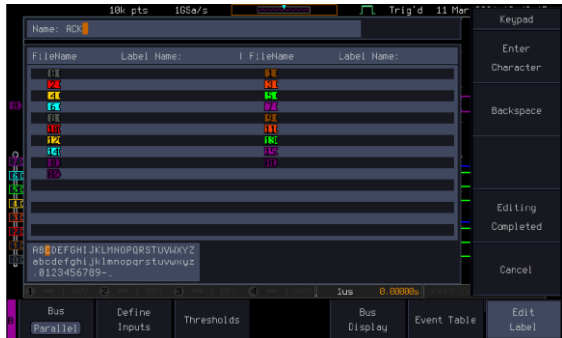

5. Use the *VARIABLE* knob to highlight a character.



Press *Enter Character* to select a number or letter.

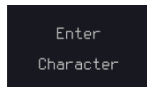

Press *Back Space* to delete a character.

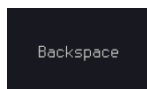

Press *Editing Completed* to create the new label and return to the previous menu.

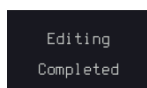

Note

This key must be pressed to save the label, even for the preset labels.

Press *Cancel* to cancel the editing and return to the Edit Label menu.

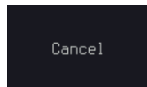

The label will appear next to the bus indicator.

Below, the label "BUS\_1" was created for the parallel bus.



The parallel bus is labeled as BUS\_1

Remove Label Press *Label Display* to toggle the label on or off.



## CAN Serial Bus Interface

The controller area network (CAN) bus is a half duplex 2 wire synchronous serial interface. The CAN bus is a multi-master communication system that relies on arbitration to solve contention issues. The GDS-3000A series supports both CAN 2.0A and 2.0B. The CAN bus uses two wires, CAN-High and CAN-Low. These wires are voltage inverted, and as such, the GDS-3000A Series only needs one wire, CAN-High or CAN-Low for decoding.

- Panel operation
1. Connect the bus signal (*CAN Input*) to one of the oscilloscope's analog or digital channels. Connect the ground potential to one of the probes' ground clip if you are using the analog channels or to the ground connector of the Digital card if you are using the digital channels.



2. Press the *Bus* key.



3. Press *Bus* from the bottom menu and choose the *CAN* serial bus.

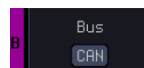

- Define Inputs
4. Press *Define Inputs* from the lower menu.

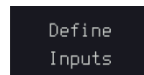

- From the side menu choose the *CAN Input* inputs and the signal type.

CAN Input CH1~CH4

Signal Type CAN\_H, CAN\_L, Tx, Rx.



Note

The Sample Point soft-key indicates the sampling position of each bit. This parameter is fixed.

Bit Rate

The *Bit Rate* menu sets the bit rate of the bus. The bit rate is usually tied to the bus length.

- Press *Bit Rate* from the bottom menu and set the bit rate.

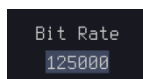

Bit Rate 10kbps, 20kbps, 50kbps, 125kbps, 250kbps, 500kbps, 800kbps, 1Mbps

## LIN Serial Bus Interface

The local interconnect network (LIN) bus is a single wire interface.

- Panel operation
- Connect the bus signal (*LIN Input*) to one of the oscilloscope's analog or digital channels. Connect the ground potential to one of the probes' ground clip if you are using the analog channels or to the ground connector of the Digital card if you are the using digital channels.

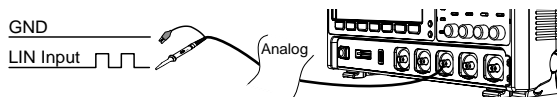

- Press the *Bus* key.



- Press *Bus* from the bottom menu and choose the *LIN* serial bus.

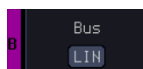

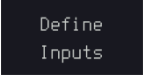
- Define Inputs
4. Press *Define Inputs* from the lower menu. 
  5. From the side menu choose the LIN input and the polarity of the bus.
- 
- |           |  |
|-----------|--|
| LIN Input | CH1~CH4                                  |
| Polarity  | Normal (High = 1),<br>Inverted(High = 0) |
- 



Note

The Sample Point soft-key indicates the sampling position of each bit. This parameter is fixed.

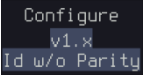
- Configuration
- The *Configure* menu sets the bit rate, the LIN standard and the parity options for the Id frame.
6. Press *Configure* from the bottom menu. 
  7. From the side menu select configuration items.
- 
- |                             |   |
|-----------------------------|---|
| Bit Rate                    | 1.2kbps, 2.4kbps, 4.8kbps,<br>9.6kbps, 10.417kbps, 19.2kbps |
| LIN Standard                | V1.x, V2.x, Both  |
| Include Parity Bits with Id | On, Off   |
- 

## Bus Encoding

---

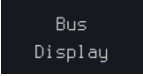
- Background
- The bus that is displayed on the screen or in the event tables can be set to either hex or binary formats.
- 
- Operation
- Press *Bus Display* from the Bus menu and choose either Hex or Binary from the side menu. 
-



## Threshold configuration

**Background**      The threshold levels for the Serial buses can be set to either a user-defined threshold level or to pre-set threshold.

**Set the Threshold** 1. Press *Threshold* from the bottom menu.

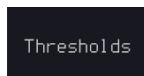

2. Press *Select* from the side menu to choose one of the lines that are configured for your type of bus.



UART	Tx, Rx
------	--------

I <sup>2</sup> C	SCLK, SDA
------------------	-----------

CAN	CAN_H, CAN_L, Tx, Rx
-----	----------------------

LIN	LIN Input
-----	-----------

3. Press *Choose Preset* to select a preset logic threshold.

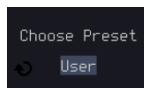

Logic Type	Threshold
------------	-----------

TTL	1.4V
-----	------

5.0V CMOS	2.5V
-----------	------

3.3V CMOS	1.65V
-----------	-------

2.5V CMOS	1.25V
-----------	-------

ECL	-1.3V
-----	-------

PECL	3.7V
------	------

0V	0V
----	----

4. Press *Threshold* to set a user defined threshold for the currently selected input.



For the analog channels, the threshold level depends on the vertical scale :

Scale	Range	Scale	Range
10V/Div	±290V	50mV/Div	±5.2V
5V/Div	±270V	20mV/Div	±580mV
2V/Div	±33V	10mV/Div	±540mV
1V/Div	±29V	5mV/Div	±520mV
500mV/Div	±27V	2mV/Div	±508mV
200mV/Div	±5.8V	1mV/Div	±504mV
100mV/Div	±5.4V		

## Serial Bus Event Tables

**Background** The serial bus event tables list when each data event on the bus occurred. The data is displayed as either hex or binary, depending on the bus display settings.

Event tables can be saved to disk in a CSV format. The files will be named “Event\_TableXXXX.CSV”, where XXXX is a number from 0000 to 9999. See page 134 for details.

**Operation**

1. Press *Event Table* from the bottom menu.
2. Press *Event Table* from the side menu to turn the event table on or off.

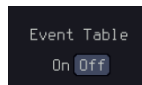
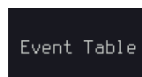

Event      On, Off

Use the *VARIABLE* knob to scroll through the event table.

**Data Detail (I<sup>2</sup>C only)**

3. To view the data at a particular address in more detail, turn *Data Detail* On. This is only available for the I<sup>2</sup>C bus.

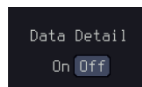

Detail On, Off

Use the *VARIABLE* knob to scroll through the Data Detail event table.

- Save Event Table 4. To save the event table, press *Save Event Table*. The Event table will be saved to the current file path in a CSV format. See page 134 for details. Use the *VARIABLE* knob to scroll through the event table.



Example:  
UART Event table

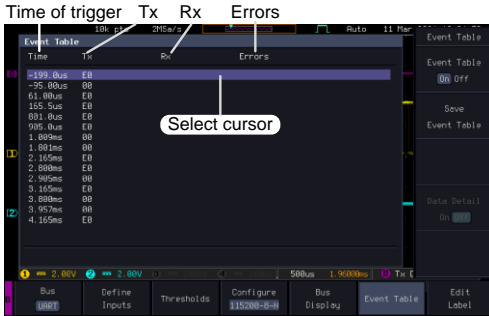

Example:  
I<sup>2</sup>C Event table

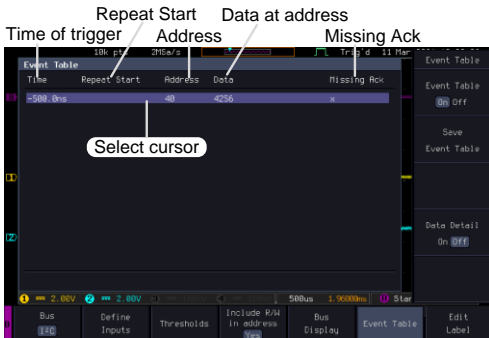

Example:  
I<sup>2</sup>C Data Detail

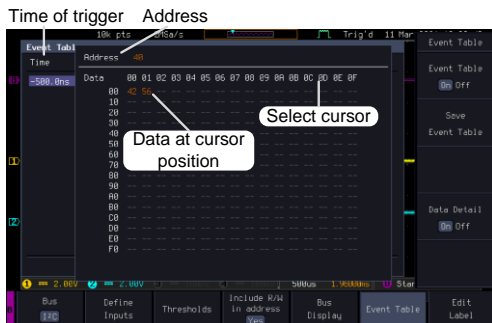

Data Detail is only available with the I<sup>2</sup>C bus.

Example:  
CAN Event table

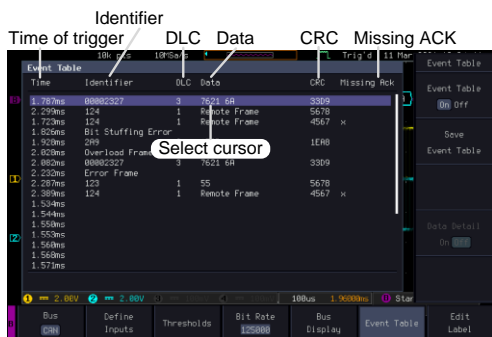

Example:  
LIN Event table

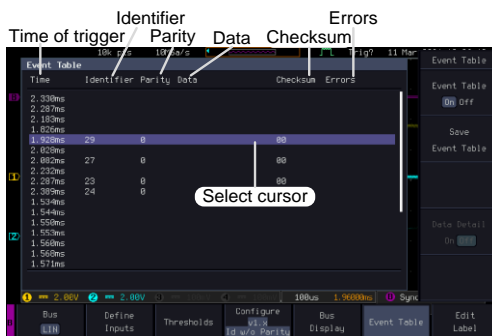

## Event Tables Format

Each bus type can have an event table saved containing each bus event as a .CSV file. An event is defined as a packet/frame/word

or associated set of data being successfully read according to the specific operating conditions of each bus (Start of frame, acknowledgements, checksums, etc ...). The data associated with each event and the time of each event is recorded.

**File Type** Each event table is saved as Event\_TableXXXX.CSV into the designated file path. Each event table is numbered sequentially from 0000 to 9999. For example the first event table will be saved as Event\_Table0000.CSV, the second as Event\_Table0001.CSV, and so on.

**Event Table Data** Each event table saves a timestamp of each event relative to the trigger as well as the data in each frame/packet at the time of an event. The frame/packet data is saved in HEX format.

The table below lists in order the data saved for each event table.

UART	Time, Tx frame data, Rx frame data, Errors.
I <sup>2</sup> C	Time, Repeat Start, Address, Data, Missing Ack.
CAN	Time, Identifier, DLC, Data, CRC, Missing Ack.
LIN	Time, Identifier, Parity, Data, Checksum, Errors.

## Adding a Label to a Bus

**Background** A Label can be added to the buses. This label will appear next to the bus indicator on the left hand-side of the display.

**Panel Operation** 1. To add a label to the bus, press *Edit Labels* from the Bus menu.



- To choose a preset label, Press *User Preset* from the side menu and choose a label.

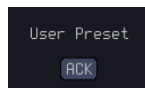

Labels      ACK, AD0, ADDR, ANALOG,  
 BIT, CAS, CLK, CLOCK, CLR,  
 COUNT, DATA, DTACK,  
 ENABLE, HALT, INT, IN, IRQ,  
 LATCH, LOAD, NMI

Edit Label

- Press *Edit Character* to edit the current label.

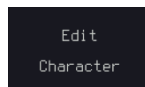

- The Edit Label window appears.

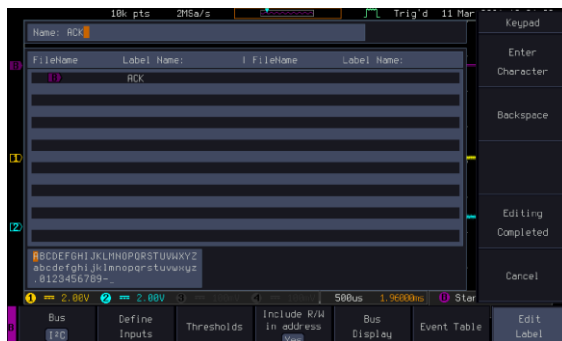

- Use the *VARIABLE* knob to highlight a character.



Press *Enter Character* to select a number or letter.

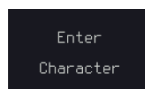

Press *Back Space* to delete a character.



Press *Editing Completed* to create the new label and return to the previous menu.

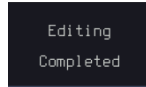

Note

This key must be pressed to save the label, even for the preset labels.

Press *Cancel* to cancel the editing and return to the Edit Label menu.



6. The label will appear next to the bus indicator.

Below, the label "ACK" was created for the bus.



The bus is labeled as ACK

Remove Label

Press *Label Display* to toggle the label on or off.



## Using Cursors with the Serial Bus

Background

The cursors can be used to read bus values at any position.



Note

Ensure that one of the serial buses has been selected and is activated.

Panel Operation

1. Press the *Cursor* key. Horizontal cursors appear on the display.

Cursor



2. When cursor mark is selected "ON"

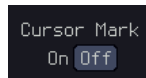

Press the *H Cursor* soft-key and select which cursor(s) you wish to position.

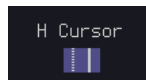

Range

Description

- |   |   |  |
|---|---|--|
|   | ⋮ | Left cursor (1) movable, right cursor position fixed |
| ⋮ |   | Right cursor (2) movable, left cursor position fixed |
|   |   | Left and right cursor (1+2) movable together         |

3. The cursor position information appears on the top left hand side of the screen.

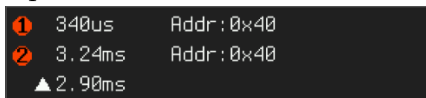

Example: I<sup>2</sup>C cursors.

Cursor 1 Hor. position, Bus value(s)

Cursor 2 Hor. position, Bus value(s)

4. When cursor mark is selected "ON"

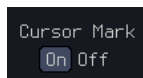

The cursor will mark readout directly on waveform.

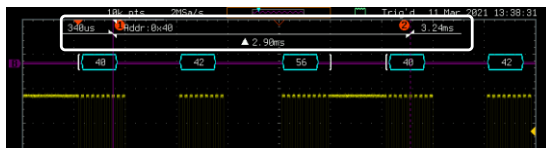

5. Use the *VARIABLE knob* to move the movable cursor(s) left or right.

VARIABLE

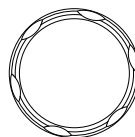

6. Press the *Cursor* key twice. Vertical cursors appear on the display.

Cursor





# Trigger

The trigger configures the conditions for when the GDS-3000A SERIES captures a waveform.

## Trigger Type Overview

**Edge**                      The edge trigger is the simplest trigger type. An edge trigger triggers when the signal crosses an amplitude threshold with either a positive or negative slope.



Rising edge trigger



Falling edge trigger

**Delay**                      The Delay trigger works in tandem with the edge trigger, by waiting for a specified time (duration) or number of events before the delay trigger starts. This method allows pinpointing a location in a long series of trigger events.



Note

When using the delay trigger, the edge trigger source can be any one of the channel inputs, the EXT input or the AC line.

### Delay trigger example (by event)

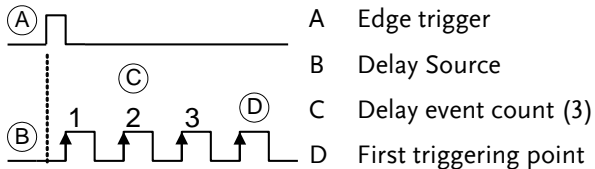

Delay trigger example (by time)

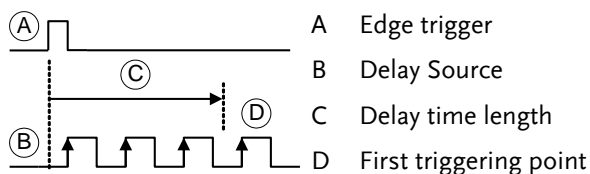

Pulse Width

Triggers when the pulse width of the signal is less than, equal, not equal or greater than a specified pulse width.



Video

Extracts a sync pulse from a video format signal, and triggers on a specific line or field.

Pulse and Runt

Triggers on a "runt". A runt is a pulse that passes a specified threshold but fails to pass a second threshold. Both positive and negative runts can be detected.

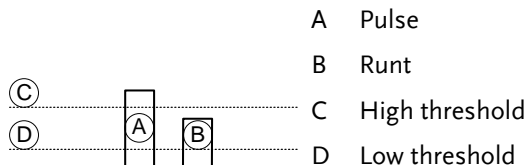

Rise and Fall (Slope)

Trigger on rising and or falling edges, below or over a specified rate. The threshold can also be specified.

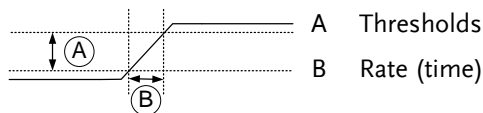

Timeout

Triggers when the signal stays high, low or either for a designated amount of time. The trigger level determines when a signal is high or low.

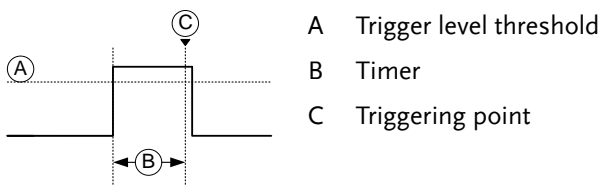

Bus	Triggers on several bus events.
Logic	Triggers on specified logic levels or for specified clock edge. Logic trigger is only available for Digital channels.

### Trigger: types and sources

Sources versus types	Trigger types	Trigger sources			
		Analog			Digital
		CH1 ~ CH4	EXT	AC Line	D0~D15
Edge	✓	✓	✓	✓	
Delay	✓	✓	✓		
Pulse Width	✓	✓	✓	✓	
Video	✓				
Pulse & Runt	✓				
Rise & Fall (Slope)	✓				
Timeout	✓	✓	✓	✓	
Bus	✓*			✓	
Logic				✓	

\*The source analog is assigned from the Bus menu.

### Trigger Parameter Overview

All the following parameters are common for all the trigger types unless stated otherwise.

Trigger Source	CH1 ~ 4	Channel 1 ~ 4 input signals
----------------	---------	-----------------------------

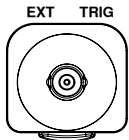
EXT	External trigger input signal Except for: Video, Pulse Runt, Rise & Fall and Bus	
AC Line	AC mains signal Except for: Video, Pulse Runt, Rise & Fall and Bus	
Alternate	Alternate between channel sources for the trigger source.	
D0 ~ D15	Digital input channels Except for: Video, Pulse Runt, Rise and Fall	
EXT Probe	For EXT trigger source only. Set the probe as either current or voltage.	
Attenuation	For EXT trigger source only. Attenuates the EXT trigger probe by an adjustable value.	
Range	0.001X ~ 1000X 1-2-5 steps	
Source Bus	UART	UART bus
	I <sup>2</sup> C	Inter-Integrated Circuit
	CAN	Controller Area Network bus
	LIN	Local Interconnect Network
	SPI	Serial Peripheral Interface
	Parallel	Parallel bus









Note

The Source Bus is not configurable from the Trigger menu. The field is automatically filled according to the Bus menu configuration (see page 114).

Coupling (Edge, Delay, Timeout)	DC	DC coupling.
	AC	AC coupling. Blocks DC components from the trigger circuits *.
	HF reject	High frequency filter, above 70kHz*.
	LF reject	Low frequency filter, below 70kHz*.
	Reject noise	DC coupling with low sensitivity to reject noise.

\*Parameter not applicable to digital channels.

Slope (Edge, Delay, Rise & Fall)		Trigger on a rising edge.
		Trigger on a falling edge.
		Either (either rising or falling edge).

Trigger Level (Edge, Delay)	Level	Adjusts the trigger level manually using the Trigger LEVEL knob.	 
	Set to TTL	Sets the trigger level to 1.4V, suitable for triggering on TTL signals.	
	Set to ECL -	Sets the trigger to -1.3V. This is suitable for ECL circuits.	
	Set to 50%	User can push the trigger level knob to set directly the trigger level to 50% of the waveform amplitude.	 

Level (Edge, Delay) Only available when the trigger source is digital.

Level	Adjusts the trigger level when the source is digital.	
-------	---	---

Range: -5V ~ +5V

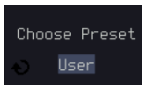
Choose Preset	Press <i>Choose Preset</i> to select a pre-set logic threshold.	
---------------	---	---

Logic Type	Threshold
TTL	1.4V
5.0V CMOS	2.5V
3.3V CMOS	1.65V
2.5V CMOS	1.25V
ECL	-1.3V
PECL	3.7V
0V	0V

Trigger Mode	<p><b>Auto</b> (untriggered roll)</p> <p>The GDS-3000A series generates an internal trigger if there is no trigger event, to make sure waveforms are constantly updated regardless of trigger events. Select this mode especially when viewing rolling waveforms at slower timebases.</p>
--------------	---

Normal	The GDS-3000A acquires a waveform only when a trigger event occurs.
--------	---

Single	<p>When pressing the Single key, the GDS-3000A Series acquires a waveform only once when a trigger event occurs, and then stops acquiring (the oscilloscope falls into Stop mode). Press the <i>Single</i> key to</p>	
--------	---	---

		acquire a waveform again. Please refer to Run/Stop mode for more details (page 39).
Holdoff	Holdoff	Sets the holdoff time.
	Set to Minimum	Set the holdoff time to the minimum.
Delay (Delay)	Time	Sets the delay time (4ns ~ 10s) between the trigger event and the real trigger timing.
	Event	Sets the number of events (1 ~ 65535) passed after the trigger event, until the real trigger timing.
	Set to Minimum	Sets the source trigger to the minimum time.
When (Pulse Width)		Sets the pulse width (4ns ~ 10s) and the triggering condition.
	>	Longer than = Equal to
	<	Shorter than ≠ Not equal to
Threshold (Pulse Width)		Sets the amplitude threshold level for the pulse widths.
	Threshold	-XXV ~ +XXV, user-set level
	Set to TTL	1.4V
	Set to ECL	-1.3V
	Set to 50%	Sets the threshold to 50%

(Only when the trigger source is digital):

Threshold Adjusts the amplitude threshold for the pulse width trigger when the source is digital.



Range -5V ~ +5V

Choose Preset Press *Choose Preset* to select a pre-set logic threshold.

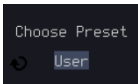

Logic Type	Threshold
TTL	1.4V
5.0V CMOS	2.5V
3.3V CMOS	1.65V
2.5V CMOS	1.25V
ECL	-1.3V
PECL	3.7V
0V	0V



Note

Setting the threshold levels for the digital sources from the Trigger menu will also change the threshold levels set in the Logic Analyzer menu (page 339).

Standard (Video) NTSC National Television System Committee

---

PAL Phase Alternate by Line

SECAM SEquential Couleure A Memoire





Polarity (Pulse Width, Video)  Positive polarity (triggered on the high to low transition)

 Negative polarity (triggered on the low to high transition)

Polarity (Pulse Runt)  Positive polarity (positive runt)

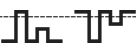
 Negative polarity (negative runt)

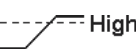

		Either (either negative or positive runt)
Trigger On (Video)	Selects the trigger point in the video signal.	
	Odd Field	NTSC: 1 ~ 263 PAL/SECAM: 1 ~ 313 EDTV: 1~525(480P), 1~625(576P) HDTV: 1~750(720P), 1~563(1080i), 1~1125(1080P)
	Even Field	NTSC: 1 ~ 262, PAL/SECAM: 1 ~ 312 HDTV: 1~562(1080i)
	All Fields	Triggers on all fields.
	All Lines	Triggers on all lines.
Trigger On (Bus)	Selects the conditions for the serial bus triggers.	
	UART Bus	Tx Start Bit, Rx Start Bit, Tx End of Packet, Rx End of Packet, Tx Data, Rx Data, Tx Parity Error, Rx Parity Error
	I <sup>2</sup> C	Start, Repeat Start, Stop, Missing Ack, Address, Data, Address/Data
	CAN	Start of Frame, Type of Frame, Identifier, Data, Id & Data, End of Frame, Missing Ack, Bit Stuffing Err
	LIN	Sync, Identifier, Data, Id & Data, Wakeup Frame, Sleep Frame, Error
Data (Bus)	Selects the conditions for the parallel bus trigger.	
	Parallel	A Binary or Hexadecimal word.
Threshold (Pulse Runt)		Sets the upper threshold limit.
		Sets the lower threshold limit.
Threshold (Rise & Fall)		<b>High</b> Sets the High threshold.
		<b>Low</b> Sets the Low threshold.

Trigger When (Timeout)	Stays High	Triggers when the input signal stays high for a designated amount of time.
	Stays Low	Triggers when the input signal stays low for a designated amount of time.
	Either	Triggers when the input signal stays high or low for a designated amount of time.
Timer (Timeout)	4ns~10.0s	Sets the amount of time that a signal must stay high or low for the timeout trigger.

## Setup Holdoff Level

**Background** The holdoff function defines the waiting period before the GDS-3000A starts triggering again after a trigger point. The holdoff function ensures a stable display if there are a number of points in a periodic waveform that can be triggered. Holdoff applies to all the triggering types except the trigger by bus.

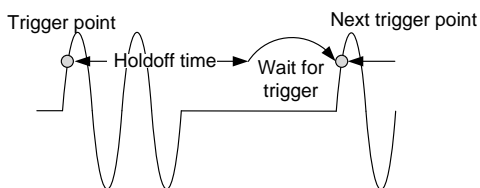

- Panel Operation**
1. Press the trigger *Menu* key.
  2. To set the Holdoff time, press the *Holdoff* (or *Mode/Holdoff*) menu button on the bottom bezel.
  3. Use the side menu to set the Holdoff time.

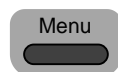

Range      4ns~10s

Pressing *Set to Minimum* sets the Holdoff time to the minimum, 4ns.

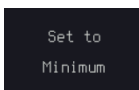

Note

The holdoff function is automatically disabled when the waveform update mode is in roll mode (page 97).

## Setup Trigger Mode

**Background**      The trigger mode can be set to Normal or Auto (untriggered roll). The triggering mode applies to all the trigger types.

**Panel Operation**      1. Press the Trigger menu key.

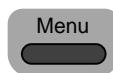

2. Press *Mode* from the bottom menu to change the triggering mode.



3. Use the side panel to select *Auto* or *Normal* triggering modes.

Range      Auto, Normal

## Using the Edge Trigger

**Panel Operation**      1. Press the trigger *Menu* key.

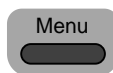

2. Press *Type* from the lower bezel menu.



3. Select *Edge* from the side menu. The edge trigger indicator appears at the bottom of the display.





From left: trigger source, slope, trigger level, coupling

4. Press *Source* to change the trigger source.

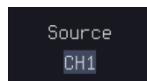

5. Use the side menu to select the trigger source type.

---

Range      Channel 1 ~4 (Alternate On/Off), EXT (Ext Probe: Volt/Current, Attenuation: 1mX~1kX, and AC Line).

---

6. Press *Coupling* from the bottom bezel menu to select the trigger coupling or frequency filter settings.

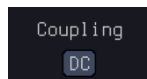

Choose the coupling from the side menu.

---

Range      DC, AC, HF Reject, LF Reject

---

7. Toggle *Noise Rejection* On or Off from the side menu.

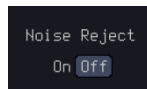



---

Range      On, Off

---

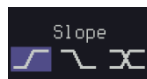
8. From the bottom menu press *Slope* to toggle the slope type.



---

Range      Rising edge, falling edge, either

---

9. To set the external trigger level, select *Level* from the bottom bezel menu (Not applicable for AC line source).



10. Set the external trigger level using the side menu.





Analog channel Range	Set to TTL 1.4V	
	Set to ECL -1.3V	
	Set to 50%	
Digital channel Range	-5.00V~ +5.00V	
	TTL	1.4V
	5.0V CMOS	2.5V
	3.3V CMOS	1.65V
	2.5V CMOS	1.25V
	ECL	-1.3V
	PECL	3.7V
	0V	0V



Note

Setting the trigger level for a digital source will also change the threshold levels set in the Logic Analyzer menu (page 339).

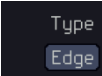
### Using Advanced Delay Trigger

- Panel Operation
1. Set the edge trigger source. This will set the initializing trigger for the delay source. Page 149
  2. Press the trigger *Menu* key. 
  3. Press *Type* from the lower bezel menu. 
  4. Select *Delay* from the side menu. The delay trigger indicator appears at the bottom of the display. 



From left: Delay trigger indicator (D), edge trigger (A), edge slope, edge level, edge coupling, delay trigger (B), delay slope, delay trigger level, delay coupling.

- To set the delay source, press *Source* and select a source from the side menu.

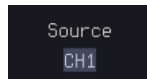



---

Source CH1 ~ CH4, AC Line, EXT

---

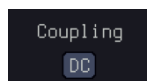
- Press *Coupling* from the bottom bezel menu to select the trigger coupling or frequency filter settings.



Choose the coupling from the side menu.

---

Range DC, AC, HF Reject, LF Reject

---

- To set the delay press *Delay* from the bottom bezel.



- To Delay by Time (Duration), press *Time* from the side menu and set the delay time.



---

Range 4ns ~ 10s (by time)  
Set to minimum

---

- To Delay by Event, press *Event* from the side menu and set the number of events.





---

Range 1 ~ 65535 events  
Set to Minimum

---

## Using Pulse Width Trigger

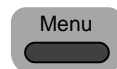
- Panel Operation 1. Press the trigger *Menu* key.



2. Press the *Type* key from the lower bezel menu.



3. Select *Pulse Width* from the side menu. The pulse width trigger indicator appears at the bottom of the display.

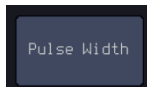

From left: source, polarity, when, coupling

4. Press *Source* from the lower bezel.



5. Use the side menu to select the pulse width trigger source.

---

Range Channel 1 ~4 (Alternate On/Off), EXT (Ext Probe: Volt/Current, Attenuation: 1mX~1kX, and AC Line.

---

6. Press *Polarity* to toggle the polarity type.





---

Range Positive (high to low transition)  
Negative (low to high transition)

---

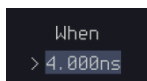
7. Press *When* from the lower bezel.



Then use the side menu to select the pulse width condition and width.

---

Condition > , < , = , ≠

---

Width 4ns ~ 10s

---

8. Press *Threshold* from the lower bezel to edit the pulse width threshold.



9. Set the threshold level using the side menu.

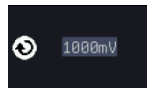

Analog channel Range	Set to TTL 1.4V	
	Set to ECL -1.3V	
	Set to 50%	
Digital channel Range	-5.00V~ +5.00V	
	TTL	1.4V
	5.0V CMOS	2.5V
	3.3V CMOS	1.65V
	2.5V CMOS	1.25V
	ECL	-1.3V
	PECL	3.7V
	0V	0V



Note

Setting the trigger threshold for a digital source will also change the threshold levels set in the Logic Analyzer menu (page 339).

## Using Video Trigger

- Panel Operation 1. Press the trigger *Menu* key.

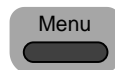

2. Press the *Type* key from the lower bezel menu.



3. Select *Video* from the side menu. The video trigger indicator appears at the bottom of the display.



From left: source, video standard, field, line, coupling



4. Press *Source* from the lower bezel.

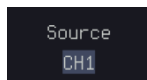

5. Use the side menu to select the video trigger source.

---

Range      Channel 1 ~4

---

6. Press *Standard* on the bottom bezel.



Use the side menu to select the video standard.

---

Range      NTSC, PAL, SECAM, EDTV(480P, 576P), HDTV(720P, 1080i, 1080P)

---

7. Press *Trigger On* to edit the video field and line.

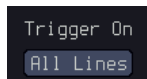

Use the side menu to select the field and line.

---

Odd Field    NTSC: 1 ~ 263  
                  PAL/SECAM: 1 ~ 313  
                  EDTV: 1~525(480P), 1~625(576P)  
                  HDTV: 1~750(720P), 1~562(1080i),  
                  1~1125(1080P)

---

Even Field    NTSC: 1 ~ 262  
                  PAL/SECAM: 1 ~ 312  
                  HDTV: 1~563(1080i)

---

All Fields    Triggers on all fields.

---

All Lines     Triggers on all lines.

---

8. Press *Polarity* to toggle the polarity type.

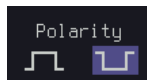



---

Range      positive, negative

---

## Pulse Runt trigger

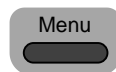
Panel Operation 1. Press the trigger *Menu* key.



2. Press the *Type* key from the lower bezel menu.



3. Select *Others* → *Pulse Runt* from the side menu. The Pulse and Runt indicator appears at the bottom of the display.

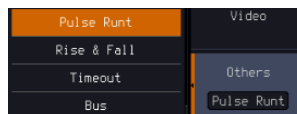

From left: polarity, source, high/low threshold, threshold level, coupling

4. Press *Source* from the lower menu.



Use the side menu to select a source.

Range Channel 1 ~ 4 (Alternate On/Off)

5. Press *Polarity* to toggle the polarity.

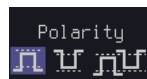

Range Rising edge, falling edge, either.

6. Press *When* from the lower menu.

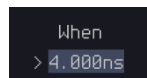

Then use the side menu to select the condition and width.

Condition >, <, =, ≠

Width 4ns ~ 10s

7. Press *Threshold* from the lower bezel to edit the threshold for the upper and lower threshold.

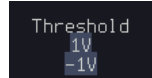

8. Use the side menu to set the upper threshold.



Range -XXV~XXV

9. Use the side menu to set the lower threshold.

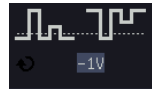

Range -XXV~XXV

### Using Rise and Fall Trigger

- Panel Operation 1. Press the trigger *Menu* key.

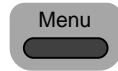

2. Press the *Type* key from the lower bezel menu.



3. Select *Others* → *Rise and Fall* from the side menu. The Rise and Fall indicator appears at the bottom of the display.

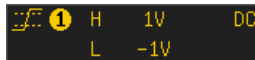
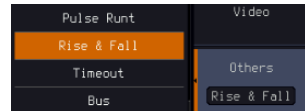

From left: slope, source, high/low threshold, threshold level, coupling

4. Press *Source* from the lower menu.

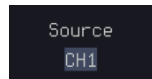

Use the side menu to select a source.

Range Channel 1 ~ 4 (Alternate On/Off)

5. Press *Slope* from the bottom menu to toggle the slope.

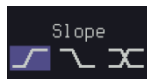

Range      Rising edge, falling edge, either

6. Press *When* from the lower menu.



Then use the side menu to select the logic conditions and true or false status.

Condition    > , < , = , ≠

Width        4ns ~ 10s

7. Press *Threshold* from the lower bezel to edit the High and Low threshold.

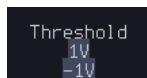

Range        High: -XXV~XXV

Low: -XXV~XXV

## Using the Timeout Trigger

- Panel Operation 1. Press the trigger *Menu* key.

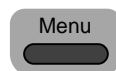

2. Press the *Type* key from the lower bezel menu.



3. Select *Others* → *Timeout* from the side menu. The Timeout indicator appears at the bottom of the display.



**1** Timeout    0V    DC

From left: Source, Trigger type, threshold level, coupling

4. Press *Source* from the lower menu.



Use the side menu to select a source.

---

Range Channel 1~4 (Alternate On/Off),  
EXT (Ext Probe: Volt/Current,  
Attenuation: 1mX~1kX and AC  
Line.

---

5. Press *Coupling* from the bottom bezel menu to select the trigger coupling or frequency filter settings.

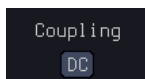

Choose the coupling from the side menu.

---

Range DC, AC, HF Reject, LF Reject

---

6. Toggle *Noise Rejection* On or Off from the Coupling side menu.

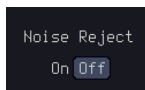



---

Range On, Off

---

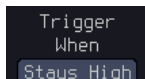
7. Press *Trigger When* from the lower menu.



Then use the side menu to select trigger conditions.

---

Condition Stays High, Stays Low, Either

---

8. Press *Level* from the lower bezel to set the trigger level.



9. Set the level using the side menu.



---

Analog channel Set to TTL 1.4V  
Range Set to ECL -1.3V  
Set to 50%

---

Digital channel	-5.00V~ +5.00V	
Range	TTL	1.4V
	5.0V CMOS	2.5V
	3.3V CMOS	1.65V
	2.5V CMOS	1.25V
	ECL	-1.3V
	PECL	3.7V
	0V	0V



Note

Setting the trigger threshold for a digital source will also change the threshold levels set in the Logic Analyzer menu (page 339).

10. Press *Timer* from the lower bezel to set the timer time.

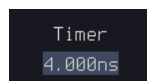

Range 4ns~10.0s

## Using the Bus Trigger

The Bus trigger is used to trigger the oscilloscope on UART, I2C, SPI, CAN or LIN serial bus signals or on parallel bus data.

### UART BUS Trigger Settings

The UART bus trigger conditions can be set at any time after the bus settings have been set to *UART*.

Panel Operation 1. Set the Bus to UART in the bus menu. Page 117

2. Press the *Trigger Menu* key.

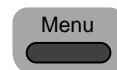

3. Press *Type* from the bottom menu.



4. Press *Others* from the side menu and select *Bus*.

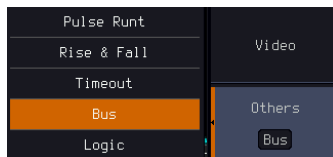

The Trigger on settings will be reflected on the Trigger Configuration icon.



From left: Bus trigger, Trigger source

5. Press *Trigger On* and select the triggering condition for the UART

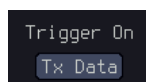

Trigger On Tx Start Bit, Rx Start Bit, Tx End of Packet, Rx End of Packet, Tx Data, Rx Data, Tx Parity Error, Rx Parity Error

Trigger On – Tx Data, Rx Data

If Tx Data or Rx Data was configured for the Trigger On setting, then the number of bytes and data can also be configured.

6. Press *Data* from the bottom menu.

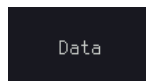

7. Press *Number of Bytes* from the side menu and choose the number of bytes for the data.

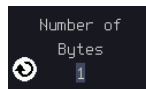

UART 1~10 Bytes

8. Press *Data* from the side menu to edit the triggering data.

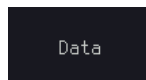

9. To edit the data, use the *VARIABLE* knob to highlight a binary or hex digit and press *Select*. Use the *Variable* knob to choose a value for the digit and press *Select* to confirm.

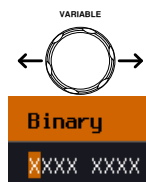

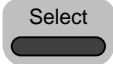
Binary	0,1,X (don't care)	
Hex	0~F, X (don't care)	
ASCII	ASCII characters for the equivalent Hex characters 00 to FF	

### I<sup>2</sup>C Bus Trigger Settings

The I<sup>2</sup>C bus trigger conditions can be set at any time after the bus settings has been set to I<sup>2</sup>C.

Panel Operation 1. Set the Bus to I<sup>2</sup>C in the bus menu. Page 119

2. Press the *Trigger Menu* key.

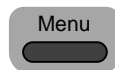

3. Press *Type* from the bottom menu.



4. Press *Others* from the side menu and select *Bus*.

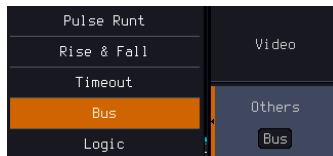

The Trigger on settings will be reflected on the Trigger Configuration icon.



From left: Bus trigger, Trigger source

5. Press *Trigger On* and select the triggering condition for the selected bus.





Trigger On Start, Repeat Start, Stop, Missing Ack, Address, Data, Address/Data

### Trigger On – Data

If Data or Address/Data was configured for the Trigger On setting, then the number of bytes, data and addressing mode (I<sup>2</sup>C) can be configured.

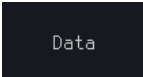

6. Press *Data* from the bottom menu. 

7. Press *Number of Bytes* from the side menu and choose the number of bytes for the data. 

---

I<sup>2</sup>C      1~5 Bytes

---

8. Press *Addressing Mode* to toggle between 7 and 10 bit addressing modes. 

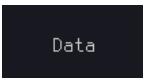
9. Press *Data* from the side menu to edit the triggering data. 

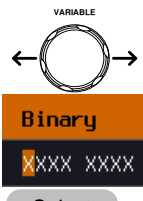
10. To edit the data, use the *VARIABLE* knob to highlight a binary or hex digit and press *Select*. Use the *VARIABLE* knob to choose a value for the digit and press *Select* to confirm. 

---

Binary      0,1,X (don't care)

---

Hex      0~F, X (don't care)

---

Trigger On -  
Address

If Address or Address/Data was configured for the Trigger On setting, then the triggering address must be configured.

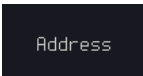
11. Press *Address* on the bottom menu. 

12. Press *Addressing Mode* to toggle between 7 and 10 bit addressing modes. 

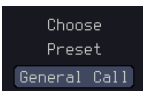
13. To choose a preset address as the default address, press *Choose Preset* and select a preset address. 

Address	Description
0000 000 0	General Call
0000 000 1	START Byte
0000 1XX X	Hs-mode
1010 XXX X	EEPROM
0000 001 X	CBUS

Press *Apply Preset* to set the default address to the preset.

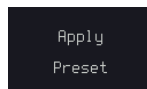

Note

Presets are not available for Trigger On Address/Data.

14. Press *Address* from the side menu to manually edit the triggering address.

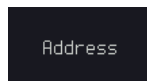

15. To edit the address, use the *VARIABLE* knob to highlight a binary or hex digit and press *Select*. Use the *VARIABLE* knob to choose a value for the digit and press *Select* to confirm.



Binary      0,1, X (don't care)

Hex          0~F, X (don't care)

Direction

16. Press *Direction* on the bottom menu and choose the direction from the side menu.

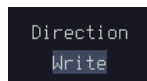

Direction      Write, Read, Read or Write

### SPI Bus Trigger Settings

The SPI bus trigger conditions can be set at any time after the bus setting has been set to SPI.

Panel Operation 1. Set the Bus to SPI in the bus menu.

2. Press the *Trigger Menu* key.

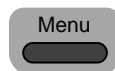

3. Press *Type* from the bottom menu.



4. Press *Others* from the side menu and select *Bus*.

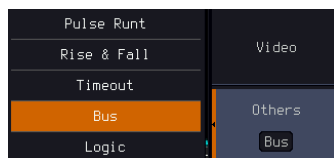

The Trigger on settings will be reflected on the Trigger Configuration icon.



From left: Bus trigger, Trigger source

5. Press *Trigger On* and select the triggering condition for the SPI bus.

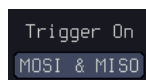

SPI SS Active, MOSI, MISO, MOSI&MISO

Trigger On – Data If MOSI, MISO or MISO/MOSI was configured for the Trigger On setting, then the number of words and the data can be configured.

6. Press *Data* from the bottom menu.

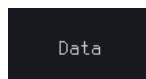

7. Press *Number of Words* from the side menu and choose the number of words for the data.

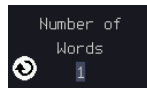

8. Press *MOSI* or *MISO* from the side menu to edit the triggering data.

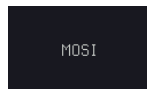

9. To edit the data, use the *VARIABLE* knob to highlight a binary or hex digit and press *Select*. Use the *VARIABLE* knob to choose a value for the digit and press *Select* to confirm.



Binary	0,1,X (don't care)
Hex	0~F, X (don't care)

### CAN Bus Trigger

The CAN bus trigger conditions can be set at any time after the bus setting has been set to CAN.

- Panel Operation
1. Set the Bus to CAN in the bus menu.

Page 120

2. Press the *Trigger Menu* key.

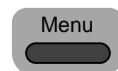

3. Press *Type* from the bottom menu.



4. Select *Others* → *Bus* from the side menu. The Bus indicator appears at the bottom of the display.

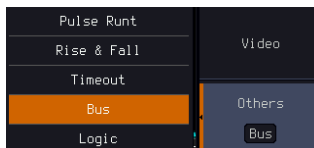

The Trigger on settings will be reflected on the Trigger Configuration icon.

**B Identifier**

From left: Bus trigger, Trigger source

5. Press *Trigger On* and select the triggering condition for the selected bus.

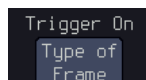

Trigger On Start of Frame, Type of Frame, Identifier, Data, Id & Data, End of Frame, Missing Ack, Bit Stuffing Err

Trigger On –Type of Frame

6. If *Frame Type* was configured for the Trigger On setting, then the type of frame can be configured from the side menu.

**B Type of Frame**

Type Data Frame, Remote Frame, Error Frame, Overload Frame

Trigger On – Identifier

7. If *Identifier/Id & Data* was configured for the Trigger On setting, select the format from the side menu.

Format Standard, Extended

8. Press *Identifier* from the side menu to set the identifier data.

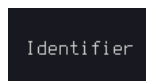

9. To edit the identifier, use the *VARIABLE* knob to highlight a binary or hex digit and press *Select*. Use the *VARIABLE* knob to choose a value for the digit and press *Select* to confirm.



Binary 0,1,X (don't care)

Hex 0~F, X (don't care)

10. Press *Direction* on the bottom menu and select the *CAN Direction* from the side menu.

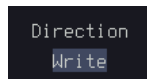

*CAN Direction*    Write, Read, Read or Write

Trigger On - Data

If *Data/Id and Data* was configured for the *Trigger On* setting, then the triggering data must be configured.

11. Press *Data* on the bottom menu.

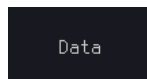

12. Press *Number of Bytes* from the side menu and choose the number of bytes for the data.



*Bytes*            1~8 Bytes

13. Press *Data* from the side menu to edit the triggering data.

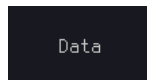

14. To edit the data, use the *VARIABLE* knob to highlight a binary or hex digit and press *Select*. Use the *VARIABLE* knob to choose a value for the digit and press *Select* to confirm.



*Binary*            0,1,X (don't care)

*Hex*                0~F, X (don't care)

15. Press *Trigger When* from the side menu to choose the triggering condition for the data.

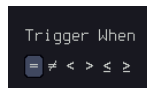

*When*             =, ≠, <, >, ≤, ≥

16. The oscilloscope will now trigger when the specified bus data matches the *Trigger When* conditions.

### LIN Bus Trigger

The LIN bus trigger conditions can be set at any time after the bus setting has been set to LIN.

Panel Operation 1. Set the Bus to LIN in the bus menu. Page 129

2. Press the *Trigger Menu* key.



3. Press *Type* from the bottom menu.



4. Select *Others* → *Bus* from the side menu. The Bus indicator appears at the bottom of the display.

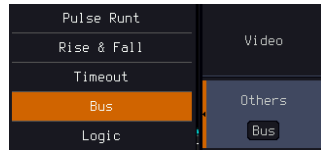

From left: Bus trigger, Trigger source

5. Press *Trigger On* and select the triggering condition for the selected bus.

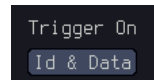

Trigger On Sync, Identifier, Data, Id and Data, Wakeup Frame, Sleep Frame, Error.

Trigger On – Identifier

6. If *Identifier* or *Id & Data* was configured for the Trigger On setting, press *Identifier* from the bottom menu.



7. Press *Identifier* from the side menu to set the identifier data.

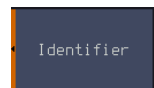

8. To edit the identifier, use the *VARIABLE* knob to highlight a binary or hex digit and press *Select*. Use the *VARIABLE* knob to choose a value for the digit and press *Select* to confirm.



Binary	0,1,X (don't care)
Hex	0~F, X (don't care)

**Trigger On - Data** If *Data/Id and Data* was configured for the Trigger On setting, then the triggering data must be configured.

9. Press *Data* on the bottom menu.

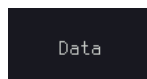

10. Press *Number of Bytes* from the side menu and choose the number of bytes for the data.



Bytes	1~8 Bytes
-------	-----------

11. Press *Data* from the side menu to edit the triggering data.

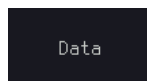

12. To edit the data, use the *VARIABLE* knob to highlight a binary or hex digit and press *Select*. Use the *VARIABLE* knob to choose a value for the digit and press *Select* to confirm.



Binary	0,1,X (don't care)
Hex	0~F, X (don't care)

13. Press *Trigger When* from the side menu to choose the triggering condition for the data.

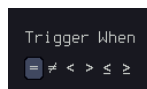

When	=, ≠, <, >, ≤, ≥
------	------------------



- The oscilloscope will now trigger when the specified bus data matches the *Trigger When* conditions.

### Parallel Bus Trigger

The parallel bus trigger conditions can be set at any time after the bus setting has been set to parallel. The parallel bus can be set up to trigger on a specified data pattern.

Panel Operation 1. Set the Bus to parallel in the bus menu.

- Press the *Trigger Menu* key.

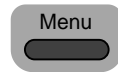

- Press *Type* from the bottom menu.

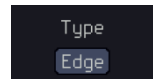

- Select *Others* → *Bus* from the side menu. The Bus indicator appears at the bottom of the display.

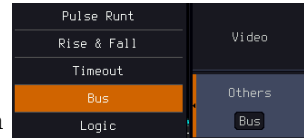

From left: Bus trigger, Data source

- Press *Data* from the bottom menu.

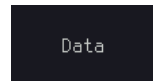

- Press *Data* from the side menu to edit the triggering data.

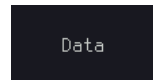

- To edit the data, use the *VARIABLE* knob to highlight a binary or hex digit and press *Select*. Use the *VARIABLE* knob to choose a value for the digit and press *Select* to confirm.

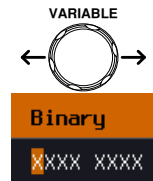

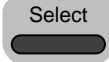
Binary	0,1,X (don't care)	
Hex	0~F, X (don't care)	

- The oscilloscope will now trigger when the specified data appears on the bus.

## Using the Logic Trigger

---

### Background

The digital channels can be set up to trigger on specified logic levels and for a specified clock edge.

For example the digital channels can be set to trigger on the rising edge of a clock signal when bit 1 of a digital channel is high and all other channels are ignored.

### Panel Operation

- Press the *Trigger Menu* key.

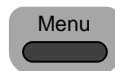

- Press *Type* from the bottom menu.



- Select *Others* → *Logic* from the side menu. The Logic indicator appears at the bottom of the display.



From left: Bits D15~D0

- Press *Define* inputs from the bottom menu.

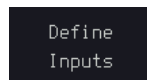

5. Press *Select* on the side menu and select a channel.
6. Next, select a logic level for the selected channel, or set the selected channel as the clock signal.

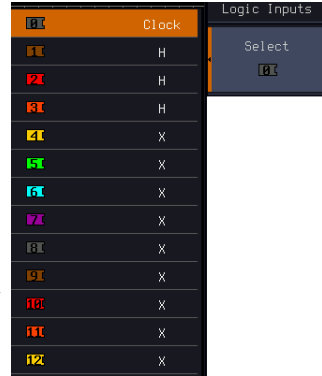



---

Logic	Clock, High (H), Low (L), Don't Care (X)
-------	--

---

7. Repeat steps 5 to 6 for the remaining channels.
8. The chosen logic levels will be reflected in the trigger indicator at the bottom of the screen. The color of each channel, if active will also be displayed. If a channel is not turned on, it will be grayed-out

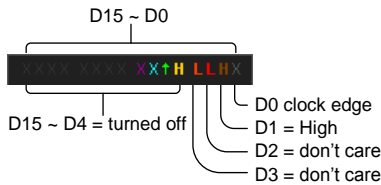
**Example**



**Logic Trigger Timing**

If a channel was selected as a clock signal, then the clock edge determines when the logic comparison is made. If a clock was not defined then the *When* menu determines the triggering timing conditions. This is described below in step 9 and 10.

9. If a clock signal was defined, press *Clock Edge* from the bottom menu and select a clock transition. At each clock transition a comparison will be made.

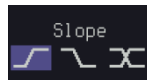

Clock Edge	Rising, Falling, Either
------------	-------------------------

10. If no clock were defined, press *When* from the bottom menu and choose the trigger timing conditions.

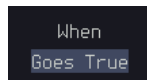

Trigger When	Description
Goes True	Triggers when the defined logic goes true (rising edge).
Goes False	Triggers when the defined logic goes false (falling edge).
Is True >	10.0ns ~ 9.99s. Triggers when the defined logic is true for greater than the defined amount of time (falling edge).
Is True <	10.0ns ~ 9.99s. Triggers when the defined logic is true for less than the defined amount of time (falling edge).
Is True =	10.0ns ~ 9.99s. Triggers when the defined logic is true for the defined amount of time $\pm 5\%$ (falling edge).
Is True $\neq$	10.0ns ~ 9.99s. Triggers when the defined logic is not true for the defined amount of time $\pm 5\%$ (falling edge).

11. The oscilloscope will now trigger when the specified logic appears among the digital channels.

**Trigger Threshold Levels** The trigger threshold levels for the digital channels can be assigned from a selected number of preset levels or a user-defined threshold level.



Note

The threshold levels that are set in this menu will replace the threshold levels that are set in the Logic Analyzer menu (page 339).

12. Press *Thresholds* from the bottom menu.



13. Press *Select* from the side menu and choose a group of channels.

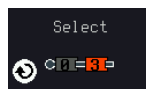

Group D0~D3, D4~D7, D8~D11, D12~D15

14. Press *Choose Preset* to select a preset logic threshold.

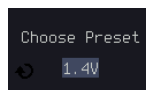

Logic Type	Threshold
TTL	1.4V
5.0V CMOS	2.5V
3.3V CMOS	1.65V
2.5V CMOS	1.25V
ECL	-1.3V
PECL	3.7V
0V	0V

15. Press *Threshold* to set a user defined threshold.



Range ± 5.00V

## Search

The search feature can be used to search for events on the analog and digital input channels. The events that can be searched for are similar to the events that are used for the trigger system. The only difference is that the search feature uses the measurement threshold levels rather than the trigger level to determine events.

### Configuring Search Events

**Background** Similar to configuring the trigger system, the Search events must first be configured before they can be found.

Luckily the trigger system configuration settings can also be used for the search events. The types of searches are listed below. Please note that a full description of the events can be found in the Trigger section on page 139.

**Display**

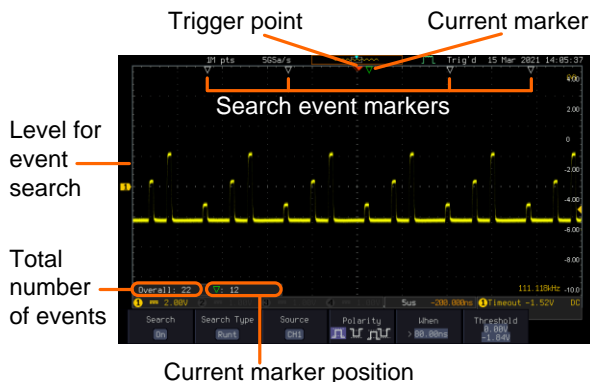

**Search Event Types** Edge, Pulse Width, Runt, Rise and Fall Time, FFT Peak\* and Bus.  
 \*The FFT Peak search event doesn't have a trigger equivalent.

Panel Operation 1. Press the *Search* menu key.



2. Press *Search* from the bottom menu and turn the Search function on.

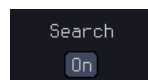

3. Press *Search Type* from the bottom menu and select the type of search. The search events are configured in the same fashion as the trigger events.



Please see the trigger configuration settings for details:

---

Event Types:	Edge, Pulse Width, Runt, Rise/Fall Time, FFT Peak*, Bus
--------------	---

\*No trigger equivalent.

---

4. Select the source from which to search events. Press *Source* from the bottom menu, and select the source.





---

Sources: CH1 ~ CH4, Math

---

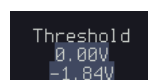
5. To set the threshold levels for the search events (instead of the trigger level that is used for trigger events), use the threshold soft-key from the bottom menu.



The search function can support up to 10,000 events, however only 1,000 events can be displayed on screen at once.

## Copying Search Event To/From Trigger Events

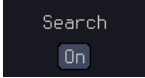
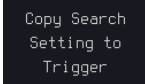
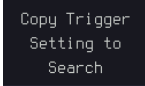
Background	As the trigger system and search feature have similar settings, their settings can be used interchangeably by using the Copy functions.	
Interchangeable Settings	Edge, Pulse Width, Pulse Runt, Rise and Fall Times, Logic and Bus (FFT Peak has no trigger equivalent)	
Panel Operation	<ol style="list-style-type: none"> <li>1. Press <i>Search</i> from the lower bezel menu.</li> </ol>	
	<ol style="list-style-type: none"> <li>2. To copy the settings of the selected search type to the trigger settings, select <i>Copy Search Settings to Trigger</i>.</li> </ol>	
	<ol style="list-style-type: none"> <li>3. To copy over the current trigger settings to the search settings, press <i>Copy Trigger Settings To Search</i>.</li> </ol>	



Note

If the settings cannot be copied or if there are no trigger settings configured (so that you cannot copy from the trigger settings), then those particular options will not be available.

## Search Event Navigation

Background	When using the search feature, each event can be searched according to the event settings.	
Operation	<ol style="list-style-type: none"> <li>1. Turn Search on and set the appropriate search type.</li> <li>2. Search events are marked by hollow white triangles at the top of the graticule.</li> </ol>	Page 176



- Use the search arrow keys to move between each search event.



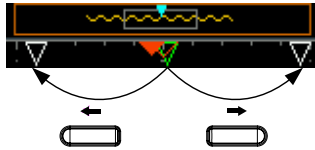

Search events can be navigated in both stop and run mode.





When using the arrow keys to navigate to each event, the “current event” will always be centered on the display.

### Save Search Marks

**Background** The search events can be saved to the graticule display, allowing you to superimpose new search events. Search events are saved over the entire record length, with a maximum of 1000 marks.

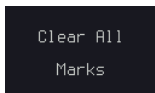
- |                   |   |
|-------------------|---|
| <b>Save Marks</b> | <ol style="list-style-type: none"> <li>Press <i>Search</i> from the lower bezel menu. </li> <li>Press the <i>Save All Marks</i> soft-key. </li> <li>The search event markers will become solid white triangles to indicate that they have been saved.  → </li> </ol> |
|-------------------|---|

<b>Clear All Marks</b>	<p>To clear all the saved marks, press <i>Clear All Marks</i> from the side menu. </p>
------------------------	---

 **Note** Each time the *Save All Marks* function is used, the previously saved marks will also be retained, unless cleared.

## Setting/Clearing Single Search Events

---

**Background** In addition to searching for search events based on Search Type settings, custom search marks can be created with the Set/Clear key.

**Set Search Event** Navigate to a point of interest using **<POSITION>** the horizontal position knob or some other method.



Push to  
Zero

1. Press the *Set/Clear* key.

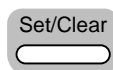

2. A marker will be saved at the center of the display.

This marker can be navigated to/from in the same way that a normally saved search marker can.

**Clear Search Event** To clear a set search event, use the search arrows to navigate to the event of interest and press the Set/Clear key.

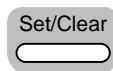

The marker will be deleted from the display.

## FFT Peak

---

**Background** The FFT Peak search type can be used to mark all FFT peaks that are above a certain threshold.

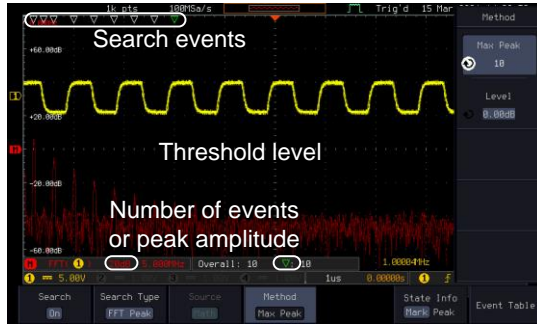

Note

The search function can support up to 10,000 events, however only 1,000 events can be displayed on screen at once.

Panel Operation

1. Turn the FFT math function on.
2. Press the *Search* menu key.
3. Press *Search* from the bottom menu and turn the Search function on.
4. Press *Search Type* from the bottom menu and select *FFT Peak* from the side menu.

Page 68

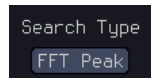

Note

Note that the Math source is automatically selected.

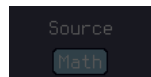

5. Next, select the event search method by pressing *Method* from the bottom menu.

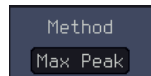

- Select *Max Peak* to search by a selected number of "max" peaks. Select *Level* to set the threshold level for the search events. Any peaks above the threshold level will be seen as a search event.

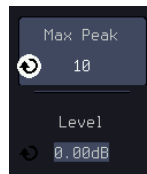

Max Peak 1 ~ 10

Level -100db ~ 100dB

View Number of Peak Events

To view the number of peak events, set *State Info* to Mark. The number of search events will be shown at the bottom of the screen.

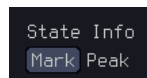

View Amplitude of Peak Search Event

To view the position and amplitude of a selected event, set *State Info* to Peak. This information will be shown at the bottom of the display.

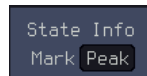

Peak Event Table

The Event Table function tabulates the amplitude and frequency of each peak event in real time. The event table can also be saved to a USB disk drive. File names are saved as a PeakEventTbXXXX.csv, where XXXX is a number starting from 0001 and is incremented each time the event table is saved.

- Press *Event Table* from the bottom menu and turn the Event Table function on.

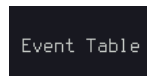

The event table will appear on the screen.

No.	Freq. (Hz)	Mag. (dB)
1	0.0000	-13.6
2	1.0000M	-5.60
3	3.0000M	-5.60
4	5.0000M	-12.0
5	7.0000M	-18.4
6	9.0000M	-24.0
7	11.000M	-29.6
8	13.000M	-31.2
9	15.000M	-33.6
10	17.000M	-33.6

Save Event Table 8. To save the event table, insert a USB memory drive into the front panel USB-A port.

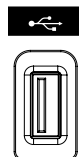

9. Press *Save Event Table*. The event table will be saved as *PeakEventTbXXXX.csv*.

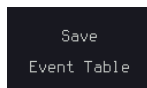

Event Table CSV Format

The format for the CSV file is the same as the event table displayed on the GDS-3000A SERIES screen; No., Frequency, and Value.

For example:

No.	Frequency	Value
1	1.0000MHz	-29.6dB
2	2.0000MHz	-30.4dB
3	3.0000MHz	-32.0dB

Center Peak Results on Screen

To shift the peak events to the center of the screen, press *Selected Peak To Center* from the event table side menu.

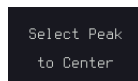

## System Settings

This section describes how to set the interface, language, time/date, probe compensation signal, erase the internal memory and access useful QR codes.

### Select Menu Language

**Description**      The GDS-3000A SERIES has a number of different languages to choose from.

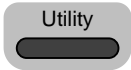
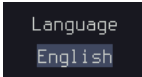
- Panel Operation**
1. Press the *Utility* key. 
  2. Press *Language* on the lower menu. 
  3. Select the language\* from the side menu.



Note

Language selection may differ based on region, and as such are not listed here.

### View System Information

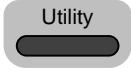
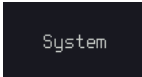
- Panel Operation**
1. Press the *Utility* key. 
  2. Press *System* from the lower menu. 
  3. Press *System Info* from the side menu. A display panel will appear showing:
    - Manufacturer name
    - Model name
    - Serial number
    - Firmware version
    - Manufacturer URL

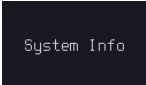

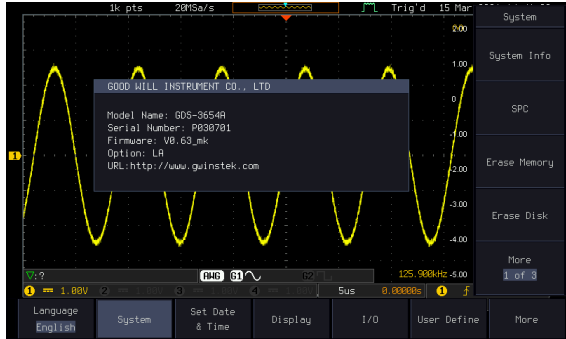

## Erase Memory

**Background** The Erase Memory function will erase all internal waveforms, setup files and labels from internal memory.

**Erased Items** Waveform 1~20, Setting memory 1~20, Reference 1~4, Labels

**Panel Operation** 1. Press the *Utility* key.

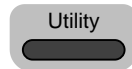

2. Press *System* from the lower menu.

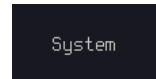

3. Press *Erase Memory* from the side menu.

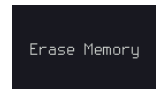

A message will prompt you to press *Select* key to confirm this process. Press another key to cancel this process.

## Erase Disk

**Background** The Erase Disk function will erase all files from the internal flash driver.

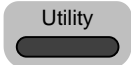
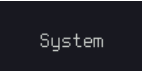
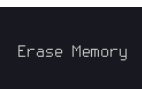

Erased Items      Waveform 1~20, Setting memory 1~20, Reference 1~4, Labels

- Panel Operation
1. Press the *Utility* key. 
  2. Press *System* from the lower menu. 
  3. Press *Erase Memory* from the side menu. 

A message will prompt you to press Select to confirm this process. Press another key to cancel this process.

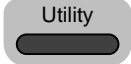
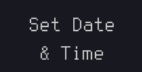
## Set Date and Time

- Panel Operation/  
Parameter
1. Press the *Utility* key. 
  2. Press *Set Date & Time* on the lower menu. 
  3. Set the *Year, Month, Day, Hour* and *Minute* from the side menu.
 

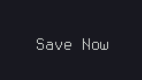
Year	2000 ~ 2037	
Month	1 ~ 12	
Day	1 ~ 31	
Hour	1~23	
Minute	0~59	
  4. Press *Save Now* from the side menu to save the date and time. 



5. Make sure the date/time setting is correctly reflected at the top of the display.

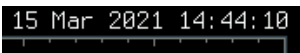

## Probe Compensation Frequency

Background

The probe compensation output can be set from 1kHz (default) to 200kHz, in steps of 1kHz.

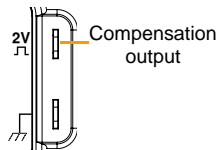

Panel Operation/  
Parameter

1. Press the *Utility* key.
2. Press the *More* key.
3. Press *Probe Comp.* on the lower menu.
4. Press *Frequency* and change the frequency of the probe compensation signal.

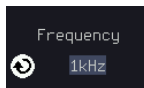
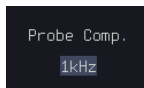
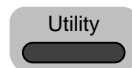

Default Frequency

5. Press *Default* to set the frequency of the probe compensation signal to 1kHz default.

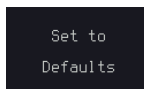

## QR Code Reader Function

Background

The QR Code reader function displays a number of preset QR codes that link to useful websites.

QR Code Items

- GW Instek website
- GW Instek contact window (marketing department)

Panel Operation/  
Parameter

1. Press the *Utility* key.
2. Press *System* from the lower menu.
3. Press *More 1 of 3*, *More 2 of 3* from the side menu.
4. Press *QR Code* from the side menu. There will be two pages of QR codes to choose from.
5. Press *Page 1* or *Page 2* to navigate to each page.

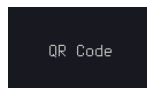
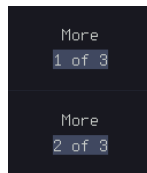
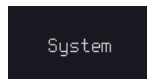
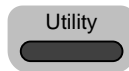

6. Use a QR code reader app on your smart phone or tablet to read one of the QR codes.

# Display

The Display menu defines how the waveforms and parameters appear on the main LCD display.

## Display Waveform as Dots or Vectors

**Background** When the waveform is displayed on the screen, it can be displayed as dots or vectors.

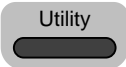
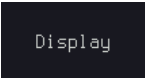
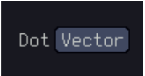
- Panel Operation**
1. Press the *Utility* key. 
  2. Press the *Display* key. 
  3. Press *Dot / Vector* to toggle between Dot and Vector mode. 

<b>Range</b>	<b>Dots</b>	Only the sampled dots are displayed.
	<b>Vectors</b>	Both the sampled dots and the connecting line are displayed.



## Ruler On/Off

**Background** The Ruler function adds a scale to the graticule.

 **Note** This mode only functions in the vertical.

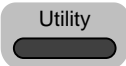
- Panel Operation**
1. Press the *Utility* key. 

2. Press the *Display* menu key.

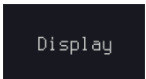

3. Press *Ruler* to toggle the Ruler function on/off

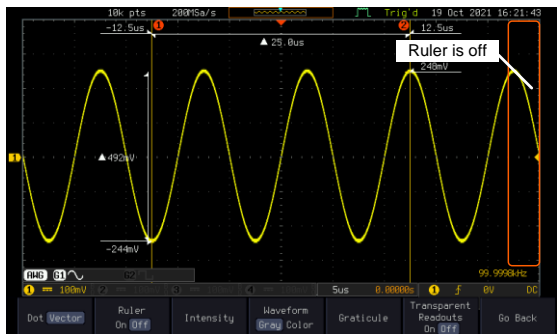
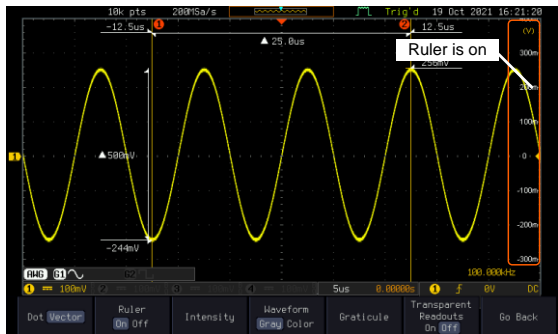

## Set the Intensity Level

### Background

The intensity level of a signal can also be set to mimic the intensity of an analog oscilloscope by setting the digital intensity level.

### Panel Operation

1. Press the *Utility* key.

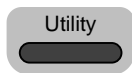

2. Press the *Display* menu key.

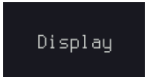

3. Press *Intensity* from the bottom menu.

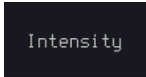

Waveform Intensity

4. To set the waveform intensity, press *Waveform Intensity* and edit the intensity.

Range 0~100%

Example

Waveform Intensity 50%

Waveform Intensity 100%

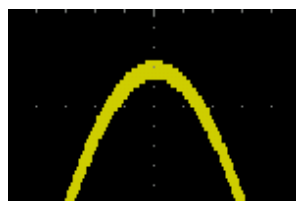
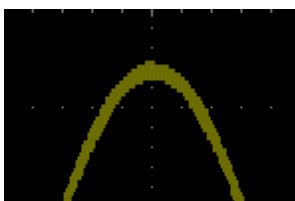

Graticule Intensity

5. To set the graticule intensity, press *Graticule Intensity* from the side menu and edit the intensity value.

Range 10~100%

Example

Graticule Intensity 100%

Graticule Intensity 10%

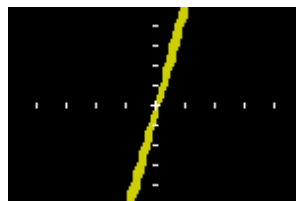
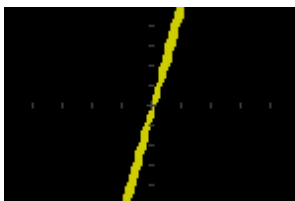

Backlight Intensity

6. To set the LCD backlight intensity, press *Backlight Intensity* from the side menu and edit the intensity value.

Range 2~100%

Backlight Auto-Dim

- To automatically dim the backlight after a set duration, set *Backlight Auto-Dim* to On and then set *Time* to the appropriate time.

After the set amount of time with no panel activity, the screen will dim until a panel key is pressed again. This function will prolong the life of the LCD display.

Range 1~180 min

Time

Screensaver Range: 1min~180min

Waveform

The intensity gradient of a signal can be set to grayscale or color. If intensity is set to color, the intensity gradient is analogous to a thermal color gradient where high intensity areas are colored red and low intensity areas are colored blue.

Range Waveform in gray or color display  
Gray/Color

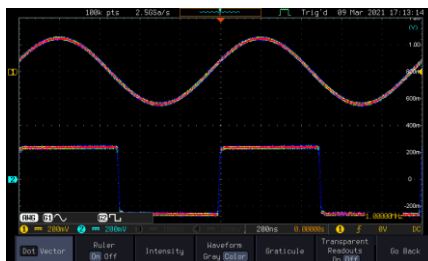
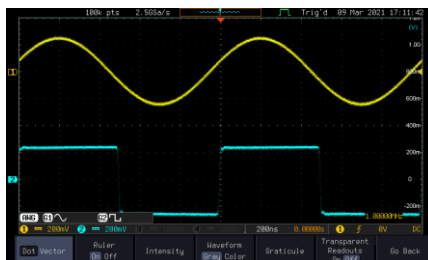

## Select Display Graticule

Panel Operation

1. Press the *Utility* key.

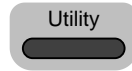

2. Press the *Display* key.

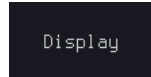

3. Press *Graticule* from the bottom menu.

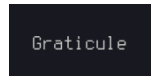

4. From the side menu choose the graticule display type.



*Full*: Shows the full grid; X and Y axis for each division.



*Grid*: Show the full grid without the X and Y axis.



*Cross Hair*: Shows only the center X and Y frame.



*Frame*: Shows only the outer frame.

Transparent Readouts

Readout background in transparent or opaque setting.

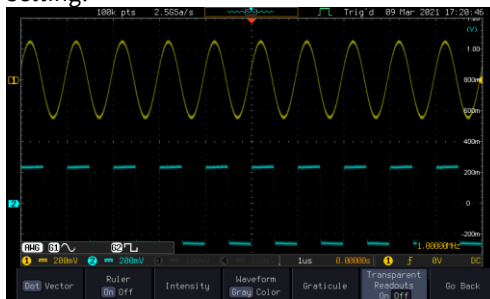

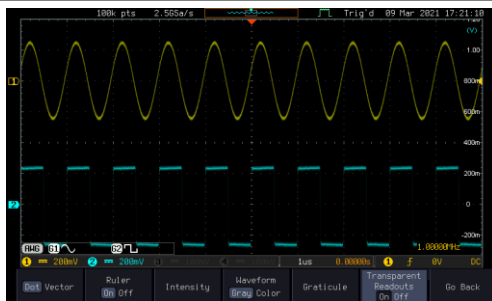

### Freeze the Waveform (Run/Stop)

For more details about Run/Stop mode, see page 39.

- Panel Operation
1. Press the *Run/Stop* key. The *Run/Stop* key turns red and waveform acquisition is paused.



2. The waveform and the trigger freezes. The trigger indicator on the top right of the display shows Stop.



3. To unfreeze the waveform, press the *Run/Stop* key again. The *Run/Stop* key turns green again and acquisition resumes.



### Turn Off Menu

- Panel Operation
1. Press the *Menu Off* key below the side menu keys to reduce a menu. The menu key needs to be pressed each time to reduce one menu.



See page 30 for more information.



# ARBITRARY WAVE GENERATOR

---

Arbitrary Wave Generator Operation .....	196
Overview .....	196
Rear Panel .....	196
AWG Display Overview .....	197
Generator Connection .....	197
Output Setup .....	198
Select the Active Channel .....	198
Turn the Output On for the Selected Channel .....	199
Setting the Load Impedance .....	199
Setting the Phase .....	199
GEN1 and GEN2 Setup .....	200
Selecting a Waveform .....	200
Waveform Settings .....	201
AM Modulation .....	203
FM Modulation .....	206
FSK Modulation .....	208
Sweep .....	209
Manage Arbitrary Waveforms .....	211
Create New ARB Waveform .....	211
Edit an Existing ARB Waveform .....	213
Load ARB Waveform .....	220
Save ARB Waveform .....	221
Coupling and tracking waveforms settings .....	223

# Arbitrary Wave Generator Operation

## Overview

Background	The AWG is a full-function dual channel arbitrary waveform generator.
Waveforms	Arbitrary, Sine, Square, Pulse, Ramp, DC, Noise, Sinc, Gaussian, Lorentz, Exp. Rise, Exp. Fall, Haversine, Cardiac
Functions	AM, FM, FSK, Sweep

## Rear Panel

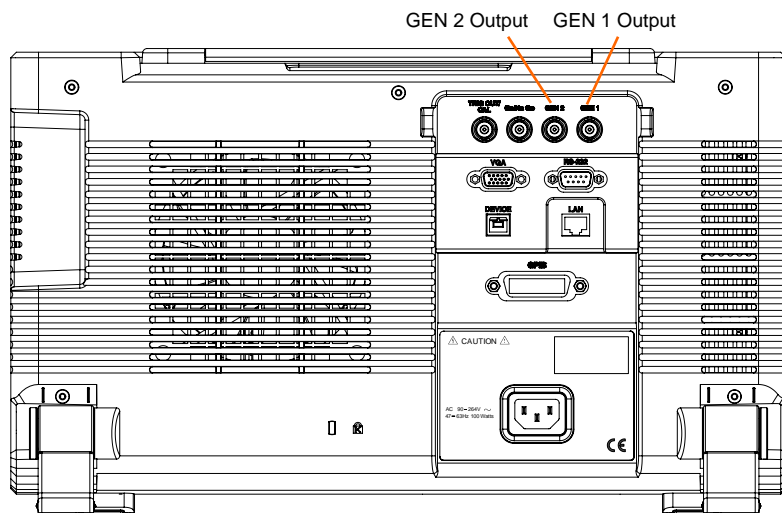

GEN1 and GEN2 Output



Outputs for the Generator 1 or Generator 2 signals.

## AWG Display Overview

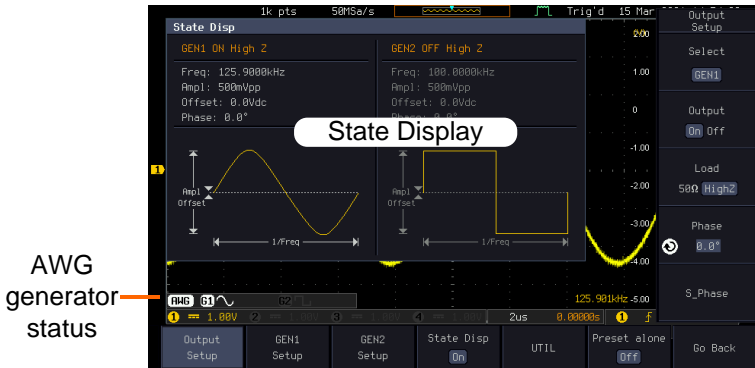



**State Display** The state display is used to visually show the major channel settings when you are in the AWG menu.

**AWG Generator Status Indicators** The AWG channel status indicators show the active channels, output waveforms and function.

 AWG status indicator

 Channel status indicator (G1, G2)

 Waveform indicator of the indicated channel (Sine, arbitrary, pulse etc...).

 Function indicator for the indicated channel (AM, FM, FSK, SWP).

## Generator Connection

**Background** This section will explain how to connect a DUT to the channel outputs.

- Connection
1. Connect the BNC output (GEN1 or GEN2) to the DUT using the GTL-101 BNC-Alligator clip cables.

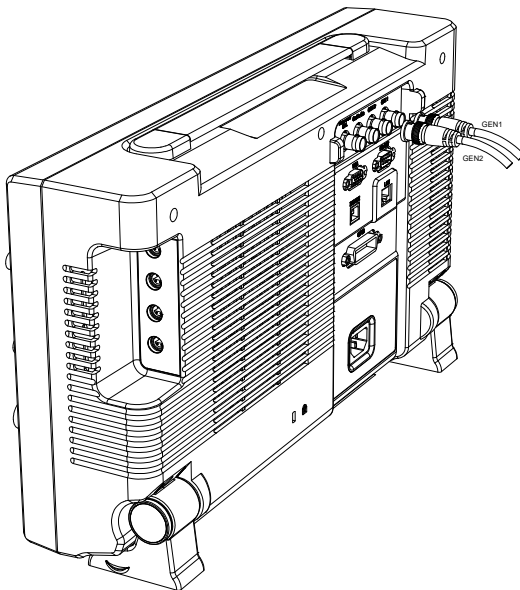

## Output Setup

The Output Setup menu allows you to select a channel, to turn the output on or off for the selected channel, configure the load impedance and the phase of the output.

### Select the Active Channel

Background Before any operations can be performed on a channel it must first be selected.

- Panel Operation
1. Press the *LA/AWG* key.

LA/ AWG



2. Press *AWG* from the bottom menu.



3. Press *Output Setup*.

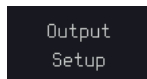

4. Press *Select* from the side menu and choose GEN1 or GEN2.



## Turn the Output On for the Selected Channel

---

**Background** The output for each generator channel can be turned on or off independently.

**Panel Operation** 1. Press *Output* to toggle the selected channel on or off.



## Setting the Load Impedance

---

**Background** The load impedance can be independently set for each generator channel.

**Panel Operation** 1. Press *Load* to toggle the impedance between 50Ω and High Z.

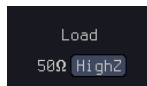

## Setting the Phase

---

**Background** The output phase can only be set for the GEN1 output. GEN2 is always set to an output phase of 0°.

**Panel Operation** 1. Press *Phase* and use the *VARIABLE* knob to set the phase.



**Phase** -180° ~ 180°

- Reset Phase      2. The phase can be reset by pressing *S\_Phase*.



## GEN1 and GEN2 Setup

The GEN1 Setup and GEN2 Setup selects the output waveform, waveform settings (amplitude, frequency, offset), modulation mode or allows you to create arbitrary waveforms.

### Selecting a Waveform

- Background      The AWG option has 14 selectable waveforms, including a user-created arbitrary waveform. When using the modulation function, the waveform selected here is also used as the carrier wave.

- Panel Operation      1. From the AWG menu press *GEN1 Setup* or *GEN2 Setup* to select the waveform for generator 1 or generator 2, respectively.



or



2. Press *Waveform* from the bottom menu.



3. From the side menu press the waveform softkey and select a waveform using the *VARIABLE* knob.



Selectable waveforms Arbitrary, sine, square, pulse, ramp, DC, Noise, Sinc, Gaussian, Lorentz, Exp. Rise, Exp. Fall, Haversine, Cardiac.

**Waveform Settings**

**Background** The Waveform Settings sub menu selects the Frequency, amplitude and offset settings for currently selected waveform in the GEN1 or GEN2 Setup menu.

1. From the Waveform menu, press *Waveform Settings* from the side menu.

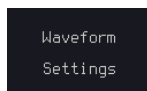

2. Press *Frequency* to set the frequency rate of the waveform.

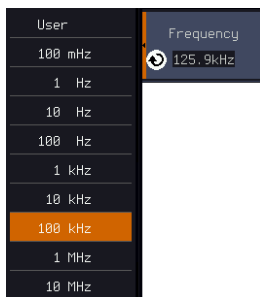

When *Frequency* is initially pressed the *VARIABLE* knob can be used to quick-select the frequency step-resolution. The *VARIABLE* knob can then be used to set the frequency in increments of the step resolution.

**Range** Arbitrary, Sine: 100mHz ~ 25MHz  
 Square, Pulse: 100mHz ~ 15MHz  
 Others: 100mHz ~ 1MHz

Set the Amplitude 3. Press *Amplitude* to set the amplitude of the waveform (use *VARIABLE* knob to input value).

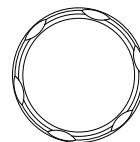

4. Use the Left and Right arrow keys to select a base unit and use *VARIABLE* knob to increase the amplitude by that base unit, as shown in the Amplitude window. Or use the numerical keypad to input value.

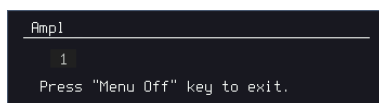

5. Press Go Back to leave the menu.

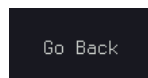

Range	10mVpp to 2.5Vpp (Load:50Ω) 20mVpp to 5Vpp (Load: High Z)
Default	1.00Vpp

Set the Offset

6. Press *Offset* to set the offset of the waveform.

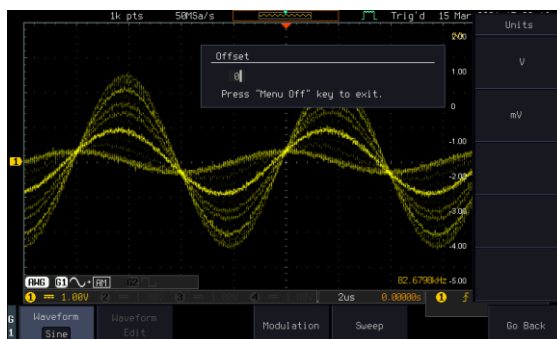
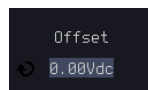



- Use the Left and Right arrow keys to select a base unit and use *VARIABLE* knob to increase the offset by that base unit, as shown in the Offset window. Or use the numerical keypad to input value.

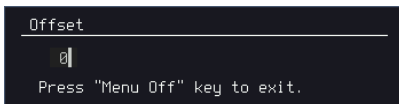

- Default can be pressed to set the Offset to 0.00Vdc.

- Press Go Back to leave the menu.

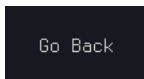

Range	-1.245 ~ +1.245 (Load: 50Ω) -2.49 ~ + 2.49 (Load: High Z)
Default	0.00Vdc

Exit Waveform Settings

- Press *Go Back* to exit the waveform settings.

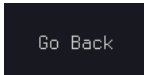

## AM Modulation

---

Background

Amplitude modulation can be used for either channel. All waveforms except Noise and DC can be used as the carrier wave. Sine, square, pulse, ramp and noise can be selected as the modulating waveform.

Example

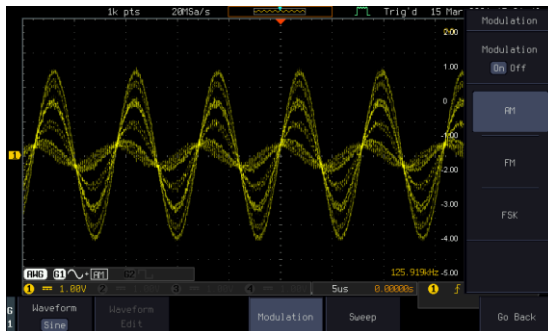

- Panel Operation
1. Select the carrier waveform from the GEN1 Setup/GEN2 Setup menu:

Press *GEN1 Setup* or *GEN2 Setup* for generator 1 or generator 2, respectively.



Press *Waveform* from the bottom menu.

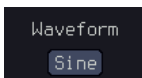

Select the waveform from the side menu. This will be the carrier wave.

**Carrier Waves** Sine, square, pulse, ramp, sinc, gaussian, Lorentz, exp. rise, exp. fall, haversine, cardiac.

2. Press the *Modulation* from the bottom menu.

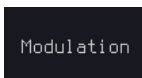

3. From the side menu, turn *Modulation* on.



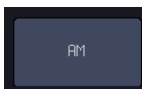

4. Press *AM* to select AM modulation and to enter the AM modulation setup menu.

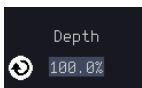

Set the Modulation

5. Press *Depth* to set the modulation depth.

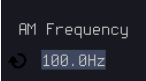

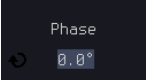
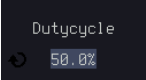
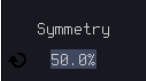
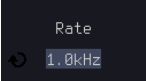
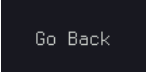
Depth	Depth	0.0% ~ 120.0%	
Modulation Frequency	6. Press <i>AM Freq</i> to set the modulation frequency.		
	Frequency	200kHz ~ 1Hz	
Shape	7. Press <i>Shape</i> to set the modulating wave shape.		
	Shape	Sine, square, pulse, ramp, noise	
Phase (Sine wave only)	8. Press <i>Phase</i> to set the phase of the modulated wave (sine wave).		
	Phase	-180.0° ~ 180.0°	
Duty Cycle (Pulse wave only)	9. Press <i>Duty Cycle</i> to set the duty cycle (pulse wave).		
	Duty Cycle	2.0 ~ 98%	
Symmetry (Ramp wave only)	10. Press <i>Symmetry</i> to set the symmetry (pulse wave).		
	Symmetry	0% ~ 100%	
Rate (Noise wave only)	11. Press <i>Rate</i> to set the rate (noise wave).		
	Noise	1kHz ~ 10MHz	
Exit AM Settings	12. Press <i>Go Back</i> to exit the AM settings.		

## FM Modulation

**Background** Frequency modulation can be used for either channel. The carrier wave can only be sine, square and ramp waveforms. Sine, square, pulse, ramp and noise can be selected as the modulating waveform.

### Example

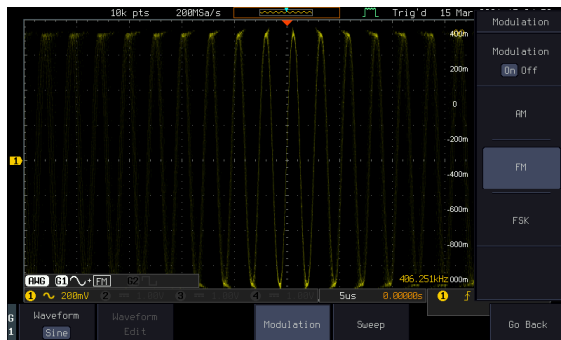

**Panel Operation** 1. Select the carrier waveform from the GEN1 Setup/GEN2 Setup menu:

2. Press *GEN1 Setup* or *GEN2 Setup* for generator 1 or generator 2, respectively.



3. Press *Waveform* from the bottom menu.



4. Select the waveform from the side menu. This will be the carrier wave.





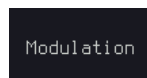

**Carrier Waves** Sine, square, ramp

5. Press the *Modulation* from the bottom menu.

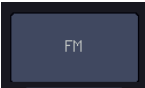

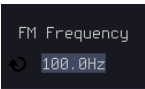
6. From the side menu, turn *Modulation* on.

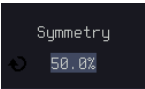
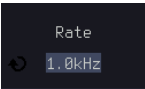

	7. Press <i>FM</i> to select FM modulation and to enter the FM modulation setup menu.	
Set the Frequency Deviation	8. Press <i>Freq Dev</i> to set the frequency deviation.	
	Deviation	12.5MHz ~ 0.1Hz
Modulation Frequency	9. Press <i>FM Freq</i> to set the modulation frequency.	
	Frequency	200kHz ~ 1Hz
Shape	10. Press <i>Shape</i> to set the modulating wave shape.	
	Shape	Sine, square, pulse, ramp, noise
Phase (Sine wave only)	11. Press <i>Phase</i> to set the phase of the modulated wave (sine wave).	
	Phase	-180.0° ~ 180.0°
Duty Cycle (Pulse wave only)	12. Press <i>Duty Cycle</i> to set the duty cycle (pulse wave).	
	Dutycycle	1% ~ 99%
Symmetry (Ramp wave only)	13. Press <i>Symmetry</i> to set the symmetry (ramp wave).	
	Symmetry	0% ~ 100%
Rate (Noise wave only)	14. Press <i>Rate</i> to set the rate (noise wave).	
	Rate	1kHz ~ 10MHz

Exit FM Settings 15. Press *Go Back* to exit the FM settings.

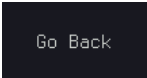

## FSK Modulation

**Background** Frequency Shift Keying Modulation is used to shift the frequency output of the function generator between two preset frequencies (carrier frequency, hop frequency).

### Example

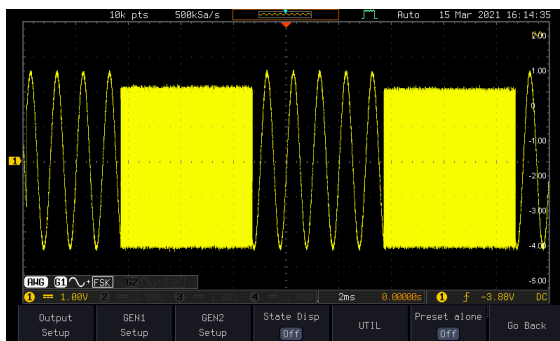

**Panel Operation** 1. Select the carrier waveform from the GEN1 Setup/GEN2 Setup menu:

Press *GEN1 Setup* or *GEN2 Setup* for generator 1 or generator 2, respectively.



Press *Waveform* from the bottom menu.

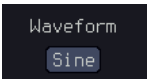



Select the waveform from the side menu. This will be the carrier wave.

**Carrier Waves** Sine, square, ramp

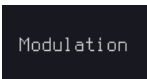
2. Press the *Modulation* from the bottom menu.

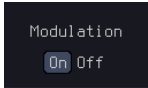
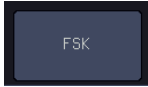

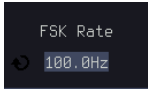
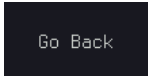
- |                   |   |   |
|-------------------|---|---|
|                   | 3. From the side menu, turn <i>Modulation</i> on.   |  |
|                   | 4. Press <i>FSK</i> to select FSK modulation and to enter the FSK modulation setup menu.                    |  |
| Set the Hop Freq  | 5. Press <i>Hop Freq</i> to set the hop frequency.  |  |
|                   | Hop Freq      25MHz ~ 0.1Hz   |   |
| FSK Rate          | 6. Press <i>FSK Rate</i> to set the rate at which the waveform switches from the carrier and hop frequency. |  |
|                   | FSK Rate      1Hz ~ 200kHz  |   |
| Exit FSK Settings | 7. Press <i>Go Back</i> to exit the FSK settings.   |  |

## Sweep

**Background**      The Sweep function can be used with sine, square and ramp waveforms for either channel. The function supports linear or logarithmic sweeping as well as up or down sweeping.

## Example

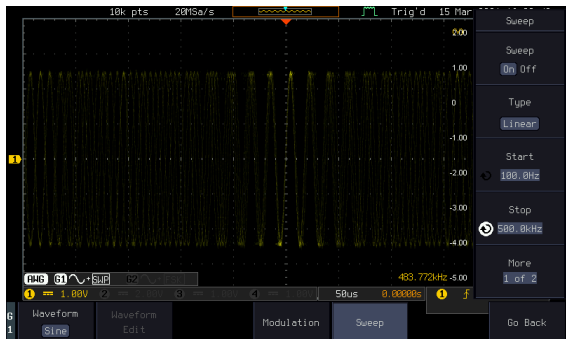

Panel Operation 1. Select the waveform from the GEN1 Setup/GEN2 Setup menu:

Press *GEN1 Setup* or *GEN2 Setup* for generator 1 or generator 2, respectively.



Press *Waveform* from the bottom menu.



Select the waveform from the side menu.

Sweep Waves Sine, square, ramp.

2. Press the *Sweep* from the bottom menu.

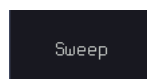

3. From the side menu, turn *Sweep* on.



Type of Sweep 4. Press *Type* to set the sweep to linear or logarithmic.

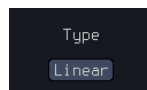

Type Linear, Log

Start and Stop Frequency 5. Press the *Start* or *Stop* soft-keys to set the start and stop frequency, respectively.

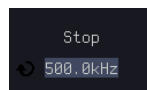

Start/Stop 25MHz ~ 0.1Hz







Note

To configure a up sweeping, set the start frequency at a lower value than the stop frequency. To configure a down sweeping, set the start frequency at a higher value than the stop frequency.

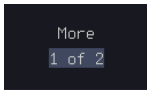
Center Frequency & Span Alternatively the center frequency and span can be set instead of the start and stop frequencies.



	6. Press <i>More</i> 1 of 2.	
Sweep Time	7. Press <i>SWP Time</i> to set how long the sweep takes to go from the start to the stop frequency.	
	Sweep time      5.0us ~ 10s	
	8. Press <i>Span</i> to set the frequency span of the sweep.	
	9. Press <i>Center</i> to set the center frequency for the configured span.	
	Span              25Mhz ~ -25MHz	
	Center            25MHz ~ 0.1Hz	

 **Note**      To configure a up sweeping, set the span with a positive frequency. To configure a down sweeping, set the span with a negative frequency.

### Manage Arbitrary Waveforms

The Arbitrary Waveform menus allow you to create, edit, recall and save arbitrary waveforms. The menus are accessible via the *Waveform Edit* button on the bottom menu once GEN1 or GEN2 has been setup with an arbitrary waveform.

### Create New ARB Waveform

**Background**      The Create New menu is used to load an inbuilt waveform with a defined length in order to build the shape of the arbitrary waveform. Supported waveforms include: Sine, Square, Pulse, Ramp and Noise.

Example

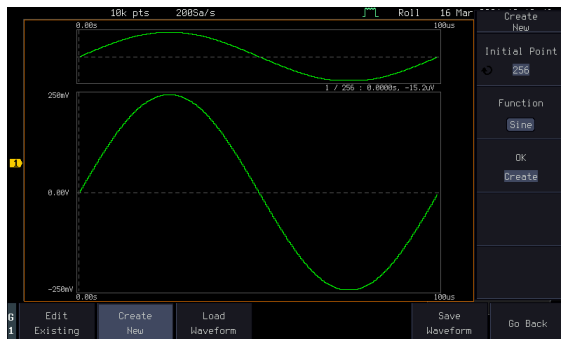

- Panel Operation
1. Select an arbitrary waveform from the GEN1 Setup/GEN2 Setup menu:

Press *GEN1 Setup* or *GEN2 Setup* for generator 1 or generator 2, respectively.



Press *Waveform* from the bottom menu.

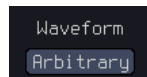

Select *Arbitrary* from the side menu.

2. Press the *Waveform Edit* from the bottom menu.

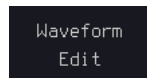

3. From the bottom menu select *Create New*.

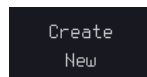

4. Press *Initial Points* to set the number of points for the waveform length.

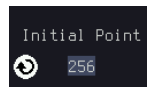

Initial Points 2 ~ 16384

5. Press *Function* to choose an inbuilt waveform:



Function: Sine, Square, Pulse, Ramp, Noise

6. Press *OK Create* to create the arbitrary waveform shape.

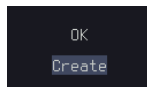

## Edit an Existing ARB Waveform

---

**Background** Use the Edit Existing menu to edit a newly created waveform and further shape it according to your requirements. You can also use the Edit Existing menu for arbitrary waveforms that have been recalled (see Load Waveform page 220). There are two main options that can be used to edit waveforms: Normal Edit and Function Edit.

---

**Editing Methods** **Normal Edit:**  
The Normal Edit function allows you to insert or delete points at any position on a waveform.

**Function Edit:**  
The Function Edit function allows you to edit the waveforms in a number of different ways:

- **Point/Line:** Insert a point or horizontal line into the ARB waveform.
- **Diagonal:** Insert a diagonal line
- **Scale:** Scales the ARB waveform vertically.
- **Copy/Paste:** Copy or paste a section of the ARB waveform.
- **Clear:** Clears a section of the ARB waveform and replaces it with a 0V DC waveform.

Example

This box shows the editing window in relation to the full ARB waveform

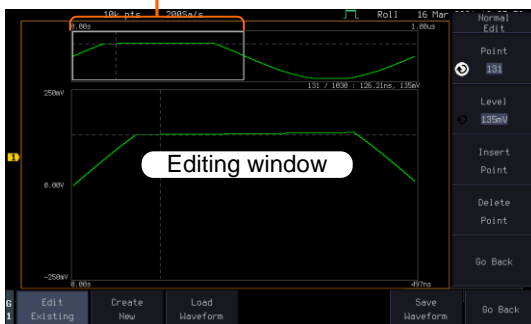

Panel Operation

1. Select a waveform from the GEN1 Setup/GEN2 Setup menu:

Press *GEN1 Setup* or *GEN2 Setup* for generator 1 or generator 2, respectively.



Press *Waveform* from the bottom menu.

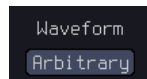

Select *Arbitrary* from the side menu.

2. Press the *Waveform Edit* from the bottom menu.

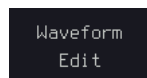

Edit Existing

3. From the bottom menu select *Edit Existing*.

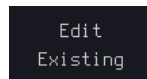

This will allow you to edit the ARB waveform that is currently loaded in memory. If no waveform has been loaded, a DC waveform is shown.

Normal Edit

4. Press *Normal Edit* to insert a point or delete a point from the waveform:

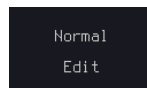

Insert Point:

To insert a point, you must first set the position of the point to be inserted.

- a. Press *Point* to set the x-axis position of the point.

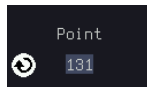

Point            1 ~ user-defined point position

- b. Press *Level* to set the amplitude of the point. The max/min amplitude depends on the waveform amplitude settings, see page 201.

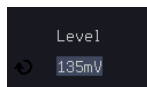

Level            ±1.25Vdc (Load: 50Ω)  
                     ±2.5Vdc (Load: High Z)

- c. Press *Insert Point*. The inserted point will increase the length of the waveform by one point.

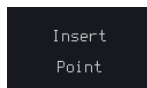

Delete Point:

- d. Press *Delete Point* to delete the point set with the “Point” soft-key.

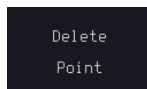

The overall length of the waveform will be shortened by one point.

- Exit Normal Edit    5. Press *Go Back* to exit the Normal Edit.

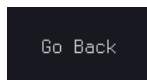

- Function Edit        6. Press *Function Edit* to perform more advanced editing functions.

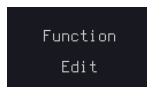

7. Press *Edit Method* to choose the editing method:

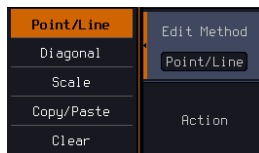

Edit Method: Point/Line  
 Diagonal  
 Scale  
 Copy/Paste  
 Clear

8. Press *Action* to begin using the selected editing method:

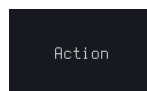

Point/Line:

a. Press *Point/Level* once to select the point's X-axis start point.



Press *Point/Level* again to select the amplitude (Level)

Point 1 ~ user-defined point position

Level  $\pm 1.25\text{Vdc}$  (Load:  $50\Omega$ )  
 $\pm 2.5\text{Vdc}$  (Load: High Z)

b. Press *Length* to set the length of the line.

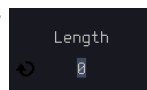

Length 0 ~ user-defined point length

c. The *Adjustment* soft-key can be used to toggle the step resolution of the *VARIABLE* knob when editing values in this menu.



Adjustment Fine, Coarse

d. Press *Preview*. The desired edit will then be previewed on the screen.

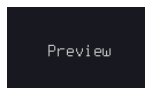

e. Press *Done* to confirm the edit, or press *Undo* to cancel.

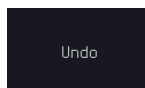
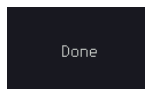

f. Press *Go Back* to go back to the previous menu.

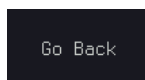

Diagonal:

a. Press *Point1/Level1* once to select the point's X axis start point.



Press *Point1/Level1* again to select the amplitude (Level) of the start point.

Point1 1 ~ user-defined point position

Level1 ±1.25Vdc (Load: 50Ω)  
±2.5Vdc (Load: High Z)

b. Press *Point2/Level2* once to select the point's X axis end point.



Press *Point2/Level2* again to select the amplitude (Level) of the end point.

Point2 1 ~ user-defined point position

Level2 ±1.25Vdc (Load: 50Ω)  
±2.5Vdc (Load: High Z)

c. The *Adjustment* soft-key can be used to toggle the step resolution of *VARIABLE* knob



when editing values in this menu.

Adjustment                      Fine, Coarse

d. Press *Preview*. The desired edit will then be previewed on the screen. 

e. Press *Done* to confirm the edit, or press *Undo* to cancel. 

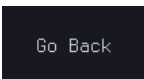
f. Press *Go Back* to go back to the previous menu. 

Scale:

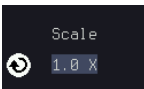
a. Press *Scale* and use *VARIABLE* knob to set the scale of the waveform vertically. 



Note

If the waveform exceeds the maximum amplitude it will be clipped.

Scale                      0.1x ~ 10X

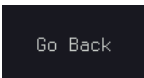
b. Press *Go Back* to go back to the previous menu. 

Copy/Paste:







a. Press *Start* to set the start point of the section you want to copy. 

b. Press *Length* to set the size of the section you want to copy from the start point. 

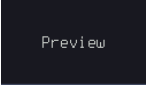
The copied section will be shown as a grey box on the display

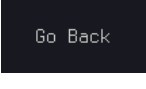
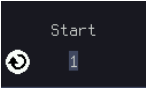
Start                      1 ~ user-defined point position

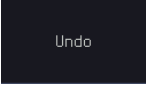

Length	1 ~ user defined point length
c.	Press <i>Paste To</i> to choose where the selected section is copied to. 
Paste To	1 ~ user defined point position
d.	Press <i>Preview</i> . The desired edit will then be previewed on the screen. The pasted section will be shown as a yellow box on the screen. 
e.	Press <i>Done</i> to confirm the edit, or press <i>Undo</i> to cancel. 
f.	Press <i>Go Back</i> to go back to the previous menu. 
Clear Section:	
a.	Press <i>Start</i> to set the start point of the section you want to clear. 
	Press <i>Length</i> to set the size of the section you want to clear. 
Start	1 ~ user-defined point position
Length	1 ~ user-defined point length
b.	Press <i>Undo</i> to clear the selected section. 
c.	Alternatively, press <i>All</i> to clear the entire waveform from the screen. 

- d. Press *Go Back* to go back to the previous menu.

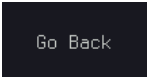

## Load ARB Waveform

---

**Background** ARB waveforms can be loaded from internal memory or from an external USB storage. It can also be loaded directly from the input channels

---

- Panel Operation**
1. Select a waveform from the GEN1 Setup/GEN2 Setup menu:

Press *GEN1 Setup* or *GEN2 Setup* for generator 1 or generator 2, respectively.



Press *Waveform* from the bottom menu.

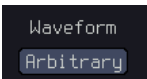

Select *Arbitrary* from the side menu.

2. Press *Waveform Edit* from the bottom menu.

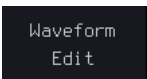

3. From the bottom menu select *Load Waveform*.

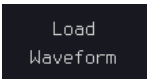

4. To load a file from one of the internal memory slots, press *From* to choose the ARB waveform to load the current waveform in channel or Ref ~ Ref4.

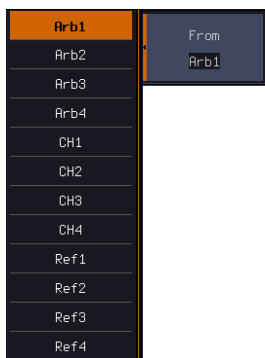

ARB: Arb1, Arb2, Arb3, Arb4, CH1~CH4,  
Ref1~Ref4

5. To load a file from an external USB or from the internal flash memory, press *From File*.

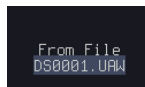

The last file that was saved to USB or the internal flash memory will be displayed in the icon.

6. To recall the displayed file, press *Recall Now*.

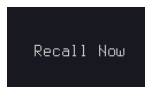

7. Alternatively, press *File Utilities*.

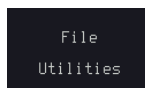

Use the *VARIABLE* knob to select the desired ARB waveform.

Press the *Select* key to load the selected ARB waveform in the file utilities screen.

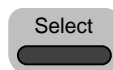

Note

Press *File Utilities* to manage the files on the internal disk or an inserted USB disk. See page 365 for details.

## Save ARB Waveform

**Background** ARB waveforms can be saved to internal memory or to an external USB storage.

- Panel Operation** 1. Select a waveform from the GEN1 Setup/GEN2 Setup menu:

Press *GEN1 Setup* or *GEN2 Setup* for generator 1 or generator 2, respectively.



Press *Waveform* from the bottom menu.

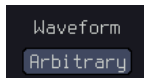

Select *Arbitrary* from the side menu.

2. Press *Waveform Edit* from the bottom menu.

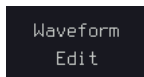

3. From the bottom menu select *Save Waveform*.

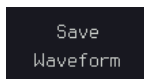

4. To save to one of the internal memory slots, press *To* to choose the ARB waveform to save:

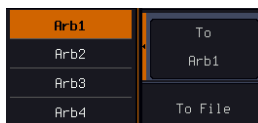



---

ARB: Arb1, Arb2, Arb3, Arb4

---

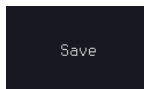
Press *Save* to save the waveform to the selected memory slot, Arb1, Arb2, Arb3 or Arb4.



5. Alternatively, to save to a USB drive or to the internal flash memory, press *To File*.

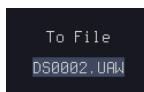

6. To save the selected file, press *Save* waveform.



7. You will automatically be taken to a file utility where you will be able to edit the name of the file.

8. To edit the file name, use the *VARIABLE* knob to highlight a character.



Press *Enter Character* or the *Select* key to select a number or letter.

Enter  
Character

Press *Back Space* to delete a character.

Backspace

9. Press *Save Now* to save the file.

Save Now



Note

Pressing *Cancel* will cancel the save operation and return you to the *Save Waveform* menu.

Cancel

After *Save Now* has been pressed the file will be saved.

Waveform saved to Disk:/DS0003.UAW.



Note

The file will not be saved if the power is turned off or the USB drive is taken out before the message ends.

## File Utility

Alternatively, to edit the internal memory or the USB flash drive contents (create/ delete/ rename files and folders) or to edit the default file path, press *File Utilities* from the side menu. See the user manual for details

File  
Utilities

## Coupling and tracking waveforms settings

### Background

GEN1 and GEN2 waveforms can be coupled in terms of frequency and/or amplitude. Similarly, waveform settings can also be tracked and be duplicated from one waveform to the other.

### Panel Operation

1. From the bottom menu of the AWG menu:

Press *UTIL* to enter the Utility menu.

UTIL

You can press on the *Preset* button from the side menu to reset both wave generators to a 0V DC waveform.



2. Press *Dual Chan* from the side menu to enter the coupling and tracking menus.

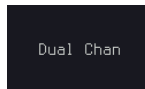

Tracking settings

3. From the side menu press *Tracking* to set the tracking mode to ON or OFF.



Tracking      ON, OFF

When Tracking is ON, all parameters set to one waveform will be copied to the other one and vice-versa.



Note

Tracking mode cannot be used together with the Frequency or Amplitude Coupling. Setting the Tracking mode to ON will disable any Coupling settings.

Frequency coupling

4. From the side menu press *Freq Couple*

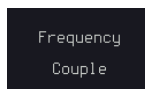

5. Press *Freq Couple Type* to set the type of frequency coupling.

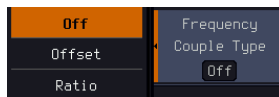

Freq Cpl Type      OFF, Offset, Ratio

Frequency from both generated waveforms can be coupled with a fixed offset or with a constant ratio.

6. Select *Offset* from the *Freq Couple Type* menu and press *Offset* on the side menu to configure the offset of the frequency coupling.



7. Use the Left and Right arrow keys to select a base unit and use the *VARIABLE* knob to increase or decrease the offset by that base unit, as shown in the Offset window. Use the *VARIABLE* knob or numerical keypad to input value.

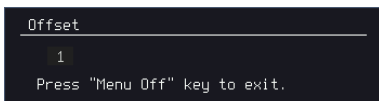

8. Default can be pressed to set the Offset to 0.0Hz.

9. Press Go Back to leave the menu.

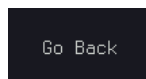

10. Select *Ratio* from the *Freq Couple Type* menu and press *Ratio* on the side menu to configure the ratio of the frequency coupling.



11. User the *VARIABLE* knob or numerical keypad to input value.

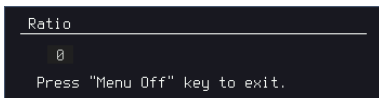

12. Default can be pressed to set the Ratio to 1.000.

13. Press *Go Back* to leave the menu.

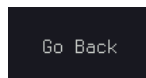

14. Press again *Go Back* to leave the menu Frequency Coupling menu.

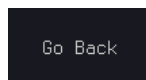



Note

Frequency Coupling cannot be set if Tracking is ON. Configuring Frequency Coupling parameters will disable the Tracking mode.

Amplitude coupling

15. Press *Amplitude Couple* to set the amplitude coupling to ON or OFF.



Amplitude Couple OFF, ON

When set to ON, amplitude from both generated waveforms will be duplicated from one to the other one.



Note

Amplitude Coupling cannot be set if Tracking is ON. Configuring Amplitude Coupling will disable the Tracking mode.

Reset the phase

16. You can also reset the phase to 0° between the two waveforms by pressing *S\_Phase*.

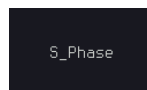



# P

# POWER ANALYSIS

## (OPTIONAL)

---

Power Analysis Overview .....	229
Set the Deskew .....	229
Power Quality .....	231
Power Quality parameter overview .....	231
Using Power Quality Measurements .....	232
Switching Loss .....	235
Using Switching loss Measurements .....	235
Harmonics .....	240
Harmonics parameter overview .....	240
Define Harmonic Inputs .....	241
Choosing a Harmonic Standard Test .....	242
Harmonics Setup – Default (None) .....	243
Harmonics Setup – IEC .....	244
Harmonics Display options .....	246
Save Harmonic Measurements .....	248
Ripple .....	250
Using Ripple Measurements .....	250
Inrush .....	252
Using Inrush Current Measurements .....	252
Modulation .....	254
Using Modulation Measurements .....	254
Safe Operation Area .....	258
Using Safe Operation Area Measurements .....	258
Transient .....	262
Using Transient Measurements .....	262
Efficiency .....	265
Using Efficiency Measurements .....	265
B-H curve .....	268
Using B-H curve Measurements .....	268



<b>Control Loop Response</b> .....	<b>272</b>
Using Control Loop Response Measurements .....	272
Source .....	274
Setup amplitude profile.....	274
Setup AWG.....	276
Quit.....	278
Analysis mode .....	278
Measure.....	278
Bode Plot.....	279
Overlay .....	281
File Utilities .....	282
<b>Power Supply Rejection Ratio (PSRR)</b> .....	<b>284</b>
Using PSRR Measurements .....	284
Source .....	287
Setup amplitude profile.....	287
Setup AWG.....	287
Quit.....	287
Analysis mode .....	287
Measure.....	287
Bode Plot.....	287
Overlay .....	287
File Utilities .....	287
<b>Turn On/Off</b> .....	<b>288</b>
Using Turn On/Off Measurements.....	288

## Power Analysis Overview

Power analysis provides automatic measurement for a number of advanced measurement types which allows user to acquire, measure, and analyze various switching power supply signals at multiple test points. This optional power analysis tool provides simple and direct way to obtain results about switching devices, magnetic components, and compliance tests to EN 61000-3-2 standard for Switch mode Power supply.

### Set the Deskew

The deskew function is used to compensate for the propagation delay between the oscilloscope and the probe. For power measurements this is especially important as voltage and current probes are often used in measurements and have differing propagation delays.

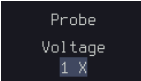
Background	The deskew function allows the time delay between voltage and current probes to be equalized.
Panel operation	<ol style="list-style-type: none"> <li data-bbox="386 861 982 965">1. If there is necessary, configure a channel as a voltage probe and another channel as a current probe.</li> <li data-bbox="386 997 982 1101">2. Press one of the <i>Channel</i> keys that was set as the voltage or current probe. </li> <li data-bbox="386 1141 982 1212">3. Press the <i>More</i> key from the bottom menu. </li> <li data-bbox="386 1244 982 1324">4. Press the <i>Probe</i> key from the right menu. </li> </ol>

5. Press *Deskew* on the side menu and use the *VARIABLE* knob to set the deskew time.

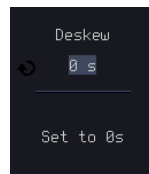

Alternatively, press *Set to 0s* to reset the deskew time. Typically, both channels should line up with a common edge.

---

Range	-50ns~50ns, 10ps increments
-------	-----------------------------

---

6. If necessary, repeat the procedure for the other channel.

## Power Quality

### Power Quality parameter overview

All the following parameters are used for power quality measurements.

Measurement	Measurement Group			
	Normal	Inrush	Ballast	Turn On
V RMS	✓	✓	✓	✓
I RMS	✓		✓	✓
True Power	✓		✓	✓
Apparent Power	✓		✓	✓
Reactive Power	✓		✓	✓
Frequency	✓	✓	✓	✓
Power Factor	✓		✓	✓
Phase Angle	✓			✓
V Crest Factor	✓		✓	✓
I Crest Factor	✓		✓	✓
(+)V Peak		✓	✓	✓
(-)V Peak		✓	✓	✓
(+)I Peak		✓	✓	✓
(-)I Peak		✓	✓	✓
DC Voltage			✓	✓
DC Current			✓	✓
Impedance				✓
Resistance				✓
Reactance				✓

## Using Power Quality Measurements

**Background** For typical power measurements, one channel is used to measure voltage using a differential probe and the other channel is used to measure current using a current probe.

In the example below, the power quality of an AC power source is tested.



**WARNING**

Ensure safe working practices are adhered to when working with live voltages. Failure to do so could lead to electric shock or loss of life.

- Setup**
1. Deskew the current and voltage probes.
  2. Connect the differential probe and current probe to an input channel.
  3. Connect to the power cord and turn on the power switch when all the connections have been made and configured.

- Panel operation**
1. Press the *Power analysis* key on the front panel.

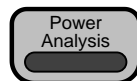

2. Use the *VARIABLE* knob to select the *Power Quality* function from the screen.

VARIABLE

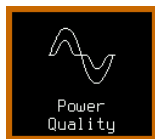
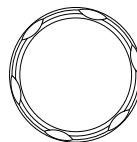

3. The measurements for power quality appear.

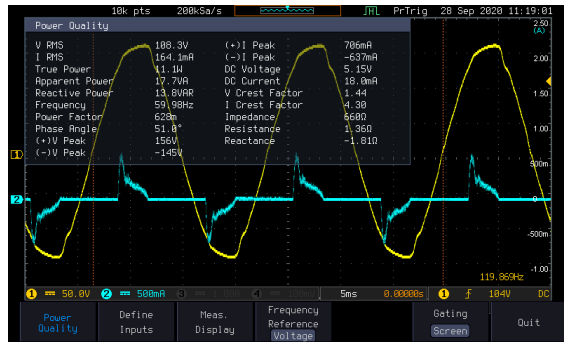

Define Inputs

1. Press *Define Inputs* from the lower menu.
2. Choose the *Voltage* input (differential voltage source) from the side menu.
3. Choose the *Current* input (current probe source) from the side menu.
4. Press *Meas. Display*.

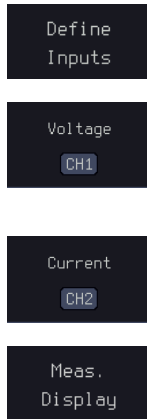

5. Choose what type of automatic measurements should be displayed from the side menu.

- Range
- Turn Off All Meas.
  - Normal
  - Inrush
  - Ballast
  - Turn On

6. Press *Frequency Reference* from the bottom menu.
7. Choose *Voltage* or *Current* as the frequency reference.

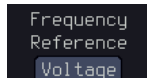

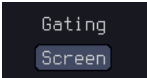
	Range	Voltage, Current
Gating	To set the measurement area press <i>Gating</i> from the bottom menu and select the <i>Gating</i> mode from the side menu. See the user manual for more details.	
	Gating	Off (Full Record), Screen, Between Cursors



# Switching Loss

## Using Switching loss Measurements

---

**Background** As the need to improve power efficiency and extend the operating time of battery powered devices increases, the ability to analyze power loss and optimize the efficiency of power supplies will become even more important. The switching loss analysis calculates the power dissipation arising in a switching device.

---



### WARNING

Ensure safe working practices are adhered to when working with live voltages. Failure to do so could lead to electric shock or loss of life.

---

**Setup**

1. Connect the positive terminal of the differential probe to the Drain(D) of the FET circuit, the negative terminal to the Source (S), and the current probe is connecting to the Source (S).
2. Connect to the power cord and turn on the power switch when all the connections have been made and configured.

---

**Panel operation** 1. Press the *Power analysis* key on the front panel.

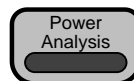

2. Use the *VARIABLE* knob to select *Switching Loss* function on the screen

VARIABLE

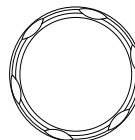

3. The switching loss measurement is shown on the screen.



**Define Inputs**

1. Press *Define Inputs* key from the lower menu.
2. Choose the *Voltage* input (source) from the side menu.
3. Choose the *Current* input (source) from the side menu.
4. When a so-called “Enhance mode” is enabled, it is possible to define another voltage input source with an enhanced vertical resolution as compared to the original voltage input. Usually, the enhanced channel is also differentially probing on the same test point as is the original voltage channel pointing to but with a smaller scale.

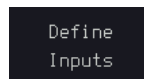

For instance, while the original voltage input CH1 uses a scale of 100V, an enhanced channel, say CH3, may adopt a finer scale such

as 50V or 20V. In that way, the so-called enhanced channel can improve the digital representation of a near-zero volt state during the conduction period, which in turn will result in a more accurate conduction loss measurement.

---

Range CH1~4 (valid options are those other than the voltage and current inputs)

---

Reference Levels

1. Press *Reference Levels* key from the lower menu for the High/ Middle/ Low of switching edges.



The value is in percentage of the maximum switch voltage/current. User can adjust this value to ignore noise floors or null offset that is difficult to eliminate in current probes. The reference level specifies the threshold that is used to determine the switching edges.

---

Range 0~100%

---

2. Use the *VARIABLE* knob or numerical keypad to input value.

VARIABLE

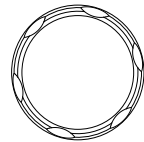

or

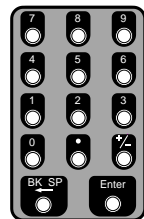

**Conduction Calculation**

1. Press the *Conduction Calculation* key from the lower menu to choose the algorithm of conduction calculation. It can be voltage waveform(V Wfm), RDS(on), or VCE(sat).

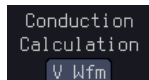

2. When voltage waveform is selected, the conduction simply uses Power = V x I formula.

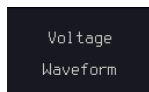

3. Press the *Enhance Mode* key to toggle the state of the Enhance Mode.

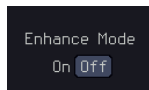

4. For RDS(on), Power = I<sup>2</sup> x RDS(on).



5. Press the *RDS(on)* key and the additional softkey to specify Rds(on).





---

Range 0 ~ 100 Ω

---

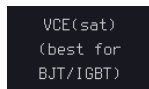
6. Power = VCE(sat) x I when VCE(sat) is set.



7. Press the *VCE(sat)* key and the additional softkey to specify VCE(sat).





---

Range 0~100V

---

**Meas. Display**

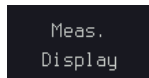
The voltage and current waveforms are displayed, as well as the power waveform (waveform MATH multiply of the voltage and current). Also displayed are these automatic power measurements and statistics



1. Press the *All* key to display all measurement items including Power Loss, Energy Loss, RDS(on) and VCE(sat).

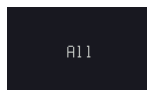

2. Press the *Power loss* key to display only Power Loss.

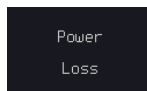

3. Press the *Energy loss* key to display only Energy Loss.

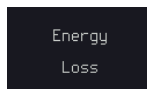

4. Press the *Position* key and then use the VARIABLE knob to adjust MATH waveform trace position.



VARIABLE

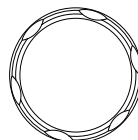

5. Press the *Unit/div* Key and then use the VARIABLE knob to adjust vertical scale of MATH waveform trace.



VARIABLE

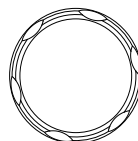

**Gating**

To set the measurement area, press *Gating* key from the bottom menu and select the gating mode from the side menu.

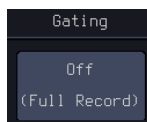

Gating      Off (Full Record), Screen, Between Cursors

# Harmonics

## Harmonics parameter overview

All the following parameters are used for harmonic measurements.

Measurement	None	IEC 61000-3-2 *
Frequency (Hz)	✓	✓ All classes
Magnitude (%)	✓	✓ All classes
Mag. RMS (A)	✓	✓ All classes
Phase (°)	✓	
Limit (A)		✓ A, B C.1, C.3,D
Limit (%)		✓ C.2
Pass   Fail		✓ All classes
Max all Windows (A)		✓ All classes
200% Limit		✓ All classes
POHC Limit		✓ All classes
THD-F	✓	✓ All classes
THD-R	✓	
RMS	✓	✓ All classes
Overall		✓ All classes
POHC		✓ All classes
POHL		✓ All classes
Input Power		✓ C.3, D
Power Factor		✓ C.1, C.2, C.3
Fundamental Current		✓ C.1, C.2, C.3
DF**		✓ C.3

\*A, B, C.1, C.2, C.3, D are Class A, Class B, Class C (Table 1), Class C (Table2), Class C (Table 3), Class D

\*\*DF (displacement factor) is one of the important factor for LED lights measurement.

## Define Harmonic Inputs

---

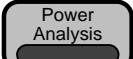
Background	Current and voltage inputs must be defined for harmonic measurements.
Background	<p>For harmonic measurements, one channel is used to measure voltage using a differential probe and the other channel is used to measure current using a current probe.</p> <p>In the example below, the harmonic content of an AC power source is tested.</p>
 WARNING	Ensure safe working practices are adhered to when working with live voltages. Failure to do so could lead to electric shock or loss of life.
Setup	<ol style="list-style-type: none"> <li>1. Deskew the current and voltage probes.</li> <li>2. Connect the differential probe and current probe to an input.</li> <li>3. Connect to the power cord and turn on the power switch when all the connections have been made and configured.</li> </ol>
Panel operation	<ol style="list-style-type: none"> <li>1. Press the <i>Power analysis</i> key on the front panel.</li> </ol> 

- Use the *VARIABLE* knob to select *Harmonics* function from the screen.

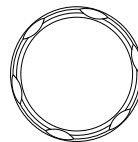
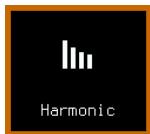

- The measurements for harmonics appear



**Define Inputs**

- Press *Define Inputs* from the lower menu.
- Choose the *Voltage* input (source) from the side menu.
- Choose the *Current* input (source) from the side menu.

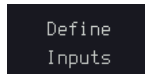

**Choosing a Harmonic Standard Test**

**Panel operation**

- Press the *Power analysis* key on the front panel.

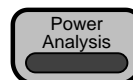



2. Use the *VARIABLE* knob to select *Harmonics* function from the screen.

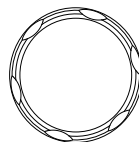
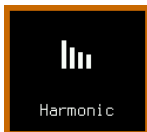

3. Press *Test to Standard* key from the lower menu.

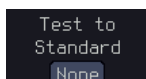

4. Choose a desired Test Standard from the side menu.



Standard    None, IEC 61000-3-2

## Harmonics Setup – Default (None)

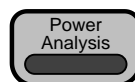

**Background**      It provides self-defined parameters for use in the frequency range of 10Hz to 400Hz and 20~400 number of harmonics.

- Panel operation**    1. Press the *Power analysis* key on the front panel.



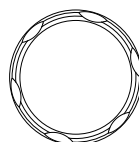
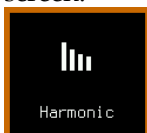

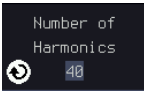
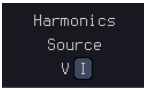
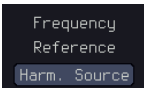
2. Use the *VARIABLE* knob to select *Harmonics* function from the screen.



- |  |   |
|--|---|
| 3. Press <i>Setup</i> key from the lower menu.   |  |
| 4. Set the <i>Number of Harmonics</i> from the side menu.                                |  |
| Range      20~400  |   |
| 5. Choose the <i>Harmonics Source</i> .  |  |
| Source      V, I   |   |
| 6. Set the <i>Frequency Reference</i> .  |  |
| Reference    V, I, Harmonics source, Fixed   |   |
| 7. If Fixed is set as the frequency reference, set the <i>Fixed Reference</i> frequency. |  |
| Reference    10Hz~400Hz  |   |

## Harmonics Setup – IEC

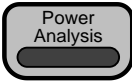
**Background**      The following Setup menu is only applicable when IEC is chosen as the testing standard. See page 242 for details.

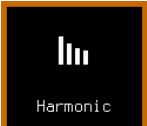
- |                 |  |   |
|-----------------|--|---|
| Panel operation | 1. Press the <i>Power analysis</i> key on the front panel.                           |              |
|                 | 2. Use the <i>VARIABLE</i> knob to select <i>Harmonics</i> function from the screen. | VARIABLE<br> |
|                 |   |   |

3. Press *Test to Standard* key from the lower menu. Select *IEC 61000-3-2* from side menu.

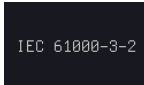

4. Press *Setup* from the lower menu.



5. Press the *Line Frequency* key from the side menu.



Range      50, 60 Hz

6. Choose the *Observation Period*.

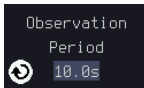

Time      200ms~ 150 seconds

**Default Settings**

Press *Set to IEC Defaults* key to set to IEC default settings.

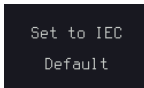

Default      Observation Period. 10s  
Grouping. On  
Filter. On

**Device Class**

Four device classes can be chosen for the IEC standard.

1. Press *More* from the Setup side menu.



2. Choose a *Device Class* from the side menu.



Class      A, B, C(Table 1), C(Table 2),  
C(Table3), D

3. For class C devices, choose the *Power Factor* and *Current*.

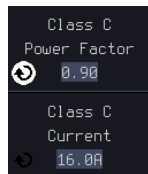

Pow. Fact. 0.00~1.00

Current 100mA~16.0A

4. For class C(Table 3) and Class D devices, choose the *Input Power*.



Power 0~600 W, 10Watt increments

**Filter, Grouping and Hysteresis**

The filter function applies a 1.5 second smoothing filter function. The Grouping function groups inter-harmonic measurements.

1. Press *more* twice from the side menu.

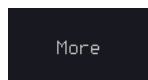

2. Press *Filter* to toggle the filter time on or off for 1.5 seconds.

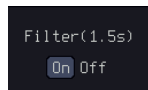

Filter On, Off

**Grouping**

3. Press *Grouping* to toggle grouping on or off.

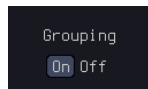

Grouping On, Off

**Harmonics Display options**

**Background**

Harmonic measurements can be displayed on-screen in graph or table format. When in graph format, a harmonic must be chosen for individual measurements.

Panel operation

1. Press the *Power analysis* key on the front panel.

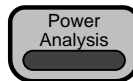

2. Use the *VARIABLE* knob to select *Harmonics* function from the screen.

VARIABLE

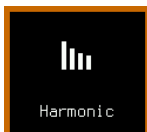
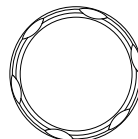

3. Press *Display* from the lower menu

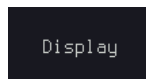

4. Choose to display harmonic measurements as a graph or as a table.

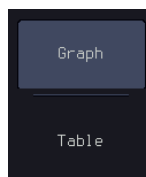

---

Range      Table, Graph

---

5. Toggle between viewing *All*, *Odd* or *Even* harmonics.



---

Harmonic    All, Odd, Even

---

6. Press *Select* and use the *VARIABLE* knob to choose a harmonic measurement to view or to navigate the harmonic list.







---

Select      1~number of measurement results

---

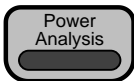
## Save Harmonic Measurements

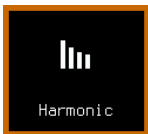
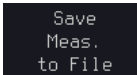
**Background** All harmonic measurements can be saved internally or to USB. The files are stored as .CSV.

- Panel operation**
1. Press the *Power analysis* key on the front panel. 
  2. Use the *VARIABLE* knob to select *Harmonics* function from the screen. 
  

  3. Press *Save Meas. To File* from the lower menu. 

**File Type** Each measurement that is saved is saved as HarmXXXX.CSV into the designated USB file path. Each file is numbered sequentially from 0000 to 9999. For example the first file will be saved as Harm0000.CSV, the second as Harm0001.CSV, and so on.

**Data** The data that is saved depends on whether *Test to Standard* is set to *None* or to *IEC 61000-2-3*. Please page 240 for details.

**Example** Below shows an example of the harmonic data that is saved.

GW GDS-3354A, serial number P930116, version V1.05

Harmonics				
THD-F	113%			
THD-R	75.10%			
RMS	353mA			
	Freq	Mag	Mag RMS	Phase
	Hz	%	A	Degrees
1	60.07	100	217m	0
2	120.1	29.4	640μ	-135
3	180.2	62.1	135m	31.4
4	240.2	24.1	524μ	-135
5	300.3	47.2	102m	29
6	360.4	53.4	1.16m	79.1
7	420.5	44.8	97.5m	10.3
8	480.5	1.27	2.77m	2.35

# Ripple

## Using Ripple Measurements

**Background**      The ripple function allows power supply ripple to be measured with ease. The function allows automatic vertical scaling to maximize the vertical resolution of the measurement by isolating the AC component from the DC waveform.



**WARNING**

Ensure safe working practices are adhered to when working with live voltages. Failure to do so could lead to electric shock or loss of life.

- Setup**
1. With the power disconnected from the power source, connect the differential voltage or current probe to the positive and negative output terminals.
  2. Connect the differential or current probe to an output.
  3. Connect to the power cord and turn on the power switch when all the connections have been made and configured.

- Panel operation**
1. Press the *Power analysis* key on the front panel.

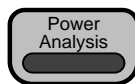

2. Use the *VARIABLE* knob to select *Ripple* function from the screen.

VARIABLE

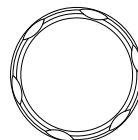

3. The measurements for ripple appear.





## Define Inputs

1. Press *Define Inputs* from the lower menu.
2. Choose the *Voltage* input (source) from the side menu.
3. Choose the *Current* input (source) from the side menu.
4. Press *Source* from the bottom menu to toggle the ripple source type.

Define  
Inputs

Voltage

CH1

Current

CH2

Source

V I

Source V, I

5. To automatically set the vertical scale, press *Do Vertical Autoset*. This will offset the DC component to maximize the accuracy of the ripple measurement.

Do  
Vertical  
Autoset

## Gating

To set the measurement area, press *Gating* key from the bottom menu and select the gating mode from the side menu.

Gating  
Screen

Gating Off (Full Record), Screen, Between  
Cursors

# Inrush

## Using Inrush Current Measurements

**Background** The GDS-3000A is able to quickly measure the inrush current generated when a power supply is first turned on. The Inrush function can measure the first and second peak.



**WARNING**

Ensure safe working practices are adhered to when working with live voltages. Failure to do so could lead to electric shock or loss of life.

**Setup**

1. With the power disconnected from the power source, connect the current probe to Line wire.
2. Connect the current probe to an input.
3. Connect to the power cord and turn on the power switch when all the connections have been made and configured.

**Panel operation** 1. Press the *Power analysis* key on the front panel.

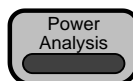

2. Use the *VARIABLE* knob to select *Inrush Current* function from the screen.

VARIABLE

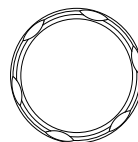

3. The measurements for inrush current appear measuring the first and second inrush current peaks.

Example

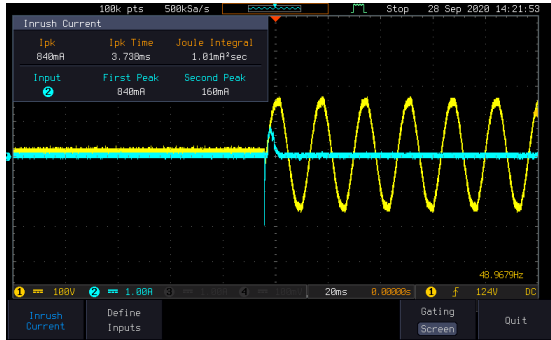

4. Press *Define Inputs* from the lower menu.
5. Choose the *Current* input (source) from the side menu.

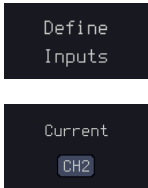

 Note

To effectively measure inrush current, use the oscilloscope in Single mode to capture the inrush current when it occurs.

A voltage source cannot be selected for inrush current.

# Modulation

## Using Modulation Measurements

**Background**      The Modulation analysis measures the control pulse signal to a switching device (MOSFET) and observes the trending of the pulse width, duty cycle, period, frequency, etc. of the control pulse signal in response to different events.



**WARNING**

Ensure safe working practices are adhered to when working with live voltages. Failure to do so could lead to electric shock or loss of life.

- Setup**
1. Connect the differential probe the Source (S) and Gate (G) of the FET circuit, and the current probe is connecting to the Drain (D).
  2. Connect to the power cord and turn on the power switch when all the connections have been made and configured.

- Panel operation**
1. Press the *Power analysis* key on the front panel.
  2. Use the *VARIABLE* knob to select *Modulation* function from the screen.

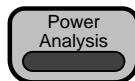

VARIABLE

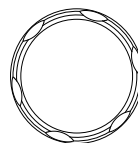

3. The measurements for modulation is appeared.



Define inputs

1. Press *Define Inputs* from the lower menu.
2. Choose the *Voltage* input (source) from the side menu.
3. Choose the *Current* input (source) from the side menu.
4. Press *Source* from the bottom menu to toggle the ripple source type.

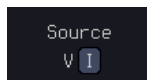
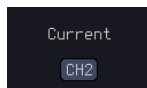
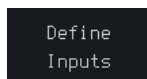

Source      V, I

Modulation Type

1. Press the *Modulation Type* key and then turn the *VARIABLE* knob to select the type of measurement to make in the modulation analysis

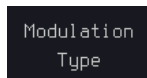

Type      +Width, -Width, Period, Frequency, +Duty, -Duty

2. Press *Position* key and then use the *VARIABLE* knob to adjust position of MATH waveform trace.

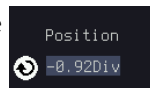

VARIABLE

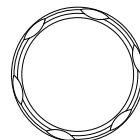

Range  $\pm 12\text{Div}$

3. Press *Unit/div* key and then use the *VARIABLE* knob to, depending on different Modulation Type options, adjust value of target unit of MATH waveform trace.



VARIABLE

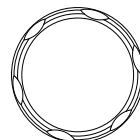

**Reference Levels** Press *Reference Level* key from the lower menu for the High/ Middle/ Low of switching edges. The value is in percentage of the maximum switch voltage/current. User can adjust this value to ignore noise floors or null offset that is difficult to eliminate in current probes. This prevents value specifies the threshold that is used to determine the switching edges.

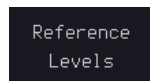

Range 0~100%

1. Use the *VARIABLE* knob or numerical keypad to input value.

VARIABLE

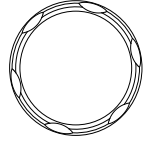

or

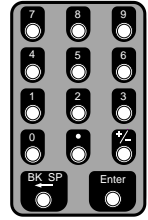

2. Press *Set to default* key to set value at 50%.

Set to  
Default

# Safe Operation Area

## Using Safe Operation Area Measurements

**Background**      The safe operating area (SOA) of the switching transistor in a switch-mode power supply defines the current that can run through the transistor at a given voltage.



**WARNING**

Ensure safe working practices are adhered to when working with live voltages. Failure to do so could lead to electric shock or loss of life.

- Setup**
1. Connect the positive terminal of the differential probe to the Drain(D) of the FET circuit, the negative terminal to the Source (S) which fixed connection on CH1 or CH3, and the current probe is connecting to the Source (S) which fixed connection on CH2 or CH4 .
  2. Connect to the power cord and turn on the power switch when all the connections have been made and configured.

- Panel operation**
1. Press the *Power analysis* key on the front panel.

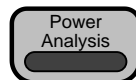

2. Use the *VARIABLE* knob to select the desired measurement as below and then press "Select" key to launch it.

VARIABLE

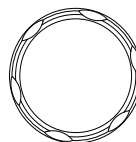

3. The measurements for SOA appear.



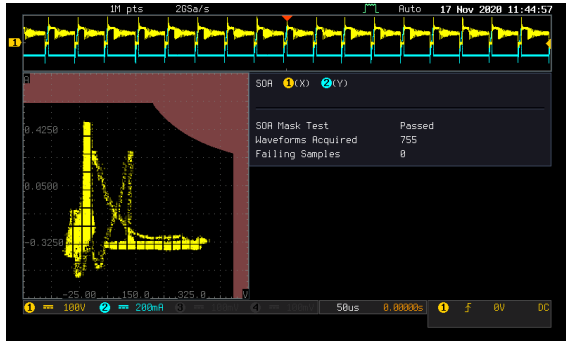

Define inputs

1. Press *Define Inputs* from the lower menu.
2. Select the SOA input pair. (A four-channel model example)

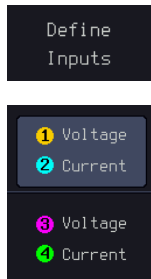

The automated SOA analysis allows switch voltage, switch current and corresponding power to be simultaneously and automatically monitored as operating conditions vary.

Define Axes

1. Press *Define Axes* key from the lower menu.
2. Press *Log/Linear* key to select Log or Linear scale display method.

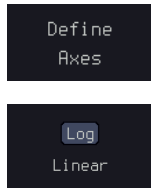

3. Press the side bar menu in right side to set Y Axis Max/Min, X Axis Max/Min.

SOA Axes define the maximum and minimum value for both voltage(X-Axis) and current(Y-Axis) based on the specification of the underlying power transistor.

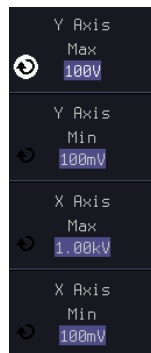

**Define Mask**

1. Press *Define Mask* key from the lower menu.
2. Press *Set Limits* key. The function of “Set Limits” defines a mask based on the maximum voltage, maximum current, and power limits according to the data sheet of the underlying power transistor.
3. Alternatively, press *Set Points* key. The function of “Set Points” allows user to construct a mask in a point-by-point manner. (up to 10 points are available).
4. Use the *VARIABLE* knob or numerical keypad to edit the coordinate (X,Y) of the selected point.
5. Press *Insert Point* key to adding a new point in front of the selected point.

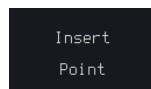
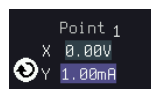
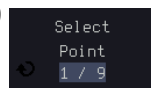
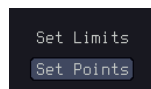
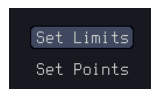
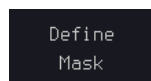

6. Press *Delete Point* key to delete the currently set Point.

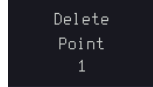

Action on Violation

1. Press *Action On Violation* key from the lower menu.

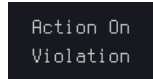

2. Press *Stop* key (on/off) to determine the action to be taken (stopping or not) if the power transistor fails in the SOA test.



Gating

To set the measurement area, press *Gating* key from the bottom menu and select the gating mode from the side menu.



Gating      Off (Full Record), Screen, Between Cursors

# Transient

## Using Transient Measurements

**Background**      The Transient analysis measures the time for the output DC voltage to settle within a user-set percentage of the expected output level after a sudden change in output load (increase or decrease in output current).



**WARNING**

Ensure safe working practices are adhered to when working with live voltages. Failure to do so could lead to electric shock or loss of life.

- Setup**
1. With the power disconnected from the power source, connect the differential voltage probe to the positive and negative output terminals.
  2. Connect the passive probe (or differential probe) to the OUTPUT terminal of the circuit and the current probe to the OUTPUT terminal
  3. Connect to the power cord and turn on the power switch when all the connections have been made and configured.

- Panel operation**
1. Press the *Power analysis* key on the front panel.

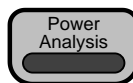

2. Use the *VARIABLE* knob to select *Transient* function from the screen.

VARIABLE

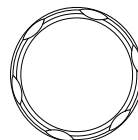

3. The measurements for transient appear.

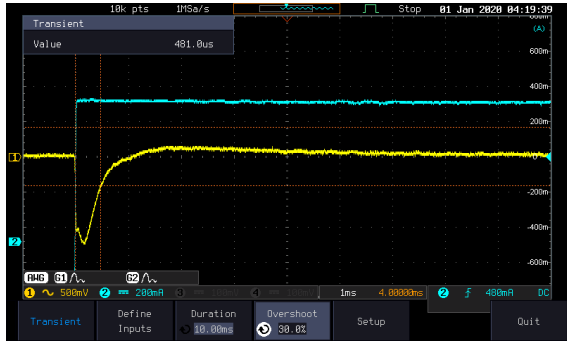

Define inputs

1. Press *Define Inputs* from the lower menu.
2. Choose the Voltage input (source) from the side menu.
3. Choose the Current input (source) from the side menu.

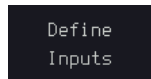

Duration

1. Press the *Duration* key and then use the *VARIABLE* knob or numerical keypad to input duration value.

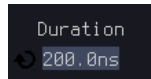

Range 10ns~10000s

Overshoot

1. Press the *Overshoot* key and then use the *VARIABLE* knob or numerical keypad to input overshoot value.

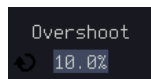

Range 0.1%~100%

Setup

1. Press *Setup* key from the lower menu.



2. Press the *Steady Vout* key and then use the *VARIABLE* knob or numerical keypad to set steady output voltage value.



3. Press the *Low Current* key and then use the *VARIABLE* knob or numerical keypad to set low current value.



4. Press the *High Current* key and then use the *VARIABLE* knob or numerical keypad to set high current value.

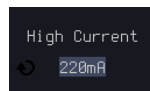

## Efficiency

### Using Efficiency Measurements

**Background** Efficiency measurement is measuring the input real power and output power in order to compute the efficiency of the power supply (Efficiency =  $\text{Power}(\text{out})/\text{Power}(\text{in}) \times 100$ ).



#### WARNING

Ensure safe working practices are adhered to when working with live voltages. Failure to do so could lead to electric shock or loss of life.

**Setup**

1. This function requires a 4-channel GDS-3000A oscilloscope to measure the input/output voltage and output current (2 channels GDS-3000A series need to measure twice and calculate the percentage).

When testing, connect the differential probe to the output/input of the circuit and the current probe to the output/input of the circuit, and set the corresponding voltage/current settings on the oscilloscope.

2. Connect to the power cord and turn on the power switch when all the connections have been made and configured.

**Panel operation**

1. Press the *Power analysis* key on the front panel.

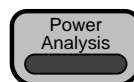

2. Use the *VARIABLE* knob to select *Efficiency* function from the screen.

VARIABLE

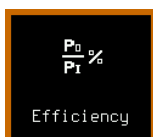

3. The measurements for efficiency appear.

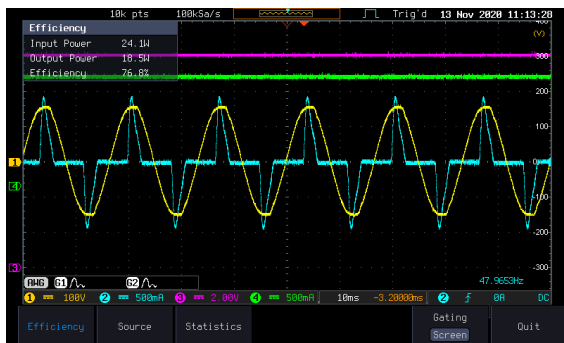

Source

1. Press *Source* key from the lower menu.



2. Choose the Voltage input channel from the side menu.



Range CH1~4

3. Choose the Current input channel from the side menu.

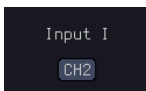

Range CH1~4

4. Choose the Voltage output channel from the side menu.



Range CH1~4

5. Choose the Current output channel from the side menu.

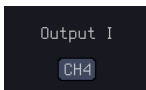

Range CH1~4

Statistics

1. Press *Statistics* key from the lower menu.

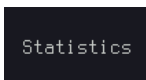



2. Press *Statistics* (on/off) key to turn on or off Statistics.



3. Press the *Mean & Std Dev Samples* key and then use the *VARIABLE* knob or numerical keypad to set value of Mean and standard deviation of the sample.

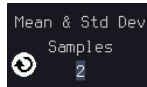



---

Range      2~1000

---

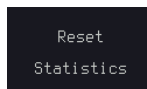
4. Press the *Reset Statistics* key to reset the value of Statistics.



### Gating

To set the measurement area, press Gating key from the bottom menu and select the gating mode from the side menu.

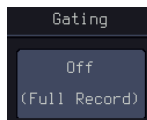

---

Gating      Off (Full Record), Screen, Between Cursors

---

## B-H curve

### Using B-H curve Measurements

**Background** B-H curve measurements are often used to verify the saturation (or lack thereof) of the magnetic elements in a switching supply and provide a measure of the energy lost per cycle in a unit volume of core material.



#### WARNING

Ensure safe working practices are adhered to when working with live voltages. Failure to do so could lead to electric shock or loss of life.

#### Setup

1. Connect the CH1/2 probes (or CH3/CH4) to the transformer's N1, N2 side of the circuit
2. Connect to the power cord and turn on the power switch when all the connections have been made and configured.

#### Panel operation

1. Press the *Power analysis* key on the front panel.

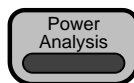

2. Use the *VARIABLE* knob to select *B-H curve* function from the screen.

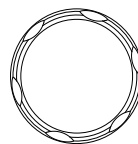
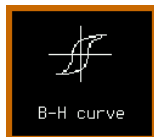

3. The measurements for B-H curve appear.

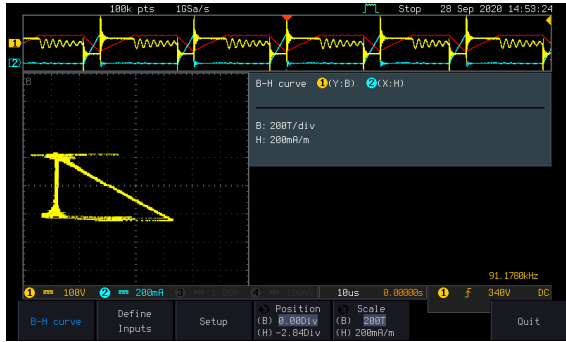

Define inputs

1. Press *Define Inputs* key from the lower menu.

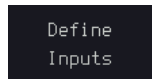

The voltage across a waveform which acquired with a differential voltage probe, is set as the voltage source. The current through the device is captured with a current probe. The hysteresis plot is presented as the integrated voltage across the magnetic device versus the current through the device.

2. 2CH model is available for one input setting.  
4CH model is available for two input settings  
Fixed CH1 or CH3 is Voltage input.  
CH2 or CH4 is Current input.



Setup

1. Press *Setup* key from the lower menu.



- Press the *Windings* key and then use the *VARIABLE* knob or numerical keypad to set value of windings magnetic element.

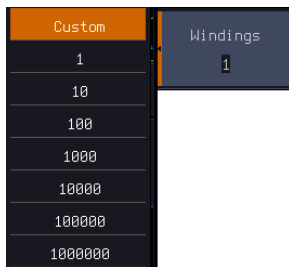

Range 1~1000000

- Press the *Cross Section Area(mm<sup>2</sup>)* key and then use the *VARIABLE* knob or numerical keypad to set value of Cross Section Area.

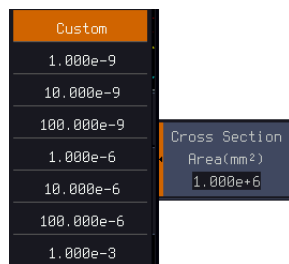

Range 1.000~1.000e+6

- Press the *Magnetic Length(m)* key and then use the *VARIABLE* knob or numerical keypad to set value of Magnetic Length.



Range 1.000~100.00

**Position**

- Press *Position* key from the lower menu. Use the *VARIABLE* knob or numerical keypad to adjust the position of (B) magnetic flux Density & (H) Magnetic Field Strength on the screen.

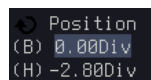

**VARIABLE**

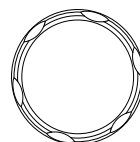

---

Range      +/- 12 divisions

---

Scale

1. Press *Scale* key from the lower menu. Use the *VARIABLE* knob or numerical keypad to adjust the scale of (B) magnetic flux Density & (H) Magnetic Field Strength.

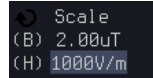

VARIABLE

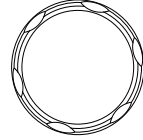

# Control Loop Response

## Using Control Loop Response Measurements

**Background** The Control Loop Response measurement performs a gain/phase plot over frequency sweep. This is used to determine the margin of a control loop.



**WARNING**

Ensure safe working practices are adhered to when working with live voltages. Failure to do so could lead to electric shock or loss of life.

**Setup**

1. Connect the probe of the corresponding channel to the INPUT/OUTPUT side of the DUT and connect the output of AWG to the Injection Transformer.
2. Connect to the power cord and turn on the power switch when all the connections have been made and configured.

**Panel operation**

1. Press the *Power analysis* key on the front panel.

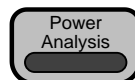

2. Use the *VARIABLE* knob to select *Control Loop Response* function from the screen.

VARIABLE

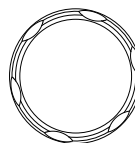

3. The measurements for Control Loop Response appear.

Example: an example with complete result of control loop response

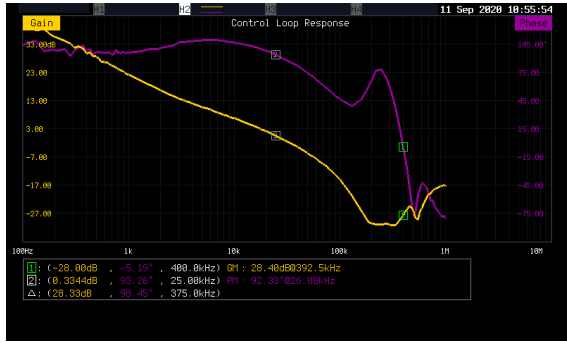



Note

Please be aware that the total time required for measuring the frequency response may vary according to your setup, e.g. the number of points per decade or when sweeping at lower frequencies.

Please note that the control loop response measurement only allows a DSO record length of 10,000 points.

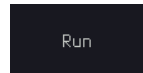
- In Setting mode (*Run* button appeared), press the *Run* button to start testing the control loop response.



- The data acquisition will stop automatically when the stop frequency is reached. The  button is then toggled back to STOP and the data is ready for analysis.



If the user needs to cancel an ongoing control loop response measurement, the  button can be pressed.

- Using the second *Analyze* menu button will switch to the Analysis mode. Details regarding this mode will be explained in later sections.

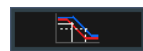

7. Press the icon to return to the upper-level menu.

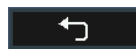

## Source

---

**Background** Use the Source menu to define the input source and output source.



**Note**

Please make sure that the two analog channels used by the control loop response measurement must be activated first.

- Panel operation**
1. Toggle the *Source* button.

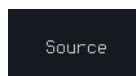

2. Press *Input Source* from the side menu and select the channel that is connected to the input of the DUT.

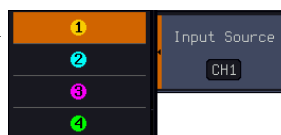

3. Press *Output Source* from the side menu and select the channel that is connected to the output of the DUT.

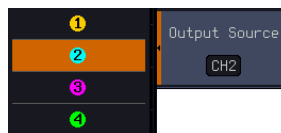

## Setup amplitude profile

---

**Background** The function of amplitude profile aims to customize the signal level across the test bands.

- Panel operation**
1. Press the *Setup* button.





- When amplitude profile is enabled, you can edit it. When amplitude profile is disabled, amplitude can be selected and changed only in the AWG Setup option.

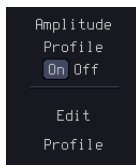

**Edit profile**

- Press *Edit Profile* from side menu. Amplitude profile is used to test at lower amplitudes at frequency where the DUT is sensitive, and test at higher amplitudes where it is less sensitive to distortion.

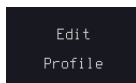

- Press *Select* from side menu and select the frequency band that needs a customized signal level.

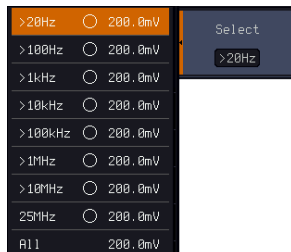

**Amplitude**

- Press *Amplitude* to configure the amplitude of the frequency band.



Use the *VARIABLE* knob or numerical keypad to input value.

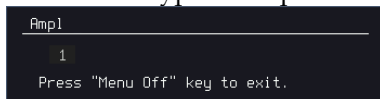

- Press *Go Back* to return to the previous menu.

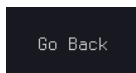

Range            0.01~2.5Vpp (50 ohms load)  
                     0.02~5Vpp (High-Z load)

**Linear Interpolation**

- Press *Linear Interpolation* to enable or disable generating linearly interpolated amplitudes between two neighboring band edges. With

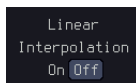

this option, one can construct a linear sweep rather than a staircase amplitude profile.

### Setup AWG

**Background** Use the Setup menu to configure the AWG output GEN1.

**Panel operation**

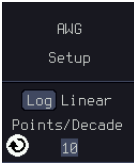
1. Press the *Setup* button. 
2. Set unit of the frequency axis: Logarithmic or Linear. For the logarithmic unit, each frequency decade is equally divided in a preset number of points. By pressing the *Points/Decade* button and using the *VARIABLE* knob, you will define the number of points per decade of frequency. 

**Example** For the 100-1000Hz decade and 15 points per decade, the frequency sweep step is given by  $(1000-100)/15 = 60\text{Hz}$ , i.e. measurements will be taken at 100Hz, 160Hz, 220Hz, 280Hz, ..., 940Hz.

**Range** 10, 15, 30, 45, 90 for logarithmic scale  
2~1000 for linear scale

3. Then press the *AWG Setup* button from the side menu to configure the frequency-swept input signal. 

**Start**

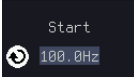
1. Press *Start* button to configure the start frequency. 

2. Use the *VARIABLE* knob or numerical keypad to input value.

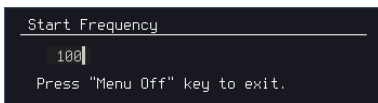

3. Press *Go Back* to return to the previous menu.

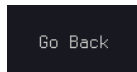

Range 20Hz ~ 25MHz

Stop

1. Press *Stop* to configure the stop frequency.

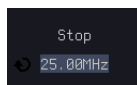

2. Use the *VARIABLE* knob or numerical keypad to input value.

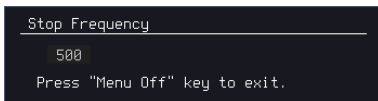

3. Press *Go Back* to return to the previous menu.

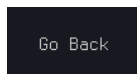

Range 20Hz ~ 25MHz

Load

1. Press *Load* button to configure the load resistance.
2. Press repeatedly the *Load* button to select the 50Ω or High Z load resistance.

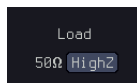

Range 50Ω, High Z

Go Back

Press *Go Back* to return to the Setup menu.

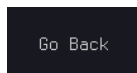

## Quit

**Background** Quit the control loop response measurement.

**Panel operation** Toggle the *Quit* button to return the Power Analysis menu.

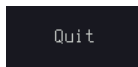

## Analysis mode

There are four main functions in the Analyze menu. Users can perform the cursor measurement, adjust the scale and the offset of the plot, overlap several test waveforms together and save measurement results for future recall as well as post-processing on the computer.

## Measure

**Background** Control loop response measurement uses cursors to precisely measure the data in absolute or relative values.

**Panel operation** 1. Under Analysis mode, press the *Measure* button to enter the Measure menu.



2. Press the *Select* button and use the *VARIABLE* knob and then the *Select* key to set the active trace, showing on top of all other traces, and refresh the cursor measurement accordingly.



**Range** H1, H2, H3, H4 (depends on how many traces have been stored in the system memory)

- The cursor 1 and 2 will appear along the active trace whenever the cursor state turns on. Press Select button to change the active cursor highlighted in green color.

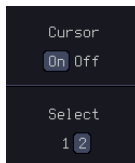

Move the active cursor along the active trace using the *VARIABLE* knob. The corresponding frequency value in Hz (X-axis), gain value in dB (left Y-axis) and phase value in degree (right Y-axis) messages are shown below.

VARIABLE

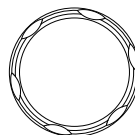

A delta between two cursor measurements is also shown below.

Δ: ( 7.22dB , 7.68° , 76.76Hz )



## Bode Plot

---

### Background

The Scale Bode Plot menu allows the user to adjust the scale and the offset of the plot on the display.

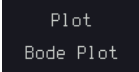
---

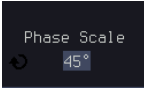
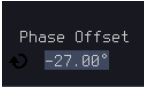
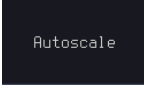
Panel operation	<ol style="list-style-type: none"> <li>When in Analysis mode, press the <i>Plot Bode Plot</i> button to enter the scale bode plot menu.</li> <li>There are four settings which can be adjusted: <i>Gain Scale</i>, <i>Gain Offset</i>, <i>Phase Scale</i>, and <i>Phase Offset</i>, respectively. Press the <i>Autoscale</i> button to automatically preset these parameters suitable for viewing the displayed traces.</li> </ol>	
Gain Scale	<ol style="list-style-type: none"> <li>Press the <i>Gain Scale</i> from the side menu and use the <i>VARIABLE</i> knob to adjust the value.</li> </ol> <p>Range                      5, 10, 15, 20dB</p>	
Gain Offset	<ol style="list-style-type: none"> <li>Press the <i>Gain Offset</i> from the side menu and use the <i>VARIABLE</i> knob to adjust the value.</li> </ol> <p>Range                      (-300+4*Gain Scale)~ (300-4*Gain Scale) dB</p>	
Phase Scale	<ol style="list-style-type: none"> <li>Press the <i>Phase Scale</i> from the side menu and use the <i>VARIABLE</i> knob to adjust the value.</li> </ol> <p>Range                      15°, 30°, 45°, 60°</p>	
Phase Offset	<ol style="list-style-type: none"> <li>Press the <i>Phase Offset</i> from the side menu and use the <i>VARIABLE</i> knob to adjust the value.</li> </ol> <p>Range                      (-720+4*Phase Scale)~ (720-4*Phase Scale) degrees</p>	
Autoscale	<ol style="list-style-type: none"> <li>Alternatively, users can press the <i>Autoscale</i> from the side menu to have the system automatically adjust these parameter to fit in all displayed traces.</li> </ol>	

## Overlay

**Background** User is able to recall the previously saved test waveforms for comparison. Waveforms corresponding to a maximum of four experimental trials can be simultaneously shown on the display.

**Panel operation**

1. Press the *Add* button to select the previously saved data and display the data on the screen.

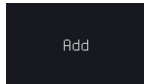

Browse through the folders and files to locate a FRA file (file.FRD) and press the Select key to recall it. A pop-up window then subsequently confirms the success of the operation. For a successful recall, the display will immediately show the newly recalled data on the current plot.

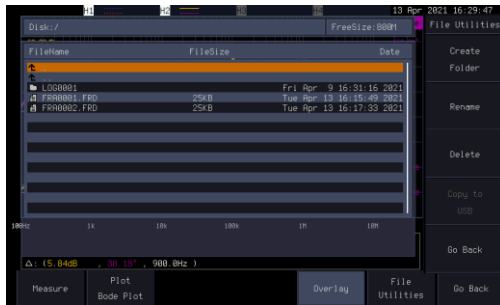

2. Press the *Select* button to choose which group of waveform data is to be operated.
3. Press the *Remove* button to delete selected waveform data and remove APP.

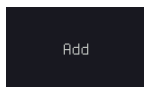

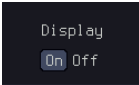
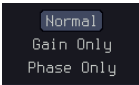
- |   |   |
|---|---|
| 4. Press the <i>Display On/Off</i> button to display or not display selected waveform data. |  |
| 5. Press the <i>Normal/Gain Only/Phase Only</i> button to select display item.              |  |
- |            |                              |
|------------|------------------------------|
| Normal     | Display both Gain and Phase. |
| Gain Only  | Display only Gain            |
| Phase Only | Display only Phase           |

## File Utilities

---

**Background**      With File Utilities, users can save in-memory data into files(in both binary and CSV formats), and recap test conditions in the Info panel.

**Panel operation**    1. When in Analysis mode, press the *File Utility* button to enter the File utility.

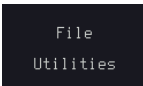

**Select**                2. Select target waveform to be saved.



**Save to File (.FRD)**    3. Press the *Save to File (.FRD)* from the side menu and save the present plotted data to a file for future reference.

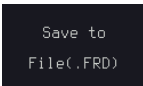

**Save to CSV**            4. Press the *Save to CSV* button to save the present plotted data in the CSV format for post processing on the computer.



**Info**                    5. For more information regarding the current plotted data, press this *Info* button.





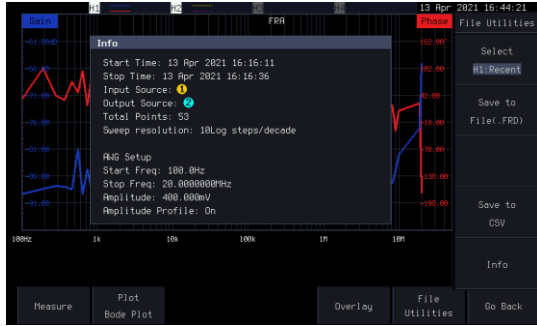

Go Back

6. Press Go Back button to return to the Setting menu.

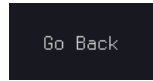

# Power Supply Rejection Ratio (PSRR)

## Using PSRR Measurements

**Background**      The Power Supply Rejection Ratio test is used to verify the rejection of ripple noise in power supply devices over different frequency ranges.

 **WARNING**      Ensure safe working practices are adhered to when working with live voltages. Failure to do so could lead to electric shock or loss of life.

**Setup**

1. For example, connect the corresponding probe to the INPUT/OUTPUT terminal, and connect the AWG output to the INPUT terminal of the operation amplifier.
2. Connect to the power cord and turn on the power switch when all the connections have been made and configured.

**Panel operation**      1. Press the *Power analysis* key on the front panel.

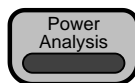

2. Use the *VARIABLE* knob to select *PSRR* function from the screen.

VARIABLE

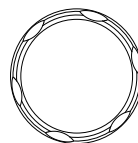

3. The measurements for PSRR appear.

Example : a PSRR test graph

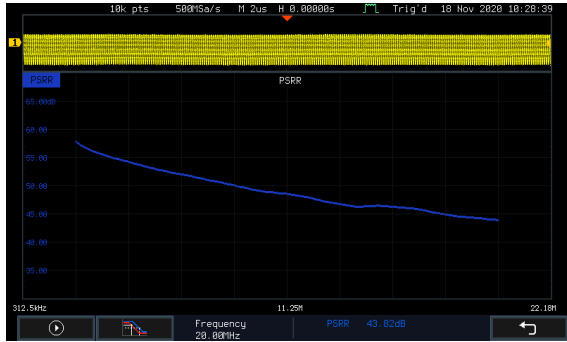

Note

Please be aware that the total time required for measuring the frequency response may vary according to your setup, e.g. the number of points per decade or when sweeping at lower frequencies.

Please note that the control loop response measurement only allows a DSO record length of 10,000 points.

4. In Setting mode (*Run* button appeared), press the *Run* button to start the frequency response analysis.

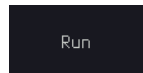

5. The data acquisition will stop automatically when the stop frequency is reached. The button is then toggled back to STOP and the data is ready for analysis.



If the user needs to cancel an ongoing control loop response measurement, the button can be pressed.

- Using the second *Analyze menu* button will switch to the Analysis mode. Details regarding this mode will be explained in later sections.



- Press the icon to return to the upper-level menu.

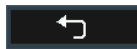

### Source

Please refer to section “Source” on page 274.

### Setup amplitude profile

Please refer to paragraph “Setup amplitude profile” on page 274.

### Setup AWG

Please refer to paragraph “Setup AWG” on page 276.

### Quit

Please refer to paragraph “Quit” on page 278.

### Analysis mode

Please refer to section “Analysis mode” on page 278.

### Measure

Please refer to paragraph “Measure” on page 278 .

### Bode Plot

Please refer to paragraph “Bode Plot” on page 279.

### Overlay

Please refer to paragraph “Overlay” on page 281.

### File Utilities

Please refer to paragraph “File Utilities” on page 282.

## Turn On/Off

### Using Turn On/Off Measurements

**Background** The Turn On measurement determines how fast a turned on power supply takes to reach 85% of its steady state output.

The Turn Off measurement determines how fast a turned off power supply takes to reduce its output voltage to 15% of maximum.



#### WARNING

Ensure safe working practices are adhered to when working with live voltages. Failure to do so could lead to electric shock or loss of life.

#### Setup

1. Connect the differential probe and current probe of the corresponding channel to the INPUT terminal of the circuit, and connect the OUTPUT terminal to another set of passive probes.
2. Connect to the power cord and turn on the power switch when all the connections have been made and configured.

#### Panel operation

1. Press the *Power analysis* key on the front panel.
2. Use the *VARIABLE* knob to select *Turn On/Off* function from the screen.

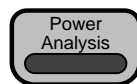

VARIABLE



3. The measurements for Turn On/Off appear.

Example



Source

4. Toggle the *Source* button.

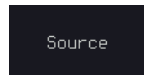

5. Press *Input V* from the side menu and select the channel that is connected to the input of the DUT.



Range CH1 ~ CH4

6. Press *Output V* from the side menu and select the channel that is connected to the output of the DUT.



Range CH1 ~ CH4

- Press *Input I* from the side menu and select the channel that is connected to the output of the DUT.



Range CH1 ~ CH4

**Setup**

- Press *Setup* key from the lower menu.



- Press the *Duration* key and then use the *VARIABLE* knob or numerical keypad to set value of Duration.

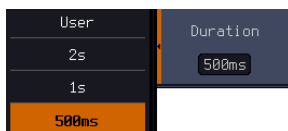

Range 500ms/1s/2s/User

- Press *Save Setup* key to save current setting (select Duration:User followed by pressing *Apply* key for next time use).

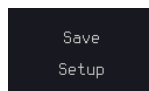

- Set a suitable Duration followed by pressing the *Apply* key to begin the test.



- Lastly, press the “Single” key on the panel to wait for trigger.

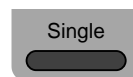

**Meas. Display**

- When trigger occurs and it enters the Stop status, press *Meas. Display* key from the lower menu to choose measurement item.

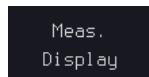

- Press *OFF* key to turn off the measured result on the screen and return back to the level prior to executing test.





3. When “Turn On” is selected for Test and the trigger occurs and it enters the Stop status, the measurement of Turn On/Off Delay (Td), Rise Time(Tr) & Inrush (Ic) will be executed and the measured value will be displayed accordingly.

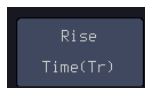

4. When “Turn Off” is selected for Test and the trigger occurs and it enters the Stop status, the measurement of Turn On/Off Delay (Td) will be executed and the measured value will be displayed accordingly.

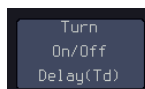

5. Press *Test* key from bottom menu to select either executing Test On or Test Off measurement.

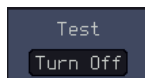
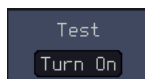

**Gating**

To set the measurement area, press Gating key from the bottom menu and select the gating mode from the side menu.

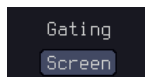

Gating      Off (Full Record), Screen, Between Cursors

# SPECTRUM ANALYZER

---

Spectrum Analyzer operation .....	293
Overview .....	293
Display Overview .....	293
Connections .....	295
Configuration .....	295
Selecting the source .....	295
Setting the trace mode options (Trace type) .....	296
Setting the Detection Method .....	298
Configuring the Frequencies and Span .....	300
Configuring the Bandwidth .....	303
Configuring the Amplitude .....	304
Display .....	305
Measurement .....	308
Using the Search function .....	308
Using the Cursors .....	309

# Spectrum Analyzer operation

## Overview

Background	The Spectrum Analyzer is a dual channel spectrum analyzer with spectrogram specially designed for the GDS-3000A series. It conveniently allows users to analyze the signal in the frequency domain.
Windows	Hanning, Rectangular, Hamming, Blackman
Frequency range	DC to 2.5GHz Max. (Frequency which exceeds analog front end bandwidth is uncalibrated)
Span	1kHz to 2.5GHz Max.
Resolution bandwidth	1Hz to 2.5MHz Max.
Functions	Compatible with the search and cursor functions for accurate measurement in the frequency domain.

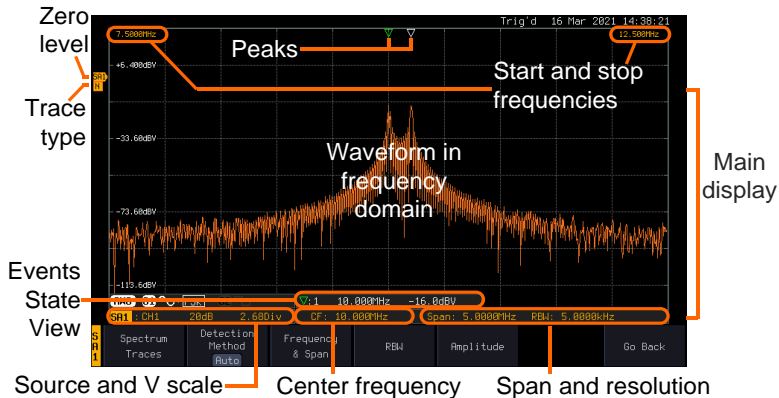

## Display Overview



**Main display**      The Spectrum Analyzer main display can show various spectrum traces of the selected analog source channel, such as the normal, max-hold, min-hold and averaged trace. The start and stop frequency of the span are displayed at both top sides. The remaining frequency span information is displayed at the bottom as well as the vertical scale. The zero level is shown for reference on the Y axis on the left. When the search function is enabled, frequency peaks will be detected and summarized in the Events State View window at the bottom left of the display.

<b>Frequency domain information</b>	<b>7.5000MHz</b>	<b>12.500MHz</b>
	Start frequency (shown on the upper left corner of the main spectrum display)	Stop frequency (shown on the upper right corner of the main spectrum display)
	<b>CF: 10.000MHz</b>	<b>Span: 5.0000MHz</b>
	Center frequency of the span	Width of the span
	<b>RBW: 5.0000kHz</b>	
	Resolution bandwidth	

<b>Vertical scale information</b>	<b>SA1 : CH1</b>	<b>20dB</b>
	Active source channel for the spectrum analyzer	Vertical scale per one division
	<b>2.68Div</b>	<b>SA1 N</b>
	Zero level position	Shows the zero position along the Y-axis (SP) and the type of trace (N = Normal)

Peaks	 Peak mark	<b>Overall: 3</b> Total number of peaks detected (according to the search function parameters).
	 Current active peak	
	 1 Active peak marker	

## Connections

---

Background	The Spectrum Analyzer uses the analog channel inputs of the GDS-3000A SERIES.
------------	---

---

- |            |  |
|------------|--|
| Connection | <ol style="list-style-type: none"> <li>1. Connect the desired signal source to one of the analog channel input of the DSO using BNC connectors.</li> </ol> |
|------------|--|

## Configuration

Setting up a spectrum trace can be done by following the subsequent steps: selecting the source turning on the trace with its associated detection options, configuring the frequencies and span, configuring the window type and the frequency resolution and lastly configuring the vertical scale.

## Selecting the source

---

Background	Before any visualization or measurement can be performed on the spectrum analyzer, it must first be associated with a source.
------------	---

---

- |                 |   |
|-----------------|---|
| Panel Operation | <ol style="list-style-type: none"> <li>1. Press the <i>Spectrum</i> key.</li> </ol> |
|-----------------|---|



- |   |
|---|
| <ol style="list-style-type: none"> <li>2. Press <i>Input Setup</i> from the bottom menu.</li> </ol> |
|---|

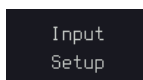

3. Press the Select in the right side to select the first spectrum analyzer (SA1) or SA2 setting.

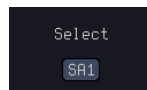

4. Press the Input in the right side to turn On or Off the SA1 or SA2 input.

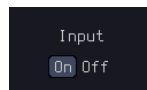

5. Press *Source* from the side menu and choose a source.

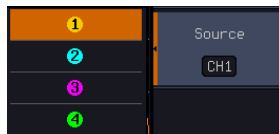

Range            CH1 ~ CH4

## Setting the trace mode options (Trace type)

Background	Trace options determine how the trace data is stored or manipulated before being displayed. The Spectrum Analyzer updates the trace according to the type of trace.
Definitions	<p>Normal: the Spectrum Analyzer continuously updates the display with each sweep.</p> <p>Max/Min Hold: the maximum/minimum points are maintained for the selected trace. The trace points are updated each sweep if a new maximum/minimum point is found.</p> <p>Average: this mode averages the trace for a user-defined number of times before it is displayed. This type of trace smooths the noise level, but it is slower to update.</p>

Example

Normal trace:

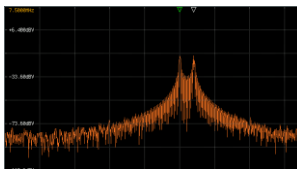

MaxHold:

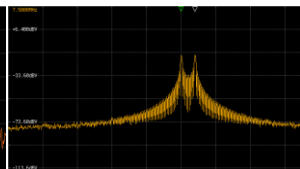

Average:

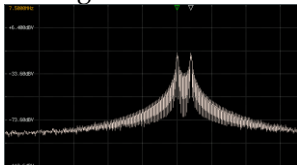

MinHold:

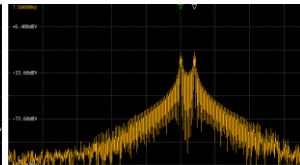

Panel Operation

1. Press the *Spectrum* key to enter the Spectrum Analyzer menu.
2. Press the SA1 setup or SA2 setup to enter the trace setting.
3. Press the *Spectrum Traces* button from the bottom menu.
4. From the side menu, press once on the *Normal* button to toggle this trace option to *On*. Press again to toggle it to *Off*.
5. From the side menu, press once on the *MaxHold* button to toggle this trace option to *On*. Press again to toggle it to *Off*.
6. From the side menu, press once on the *MinHold* button to toggle this trace option to *On*. Press again to toggle it to *Off*.

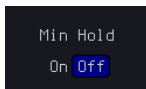
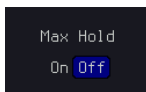
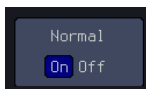
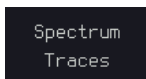
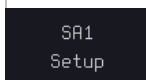
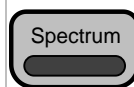

- From the side menu, press once on the *Average* button to toggle this trace option to *On*. Use the *VARIABLE* knob to change the number of sweeps the average will be based on. Press again to toggle it to *Off*.

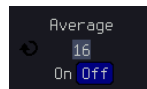

Range 2 ~ 512

- Press the *Reset Spectrum Traces* button to clear all current active traces on the screen and then restart the spectrum calculation process.

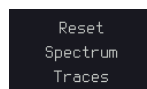

Note

The four different trace types can be activated at the same time, allowing a quick comparison for the maximum, minimum and averaged spectrum magnitude of the underlying signal.

### Example

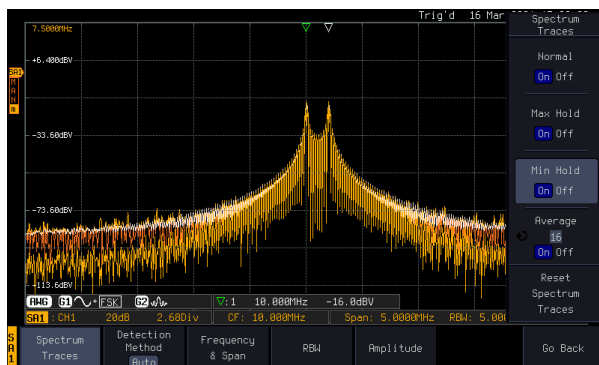





## Setting the Detection Method

### Background

Each time the Spectrum Analyzer samples data, a number of samples are usually taken for each point to display, known as a sample bucket. The actual value of each point is determined by the detection method.

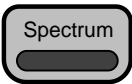

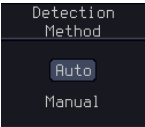
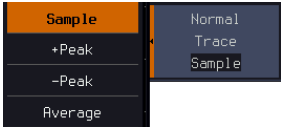
Each trace type (Normal, Max and Min Hold, Average) can use a different detection method.

- Panel Operation
1. Press the *Spectrum* key to enter the Spectrum Analyzer menu. 
  2. Press the SA1 setup or SA2 setup to enter the trace setting. 
  3. Press the *Detection* button from the bottom menu. 
  4. By default, the detection method is set to *Auto*. When selected, the analyzer automatically chooses a detection method suitable for each type of trace. 
  5. Press the button *Auto/Manual* once to toggle the detection method to *Manual* and be able to fine tune the detection method for each type of trace. Press the *Auto/Manual* button once more to toggle it back to *Auto*.
  6. Press on the *Normal Trace* button to see a list of detection options. Use the *VARIABLE* knob and the *Select* key to select one. 
  7. Repeat the same operation for the *Max Hold Trace* button. 
  8. Repeat the same operation for the *Min Hold Trace* button. 

- Repeat the same operation for the *Average Trace* button.

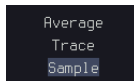

## Configuring the Frequencies and Span

**Center Frequency** The Center Frequency function sets the center frequency. The display will be centered on this frequency.

- Panel Operation**
- Press the *Spectrum* key to enter the Spectrum Analyzer menu.

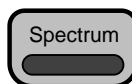

- Press the SA1 setup or SA2 setup to enter the trace setting.

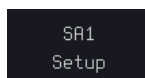

- Press the *Freq & Span* button to enter the frequencies and span menu.

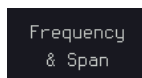

- Press the *Center* button to display a list of frequencies step-resolution.

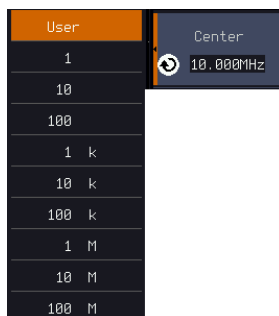

the *VARIABLE* knob can be used to select one. Press again on the *Center* button; the *VARIABLE* knob can now be used to set the frequency in increments of the chosen step resolution.

- Or use the numerical keypad to input value.

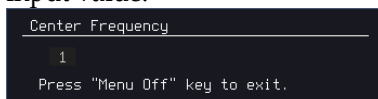

Press *Go Back* to return to the previous menu and validate the user-defined value.

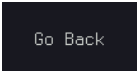

Range 0Hz ~ 2.5GHz

**Span** The Span function sets the frequency range of the sweep. The sweep will be centered around the center frequency.

**Panel Operation** 6. Press the *Span* button to display a list of frequencies step-resolution.

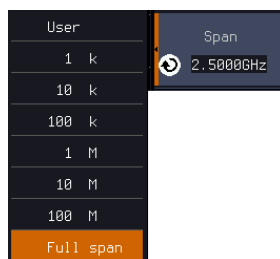

The *VARIABLE* knob can be used to select one. Press again on the *Span* button; the *VARIABLE* knob can now be used to set the frequency in increments of the chosen step resolution.

7. Or use the numerical keypad to input value.

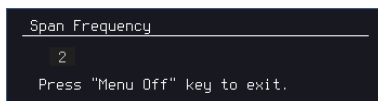

8. Press *Go Back* to return to the previous menu and validate the user-defined value.

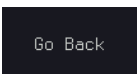

Range 1kHz ~ 2.5GHz

**Start and Stop Frequencies** The Start and Stop frequencies can also be used to specify the span frequency.



The Start and Stop frequencies are automatically adjusted when configuring the Center and the Span.

Conversely, configuring the Start and Stop frequencies will automatically configure the Center and the Span.

The Stop frequency must always be higher than the Start frequency. As a consequence, when one crosses the other's value, the Start or Stop frequency will automatically be adjusted to the next highest/smallest step.

- Panel Operation 9. Press the *Start* or *Stop* button to display a list of frequencies step-resolution.

The *VARIABLE* knob can be used to select one. Press again on the *Start* or *Stop* button; the *VARIABLE* knob can now be used to set the frequency in increments of the chosen step resolution.

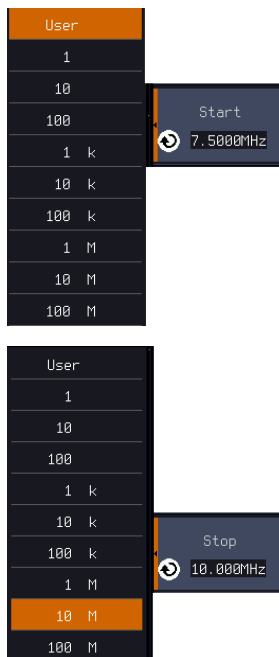

10. Use the numerical keypad to input value.

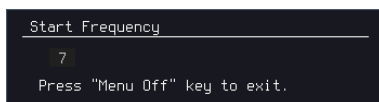

Press *Go Back* to return to the previous menu and validate the user-defined value.

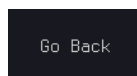



Range Start: 0Hz ~ 2.4999GHz

Stop: 500Hz ~ 2.5GHz

Peak to center	Pressing this button will set the frequency location of the spectrum peak as the new center frequency of the Spectrum Analyzer.	
----------------	---	---

## Configuring the Bandwidth

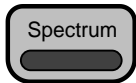
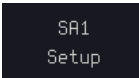
Background	The bandwidth menu gives the possibility of configuring the resolution bandwidth as well as the type of window used for the spectral analysis.
------------	--

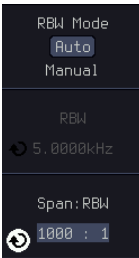
Panel Operation	<ol style="list-style-type: none"> <li>1. Press the <i>Spectrum</i> key to enter the Spectrum Analyzer menu.</li> </ol>	
	<ol style="list-style-type: none"> <li>2. Press the SA1 setup or SA2 setup to enter the trace setting.</li> </ol>	
	<ol style="list-style-type: none"> <li>3. Press the <i>RBW</i> button to enter the bandwidth menu.</li> </ol>	
	<ol style="list-style-type: none"> <li>4. The resolution bandwidth can be set automatically according to a configurable ratio defined between the span and the frequency resolution. To choose that option, set the <i>RBW Mode</i> button to <i>Auto</i>, press on the <i>Span: RBW</i> button and tune the ratio using the <i>VARIABLE</i> knob.</li> </ol>	

Range            5,000:1 ~ 1,000:1

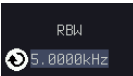
<ol style="list-style-type: none"> <li>5. Alternatively, set the <i>RBW Mode</i> button to <i>Manual</i> to manually configure the frequency resolution.</li> </ol>	
<ol style="list-style-type: none"> <li>6. Press the <i>RBW</i> button to select the RBW frequency. the <i>VARIABLE</i></li> </ol>	

knob can be used to select.

**Window type** The type of window used for spectrum analysis can be chosen. Each window type is characterized by making a tradeoff between the frequency resolution and the amplitude accuracy. Please see the note below.

7. Press the *Window* button and change the window type using the *VARIABLE* knob. Press again the *Window* button to confirm the change.

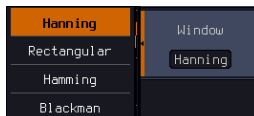

**Note**

Hanning and Hamming windows are both good to analyze periodic signals. The rectangular window is more suitable for single shot phenomenon. The Blackman window is most suitable for amplitude measurement on periodic signals. Please refer to the Section “Math operations”, paragraph “FFT Overview” on page 66 and 68 for more details.

## Configuring the Amplitude

**Background** The vertical scale and the zero reference position can be configured in this menu.

- Panel Operation**
1. Press the *Spectrum* key to enter the Spectrum Analyzer menu.
  2. Press the SA1 setup or SA2 setup to enter the trace setting.
  3. Press the *Amplitude* button to enter the vertical scale menu.

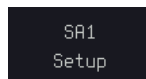
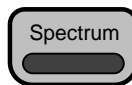

- Choose a vertical unit by toggling the *Vertical Units* button to *dBV RMS*, *Linear RMS*, or *dBm* using the *VARIABLE* knob.

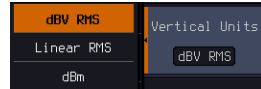

When the setting unit is dBm, connect a 50 Ohm feed through termination on BNC.

- You can define the scale of the vertical axis by pressing on the *Unit/div* button and using the *VARIABLE* knob.



Range      1dB ~ 20dB (dBV RMS, dBm)  
               2mV ~ 1kV (Linear RMS)

- You can define the zero level position by pressing on the *Position* button and using the *VARIABLE* knob.

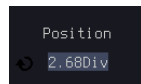

Range      -12.00 ~ 12.00 Div

**AWG**

AWG fast switch button. This button is used for user to observe the AWG waveform change easily in the spectrum after changing waveform parameters.



## Display

**Background**

Display key allows user to select either normal spectrum display or spectrogram display, which is useful for viewing frequency or power in the time domain. Use the *VARIABLE* knob to select.

**Panel Operation**

- Press the *Spectrum* key to enter the Spectrum Analyzer menu.

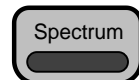

2. Press *Display* key from the side menu.

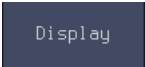

An example of both spectrum and spectrogram displaying on the LCD screen at the same time.

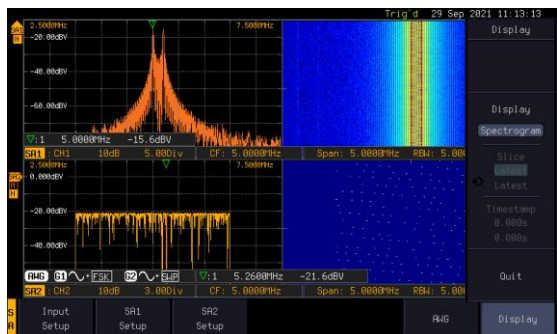

3. Choose a display mode by toggling between *Spectrum* button and *Spectrogram* button using the *VARIABLE* knob.

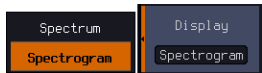

4. In the midst of spectrogram execution, press the *Run/Stop* key and turn the *VARIABLE* knob to observe the correlation between slice and frequency domain from the spectrogram display.

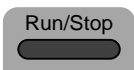

VARIABLE

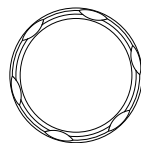



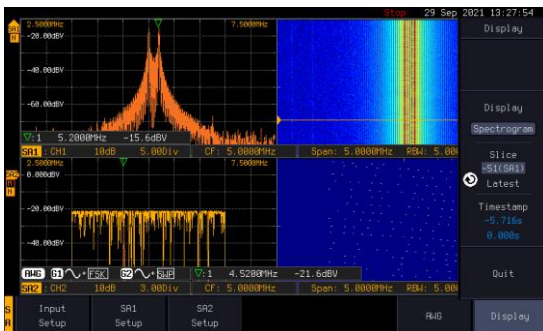

Operation

5. Press the *Run/Stop* key followed by pressing the *Slice* key and rotate the *VARIABLE* knob to observe input signal. And it's spectrogram on the same date time axis.

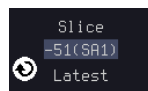
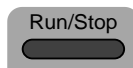

VARIABLE

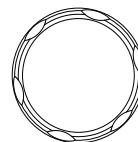

Timestamp

6. The information on the *Timestamp* displays current slice time.

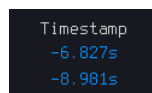

## Measurement

The Spectrum Analyzer of the GDS-3000A is compatible with a certain number of measurement tools such as the search function and the use of cursors, enabling detailed analysis of the signal characteristics in the frequency domain.

### Using the Search function

**Background** When the Spectrum Analyzer is on, pressing the *Search* key and turning on the Search function will automatically pre-configure the *Search Type* and the *Source* (respectively set to *SP Peak* and *SP*) in order to search for spectrum peaks. Please also note that it is not possible to search for spectrum peaks if the Spectrum Analyzer Option is not on.

**Panel Operation**

1. When the Spectrum Analyzer is on, press the Search key.

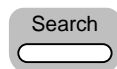

2. Press the *Search* button from the bottom menu to turn the Search function on.

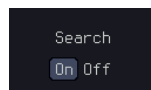

3. Configure the Search Method by pressing the *Method* button from the bottom menu and choose between two methods:

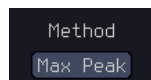

Max Peak: search for a defined number of peaks. Threshold: search for peaks above a defined threshold level.



4. You can configure the Event state display by toggling the State Info button either to Mark or to Peak.

Mark: displays the overall number of peaks and the current active peak.

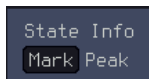

Peak: gives frequency and level details of the current active peak.

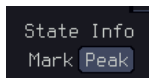

5. Press on the Peak Table button from the bottom menu to examine all the searched spectrum peaks in a tabulated form or save it as files on an external USB drive.

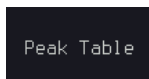

For more details about the Search function, please refer to the section "Search" on page 176 for more details.

## Using the Cursors

**Background** Horizontal and vertical cursors can be used together with the Spectrum Analyzer.

- Panel Operation**
1. When the Spectrum Analyzer is on, press the cursor key.
  2. Move the horizontal cursors along the trace to perform accurate measurement of frequency and level. Use the horizontal cursor to further measure points of interest in both absolute and delta values.

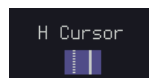

For more details about the *cursor* function, please refer to the section "Cursor" on page 59 for more details.

Use the Save / Recall menu to save the spectrum data as a CSV file in SA mode, but you can't recall the file to the screen.

# A APPLICATIONS

---

Introduction.....	311
Overview .....	311
Running Applications .....	312
Go-NoGo application .....	314
DVM application .....	319
Data Log application.....	321
Digital Filter application .....	323
Mask application .....	325
Select the source channel .....	325
Configure the mask violation .....	326
Auto Mask.....	327
User Defined Mask/ Create Mask.....	330
User-defined Mask File Format.....	334
FRA application .....	336
Connections.....	337
Launching the FRA application .....	338
Setting mode.....	338
FRA Run .....	339

# Introduction

## Overview

---

**Background**      The Application (APP) function allows different software applications to be run. The GDS-3000A comes pre-installed with a number of apps, as described below. Please see your local GW Instek distributor for the latest information on new apps.

---



<b>Included Applications</b>	<b>Go/No-Go</b>	The Go/No-Go application can be used to set threshold boundaries for input signals. Go/No-Go tests to see if a waveform will fit inside a user-specified maximum and minimum amplitude boundary (template).
	<b>DVM</b>	The DVM application displays a digital voltage meter readout that floats on the top left-hand side of the screen.
	<b>Data Log</b>	The Data Log app will log waveform data and/or screenshots at set intervals for set duration of time.
	<b>Digital Filter</b>	Adds a digital low, high or band pass filter to any of the input channels. Each filter can have a user-defined cutoff frequency set.

---

Frequency response analyzer	The Frequency Response Analyzer (FRA) is a feature application for digital storage oscilloscope with an integrated arbitrary waveform generator.
Mask	Create shape templates for signal comparison.
Mount Remote Disk	This app allows the scope to mount a network share drive.
Demo	The Demo app, when combined with the GDB-03 demo board, allows the scope to trigger a number of different signals from the demo board.

## Running Applications

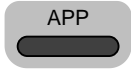
**Background** The GDS-3000A comes pre-installed with a number of apps which can be activated from a dedicated menu.

- Panel Operation**
1. Press the *APP* key.
 
  2. Press *APP* from the bottom menu.
 
  3. Scroll through each application using the *VARIABLE* knob.
 



4. Select an application by pressing the *Select* key *twice*.

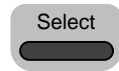

x2

## Go-NoGo application

### Background

The Go-NoGo test checks if a waveform fits inside a user-specified maximum and minimum boundary. Boundary templates are automatically created from a source channel. Boundary tolerances and violation conditions can be set.

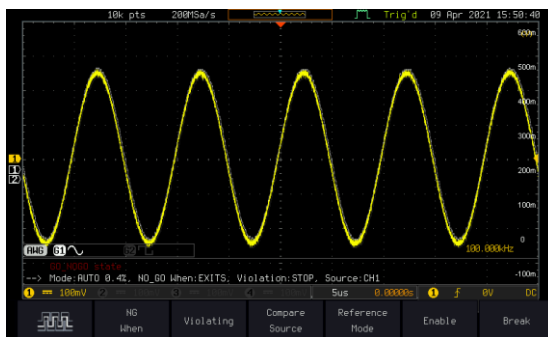

Choose the Go\_NoGo application from the APP menu. See page 312.



### Set Go-NoGo Conditions

Select the Go-NoGo conditions (NG When) and actions when a Go-NoGo condition has been met (Violating).

1. Press *NG When* from the bottom menu and select the NoGo conditions:

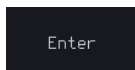
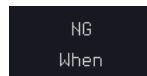



Enter: Sets the NoGo condition to when the input signal stays within the limit boundary.



Exit: Sets the NoGo condition to when the input signal exceeds the limit boundary.

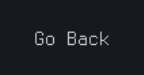
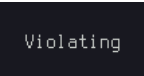
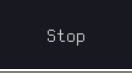
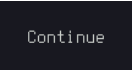
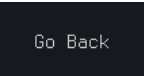
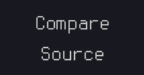

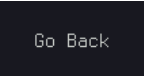
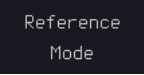
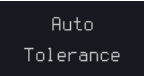
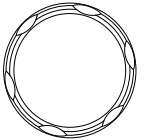
	2. Press <i>Go Back</i> to return to the previous menu.	
Set Go-NoGo Actions	3. Press <i>Violating</i> to set what action to perform when a signal violates the Go-NoGo conditions.	
	 The waveform stops when the conditions are violated.	
	 Ignore violations and continue to monitor the signal. Each violation is counted.	
	4. Press <i>Go Back</i> to return to the previous menu.	
Set Go-NoGo Source	5. Press <i>Compare Source</i> from the bottom menu to set the Go-NoGo boundary source.	
	 Sets CH1 as the source.	
	 Sets CH2 as the source. There are up to four channels.	
	6. Press <i>Go Back</i> to return to the previous menu.	
Set Boundary Tolerance	7. To set the Go-NoGo boundary tolerance, press <i>Reference Mode</i> .	
Auto Tolerance	8. To set the boundary tolerance as a percentage offset from the source waveform, press <i>Auto Tolerance</i> and use the <i>VARIABLE</i> knob.	
		

Offset      0.4% ~ 40% (.4% steps)

Maximum and Minimum Position

9. To manually set the template tolerance, press *Minimum Position* or *Maximum Position* and use the *VARIABLE* knob to set the absolute minimum or maximum position.

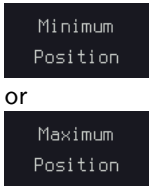

Range      Voltage division range

Save Boundary Template

10. Press *Save Operation* to save the tolerance boundaries.

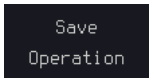

11. The Maximum Position tolerance will be saved to reference waveform R1, and the Minimum Position tolerance to R2.

12. Press *Go Back* to return to the previous menu.

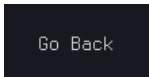

Start Go-NoGo

Press *Enable* to start the Go-NoGo test. Then the Enable button will change to Disable. Pressing *Disable* will stop the Go-NoGo test and toggle the button back to Enable.

If the Violating setting was set to Stop, press *Enable* to restart the test after it has stopped.

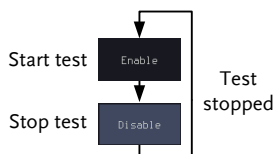

Results

When Go-NoGo is running, the violation/test ratio is displayed in the bottom left-hand corner. The first digit represents the number of violations, and the right hand digit represents the number of tests.

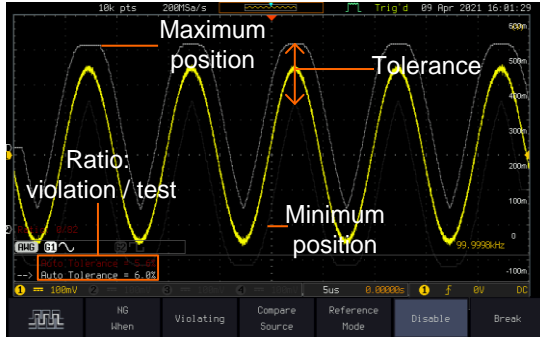

Exit the Application

To exit the application, press *Break*.

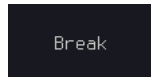

Note

After you exit the Go/NoGo app, the boundary templates that were saved to R1 & R2 reference waveforms will still be turned on. See page 363 to turn the reference waveforms off.

Using the Go-NoGo Output

To output the Go-NoGo results to an external device, the Go-NoGo rear panel terminal (open collector) can be used. The Go-NoGo terminal will output a positive pulse each time a NoGo violation has occurred for a minimum of 500us. The voltage of the pulse depends on the external pull-up voltage.

Go/No Go



Timing Diagram

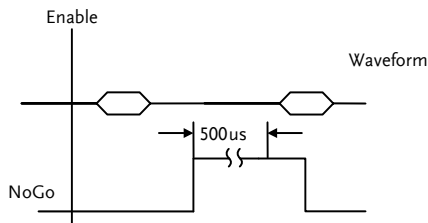

Circuit Diagram

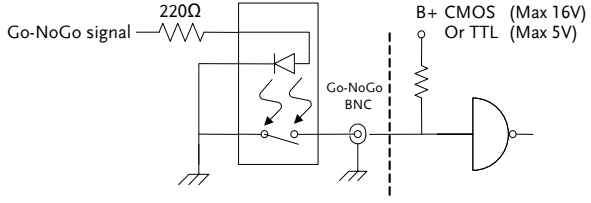

## DVM application

### Background

The DVM app is a digital voltage meter or digital current meter readout that floats on the top left-hand side of the screen. However, please note that if the cursors (refer to page 59) are turned on, the DVM readout will be replaced by the cursor readout.

The DVM app allows you to measure the AC RMS, DC, DC RMS, Duty and frequency of an input signal. This software is especially useful for those measurement applications that require both a DSO and a basic DVM to be used at the same time.





### Basic Features:

- 300V input (peak AC + DC) CAT 1
- 3 digit resolution for voltage measurements
- 5 digit resolution for frequency
- Input channel selection

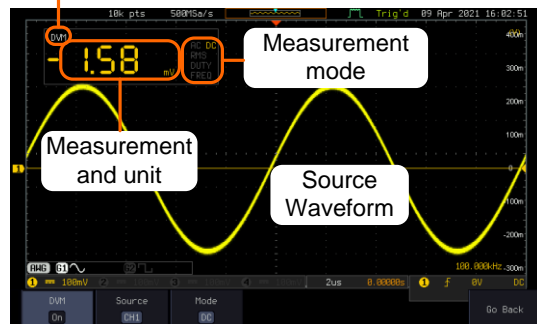
### Example APP-DVM-1.png

#### DVM function indicator



Panel Operation	Choose the DVM application from the APP menu. See page 312.	
Set Source	<ol style="list-style-type: none"> <li>1. Press <i>Source</i> and select the source channel for the DVM. The probe type setting (voltage or current) determines whether the function acts as a digital voltmeter or as a digital current meter for the selected source. See page 111 to set the probe type.</li> </ol>	
<p>Source      CH1 ~ CH4</p>		
Mode	The Mode setting determines the measurement mode for the meter.	
	<ol style="list-style-type: none"> <li>2. Press <i>Mode</i> and select the mode.</li> </ol>	
<p>Mode      AC RMS, DC, DC RMS, Duty, Frequency</p>		
Turn On/Off	<ol style="list-style-type: none"> <li>3. Press <i>DVM</i> and toggle DVM on. The DVM app will remain running in the background even if other functions are turned on.</li> </ol>	

# Data Log application

**Background** The Data Log app will log the current waveform data or screenshot at set intervals for a set duration of time.

Basic Features:

- Log up to 1000 hours of images or waveform data.
- The minimum interval is 2, or 5 seconds, and the Interval time needs to be lengthened because of the longer memory length. If you use the USB flash drive to store data, it may require a longer interval which depends on the storing data speed of the USB flash drive.

**Example**

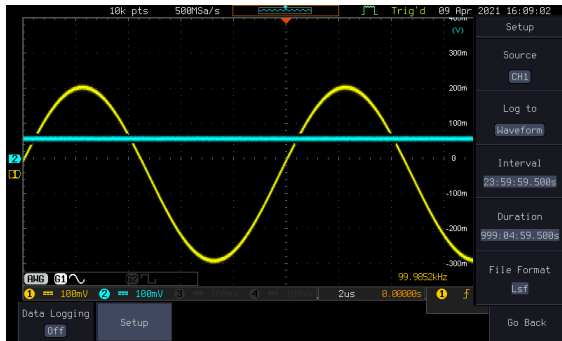

**Panel Operation** Choose the Data Log application from the APP menu. See page 312.

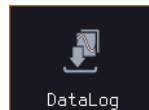

1. Press *Setup*.

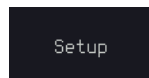

2. Press *Log to* from the side menu and select what type of data to log, waveform data or screenshots.

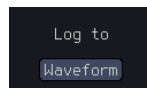

---

Log to      Image, Waveform

---

3. Press *Source* from the side menu and select a source channel to log if waveforms are to be logged.





---

Source      CH1 ~ CH4, All Displayed

---

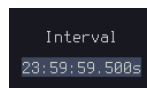
4. Press *Interval* and set the logging interval time.





---

Interval      Data: 2sec ~ 23h59m59.5s  
                  Image: 5sec ~ 23h59m59.5s

---

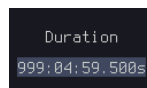
5. Press *Duration* and select the logging duration time.



---

Duration      5sec ~ 999h59m59.5s

---

6. From the bottom menu, press *File FORMAT* and set the save file format. See the Save/Recall chapter (page 365) for details.

Turn On/Off

7. Press *Data Logging* from the bottom menu and toggle Data Logging on.

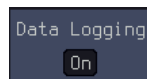

The data/images will be saved to the designated file path when Data Logging is turned on.

---



## Digital Filter application

**Background** The Digital Filter app is a digital high, low, band pass filter with a selectable cutoff frequency. The digital filter can be applied to analog channel individually or together using the tracking functionality.

**Basic Features:**

- High, low, band pass filtering of analog channels.
- Selectable cutoff frequencies.
- Tracking function

**Example**

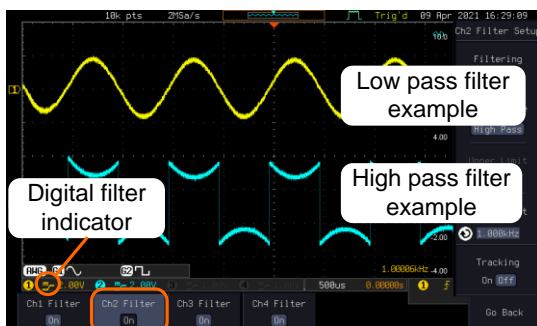

Digital filter  
type or status

CH1 input: 2Vpp 1kHz square wave, low pass filter with 1kHz cutoff frequency.

CH2 input: 2Vpp 1kHz square wave, high pass filter with 1kHz cutoff frequency.

**Panel Operation** Choose the Digital filter application from the APP menu. See page 312.

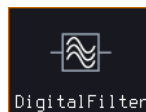

**Set Source**

1. Select a source channel by pressing *Ch1 Filter*, *Ch2 Filter* and for 4-channel model, *Ch3 Filter*, *Ch4 Filter*.



2. From the side menu press *Filtering* and turn on.
3. Press *Filter Type* and select low, high, or band pass filter.

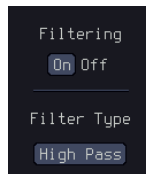

Type                      Low Pass, High Pass, Band Pass

4. If Low Pass was selected, press *Upper Limit* to set the low pass cutoff frequency. Likewise if High Pass was selected, press *Lower Limit* to set the high pass cutoff frequency. Only one option will be available at a time.



Upper Limit    1Hz ~ 0.495 x sampling frequency

Lower Limit    1Hz ~ 0.495 x sampling frequency

**Tracking**

5. Press *Tracking* if you want the settings of the digital filter on each channel to be the same. When a setting is changed on one channel, it is reflected on the other channels.

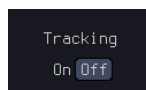

Note

The digital filter settings will still apply to the relevant input signals after leaving the app, unless turned off.

# Mask application

**Background**      The Mask application allows the user to create shape templates for easy comparison of an input signal with a defined shape.

**Panel Operation**    Choose the Mask application from the APP menu. See page 312.

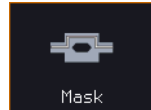

## Select the source channel

**Step**                    1. Press the *Compare Source* button from the bottom menu.

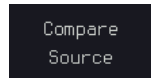

2. Press the CH1 button from the side menu and use the *VARIABLE* knob to select a source channel (CH1, CH2 for 2 channels models; CH3 CH4 for 4 channels models) as a compare source.



VARIABLE

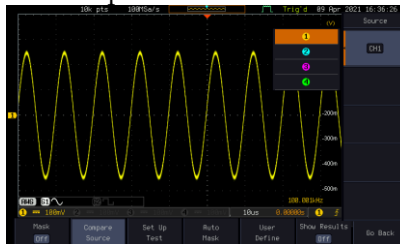
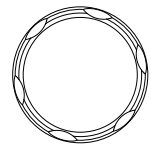

## Configure the mask violation

- Step
1. Press the *Set up test* button from the bottom menu.

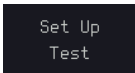
  2. Press *Violating Threshold* to set the number of violations that can occur before a test status is considered.

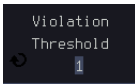

  3. Press *Stop After Time* to set the test to stop after a set amount of time elapses.



Range 1~172,800s (infinite)
  4. Press *stop After Waveform* to set the test to stop after a set number of waveforms.

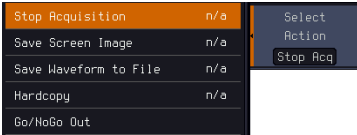

Range 1~1,000,000 (infinite)
  5. Press *Select Action* to set how the oscilloscope responds to test failure. User can set multiple actions as shown in the figure below.

  6. Press *Action on Failure On/Off*. The above setting will be executed only when Failure On or Off occurs.

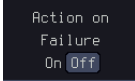
  7. Press *Action on Test Completion On/Off*.

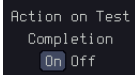

- Press "Go/NoGo Out" option to set how the oscilloscope will respond to test completion.

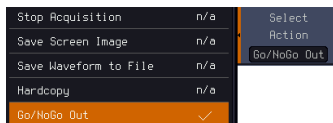

- Press *Pre-Test Delay* to set a delay before starting a test.



- Press *Repeat on Completion (On/Off)* to set on for the test to repeat when it has run the minimum number of waveforms or the minimum amount of time



Set off for the test to run a single time and not repeat.

## Auto Mask

---

### Step

- Press the *Auto Mask* button from the bottom menu to create a mask shaped out from an existing waveform.
- Press the *Reference Source* button from the side menu to select the pattern the mask will be shaped on.

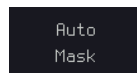

- Use the *VARIABLE* knob to select the reference source (CH1 or CH2 for 2 channels model; CH3 or CH4 for 4 channels model).

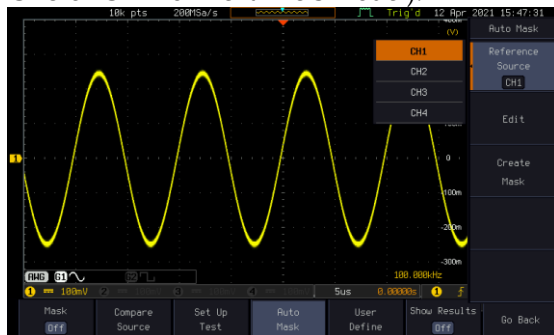

- Press the *Edit* button from the side menu if you want to further adjust the mask pattern. Otherwise, go to step 9 below to create the mask directly without adjustment.
- Edit
- Press the *Unit* button from the side menu and use the *VARIABLE* knob to select either *Divisions* (graticule division fractions) or *Current* (X or Y axis actual scale units) as the units to set the mask deviation from its original pattern.

- Press the *X Mask* button from the side menu and use the *VARIABLE* knob to adjust the horizontal deviation of the mask compared to its original pattern.

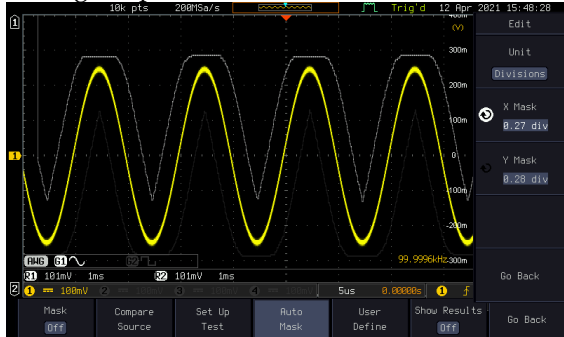

- Press the *Y Mask* button from the side menu and use the *VARIABLE* knob to adjust the vertical deviation of the mask compared to its original pattern.

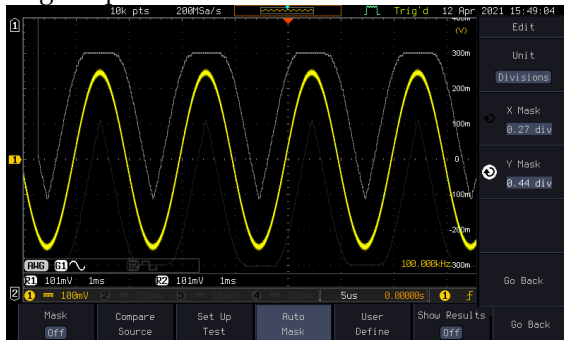

- Press the *Go Back* button from the side menu.

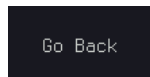

- Press the *Create Mask* button from the side menu.

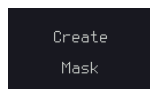

A mask is created (as shown in the below diagram) and can now be used.

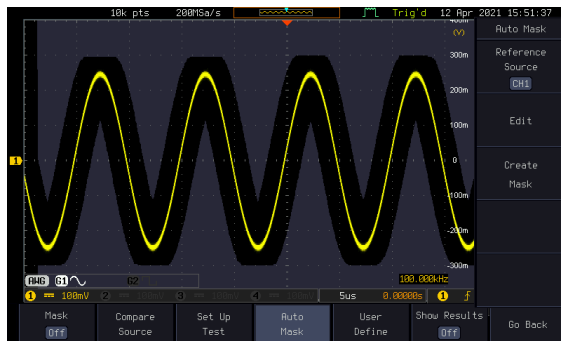

10. Press the *Auto Mask* button from the bottom menu to close auto mask function.

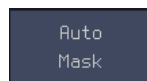

11. Press the *Mask ON* button from the bottom menu to execute the mask function and start comparing the source channel (set in the compare source menu) with the mask.

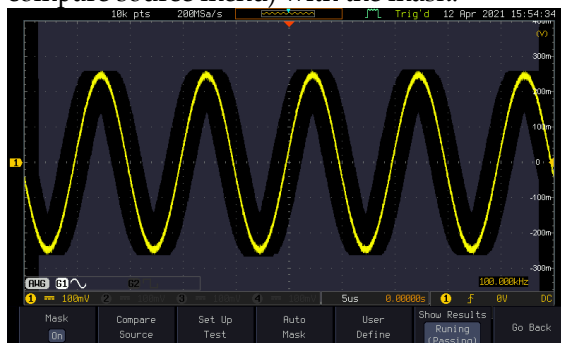

## User Defined Mask/ Create Mask

### Background

A user-defined mask can be created. Up to 8 areas of any form, each made of up to 10 points, can be built out and juxtaposed to each other to form the user-defined mask pattern.

### Step

1. Press the *User Define* button from the bottom menu.

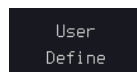



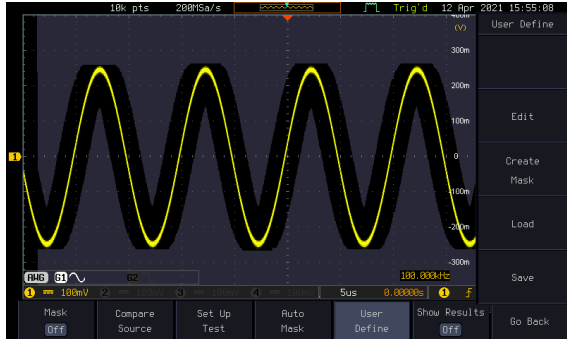

2. Press the *Edit* button from the side menu.

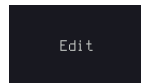

Create an area

3. Press the *Area Number* button from the side menu and use the *VARIABLE* knob to select 1 out of 8 areas that can be created to build the mask pattern and start to shape it.

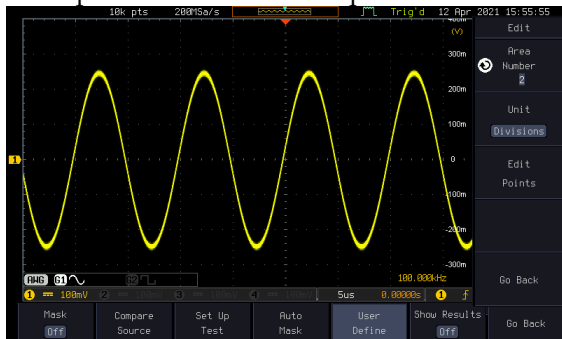

4. Press the *Unit* button from the side menu and use the *VARIABLE* knob to either select *Divisions* (graticule division fractions) or *Current* (Actual oscilloscope X- and Y-axis scale units) as the points position units.

5. Press the *Edit Points* button from the side menu to start shaping the pattern of the area you selected.

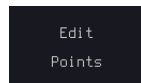

- Edit the first point 6. Press the *Points Number* button from the side menu and use the *VARIABLE* knob to select the first point that will shape the area pattern. Up to 10 points can form an area pattern.
7. Press the *Points Number ON* button from the side menu to activate the point.
  8. Press the *Y Mask* button from the side menu and use the *VARIABLE* knob to adjust the vertical position of the point (Y-axis).
  9. Press the *X Mask* button from the side menu and use the *VARIABLE* knob to adjust the horizontal position of the point (X-axis).

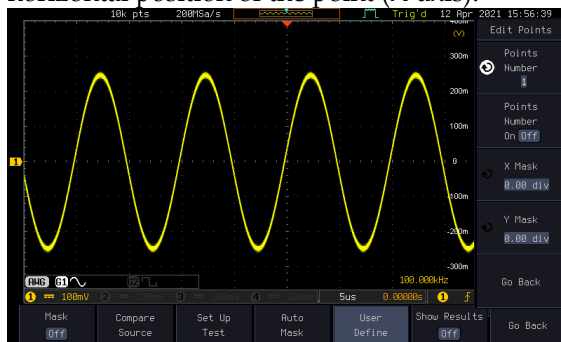

- Edit the other points
10. Repeat the above steps 6 to 9 to add other points to the area and until you finalize the shape of this first area. Then press the *Go Back* button to exit the Edit Points menu.

- Create other areas
11. Repeat the above steps for as many areas as you need to create your mask pattern.

12. Press the *Go Back* button again from the side menu.

Go Back

13. Press the *Create Mask* button from the side menu.

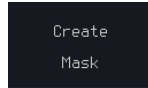

A user-defined mask is created (as shown in the below diagram) and can now be used.

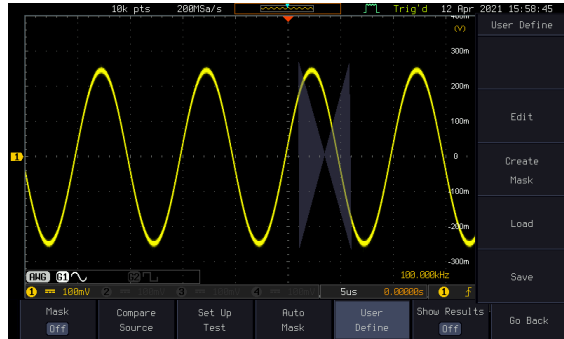

Save the user-defined mask

14. Press the *Save* button from the side menu.

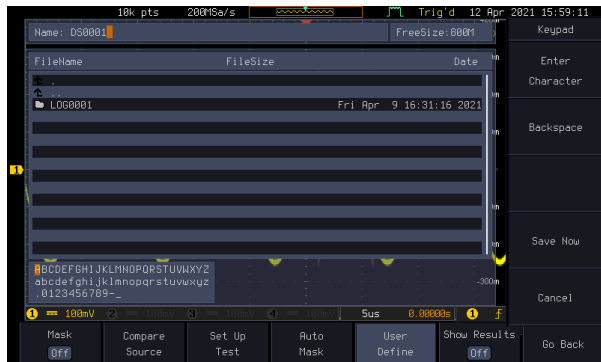

15. Use the *VARIABLE* knob and the select key to change the name of the file if needed and press the *Save Now* button from the side menu to save the user-defined mask.

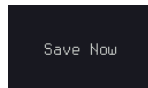

Load a user-defined mask

16. From the User Define menu, you can also load an existing mask. Press the *Load* button from the side menu, use the *VARIABLE* knob to select the file, and press the *Select* key twice to load the mask.

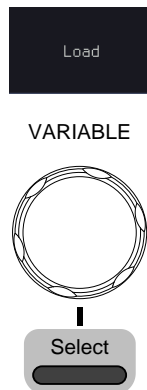

## User-defined Mask File Format

---

Background

The user-defined mask files can be created out of support (from an external computer for example) and uploaded to the GDS-3000A Mask application with a USB flash disk.

Create an unformatted text file respecting the format described below.

File extension

*File\_name.MSK*

Format

Format (XX: version number)  
 Total Area Number,1,  
 Area Number,1,  
 Points Number,3,  
 0.00,2.00,  
 1.00,1.00,  
 -1.00,1.00,

Example (with Division units)	Format (XX: version number) Total Area Number,2, Area Number,1, Points Number,4, 0.00,2.00, 1.00,1.00, 0.00,0.00, -1.00,1.00, Area Number,2, Points Number,3, 0.00,-2.00, 1.00,-1.00, -1.00,-1.00,
-------------------------------------	--

# FRA application

**Background** The Frequency Response Analyzer (FRA) is a feature application for digital storage oscilloscope with an integrated arbitrary waveform generator. It can plot gain and phase responses at the output of a device-under-test (DUT) when its input is excited by a frequency-swept sinusoidal signal. Bode plots can be created, stored for future reference and analyzed. The FRA application uses the output of the Arbitrary Wave Generator (AWG) to generate the frequency-swept signal.

- Functions**
- Bode plots.
  - Stores plots for future use and analysis.
  - Precise analysis of the measured data in a plot with the aid of cursor measurement.
  - Amplitude profile implemented along with independent interpolation control for all test frequency bands.

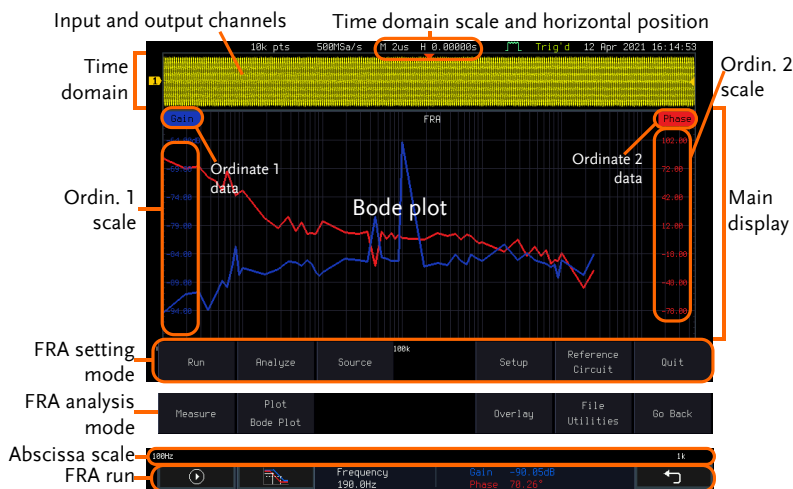

**Introduction**      The FRA application is divided into two main operation modes: Setting and Analysis mode.

When in Setting mode (the  menu icon appeared), the user can setup the FRA analysis and then start it right after the FRA Run button is pressed.

---

**Time domain**      When the FRA application is in Setting mode, the top portion of the display window shows time-domain waveforms of the input and the output channel. This window disappears when in Analysis mode.

---

**Main display**      In either mode, the FRA main display shows a Bode plot with corresponding abscissa and ordinates scales.

## Connections

---

**Background**      The FRA application uses two analog channels of the DSO as well as the GEN1 output of the Arbitrary Wave Generator (AWG).

---

- Connection**
1. Connect the AWG output GEN1 to the input of the Device-Under-Test (DUT).
  2. Connect one DSO analog channel to the input of the DUT.
  3. Connect the output of the DUT to another DSO analog channel.

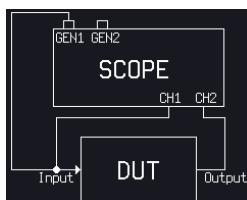

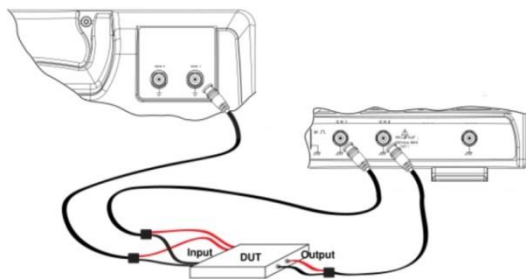

## Launching the FRA application

**Background**      The FRA application is launched from the *APP* menu.

- Panel Operation**
1. Press the *APP* key.
  2. Press the *APP* button from the bottom menu.
  3. Scroll through the applications using the *VARIABLE* knob until the FRA application is highlighted.
  4. Launch the FRA application by pressing the *Select* key twice.



x2

## Setting mode

In Setting mode (*FRA Run* button appeared), the user can define the sources and setup the frequency-swept sinusoidal signal generated by the AWG. In addition, FRA data acquisition is launched from this mode.



## FRA Run

---

**Background** Once the FRA application is fully setup and the DUT is correctly connected, data can be acquired by pressing the *Run* button.

---



Note

Please be aware that the total time required for measuring the frequency response may vary according to your setup, e.g. the number of points per decade or when sweeping at lower frequencies.

Please note that the FRA application only allows a DSO record length of 10,000 points.

---

**Panel operation**

1. In Setting mode (*FRA Run* button appeared), press the *FRA Run* button to start the frequency response analysis.



2. The data acquisition will stop automatically when the stop frequency is reached. The  button is then toggled back to STOP and the data is ready for analysis.



If the user needs to cancel an ongoing FRA measurement, the  button can be pressed.

3. Using the second *Analyze menu* button will switch to the Analysis mode. Details regarding this mode will be explained in later sections.

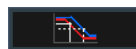

4. Press the icon to return to the upper-level menu.

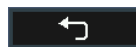

### Source

Please refer to section “Source” on page 274.

### Setup amplitude profile

Please refer to paragraph “Setup amplitude profile” on page 274.

### Setup AWG

Please refer to paragraph “Setup AWG” on page 276.

### Quit

Please refer to paragraph “Quit” on page 278.

### Analysis mode

Please refer to section “Analysis mode” on page 278.

### Measure

Please refer to paragraph “Measure” on page 278 .

### Bode Plot

Please refer to paragraph “Bode Plot” on page 279.

### Overlay

Please refer to paragraph “Overlay” on page 281.

### File Utilities

Please refer to paragraph “File Utilities” on page 282.

# SAVE/RECALL

---

File Format/Utility .....	342
Image File Format.....	342
Waveform File Format.....	342
Spreadsheet File Format.....	343
Setup File Format.....	345
Create/Edit Labels .....	348
Save .....	351
File Type/Source/Destination.....	351
Save Image.....	351
Save Waveform.....	354
Save Setup.....	356
Recall.....	358
File Type/Source/Destination.....	358
Recall Default Panel Setting.....	358
Recall Waveform .....	360
Recall Setup .....	361
Reference Waveforms .....	363
Recall and Display Reference Waveforms .....	363

## File Format/Utility

### Image File Format

---

Format	*.bmp or *.png
Default Filename	DSxxxx.bmp/png
Contents	The display image is 800 by 480 pixels. The background color can be inverted (Ink saver function). Each image file is saved to the current file path as a bitmap or PNG file.

### Waveform File Format

---

Format	DSxxxx.lsf, CH1~CH2.lsf	
	The LSF file format efficiently stores waveforms. This is the file format used for storing and recalling all waveforms that are used with the GDS-3000A series.	
Filename	DSxxxx.lsf	
Waveform Type	CH1 ~ 4	Input channel signal
	REF	Reference waveform
	Math	Math operation result (page 66)
Storage Location	Wave1 ~ Wave20	Waveform files stored to the internal memory. Stored waveforms can be transferred to Ref. 1 ~ 4 to be viewed on the display. (W1 ~ W20 waveforms cannot be directly recalled on the display).
	Ref 1~4	Reference waveforms stored in the internal memory, separate from W1 ~ W20. Reference waveforms (Ref 1 ~ 4) can be displayed directly onto the display with amplitude and

frequency information. Ref 1~4 are useful for reference purposes. Other waveforms (LSF and W1~20) must be recalled to R1~4 before being displayed.

Contents: The waveform data can be used for detailed Waveform Data analysis. It consists of the horizontal and vertical data used by the waveform.

## Spreadsheet File Format

Format \*.csv (Comma-separated values format, can be opened in spreadsheet applications such as Microsoft Excel).

CSV-formatted files can be stored in either a short-memory format or a long-memory format: Detail CSV, Fast CSV. The number of points that are saved depends on the record length settings.

Detail CSV will record both the horizontal and vertical sample points of the waveform. All the points are recorded in scientific notation for analog data.

Fast CSV will only record the vertical amplitude of the sample points. Fast CSV also contains data that enables the horizontal data points to be reconstructed, such as trigger position, etc. Data is recorded as integers.

Note, however, that only fast CSV can be recalled to the internal memory. Detailed CSV cannot be recalled.

Filename DSxxxx.csv

Waveform Type	CH1 ~4	Input channel signal
	Ref1~4	Reference waveform
	Math	Math operation result (page 66)
	All Displayed	All the waveforms on the display.

Contents: The following information is included in the Fast  
Fast CSV CSV waveform files, where applicable:

- Format (scope type)
- Input distance (input trigger distance)
- Trigger level
- Vertical units
- Vertical units extend div
- Probe type
- Vertical scale
- Horizontal units
- Horizontal position
- Sinc ET mode (sampling mode)
- Horizontal old scale
- Firmware
- Mode
- Memory length
- Trigger address
- Source
- Vertical units div
- Label
- Probe ratio
- Vertical position
- Horizontal scale
- Horizontal mode
- Sampling period
- Horizontal old position
- Time
- Raw vertical waveform data

Contents: Detail CSV waveform data contains channel  
Detail CSV information such as vertical and horizontal position of a signal for all the recorded points. The following information is included in Detail CSV, where applicable:

- Format (scope type)
- Input distance (input trigger distance)
- Trigger level
- Vertical units
- Memory length
- Trigger address
- Source
- Vertical units div

- Vertical units extend div
- Probe type
- Vertical scale
- Horizontal units
- Horizontal position
- Sinc ET mode (sampling mode)
- Horizontal old scale
- Firmware
- Mode
- Horizontal data
- Label
- Probe ratio
- Vertical position
- Horizontal scale
- Horizontal mode
- Sampling period
- Horizontal old position
- Time
- Raw vertical waveform data
- Vertical data

## Setup File Format

Format	DSxxxx.set (proprietary format)		
	The setup file saves or recalls the following settings.		
Contents	Acquire	<ul style="list-style-type: none"> <li>• Mode</li> <li>• Sample rate</li> <li>• XY</li> </ul>	<ul style="list-style-type: none"> <li>• Sample mode</li> <li>• Record Length</li> </ul>
	Display	<ul style="list-style-type: none"> <li>• Mode</li> <li>• Persistence</li> <li>• Waveform intensity</li> <li>• Graticule intensity</li> </ul>	<ul style="list-style-type: none"> <li>• Backlight intensity</li> <li>• Graticule</li> <li>• Backlight</li> <li>• Auto-dim</li> </ul>

Channel	<ul style="list-style-type: none"> <li>• Scale</li> <li>• Channel</li> <li>• Coupling</li> <li>• Impedance</li> <li>• Invert</li> <li>• Bandwidth</li> </ul>	<ul style="list-style-type: none"> <li>• Expand</li> <li>• Position</li> <li>• Probe</li> <li>• Probe attenuation</li> <li>• Deskew</li> </ul>
Cursor	<ul style="list-style-type: none"> <li>• Horizontal cursor</li> <li>• H Unit</li> </ul>	<ul style="list-style-type: none"> <li>• Vertical cursor</li> <li>• V Unit</li> </ul>
Measure	<ul style="list-style-type: none"> <li>• Source</li> <li>• Gating</li> <li>• Statistics</li> </ul>	<ul style="list-style-type: none"> <li>• Display</li> <li>• High-Low</li> <li>• Reference levels</li> </ul>
Horizontal	<ul style="list-style-type: none"> <li>• Scale</li> </ul>	
Math	<ul style="list-style-type: none"> <li>• Source1</li> <li>• Operator</li> <li>• Source2</li> </ul>	<ul style="list-style-type: none"> <li>• Position</li> <li>• Unit/Div</li> <li>• Math Off</li> </ul>
FFT Math	<ul style="list-style-type: none"> <li>• Source</li> <li>• Vertical Units</li> <li>• Window</li> </ul>	<ul style="list-style-type: none"> <li>• Vertical position</li> <li>• Horizontal position</li> </ul>
Advanced Math	<ul style="list-style-type: none"> <li>• Expression</li> <li>• VAR1</li> <li>• VAR2</li> </ul>	<ul style="list-style-type: none"> <li>• Position</li> <li>• Unit/Div</li> </ul>
Trigger	<ul style="list-style-type: none"> <li>• Type</li> <li>• Source</li> <li>• Coupling</li> <li>• Alternate</li> <li>• Rejection</li> <li>• Noise Rejection</li> </ul>	<ul style="list-style-type: none"> <li>• Slope</li> <li>• Level</li> <li>• Mode</li> <li>• Trigger When</li> <li>• Timer</li> <li>• Holdoff</li> </ul>



Utility	<ul style="list-style-type: none"><li>• Language</li><li>• Hardcopy key</li><li>• File Format</li></ul>	<ul style="list-style-type: none"><li>• Ink Saver</li><li>• Assign Save</li><li>• Probe Comp.</li></ul>
Save/ recall	<ul style="list-style-type: none"><li>• Image file format</li></ul>	<ul style="list-style-type: none"><li>• Data file format</li></ul>

## Create/Edit Labels

### Overview

Reference files, Setup files and the analog and digital input channels can have individual file labels set.

For the analog channels and reference waveforms, the file label can be displayed next to the channel/reference indicator.

The file labels are also used to easily identify reference files, setup files or channels when saving or recalling waveforms and setups.

### Example

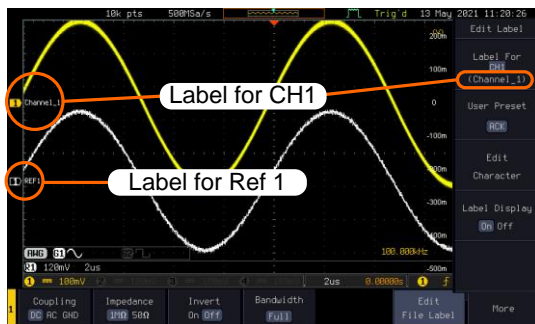

In the example above, the file label for channel 1 is displayed next to the channel indicator and is also displayed in the *Edit Label* menu. The Ref\_1 file label is shown next to the reference indicator.

### Panel Operation

1. Press the *Save/Recall* key from the front panel.
2. Press *Edit File Label* from the bottom menu.
3. Press *Label For* and select the item that you want to create the label for.

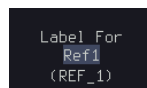
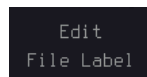
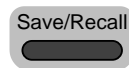

Label For CH1~CH4, Ref1~4, Set1~20, Math

- To choose a preset label, Press *User Preset* from the side menu and choose a label.



Labels ACK, AD0, ANALOG, BIT, CAS, CLK, CLOCK, CLR, COUNT, DATA, DTACK, ENABLE, HALT, INT, IN, IRQ, LATCH, LOAD, NMI

Edit Label

- Press *Edit Character* to edit the current label.

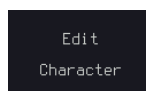

- The Edit Label window appears.



- Use the *VARIABLE* knob to highlight a character.



Press *Enter Character* to select a number or letter.

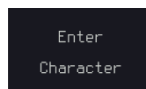

Press *Back Space* to delete a character.



Press *Save Now* to save the label and return to the previous menu.



To cancel the editing the label and return to the previous menu, press *Cancel*.



---

#### Display Label

To display the currently selected file label on the screen next to its respective indicator, toggle *Label Display* to On.

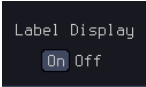

Conversely, if you want to remove the currently selected file label from the display, toggle *Label Display* to Off.

## Save

### File Type/Source/Destination

Item	Source	Destination
Panel Setup (DSxxxx.set)	<ul style="list-style-type: none"> <li>• Front panel settings</li> </ul>	<ul style="list-style-type: none"> <li>• Internal memory: Set1 ~ Set20</li> <li>• File system: Disk, USB</li> </ul>
Waveform Data (DSxxxx.csv) (DSxxxx.lsf) (CH1~CH2.lsf, Ref1~Ref4.lsf, Math.lsf)* ALLxxxx.csv	<ul style="list-style-type: none"> <li>• Channel 1 ~4</li> <li>• Math operation result</li> <li>• Reference waveform Ref1~4</li> <li>• All displayed waveforms</li> </ul>	<ul style="list-style-type: none"> <li>• Internal memory: Reference waveform Ref1~4, Wave1 ~ Wave20</li> <li>• File system: Disk, USB</li> </ul>

Display Image (DSxxxx.bmp/png)  
(Axxx1.bmp/png)\*\*

- Display image
- File system: Disk, USB

\* Stored in ALLXXXX directories when All Displayed waveforms are saved.

\*\* Stored in ALLXXXX directories when the Hardcopy key is assigned to save Waveform, Setup or All.



Note

By default all filenames/directories are named DSxxxx/ALLxxxx where xxxx is a number starting from 0001 and is incremented by one after each save.

## Save Image

Images can be saved either using the Save/Recall key or by using the Hardcopy key. To save images using the Hardcopy key, see the hardcopy section on page 373.

Panel Operation 1. To save to USB, connect a USB drive to the front panel USB port. If a USB drive is not connected, images can still be saved to the internal memory.

Front Panel

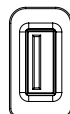

2. Press the *Save/Recall* key from the front panel.

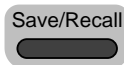

3. Press *Save Image* from the bottom menu.

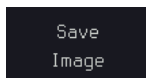

4. Press *File Format* to choose PNG or BMP file types.

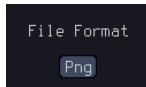

Range DSxxxx.bmp, DSxxxx.png

5. Press *Ink Saver* to toggle Ink Saver On or Off.

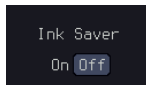

Ink Saver On

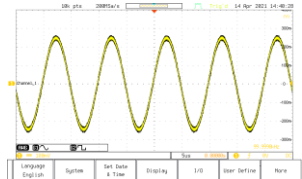

Ink Saver Off

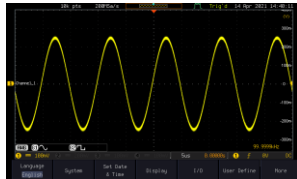

6. Press *Save* from the side menu to save the display as an image file.

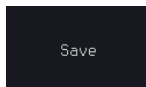

7. You will automatically be taken to a file utility where you will be able to edit the name of the file.
8. To edit the file name, use the *VARIABLE* knob to highlight a character.



Press *Enter Character* or the *Select* key to select a number or letter.

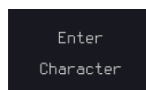

Press *Back Space* to delete a character.

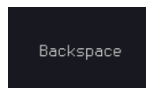

9. Press *Save Now* to save the file.  
The file name need not have been edited to save the file.

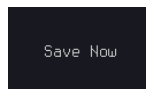

Note

Pressing *Cancel* will cancel the save operation and return you to the *Save/Recall* menu.

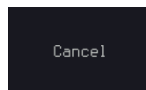

After *Save Now* has been pressed the file will be saved.

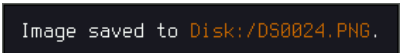

Note

The file will not be saved if the power is turned off or the USB drive is taken out before the message ends.

File Utility

To edit the internal memory or the USB flash drive contents (create/delete/rename files and folders) or to edit the default file path, press *File Utilities* from the side menu.

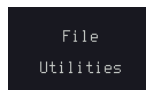

## Save Waveform

Panel Operation 1. To save to an external USB flash drive, connect the drive to the front panel USB port. If a USB drive is not connected, files can still be saved to the internal memory.

Front Panel

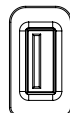

2. Press the *Save/Recall* key from the front panel.

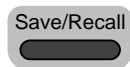

3. Press *Save Waveform* from the bottom menu.

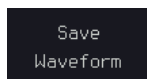

4. Choose the *From* waveform on the side menu.

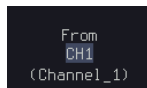



---

Source CH1~4, Math, Ref1~4, All Displayed

---

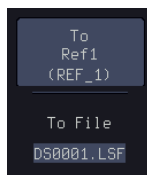
5. Press *To* (internal memory) or *To File* and choose a destination to save.



---

To Ref1~4, Wave1~20

---

To File Format: LSF, Detail CSV, Fast CSV

---

6. Press *Save* to save the file.

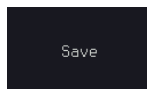

7. If you are saving to a file, a file utility appears where you will be able to edit the name of the file from the default "DSXXX" filename.

8. To edit the filename, use the *VARIABLE* knob to highlight a character.



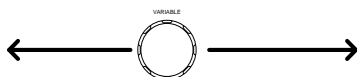

```

AB C DEFGHI JKLMNOPQRSTUVWXYZ
abcde fghi jklmnopqrstuvwxyz
. 0123456789- _
    
```

Press *Enter Character* or the *Select* key to select a number or letter.

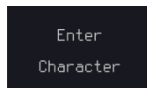

Press *Back Space* to delete a character.

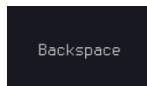

9. Press *Save Now* to save the file. The filename need not have been edited to save the file.



Note

Pressing *Cancel* will cancel the save operation and return you to the *Save/Recall* menu.

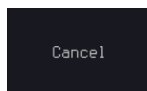

After *Save Now* has been pressed the file will be saved.

```

Waveform saved to Disk:/DS0002.CSV.
    
```



Note

The file will not be saved if the power is turned off or the USB drive is taken out before the message ends.

File Utility

To edit the internal memory or the USB flash drive contents (create/delete/rename files and folders), press *File Utilities*.

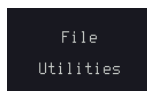

## Save Setup

Panel Operation 1. To saving to an external USB flash drive connect the drive to the front or rear panel USB port. If a USB drive is not connected, files can be saved to the internal memory.

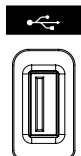

2. Press the *Save/Recall* key from the front panel.

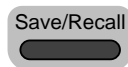

3. Press *Save Setup* from the bottom menu.

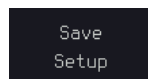

4. Press *To* (internal memory) or *To File* and choose a destination to save to.

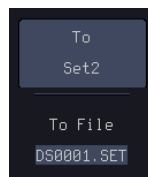

---

To                      Set1~Set20

---

To File                DSxxxx.set

---

5. Press *Save* to confirm saving. When completed, a message appears at the bottom of the display.



6. If you are saving to a file, a file utility appears where you will be able to edit the name of the file from the default "DSxxxx" filename.

7. To edit the filename, use the *VARIABLE* knob to highlight a character.

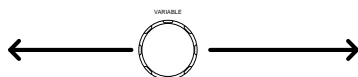

```

AB CDEFGHI JKLMNOPQRSTUVWXYZ
abcdefghijklmnopqrstuvwxyz
.0123456789- _
    
```

Press *Enter Character* or the *Select* key to select a number or letter.

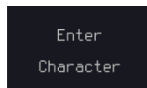

Press *Back Space* to delete a character.

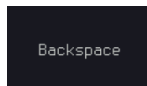

8. Press *Save Now* to save the file. The filename need not have been edited to save the file.

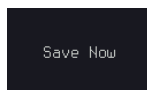

Note

Pressing *Cancel* will cancel the save operation and return you to the *Save/Recall* menu.

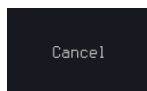

After *Save Now* has been pressed the file will be saved.

```

Waveform saved to Disk: /DS0002.CSV.
    
```



Note

The file will not be saved if the power is turned off or the USB drive is taken out before the message ends.

File Utility

To edit the internal memory or the USB flash drive contents (create/ delete/ rename files and folders) or to set the file path, press *File Utilities*.

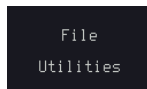

Edit Label

To edit labels for Setup files, press *Edit Label*. For more details on editing labels, see page 348.

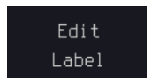

## Recall

### File Type/Source/Destination

Item	Source	Destination
Default Panel Setup	<ul style="list-style-type: none"> <li>Factory installed setting</li> </ul>	<ul style="list-style-type: none"> <li>Current front panel</li> </ul>
Reference Waveform	<ul style="list-style-type: none"> <li>Internal memory: Ref1~4</li> </ul>	<ul style="list-style-type: none"> <li>Current front panel</li> </ul>
Panel Setup (DSxxxx.set)	<ul style="list-style-type: none"> <li>Internal memory: S1 ~ S20</li> <li>File system: Disk, USB</li> </ul>	<ul style="list-style-type: none"> <li>Current front panel</li> </ul>
Waveform Data (DSxxxx.lsf, DSxxxx.csv**, (CH1~CH4.lsf, Ref1~Ref4.lsf, Math.lsf)*	<ul style="list-style-type: none"> <li>Internal memory: Wave 1 ~ Wave20</li> <li>File system: Disk, USB</li> </ul>	<ul style="list-style-type: none"> <li>Reference waveform 1 ~ 4</li> </ul>

\*Recalled from ALLXXX directories. Note that Allxxxx.csv cannot be recalled to the oscilloscope.

\*\*Detail CSV files cannot be recalled to the oscilloscope.

### Recall Default Panel Setting

Panel Operation 1. Press the *Default* key.

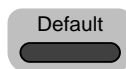

2. The screen will update with the default panel settings.

Setting Contents The following is the default (factory) setting contents.

Acquire Mode: Sample XY: OFF

	Record Length: 10k	Expand: By Center
Display	Mode: Vector	Persistence: 240ms
	Waveform intensity: 50%	Graticule intensity: 50%
	Backlight Intensity: 80%	Backlight Auto-dim: On
	Time: 10min	Graticule: full 
Channel	Scale: 100mV/Div	CH1: On
	Coupling: DC	Impedance: 1MΩ
	Invert: Off	Bandwidth: full
	Expand: By Ground	Position: 0.00V
	Probe: Voltage	Probe attenuation: 1x
	Deskew: 0s	
Cursor	Horizontal cursor: Off	Vertical Cursor: Off
Measure	Source: CH1	Gating: Screen
	Display All: Off	High-Low: Auto
	Statistics: Off	Mean & Std Dev
		Samples: 2
	High Ref: 90.0%	Mid Ref: 50.0%
	Low Ref: 10.0%	
Horizontal	Scale: 10us/Div	Position: 0.000s
Math	Source1: CH1	Operator: +
	Source2: CH2	Position: 0.00 Div
	Unit/Div: 200mV	Math Off
FFT	Source: CH1	Vertical Units: dB
		RMS
	Window: Hanning	Vertical: 20dB
	Horizontal: 5MHz/div	
Advanced Math	Expression: CH1+CH2	VAR1: 0
	VAR2: 1	Position: 0.00Div

	Unit/div: 500mV	
APP	App: Go-NoGo, DVM, Datalog, Mount Remote Disk	
Trigger	Type: Edge	Source: CH1
	Coupling: DC	Alternate: Off
	Noise Rejection: Off	Slope: Positive
	Level: 0.00V	Mode: Auto
	Holdoff: 10.0ns	
Utility	Hardcopy: Save	Ink Saver: Off
	Assign Save To: Image	File Format: Bmp
	Probe Comp.: 1kHz	

## Recall Waveform

---

Panel Operation 1. For recalling from an external USB Front Panel flash drive, connect the drive to the front or rear panel USB port.

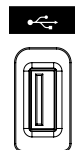

2. The waveform must be stored in advance. See page 354 for waveform store details.
3. Press the *Save/Recall* key.

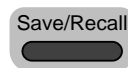

4. Press *Recall Waveform* from the bottom menu. The Recall menu appears.

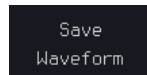

5. Press *From* (internal memory) or *From File* and choose a source to recall from.

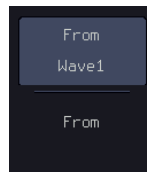

From Wave1~20

From File\* File format: Lsf, Fast Csv

\* Only files in the current file path will be available, this includes files saved in the ALLxxx directories.

Allxxx.csv files cannot be recalled to the oscilloscope.

Only the "Fast CSV", "LSF" files can be recalled to the oscilloscope.

6. Press *To* and select the reference waveform to recall to.

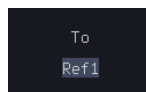

To Ref1~4

7. Press *Recall Now* to recall the waveform. The reference waveform will appear on the screen when successful.

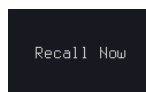

**File Utility**

To edit USB flash drive contents (create/ delete/ rename files and folders) or to set the file path, press *File Utilities*.

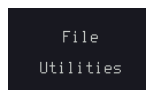

**Recall Setup**

**Panel Operation**

1. (For recalling from an external USB flash drive) Connect the drive to the front or rear panel USB port.

Front Panel

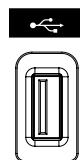

2. Press the *Save/Recall* key.

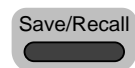

3. Press *Recall Setup* from the bottom menu.

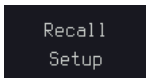

4. Press *From* (internal memory) or *From File* and choose a source to recall from.

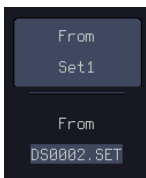

---

From      Set1~20

---

From File    DSxxxx.set (USB, Disk)\*

---

\* Only files in the current file path will be available.

5. Press *Recall Now* to confirm recalling. When completed, a message appears at the bottom of the display.

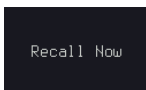

**Note** The file will not be recalled if the power is turned off or the USB drive is taken out before the message appears.

**File Utility**

To edit the internal memory or the USB flash drive contents (create/ delete/ rename files and folders) or to set the file path, press *File Utilities*.

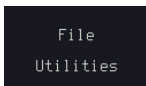

**Edit Label**

To edit labels for Setup files, press *Edit label*. For more details on editing labels, see page 348.

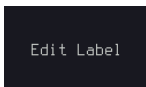



# Reference Waveforms

## Recall and Display Reference Waveforms

**Panel Operation** A reference waveform must be stored in advance. See page 354 to store waveforms as reference waveforms.

1. Press the REF key on the front panel.



2. Pressing R1~R4 repeatedly will toggle the corresponding reference waveform OFF/ON.

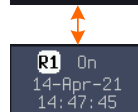
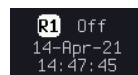

Turning R1~R4 ON will open the corresponding reference menu.

3. If a reference waveform is ON but not active, its reference menu can be opened by pressing the corresponding R1~R4 key from the bottom menu.

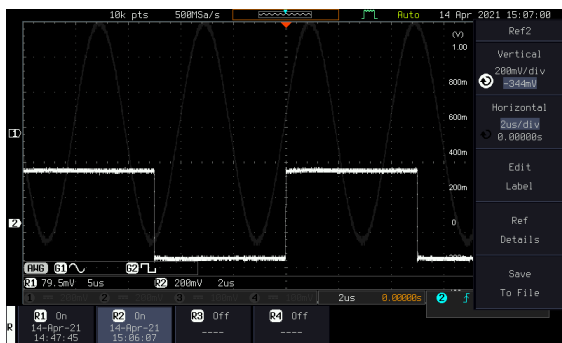
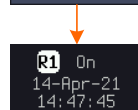
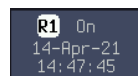

**Vertical Navigation** Press *Vertical* repeatedly from the side menu to choose to edit the vertical position or Unit/Div. Use the *VARIABLE* knob to edit the values.

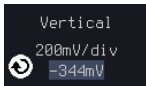

**Horizontal Navigation** Press *Horizontal* repeatedly from the side menu to choose to edit the Time/Div or the horizontal position. Use the *VARIABLE* knob to edit the value.

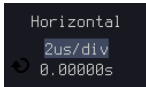

**View Reference Waveform Details** Pressing *RefDetails* will display the reference waveform details.

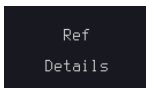

Details      Sample Rate, Record Length, Date

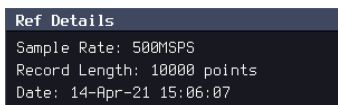

**Edit Labels** To edit labels for Setup files, press *Edit Labels*. For more details on editing labels, see page 348.

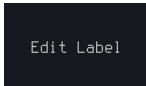

**Save Reference Waveforms** To save reference waveforms, press *Save to File*. For more details on saving waveforms, see page 354.

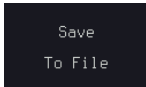

# FILE UTILITIES

The file utilities are used each time files need to be saved to internal or external memory. The file utilities can create, delete and rename directories or files as well as copy files from internal memory to USB. The File Utilities menu also sets the file path for saving and recalling files from the Save/Recall menu.

---

File Navigation.....	366
Create Folder.....	367
Rename File.....	368
Delete File or Folder.....	370
Copy File to USB.....	371

## File Navigation

The File Utilities menu can be used to choose files or to set the file path for saving/recalling files.

### File System

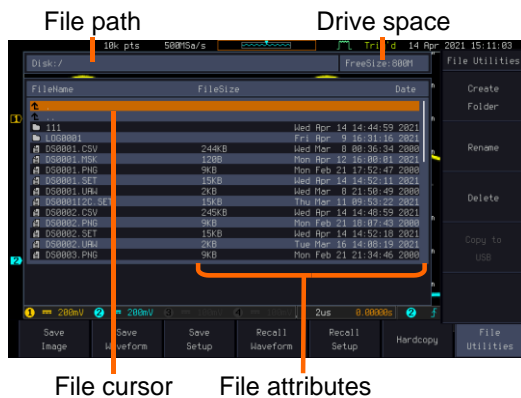

### Panel Operation

1. Press the *Save/Recall* key.

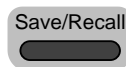

2. Press *File Utilities* from the bottom menu.

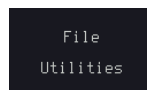

3. The file system appears.

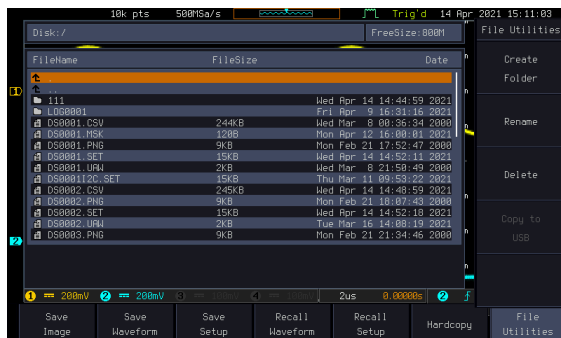

- Use the *VARIABLE* knob to move the file cursor up and down.

VARIABLE

Use the *Select* key to choose a file or directory or to set the file path.

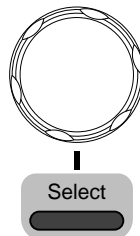

Note

When a USB flash drive is used, the file path is remembered each time the USB flash drive is used. This saves you the hassle of setting the USB file path each time the USB flash drive is inserted into the scope.

## Create Folder

- Panel Operation
- Press the *Save/Recall* key.

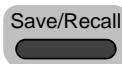

- Press *File Utilities* from the bottom menu.

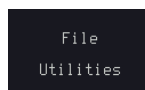

- Use the *VARIABLE* knob and *Select* key to navigate the file system. The preview thumbnail will be shown in the lower-right corner if the data selected by user refers to image.

VARIABLE

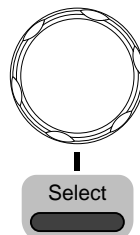

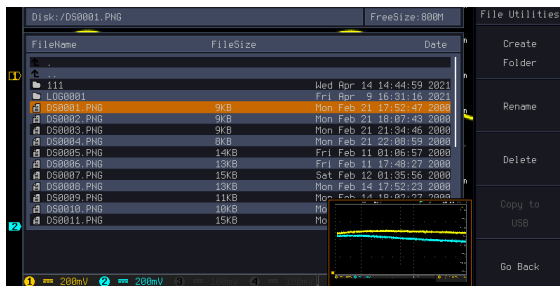

Create Folder

4. Press *Create Folder* to make a new directory at the selected location.

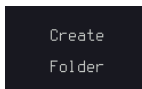

5. Use the *VARIABLE* knob to highlight a character.



Press *Enter Character* or the *Select* key to select a number or letter.

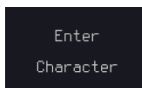

Press *Back Space* to delete a character.

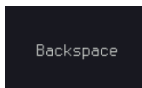

6. Press *Save Now* to create the folder.

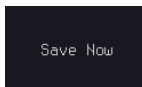

Cancel

Press *Cancel* to cancel the operation.



## Rename File

Panel Operation 1. Press the *Save/Recall* key.

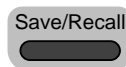

2. Press *File Utilities* from the bottom menu.

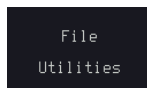

3. Use the *VARIABLE* knob and *Select* key to choose a file to rename.

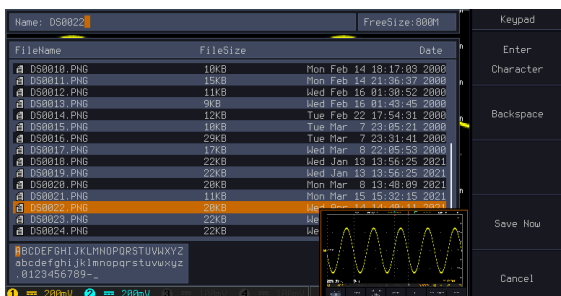
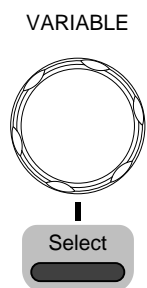

4. Press *Rename* when a file is chosen.

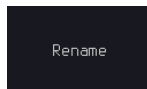

5. Use the *VARIABLE* knob to highlight a character.

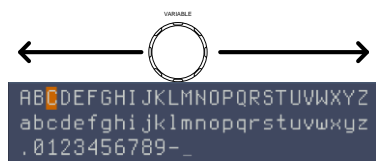
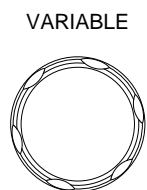

Press *Enter Character* or the *Select* key to select a number or letter.

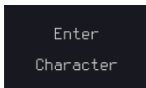

Press *Back Space* to delete a character.

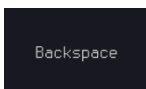

6. Press *Save Now* to rename the folder or file.

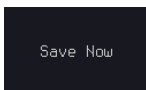

## Delete File or Folder

Panel Operation

1. Press the *Save/Recall* key.

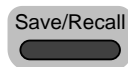

2. Press *File Utilities* from the bottom menu.

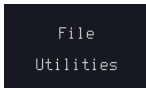

3. Use the *VARIABLE* knob and *Select* key to navigate the file system to choose a file.

VARIABLE



Select

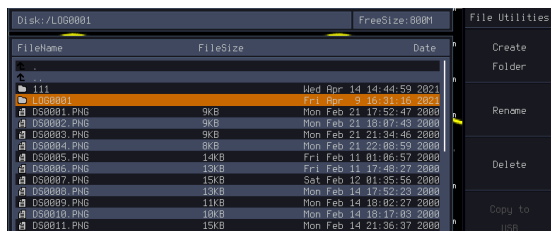
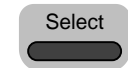

4. Press *Delete* to delete the selected file.





5. Press *Delete* again to confirm the deletion.

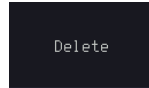

## Copy File to USB

Panel Operation

1. Connect a USB drive to the front panel USB port.

Front Panel

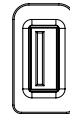

2. Press the *Save/Recall* key.

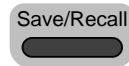

3. Press *File Utilities* from the bottom menu.

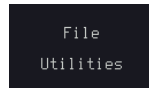

4. Use the *VARIABLE* knob and *Select* key to navigate the file system to choose a file from internal memory.

VARIABLE

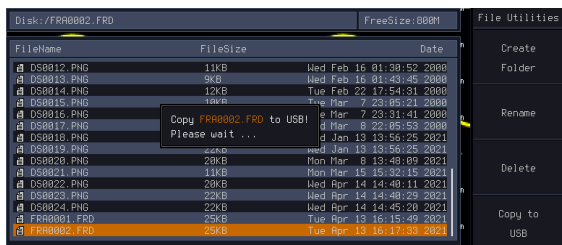
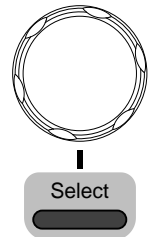

5. Press *Copy to USB* to copy the selected file to the USB drive.

A dark rectangular button with the text "Copy to" on the top line and "USB" on the bottom line, both in a light gray font.**Note**

If the same file name already exists on the USB drive, it will be copied over.



# HARDCOPY KEY

The Hardcopy key is used as quick-save. The Hardcopy key can be used to save a screen shot, a waveform, or the current setup.

## Save - Hardcopy Key

---

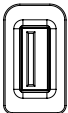
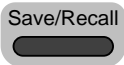
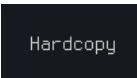
**Background** When the Hardcopy key is assigned to “Save”, pressing the Hardcopy key can be used to save a screen shot, a waveform, or the current setup, depending on the configuration.

- |                        |  |  |
|------------------------|--|--|
| <b>Panel Operation</b> | <ol style="list-style-type: none"> <li>1. If you wish to save to USB, connect a USB drive to the front panel USB port, otherwise the file will save to internal memory.</li> </ol> | <p>Front Panel</p>   |
|                        | <ol style="list-style-type: none"> <li>1. Press the <i>Save/Recall</i> key.</li> </ol>   |    |
|                        | <ol style="list-style-type: none"> <li>2. Press <i>Hardcopy</i> from the bottom menu.</li> </ol>   |   |
|                        | <ol style="list-style-type: none"> <li>3. Press <i>Assign Save To</i> and select which type of file will be saved when the Hardcopy key is pressed.</li> </ol>                     |   |

File Type: Image, Waveform, Setup, All

4. Press the *Hardcopy* key to save the file\*.



A message will appear when the save is successful.

Image saved to Disk:/DS0025.PNG.

Image File Format

5. For image files the file format can be selected with the *File Format* key.

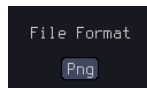

Format      BMP, PNG

Ink Saver

6. To have a white background for image files, set *Ink Saver* to On.

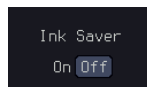

**Ink Saver On**

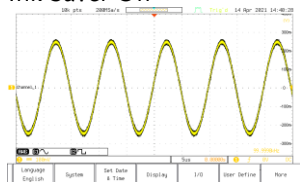

**Ink Saver Off**



Note

\*Each time the *Hardcopy* key is used to save waveforms or setup files, the files are saved into a new directory. The save directory is labeled ALLXXXX, where XXXX is a number that is incremented with each save. This directory is created in either the internal memory or to a USB flash drive.

# REMOTE CONTROL CONFIG

This chapter describes basic configuration for remote control. For a complete command list, refer to the programming manual downloadable from GW Instek website, [www.gwinstek.com](http://www.gwinstek.com).

---

Interface Configuration .....	376
Configure USB Interface.....	376
Configure the Ethernet Interface .....	377
Configure RS-232C Interface .....	380
Configure Socket Server.....	382
Socket Server Functionality Check.....	383
Web Server.....	388
Web Server Overview.....	388

## Interface Configuration

### Configure USB Interface

USB Configuration	PC side connector	Type A, host
	GDS-3000A side connector	Type B, device
	Speed	1.1/2.0
	USB Class	USBTMC 488.2 class device for remote connectivity

Panel Operation 1. Press the *Utility* key.

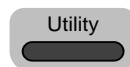

2. Press *I/O* from the bottom menu.



3. Rotate the *VARIABLE* knob to select the *USB Device Port* function.

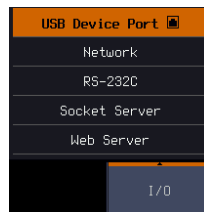

4. Select *Computer* from the side menu.



- This oscilloscope is a USB-TMC device. Please install the National Instruments NI-VISA library which can download from the National Instruments web site. Newer versions are likely, and should be compatible with this instrumentation. Download the latest version available for the operating system being used by the controlling computer.



### Configure the Ethernet Interface

Ethernet Configuration

MAC Address	Domain Name
Instrument Name	DNS IP Address
User Password	Gateway IP Address
Instrument IP Address	Subnet Mask

Background

The Ethernet interface is used for remote control using a socket server connection. For details, please see the Socket Server section on page 377.

Panel Operation

- Connect the Ethernet cable to the LAN port on the rear panel.
- Press the *Utility* key.
- Press *I/O* from the bottom menu.

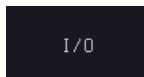
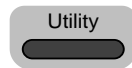

4. Rotate the *VARIABLE* knob to select the *Network* function.

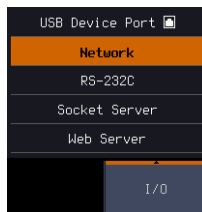

5. Press Ethernet from the side menu

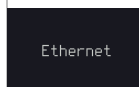

6. Set DHCP/BOOTP to On or Off from the side menu.

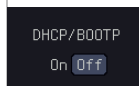

Note

IP addresses will automatically be assigned with DHCP/BOOTP set to on. For Static IP Addresses, DHCP/BOOTP should be set to off.

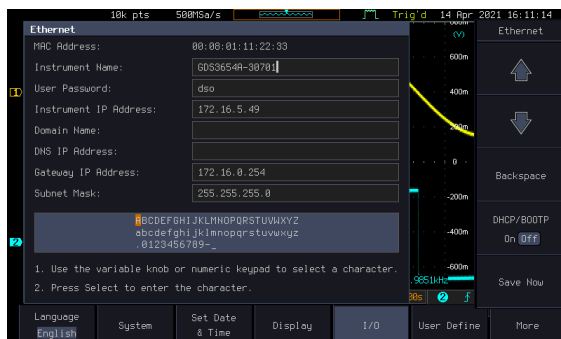

7. Use the Up and Down arrows on the side menu or use the numerical keypad on front panel to navigate to each Ethernet configuration item.





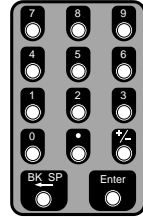



---

Items      MAC Address, Instrument Name, User Password, Instrument IP Address, Domain Name, DNS IP Address, Gateway IP Address, Subnet Mask

---

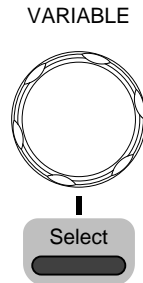
8. Use the *VARIABLE* knob to highlight a character and use the *Select* key to choose a character.



Press *Backspace* to delete a character.

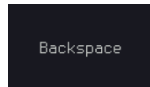

Press *Save Now* to save the configuration. Complete will be displayed when successful.

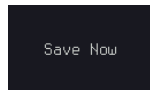

## Configure RS-232C Interface

RS-232C Configuration	Connector	DB-9, Male
	Baud rate	2400, 4800, 9600, 19200, 38400, 57600, 115200
	Parity	None, Odd, Even
	Data bit	8 (fixed)
	Stop bit	1, 2

Panel Operation 1. Press the *Utility* key.

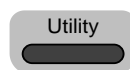

2. Press *I/O* from the bottom menu.



3. Rotate the *VARIABLE* knob to select the *RS-232C* function.

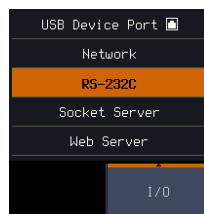

4. Use the side menu to set the Baud Rate.



Baud Rate 2400, 4800, 9600, 19200, 38400, 57600, 115200

5. Press *Stop Bit* to toggle the number of stop bits.



Stop Bits 1, 2

6. Press *Parity* to toggle the parity.

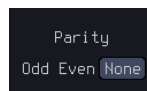

Parity Odd, Even, None

7. Press *Save Now* to save the settings.

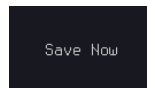

8. Connect the RS-232C cable to the rear panel port: DB-9 male connector.



Pin Assignment

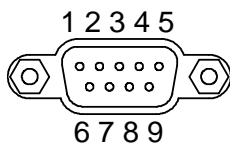

- 2: RxD (Receive data)
- 3: TxD (Transmit data)
- 5: GND
- 4, 6 ~ 9: No connection

PC Connection

Use the Null Modem connection as in the below diagram.

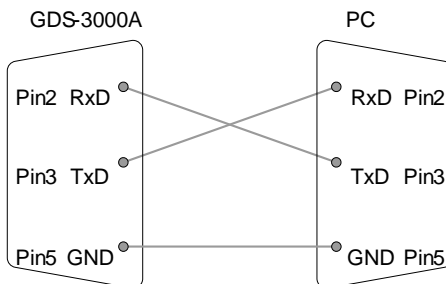

## Configure Socket Server

The GDS-3000A supports socket server functionality for direct two-way communication with a client PC or device over LAN. By default, the Socket Server is off.

Configure Socket Server 1. Configure the IP address for the GDS-3000A. Page 377

2. Press the *Utility* key.

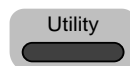

3. Press *I/O* from the bottom menu.



4. Rotate the *VARIABLE* knob to select the *Socket Server* function.

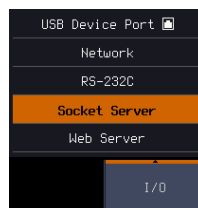

5. Press *Select Port* and choose the port number with the *VARIABLE* knob.



Range 1024~32767

6. Press *Set Port* to confirm the port number.

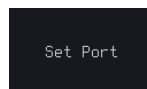

7. The Current Port icon will update to the new port number.

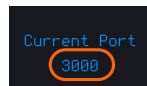

8. Press *Server* and turn the socket server On.

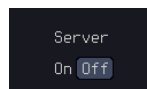

## Socket Server Functionality Check

NI Measurement and Automation Explorer To test the socket server functionality, National Instruments Measurement and Automation Explorer can be used. This program is available on the NI website, [www.ni.com](http://www.ni.com).

- |           |  |   |
|-----------|--|---|
| Operation | 1. Configure the IP address for the GDS-3000A.   | Page 377  |
|           | 2. Configure the socket port.  | Page 377  |
|           | 3. Start the NI Measurement and Automation Explorer (MAX) program. Using Windows, press: |  |

Start>All Programs>National Instruments>Measurement & Automation



4. From the Configuration panel access;  
My System>Devices and Interfaces>Network Devices
5. Right click Network Devices and select Create New Visa TCP/IP Resource...

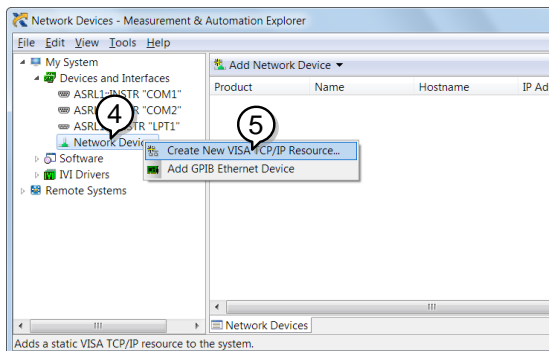

6. Select *Manual Entry of Raw Socket* from the popup window.
7. Click *Next*.

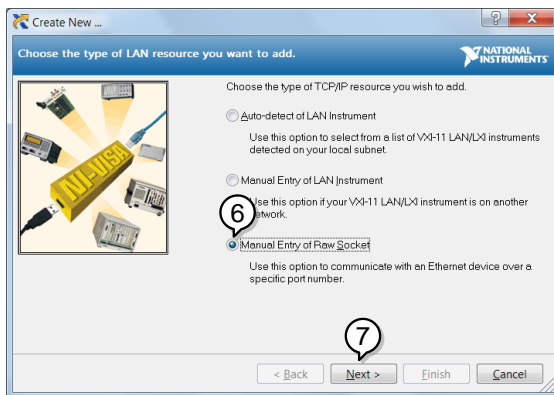

8. Enter the GDS-3000A's IP address and socket port number.
9. Click *Validate*.
10. A popup will appear to tell you if a VISA socket session was successfully created.
11. Click *Next*.

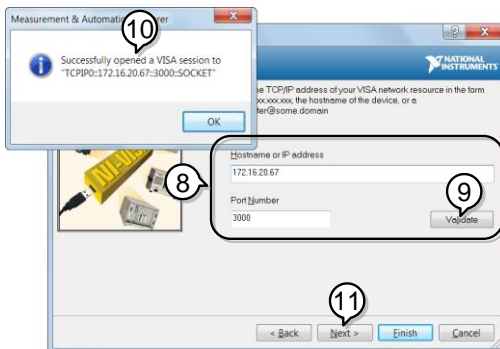

12. Choose an alias for the socket connection if you like.

13. Click *Finish* to finish the configuration.



14. The GDS-3000A will now appear under Network Devices in the Configuration Panel.

Functionality Check

15. Click the *Open Visa Test Panel* to send a remote command to the GDS-3000A.

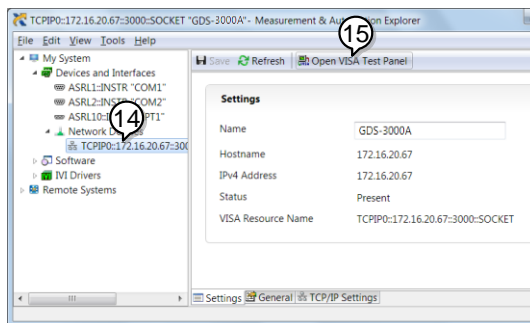

16. Click on the *Configuration* icon.

17. Select the *I/O Settings* tab.

18. Mark the *Enable Termination Character* checkbox. Make sure the termination character is a line feed (/n, value: xA).

19. Click Apply Changes.

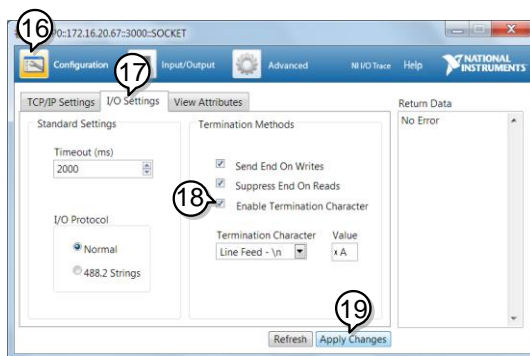

20. Click the *Input/Output* icon.

21. Make sure the *\*IDN?* query is selected in the *Select or Enter Command* drop box.

22. Click on *Query*.

23. The manufacturer, model number, serial



number and firmware version will be displayed in the buffer. For example:  
 GW-INSTEK, GDS-3652A,PXXXXXX,V1.00



Note

For further details about remote control and remote commands, please see the programming manual.

# Web Server

## Web Server Overview

**Background**      The GDS-3000A has an inbuilt web server that can be used to:

- view the system information (Welcome Page)
- set/view the network configuration settings (Network Configuration)
- remotely view the current display image on the unit (Get Display Image)
- execute SCPI command
- send the internal profile of oscilloscope to PC side or receive profile
- Web control function: control oscilloscope remotely from browser and display waveform in real-time

**System Information:**

- Manufacturer
- Serial Number
- Firmware version
- Hostname
- Domain name
- IP Address
- Subset Mask
- DNS
- MAC Address
- DHCP State



System Information	
Manufacturer	GW
Serial Number	P006701
Description	GW-GDS-3000A
Firmware Version	V0.65.0407
Hostname	GDS3000A-30701
mDNS Hostname	GDS3000A-30701.local
IP Address	172.16.5.49
Subnet Mask	255.255.255.0
Gateway	172.16.0.254
DNS	
MAC Address	00:08:01:11:22:33
DHCP State	OFF
VISA TCP/IP Connect String	TCP/IP: 172.16.5.49:2268::SOCKET

Network Configuration

- Hostname
- Domain name
- IP Address
- Subnet mask
- Gateway
- DNS
- DHCP State

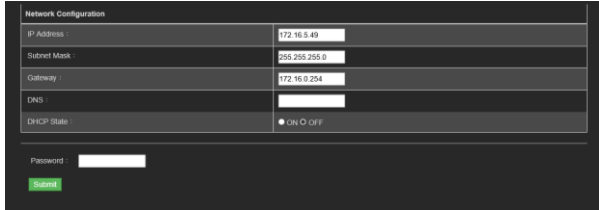

Get Display Image

- Current display image



File Exchange

Upload or download profile (\*.set) to oscilloscope Web

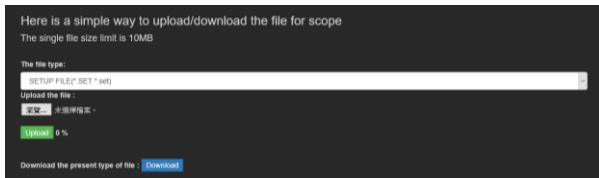

SCPI command

Control oscilloscope remotely from browser via executing SCPI command

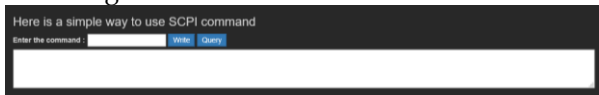

Web control

Control oscilloscope remotely from browser via graphical user interface (GUI) to display real-time waveform

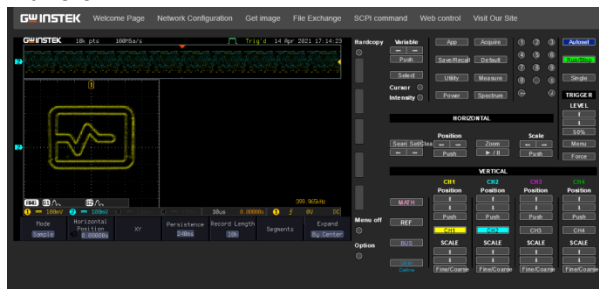

- Panel Operation
1. Configure the Ethernet interface. Page 377
  2. Enter the IP address of the GDS-3000A unit into the address bar of a web browser.

For example <http://172.16.20.255>

3. Press *I/O* from the bottom menu.

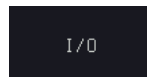

4. Rotate the *VARIABLE* knob to select the *Web Server* function.

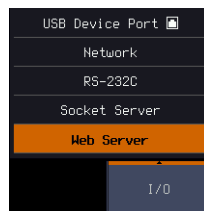

5. Press the *Connect* button in the side menu to connect to internet.



6. The "ONLINE" will be shown for web server when internet connection is established.



7. The GDS-3000A web browser welcome page appears.

**GW INSTEK**

[Welcome Page](#) | 
 [Network Configuration](#) | 
 [Get Image](#) | 
 [File Exchange](#) | 
 [SCPI command](#) | 
 [Web control](#) | 
 [Visit Our Site](#)

### GDS-3000A Series Web Browser Pages

Thanks For Your Using.

Use the left menu to select the features you need.

More How-to  
Please refer to user manual.



System Information	
Manufacturer :	GW
Serial Number :	P930701
Description :	GW-GDS-3654A
Firmware Version :	V0.65.0407
Hostname :	GDS3654A-30701
mDNS Hostname :	GDS3654A-30701.local
IP-Address :	172.16.5.49
Subnet Mask :	255.255.255.0
Gateway :	172.16.0.254
DNS :	
MAC Address :	00:08:01:11:22:33
DHCP State :	OFF
VISA TCP/IP Connect String :	TCPIP6-172.16.5.49:2268-SOCKET

Copyright 2020 © Good Will Instrument Co., Ltd All Rights Reserved.

# M AINTENANCE

Three types of maintenance operations are available: Signal Path Compensation, Vertical Accuracy Calibration and Probe Compensation. Run these operations when using the GDS-3000A in a new environment.

---

How to use the SPC function.....	393
Vertical Accuracy Calibration.....	393
Probe Compensation .....	395

## How to use the SPC function

---

**Background** Signal Path Compensation (SPC) is used to compensate the internal signal path due to ambient temperature. SPC is able to optimize the accuracy of the oscilloscope with respect to the ambient temperature.

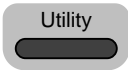
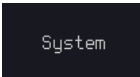
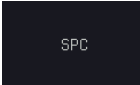
- Panel Operation**
1. Press the *Utility* key. 
  2. Press *System* from the bottom menu. 
  3. Press *SPC* from the side menu. A message showing a brief introduction to SPC appears on the screen. 



Note

Disconnect all probes and cables from all channels before calibrating.

The DSO needs to be warmed up for at least 30 minutes before using the SPC function.

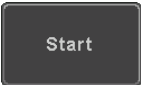
4. Press *Start* on the side menu to start SPC calibration. 
5. The SPC Calibration will proceed one channel at a time, from channel 1 to channel 4.

## Vertical Accuracy Calibration

---

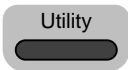
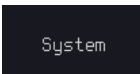
- Panel Operation**
1. Press the *Utility* key. 
  2. Press *System* from the bottom menu. 

3. Press *more 1 of 3* from the side menu.

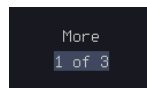

4. Press *Self Cal* on the side menu.

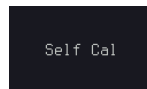

5. Press *Vertical* on the side menu.

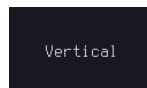

6. A message appears to “Now performing vertical calibration...  
CH1  
Connect the CAL output to channel, then press the Vertical key”.

7. Connect the calibration signal from the rear panel to the Channel 1 input with a BNC cable.

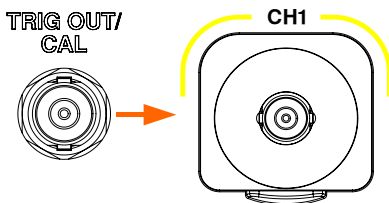

8. Press *Vertical* again after connecting CAL to the channel 1 input.

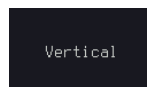

The calibration for Channel 1 starts and ends automatically, in less than 5 minutes. A message is displayed when the calibration procedure has ended.

Repeat the above step for Channel 2, 3\* and 4\* when prompted.

\*4 channel models



- When the calibration for all channels has completed, the display goes back to the default state.

## Probe Compensation

- Panel Operation
- Connect the probe between the Channel 1 input and the probe compensation output (default set as 2V<sub>p-p</sub>, 1kHz square wave) on the front panel. Set the probe attenuation to x10.
  - Alternatively, the probe compensation frequency can be changed. See page 187 for details.

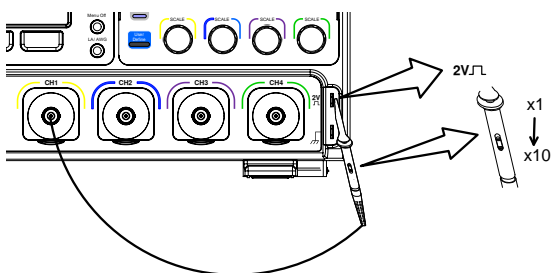

- Press the *CH1* key to activate CH1.
- Set the *Coupling* to DC from the bottom menu.
- Set the Probe attenuation to *Voltage, 10X*.
- Press the *Autoset* key. The compensation signal appears on the display.

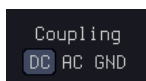
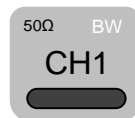

Page 112

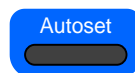

- Press the UTILITY key followed by pressing the DISPLAY button in the bottom menu, then set the display type to Vector.



- Turn the adjustment point on the probe to make the waveform as square as possible.

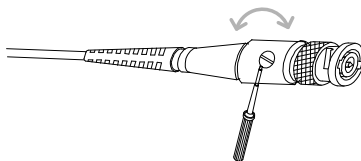
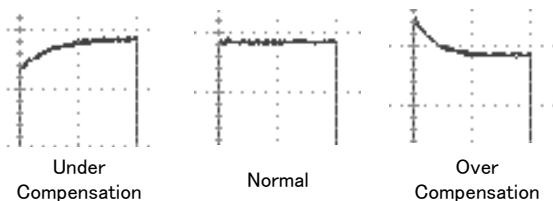

# F AQ

---

- I connected the signal but it does not appear on the display.
- I want to remove the (Measurement result/ FFT result/ Help contents) from the display.
- The waveform does not update (frozen).
- The probe waveform is distorted.
- Autoset does not catch the signal well.
- The date and time settings are not correct.
- The accuracy does not match the specification.

## I connected the signal but it does not appear on the display.

---

Make sure you have activated the channel by pressing the Channel key (the channel key lights up).

## I want to remove the (Measurement result/ FFT result/ Help contents) from the display.

---

To clear automatic measurement results, press the Measure key, select Remove Measurement and choose Remove All. See page 49.

To clear individual measurements from the screen, press the Measure key, select Display All and choose Off. See page 53.

To clear the FFT result, press the Math key twice. See page 66 for details.

To clear the Help result, press the Help key again. See page 35 for details.

The waveform does not update (frozen).

---

Press the Run/Stop key to unfreeze the waveform. See page 39 for details.

If this does not help, the trigger mode might be set to Single. Press the Single key to exit Single mode. See page 141 for Single trigger details.

The probe waveform is distorted.

---

You might need to compensate the probe. For details, see page 395.

Autoset does not catch the signal well.

---

The Autoset function cannot catch signals under 10mV or 20Hz. Please use the manual operation. See page 38 for Autoset details.

The date and time settings are not correct.

---

For date and time setting details, please see page 185. If it does not help, the internal battery controlling the clock might be worn out. Contact your dealer or GW Instek.

The accuracy does not match the specification.

---

Make sure the device is powered on for at least 30 minutes, within +20°C~+30°C. This is necessary to stabilize the unit to match the specification.

For more information, contact your local dealer or GW Instek at [www.gwinstek.com](http://www.gwinstek.com) / [marketing@goodwill.com.tw](mailto:marketing@goodwill.com.tw).

# **A**PPENDIX

---

Updating the Firmware .....	400
GDS-3000A Series Specifications .....	402
Model-specific .....	402
Common .....	402
Probe Specifications .....	409
Model-specific Probe Specifications .....	409
Common Probe Specifications .....	409
Dimensions .....	410
Certificate Of Compliance .....	411

## Updating the Firmware

**Background** New firmware can be downloaded from the our website in the oscilloscope products section.

Place a copy of the firmware file (xxx.upg) onto the root directory of a USB flash disk.

**Panel Operation** 1. Put the USB drive that contains the firmware into the front panel USB port.

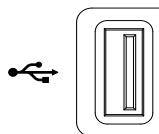

2. Power up the oscilloscope and at the same time, rotating the *VARIABLE* knob several times until the oscilloscope boot in the firmware upgrade mode as in the snapshot below.

VARIABLE

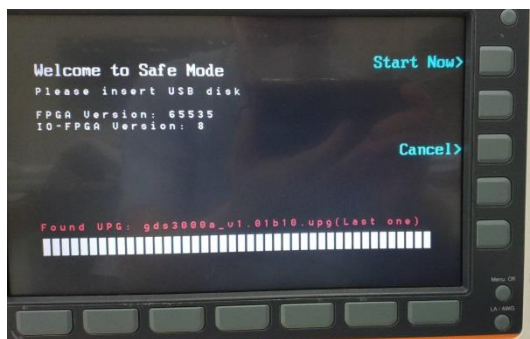
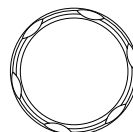

3. When the firmware file of USB flash disk has been recognized by oscilloscope, a message of “Found UPG: xxx.upg” will appear on the lower corner.

4. Press the "Start Now" (F1) key. The oscilloscope will automatically start upgrading the firmware. Or press the "Cancel" (F3) key to quit the firmware upgrading procedure.

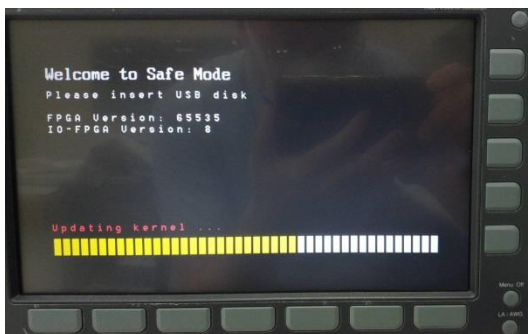

5. When the status indicator shows the complete status (status indicator in yellow completely) and a message of "Update NAND flash success" will appear on the top of status indicator. The firmware upgrading procedure is completed.



6. Restart the oscilloscope manually. Check the firmware version by pressing the "Utility" → "System" → "System Info". The system information screen that it is being updated.

## GDS-3000A Series Specifications

The specifications apply when the GDS-3000A series is powered on for at least 30 minutes under +20°C~+30°C.

### Model-specific

GDS-3352A	Channels	2 + Ext
	Bandwidth	DC ~ 350MHz (-3dB) @50Ω/1MΩ input impedance
	Rise Time	1ns (calculated)
	Bandwidth Limit	20MHz/100MHz/200MHz*
GDS-3652A	Channels	2 + Ext
	Bandwidth	DC ~ 650MHz (-3dB) @50Ω input impedance DC ~ 500MHz (-3dB) @1MΩ input impedance
	Rise Time	535ps (calculated)
	Bandwidth Limit	20MHz/100MHz/200MHz/300MHz*
GDS-3354A	Channels	4 + Ext
	Bandwidth	DC ~ 350MHz (-3dB) @50Ω/1MΩ input impedance
	Rise Time	1ns (calculated)
	Bandwidth Limit	20MHz/100MHz/200MHz*
GDS-3654A	Channels	4 + Ext
	Bandwidth	DC ~ 650MHz (-3dB) @50Ω input impedance DC ~ 500MHz (-3dB) @1MΩ input impedance
	Rise Time	535ps (calculated)
	Bandwidth Limit	20MHz/100MHz/200MHz/300MHz*

\*: The tolerance of bandwidth limit is ±10%.

### Common

Vertical Sensitivity	Resolution	8 bits, (Max.12bits with Hi Res) For 1MΩ input impedance: 1mV*~10V/div For 50Ω input impedance: 1mV*~1V/div *: The bandwidth is limited to 20MHz at 2mV/div or below.
	Input Coupling	AC, DC, GND



	Input Impedance	1MΩ// 22pF approx.
	DC Gain Accuracy	1mV: ±5% full scale ≥2mV: ±3% full scale
	Polarity	Normal & Invert
	Maximum Input Voltage	For 1MΩ input impedance: 300Vrms, CAT II For 50Ω input impedance: 5Vrms
	Offset Position Range	For 1MΩ input impedance: 1mV/div ~ 20mV/div : ±1V 50mV/div ~ 500mV/div : ±10V 1V/div ~ 5V/div : ±100V 10V/div : ±1000V For 50Ω input impedance: 1mV/div ~ 50mV/div : ±1V 100mV/div ~ 1V/div : ±10V
	Waveform Signal Process	+, -, x, ÷, FFT, User Defined Expression FFT: Spectral magnitude. Set FFT Vertical Scale to Linear RMS or dBV RMS, and FFT Window to Rectangular, Hamming, Hanning or Blackman.
Trigger	Source	CH1, CH2, CH3**, CH4**, Line, EXT **: For 4CH models only
	Trigger Mode	Auto (supports Roll Mode for 100 ms/div and slower), Normal, Single
	Trigger Type	Edge, Pulse Width(Glitch), Video, Pulse Runt, Rise & Fall(Slope), Timeout, Alternate, Event-Delay(1~65535 events), Time-Delay(Duration, 4ns~10s), Bus (UART, I2C, SPI, CAN, LIN)
	Holdoff range	4ns to 10s
	Coupling	AC, DC, LF rej., Hf rej., Noise rej.
External Trigger	Sensitivity	1div
	Range	±20V
	Sensitivity	DC ~ 100MHz Approx. 100mV 100MHz ~ 350MHz Approx. 150mV
Horizontal	Input Impedance	1MΩ±3%~22pF
	Time base Range	1ns/div ~ 1000s/div (1-2-5 increments) ROLL: 100ms/div ~ 1000s/div
	Pre-trigger	10 div maximum
	Post-trigger	10,000,000 div maximum(depend on time base).
	Timebase Accuracy	±5 ppm, about ±2ppm increase in error per year

Signal Acquisition	Real Time Sample Rate	5GSa/s half channels; 2.5GSa/s all channels
	Record Length	Max. 200Mpts / ch
	Acquisition Mode	Normal, Average, High Resolution, Peak Detect, Single
	Peak Detection	2ns (typical)
	Average	Selectable from 2 to 512
	Number of Segments	1 to 490,000 maximum
X-Y Mode	X-Axis Input	Channel 1, Channel 3 (for 4CH models)
	Y-Axis Input	Channel 2, Channel 4 (for 4CH models)
	Phase Shift	±3° at 100kHz
Cursors and Measurement	Cursors	Amplitude, Time, Gating available; Unit: Seconds(s), Hz (1/s), Phase (degree), Ratio (%)
	Automatic Measurement	38 sets with indicator: Pk-Pk, Max, Min, Amplitude, High, Low, Mean, Cycle Mean, RMS, Cycle RMS, Area, Cycle Area, ROVShoot, FOVShoot, RPREShoot, FPREShoot, Frequency, Period, RiseTime, FallTime, +Width, -Width, Duty Cycle, +Pulses, -Pulses, +Edges, -Edges, %Flicker, Flicker Idx, FRR, FRF, FFR, FFF, LRR, LRF, LFR, LFF, Phase.
	Cursors measurement	Voltage difference between cursors ( $\Delta V$ ) Time difference between cursors ( $\Delta T$ )
	Auto counter	6 digits, range from 2Hz minimum to the rated bandwidth
Control Panel Function	Autoset	Single-button, automatic setup of all channels for vertical, horizontal and trigger systems, with “Undo Autoset”, “Fit Screen”/ “AC Priority” mode, and “Fine Scale” functions.
	Save Setup	20 sets
	Save Waveform	20 sets
	Save Reference Waveform	4 sets
	Power Analysis (Optional)	Power Quality, Harmonics, Ripple, In-rush current, Switching Loss, Modulation, SOA, Transient, Efficiency, B-H curve, Control Loop Response, PSRR, Turn On/Off
AWG	General	
	Channels	2
	Sample Rate	200MSa/s
	Vertical Resolution	14 bits

	Max. Frequency	25 MHz
	Waveforms	Arbitrary, Sine, Square, Pulse, Ramp, DC, Noise, Sinc, Gaussian, Lorentz, Exponential Rise, Exponential Fall, Haversine, Cardiac
	Output Range	20 mVpp to 5 Vpp, HighZ; 10 mVpp to 2.5 Vpp, 50Ω
	Output Resolution	1mV
	Output Accuracy	2% (1 kHz)
	Offset Range	±2.5 V, HighZ; ±1.25 V, 50 Ω
	Offset Resolution	1mV
	<b>Sine</b>	
	Frequency Range	100 mHz to 25 MHz
	Flatness (relative to 1 kHz)	±0.5 dB < 15MHz; ±1dB 15MHz~25MHz
	Harmonic Distortion	-40 dBc
	Stray (Non-harmonic)	-40 dBc
	Total Harmonic Distortion	1%
	S/N Ratio	40 dB
	<b>Square/Pulse</b>	
	Frequency Range	Square: 100 mHz to 15 MHz
	Rise/Fall Time	< 15ns
	Overshoot	< 3 %
	Duty Cycle	Square: 50% Pulse: 0.4% to 99.6%
	Min. Pulse Width	30ns
	Jitter	500 ps
	<b>Ramp</b>	
	Frequency Range	100 mHz to 1MHz
	Linearity	1%
	Symmetry	0 to 100%
Spectrum Analyzer	Frequency Range	DC~2.5GHz Max, dual channel with spectrogram (based on Advanced FFT). Notice: Frequency which exceeds analog front end bandwidth is uncalibrated
	Span	1kHz~2.5GHz (Max.)
	Resolution Bandwidth	1Hz~2.5MHz (Max.)
	Reference Level	-80dBm to +40dBm in steps of 5dBm
	Vertical Units	dBV RMS; Linear RMS; dBm
	Vertical Position	-12divs to +12divs

	Vertical Scale	1dB/div to 20dB/div in a 1-2-5 Sequence
	Displayed Average Noise Level	1V/div ← -40dBm, Avg : 16 100mV/div ← -60dBm, Avg : 16 10mV/div ← -80dBm, Avg : 16
	Spurious Response	2nd harmonic distortion < 35dBc 3rd harmonic distortion < 40dBc
	Frequency Domain Trace Types	Normal; Max Hold; Min Hold; Average (2 ~ 512)
	Detection Methods	Sample; +Peak; -Peak; Average
	FFT Windows	FFT Factor: Hanning 1.44 Rectangular 0.89 Hamming 1.30 Blackman 1.68
Logic Analyzer (Option)	Sample Rate	1GSa/s per channel
	Bandwidth	200MHz
	Record Length	Per Channel 10M points (max)
	Input Channels	16 Digital (D15 - D0)
	Trigger type	Edge, Pattern, Pulse Width, Serial bus (I2C, SPI, UART, CAN, LIN), Parallel Bus
	Thresholds Quad	Settable thresholds for: D0-D3, D4-D7, D8-11, D12-15
	Threshold selections	TTL, CMOS(5V,3.3V,2.5V), ECL, PECL,0V ,User Defined
	User-defined Threshold Range	±5V
	Maximum Input Voltage	±40 V
	Minimum Voltage Swing	±250 mV
	Vertical Resolution	1 bit
	Frequency Response Analyzer	Frequency Range
Input and Output Sources		Channel 1 ~ 2 for 2CH models Channel 1 ~ 4 for 4CH models
Number of Test Points		10, 15, 30, 45, 90 points per decade selectable for logarithm scale; 2 ~ 1000 points selectable for linear scale
Dynamic Range		> 80dB (typical)

	Test Amplitude	10mVpp to 2.5Vpp into 50Ω, 20mVpp to 5Vpp into High-Z, Fixed test amplitude or custom amplitude for each decade.
	Test Results	Logarithmic or linear overlaid gain and phase plot, may also overlay with reference plots for cross comparison. Test results saved in csv format for offline analysis.
	Manual Measurements	Tracking gain and phase markers
	Plot Scaling	Auto-scaled during test
Display	TFT LCD Type	10.2" TFT LCD WVGA color display
	Display Resolution	800 horizontal × 480 vertical pixels (WVGA)
	Interpolation	Sin(x)/x
	Waveform Display	Dots, vectors, variable persistence (16ms~4s), infinite persistence, gray or color waveforms.
	Waveform Update Rate	200,000 waveforms per second, maximum
	Display Graticule	8 x 10 divisions
	Display Mode	YT, XY
Interface	USB Port	USB 2.0 High-speed host port X1, USB High-speed 2.0 device port X1
	Ethernet Port (LAN)	RJ-45 connector X1, 10/100Mbps with HP Auto-MDIX
	Go-NoGo BNC	5V Max/10mA TTL open collector output X1
	Power Supply Receptacles	±12V / 600mA for current probe use. Two sets of power supply receptacles for 2CH models; Four sets of power supply receptacles for 4CH models.
	RS232C	DB-9 male connector X1
	VGA Video Port	DB-15 female connector X1, monitor output for display on VGA monitor
	Optional GPIB Module	Fully programmable with IEEE488-2 compliance
	Kensington Style Lock	Rear-panel security slot connects to standard Kensington-style lock.
Miscellaneous	Multi-language menu Operation	Available
	Environment	Temperature: 0°C to 50°C. Relative Humidity ≤ 80% at 40°C or below; ≤ 45% at 41°C ~ 50°C.
	On-screen help	Available

Time clock	Time and Date, Provide the Date/Time for saved data
Internal Flash Disk	800M bytes Single-Level Cell memory
Installed APP	Go/NoGo, DVM, DataLog, Digital Filter, Frequency Response Analyzer, Mask, Mount Remote Disk, Demo
User Define Key	User can select one of the several different preset functions as shortcut key.
Power Consumption	100W
Weight	Approx. 4.6kg
Dimensions	420mm(W)X 253mm(H)X 113.8mm(D)

---

## Probe Specifications

### Model-specific Probe Specifications

GTP-351R	Applicable to	GDS-3352A / GDS-3354A
	Bandwidth	DC ~ 350MHz
	Rise time	1.0ns
	Input Capacitance	~12pF
	Compensation Range	10 ~ 30pF
GTP-501R	Applicable to	GDS-3652A / GDS-3654A
	Bandwidth	DC ~ 500MHz
	Rise time	0.7ns
	Input Capacitance	~11.5pF @ 100MHz
	Compensation Range	8 ~ 20pF

### Common Probe Specifications

Position x 10	Attenuation Ratio	10:1 (fixed) with readout pin
	Input Resistance	10M $\Omega$ when used with 1M $\Omega$ input oscilloscope
	Maximum Input Voltage	500V CAT I, 300V CAT II derating with frequency
Operating Condition	Temperature	-0°C ~ 50°C
	Relative Humidity	≤85% @35°C
Safety Standard	EN61010-031 CAT II	

# Dimensions

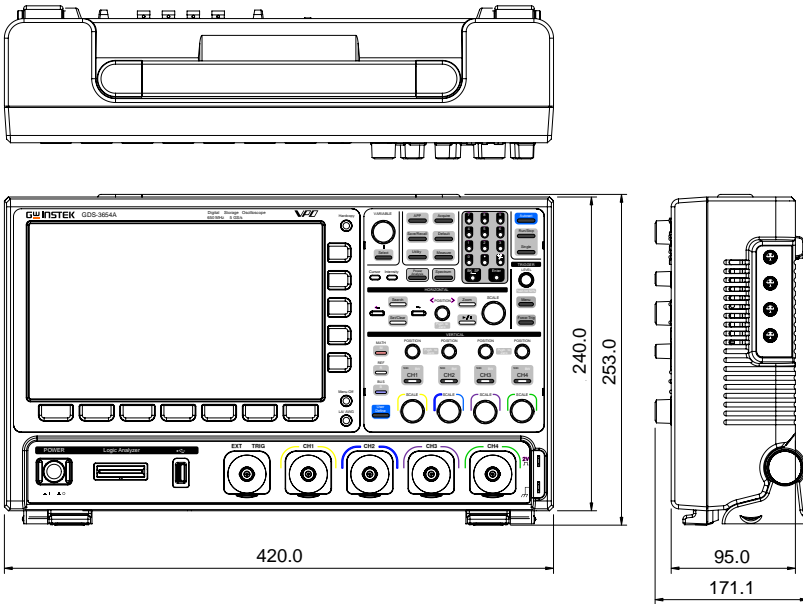



## Certificate Of Compliance

We

**GOOD WILL INSTRUMENT CO., LTD.**

declare that the CE marking mentioned product

satisfies all the technical relations application to the product within the scope of council:

Directive: EMC; LVD; WEEE; RoHS

The product is in conformity with the following standards or other normative documents:

© EMC	
EN 61326-1	Electrical equipment for measurement, control and laboratory use — EMC requirements
Conducted & Radiated Emission EN 55011 / EN 55032	Electrical Fast Transients EN 61000-4-4
Current Harmonics EN 61000-3-2 / EN 61000-3-12	Surge Immunity EN 61000-4-5
Voltage Fluctuations EN 61000-3-3 / EN 61000-3-11	Conducted Susceptibility EN 61000-4-6
Electrostatic Discharge EN 61000-4-2	Power Frequency Magnetic Field EN 61000-4-8
Radiated Immunity EN 61000-4-3	Voltage Dip/ Interruption EN 61000-4-11 / EN 61000-4-34
© Safety	
EN 61010-1 :	Safety requirements for electrical equipment for measurement, control, and laboratory use - Part 1: General requirements

**GOODWILL INSTRUMENT CO., LTD.**

No. 7-1, Jhongsing Road, Tucheng District, New Taipei City 236, Taiwan

Tel: [+886-2-2268-0389](tel:+886-2-2268-0389)

Fax: [+886-2-2268-0639](tel:+886-2-2268-0639)

Web: <http://www.gwinstek.com>

Email: [marketing@goodwill.com.tw](mailto:marketing@goodwill.com.tw)

**GOODWILL INSTRUMENT (SUZHOU) CO., LTD.**

No. 521, Zhujiang Road, Snd, Suzhou Jiangsu 215011, China

Tel: [+86-512-6661-7177](tel:+86-512-6661-7177)

Fax: [+86-512-6661-7277](tel:+86-512-6661-7277)

Web: <http://www.instek.com.cn>

Email: [marketing@instek.com.cn](mailto:marketing@instek.com.cn)

**GOODWILL INSTRUMENT EURO B.V.**

De Run 5427A, 5504DG Veldhoven, The Netherlands

Tel: [+31-\(0\)40-2557790](tel:+31-(0)40-2557790)

Fax: [+31-\(0\)40-2541194](tel:+31-(0)40-2541194)

Email: [sales@gw-instek.eu](mailto:sales@gw-instek.eu)

# INDEX

- AC coupling..... 106
- AC Priority mode ..... 39
- Acquisition ..... 80
  - average .....80
  - indicator .....25
  - peak detect .....80
  - record length.....84
  - sample.....80
  - XY mode.....81
- Advanced math
  - expression .....72
  - operation .....73
  - source.....72
- Amplitude measurements..... 44
- APP
  - Data Log .....321
  - digital filter .....323
  - DVM .....319
  - Go-NoGo.....314
  - mask.....325
  - overview.....311
  - run.....312
- Area measurements ..... 44
- Auto trigger..... 144
- Auto-dim ..... 192
- Automatic measurement
  - Add measurement.....47
  - display all .....53
  - gated mode .....53
  - High-Low .....54
  - overview.....43
  - Reference levels .....58
  - remove measurement 49, 50, 51, 52
  - Statistics.....56
- Autoset..... 38
  - AC Priority mode .....39
  - effect on channel.....39
  - exception .....39
  - Fit Screen mode .....39

- AWG
  - AM.....203
  - channel activation..... 198
  - connection.....197
  - Coupling and tracking ..... 223
  - Create new ARB waveform ..... 211
  - edit existing waveform ..... 213
  - FM.....206
  - FSK .....208
  - function edit ..... 215
  - impedance ..... 199
  - load ARB waveform ..... 220
  - normal edit ..... 214
  - overview ..... 196
  - phase .....199
  - Save ARB waveform.....221
  - select waveform ..... 200
  - specification.....404
  - sweep ..... 209
  - turn on output.....199
  - waveform settings ..... 201
- Bandwidth filter ..... 107
- Blackman window ..... 69
- Bus
  - CAN ..... 128
  - cursors ..... 137
  - encoding ..... 130
  - event tables.....132, 135
  - I<sup>2</sup>C .....119
  - labels.....135
  - LIN.....129
  - serial bus overview ..... 115
  - threshold..... 131
  - trigger settings
    - CAN ..... 166
    - I<sup>2</sup>C ..... 162
    - LIN.....169
    - Parallel ..... 171
    - SPI..... 165
    - UART ..... 160

UART .....	117	FAQ.....	397
Channel .....	37	FFT	
status indicator .....	25	horizontal cursor .....	60
Connection.....	337	vertical cursor.....	63
Control panel function		File	
specification.....	404	create folder.....	367
Conventions .....	30	delete .....	370
Coupling mode .....	105	rename.....	368
Cursor		File navigation.....	366
horizontal .....	59	File path.....	367
specification.....	404	Firmware update.....	400
vertical .....	62	Firmware version.....	184
Data logging .....	321	First time use .....	27
Date setting.....	186	Fit Screen mode.....	39
indicator.....	25	Frequency measurements .....	45
DC coupling .....	105	Go-NoGo	
Declaration of conformity.....	411	circuit diagram .....	318
Default setup .....	358	Go-NoGo .....	314
contents.....	358	timing .....	317
effect on channel.....	38	Ground	
Delay measurements .....	46	coupling .....	106
Deskew.....	112, 229	Hamming window .....	68
Detection mode .....	278	Hanning window .....	68
Digital filter .....	323	Harmonics.....	240
Dimensions		Holdoff .....	148
diagram.....	410	Horizontal	
Display		basic operation .....	40
AWG .....	197	position.....	96
bus .....	114	scale .....	97
search .....	177	specification.....	403
segmented memory.....	86	Image file format.....	342
specification.....	407	Impedance.....	106
Spectrum Analyzer.....	294	Initialization.....	27
Dots.....	189	Input frequency indicator .....	25
DVM.....	319	Inrush235, 252, 254, 258, 262, 265, 268, 272, 284	
Edge Trigger.....	149	Intensity.....	189, 190
EN61010		Interface.....	376
measurement category.....	5	specification.....	407
pollution degree.....	6	Invert waveform .....	106, 109
Erase memory .....	185, 186	Keys overview .....	15
Ethernet		Labels.....	348
interface .....	377	Language selection .....	184
Expand by ground/center.....	110	List of features.....	10
External trigger .....	142	Logic Analyzer	
input terminal.....	20	specification.....	406
specification.....	403	Logic trigger .....	172

Mask.....	325	Rear panel diagram .....	196
auto mask.....	327	Recall .....	358
user-defined mask.....	330	default setup.....	358
Math		reference.....	363
Advanced math overview .....	72	setup .....	361
basic .....	66	waveform.....	360
FFT operation.....	69	Rectangular window .....	69
FFT overview .....	68	Reduce any menu .....	33
Mean measurements .....	44	Reduce lower menu.....	33
Memory bar		Reduce side menu.....	32
indicator .....	25	Remote control .....	375
Menu on/off .....	194	interface configuration.....	376
Miscellaneous		webserver .....	388
specification .....	407	Ripple .....	250
Model differences .....	10	Rise and fall trigger .....	157
Normal trigger .....	144	RMS measurements.....	44
NTSC.....	146	Roll mode.....	98
Overshoot measurements.....	45	RS-232C	
Overview .....	336	interface.....	380
PAL.....	146	Run/Stop .....	39, 194
Parallel bus		horizontal position.....	96
configuration .....	123	Horizontal scale .....	97
encoding.....	125	Safety Instructions	
event table.....	125	Caution symbol.....	4
labels .....	126	Cleaning the instrument .....	6
threshold .....	124	Disposal instructions.....	7
Peak measurements .....	43	Ground symbol .....	4
Peak search.....	278, 279, 281, 282	Operation Environment.....	6
Peak to peak measurement .....	43	Power on/off.....	6
Play waveform.....	101	UK power cord.....	8
Power Analysis.....	10, 229	Warning symbol .....	4
harmonics overview.....	240	Save.....	351
Inrush.....	235, 252, 254, 258, 262, 265, 268, 272, 284, 288	hardcopy key.....	373
power quality overview .....	231	image.....	352
ripple.....	250	setup .....	356
Power quality .....	231	waveform.....	354
Probe		Screen dimmer .....	192
attenuation level.....	112	Search	
attenuation type .....	111	configuration.....	176
deskew.....	112, 229	copying search events .....	178
Probe compensation.....	395	copying trigger events.....	178
Probe compensation frequency.....	187	FFT Peak .....	180
Pulse runt trigger.....	156	navigation .....	178
Pulse measurements .....	45	save marks .....	179
Pulse width trigger.....	152	set/clear events.....	180
QR code reader function.....	187	SECAM.....	146
		Segmented memory	

- configuration.....87
- infomation.....94
- measurement.....91
- navigation.....89
- overview.....85
- play back.....90
- run.....88
- Serial Bus
  - SPI.....120
- Serial number.....184
- Service operation
  - about disassembly.....5
  - contact.....398
- Setup
  - default contents.....359
  - file format.....345
- Signal path compensation.....393
- Single trigger mode.....144
  - Run/Stop.....40
- Socket server
  - function check.....383
- Socket server
  - interface.....382
- Source.....274, 276, 338
- SPC.....393
- Specifications.....402
- Spectrum Analyzer
  - bandwidth.....303
  - center frequency.....300
  - connections.....295
  - cursors.....309
  - detection mode.....298
  - Overview.....293
  - peak search.....308
  - source.....295
  - span.....301
  - start and stop frequency.....301
  - trace options.....296
  - vertical scale.....304, 305
  - window type.....304
- Spreadsheet file format.....343
- System information.....184
- Tilt stand.....26
- Time setting.....186
  - indicator.....25
- Trigger.....139
  - Bus
    - CAN.....166
    - I<sup>2</sup>C.....162
    - LIN.....169
    - Parallel.....171
    - SPI.....165
    - UART.....160
  - edge.....149
  - holdoff.....148
  - indicator.....25
  - logic.....172
  - mode.....149
  - parameters.....141
  - pulse runt.....156
  - pulse width.....152
  - Rise and fall.....157
  - Single.....40
  - specification.....403
  - status indicator.....25
  - Timeout.....158
    - overview.....148
  - video.....154
- Updating the firmware.....400
- USB
  - remote control interface.....376
- Vectors.....189
- Vertical.....104
  - accuracy calibration.....393
  - basic operation.....42
  - position.....104
  - scale.....105
  - specification.....402
- Vertical scale.....339
- Video trigger.....154
- Waveform
  - CSV file contents.....344
  - file contents.....343
  - how to recall.....360
  - how to save.....354
  - invert waveform.....106, 109
  - play/pause key.....101
  - roll mode.....98
  - zoom mode.....99
- Waveform color.....24
- Waveform file format.....342
- XY
  - specification.....404
- Zoom waveform.....99