

Multi-phase Programmable AC/DC Power Source

ASR-6000 Series

CAN BUS MANUAL



ISO-9001 CERTIFIED MANUFACTURER

GW INSTEK

This manual contains proprietary information, which is protected by copyright. All rights are reserved. No part of this manual may be photocopied, reproduced or translated to another language without prior written consent of Good Will company.

The information in this manual was correct at the time of printing. However, Good Will continues to improve products and reserves the rights to change specification, equipment, and maintenance procedures at any time without notice.

Good Will Instrument Co., Ltd.
No. 7-1, Jhongsing Rd., Tucheng Dist., New Taipei City 236, Taiwan.

Table of Contents

SAFETY INSTRUCTIONS	4
GETTING STARTED	8
ASR-6000 Series Overview	9
Appearance.....	13
CAN OPEN	21
NMT state machine	22
SDO communication	24
Protocol SDO download.....	26
Protocol SDO download initiate.....	28
Protocol SDO download segment	30
Protocol SDO upload	32
Protocol SDO upload initiate	33
Protocol SDO upload segment.....	35
Emergency Object.....	37
Heartbeat protocol.....	38
PDO Communication	39
REMOTE CONTROL	40
CAN BUS Configuration	41
Object dictionary	45
Communication Command List.....	74
Manufacturer-specific Command List ..	80
SDO Abort Transmission (CANopen Errors)	280
APPENDIX	284
Factory Default Settings	284
INDEX	295

S SAFETY INSTRUCTIONS

This chapter contains important safety instructions that you must follow during operation and storage. Read the following before any operation to ensure your safety and to keep the instrument in the best possible condition.

Safety Symbols

These safety symbols may appear in this manual or on the instrument.



Warning: Identifies conditions or practices that could result in injury or loss of life.



Caution: Identifies conditions or practices that could result in damage to the ASR-6000 or to other properties.



DANGER High Voltage



Attention Refer to the Manual



Protective Conductor Terminal



Earth (ground) Terminal



Do not dispose electronic equipment as unsorted municipal waste. Please use a separate collection facility or contact the supplier from which this instrument was purchased.

Safety Guidelines

General Guideline



CAUTION

- Do not place any heavy object on the ASR-6000.
- Avoid severe impact or rough handling that leads to damaging the ASR-6000.
- Do not discharge static electricity to the ASR-6000.
- Use only mating connectors, not bare wires, for the terminals.
- Do not block the cooling fan opening.
- Do not disassemble the ASR-6000 unless you are qualified.
- If the equipment is used in a manner not specified by the manufacturer, the protection provided by the equipment may be impaired.
- Due to the fact that ASR-6000 unit weights greater than 18kg, please resort to the standard kit GRA-451-E for transport or remove the unit by at least two persons in case of danger occurred.

Power Supply



WARNING

- AC Input voltage range:
200 Vac to 240 Vac $\pm 10\%$
phase voltage (Delta: L-L, Y: L-N)
 - Frequency: 47 ~ 63 Hz
 - To avoid electrical shock connect the protective grounding conductor of the AC power cord to an earth ground.
 - The power switch that is included in the instrument is not considered a disconnecting device.
 - The permanently connected power input is used as the disconnecting device and shall remain readily operable.
 - a. A switch or circuit-breaker must be included in the installation
 - b. It must be suitably located and easily reached
 - c. It must be marked as the disconnecting device for the equipment.
 - d. It shall be located near the equipment
 - Do not position the equipment so that it is difficult to operate the disconnecting device.
 - Ask for professional technician for installation.
 - It requires 200Vac input condition and the maximum input current [30A (ASR-6450), 40A (ASR-6600)], which conforms to cord diameter by local regulations.
 - Breaker, of which the specification is required to larger than 30A (ASR-6450), 40A (ASR-6600) individually, should be in the near proximity of unit.
-

- Cleaning the ASR-6000
- Disconnect the circuit-breaker or permanently connected power input before cleaning.
 - Use a soft cloth dampened in a solution of mild detergent and water. Do not spray any liquid.
 - Do not use chemicals containing harsh material such as benzene, toluene, xylene, and acetone.

- Operation Environment
- Location: Indoor, no direct sunlight, dust free, almost non-conductive pollution (Note below)
 - Relative Humidity: 20%~ 80%, no condensation
 - Altitude: < 2000m
 - Temperature: 0°C to 40°C
- (Pollution Degree) EN 61010-1:2010 specifies the pollution degrees and their requirements as follows. The ASR-6000 falls under degree 2. Pollution refers to “addition of foreign matter, solid, liquid, or gaseous (ionized gases), that may produce a reduction of dielectric strength or surface resistivity”.
- Pollution degree 1: No pollution or only dry, non-conductive pollution occurs. The pollution has no influence.
 - Pollution degree 2: Normally only non-conductive pollution occurs. Occasionally, however, a temporary conductivity caused by condensation must be expected.
 - Pollution degree 3: Conductive pollution occurs, or dry, non-conductive pollution occurs which becomes conductive due to condensation which is expected. In such conditions, equipment is normally protected against exposure to direct sunlight, precipitation, and full wind pressure, but neither temperature nor humidity is controlled.

- Storage environment
- Location: Indoor
 - Temperature: -10°C to 70°C
 - Relative Humidity: ≤90%, no condensation

Disposal



Do not dispose this instrument as unsorted municipal waste. Please use a separate collection facility or contact the supplier from which this instrument was purchased. Please make sure discarded electrical waste is properly recycled to reduce environmental impact.

GETTING STARTED

This chapter describes the ASR-6000 power supply in a nutshell, including its main features and front / rear panel introduction.

ASR-6000 series



ASR-6000 Series Overview	9
Series lineup	9
Main Features	10
Accessories.....	11
Appearance	13
Front Panel.....	13
Rear Panel	18

ASR-6000 Series Overview

Series lineup

The ASR-6000 series consists of 2 models, the ASR-6450 and ASR-6600, differing in capacity. Note that throughout the user manual, the term “ASR-6000” refers to any of the models, unless stated otherwise.

1P Output Condition

Model Name	Power Rating	Max. Output Current	Max. Output Voltage
ASR-6450	4500 VA	45 / 22.5 A	350 Vrms / 500 Vdc
ASR-6600	6000 VA	60 / 30 A	350 Vrms / 500 Vdc

1P3W Output Condition

Model Name	Power Rating	Max. Output Current	Max. Output Voltage
ASR-6450	3000 VA	15 / 7.5 A	700 Vrms / 1000 Vdc
ASR-6600	4000 VA	20 / 10 A	700 Vrms / 1000 Vdc

3P Output Condition (Pre phase)

Model Name	Power Rating	Max. Output Current	Max. Output Voltage
ASR-6450	1500 VA	15 / 7.5 A	350 Vrms / 500 Vdc
ASR-6600	2000 VA	20 / 10 A	350 Vrms / 500 Vdc

Main Features

Performance	<ul style="list-style-type: none">• Maximum phase voltage is 350 Vrms, line voltage is 700 Vrms• Maximum DC output voltage is 1000 Vdc• Maximum output frequency is 2000 Hz• Adjustable Voltage rising time• DC full capacity output ability• Output voltage total harmonic distortion is less than 0.3% at 50 and 60 Hz• Maximum crest factor reached 4 times
Features	<ul style="list-style-type: none">• Include sine, square, triangle, arbitrary and DC output waveforms• Variable voltage, frequency and current limiter• 100 steps Harmonic voltage and current analysis ability• Supported three phase unbalanced output mode• Sequence, simulate and preset memory functions• AC line frequency synchronized output• USB memory save and recall• Remote sense compensator• Supported 1P, 1P3W and 3P output phase• External control I/O and signal input applications• Voltage and current monitor output• Voltage control amplifier output• PC software, web control and data log functions
Interface	<ul style="list-style-type: none">• Built-in LAN, USB host, USB device and RS232 interface• Optional GPIB, DeviceNet and CAN BUS interface

Accessories

Before using the ASR-6000 power source unit, check the package contents to make sure all the standard accessories are included.

Standard Accessories	Part number	Description
		Quick Start Guide
	82GW1SAFE0M*1	Safety guide
	62SR-6K0SC401	Input terminal cover
	62SR-6K0SC301	Output terminal cover
	62SR-6K0CP101	Copper plate for delta connection input (Mark 1)
	62SR-6K0CP201	Copper plate for single phase and Y connection input (Mark 2)
	62SR-6K0CP301	Copper plate for delta connection input (Mark 3)
	62SR-6K0CP401	Copper plate for 1P output (Mark 4)
	GRA-451-E	Rack mount adapter (EIA)
	GTL-246	USB cable (USB 2.0 Type A - Type B cable, approx. 1.2M)
Optional Accessories	Part number	Description
	GRA-451-J	Rack mount adapter (JIS)
	GPW-008	Power Cord SJT 10AWG/3C, 3m Max Length, 105oC, RV5-5*3P, RV5-5*3P UL TYPE
	GPW-009	Power Cord H05VV-F 2.5mm ² /3C, 3m Max Length, 105oC, RVS3-5*3P, RVS3-5*3P VDE TYPE

GPW-010	Power Cord VCTF 2.0mm2/3C, 3m Max Length, 105oC, RVS2-5*3P, RVS2-5*3P PSE TYPE
GPW-011	Power Cord SJT 10AWG/5C, 3m Max Length, 105oC, RV5-5*5P, RV5-5*5P UL TYPE
GPW-012	Power Cord H05VV-F 2.5mm2/5C, 3m Max Length, 105oC, RVS3-5*5P, RVS3-5*5P VDE TYPE
GPW-013	Power Cord VCTF 2.0mm2/5C, 3m Max Length, 105oC, , RVS2-5*5P, RVS2-5*5P PSE TYPE
GPW-014	Power Cord SJT 10AWG/4C, 3m Max Length, 105oC, RV5-5*4P, RV5-5*4P UL TYPE
GPW-015	Power Cord H05VV-F 2.5mm2/4C, 3m Max Length, 105oC, RVS3-5*4P, RVS3-5*4P VDE TYPE
GPW-016	Power Cord VCTF 2.0mm2/4C, 3m Max Length, 105oC, , RVS2-5*4P, RVS2-5*4P PSE TYPE
GTL-232	RS232C cable, approx. 2M
GTL-248	GPIB cable, approx. 2M
ASR-003	GPIB interface card
ASR-004	DeviceNet interface card
ASR-005	CAN BUS interface card
ASR-006	External parallel cable



Note

- GPW-008, 009, 010 are for single phase input only.
- GPW-011, 012, 013 are for Y connection input only.
- GPW-014, 015, 016 are for Delta connection input only.

Appearance

Front Panel

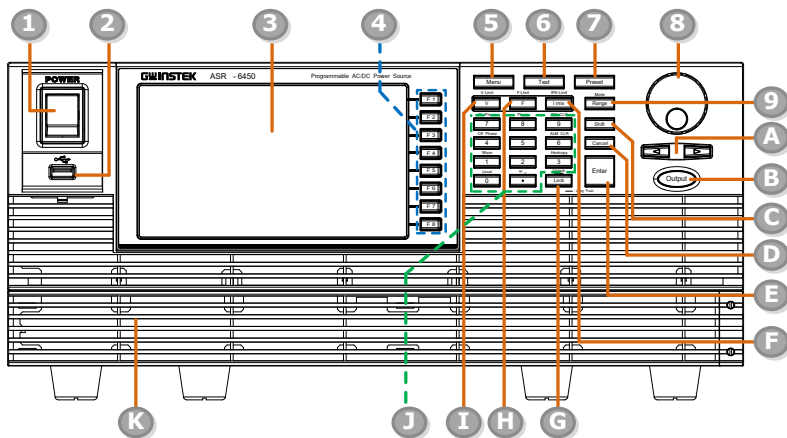



Item Index	Description
1	Power switch button
2	USB interface connector (A Type)
3	LCD screen
4	Function keys (blue zone)
5	Menu key
6	Test key
7	Preset key
8	Scroll wheel
9	Range key/Output mode key
A	Arrow keys
B	Output key
C	Shift key

D	Cancel key
E	Enter key
F	Irms/IPK-Limit button
G	Lock/Unlock button
H	F/F-Limit button
I	V/V-Limit button
J	Numerical Keypad with additional “Shift + key” shortcut functions (green zone)
K	Air inlet









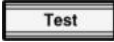

Item	Description
------	-------------

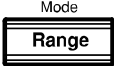

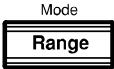

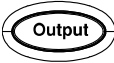



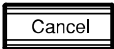



Power Switch		Turn on the mains power
--------------	-----------------------------------------------------------------------------------	-------------------------

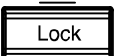



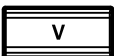

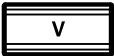





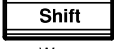
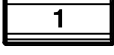

USB A Port		<p>The USB port is used for data transfers and upgrading software. Also, it is available for screenshot hardcopy.</p> <p> It supports FAT32 format with maximum 32G storage.</p>
------------	-----------------------------------------------------------------------------------	-------------------------------------------------------------------------------------------------------------------------------------------------------------------------------------------------------------------------------------------------------------------

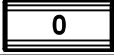
LCD Screen	Displays the setting and measured values or menu system
------------	---------------------------------------------------------

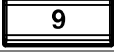
Function Keys		Assigned to the functions displayed on the right side of the screen.
---------------	-------------------------------------------------------------------------------------	----------------------------------------------------------------------

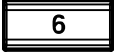
Menu Key		Enters the Main menu or goes back to one of the display modes.
Test Key		Puts the instrument into the Sequence and Simulation control mode.
Preset Key		Puts the instrument into Preset mode.
Arrow Keys		The arrow keys are used to select the digit power of a value that is being edited.
Range Key		Switches between the 100V, 200V and AUTO ranges
Output Mode	 + 	Selects between the AC+DC-INT, AC-INT, DC-INT, AC+DC-EXT, AC-EXT, AC+DC-ADD, AC-ADD, AC+DC-Sync, AC-Sync and AC-VCA modes.
Scroll Wheel		Used to navigate menu items or for increment/decrement values one step at a time.
Output Key		Turns the output on or off.
Shift Key		Turns on the shift state, which enables shortcut operations with an icon  indicated on the top status bar. The shift state, which allows continuous shortcut operations, is kept until another press on shift key again.
		When performing shortcut operations, press shift key followed by another shortcut function key. Do Not press both shift key and shortcut function key simultaneously.
Cancel Key		Used to cancel function setting menus or dialogs.

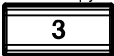
Enter Key		Confirms selections and settings.
Irms	<p style="text-align: center;">IPK-Limit</p> 	Used for setting the maximum output current.
IPK-Limit	<p style="text-align: center;">Shift</p> <p style="text-align: center;">+ IPK-Limit</p>  <p style="text-align: center;">Irms</p> 	Used to set the peak output current limit value.
Lock/Unlock Key	<p style="text-align: center;">Unlock</p>  <p style="text-align: center;">Lock</p> <p style="text-align: center;">— : Long Push</p>	Used to lock or unlock the front panel keys except output key. Simply press to lock, whilst long press to unlock.
F	<p style="text-align: center;">F-Limit</p> 	Used for setting the output frequency (DC mode N/A).
F-Limit	<p style="text-align: center;">Shift</p> <p style="text-align: center;">+ F-Limit</p>  <p style="text-align: center;">F</p> 	Used for setting the output frequency limit value (DC mode N/A).
V	<p style="text-align: center;">V-Limit</p> 	Used for setting the output voltage.
V-Limit	<p style="text-align: center;">Shift</p> <p style="text-align: center;">+ V-Limit</p>  <p style="text-align: center;">V</p> 	Used for setting the output voltage limit value.
Keypad		Used to input power of a value directly. The  key is used to input decimal / plus or minus.

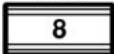
On Phase	 <small>On Phase</small>	+ Sets the on phase for the output voltage.
		
<hr/>		
Off Phase	 <small>Off Phase</small>	+ Sets the off phase for the output voltage.
		
<hr/>		
Output Waveform	 <small>Wave</small>	+ Selects between the Sine, Square, Triangle and ARB 1~16 waveforms (not available for DC-INT, AC+DC-EXT and AC-EXT).
		
<hr/>		
Local Mode	 <small>Local</small>	+ Switches operation back to local mode from remote mode.
		
<hr/>		
IPK CLR	 <small>IPK CLR</small>	+ Used to clear peak output current value.
		
<hr/>		
ALM CLR	 <small>ALM CLR</small>	+ Clears alarms.
		
<hr/>		
Hardcopy Key	 <small>Hardcopy</small>	+ Used to take a screenshot. Make sure an USB flash disk is well inserted before the action.
		
<hr/>		
Output Phase	 <small>Phase</small>	+ Used to switch output phase 1P2W, 1P3W or 3P4W.
		

Rear Panel

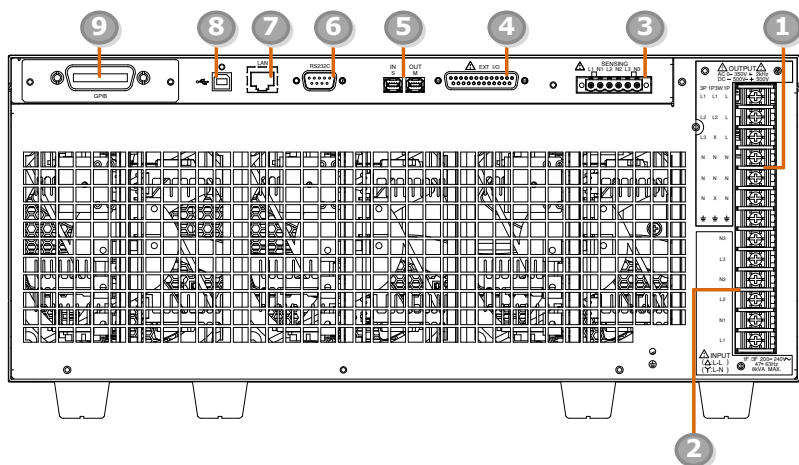

Item Index	Description
1	Output terminal
2	AC power input terminal
3	Remote sensing input terminal
4	External I/O connector
5	External IN/OUT connection in parallel function
6	RS232 connector
7	Ethernet (LAN) connector
8	USB interface connector (B Type)
9	Optional interface Slot <ul style="list-style-type: none"> ▪ GPIB card (ASR-003) ▪ DeviceNet card (ASR-004) ▪ CAN BUS card (ASR-005)

Item	Description
Output Terminal	<div data-bbox="397 223 588 550" style="display: inline-block; vertical-align: top;"> <p style="font-size: small; margin-top: 5px;"> OUTPUT AC 0-300V ± 20Hz DC 0-500V ± 500V </p> </div> <div data-bbox="593 223 985 327" style="display: inline-block; vertical-align: top; padding-left: 20px;"> <p>Output terminal (M4 screw type, 8 ~ 18 AWG) (Screw torque value:18kgf-cm)</p> </div>
AC Power Input Terminal	<div data-bbox="397 582 588 877" style="display: inline-block; vertical-align: top;"> <p style="font-size: small; margin-top: 5px;"> INPUT (Δ:L-L) (Y:L-N) </p> <p style="font-size: x-small; margin-top: 5px;"> 1Φ/3Φ 200-240V~ 47-63Hz 8kVA MAX. </p> </div> <div data-bbox="593 582 985 686" style="display: inline-block; vertical-align: top; padding-left: 20px;"> <p>AC inlet (M4 screw type, 8 ~ 18 AWG) (Screw torque value:18kgf-cm)</p> </div>
Remote Sensing Input Terminal	<div data-bbox="397 909 588 989" style="display: inline-block; vertical-align: top;"> <p style="font-size: small; margin-top: 5px;"> SENSING L1 N1 L2 N2 L3 N3 </p> </div> <div data-bbox="593 909 985 1101" style="display: inline-block; vertical-align: top; padding-left: 20px;"> <p>Remote sensing input terminal is for compensation of load wire voltage drop. (M2.5 screw type, 12 ~ 30 AWG) (Screw torque value: 0.5N*m) (Strip length: 7 ~ 8mm)</p> </div>
External Control I/O Connector	<div data-bbox="397 1133 588 1197" style="display: inline-block; vertical-align: top;"> <p style="font-size: small; margin-top: 5px;"> EXT I/O </p> </div> <div data-bbox="593 1133 985 1228" style="display: inline-block; vertical-align: top; padding-left: 20px;"> <p>Used to control ASR-6000 externally by using the logic signal and monitor Sequence function status.</p> </div>
External IN/OUT Connection in Parallel Function	<div data-bbox="397 1268 588 1361" style="display: inline-block; vertical-align: top;"> <p style="font-size: small; margin-top: 5px;"> IN S OUT M </p> </div> <div data-bbox="593 1268 985 1361" style="display: inline-block; vertical-align: top; padding-left: 20px;"> <p>The IN (Slave) and OUT (Master) ports are used for connection with external unit in parallel function.</p> </div>

RS232C
Connector

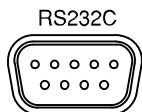

The RS232C connector for controlling the ASR-6000 remotely.

Ethernet LAN
Port

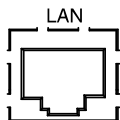

The Ethernet port is used for remote control.

USB B-type Port



USB port for controlling the ASR-6000 remotely.

Optional GPIB
Connector



The optional GPIB connector for controlling the ASR-6000 remotely.

Optional CAN
BUS Connector

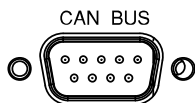

The optional CAN BUS connector for controlling the ASR-6000 remotely.

Optional
DeviceNet
Connector

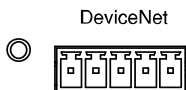

The optional DeviceNet connector for controlling the ASR-6000 remotely.

CAN OPEN

This chapter describes CANopen Application Layer and Communication Profile CiA Draft Standard 301.

NMT state machine	22
SDO communication	24
Protocol SDO download	26
Protocol SDO download initiate	28
Protocol SDO download segment.....	30
Protocol SDO upload	32
Protocol SDO upload initiate	33
Protocol SDO upload segment	35
Emergency Object	37
Heartbeat protocol	38
PDO Communication	39

NMT state machine

To ensure compatibility with the CANopen network management (NMT), all CANopen devices are required to support the NMT slave state machine. The NMT state machine defines the communication behavior of a CANopen device. It comprises four states: Initialization, Pre-operational, Operational, and Stopped. After power-on or reset, the device enters the Initialization state.

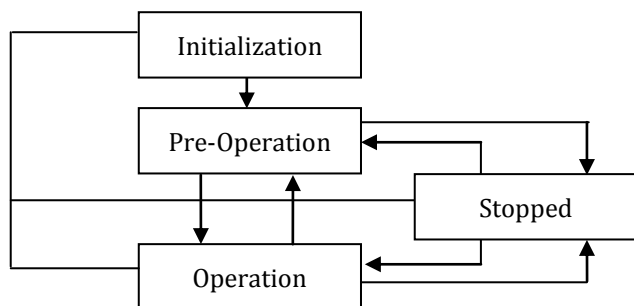

The state machine defines the various states and transitions that occur during communication. The states are as follows:

- **Initialization:** This is the initial state of the CANopen network, where all devices are reset and their communication parameters are set.
- **Pre-Operational:** In this state, the devices are ready to communicate, but they have not yet started any data exchange.
- **Operational:** In this state, the devices exchange data as per the commands from the master.
- **Stopped:** This is an error state, where the communication between devices has been halted due to some fault or error.
- **Reset Node:** This state is used to reset a particular node in the network.

Once the device initialization is complete, it will automatically transition to the Pre-operational state and signal this transition by transmitting the boot-up message. This indicates that the device is ready for operation. While in Pre-operational state, the device can send SYNC-, Time Stamp-, or Heartbeat messages if these services have been configured and are supported. The device can also communicate via SDO, but PDO communication is disabled in this state and only becomes possible in the Operational state. In the Operational state, the device can use all supported communication objects. If the device is switched to the Stopped state, it will only respond to NMT commands received and will indicate the current NMT state by supporting the error control protocol.

The following table shows the possible states for the communication objects:

State	Initialisation	Pre-Operational	Operational	Stopped
PDO			V	
SDO		V	V	
SYNC		V	V	
EMCY		V	V	
Boot-Up	V			
NMT		V	V	V

SDO communication

SDO (Service Data Object) is a type of communication in the CANopen protocol that enables the transmission of complex data between nodes in the network. It is used for the configuration and control of devices in the network.

In SDO communication, the client node initiates the data transfer via a request message, and the server node responds with the requested data or an error message. SDO communication adopts a client-server model, where the client initiates the data transfer request, and the server responds with the requested data. The SDO request message contains the object index, sub-index, and data to be transferred, while the SDO response message contains the requested data or error message if the request cannot be completed.

SDO communication allows for data transfer up to 8 bytes in length, making it suitable for configuring and controlling devices. Additionally, SDO communication implements error checking and verifies data transfer to ensure data integrity.

CANopen device can support different variants of the SDO communication:

- expedited transfer
- normal (segmented) transfer
- block transfer

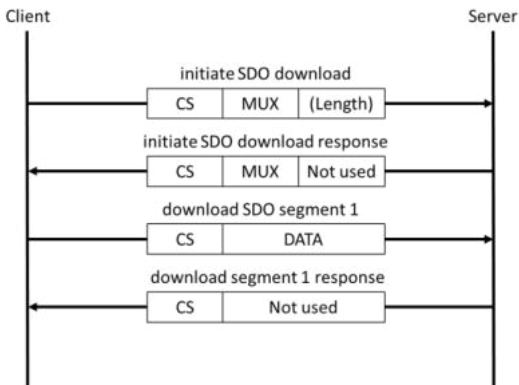

During the initialization process, the client device specifies the information to be accessed from the server's object dictionary, the type of SDO to be used, and whether the data is to be read or written. The server acknowledges the request, and the client starts transmitting the first data segment. Segmented data transfer is used to communicate any amount of data. Each segment can hold up to seven bytes of application data, with one byte of the CAN frame required for protocol information. In a normal SDO transfer, an unlimited number of segments and therefore of application data can be exchanged.

For small amounts of data (less than or equal to 4 bytes), the expedited SDO transfer is used to accelerate data transfer. In this type of SDO connection, the data is transmitted directly during the initiation of the SDO connection. Supporting the SDO block transfer is useful for speeding up the transmission of large amounts of data. During block transfer, only a block of data (up to 127 segments) is confirmed by the receiver, unlike the normal transfer where each segment is individually confirmed.

Protocol SDO download

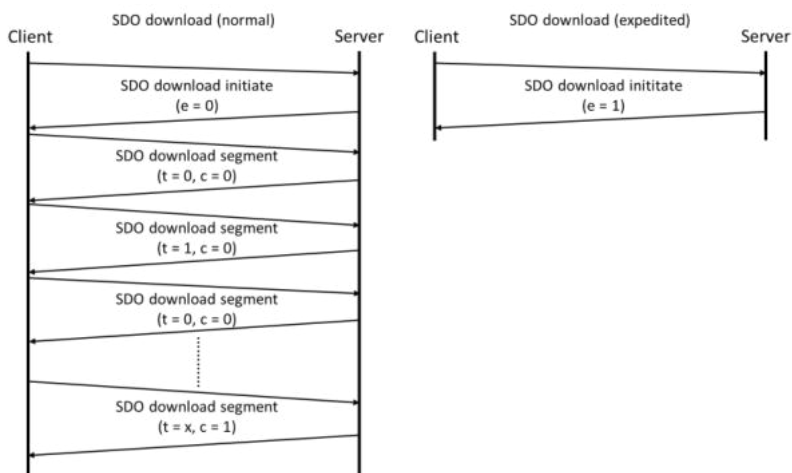

The SDO download service protocol is required to be utilized for implementing SDO downloads. These SDOs are downloaded as a series of SDO download segment services that may be zero or more, with an SDO download initiate service initiating the sequence. The sequence is terminated by:

- SDO download initiate request/indication with the e-bit set to 1 followed by an SDO download initiate response/confirm, indicating the successful completion of an expedited download sequence.
- SDO download segment response/confirm with the c-bit set to 1, indicating the successful completion of a normal download sequence.

- SDO abort transfer request/indication, indicating the unsuccessful completion of the download sequence.
- SDO download initiate request/indication, indicating the unsuccessful completion of the download sequence and the start of a new SDO download sequence.

If the toggle bit does not change during the download of two consecutive segments, the content of the last segment will be disregarded. If such an error is reported to the application, the application may decide to abort the download.

Protocol SDO download initiate

The SDO download initiate protocol of CANopen communication is used to initiate the download of an SDO object from a server device to a client device. This protocol is initiated by the client device and the server device responds with a download response.

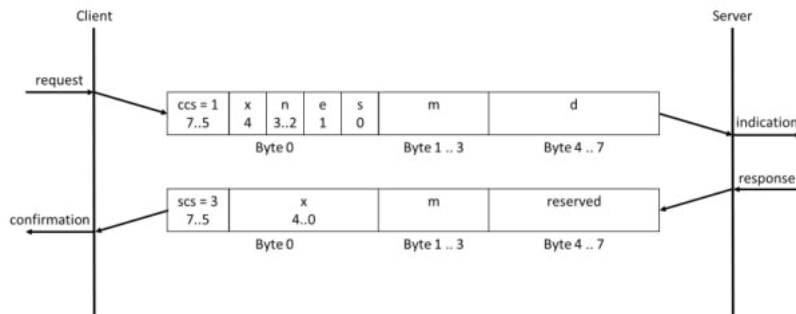

- ccs: client command specifier
 - 1: initiate download request
- scs: server command specifier
 - 3: initiate download response
- n: Only valid if e = 1 and s = 1, otherwise 0. If valid it indicates the number of bytes in d that do not contain data. Bytes [8-n, 7] do not contain data.
- e: transfer type
 - 0: normal transfer
 - 1: expedited transfer
- s: size indicator
 - 0: data set size is not indicated
 - 1: data set size is indicated
- m: multiplexer. It represents the index/sub-index of the data to be transfer by the SDO.

- d: data
 - e = 0, s = 0: d is reserved for further use.
 - e = 0, s = 1: d contains the number of bytes to be downloaded.
 - Byte 4 contains the LSB and byte 7 contains the MSB.
 - e = 1, s = 1: d contains the data of length 4-n to be downloaded, the encoding of this data depends on the type of data referenced by the index and sub-index.
 - e = 1, s = 0: d contains unspecified number of bytes to be downloaded
- x: not used, always 0
- reserved: reserved for further use, always 0

Protocol SDO download segment

The SDO Download Segment protocol is used in CANopen communication to transfer segments of data from a client device to a server device. The data is transferred in segments to accommodate larger amounts of data, with each segment containing up to 7 bytes of data. This protocol is initiated after the SDO Download Initiate protocol has been successfully completed.

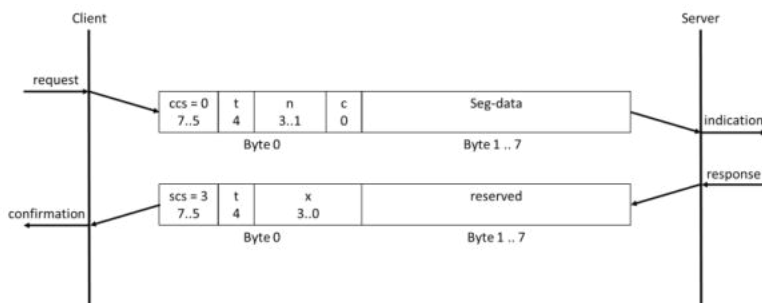

- ccs: client command specifier
 - 0: download segment request
- scs: server command specifier
 - 1: download segment response
- seg-data: at most 7 bytes of segment data to be downloaded. The encoding depends on the type of the data referenced by index and sub-index.
- n: specifies the number of bytes in seg-data that do not contain segment data. Bytes [8-n, 7] do not contain segment data. If n = 0, then bytes 1 to 7 will contain segment data.
 - NOTE: If the size is indicated in the initiation, it applies to the overall transferred data.
- c: indicates whether there are still more segments to be downloaded.
 - 0 more segments to be downloaded

1: no more segments to be downloaded

- t: toggle bit. This bit must alternate for each subsequent segment downloaded. The first segment should have the toggle bit set to 0. The toggle bit must be the same for both the request and the response message.
- X: not used, always 0
- reserved: reserved for further use, always 0

Protocol SDO upload

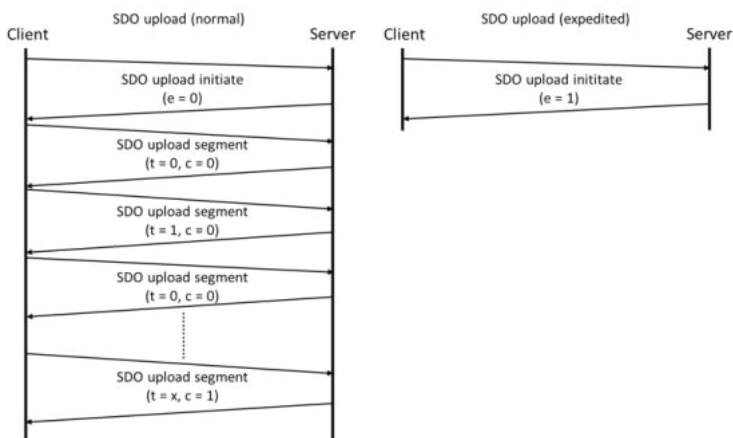

The defined protocol is used to implement the SDO upload service in CANopen communication. The SDOs are uploaded in a series of zero or more SDO upload segment services that are preceded by an SDO upload initiate service. The sequence is terminated by one of the following:

- SDO upload initiate response/confirm, with the e-bit set to 1, which indicates the successful completion of an expedited upload sequence.
- SDO upload segment response/confirm, with the c-bit set to 1, which indicates the successful completion of a normal upload sequence.
- SDO abort transfer request/indication, which indicates the unsuccessful completion of the upload sequence.
- SDO upload initiate request/indication, which indicates the unsuccessful completion of the upload sequence and the start of a new sequence.

If the toggle bit does not alternate in the upload of two consecutive segments, the content of the last segment is ignored. If such an error is reported to the application, the application may decide to abort the upload.

Protocol SDO upload initiate

The SDO upload initiate protocol is a communication protocol used in the CANopen network for uploading data from a CANopen device. The protocol initiates the upload sequence and is followed by zero or more SDO upload segment services. The SDO upload initiate protocol is terminated by a response/confirm message, which can be an SDO upload initiate response/confirm or an SDO abort transfer request/indication.

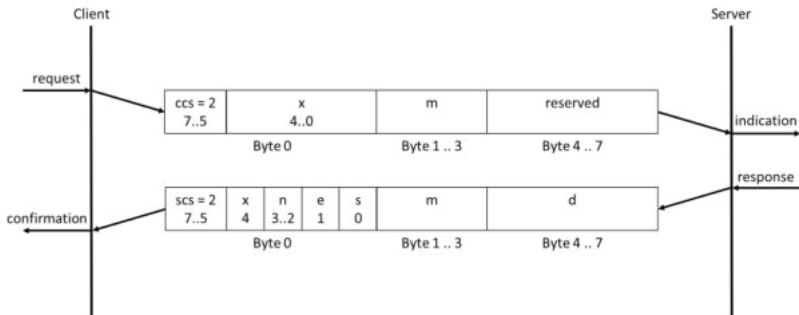

- ccs: client command specifier
2: initiate upload request
- scs: server command specifier
2: initiate upload response
- n: Only valid when e = 1 and s = 1; otherwise 0. It indicates the number of bytes in d that do not contain data. Bytes [8-n, 7] do not contain segment data.
- e: transfer type
0: normal transfer
1: expedited transfer
- s: size indicator
0: data set size is not indicated
1: data set size is indicated

- m: multiplexer. It represents the index/sub-index of the data to be transfer by the SDO.
- d: data
 - e = 0, s = 0: d is reserved for further use.
 - e = 0, s = 1: d contains the number of bytes to be uploaded.
Byte 4 contains the lsb and byte 7 contains the msb.
 - e = 1, s = 1: d contains the data of length 4-n to be uploaded,
the encoding depends on the type of the data referenced by
index and subindex
 - e = 1, s = 0: d contains an unspecified number of bytes to be
uploaded.
- X: not used, always 0
- reserved: reserved for further use , always 0

Protocol SDO upload segment

In CANopen communication, the Protocol SDO upload segment is used to transfer data from the server to the client in a segmented manner. This is done when the data to be transmitted is too large to be sent in a single message. The upload segment service is preceded by an upload initiate service and is followed by zero or more upload segment services until all the data has been transferred.

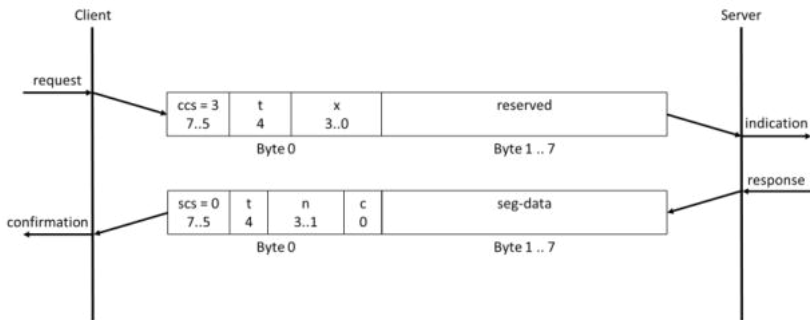

- ccs: client command specifier
 - 3: upload segment request
- scs: server command specifier
 - 0: upload segment response
- t: toggle bit. This bit shall alternate for each subsequent segment that is uploaded. The first segment's toggle-bit must be set to 0. The toggle bit must be the same for both the request and response messages.
- c: indicates whether there are still more segments to be uploaded.
 - 0: more segments to be uploaded
 - 1: no more segments to be uploaded
- seg-data: at most 7 bytes of segment data to be uploaded. The encoding depends on the type of the data referenced by index and sub-index

- n: indicates the number of bytes in seg-data that do not contain segment data. Bytes [8-n, 7] do not contain segment data. If n = 0 bytes 1 to 7 shall contain segment data.

Note that if the size is indicated during initiation, it applies to the overall data transferred.

- X: not used, always 0
- reserved: reserved for further use, always 0

Emergency Object

Emergency objects are triggered by the occurrence of a CANopen device internal error situation and are transmitted from an emergency producer on the CANopen device. Emergency objects are suitable for interrupt type error alerts. An emergency object is transmitted only once per 'error event'. Once an emergency object is sent, no further emergency objects are transmitted unless a new error occurs. The message consists of 8 bytes that provide details about the specific error that occurred.

The Emergency Object consists of two parts: the Emergency message and the Error code. The Emergency message is a CAN message with the following fields:

- ID: the identifier for the Emergency Object, which is $0x80 + \text{node ID}$, where node ID is the identifier of the device that sent the message.
- Data: the data field of the message, which contains the error information.

Heartbeat protocol

The Heartbeat protocol is an important aspect of CANopen communication that monitors the communication status between two devices. A device, acting as a producer, cyclically sends a Heartbeat message into the CAN bus, and one or several devices, acting as consumers, monitor whether the message is received at a determined cycle. If the message is missing, an error is triggered by the monitoring consumer.

The Heartbeat message is transmitted periodically between the consumer and producer devices, with the producer sending the message at regular intervals to indicate its proper operation and communication reception. The message consists of four bytes, including a node ID to identify the producer and a configurable heartbeat value that defines the time interval between consecutive Heartbeat messages. The consumer device takes appropriate action if it doesn't receive a Heartbeat message within a specified time interval and can also send a Heartbeat message to the producer to indicate its own operating status.

The Heartbeat protocol employs the CANopen Network Management (NMT) protocol to manage the Heartbeat messages, including starting, stopping, and controlling them, and monitoring device communication status. The NMT protocol also defines different communication states such as Pre-Operational, Operational, and Stopped, which impact the transmission and reception of Heartbeat messages.

Implementing the Heartbeat protocol is essential for reliable communication between devices and prompt detection of communication failures. The CANopen specification includes comprehensive guidelines for implementing the Heartbeat protocol, including message structure, timing, and error handling. To activate the protocol, writing to object 0x1017 with a value 0 is required.

PDO Communication

CANopen utilizes Process Data Object (PDO) communication to transfer real-time process data such as sensor values, actuator commands, and status information between nodes in a network. PDOs offer faster communication rates than Service Data Objects (SDOs), which are used for configuration and parameterization. PDOs can be transmitted either synchronously or asynchronously, with each PDO consisting of an identifier, a data length code, and up to eight bytes of data.

Each node in a CANopen network can have up to four transmit and four receive PDOs, and PDO mapping is used to map process data from the object dictionary to specific PDOs. PDO mapping specifies the object index and sub-index, as well as the data length. PDO mapping can be either static or dynamic, with static mapping specified at device startup, and dynamic mapping specified during runtime.

The communication parameters for receive PDOs are arranged in the index range 1400h - 15FFh, and for transmit PDOs in the range 1800h - 19FFh. The related mapping entries are managed in the index ranges 1600h - 17FFh and 1A00h - 1BFFh.

PDO mapping defines the sequence and length of the mapped application objects. CANopen supports three types of PDO mapping: static, variable, and dynamic. Static PDO mapping is pre-defined by the device manufacturer and cannot be changed via the CANopen interface. Variable PDO mapping allows mapping entries to be changed during the NMT pre-operational state, and dynamic PDO mapping allows changes to be made during the NMT operational state.

PDOs are an essential feature of CANopen communication because they enable real-time transmission of critical process data between devices. The CANopen specification provides detailed guidelines for implementing PDO communication, including message structure, mapping, and parameterization.

REMOTE CONTROL

This chapter describes basic configuration of IEEE488.2 based remote control.

CAN BUS Configuration	41
CAN BUS Interface.....	41
Setting of the CAN BUS baud rate.....	42
Auto baud rate.....	42
CAN Bus termination resistance	43
Pin assignment.....	44
Object dictionary.....	45
General structure.....	45
Definitions	46
Communication profile	47
Manufacturer-specific profile.....	49
Communication Command List	74
Manufacturer-specific Command List.....	80
SDO Abort Transmission (CANopen Errors).....	273

CAN BUS Configuration

CAN BUS Interface

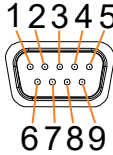
CAN BUS Configuration	Connector Parameters	BD-9, male Protocol, Baudrate, Node ID
Pin Assignment		2: CAN-L 3, 5: GND 7: CAN-H 1, 4, 6, 8, 9: No connection

- Steps**
1. Connect a CAN BUS cable from the PC to the CAN BUS port on the rear panel.
 2. Press the *Menu* key. The Menu setting will appear on the display. 
 3. Use the scroll wheel to go to item 6, *Option Interface* and press *Enter*.
 4. Set the CAN BUS relative settings.

Protocol	Canopen
Baudrate	125K(default), 250K, 500K, 1M, Auto
MAC ID	1 ~ 127 (127 is default value)
- Exit**
5. Press *Exit[F8]* to exit from the CAN BUS settings. 

CAN BUS Configuration



Setting of the CAN BUS baud rate

Depending on the set bit rate the length of the bus line is restricted. The specified max. bus length is an approximate value and also depends on the other devices on the bus.

Baud rate	Max. bus length
125K	500 m
250K	250 m
500K	100 m
1M	40 m

Auto baud rate

The CAN BUS of ASR6000 supports auto baud rate mode. When the Baud rate is switched to "Auto", the system will start to detect the baud rate mode. At this time, the master in the CAN BUS network must send more than 1 Byte of data. When ASR6000 receives after receiving the packet, the baud rate detection is completed and the system will automatically set the same baud rate as the master.

CAN Bus termination resistance

CAN bus networks require a specific characteristic impedance (typically 120 ohms) to operate properly. This characteristic impedance is maintained by placing termination resistors at both ends of the network, which effectively terminate the CAN signal and prevent signal reflections that can cause errors and signal corruption.

To add terminal resistance, you need to connect a 120 Ohm resistor between the CAN_H and CAN_L lines at each end of the network. The termination resistors are typically placed at the two ends of the bus network, which could be at the physical ends of the network or at the last two nodes in the network.

If the network has only two nodes, both nodes must have termination resistors. However, if there are more than two nodes, only the two nodes at the physical ends of the network require termination resistors.

To add a termination resistor to a CAN connector on ASR6000, you should connect the CAN connector on the ASR6000 through a CAN cable with the second last device in the network. Then, cover the CAN connector with a CAN terminal connector (with a 120 Ohm resistor between CAN-L and CAN-H) to provide proper termination for the network.

It's important to note that failure to add termination resistors can result in poor network performance and communication issues. So, it's essential to ensure proper termination of the network to maintain its integrity and reliable performance.

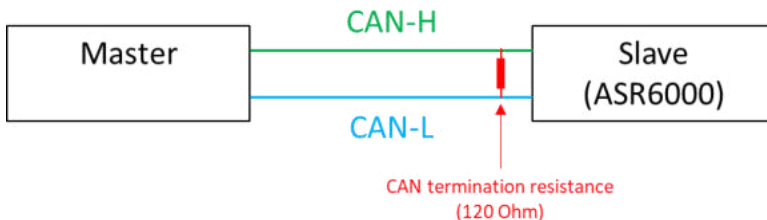

Pin assignment

The CAN BUS port have the following pin assignments:

Pin	Signal
1	Not assigned
2	CAN-L
3	CAN GND
4	Not assigned
5	Shield
6	GND (CAN GND)
7	CAN-H
8	Not assigned
9	Not assigned

Object dictionary

General structure

The object dictionary is a crucial part of a CANopen node that stores and retrieves configuration and process data. It is structured as a table with up to 65,536 objects that are addressed through a 16-bit index and up to 256 sub-indices per object, which are addressed through an 8-bit sub-index.

Index	Object
0000h	not used
0001h - 001Fh	Static data types
0020h - 003Fh	Complex data type
0040h - 005Fh	Manufacturer-specific complex data types
0060h - 025Fh	Device profile specific data types
0260h - 03FFh	reserved
0400h - 0FFFh	reserved
1000h - 1FFFh	Communication profile area
2000h - 5FFFh	Manufacturer-specific profile area

The object dictionary is divided into different sections with specific index ranges. The static data types at indices from 0001h to 001Fh define standard data types such as BOOLEAN, INTEGER, UNSIGNED, floating point, string, and others. The complex data types at indices from 0020h to 003Fh are predefined structures that consist of standard data types and are common to all CANopen devices.

The manufacturer-specific complex data types at indices from 0040h to 005Fh consist of structures that use standard data types but are specific to a particular CANopen device. Device profiles may define additional data types that are specific to their device type, and they are listed at indices from 0060h to 025Fh. The object dictionary also has reserved index ranges, such as indices from 0260h to 03FFh and indices from 0400h to 0FFFh.

The communication profile area at indices from 1000h to 1FFFh contains communication-specific parameters that are common to all CANopen devices. The manufacturer-specific profile area is at indices from 2000h to 5FFFh.

Definitions

In the following the below listed terms and abbreviations are used:

Index	Description
ro	Only read access (read-only)
wo	Only write access (write-only)
rw	Read and write access (read-write)

Communication profile

The following table shows all objects of the communication profile which are supported by the device:

Index	Read (0x40)	Write (0x23)	sub-index	Name	Attribute	Data type
0x1000	V			Device Type	ro	Unsigned32
0x1001	V			Error Register	ro	Unsigned8
	V	V	0	Pre-defined Error Field	rw	Unsigned8
	V	V	1	Pre-defined Error Field	rw	Unsigned32
	V	V	2	Pre-defined Error Field	rw	Unsigned32
	V	V	3	Pre-defined Error Field	rw	Unsigned32
	V	V	4	Pre-defined Error Field	rw	Unsigned32
0x1003	V	V	5	Pre-defined Error Field	rw	Unsigned32
	V	V	6	Pre-defined Error Field	rw	Unsigned32
	V	V	7	Pre-defined Error Field	rw	Unsigned32
	V	V	8	Pre-defined Error Field	rw	Unsigned32
	V	V	9	Pre-defined Error Field	rw	Unsigned32
	V	V	10	Pre-defined Error Field	rw	Unsigned32
0x1005	V	V		COB-ID SYNC message	rw	Unsigned8
	V	V	0	Store Parameters	rw	Unsigned32
	V	V	1	Store Parameters	rw	Unsigned32
0x1010	V	V	2	Store Parameters	rw	Unsigned32
	V	V	3	Store Parameters	rw	Unsigned32
	V	V	4	Store Parameters	rw	Unsigned32

Index	Read (0x40)	Write (0x23)	sub-index	Name	Attribute	Data type
0x1014	V			COB-ID Emergency Object	ro	Unsigned32
0x1017	V			Producer Heartbeat Time	rw	Unsigned16
	V		0	Identity Object	ro	Unsigned8
	V		1	Identity Object	ro	Unsigned32
0x1018	V		2	Identity Object	ro	Unsigned32
	V		3	Identity Object	ro	Unsigned32
	V		4	Identity Object	ro	Unsigned32

Manufacturer-specific profile

The following table shows all objects of the Manufacturer-specific profile which are supported by the device:

Index	Read (0x40)	Write (0x23)	sub-index	SCTP command	Attribute	Data type	Data size (Bytes)
0x2002		V		*CLS	wo	Unsigned8	1
0x2005	V			*IDN?	ro	char	36
0x2007		V		*RCL	wo	Unsigned8	1
0x2008		V		*RST	wo	Unsigned8	1
0x2009		V		*SAV	wo	Unsigned8	1
0x200E		V		*WAI	wo	Unsigned8	1
0x2202		V		DATA:SEquence:CLEar	wo	Unsigned8	1
0x2204		V		DATA:SEquence:RECall	wo	Unsigned8	1
0x2205		V		DATA:SEquence:STORE	wo	Unsigned8	1
0x2206		V		DATA:SIMulation:CLEar	wo	Unsigned8	1
0x2208		V		DATA:SIMulation:RECall	wo	Unsigned8	1
0x2209		V		DATA:SIMulation:STORE	wo	Unsigned8	1
0x2213		V		DATA:WAVE:CLEar	wo	Unsigned8	1
0x2215		V	0	DATA:WAVE[:DATA]	wo	Unsigned32	8192
		V	1	DATA:WAVE[:DATA]	wo	Unsigned32	8192
		V	2	DATA:WAVE[:DATA]	wo	Unsigned32	8192
		V	3	DATA:WAVE[:DATA]	wo	Unsigned32	8192
		V	4	DATA:WAVE[:DATA]	wo	Unsigned32	8192
		V	5	DATA:WAVE[:DATA]	wo	Unsigned32	8192

Index	Read (0x40)	Write (0x23)	sub-index	SCPI command	Attribute	Data type	Data size (Bytes)
	V		6	DATA:WAVE[:DATA]	wo	Unsigned32	8192
	V		7	DATA:WAVE[:DATA]	wo	Unsigned32	8192
	V		8	DATA:WAVE[:DATA]	wo	Unsigned32	8192
	V		9	DATA:WAVE[:DATA]	wo	Unsigned32	8192
	V		10	DATA:WAVE[:DATA]	wo	Unsigned32	8192
	V		11	DATA:WAVE[:DATA]	wo	Unsigned32	8192
	V		12	DATA:WAVE[:DATA]	wo	Unsigned32	8192
	V		13	DATA:WAVE[:DATA]	wo	Unsigned32	8192
	V		14	DATA:WAVE[:DATA]	wo	Unsigned32	8192
	V		15	DATA:WAVE[:DATA]	wo	Unsigned32	8192
0x2301	V			DISPlay[:WINDow]:DESIgn:MODE	wo	Unsigned8	1
	V	V	0	DISPlay[:WINDow]:MEASure:SOURce	rw	Unsigned8	1
0x2302	V	V	1	DISPlay[:WINDow]:MEASure:SOURce	rw	Unsigned8	1
	V	V	2	DISPlay[:WINDow]:MEASure:SOURce	rw	Unsigned8	1
	V	V	3	DISPlay[:WINDow]:MEASure:SOURce	rw	Unsigned8	1
0x2310	V			DISPLAY_ADDRESS	wo	Unsigned8	1
0x2501	V			FETCh[:SCALar]:CURRent:CFACtor	ro	Signed32	4
0x2502	V			FETCh[:SCALar]:CURRent:HIGH	ro	Signed32	4
0x2503	V			FETCh[:SCALar]:CURRent:LOW	ro	Signed32	4
0x2504	V			FETCh[:SCALar]:CURRent	ro	Signed32	4

Index	Read (0x40)	Write (0x23)	sub-index	SCPI command	Attribute	Data type	Data size (Bytes)
				t:PEAK:HOLD			
0x2505	V			FETCh[;SCALar]:CURRen t[:RMS]	ro	Signed32	4
0x2506	V			FETCh[;SCALar]:CURRen t[:RMS]:TOTal	ro	Signed32	4
0x2507	V			FETCh[;SCALar]:CURRen t:AC	ro	Signed32	4
0x2508	V			FETCh[;SCALar]:CURRen t:AVERAge	ro	Signed32	4
0x2509	V			FETCh[;SCALar]:FREQue ncy	ro	Signed32	4
0x250A	V			FETCh[;SCALar]:POWer[: AC]:APParent	ro	Signed32	4
0x250B	V			FETCh[;SCALar]:POWer[: AC]:APParent:TOTal	ro	Signed32	4
0x250C	V			FETCh[;SCALar]:POWer[: AC]:PFACTOR	ro	Signed32	4
0x250D	V			FETCh[;SCALar]:POWer[: AC]:PFACTOR:TOTal	ro	Signed32	4
0x250E	V			FETCh[;SCALar]:POWer[: AC]:REACTive	ro	Signed32	4
0x250F	V			FETCh[;SCALar]:POWer[: AC]:REACTive:TOTal	ro	Signed32	4
0x2510	V			FETCh[;SCALar]:POWer[: AC]:[:REAL]	ro	Signed32	4
0x2511	V			FETCh[;SCALar]:POWer[: AC]:[:REAL]:TOTal	ro	Signed32	4
0x2512	V			FETCh[;SCALar]:VOLTag e[:RMS]	ro	Signed32	4
0x2513	V			FETCh[;SCALar]:VOLTag e[:RMS]:TOTal	ro	Signed32	4
0x2514	V			FETCh[;SCALar]:VOLTag e:AC	ro	Signed32	4

Index	Read (0x40)	Write (0x23)	sub-index	SCPI command	Attribute	Data type	Data size (Bytes)
0x2515	V			FETCh[:SCALar]:VOLTag e:AVERAge	ro	Signed32	4
0x2516	V			FETCh[:SCALar]:VOLTag e:HIGH	ro	Signed32	4
0x2517	V			FETCh[:SCALar]:VOLTag e:LOW	ro	Signed32	4
0x2518	V		0	FETCh[:SCALar]:CURRen t:HARMonic[:RMS]	ro	Signed32	4
	V		1	FETCh[:SCALar]:CURRen t:HARMonic[:RMS]	ro	Signed32	80
	V		2	FETCh[:SCALar]:CURRen t:HARMonic[:RMS]	ro	Signed32	80
	V		3	FETCh[:SCALar]:CURRen t:HARMonic[:RMS]	ro	Signed32	80
	V		4	FETCh[:SCALar]:CURRen t:HARMonic[:RMS]	ro	Signed32	80
	V		5	FETCh[:SCALar]:CURRen t:HARMonic[:RMS]	ro	Signed32	80
0x2519	V		0	FETCh[:SCALar]:CURRen t:HARMonic:RATio	ro	Signed32	4
	V		1	FETCh[:SCALar]:CURRen t:HARMonic:RATio	ro	Signed32	80
	V		2	FETCh[:SCALar]:CURRen t:HARMonic:RATio	ro	Signed32	80
	V		3	FETCh[:SCALar]:CURRen t:HARMonic:RATio	ro	Signed32	80
	V		4	FETCh[:SCALar]:CURRen t:HARMonic:RATio	ro	Signed32	80
	V		5	FETCh[:SCALar]:CURRen t:HARMonic:RATio	ro	Signed32	80
0x251A	V		0	FETCh[:SCALar]:VOLTag e:HARMonic[:RMS]	ro	Signed32	4
	V		1	FETCh[:SCALar]:VOLTag	ro	Signed32	80

Index	Read (0x40)	Write (0x23)	sub-index	SCPI command	Attribute	Data type	Data size (Bytes)
				e:HARMonic[:RMS]			
	V		2	FETCh[:SCALar]:VOLTag e:HARMonic[:RMS]	ro	Signed32	80
	V		3	FETCh[:SCALar]:VOLTag e:HARMonic[:RMS]	ro	Signed32	80
	V		4	FETCh[:SCALar]:VOLTag e:HARMonic[:RMS]	ro	Signed32	80
	V		5	FETCh[:SCALar]:VOLTag e:HARMonic[:RMS]	ro	Signed32	80
0x251B	V		0	FETCh[:SCALar]:VOLTag e:HARMonic:RATio	ro	Signed32	4
	V		1	FETCh[:SCALar]:VOLTag e:HARMonic:RATio	ro	Signed32	80
	V		2	FETCh[:SCALar]:VOLTag e:HARMonic:RATio	ro	Signed32	80
	V		3	FETCh[:SCALar]:VOLTag e:HARMonic:RATio	ro	Signed32	80
	V		4	FETCh[:SCALar]:VOLTag e:HARMonic:RATio	ro	Signed32	80
	V		5	FETCh[:SCALar]:VOLTag e:HARMonic:RATio	ro	Signed32	80
0x251C	V			FETCh[:SCALar]:LINE:V OLTag[:RMS]	ro	Signed32	4
0x251D	V			FETCh[:SCALar]:LINE:V OLTag:AVERAge	ro	Signed32	4
0x251E	V			FETCh[:SCALar]:LINE:V OLTag:HIGH	ro	Signed32	4
0x251F	V			FETCh[:SCALar]:LINE:V OLTag:LOW	ro	Signed32	4
0x2603	V	V		INPut:GAIN	rw	Unsigned16	2
0x2604	V	V		INPut:SOURce	rw	Unsigned8	1
0x2605	V	V		INPut:SYNC:SOURce	rw	Unsigned8	1

Index	Read (0x40)	Write (0x23)	sub-index	SCPI command	Attribute	Data type	Data size (Bytes)
0x2701	V	V		INSTrument:EDIT	rw	Unsigned8	1
0x2702	V	V		INSTrument:SElect	rw	Unsigned8	1
0x2801	V	V		MEASure:AVERage:COU Nt	rw	Unsigned8	1
0x2802	V	V		MEASure:CONFigure:SE NSing	rw	Unsigned8	1
0x2803	V	V		MEASure:UPDate:RATE	rw	Unsigned8	1
0x2804	V			MEASure[:SCALar]:CUR Rent:CFACtor	ro	Signed32	4
0x2805	V			MEASure[:SCALar]:CUR Rent:HIGH	ro	Signed32	4
0x2806	V			MEASure[:SCALar]:CUR Rent:LOW	ro	Signed32	4
0x2807	V			MEASure[:SCALar]:CUR Rent:PEAK:HOLD	ro	Signed32	4
0x2808	V			MEASure[:SCALar]:CUR Rent[:RMS]	ro	Signed32	4
0x2809	V			MEASure[:SCALar]:CUR Rent[:RMS]:TOTal	ro	Signed32	4
0x280A	V			MEASure[:SCALar]:CUR Rent:AC	ro	Signed32	4
0x280B	V			MEASure[:SCALar]:CUR Rent:AVERage	ro	Signed32	4
0x280C	V			MEASure[:SCALar]:FREQu ency	ro	Signed32	4
0x280D		V		MEASure[:SCALar]:PEA K:CLEar	wo	Unsigned8	1
0x280E	V			MEASure[:SCALar]:POW er[:AC]:APParent	ro	Signed32	4
0x280F	V			MEASure[:SCALar]:POW er[:AC]:APParent:TOTal	ro	Signed32	4
0x2810	V			MEASure[:SCALar]:POW	ro	Signed32	4

Index	Read (0x40)	Write (0x23)	sub-index	SCPI command	Attribute	Data type	Data size (Bytes)
				er[:AC]:PFACtor			
0x2811	V			MEASure[:SCALar]:POWer[:AC]:PFACtor:TOTal	ro	Signed32	4
0x2812	V			MEASure[:SCALar]:POWer[:AC]:REACtive	ro	Signed32	4
0x2813	V			MEASure[:SCALar]:POWer[:AC]:REACtive:TOTal	ro	Signed32	4
0x2814	V			MEASure[:SCALar]:POWer[:AC][:REAL]	ro	Signed32	4
0x2815	V			MEASure[:SCALar]:POWer[:AC][:REAL]:TOTal	ro	Signed32	4
0x2816	V			MEASure[:SCALar]:VOLTag[:RMS]	ro	Signed32	4
0x2817	V			MEASure[:SCALar]:VOLTag[:RMS]:TOTal	ro	Signed32	4
0x2818	V			MEASure[:SCALar]:VOLTag:AC	ro	Signed32	4
0x2819	V			MEASure[:SCALar]:VOLTag:AVERAge	ro	Signed32	4
0x281A	V			MEASure[:SCALar]:VOLTag:HIGH	ro	Signed32	4
0x281B	V			MEASure[:SCALar]:VOLTag:LOW	ro	Signed32	4
	V		0	MEASure[:SCALar]:CURRent:HARMonic[:RMS]	ro	Signed32	4
	V		1	MEASure[:SCALar]:CURRent:HARMonic[:RMS]	ro	Signed32	80
0x281D	V		2	MEASure[:SCALar]:CURRent:HARMonic[:RMS]	ro	Signed32	80
	V		3	MEASure[:SCALar]:CURRent:HARMonic[:RMS]	ro	Signed32	80
	V		4	MEASure[:SCALar]:CURRent:HARMonic[:RMS]	ro	Signed32	80

Index	Read (0x40)	Write (0x23)	sub-index	SCPI command	Attribute	Data type	Data size (Bytes)
0x281E	V		5	MEASure[:SCALar]:CURRent:HARMonic[:RMS]	ro	Signed32	80
	V		0	MEASure[:SCALar]:CURRent:HARMonic:RATio	ro	Signed32	4
	V		1	MEASure[:SCALar]:CURRent:HARMonic:RATio	ro	Signed32	80
	V		2	MEASure[:SCALar]:CURRent:HARMonic:RATio	ro	Signed32	80
	V		3	MEASure[:SCALar]:CURRent:HARMonic:RATio	ro	Signed32	80
	V		4	MEASure[:SCALar]:CURRent:HARMonic:RATio	ro	Signed32	80
	V		5	MEASure[:SCALar]:CURRent:HARMonic:RATio	ro	Signed32	80
0x281F	V		0	MEASure[:SCALar]:VOLTag:e:HARMonic[:RMS]	ro	Signed32	4
	V		1	MEASure[:SCALar]:VOLTag:e:HARMonic[:RMS]	ro	Signed32	80
	V		2	MEASure[:SCALar]:VOLTag:e:HARMonic[:RMS]	ro	Signed32	80
	V		3	MEASure[:SCALar]:VOLTag:e:HARMonic[:RMS]	ro	Signed32	80
	V		4	MEASure[:SCALar]:VOLTag:e:HARMonic[:RMS]	ro	Signed32	80
	V		5	MEASure[:SCALar]:VOLTag:e:HARMonic[:RMS]	ro	Signed32	80
0x2820	V		0	MEASure[:SCALar]:VOLTag:e:HARMonic:RATio	ro	Signed32	4
	V		1	MEASure[:SCALar]:VOLTag:e:HARMonic:RATio	ro	Signed32	80
	V		2	MEASure[:SCALar]:VOLTag:e:HARMonic:RATio	ro	Signed32	80
	V		3	MEASure[:SCALar]:VOLTag:e:HARMonic:RATio	ro	Signed32	80
	V		4	MEASure[:SCALar]:VOLTag:e:HARMonic:RATio	ro	Signed32	80

Index	Read (0x40)	Write (0x23)	sub-index	SCPI command	Attribute	Data type	Data size (Bytes)
				Tag:Harmonic:Ratio			
	V		4	MEASure[:SCALar]:VOL Tag:Harmonic:Ratio	ro	Signed32	80
	V		5	MEASure[:SCALar]:VOL Tag:Harmonic:Ratio	ro	Signed32	80
0x2821	V			MEASure[:SCALar]:LINE: VOLTage[:RMS]	ro	Signed32	4
0x2822	V			MEASure[:SCALar]:LINE: VOLTage:AVERage	ro	Signed32	4
0x2823	V			MEASure[:SCALar]:LINE: VOLTage:HIGH	ro	Signed32	4
0x2824	V			MEASure[:SCALar]:LINE: VOLTage:LOW	ro	Signed32	4
0x2904		V		MEMory:SAV	wo	Unsigned8	1
0x2905		V		MEMory:RCL	wo	Unsigned8	1
0x2A01	V	V		OUTPut:IMPedance	rw	Unsigned8	1
0x2A02	V	V	0	OUTPut:IMPedance:IND uctance	rw	Unsigned16	2
0x2A02	V	V	1	OUTPut:IMPedance:IND uctance	rw	Unsigned16	2
	V	V	2	OUTPut:IMPedance:IND uctance	rw	Unsigned16	2
0x2A03	V	V	0	OUTPut:IMPedance:RESi stance	rw	Unsigned16	2
	V	V	1	OUTPut:IMPedance:RESi stance	rw	Unsigned16	2
	V	V	2	OUTPut:IMPedance:RESi stance	rw	Unsigned16	2
0x2A04	V	V		OUTPut:MONitor:AMPLi tude	rw	Unsigned8	1
0x2A05	V	V	0	OUTPut:MONitor:SOURc e	rw	Unsigned8	1

Index	Read (0x40)	Write (0x23)	sub-index	SCPI command	Attribute	Data type	Data size (Bytes)
	V	V	1	OUTPut:MONitor:SOURce	rw	Unsigned8	1
0x2A06	V	V		OUTPut:PON	rw	Unsigned8	1
0x2A07		V		OUTPut:PROTection:CLear	wo	Unsigned8	1
0x2A08	V	V		OUTPut:RELAy	rw	Unsigned8	1
0x2A0A	V	V		OUTPut[:STATe]	rw	Unsigned8	1
0x2C02	V	V		SYSTem:ARBitrary:EDIT:BUILtin	rw	Unsigned8	1
0x2C03	V	V	0	SYSTem:ARBitrary:EDIT:CFACtor	rw	Unsigned16	2
	V	V	1	SYSTem:ARBitrary:EDIT:CFACtor	rw	Unsigned8	1
0x2C04	V	V		SYSTem:ARBitrary:EDIT:CLIP	rw	Unsigned16	2
0x2C05	V	V	0	SYSTem:ARBitrary:EDIT:DIP	rw	Unsigned32	4
	V	V	1	SYSTem:ARBitrary:EDIT:DIP	rw	Unsigned32	4
	V	V	2	SYSTem:ARBitrary:EDIT:DIP	rw	Unsigned32	4
0x2C06	V	V	0	SYSTem:ARBitrary:EDIT:LFRing	rw	Unsigned32	4
	V	V	1	SYSTem:ARBitrary:EDIT:LFRing	rw	Unsigned32	4
	V	V	2	SYSTem:ARBitrary:EDIT:LFRing	rw	Unsigned32	4
	V	V	3	SYSTem:ARBitrary:EDIT:LFRing	rw	Unsigned32	4
	V	V	4	SYSTem:ARBitrary:EDIT:LFRing	rw	Unsigned32	4

Index	Read (0x40)	Write (0x23)	sub-index	SCPI command	Attribute	Data type	Data size (Bytes)
	V	V	5	SYSTEM:ARbitrary:EDIT:LFRing	rw	Unsigned32	4
	V	V	6	SYSTEM:ARbitrary:EDIT:LFRing	rw	Unsigned32	4
	V	V	7	SYSTEM:ARbitrary:EDIT:LFRing	rw	Unsigned32	4
	V	V	0	SYSTEM:ARbitrary:EDIT:RIPple	rw	Unsigned8	1
0x2C07	V	V	1	SYSTEM:ARbitrary:EDIT:RIPple	rw	Unsigned16	2
	V	V	2	SYSTEM:ARbitrary:EDIT:RIPple	rw	Unsigned16	2
0x2C08	V	V		SYSTEM:ARbitrary:EDIT:STAir	rw	Unsigned8	1
0x2C09		V		SYSTEM:ARbitrary:EDIT:STORe	wo	Unsigned8	1
0x2C0A		V	0	SYSTEM:ARbitrary:EDIT:STORe:APPLy	wo	Unsigned8	1
		V	1	SYSTEM:ARbitrary:EDIT:STORe:APPLy	wo	Unsigned8	1
		V	2	SYSTEM:ARbitrary:EDIT:STORe:APPLy	wo	Unsigned8	1
0x2C0B	V	V	0	SYSTEM:ARbitrary:EDIT:SURGe	rw	Unsigned8	1
	V	V	1	SYSTEM:ARbitrary:EDIT:SURGe	rw	Unsigned16	2
	V	V	2	SYSTEM:ARbitrary:EDIT:SURGe	rw	Unsigned16	2
0x2C0C	V	V		SYSTEM:ARbitrary:EDIT:TRlangle	rw	Unsigned16	2
0x2C0D	V	V		SYSTEM:VUNit	rw	Unsigned8	1
0x2C0E	V	V		SYSTEM:BEEPer:STATe	rw	Unsigned8	1

Index	Read (0x40)	Write (0x23)	sub-index	SCPI command	Attribute	Data type	Data size (Bytes)
0x2C11	V	V		SYSTem:COMMunicate:INTerface:ADDRes	rw	Unsigned8	1
0x2C12	V	V		SYSTem:COMMunicate:INTerface:BAUD	rw	Unsigned8	1
0x2C13	V	V		SYSTem:COMMunicate:LAN:DHCP	rw	Unsigned8	1
0x2C14	V	V		SYSTem:COMMunicate:LAN:DNS	rw	Unsigned8	4
0x2C15	V	V		SYSTem:COMMunicate:LAN:GATeway	rw	Unsigned8	4
0x2C17	V	V		SYSTem:COMMunicate:LAN:IPADdress	rw	Unsigned8	4
0x2C18	V			SYSTem:COMMunicate:LAN:MAC	ro	char	17
0x2C19	V	V		SYSTem:COMMunicate:LAN:SMASK	rw	Unsigned8	4
0x2C1C	V	V		SYSTem:COMMunicate:RLState	rw	Unsigned8	1
0x2C1D	V	V		SYSTem:COMMunicate:SERial[:RECeive]:TRANsmit:BAUD	rw	Unsigned8	1
0x2C1E	V	V		SYSTem:COMMunicate:SERial[:RECeive]:TRANsmit:BITS	rw	Unsigned8	1
0x2C1F	V	V		SYSTem:COMMunicate:SERial[:RECeive]:TRANsmit:PARity	rw	Unsigned8	1
0x2C20	V	V		SYSTem:COMMunicate:SERial[:RECeive]:TRANsmit:SBITS	rw	Unsigned8	1
0x2C21	V			SYSTem:COMMunicate:TCPIP:CONTRol	ro	Unsigned16	2
0x2C22	V			SYSTem:COMMunicate:USB:FRONT:STATe	ro	Unsigned8	1

Index	Read (0x40)	Write (0x23)	sub-index	SCPI command	Attribute	Data type	Data size (Bytes)
0x2C24	V			SYSTem:COMMunicate:USB:REAR:STATe	ro	Unsigned8	1
0x2C25	V	V		SYSTem:CONFigure:EXTio[:STATe]	rw	Unsigned8	1
0x2C26	V	V		SYSTem:CONFigure:PHASe	rw	Unsigned8	1
0x2C27	V	V		SYSTem:CONFigure[:MODE]	rw	Unsigned8	1
0x2C28	V	V		SYSTem:CONFigure:TRIGGER:OUTPut:SOURce	rw	Unsigned8	1
0x2C29	V	V		SYSTem:CONFigure:TRIGGER:OUTPut:WIDTh	rw	Unsigned8	1
0x2C2C	V	V		SYSTem:KLOCK	rw	Unsigned8	1
0x2C2E	V	V		SYSTem:PKHold:TIME	rw	Unsigned16	2
0x2C2F		V		SYSTem:REBoot	wo	Unsigned8	1
0x2C32	V	V		SYSTem:HOLD:STATe	rw	Unsigned8	1
0x2D03		V		TRACe:SEQuence:CLEar	wo	Unsigned8	1
0x2D07		V		TRACe:SEQuence:RECall	wo	Unsigned8	1
0x2D08		V		TRACe:SEQuence:STORe	wo	Unsigned8	1
0x2D09		V		TRACe:SIMulation:CLEar	wo	Unsigned8	1
0x2D0D		V		TRACe:SIMulation:RECal	wo	Unsigned8	1
0x2D0E		V		TRACe:SIMulation:STORe	wo	Unsigned8	1
0x2D12		V		TRACe:WAVE:CLEar	wo	Unsigned8	1
0x2D14		V	0	TRACe:WAVE[:DATA]	wo	Unsigned32	8192
		V	1	TRACe:WAVE[:DATA]	wo	Unsigned32	8192

Index	Read (0x40)	Write (0x23)	sub-index	SCPI command	Attribute	Data type	Data size (Bytes)
	V		2	TRACe:WAVE[:DATA]	wo	Unsigned32	8192
	V		3	TRACe:WAVE[:DATA]	wo	Unsigned32	8192
	V		4	TRACe:WAVE[:DATA]	wo	Unsigned32	8192
	V		5	TRACe:WAVE[:DATA]	wo	Unsigned32	8192
	V		6	TRACe:WAVE[:DATA]	wo	Unsigned32	8192
	V		7	TRACe:WAVE[:DATA]	wo	Unsigned32	8192
	V		8	TRACe:WAVE[:DATA]	wo	Unsigned32	8192
	V		9	TRACe:WAVE[:DATA]	wo	Unsigned32	8192
	V		10	TRACe:WAVE[:DATA]	wo	Unsigned32	8192
	V		11	TRACe:WAVE[:DATA]	wo	Unsigned32	8192
	V		12	TRACe:WAVE[:DATA]	wo	Unsigned32	8192
	V		13	TRACe:WAVE[:DATA]	wo	Unsigned32	8192
	V		14	TRACe:WAVE[:DATA]	wo	Unsigned32	8192
	V		15	TRACe:WAVE[:DATA]	wo	Unsigned32	8192
0x2E05	V			TRIGger:SEquence:SElected:EXECute	wo	Unsigned8	1
0x2E06	V			TRIGger:SIMulation:SElected:EXECute	wo	Unsigned8	1
0x3001	V	V		[:SOURce]:CURRent:LIMit:PEAK:HIGH	rw	Unsigned32	4
0x3002	V	V		[:SOURce]:CURRent:LIMit:PEAK:LOW	rw	Signed32	4
0x3003	V	V		[:SOURce]:CURRent:LIMit:PEAK:MODE	rw	Unsigned8	1
0x3004	V	V		[:SOURce]:CURRent:LIMit:RMS[:AMPLitude]	rw	Unsigned32	4

Index	Read (0x40)	Write (0x23)	sub-index	SCPI command	Attribute	Data type	Data size (Bytes)
0x3005	V	V		[:SOURce]:CURRent:LIMit:RMS:MODE	rw	Unsigned8	1
0x3006	V	V		[:SOURce]:FREQuency:LIMit:HIGH	rw	Unsigned32	4
0x3007	V	V		[:SOURce]:FREQuency:LIMit:LOW	rw	Unsigned32	4
0x3008	V	V		[:SOURce]:FREQuency[:IMMediate]	rw	Unsigned32	4
0x3009	V	V		[:SOURce]:FUNCTion[:SHAPE][:IMMediate]	rw	Unsigned8	1
0x300A	V	V		[:SOURce]:FUNCTion:THD:FORMat	rw	Unsigned8	1
0x300B	V	V		[:SOURce]:LINE:VOLTage[:LEVel][:IMMediate][:AMPLitude]	rw	Unsigned32	4
0x300C	V	V		[:SOURce]:LINE:VOLTage[:LEVel][:IMMediate]:OFFSet	rw	Signed32	4
0x300D	V	V		[:SOURce]:PHASe:BALance	rw	Unsigned8	1
0x300E	V	V		[:SOURce]:PHASe:MODE	rw	Unsigned8	1
0x300F	V	V	0	[:SOURce]:PHASe:PHASe	rw	Unsigned16	2
	V	V	1	[:SOURce]:PHASe:PHASe	rw	Unsigned16	2
0x3010	V	V		[:SOURce]:PHASe:RELock	rw	Unsigned8	1
0x3011	V	V		[:SOURce]:PHASe:SETChange:STATe	rw	Unsigned8	1
0x3012	V	V		[:SOURce]:PHASe:START[:IMMediate]	rw	Unsigned16	2
0x3013	V	V		[:SOURce]:PHASe:START:STATe	rw	Unsigned8	1
0x3014	V	V		[:SOURce]:PHASe:STOP[:	rw	Unsigned16	2

Index	Read (0x40)	Write (0x23)	sub-index	SCPI command	Attribute	Data type	Data size (Bytes)
				IMMEDIATE]			
0x3015	V	V		[:SOURce]:PHASe:STOP:STATe	rw	Unsigned8	1
0x3016	V	V		[:SOURce]:PHASe:SYNC[:IMMEDIATE]	rw	Unsigned16	2
	V		0	[:SOURce]:READ	ro	Signed32	4
	V		1	[:SOURce]:READ	ro	Signed32	4
	V		2	[:SOURce]:READ	ro	Signed32	4
	V		3	[:SOURce]:READ	ro	Signed32	4
	V		4	[:SOURce]:READ	ro	Signed32	4
	V		5	[:SOURce]:READ	ro	Signed32	4
	V		6	[:SOURce]:READ	ro	Signed32	4
	V		7	[:SOURce]:READ	ro	Signed32	4
	V		8	[:SOURce]:READ	ro	Signed32	4
0x3017	V		9	[:SOURce]:READ	ro	Signed32	4
	V		10	[:SOURce]:READ	ro	Signed32	4
	V		11	[:SOURce]:READ	ro	Signed32	4
	V		12	[:SOURce]:READ	ro	Signed32	4
	V		13	[:SOURce]:READ	ro	Signed32	4
	V		14	[:SOURce]:READ	ro	Signed32	4
	V		15	[:SOURce]:READ	ro	Signed32	4
	V		16	[:SOURce]:READ	ro	Signed32	4
	V		17	[:SOURce]:READ	ro	Signed32	4
	V		18	[:SOURce]:READ	ro	Signed32	4

Index	Read (0x40)	Write (0x23)	sub-index	SCPI command	Attribute	Data type	Data size (Bytes)
	V		19	[:SOURce]:READ	ro	Signed32	4
	V		20	[:SOURce]:READ	ro	Signed32	4
	V		21	[:SOURce]:READ	ro	Signed32	4
	V		22	[:SOURce]:READ	ro	Signed32	4
	V		23	[:SOURce]:READ	ro	Signed32	4
	V		24	[:SOURce]:READ	ro	Signed32	4
	V		25	[:SOURce]:READ	ro	Signed32	4
	V		26	[:SOURce]:READ	ro	Signed32	4
	V		27	[:SOURce]:READ	ro	Signed32	4
	V		28	[:SOURce]:READ	ro	Signed32	4
	V		29	[:SOURce]:READ	ro	Signed32	4
	V		30	[:SOURce]:READ	ro	Signed32	4
	V		31	[:SOURce]:READ	ro	Signed32	4
	V		32	[:SOURce]:READ	ro	Signed32	4
	V		33	[:SOURce]:READ	ro	Signed32	4
	V		34	[:SOURce]:READ	ro	Signed32	4
	V		35	[:SOURce]:READ	ro	Signed32	4
	V		36	[:SOURce]:READ	ro	Signed32	4
	V		37	[:SOURce]:READ	ro	Signed32	4
	V		38	[:SOURce]:READ	ro	Signed32	4
	V		39	[:SOURce]:READ	ro	Signed32	4
	V		40	[:SOURce]:READ	ro	Signed32	4
	V		41	[:SOURce]:READ	ro	Signed32	4

Index	Read (0x40)	Write (0x23)	sub-index	SCPI command	Attribute	Data type	Data size (Bytes)
	V		42	[:SOURce]:READ	ro	Signed32	4
	V		43	[:SOURce]:READ	ro	Signed32	4
	V		44	[:SOURce]:READ	ro	Signed32	4
	V		45	[:SOURce]:READ	ro	Signed32	4
	V		46	[:SOURce]:READ	ro	Signed32	4
	V		47	[:SOURce]:READ	ro	Signed32	4
	V		48	[:SOURce]:READ	ro	Signed32	4
	V		49	[:SOURce]:READ	ro	Signed32	4
	V		50	[:SOURce]:READ	ro	Signed32	4
0x3030	V			[:SOURce]:SEQuence:CO NDition	ro	Unsigned8	1
	V	V	0	[:SOURce]:SEQuence:CPA Rameter	rw	Unsigned32	4
	V	V	1	[:SOURce]:SEQuence:CPA Rameter	rw	Unsigned16	2
	V	V	2	[:SOURce]:SEQuence:CPA Rameter	rw	Unsigned8	1
	V	V	3	[:SOURce]:SEQuence:CPA Rameter	rw	Unsigned16	2
0x3031	V	V	4	[:SOURce]:SEQuence:CPA Rameter	rw	Unsigned8	1
	V	V	5	[:SOURce]:SEQuence:CPA Rameter	rw	Unsigned8	1
	V	V	6	[:SOURce]:SEQuence:CPA Rameter	rw	Unsigned16	2
	V	V	7	[:SOURce]:SEQuence:CPA Rameter	rw	Unsigned8	1
	V	V	8	[:SOURce]:SEQuence:CPA Rameter	rw	Unsigned16	2

Index	Read (0x40)	Write (0x23)	sub-index	SCPI command	Attribute	Data type	Data size (Bytes)
	V	V	9	[:SOURce]:SEQuence:CPA Rameter	rw	Unsigned8	1
	V	V	10	[:SOURce]:SEQuence:CPA Rameter	rw	Unsigned16	2
	V	V	11	[:SOURce]:SEQuence:CPA Rameter	rw	Unsigned8	1
	V	V	12	[:SOURce]:SEQuence:CPA Rameter	rw	Unsigned16	2
	V	V	13	[:SOURce]:SEQuence:CPA Rameter	rw	Unsigned8	1
	V	V	14	[:SOURce]:SEQuence:CPA Rameter	rw	Unsigned8	1
0x3032	V			[:SOURce]:SEQuence:CST ep	ro	Unsigned16	2
0x3033	V	V		[:SOURce]:SEQuence:INS Trument:SELEct	rw	Unsigned8	1
	V	V	0	[:SOURce]:SEQuence:SPA Rameter	rw	Unsigned32	4
	V	V	1	[:SOURce]:SEQuence:SPA Rameter	rw	Unsigned8	1
	V	V	2	[:SOURce]:SEQuence:SPA Rameter	rw	Unsigned32	4
	V	V	3	[:SOURce]:SEQuence:SPA Rameter	rw	Unsigned8	1
0x3034	V	V	4	[:SOURce]:SEQuence:SPA Rameter	rw	Unsigned32	4
	V	V	5	[:SOURce]:SEQuence:SPA Rameter	rw	Unsigned8	1
	V	V	6	[:SOURce]:SEQuence:SPA Rameter	rw	Unsigned8	1
	V	V	7	[:SOURce]:SEQuence:SPA Rameter	rw	Unsigned16	2
0x3035	V	V		[:SOURce]:SEQuence:STE	rw	Unsigned16	2

Index	Read (0x40)	Write (0x23)	sub-index	SCPI command	Attribute	Data type	Data size (Bytes)
0x3036	V			[:SOURce]:SIMulation:CO NDition	ro	Unsigned8	1
0x3037	V	V		[:SOURce]:SIMulation:AB Normal:CODE	rw	Unsigned8	1
0x3038	V	V		[:SOURce]:SIMulation:AB Normal:FREQuency	rw	Unsigned32	4
0x3039	V	V		[:SOURce]:SIMulation:AB Normal:PHASe:STARt:EN ABLE	rw	Unsigned8	1
0x303A	V	V		[:SOURce]:SIMulation:AB Normal:PHASe:STARt[:IM MMediate]	rw	Unsigned16	2
0x303B	V	V		[:SOURce]:SIMulation:AB Normal:PHASe:STOP:EN ABLE	rw	Unsigned8	1
0x303C	V	V		[:SOURce]:SIMulation:AB Normal:PHASe:STOP[:IM Mediate]	rw	Unsigned16	2
0x303D	V	V		[:SOURce]:SIMulation:AB Normal:TIME	rw	Unsigned32	4
0x303E	V	V		[:SOURce]:SIMulation:AB Normal:VOLTag	rw	Unsigned32	4
0x303F	V			[:SOURce]:SIMulation:CS Tep	ro	Unsigned8	1
0x3040	V	V		[:SOURce]:SIMulation:INI Tial:CODE	rw	Unsigned8	1
0x3041	V	V		[:SOURce]:SIMulation:INI Tial:FREQuency	rw	Unsigned32	4
0x3042	V	V		[:SOURce]:SIMulation:INI Tial:PHASe:STARt:ENAB le	rw	Unsigned8	1
0x3043	V	V		[:SOURce]:SIMulation:INI Tial:PHASe:STARt[:IMMe	rw	Unsigned16	2

Index	Read (0x40)	Write (0x23)	sub-index	SCPI command	Attribute	Data type	Data size (Bytes)
				diatiate]			
0x3044	V	V		[:SOURce]:SIMulation:INI Tial:PHASe:STOP:ENABl e	rw	Unsigned8	1
0x3045	V	V		[:SOURce]:SIMulation:INI Tial:PHASe:STOP[:IMMe diatiate]	rw	Unsigned16	2
0x3046	V	V		[:SOURce]:SIMulation:INI Tial:VOLTage	rw	Unsigned32	4
0x3048	V	V	0	[:SOURce]:SIMulation:NO RMal:CODE	rw	Unsigned8	1
	V	V	1	[:SOURce]:SIMulation:NO RMal:CODE	rw	Unsigned8	1
0x3049	V	V	0	[:SOURce]:SIMulation:NO RMal:FREQuency	rw	Unsigned32	4
	V	V	1	[:SOURce]:SIMulation:NO RMal:FREQuency	rw	Unsigned32	4
0x304A	V	V	0	[:SOURce]:SIMulation:NO RMal:PHASe:STARt:ENA Ble	rw	Unsigned8	1
	V	V	1	[:SOURce]:SIMulation:NO RMal:PHASe:STARt:ENA Ble	rw	Unsigned8	1
0x304B	V	V	0	[:SOURce]:SIMulation:NO RMal:PHASe:STARt[:IM Mediate]	rw	Unsigned16	2
	V	V	1	[:SOURce]:SIMulation:NO RMal:PHASe:STARt[:IM Mediate]	rw	Unsigned16	2
0x304C	V	V	0	[:SOURce]:SIMulation:NO RMal:PHASe:STOP:ENA Ble	rw	Unsigned8	1
	V	V	1	[:SOURce]:SIMulation:NO RMal:PHASe:STOP:ENA Ble	rw	Unsigned8	1

Index	Read (0x40)	Write (0x23)	sub-index	SCPI command	Attribute	Data type	Data size (Bytes)
0x304D	V	V	0	[:SOURce]:SIMulation:NO RMal:PHASe:STOP[:IMM ediate]	rw	Unsigned16	2
	V	V	1	[:SOURce]:SIMulation:NO RMal:PHASe:STOP[:IMM ediate]	rw	Unsigned16	2
0x304E	V	V	0	[:SOURce]:SIMulation:NO RMal:TIME	rw	Unsigned32	4
	V	V	1	[:SOURce]:SIMulation:NO RMal:TIME	rw	Unsigned32	4
0x304F	V	V	0	[:SOURce]:SIMulation:NO RMal:VOLTag	rw	Unsigned32	4
	V	V	1	[:SOURce]:SIMulation:NO RMal:VOLTag	rw	Unsigned32	4
0x3050	V	V		[:SOURce]:SIMulation:RE Peat:COUNT	rw	Unsigned16	2
0x3051	V	V		[:SOURce]:SIMulation:RE Peat:ENABLE	rw	Unsigned8	1
0x3052	V	V	0	[:SOURce]:SIMulation:TR ANsition:CODE	rw	Unsigned8	1
	V	V	1	[:SOURce]:SIMulation:TR ANsition:CODE	rw	Unsigned8	1
0x3053	V	V	0	[:SOURce]:SIMulation:TR ANsition:TIME	rw	Unsigned32	4
	V	V	1	[:SOURce]:SIMulation:TR ANsition:TIME	rw	Unsigned32	4
0x3060	V	V	0	[:SOURce]:SEQuence:NSP arameter	rw	Unsigned32	4
	V	V	1	[:SOURce]:SEQuence:NSP arameter	rw	Unsigned8	1
	V	V	2	[:SOURce]:SEQuence:NSP arameter	rw	Unsigned32	4
	V	V	3	[:SOURce]:SEQuence:NSP arameter	rw	Unsigned8	1

Index	Read (0x40)	Write (0x23)	sub-index	SCPI command	Attribute	Data type	Data size (Bytes)
	V	V	4	[:SOURce]:SEQuence:NSP arameter	rw	Unsigned32	4
	V	V	5	[:SOURce]:SEQuence:NSP arameter	rw	Unsigned8	1
	V	V	6	[:SOURce]:SEQuence:NSP arameter	rw	Unsigned8	1
	V	V	7	[:SOURce]:SEQuence:NSP arameter	rw	Unsigned16	2
	V	V	8	[:SOURce]:SEQuence:NSP arameter	rw	Unsigned16	2
0x3101	V	V		[:SOURce]:SQUare:DCYC le	rw	Unsigned16	2
0x3102	V	V		[:SOURce]:VOLTage:LIMi t:PEAK	rw	Unsigned32	4
0x3103	V	V		[:SOURce]:VOLTage:LIMi t:RMS	rw	Unsigned32	4
0x3104	V	V		[:SOURce]:VOLTage:LIMi t:HIGH	rw	Unsigned32	4
0x3105	V	V		[:SOURce]:VOLTage:LIMi t:LOW	rw	Signed32	4
0x3106	V	V		[:SOURce]:VOLTage:RAN Ge	rw	Unsigned8	1
0x3107	V	V		[:SOURce]:VOLTage:RES Ponse	rw	Unsigned8	1
0x3108	V	V		[:SOURce]:VOLTage[:LEV el][:IMMediate][:AMPLitu de]	rw	Unsigned32	4
0x3109	V	V		[:SOURce]:VOLTage[:LEV el][:IMMediate]:OFFSet	rw	Signed32	4
0x310A	V	V		[:SOURce]:MODE	rw	Unsigned8	1
0x3601	V		0	DATA_RANGE_MAX	ro	Unsigned32	4
	V		1	DATA_RANGE_MAX	ro	Signed32	4

Index	Read (0x40)	Write (0x23)	sub-index	SCPI command	Attribute	Data type	Data size (Bytes)
	V		2	DATA_RANGE_MAX	ro	Unsigned32	4
	V		3	DATA_RANGE_MAX	ro	Unsigned32	4
	V		4	DATA_RANGE_MAX	ro	Unsigned16	2
	V		5	DATA_RANGE_MAX	ro	Unsigned16	2
	V		6	DATA_RANGE_MAX	ro	Unsigned16	2
	V		7	DATA_RANGE_MAX	ro	Unsigned16	2
	V		8	DATA_RANGE_MAX	ro	Unsigned16	2
	V		9	DATA_RANGE_MAX	ro	Unsigned16	2
	V		10	DATA_RANGE_MAX	ro	Unsigned32	4
	V		11	DATA_RANGE_MAX	ro	Signed32	4
	V		12	DATA_RANGE_MAX	ro	Unsigned32	4
	V		13	DATA_RANGE_MAX	ro	Signed32	4
	V		14	DATA_RANGE_MAX	ro	Unsigned32	4
	V		15	DATA_RANGE_MAX	ro	Unsigned32	4
	V		0	DATA_RANGE_MIN	ro	Unsigned32	4
	V		1	DATA_RANGE_MIN	ro	Signed32	4
	V		2	DATA_RANGE_MIN	ro	Unsigned32	4
	V		3	DATA_RANGE_MIN	ro	Unsigned32	4
0x3602	V		4	DATA_RANGE_MIN	ro	Unsigned16	2
	V		5	DATA_RANGE_MIN	ro	Unsigned16	2
	V		6	DATA_RANGE_MIN	ro	Unsigned16	2
	V		7	DATA_RANGE_MIN	ro	Unsigned16	2
	V		8	DATA_RANGE_MIN	ro	Unsigned16	2

Index	Read (0x40)	Write (0x23)	sub-index	SCPI command	Attribute	Data type	Data size (Bytes)
	V		9	DATA_RANGE_MIN	ro	Unsigned16	2
	V		10	DATA_RANGE_MIN	ro	Unsigned32	4
	V		11	DATA_RANGE_MIN	ro	Signed32	4
	V		12	DATA_RANGE_MIN	ro	Unsigned32	4
	V		13	DATA_RANGE_MIN	ro	Signed32	4
	V		14	DATA_RANGE_MIN	ro	Unsigned32	4
	V		15	DATA_RANGE_MIN	ro	Unsigned32	4

Communication Command List

Object 0x1000: Device Type	74
Object 0x1001: Error Register.....	75
Object 0x1003: Pre-defined Error Field.....	76
Object 0x1005: COB-ID SYNC message	76
Object 0x1010: Store parameters	77
Object 0x1014: COB-ID Emergency Object.....	78
Object 0x1017: Producer Heartbeat Time.....	78
Object 0x1018: Identity Object	78

Object 0x1000: Device Type

Description	The CANopen node is not implemented according to a standardized profile.
Index	0x1000
Sub-Index	0x00
Name	Device Type
Type	Unsigned32
Access	ro

Object 0x1001: Error Register

Description	This object shall provide the errors that occurred on the CANopen device and were signaled via the emergency object. In doing so it provides an error history.
Index	0x1001
Sub-Index	0x00
Name	Device Type
Type	Unsigned8
Access	ro

The following table shows the structure: Bit 0 is set at each error. Additionally set bits specify the error more precisely.

Bit	Meaning
0	General error
1	Current
2	Voltage
3	Temperature
4	Communication
5	Device profile specific
6	Reserved
7	Manufacturer specific

Object 0x1003: Pre-defined Error Field

Description	This object shall provide the errors that occurred on the CANopen device and were signaled via the emergency object. In doing so it provides an error history.
Index	0x1003
Sub-Index	0x00
Name	Number of errors
Type	Unsigned8
Access	rw
Sub-Index	0x01 to 0x10
Name	Pre-defined Error Field
Type	Unsigned32
Access	ro

Object 0x1005: COB-ID SYNC message

Description	This object shall indicate the configured COB-ID of the synchronization object (SYNC). Further, it defines whether the CANopen device generates the SYNC.
Index	0x1005
Sub-Index	0x00
Name	COB-ID SYNC message
Type	Unsigned32
Access	rw

Object 0x1010: Store parameters

Description	This object shall control the saving of parameters in non-volatile memory.
Index	0x1010
Sub-Index	0x00
Name	COB-ID SYNC message
Type	Unsigned8
Access	ro
Sub-Index	0x01
Name	save all parameters
Type	Unsigned32
Access	rw
Sub-Index	0x02
Name	save communication parameters
Type	Unsigned32
Access	rw
Sub-Index	0x03
Name	save application parameters
Type	Unsigned32
Access	rw
Sub-Index	0x04 ~ 0x7H
Name	save manufacturer defined parameters
Type	Unsigned32
Access	rw

Object 0x1014: COB-ID Emergency Object

Description	This object shall indicate the configured COB-ID for the EMCY write service.
Index	0x1014
Sub-Index	0x00
Name	COB-ID Emergency Object
Type	Unsigned32
Access	ro

Object 0x1017: Producer Heartbeat Time

Description	The producer heartbeat time shall indicate the configured cycle time of the heartbeat.
Index	0x1017
Sub-Index	0x00
Name	Producer heartbeat time
Type	Unsigned16
Access	rw

Object 0x1018: Identity Object

Description	This object shall provide general identification information of the CANopen device.
Index	0x1018
Sub-Index	0x00
Name	Number of supported entries
Type	Unsigned8
Access	ro
Sub-Index	0x01

Name	Vendor ID
Type	Unsigned32
Access	ro
Sub-Index	0x02
Name	Device description
Type	Unsigned32
Access	ro
Sub-Index	0x03
Name	Revision number
Type	Unsigned32
Access	ro
Sub-Index	0x04
Name	Serial number
Type	Unsigned32
Access	ro

Manufacturer-specific Command List

Common Commands

Object 0x2002: *CLS	88
Object 0x2005: *IDN	88
Object 0x2007: *RCL	91
Object 0x2008: *RST	91
Object 0x2009: *SAV	92
Object 0x200E: *WAI	92

Data/Trace Commands

Object 0x2202 0x2D03: DATA TRACe:SEQuence:CLear	93
Object 0x2204 0x2D07: DATA TRACe:SEQuence:RECall	94
Object 0x2205 0x2D08: DATA TRACe:SEQuence:STORe	94
Object 0x2206 0x2D09: DATA TRACe:SIMulation:CLear	95
Object 0x2208 0x2D0D: DATA TRACe:SIMulation:RECall	96
Object 0x2209 0x2D0E: DATA TRACe:SIMulation:STORe	96
Object 0x2213 0x2D12: DATA TRACe:WAVe:CLear	97
Object 0x2215 0x2D14: DATA TRACe:WAVe[DATA]	98

Measure Commands

Object 0x2804: MEASure[:SCALar]:CURRent:CFACtor	100
Object 0x2805: MEASure[:SCALar]:CURRent:HIGH	100
Object 0x2806: MEASure[:SCALar]:CURRent:LOW	101
Object 0x2807: MEASure[:SCALar]:CURRent:PEAK:HOLD	102
Object 0x2808: MEASure[:SCALar]:CURRent[:RMS]	102
Object 0x2809: MEASure[:SCALar]:CURRent[:RMS]:TOTal	103
Object 0x280A: MEASure[:SCALar]:CURRent:AC	103
Object 0x280B: MEASure[:SCALar]:CURRent:AVERage	104
Object 0x281D: MEASure[:SCALar]:CURRent:HARMonic[:RMS]	104
Object 0x281E: MEASure[:SCALar]:CURRent:HARMonic:RATio	107
Object 0x280C: MEASure[:SCALar]:FREQuency	110
Object 0x280D: MEASure[:SCALar]:PEAK:CLear	110

Object 0x280E: MEASure[:SCALar]:POWer[:AC]:APParent.....	111
Object 0x280F: MEASure[:SCALar]:POWer[:AC]:APParent:TOTal...	112
Object 0x2810: MEASure[:SCALar]:POWer[:AC]:PFACTor	113
Object 0x2811: MEASure[:SCALar]:POWer[:AC]:PFACTor:TOTal.....	113
Object 0x2812: MEASure[:SCALar]:POWer[:AC]:REACTive	114
Object 0x2813: MEASure[:SCALar]:POWer[:AC]:REACTive:TOTal ..	114
Object 0x2814: MEASure[:SCALar]:POWer[:AC][:REAL]	115
Object 0x2815: MEASure[:SCALar]:POWer[:AC][:REAL]:TOTal	116
Object 0x2816: MEASure[:SCALar]:VOLTage[:RMS]	116
Object 0x2817: MEASure[:SCALar]:VOLTage[:RMS]:TOTal	117
Object 0x2818: MEASure[:SCALar]:VOLTage:AC.....	117
Object 0x2819: MEASure[:SCALar]:VOLTage:AVERage.....	118
Object 0x281A: MEASure[:SCALar]:VOLTage:HIGh.....	118
Object 0x281B: MEASure[:SCALar]:VOLTage:LOW	119
Object 0x2821: MEASure[:SCALar]:LINE:VOLTage[:RMS]	120
Object 0x2822: MEASure[:SCALar]:LINE:VOLTage:AVERage	120
Object 0x2823: MEASure[:SCALar]:LINE:VOLTage:HIGh.....	121
Object 0x2824: MEASure[:SCALar]:LINE:VOLTage:LOW.....	122
Object 0x281F: MEASure[:SCALar]:VOLTage:HARMonic[:RMS]	122
Object 0x2820: MEASure[:SCALar]:VOLTage:HARMonic:RATio.....	125
Object 0x2802: MEASure:CONFigure:SENSing	127
Object 0x2801: MEASure:AVERage:COUNt.....	127
Object 0x2803: MEASure:UPDate:RATE.....	128

Fetch Commands

Object 0x2501: FETCh[:SCALar]:CURRent:CFACToR.....	131
Object 0x2502: FETCh[:SCALar]:CURRent:HIGh.....	131
Object 0x2503: FETCh[:SCALar]:CURRent:LOW	132
Object 0x2504: FETCh[:SCALar]:CURRent:PEAK:HOLD	133
Object 0x2505: FETCh[:SCALar]:CURRent[:RMS].....	133
Object 0x2506: FETCh[:SCALar]:CURRent[:RMS]:TOTal.....	134
Object 0x2507: FETCh[:SCALar]:CURRent:AC	135
Object 0x2508: FETCh[:SCALar]:CURRent:AVERage	135
Object 0x2518: FETCh[:SCALar]:CURRent:HARMonic[:RMS]	136
Object 0x2519: FETCh[:SCALar]:CURRent:HARMonic:RATio.....	138
Object 0x2509: FETCh[:SCALar]:FREQuency	140
Object 0x250A: FETCh[:SCALar]:POWer[:AC]:APParent	141
Object 0x250B: FETCh[:SCALar]:POWer[:AC]:APParent:TOTal	142

Object 0x250C: FETCh[:SCALar]:POWer[:AC]:PFACtor.....	142
Object 0x250D: FETCh[:SCALar]:POWer[:AC]:PFACtor:TOTal.....	143
Object 0x250E: FETCh[:SCALar]:POWer[:AC]:REACtive.....	143
Object 0x250F: FETCh[:SCALar]:POWer[:AC]:REACtive:TOTal	144
Object 0x2510: FETCh[:SCALar]:POWer[:AC][:REAL]	145
Object 0x2511: FETCh[:SCALar]:POWer[:AC][:REAL]:TOTal	145
Object 0x2512: FETCh[:SCALar]:VOLTage[:RMS]	146
Object 0x2513: FETCh[:SCALar]:VOLTage[:RMS]:TOTal	146
Object 0x2514: FETCh[:SCALar]:VOLTage:AC.....	147
Object 0x2515: FETCh[:SCALar]:VOLTage:AVERage.....	148
Object 0x2516: FETCh[:SCALar]:VOLTage:HIGH	148
Object 0x2517: FETCh[:SCALar]:VOLTage:LOW	149
Object 0x251C: FETCh[:SCALar]:LINE:VOLTage[:RMS]	150
Object 0x251D: FETCh[:SCALar]:LINE:VOLTage:AVERage	150
Object 0x251E: FETCh[:SCALar]:LINE:VOLTage:HIGH.....	151
Object 0x251F: FETCh[:SCALar]:LINE:VOLTage:LOW	152
Object 0x251A: FETCh[:SCALar]: VOLTage:HARMonic[:RMS]	152
Object 0x251B: FETCh[:SCALar]:VOLTage:HARMonic:RATio.....	155

Memory Commands

Object 0x2905: MEMory:RCL	158
Object 0x2904: MEMory:SAV	159

Output Commands

Object 0x2A01: OUTPut:IMPedance.....	160
Object 0x2A02: OUTPut:IMPedance:INDuctance	161
Object 0x2A03: OUTPut:IMPedance:RESistance	161
Object 0x2A04: OUTPut:MONitor:AMPLitude	162
Object 0x2A05: OUTPut:MONitor:SOURce<1 2>.....	163
Object 0x2A0A: OUTPut[:STATE]	163
Object 0x2A06: OUTPut:PON	164
Object 0x2A07: OUTPut:PROTection:CLEar	165
Object 0x2A08: OUTPut:RELay	165

System Commands

Object 0x2C02: SYSTem:ARBitrary:EDIT:BUILtin.....	167
Object 0x2C0B: SYSTem:ARBitrary:EDIT:SURGe	168
Object 0x2C08: SYSTem:ARBitrary:EDIT:STAir.....	170
Object 0x2C03: SYSTem:ARBitrary:EDIT:CFACtor<1 2>.....	170
Object 0x2C04: SYSTem:ARBitrary:EDIT:CLIP	172
Object 0x2C09: SYSTem:ARBitrary:EDIT:STORE.....	172
Object 0x2C0C: SYSTem:ARBitrary:EDIT:TRlangle.....	174
Object 0x2C05: SYSTem:ARBitrary:EDIT:DIP	174
Object 0x2C06: SYSTem:ARBitrary:EDIT:LFRing.....	176
Object 0x2C07: SYSTem:ARBitrary:EDIT:RIPple	179
Object 0x2C0A: SYSTem:ARBitrary:EDIT:STORE:APPLY<1 3>	180
Object 0x2C0E: SYSTem:BEEPer:STATe	183
Object 0x2C11: SYSTem:COMMunicate:INTerface:ADDRes	183
Object 0x2C12: SYSTem:COMMunicate:INTerface:BAUD	184
Object 0x2C13: SYSTem:COMMunicate:LAN:DHCP.....	185
Object 0x2C14: SYSTem:COMMunicate:LAN:DNS.....	185
Object 0x2C15: SYSTem:COMMunicate:LAN:GATeway	186
Object 0x2C17: SYSTem:COMMunicate:LAN:IPAddress.....	186
Object 0x2C18: SYSTem:COMMunicate:LAN:MAC.....	187
Object 0x2C19: SYSTem:COMMunicate:LAN:SMASK.....	188
Object 0x2C1C: SYSTem:COMMunicate:RLState.....	189
Object 0x2C1D:	
SYSTem:COMMunicate:SERial[:RECeive]:TRANsmit:BAUD	190
Object 0x2C1E:	
SYSTem:COMMunicate:SERial[:RECeive]:TRANsmit:BITS.....	191
Object 0x2C1F:	
SYSTem:COMMunicate:SERial[:RECeive]:TRANsmit:PARity	191
Object 0x2C20:	
SYSTem:COMMunicate:SERial[:RECeive]:TRANsmit:SBITs	192
Object 0x2C21: SYSTem:COMMunicate:TCPIP:CONTRol.....	193
Object 0x2C22: SYSTem:COMMunicate:USB:FRONt:STATe	194
Object 0x2C24: SYSTem:COMMunicate:USB:REAR:STATe	194
Object 0x2C27: SYSTem:CONFigure[:MODE]	194
Object 0x2C25: SYSTem:CONFigure:EXTio[:STATe]	195
Object 0x2C26: SYSTem:CONFigure:PHASe.....	195
Object 0x2C28: SYSTem:CONFigure:TRIGger:OUTPut:SOURce	196

Object 0x2C29: SYSTem:CONFigure:TRIGger:OUTPut:WIDTh	197
Object 0x2C32: SYSTem:HOLD:STATe.....	197
Object 0x2C2E: SYSTem:PKHold:TIME.....	198
Object 0x2C2C: SYSTem:KLOCK.....	198
Object 0x2C2F: SYSTem:REBoot.....	199
Object 0x2C0D: SYSTem:VUNit	199

Source Commands

Object 0x2701: INSTRument:EDIT	201
Object 0x2702: INSTRument:SELEct.....	202
Object 0x3001: [:SOURce]:CURRent:LIMit:PEAK:HIGH.....	202
Object 0x3002: [:SOURce]:CURRent:LIMit:PEAK:LOW	203
Object 0x3004: [:SOURce]:CURRent:LIMit:RMS[:AMPLitude]	204
Object 0x3003: [:SOURce]:CURRent:LIMit:PEAK:MODE	205
Object 0x3005: [:SOURce]:CURRent:LIMit:RMS:MODE	205
Object 0x3006: [:SOURce]:FREQuency:LIMit:HIGH.....	206
Object 0x3007: [:SOURce]:FREQuency:LIMit:LOW	206
Object 0x3008: [:SOURce]:FREQuency[:IMMediate]	207
Object 0x3009: [:SOURce]:FUNCTion[:SHAPe][:IMMediate].....	207
Object 0x300A: [:SOURce]:FUNCTion:THD:FORMat	209
Object 0x300B:	
[:SOURce]:LINE:VOLTage[:LEVel][:IMMediate][:AMPLitude]	210
Object 0x300C: [:SOURce]:LINE:VOLTage[:LEVel][:IMMediate]:OFFSet	211
Object 0x310A: [:SOURce]:MODE.....	212
Object 0x300D: [:SOURce]:PHASe:BALance.....	213
Object 0x300E: [:SOURce]:PHASe:MODE.....	213
Object 0x300F: [:SOURce]:PHASe:PHASe.....	214
Object 0x3010: [:SOURce]:PHASe:RELock	215
Object 0x3011: [:SOURce]:PHASe:SETChange:STATe	215
Object 0x3013: [:SOURce]:PHASe:STARt:STATe.....	216
Object 0x3015: [:SOURce]:PHASe:STOP:STATe	217
Object 0x3012: [:SOURce]:PHASe:STARt[:IMMediate]	217
Object 0x3014: [:SOURce]:PHASe:STOP[:IMMediate]	218
Object 0x3016: [:SOURce]:PHASe:SYNC[:IMMediate].....	219
Object 0x3017: [:SOURce]:READ	219
Object 0x3106: [:SOURce]:VOLTage:RANGe	221
Object 0x3107: [:SOURce]:VOLTage:RESPonse.....	222

Object 0x3103: [:SOURCE]:VOLTage:LIMit:RMS.....	223
Object 0x3102: [:SOURCE]:VOLTage:LIMit:PEAK	224
Object 0x3104: [:SOURCE]:VOLTage:LIMit:HIGH	224
Object 0x3105: [:SOURCE]:VOLTage:LIMit:LOW.....	225
Object 0x3108: [:SOURCE]:VOLTage[:LEVel][:IMMediate][:AMPLitude]	226
Object 0x3109: [:SOURCE]:VOLTage[:LEVel][:IMMediate]:OFFSet	226
Object 0x3101: [:SOURCE]:SQUare:DCYCLE.....	227

Sequence Commands

Object 0x3031: [:SOURCE]:SEQuence:CPARameter.....	228
Object 0x3032: [:SOURCE]:SEQuence:CSTep	231
Object 0x3033: [:SOURCE]:SEQuence:INSTrument:SElect	232
Object 0x3034: [:SOURCE]:SEQuence:SPARameter.....	233
Object 0x3035: [:SOURCE]:SEQuence:STEP.....	235
Object 0x3030: [:SOURCE]:SEQuence:CONDition.....	236
Object 0x2E05: TRIGger:SEQuence:SElected:EXECute	237
Object 0x3060: [:SOURCE]:SEQuence:NSParameter.....	237

Simulate Commands

Object 0x3036: [:SOURCE]:SIMulation:CONDition.....	242
Object 0x3037: [:SOURCE]:SIMulation:ABNormal:CODE	243
Object 0x3038: [:SOURCE]:SIMulation:ABNormal:FREQuency	243
Object 0x3039: [:SOURCE]:SIMulation:ABNormal:PHASe:STARt:ENABLE.....	244
Object 0x303A: [:SOURCE]:SIMulation:ABNormal:PHASe:STARt[:IMMediate]	245
Object 0x303B [:SOURCE]:SIMulation:ABNormal:PHASe:STOP:ENABLE	245
Object 0x303C: [:SOURCE]:SIMulation:ABNormal:PHASe:STOP[:IMMediate]	246
Object 0x303D: [:SOURCE]:SIMulation:ABNormal:TIME.....	247
Object 0x303E: [:SOURCE]:SIMulation:ABNormal:VOLTage.....	247
Object 0x303F: [:SOURCE]:SIMulation:CSTep	248
Object 0x3040: [:SOURCE]:SIMulation:INITial:CODE	249

Object 0x3041: [:SOURce]:SIMulation:INITial:FREQuency 250

Object 0x3042: [:SOURce]:SIMulation:INITial:PHASe:STARt:ENABle
..... 250

Object 0x3043:
[:SOURce]:SIMulation:INITial:PHASe:STARt[:IMMediate] 251

Object 0x3044: [:SOURce]:SIMulation:INITial:PHASe:STOP:ENABle 252

Object 0x3045:
[:SOURce]:SIMulation:INITial:PHASe:STOP[:IMMediate] 252

Object 0x3046: [:SOURce]:SIMulation:INITial:VOLTagE 253

Object 0x3048: [:SOURce]:SIMulation:NORMal<1 | 2>:CODE 254

Object 0x3049: [:SOURce]:SIMulation:NORMal 1:FREQuency 255

Object 0x304A:
[:SOURce]:SIMulation:NORMal<1 | 2>:PHASe:STARt:ENABle 256

Object 0x304B:
[:SOURce]:SIMulation:NORMal<1 | 2>:PHASe:STARt[:IMMediate] 257

Object 0x304C:
[:SOURce]:SIMulation:NORMal<1 | 2>:PHASe:STOP:ENABle 258

Object 0x304D:
[:SOURce]:SIMulation:NORMal<1 | 2>:PHASe:STOP[:IMMediate] 259

Object 0x304E: [:SOURce]:SIMulation:NORMal<1 | 2>:TIME 260

Object 0x304F: [:SOURce]:SIMulation:NORMal 1:VOLTagE 261

Object 0x3050: [:SOURce]:SIMulation:REPeat:COUNT 262

Object 0x3051: [:SOURce]:SIMulation:REPeat:ENABle 262

Object 0x3053: [:SOURce]:SIMulation:TRANsition<1 | 2>:TIME 263

Object 0x3052: [:SOURce]:SIMulation:TRANsition<1 | 2>:CODE 264

Object 0x2E06: TRIGger:SIMulation:SELEcted:EXECute 265

Input Subsystem Command

Object 0x2002: *CLS 88

Object 0x2005: *IDN 88

Object 0x2007: *RCL 91

Object 0x2008: *RST 91

Object 0x2009: *SAV 92

Object 0x200E: *WAI 92

Display Command

Object 0x2301: DISPlay[:WINDow]:DESIgn:MODE	269
Object 0x2302: DISPlay[:WINDow]:MEASure:SOURce<1 2 3 4> ..	270
Object 0x2310: DISPLAY_ADDRESS	272

Read Data Range Commands

Object 0x3601: DATA_RANGE_MAX.....	273
Object 0x3602: DATA_RANGE_MIN.....	276

Common Commands

Object 0x2002: *CLS	88
Object 0x2005: *IDN	88
Object 0x2007: *RCL.....	91
Object 0x2008: *RST.....	91
Object 0x2009: *SAV.....	92
Object 0x200E: *WAI.....	92

Object 0x2002: *CLS

Description	The *CLS command clears all the event registers, including the status byte, event status and error queue.
Index	0x2002
Sub-Index	0x00
Value	-
Type	Unsigned8
Data size	1 Byte
Access	wo
Example (SDO)	23 02 20 00 00 00 00 00 (*CLS) Sets the *CLS command.

Object 0x2005: *IDN

Description	Queries the manufacturer, model name, serial number, and firmware version of the ASR.
Index	0x2005
Sub-Index	0x00
Value	Returns the instrument identification as

astring in the following format:
 GW-INSTEK,ASR-
 XXXX,GXXXXXXXXX,XX.XX
 Manufacturer: GW-INSTEK
 Model number : ASR-XXXX
 Serial number : GXXXXXXXXX
 Firmware version : XX.XX

Type	char
Data Size	36 Bytes
Access	ro
Example (SDO)	<p>Command 1: 40 05 20 00 00 00 00 00 (*IDN?) Return 1: 41 05 20 00 24 00 00 00 (Data Size is "36 Bytes")</p> <p>Command 2: 60 05 20 00 00 00 00 00 Return 2: 00 47 57 2D 49 4E 53 54 (Char data is "GW-INST")</p> <p>Command 3: 70 05 20 00 00 00 00 00 Return 3: 10 45 4B 2C 41 53 52 2D (Char data is "EK,ASR-")</p> <p>Command 4: 60 05 20 00 00 00 00 00</p>

Return 4:

00 36 36 30 30 2C 53 41

(Char data is "6600,SN")

Command 5:

70 05 20 00 00 00 00 00

Return 5:

10 30 30 30 30 30 31 2C

(Char data is "000001,")

Command 6:

60 05 20 00 00 00 00 00

Return 6:

00 31 2E 32 36 2E 30 30

(Char data is "1.26.00")

Command 7:

70 05 20 00 00 00 00 00

Return 7:

1D 30 00 00 00 00 00 00

(Char data is "0")

Return data is "GW-INSTEK,ASR-
6600,SN000001,1.26.000"

Object 0x2007: *RCL

Description	Recalls the contents stored in memory slot M0 ~ M9. These memory slots are mapped to the preset settings.
Index	0x2007
Sub-Index	0x00
Value	0 ~ 9 (as memory M0 ~ M9)
Type	Unsigned8
Data size	1 Byte
Access	wo
Example (SDO)	23 07 20 00 00 00 00 00 (*RCL)
	Sets the *RCL command.

Object 0x2008: *RST

Description	Performs a device reset. Configures the unit to a known configuration (default settings). This known configuration is independent of the usage history.
Index	0x2008
Sub-Index	0x00
Value	-
Type	Unsigned8
Data size	1 Byte
Access	wo
Example (SDO)	23 08 20 00 00 00 00 00 (*RST)
	Sets the *RST command.

Object 0x2009: *SAV

Description	Saves the settings into memory slot M0 ~ M9. These memory slots are mapped to the preset settings.
Index	0x2009
Sub-Index	0x00
Value	0 ~ 9 (as memory M0 ~ M9)
Type	Unsigned8
Data size	1 Byte
Access	wo

Object 0x200E: *WAI

Description	Prevents any other commands or queries from being executed until all outstanding commands have completed.
Index	0x200E
Sub-Index	0x00
Value	-
Type	Unsigned8
Data size	1 Byte
Access	wo

Trace/Data Commands



Note

The TRACE and DATA node for the following commands are functionally equivalent.

Object 0x2202 0x2D03: DATA TRACe:SEQuence:CLEar.....	93
Object 0x2204 0x2D07: DATA TRACe:SEQuence:RECall.....	94
Object 0x2205 0x2D08: DATA TRACe:SEQuence:STORe.....	94
Object 0x2206 0x2D09: DATA TRACe:SIMulation:CLEar	95
Object 0x2208 0x2D0D: DATA TRACe:SIMulation:RECall.....	96
Object 0x2209 0x2D0E: DATA TRACe:SIMulation:STORe	96
Object 0x2213 0x2D12: DATA TRACe:WAVe:CLEar	97
Object 0x2215 0x2D14: DATA TRACe:WAVe[:DATA].....	98

Object 0x2202|0x2D03: DATA|TRACe:SEQuence:CLEar

Description	Clears the sequence data for the selected save memory (Seq0 ~ Seq9).
Index	0x2202 0x2D03
Sub-Index	0x00
Value	0 ~ 9 (Seq0 ~ Seq9).
Type	Unsigned32
Data size	4 Bytes
Access	wo
Example (SDO)	23 02 22 00 01 00 00 00 (:DATA:SEQ:CLE 1) 23 03 2D 00 01 00 00 00 (:TRACe:SEQ:CLE 1)
	Clears the sequence data from Seq1.

Object 0x2204|0x2D07: DATA|TRACe:SEQ:RECall

Description	Loads the sequence data. This command is the equivalent to recalling a sequence memory in theSequence mode.
Index	0x2204 0x2D07
Sub-Index	0x00
Value	0 ~ 9 (Seq0 ~ Seq9).
Type	Unsigned8
Data size	1 Byte
Access	wo
Example (SDO)	23 04 22 00 01 00 00 00 (:DATA:SEQ:REC 1) 23 07 2D 00 01 00 00 00 (:TRACe:SEQ:REC 1)
	Loads the data from Seq1.

Object 0x2205|0x2D08: DATA|TRACe:SEQ:STORe

Description	Saves the sequence data. This command is the equivalent to saving a sequence memory in Sequence mode.
Index	0x2205 0x2D08
Sub-Index	0x00
Value	0 ~ 9 (Seq0 ~ Seq9).
Type	Unsigned8
Data size	1 Byte
Access	wo
Example (SDO)	23 05 22 00 01 00 00 00 (:DATA:SEQ:STOR 1)

23 08 2D 00 01 00 00 00
 (:TRACe:SEQ:STOR 1)

Saves the data from Seq1.

Object 0x2206|0x2D09: DATA|TRACe:SIMulation:CLEar

Description	Clears the simulation data for the selected savememory (SIM0 ~ SIM9).
Index	0x2206 0x2D09
Sub-Index	0x00
Value	0 ~ 9 (SIM0 ~ SIM9).
Type	Unsigned8
Data size	1 Byte
Access	wo
Example	23 06 22 00 01 00 00 00 (:DATA:SIM:CLE 1)
(SDO)	23 09 2D 00 01 00 00 00 (:TRACe:SIM:CLE 1)

Clears the simulation data from SIM1.

Object 0x2208|0x2D0D: DATA|TRACe:SIMulation:RECall

Description	Loads the simulation data. This command is the equivalent to recalling a simulation memory in the Simulation mode (SIM0~SIM9).
Index	0x2208 0x2D0D
Sub-Index	0x00
Value	0 ~ 9 (SIM0 ~ SIM9).
Type	Unsigned8
Data size	1 Byte
Access	wo
Example (SDO)	23 08 22 00 01 00 00 00 (:DATA:SIM:REC 1) 23 0D 2D 00 01 00 00 00 (:TRACe:SIM:REC 1)
	Loads the data from SIM1.

Object 0x2209|0x2D0E: DATA|TRACe:SIMulation:STORE

Description	Saves the simulation data. This command is the equivalent saving a simulation memory in Simulation mode (SIM0 ~ SIM9).
Index	0x2209 0x2D0E
Sub-Index	0x00
Value	0 ~ 9 (SIM0 ~ SIM9).
Type	Unsigned8
Data size	1 Byte
Access	wo
Example	23 09 22 00 01 00 00 00

(SDO) (:DATA:SIM:STOR 1)
 23 0E 2D 00 01 00 00 00
 (:TRACe:SIM:STOR 1)

Saves the data from SIM1.

Object 0x2213|0x2D12: DATA|TRACe:WAVe:CLear

Description	Clears the ARB 1-16 data for the selected wave group.
Index	0x2213 0x2D12
Sub-Index	0x00
Value	1 ~ 16 (ARB1 ~ ARB16).
Type	Unsigned8
Data size	1 Byte
Access	wo
Example (SDO)	23 13 22 00 0D 00 00 00 (:DATA:WAV:CLE 13) 23 12 2D 00 0D 00 00 00 (:TRACe:WAV:CLE 13)

Clears the wave data from ARB13.

Object 0x2215|0x2D14: DATA|TRACe:WAVE[:DATA]

Description	Sets the arbitrary wave.
Index	0x2215 0x2D14
Sub-Index	0x00 ~ 0x0F (ARB 1 ~ 16)
Vange	Indicates 16-bit with 4096 words waveform data. Plus, the data format of wave is the big endian in the form of two's complement.
Type	Unsigned32
Data size	8192 Bytes
Access	rw
Example (SDO)	(TRAC:WAV 1, #48192<DAB>...<DAB>) 21 14 2D 01 00 20 00 00 00 (Byte 1 ~ Byte 7 is data) 10 (Byte 1 ~ Byte 7 is data) 00 (Byte 1 ~ Byte 7 is data) 10 (Byte 1 ~ Byte 7 is data) 00 (Byte 1 ~ Byte 7 is data) 10 (Byte 1 ~ Byte 7 is data) ⋮ ⋮ 0B (Byte 1 ~ Byte 2 is data)

Measure Commands

Object 0x2804: MEASure[:SCALar]:CURRent:CFACtor	100
Object 0x2805: MEASure[:SCALar]:CURRent:HIGH	100
Object 0x2806: MEASure[:SCALar]:CURRent:LOW	101
Object 0x2807: MEASure[:SCALar]:CURRent:PEAK:HOLD	102
Object 0x2808: MEASure[:SCALar]:CURRent[:RMS]	102
Object 0x2809: MEASure[:SCALar]:CURRent[:RMS]:TOTal	103
Object 0x280A: MEASure[:SCALar]:CURRent:AC	103
Object 0x280B: MEASure[:SCALar]:CURRent:AVERAge	104
Object 0x281D: MEASure[:SCALar]:CURRent:HARMonic[:RMS]	104
Object 0x281E: MEASure[:SCALar]:CURRent:HARMonic:RATio	107
Object 0x280C: MEASure[:SCALar]:FREQuency	110
Object 0x280D: MEASure[:SCALar]:PEAK:CLear	110
Object 0x280E: MEASure[:SCALar]:POWER[:AC]:APParent	111
Object 0x280F: MEASure[:SCALar]:POWER[:AC]:APParent:TOTal ...	112
Object 0x2810: MEASure[:SCALar]:POWER[:AC]:PFACtor	113
Object 0x2811: MEASure[:SCALar]:POWER[:AC]:PFACtor:TOTal	113
Object 0x2812: MEASure[:SCALar]:POWER[:AC]:REACTiVe	114
Object 0x2813: MEASure[:SCALar]:POWER[:AC]:REACTiVe:TOTal ..	114
Object 0x2814: MEASure[:SCALar]:POWER[:AC][:REAL]	115
Object 0x2815: MEASure[:SCALar]:POWER[:AC][:REAL]:TOTal	116
Object 0x2816: MEASure[:SCALar]:VOLTage[:RMS]	116
Object 0x2817: MEASure[:SCALar]:VOLTage[:RMS]:TOTal	117
Object 0x2818: MEASure[:SCALar]:VOLTage:AC	117
Object 0x2819: MEASure[:SCALar]:VOLTage:AVERAge	118
Object 0x281A: MEASure[:SCALar]:VOLTage:HIGH	118
Object 0x281B: MEASure[:SCALar]:VOLTage:LOW	119
Object 0x2821: MEASure[:SCALar]:LINE:VOLTage[:RMS]	120
Object 0x2822: MEASure[:SCALar]:LINE:VOLTage:AVERAge	120
Object 0x2823: MEASure[:SCALar]:LINE:VOLTage:HIGH	121
Object 0x2824: MEASure[:SCALar]:LINE:VOLTage:LOW	122
Object 0x281F: MEASure[:SCALar]:VOLTage:HARMonic[:RMS]	122
Object 0x2820: MEASure[:SCALar]:VOLTage:HARMonic:RATio	125
Object 0x2802: MEASure:CONFigure:SENSing	127
Object 0x2801: MEASure:AVERAge:COUNt	127
Object 0x2803: MEASure:UPDate:RATE	128

Object 0x2804: MEASure[:SCALar]:CURRent:CFACtor

Description	Returns the output current crest factor (CF).
Index	0x2804
Sub-Index	0x00
Value	Returns the crest factor.
Type	Signed32
Data size	4 Bytes
Access	ro
Example (SDO)	40 04 28 00 00 00 00 00 (:MEAS:CURR:CFACtor?)
	Return data is 1520. 43 04 28 00 F0 05 00 00 The crest factor is 1.52, Magnification is 1000.

Object 0x2805: MEASure[:SCALar]:CURRent:HIGH

Description	Returns the output current maximum peak value (Imax).
Index	0x2805
Sub-Index	0x00
Value	Returns the Imax value in amps.
Type	Signed32
Data size	4 Bytes
Access	ro
Note	Current maximum peak value is defined as the highest peak value in the complete

	period.
Example (SDO)	40 05 28 00 00 00 00 00 (:MEAS:CURR:HIGH?)
	Return data is 20050. 43 05 28 00 52 4E 00 00 The current maximum peak value is 20.05 A, Magnification is 1000.

Object 0x2806: MEASure[:SCALar]:CURRent:LOW

Description	Returns the output current minimum value (Imin).
Index	0x2806
Sub-Index	0x00
Value	Returns the Imin value in amps.
Type	Signed32
Data size	4 Bytes
Access	ro
Note	Current minimum value is defined as the lowest value in the complete period.
Example (SDO)	40 06 28 00 00 00 00 00 (:MEAS:CURR:LOW?)
	Return data is 1050. 43 06 28 00 1A 04 00 00 The current minimum value is 1.05 A, Magnification is 1000.

Object 0x2807: MEASure[:SCALar]:CURRent:PEAK:HOLD

Description	Returns the current peak hold value in amps (IPKHold).
Index	0x2807
Sub-Index	0x00
Value	Returns the peak hold value in amps.
Type	Signed32
Data size	4 Bytes
Access	ro
Example (SDO)	40 07 28 00 00 00 00 00 (:MEAS:CURR:PEAK:HOLD?)
	Return data is 20050. 43 07 28 00 52 4E 00 00 The ipeak hold is 20.05 A, Magnification is 1000.

Object 0x2808: MEASure[:SCALar]:CURRent[:RMS]

Description	Returns the output current (Irms).
Index	0x2808
Sub-Index	0x00
Value	Returns the current value in Irms.
Type	Signed32
Data size	4 Bytes
Access	ro
Example (SDO)	40 08 28 00 00 00 00 00 (:MEAS:CURR?)
	Return data is 10050.

43 08 28 00 42 27 00 00

The current is 10.05 A, Magnification is 1000.

Object 0x2809: MEASure[:SCALar]:CURRent[:RMS]:TOTal

Description	Returns the total of output current (Irms).
Index	0x2809
Sub-Index	0x00
Value	Returns the total of current value in Irms.
Type	Signed32
Data size	4 Bytes
Access	ro
Example (SDO)	40 09 28 00 00 00 00 00 (:MEAS:CURR:TOTal?)

Return data is 10050.

43 09 28 00 42 27 00 00

The total of current is 10.05 A, Magnification is 1000.

Object 0x280A: MEASure[:SCALar]:CURRent:AC

Description	Returns the output AC current (Irms).
Index	0x280A
Sub-Index	0x00
Value	Returns the AC current value in Irms.
Type	Signed32
Data size	4 Bytes
Access	ro
Example	40 0A 28 00 00 00 00 00

(SDO)

(:MEAS:CURR:AC?)

Return data is 10050.

43 0A 28 00 42 27 00 00

The AC current is 10.05 A, Magnification is 1000.

Object 0x280B: MEASure[:SCALar]:CURRent:AVERage

Description

Returns the current average value (Iavg).

Index

0x280B

Sub-Index

0x00

Value

Returns the current average value in amps.

Type

Signed32

Data size

4 Bytes

Access

ro

Example

40 0B 28 00 00 00 00 00

(SDO)

(:MEAS:CURR:AVERage?)

Return data is 10050.

43 0B 28 00 42 27 00 00

The current average value is 10.05 A, Magnification is 1000.

Object 0x281D:

MEASure[:SCALar]:CURRent:HARMonic[:RMS]

Description

Returns 101 values covering Total and order 1 to 100 current (Irms) in harmonic. (Only AC-INT and 50/60 Hz Active)

Index

0x281D

Sub-Index	0x00
Name	Total current (Irms) in harmonic.
Value	Returns the Total current (Irms) in harmonic.
Type	Signed32
Data size	4 Bytes
Access	ro
Sub-Index	0x01 (Page 1)
Value	Returns the entire 20 values containing order 1 to 20 current (Irms) in harmonic.
Type	Signed32
Data size	80 Bytes
Access	ro
Sub-Index	0x02 (Page 2)
Value	Returns the entire 20 values containing order 21 to 40 current (Irms) in harmonic.
Type	Signed32
Data size	80 Bytes
Access	ro
Sub-Index	0x03 (Page 3)
Value	Returns the entire 20 values containing order 41 to 60 current (Irms) in harmonic.
Type	Signed32
Data size	80 Bytes
Access	ro
Sub-Index	0x04 (Page 4)
Value	Returns the entire 20 values

	containing order 61 to 80 current (Irms) in harmonic.
Type	Signed32
Data size	80 Bytes
Access	ro
Sub-Index	0x05 (Page 5)
Value	Returns the entire 20 values containing order 81 to 100 current (Irms) in harmonic.
Type	Signed32
Data size	80 Bytes
Access	ro
Example (SDO)	<p>Command 1: 40 1D 28 05 00 00 00 00 (:MEAS:CURR:HARMonic? 5)</p> <p>Return 1: 41 1D 28 05 50 00 00 00 (Data Size is "80 Bytes")</p> <p>Command 2: 60 1D 28 00 00 00 00 00</p> <p>Return 2: 00 (Byte 1 ~ Byte 7 is data)</p> <p>Command 3: 70 1D 28 00 00 00 00 00</p> <p>Return 3: 10 (Byte 1 ~ Byte 7 is data)</p> <p style="text-align: center;">⋮ ⋮</p>

In a total of 80 bytes of data, every 4 bytes are regarded as a data.

Object 0x281E:

MEASure[:SCALar]:CURRent:HARMonic:RATio

Description	Returns 101 values covering Total and order 1 to 100 current (Ratio) in harmonic. (Only AC-INT and 50/60 Hz Active)
Index	0x281E
Sub-Index	0x00 (Total current (Ratio) in harmonic.)
Value	Returns the Total current (Ratio) in harmonic.
Type	Signed32
Data size	4 Bytes
Access	ro
Sub-Index	0x01 (Page 1)
Value	Returns the entire 20 values containing order 1 to 20 current (Ratio) in harmonic.
Type	Signed32
Data size	80 Bytes
Access	ro
Sub-Index	0x02 (Page 2)
Value	Returns the entire 20 values containing order 21 to 40 current (Ratio) in harmonic.
Type	Signed32
Data size	80 Bytes
Access	ro
Sub-Index	0x03 (Page 3)

Value	Returns the entire 20 values containing order 41 to 60 current (Ratio) in harmonic.
Type	Signed32
Data size	80 Bytes
Access	ro
Sub-Index	0x04 (Page 4)
Value	Returns the entire 20 values containing order 61 to 80 current (Ratio) in harmonic.
Type	Signed32
Data size	80 Bytes
Access	ro
Sub-Index	0x05 (Page 5)
Value	Returns the entire 20 values containing order 81 to 100 current (Ratio) in harmonic.
Type	Signed32
Data size	80 Bytes
Access	ro
Example (SDO)	<p>Command 1: 40 1E 28 05 00 00 00 00 (:MEAS:CURR:HARMonic:RATio? 5)</p> <p>Return 1: 41 1E 28 05 50 00 00 00 (Data Size is "80 Bytes")</p> <p>Command 2: 60 1E 28 00 00 00 00 00</p> <p>Return 2: 00 (Byte 1 ~ Byte 7 is data)</p>

Command 3:

70 1E 28 00 00 00 00 00

Return 3:

10 (Byte 1 ~ Byte 7 is data)

⋮
⋮

In a total of 80 bytes of data, every 4 bytes are regarded as a data.

Object 0x280C: MEASure[:SCALar]:FREQuency

Description	Returns the SYNC signal source frequency in Hz. The external sync signal frequency measurement range is 10.0 Hz to 2100.0 Hz. (Only AC+DC-sync or AC-sync Active)
Index	0x280C
Sub-Index	0x00
Value	Returns the SYNC frequency in Hz
Type	Signed32
Data size	4 Bytes
Access	ro
Example (SDO)	40 0C 28 00 00 00 00 00 (:MEASure:FREQuency?) Return data is 50000. 43 0C 28 00 50 C3 00 00 The SYNC frequency is 50 Hz, Magnification is 1000.

Object 0x280D: MEASure[:SCALar]:PEAK:CLEAr

Description	Clears the current peak-hold value.
Index	0x280D
Sub-Index	0x00
Value	0 = ALL Clear the three-phase and total peak hold value. 1 = L1

Clear L1 phase peak hold value.

2 = L2

Clear L2 phase peak hold value.

3 = L3

Clear L3 phase peak hold value.

4 = TOTal

Clear Total peak hold value.

Type	Unsigned8
Data size	1 Byte
Access	wo
Example (SDO)	23 0D 28 00 00 00 00 00 (:MEASure[:SCALar]:PEAK:CLEar ALL)
	Clear the three-phase and total peak hold value.

Object 0x280E: MEASure[:SCALar]:POWER[:AC]:APParent

Description	Returns the apparent power (S).
Index	0x280E
Sub-Index	0x00
Value	Returns the apparent power in VA.
Type	Signed32
Data size	4 Bytes
Access	ro
Example (SDO)	40 0E 28 00 00 00 00 00 (:MEASure:POWER:APParent?)

Return data is 2500.

43 0E 28 00 C4 09 00 00

The apparent power is 2.5, Magnification is 1000.

Object 0x280F:

MEASure[:SCALar]:POWER[:AC]:APParent:TOTal

Description	Returns the total of apparent power (S).
Index	0x280F
Sub-Index	0x00
Value	Returns the total of apparent power in VA.
Type	Signed32
Data size	4 Bytes
Access	ro
Example (SDO)	40 0E 28 00 00 00 00 00 (:MEASure:POWER:APParent:TOTal?)

Return data is 2500.

43 0E 28 00 C4 09 00 00

The total of apparent power is 2.5, Magnification is 1000.

Object 0x2810: MEASure[:SCALar]:POWER[:AC]:PFACtor

Description	Returns the power factor (PF).
Index	0x2810
Sub-Index	0x00
Value	Returns the power factor.
Type	Signed32
Data size	4 Bytes
Access	ro
Example (SDO)	40 10 28 00 00 00 00 00 (:MEASure:POWER:PFACtor?)
	Return data is 2500. 43 10 28 00 C4 09 00 00 The power factor is 2.5, Magnification is 1000.

Object 0x2811:

MEASure[:SCALar]:POWER[:AC]:PFACtor:TOTal

Description	Returns the total of power factor (PF).
Index	0x2811
Sub-Index	0x00
Value	Returns the total of power factor.
Type	Signed32
Data size	4 Bytes
Access	ro
Example (SDO)	40 11 28 00 00 00 00 00 (:MEASure:POWER:PFACtor:TOTal?)

Return data is 2500.
 43 11 28 00 C4 09 00 00
 The total of power factor is 2.5, Magnification is 1000.

Object 0x2812: MEASure[:SCALar]:POWER[:AC]:REACTive

Description	Returns the reactive power (Q).
Index	0x2812
Sub-Index	0x00
Value	Returns the reactive power in VAR.
Type	Signed32
Data size	4 Bytes
Access	ro
Example (SDO)	40 12 28 00 00 00 00 00 (:MEASure:POWER:REACTive?)

Return data is 2500.
 43 12 28 00 C4 09 00 00
 The reactive power is 2.5, Magnification is 1000.

**Object 0x2813:
 MEASure[:SCALar]:POWER[:AC]:REACTive:TOTal**

Description	Returns the total of reactive power (Q).
Index	0x2813
Sub-Index	0x00
Value	Returns the total of reactive power in VAR.
Type	Signed32
Data size	4 Bytes

Access	ro
Example (SDO)	40 13 28 00 00 00 00 00 (:MEASure:POWer:REACtive:TOTal?)
	Return data is 2500. 43 13 28 00 C4 09 00 00 The reactive power is 2.5, Magnification is 1000.

Object 0x2814: MEASure[:SCALar]:POWer[:AC][:REAL]

Description	Returns the active power in Watts (P).
Index	0x2814
Sub-Index	0x00
Value	Returns the power in Watts.
Type	Signed32
Data size	4 Bytes
Access	ro
Example (SDO)	40 14 28 00 00 00 00 00 (:MEASure:POWer?)
	Return data is 100500. 43 14 28 00 94 88 01 00 The power is 100.5 W, Magnification is 1000.

Object 0x2815:

MEASure[:SCALar]:POWER[:AC][:REAL]:TOTal

Description	Returns the total of active power in Watts (P).
Index	0x2815
Sub-Index	0x00
Value	Returns the total of power in Watts.
Type	Signed32
Data size	4 Bytes
Access	ro
Example (SDO)	40 15 28 00 00 00 00 00 (:MEASure:POWER:TOTal?)
	Return data is 100500. 43 15 28 00 A0 86 01 00 The total of power is 100.5 W, Magnification is 1000.

Object 0x2816: **MEASure[:SCALar]:VOLTage[:RMS]**

Description	Returns the voltage (Vrms).
Index	0x2816
Sub-Index	0x00
Value	Returns the voltage value in Vrms.
Type	Signed32
Data size	4 Bytes
Access	ro
Example (SDO)	40 16 28 00 00 00 00 00 (:MEASure:VOLTage?)

Return data is 100500.

43 16 28 00 A0 86 01 00

The voltage is 100.5 V, Magnification is 1000.

Object 0x2817: MEASure[:SCALar]:VOLTage[:RMS]:TOTal

Description	Returns the total of voltage (Vrms).
Index	0x2817
Sub-Index	0x00
Value	Returns the total of voltage value in Vrms.
Type	Signed32
Data size	4 Bytes
Access	ro
Example (SDO)	40 17 28 00 00 00 00 00 (:MEASure:VOLTage:TOTal?)

Return data is 100500.

43 17 28 00 A0 86 01 00

The total of voltage is 100.5 V, Magnification is 1000.

Object 0x2818: MEASure[:SCALar]:VOLTage:AC

Description	Returns the AC voltage (Vrms).
Index	0x2818
Sub-Index	0x00
Value	Returns the AC voltage value in Vrms.
Type	Signed32
Data size	4 Bytes
Access	ro

Sub-Index	0x00
Value	Returns the Vmax value in volts.
Type	Signed32
Data size	4 Bytes
Access	ro
Note	Voltage maximum peak value is defined as the highest peak value in the complete period.
Example (SDO)	40 1A 28 00 00 00 00 00 (:MEASure:VOLTage:HIGH?) Return data is 100500. 43 1A 28 00 A0 86 01 00 The voltage maximum peak is 100.5 V, Magnification is 1000.

Object 0x281B: MEASure[:SCALar]:VOLTage:LOW

Description	Returns the output voltage minimum value (Vmin).
Index	0x281B
Sub-Index	0x00
Value	Returns the Vmin value in volts
Type	Signed32
Data size	4 Bytes
Access	ro
Note	Voltage minimum value is defined as the lowest value in the complete period.
Example (SDO)	40 1B 28 00 00 00 00 00 (:MEASure:VOLTage:LOW?)

Return data is -50750.
 43 1B 28 00 C2 39 FF FF
 The voltage minimum is -50.75 V,
 Magnification is 1000.

Object 0x2821: MEASure[:SCALar]:LINE:VOLTage[:RMS]

Description	Returns the line voltage (Vrms).
Index	0x2821
Sub-Index	0x00
Value	Returns the line voltage value in Vrms.
Type	Signed32
Data size	4 Bytes
Access	ro
Example (SDO)	40 21 28 00 00 00 00 00 (:MEASure:LINE:VOLTage?)

Return data is 100500.
 43 21 28 00 A0 86 01 00
 The line voltage is 100.5 V, Magnification is 1000.

Object 0x2822: MEASure[:SCALar]:LINE:VOLTage:AVERage

Description	Returns the line voltage average value (Vavg).
Index	0x2822
Sub-Index	0x00
Value	Returns the line voltage average value in volts.
Type	Signed32

Data size	4 Bytes
Access	ro
Example (SDO)	40 22 28 00 00 00 00 00 (:MEASure:LINE:VOLTage:AVERage?) Return data is 100500. 43 22 28 00 A0 86 01 00 The line voltage average is 100.5 V, Magnification is 1000.

Object 0x2823: MEASure[:SCALar]:LINE:VOLTage:HIGH

Description	Returns the output line voltage maximum peak value (Vmax).
Index	0x2823
Sub-Index	0x00
Value	Returns the line Vmax value in line volts.
Type	Signed32
Data size	4 Bytes
Access	ro
Note	Line voltage maximum peak value is defined as the highest peak value in the complete period.
Example (SDO)	40 23 28 00 00 00 00 00 (:MEASure:LINE:VOLTage:AVERage:HIGH?) Return data is 100500. 43 23 28 00 A0 86 01 00 The line voltage maximum peak is 100.5 V, Magnification is 1000.

Object 0x2824: MEASure[:SCALar]:LINE:VOLTage:LOW

Description	Returns the output line current minimum value (Vmin).
Index	0x2824
Sub-Index	0x00
Value	Returns the line Vmin value in line volts.
Type	Signed32
Data size	4 Bytes
Access	ro
Note	Line voltage minimum value is defined as the lowest value in the complete period.
Example (SDO)	<p>40 24 28 00 00 00 00 00</p> <p>(:MEASure:LINE:VOLTage:LOW?)</p> <p>Return data is -50750.</p> <p>43 24 28 00 C2 39 FF FF</p> <p>The line voltage minimum is -50.75 V, Magnification is 1000.</p>

Object 0x281F:

MEASure[:SCALar]:VOLTage:HARMonic[:RMS]

Description	Returns 101 values covering Total and order 1 to 100 voltage (Vrms) in harmonic. (Only AC-INT and 50/60 Hz Active)
Index	0x281F
Sub-Index	0x00 (Total voltage (Vrms) in harmonic.)
Value	Returns the Total voltage (Vrms) in harmonic.

Type	Signed32
Data size	4 Bytes
Access	ro
Sub-Index	0x01 (Page 1)
Value	Returns the entire 20 values containing order 1 to 20 voltage (Vrms) in harmonic.
Type	Signed32
Data size	80 Bytes
Access	ro
Sub-Index	0x02 (Page 2)
Value	Returns the entire 20 values containing order 21 to 40 voltage (Vrms) in harmonic.
Type	Signed32
Data size	80 Bytes
Access	ro
Sub-Index	0x03 (Page 3)
Value	Returns the entire 20 values containing order 41 to 60 voltage (Vrms) in harmonic.
Type	Signed32
Data size	80 Bytes
Access	ro
Sub-Index	0x04 (Page 4)
Value	Returns the entire 20 values containing order 61 to 80 voltage (Vrms) in harmonic.
Type	Signed32
Data size	80 Bytes
Access	ro

Sub-Index	0x05 (Page 5)
Value	Returns the entire 20 values containing order 81 to 100 voltage (Vrms) in harmonic.
Type	Signed32
Data size	80 Bytes
Access	ro
Example (SDO)	<p>Command 1: 40 1F 28 05 00 00 00 00 (:MEAS: VOLTage:HARMonic? 5)</p> <p>Return 1: 41 1F 28 05 50 00 00 00 (Data Size is "80 Bytes")</p> <p>Command 2: 60 1F 28 00 00 00 00 00</p> <p>Return 2: 00 (Byte 1 ~ Byte 7 is data)</p> <p>Command 3: 70 1F 28 00 00 00 00 00</p> <p>Return 3: 10 (Byte 1 ~ Byte 7 is data)</p> <p style="text-align: center;">⋮ ⋮</p> <p>In a total of 80 bytes of data, every 4 bytes are regarded as a data.</p>

Object 0x2820:

MEASure[:SCALar]:VOLTage:HARMonic:RATio

Description	Returns 101 values covering Total and order 1 to 100 current (Ratio) in harmonic. (Only AC-INT and 50/60 Hz Active)
Index	0x2820
Sub-Index	0x00 (Total current (Ratio) in harmonic.)
Value	Returns the Total current (Ratio) in harmonic.
Type	Signed32
Data size	4 Bytes
Access	ro
Sub-Index	0x01 (Page 1)
Value	Returns the entire 20 values containing order 1 to 20 current (Ratio) in harmonic.
Type	Signed32
Data size	80 Bytes
Access	ro
Sub-Index	0x02 (Page 2)
Value	Returns the entire 20 values containing order 21 to 40 current (Ratio) in harmonic.
Type	Signed32
Data size	80 Bytes
Access	ro
Sub-Index	0x03 (Page 3)
Value	Returns the entire 20 values containing order 41 to 60 current (Ratio) in harmonic.
Type	Signed32

Data size	80 Bytes
Access	ro
Sub-Index	0x04 (Page 4)
Value	Returns the entire 20 values containing order 61 to 80 current (Ratio) in harmonic.
Type	Signed32
Data size	80 Bytes
Access	ro
Sub-Index	0x05 (Page 5)
Value	Returns the entire 20 values containing order 81 to 100 current (Ratio) in harmonic.
Type	Signed32
Data size	80 Bytes
Access	ro
Example (SDO)	<p>Command 1: 40 20 28 05 00 00 00 00 (:MEAS:VOLTage:HARMonic:RATio? 5)</p> <p>Return 1: 41 20 28 05 50 00 00 00 (Data Size is "80 Bytes")</p> <p>Command 2: 60 20 28 00 00 00 00 00</p> <p>Return 2: 00 (Byte 1 ~ Byte 7 is data)</p> <p>Command 3: 70 20 28 00 00 00 00 00</p> <p>Return 3:</p>

10 (Byte 1 ~ Byte 7 is data)

⋮
⋮

In a total of 80 bytes of data, every 4 bytes are regarded as a data.

Object 0x2802: MEASure:CONFigure:SENSing

Description	Sets or queries the remote sense configuration. (Only AC-INT, DC-INT, AC-SYNC Mode and 100V, 200V Range and SIN Wave Shape and Output Impedance is Truned off.
Index	0x2802
Sub-Index	0x00
Value	0 = OFF Turns the remote sense off. 1 = ON Turns the remote sense on.
Type	Unsigned8
Data size	1 Byte
Access	rw
Example (SDO)	23 02 28 00 00 00 00 00 (:MEAS:CONF:SENS 0)
	Sets the remote sense off.

Object 0x2801: MEASure:AVERAge:COUNT

Description	Sets or queries the averaging count for Measure Function.
Index	0x2801
Sub-Index	0x00

Value	1 ~ 128
Type	Unsigned8
Data size	1 Byte
Access	rw
Averaged Parameter	Vrms & Vmax & Vmin & Irms & Imax & Imin & P & S & Q & PF & CF & Vavg & Ivag & Ipkh
Not Averaged Parameter	Freq & THDv & THDi
Example (SDO)	40 01 28 00 00 00 00 00 (:MEASure:AVERage:COUNT?)
	Return data is 1 43 01 28 00 01 00 00 00
	Returns the averaging count for Measure Function.

Object 0x2803: MEASure:UPDate:RATE

Description	Sets or queries the data update interval for Measure Function.
Index	0x2803
Sub-Index	0x00
Value	0 = FAST 1 = 0.1 Sec 2 = 0.25 Sec 3 = 0.5 Sec 4 = 1 Sec 5 = 2 Sec 6 = 5 Sec

	7 = 10 Sec
	8 = 20 Sec
Type	Unsigned8
Data size	1 Byte
Access	rw
Use Update Rate Parameter	Vrms & Vmax & Vmin & Irms & Imax & Imin & P & S & Q & PF & CF & Vavg & Ivag & Ipkh
Not Use Update Rate Parameter	Freq & THDv & THDi (update as soon as possible)
Example (SDO)	40 03 28 00 00 00 00 00 (:MEASure:AVERage:COUNT?)
	Return data is 0 FAST. 43 03 28 00 00 00 00 00
	Returns the data update interval for Measure Function.

Fetch Commands

Object 0x2501: FETCh[:SCALar]:CURRent:CFACtor	131
Object 0x2502: FETCh[:SCALar]:CURRent:HIGH	131
Object 0x2503: FETCh[:SCALar]:CURRent:LOW	132
Object 0x2504: FETCh[:SCALar]:CURRent:PEAK:HOLD	133
Object 0x2505: FETCh[:SCALar]:CURRent[:RMS]	133
Object 0x2506: FETCh[:SCALar]:CURRent[:RMS]:TOTal	134
Object 0x2507: FETCh[:SCALar]:CURRent:AC	135
Object 0x2508: FETCh[:SCALar]:CURRent:AVERAge	135
Object 0x2518: FETCh[:SCALar]:CURRent:HARMonic[:RMS]	136
Object 0x2519: FETCh[:SCALar]:CURRent:HARMonic:RATio	138
Object 0x2509: FETCh[:SCALar]:FREQuency	140
Object 0x250A: FETCh[:SCALar]:POWEr[:AC]:APParent	141
Object 0x250B: FETCh[:SCALar]:POWEr[:AC]:APParent:TOTal	142
Object 0x250C: FETCh[:SCALar]:POWEr[:AC]:PFACtor	142
Object 0x250D: FETCh[:SCALar]:POWEr[:AC]:PFACtor:TOTal	143
Object 0x250E: FETCh[:SCALar]:POWEr[:AC]:REACTive	143
Object 0x250F: FETCh[:SCALar]:POWEr[:AC]:REACTive:TOTal	144
Object 0x2510: FETCh[:SCALar]:POWEr[:AC][:REAL]	145
Object 0x2511: FETCh[:SCALar]:POWEr[:AC][:REAL]:TOTal	145
Object 0x2512: FETCh[:SCALar]:VOLTag[:RMS]	146
Object 0x2513: FETCh[:SCALar]:VOLTag[:RMS]:TOTal	146
Object 0x2514: FETCh[:SCALar]:VOLTag:AC	147
Object 0x2515: FETCh[:SCALar]:VOLTag:AVERAge	148
Object 0x2516: FETCh[:SCALar]:VOLTag:HIGH	148
Object 0x2517: FETCh[:SCALar]:VOLTag:LOW	149
Object 0x251C: FETCh[:SCALar]:LINE:VOLTag[:RMS]	150
Object 0x251D: FETCh[:SCALar]:LINE:VOLTag:AVERAge	150
Object 0x251E: FETCh[:SCALar]:LINE:VOLTag:HIGH	151
Object 0x251F: FETCh[:SCALar]:LINE:VOLTag:LOW	152
Object 0x251A: FETCh[:SCALar]:VOLTag:HARMonic[:RMS]	152
Object 0x251B: FETCh[:SCALar]:VOLTag:HARMonic:RATio	155

Object 0x2501: FETCh[:SCALAr]:CURRent:CFACtor

Description	Returns the read output current crest factor (CF).
Index	0x2501
Sub-Index	0x00
Value	Returns the read crest factor.
Type	Signed32
Data size	4 Bytes
Access	ro
Example (SDO)	40 01 25 00 00 00 00 00 (:FETCh:CURR:CFACtor?) Return data is 1520. 43 01 25 00 F0 05 00 00 The crest factor is 1.52, Magnification is 1000.

Object 0x2502: FETCh[:SCALAr]:CURRent:HIGH

Description	Returns the read output current maximum peak value (Imax).
Index	0x2502
Sub-Index	0x00
Value	Returns the read Imax value in amps.
Type	Signed32
Data size	4 Bytes
Access	ro
Note	Current maximum peak value is defined as the highest peak value in the

	complete period.
Example (SDO)	40 02 25 00 00 00 00 00 (:FETCh:CURR:HIGH?)
	Return data is 20050. 43 02 25 00 52 4E 00 00 The current maximum peak value is 20.05 A, Magnification is 1000.

Object 0x2503: FETCh[:SCALar]:CURRent:LOW

Description	Returns the read output current minimum value (Imin).
Index	0x2503
Sub-Index	0x00
Value	Returns the read Imin value in amps.
Type	Signed32
Data size	4 Bytes
Access	ro
Note	Current maximum peak value is defined as the highest peak value in the complete period.
Example (SDO)	40 03 25 00 00 00 00 00 (:FETCh:CURR:LOW?)
	Return data is 1050. 43 03 25 00 1A 04 00 00 The current minimum value is 1.05 A, Magnification is 1000.

Object 0x2504: FETCh[:SCALar]:CURRent:PEAK:HOLD

Description	Returns the read output current peak hold value in amps (IPK Hold).
Index	0x2504
Sub-Index	0x00
Value	Returns the read peak hold value in amps.
Type	Signed32
Data size	4 Bytes
Access	ro
Example (SDO)	40 04 25 00 00 00 00 00 (:FETCh:CURR:PEAK:HOLD?)
	Return data is 20050. 43 04 25 00 52 4E 00 00 The ipeak hold is 20.05 A, Magnification is 1000.

Object 0x2505: FETCh[:SCALar]:CURRent[:RMS]

Description	Returns the read output current (Irms).
Index	0x2505
Sub-Index	0x00
Value	Returns the read current value in Irms.
Type	Signed32
Data size	4 Bytes
Access	ro
Example (SDO)	40 05 28 00 00 00 00 00 (:FETCh:CURR?)

Return data is 10050.

43 05 28 00 42 27 00 00

The current is 10.05 A, Magnification is 1000.

Object 0x2506: FETCh[:SCALAr]:CURRent[:RMS]:TOTal

Description	Returns the read total of output current (Irms).
Index	0x2506
Sub-Index	0x00
Value	Returns the read total of current value in Irms.
Type	Signed32
Data size	4 Bytesz
Access	ro
Example (SDO)	40 06 25 00 00 00 00 00 (:FETCh:CURR:TOTal?)

Return data is 10050.

43 06 25 00 42 27 00 00

The total of current is 10.05 A, Magnification is 1000.

Object 0x2507: FETCh[:SCALar]:CURRent:AC

Description	Returns the read output AC current (Irms).
Index	0x2507
Sub-Index	0x00
Value	Returns the read AC current value in Irms.
Type	Signed32
Data size	4 Bytes
Access	ro
Example (SDO)	40 07 25 00 00 00 00 00 (:FETCh:CURR:AC?) Return data is 10050. 43 07 25 00 42 27 00 00 The AC current is 10.05 A, Magnification is 1000.

Object 0x2508: FETCh[:SCALar]:CURRent:AVERAge

Description	Returns the read current average value (Iavg).
Index	0x2508
Sub-Index	0x00
Value	Returns the read current average value in amps.
Type	Signed32
Data size	4 Bytes
Access	ro

Example 40 08 25 00 00 00 00 00
 (SDO) (:FETCh:CURR:AVERAge?)

Return data is 10050.
 43 08 25 00 42 27 00 00
 The current average value is 10.05 A,
 Magnification is 1000.

Object 0x2518: FETCh[:SCALAr]:CURRent:HARMONic[:RMS]

Description	Returns 101 values covering Total and order 1 to 100 fetch current (Irms) in harmonic. (Only AC-INT and 50/60 Hz Active)
Index	0x2518
Sub-Index	0x00 (Total Fetch current (Irms) in harmonic.)
Value	Returns the Total Fetch current (Irms) in harmonic.
Type	Signed32
Data size	4 Bytes
Access	ro
Sub-Index	0x01 (Page 1)
Value	Returns the entire 20 values containing order 1 to 20 current (Irms) in harmonic.
Type	Signed32
Data size	80 Bytes
Access	ro
Sub-Index	0x02 (Page 2)
Value	Returns the entire 20 values containing order 21 to 40 current (Irms) in

	harmonic.
Type	Signed32
Data size	80 Bytes
Access	ro
Sub-Index	0x03 (Page 3)
Value	Returns the entire 20 values containing order 41 to 60 current (Irms) in harmonic.
Type	Signed32
Data size	80 Bytes
Access	ro
Sub-Index	0x04 (Page 4)
Value	Returns the entire 20 values containing order 61 to 80 current (Irms) in harmonic.
Type	Signed32
Data size	80 Bytes
Access	ro
Sub-Index	0x05 (Page 5)
Value	Returns the entire 20 values containing order 81 to 100 current (Irms) in harmonic.
Type	Signed32
Data size	80 Bytes
Access	ro
Example (SDO)	Command 1: 40 18 25 05 00 00 00 00 (:FETCh:CURR:HARMonic? 5) Return 1: 41 18 25 05 50 00 00 00

(Data Size is “80 Bytes”)

Command 2:

60 18 25 00 00 00 00 00

Return 2:

00 (Byte 1 ~ Byte 7 is data)

Command 3:

70 18 25 00 00 00 00 00

Return 3:

10 (Byte 1 ~ Byte 7 is data)

⋮
⋮

In a total of 80 bytes of data, every 4 bytes are regarded as a data.

Object 0x2519: FETCh [:SCALar]:CURRent:HARMonic:RATio

Description	Returns 101 values covering Total and order 1 to 100 fetch current (Ratio) in harmonic. (Only AC-INT and 50/60 Hz Active)
Index	0x2519
Sub-Index	0x00 (Total Fetch current (Ratio) in harmonic.)
Value	Returns the Total Fetch current (Ratio) in harmonic.
Type	Signed32
Data size	4 Bytes
Access	ro

Sub-Index	0x01 (Page 1)
Value	Returns the entire 20 values containing order 1 to 20 current (Ratio) in harmonic.
Type	Signed32
Data size	80 Bytes
Access	ro
Sub-Index	0x02 (Page 2)
Value	Returns the entire 20 values containing order 21 to 40 current (Ratio) in harmonic.
Type	Signed32
Data size	80 Bytes
Access	ro
Sub-Index	0x03 (Page 3)
Value	Returns the entire 20 values containing order 41 to 60 current (Ratio) in harmonic.
Type	Signed32
Data size	80 Bytes
Access	ro
Sub-Index	0x04 (Page 4)
Value	Returns the entire 20 values containing order 61 to 80 current (Ratio) in harmonic.
Type	Signed32
Data size	80 Bytes
Access	ro
Sub-Index	0x05 (Page 5)
Value	Returns the entire 20 values containing

	order 81 to 100 current (Ratio) in harmonic.
Type	Signed32
Data size	80 Bytes
Access	ro
Example (SDO)	<p>Command 1: 40 19 25 05 00 00 00 00 (:FETCh:CURR:HARMonic:RATio? 5)</p> <p>Return 1: 41 19 25 05 50 00 00 00 (Data Size is "80 Bytes")</p> <p>Command 2: 60 19 25 00 00 00 00 00</p> <p>Return 2: 00 (Byte 1 ~ Byte 7 is data)</p> <p>Command 3: 70 19 25 00 00 00 00 00</p> <p>Return 3: 10 (Byte 1 ~ Byte 7 is data)</p> <p style="text-align: center;">⋮ ⋮</p> <p>In a total of 80 bytes of data, every 4 bytes are regarded as a data.</p>

Object 0x2509: FETCh[:SCALar]:FREQuency

Description	Returns the read SYNC signal source frequency in Hz.The external sync signal frequency measurement range is
-------------	-------------------------------------------------------------------------------------------------------------

	10.0 Hz to 2100.0 Hz. (Only AC+DC-sync or AC-sync Active)
Index	0x2509
Sub-Index	0x00
Value	Returns the read SYNC frequency in Hz.
Type	Signed32
Data size	4 Bytes
Access	ro
Example (SDO)	40 09 25 00 00 00 00 00 (:FETCh:FREQUency?)
	Return data is 50000. 43 09 25 00 50 C3 00 00 The SYNC frequency is 50 Hz, Magnification is 1000.

Object 0x250A: FETCh[:SCALAr]:POWEr[:AC]:APParent

Description	Returns the read apparent power (S).
Index	0x250A
Sub-Index	0x00
Value	Returns the read apparent power in VA.
Type	Signed32
Data size	4 Bytes
Access	ro
Example (SDO)	40 0A 25 00 00 00 00 00 (:FETCh:POWEr:APParent?)
	Return data is 2500.

43 0A 25 00 C4 09 00 00

The apparent power is 2.5, Magnification is 1000.

Object 0x250B:

FETCh[:SCALar]:POWer[:AC]:APParent:TOTal

Description	Returns the read total of apparent power (S).
Index	0x250B
Sub-Index	0x00
Value	Returns the read total of apparent power in VA.
Type	Signed32
Data size	4 Bytes
Access	ro
Example (SDO)	40 0B 25 00 00 00 00 00 (:FETCh:POWer:APParent:TOTal?)
	Return data is 2500. 43 0B 25 00 C4 09 00 00 The total of apparent power is 2.5, Magnification is 1000.

Object 0x250C: FETCh[:SCALar]:POWer[:AC]:PFACTOR

Description	Returns the read power factor (PF).
Index	0x250C
Sub-Index	0x00
Value	Returns the read power factor.
Type	Signed32
Data size	4 Bytes

Access	ro
Example (SDO)	40 0C 25 00 00 00 00 00 (:FETCh:POWer:PFACTOR?)
	Return data is 2500. 43 0C 25 00 C4 09 00 00 The power factor is 2.5, Magnification is 1000.

Object 0x250D: FETCh[:SCALAr]:POWer[:AC]:PFACTOR:TOTAL

Description	Returns the read total of power factor (PF).
Index	0x250D
Sub-Index	0x00
Value	Returns the read total of power factor.
Type	Signed32
Data size	4 Bytes
Access	ro
Example (SDO)	40 0D 25 00 00 00 00 00 (:FETCh:POWer:PFACTOR:TOTAL?)
	Return data is 2500. 43 0D 25 00 C4 09 00 00 The total of power factor is 2.5, Magnification is 1000.

Object 0x250E: FETCh[:SCALAr]:POWer[:AC]:REACTIVE

Description	Returns the read reactive power (Q).
Index	0x250E
Sub-Index	0x00

Value	Returns the read reactive power in VAR.
Type	Signed32
Data size	4 Bytes
Access	ro
Example (SDO)	40 0E 25 00 00 00 00 00 (:FETCh:POWer:REACtive?) Return data is 2500. 43 0E 25 00 C4 09 00 00 The reactive power is 2.5, Magnification is 1000.

Object 0x250F:

FETCh[:SCALar]:POWer[:AC]:REACtive:TOTal

Description	Returns the read total of reactive power (Q).
Index	0x250F
Sub-Index	0x00
Value	Returns the read total of reactive power in VAR.
Type	Signed32
Data size	4 Bytes
Access	ro
Example (SDO)	40 0F 25 00 00 00 00 00 (:FETCh:POWer:REACtive:TOTal?) Return data is 2500. 43 0F 25 00 C4 09 00 00 The reactive power is 2.5, Magnification is 1000.

Object 0x2510: FETCh[:SCALar]:POWer[:AC][:REAL]

Description	Returns the read active power in Watts (P).
Index	0x2510
Sub-Index	0x00
Value	Returns the read power in Watts.
Type	Signed32
Data size	4 Bytes
Access	ro
Example (SDO)	40 10 25 00 00 00 00 00 (:FETCh:POWer?) Return data is 100500. 43 10 25 00 94 88 01 00 The power is 100.5 W, Magnification is 1000.

Object 0x2511: FETCh[:SCALar]:POWer[:AC][:REAL]:TOTal

Description	Returns the read total of active power in Watts (P).
Index	0x2511
Sub-Index	0x00
Value	Returns the read power in Watts.
Type	Signed32
Data size	4 Bytes
Access	ro
Example (SDO)	40 11 25 00 00 00 00 00 (:FETCh:POWer:TOTal?) Return data is 100500.

43 11 25 00 A0 86 01 00

The total of power is 100.5 W, Magnification is 1000.

Object 0x2512: FETCh[:SCALAr]:VOLTage[:RMS]

Description	Returns the read voltage (Vrms).
Index	0x2512
Sub-Index	0x00
Value	Returns the read voltage value in Vrms.
Type	Signed32
Data size	4 Bytes
Access	ro
Example (SDO)	40 12 25 00 00 00 00 00 (:FETCh:VOLTage?) Return data is 100500. 43 12 25 00 A0 86 01 00 The voltage is 100.5 V, Magnification is 1000.

Object 0x2513: FETCh[:SCALAr]:VOLTage[:RMS]:TOTal

Description	Returns the read total of voltage (Vrms).
Index	0x2513
Sub-Index	0x00
Value	Returns the read total of voltage value in Vrms.
Type	Signed32
Data size	4 Bytes
Access	ro
Example	40 13 25 00 00 00 00 00

(SDO)	(:FETCh:VOLTage:TOTal?)
	Return data is 100500. 43 13 25 00 A0 86 01 00
	The total of voltage is 100.5 V, Magnification is 1000.

Object 0x2514: FETCh[:SCALar]:VOLTage:AC

Description	Returns the read AC voltage (Vrms).
Index	0x2514
Sub-Index	0x00
Value	Returns the read AC voltage value in Vrms.
Type	Signed32
Data size	4 Bytes
Access	ro
Example (SDO)	40 14 25 00 00 00 00 00 (:FETCh:VOLTage:AC?)
	Return data is 100500. 43 14 25 00 A0 86 01 00
	The AC voltage is 100.5 V, Magnification is 1000.

Object 0x2515: FETCh[:SCALAr]:VOLTage:AVERage

Description	Returns the read voltage average value (Vavg).
Index	0x2515
Sub-Index	0x00
Value	Returns the read voltage average value in volts.
Type	Signed32
Data size	4 Bytes
Access	ro
Example (SDO)	40 15 25 00 00 00 00 00 (:FETCh:VOLTage:AC?)
	Return data is -50750. 43 15 25 00 C2 39 FF FF The voltage average is -50.75 V, Magnification is 1000.

Object 0x2516: FETCh[:SCALAr]:VOLTage:HIGH

Description	Returns the read output voltage maximum peak value (Vmax).
Index	0x2516
Sub-Index	0x00
Value	Returns the read Vmax value in volts.
Type	Signed32
Data size	4 Bytes
Access	ro
Note	Voltage maximum peak value is defined

	as the highest peak value in the complete period.
Example (SDO)	40 16 25 00 00 00 00 00 (:FETCh:VOLTage:HIGH?)
	Return data is 100500. 43 16 25 00 A0 86 01 00 The voltage maximum peak is 100.5 V, Magnification is 1000.

Object 0x2517: FETCh[:SCALar]:VOLTage:LOW

Description	Returns the read output voltage minimum value (Vmin).
Index	0x2517
Sub-Index	0x00
Value	Returns the read Vmin value in volts.
Type	Signed32
Data size	4 Bytes
Access	ro
Note	Voltage minimum value is defined as the lowest value in the complete period.
Example (SDO)	40 17 25 00 00 00 00 00 (:FETCh:VOLTage:LOW?)
	Return data is -50750. 43 17 25 00 C2 39 FF FF The voltage minimum is -50.75 V, Magnification is 1000.

Object 0x251C: FETCh[:SCALar]:LINE:VOLTage[:RMS]

Description	Returns the read line voltage (Vrms).
Index	0x251C
Sub-Index	0x00
Value	Returns the read line voltage value in Vrms.
Type	Signed32
Data size	4 Bytes
Access	ro
Example (SDO)	40 1C 25 00 00 00 00 00 (:FETCh:LINE:VOLTage?)
	Return data is 100500. 43 1C 25 00 A0 86 01 00 The line voltage is 100.5 V, Magnification is 1000.

Object 0x251D: FETCh[:SCALar]:LINE:VOLTage:AVERage

Description	Returns the read line voltage average value (Vavg).
Index	0x251D
Sub-Index	0x00
Value	Returns the read line voltage average value in volts.
Type	Signed32
Data size	4 Bytes
Access	ro
Example	40 1D 25 00 00 00 00 00

(SDO) (:FETCh:LINE:VOLTage:AVERage?)

Return data is 100500.
 43 1D 25 00 A0 86 01 00
 The line voltage average is 100.5 V,
 Magnification is 1000.

Object 0x251E: FETCh[:SCALar]:LINE:VOLTage:HIGH

Description	Returns the read output line voltage maximum peak value (Vmax).
Index	0x251E
Sub-Index	0x00
Value	Returns the read line Vmax value in volts.
Type	Signed32
Data size	4 Bytes
Access	ro
Note	Line voltage maximum peak value is defined as the highest peak value in the complete period.
Example (SDO)	40 1E 25 00 00 00 00 00 (:FETCh:LINE:VOLTage:AVERage:HIGH?)

Return data is 100500.
 43 1E 25 00 A0 86 01 00
 The line voltage maximum peak is 100.5 V,
 Magnification is 1000.

Object 0x251F: FETCh[:SCALAr]:LINE:VOLTage:LOW

Description	Returns the output read line voltage minimum value (Vmin).
Index	0x251F
Sub-Index	0x00
Value	Returns the read line Vmin value in volts.
Type	Signed32
Data size	4 Bytes
Access	ro
Note	Line voltage minimum value is defined as the lowest value in the complete period.
Example (SDO)	<p>40 1F 25 00 00 00 00 00</p> <p>(:FETCh:LINE:VOLTage:LOW?)</p> <p>Return data is -50750.</p> <p>43 1F 25 00 C2 39 FF FF</p> <p>The line voltage minimum is -50.75 V, Magnification is 1000.</p>

Object 0x251A: FETCh[:SCALAr]: VOLTage:HARMOonic[:RMS]

Description	Returns 101 values covering Total and order 1 to 100 fetch voltage (Vrms) in harmonic. (Only AC-INT and 50/60 Hz Active)
Index	0x251A
Sub-Index	0x00 (Total fetch voltage (Vrms) in harmonic.)
Value	Returns the Total fetch voltage (Vrms) in harmonic.

Type	Signed32
Data size	4 Bytes
Access	ro
Sub-Index	0x01 (Page 1)
Value	Returns the entire 20 values containing order 1 to 20 fetch voltage (Vrms) in harmonic.
Type	Signed32
Data size	80 Bytes
Access	ro
Sub-Index	0x02 (Page 2)
Value	Returns the entire 20 values containing order 21 to 40 fetch voltage (Vrms) in harmonic.
Type	Signed32
Data size	80 Bytes
Access	ro
Sub-Index	0x03 (Page 3)
Value	Returns the entire 20 values containing order 41 to 60 fetch voltage (Vrms) in harmonic.
Type	Signed32
Data size	80 Bytes
Access	ro
Sub-Index	0x04 (Page 4)
Value	Returns the entire 20 values containing order 61 to 80 fetch voltage (Vrms) in harmonic.
Type	Signed32
Data size	80 Bytes

Access	ro
Sub-Index	0x05 (Page 5)
Value	Returns the entire 20 values containing order 81 to 100 fetch voltage (Vrms) in harmonic.
Type	Signed32
Data size	80 Bytes

Access	ro
--------	----

Example (SDO)

Command 1:
 40 1A 25 05 00 00 00 00
 (:FETCh: VOLTage:HARMonic? 5)

Return 1:
 41 1A 25 05 50 00 00 00
 (Data Size is "80 Bytes")

Command 2:
 60 1A 25 00 00 00 00 00

Return 2:
 00 (Byte 1 ~ Byte 7 is data)

Command 3:
 70 1A 25 00 00 00 00 00

Return 3:
 10 (Byte 1 ~ Byte 7 is data)

⋮
 ⋮

In a total of 80 bytes of data, every 4 bytes are regarded as a data.

Object 0x251B: FETCh[:SCALAr]:VOLTage:HARMonic:RATio

Description	Returns 101 values covering Total and order 1 to 100 fetch current (Ratio) in harmonic. (Only AC-INT and 50/60 Hz Active)
Index	0x251B
Sub-Index	0x00 (Total fetch current (Ratio) in harmonic.)
Value	Returns the Total fetch current (Ratio) in harmonic.
Type	Signed32
Data size	4 Bytes
Access	ro
Sub-Index	0x01 (Page 1)
Value	Returns the entire 20 values containing order 1 to 20 fetch current (Ratio) in harmonic.
Type	Signed32
Data size	80 Bytes
Access	ro
Sub-Index	0x02 (Page 2)
Value	Returns the entire 20 values containing order 21 to 40 fetch current (Ratio) in harmonic.
Type	Signed32
Data size	80 Bytes
Access	ro
Sub-Index	0x03 (Page 3)
Value	Returns the entire 20 values

	containing order 41 to 60 fetch current (Ratio) in harmonic.
Type	Signed32
Data size	80 Bytes
Access	ro
Sub-Index	0x04 (Page 4)
Value	Returns the entire 20 values containing order 61 to 80 fetch current (Ratio) in harmonic.
Type	Signed32
Data size	80 Bytes
Access	ro
Sub-Index	0x05 (Page 5)
Value	Returns the entire 20 values containing order 81 to 100 fetch current (Ratio) in harmonic.
Type	Signed32
Data size	80 Bytes
Access	ro
Example (SDO)	<p>Command 1: 40 25 1B 05 00 00 00 00 (:FETCh: VOLTage:HARMonic:RATio? 5)</p> <p>Return 1: 41 25 1B 05 50 00 00 00 (Data Size is "80 Bytes")</p> <p>Command 2: 60 25 1B 00 00 00 00 00</p> <p>Return 2: 00 (Byte 1 ~ Byte 7 is data)</p>

Command 3:

70 25 1B 00 00 00 00 00

Return 3:

10 (Byte 1 ~ Byte 7 is data)

In a total of 80 bytes of data, every 4 bytes
are regarded as a data.

Memory Commands

Object 0x2905: MEMory:RCL	158
Object 0x2904: MEMory:SAV	159

Object 0x2905: MEMory:RCL

Description	Recalls the settings from memory slot M0~M9. These memory slots are mapped to the preset settings. Equivalent to the *RCL command.
Index	0x2905
Sub-Index	0x00
Value	0 ~ 9
Type	Unsigned8
Data size	1 Byte
Access	wo
Example (SDO)	23 05 29 00 01 00 00 00 (:MEMory:RCL 1) Recall the settings from M1.

Object 0x2904: MEMory:SAV

Description	Saves the settings into memory slot M0 ~ M9. These memory slots are mapped to the preset settings. Equivalent to the *SAV command.
Index	0x2904
Sub-Index	0x00
Value	0 ~ 9
Type	Unsigned8
Data size	1 Byte
Access	wo
Example (SDO)	23 04 29 00 01 00 00 00 (:MEMory:SAV 1) Save the settings to M1.

Output Commands

Object 0x2A01: OUTPut:IMPedance.....	160
Object 0x2A02: OUTPut:IMPedance:INDuctance	161
Object 0x2A03: OUTPut:IMPedance:RESistance	161
Object 0x2A04: OUTPut:MONitor:AMPLitude	162
Object 0x2A05: OUTPut:MONitor:SOURce<1 2>.....	163
Object 0x2A0A: OUTPut[:STATe]	163
Object 0x2A06: OUTPut:PON	164
Object 0x2A07: OUTPut:PROTection:CLEar	165
Object 0x2A08: OUTPut:RELAY	165

Object 0x2A01: OUTPut:IMPedance

Description	Sets or queries the output impedance state of power source.
Index	0x2A01
Sub-Index	0x00
Value	0 = OFF Turns the output impedance off. 1 = ON Turns the output impedance on.
Type	Unsigned8
Data size	1 Byte
Access	rw
Example (SDO)	23 01 2A 00 00 00 00 00 (:OUTP:IMP 0) Sets power output impedance off.

Object 0x2A02: OUTPut:IMPedance:INDuctance

Description	Sets or queries the phase and inductance value parameter for output impedance inductance.
Index	0x2A02
Sub-Index	0x00 ~ 0x02 (L1 ~ L3 phase)
Value	inductance : 0.0 ~ 2000 μ H (Set Value = Value * 10)
Type	Unsigned16
Data size	2 Bytes
Access	rw
Example (SDO)	40 02 2A 00 00 00 00 00 (OUTP:IMP:IND? L1) Return data is 1 (0.1 μ H) 43 02 2A 00 01 00 00 00 Returns the L1 phase and inductance value parameter for output impedance inductance.

Object 0x2A03: OUTPut:IMPedance:RESistance

Description	Sets or queries the phase and inductance value parameter for output impedance resistance.
Index	0x2A03
Sub-Index	0x00 ~ 0x02 (L1 ~ L3 phase)
Value	resistance : 0.0 ~ 1 Ω (Set Value = Value * 10)

Type	Unsigned16
Data size	2 Bytes
Access	rw
Example (SDO)	40 03 2A 00 00 00 00 00 (:OUTP:IMP:RES? L1)
	Return data is 1 (0.1 μH) 43 03 2A 00 01 00 00 00
	Returns the L1 phase and resistance value parameter for output impedance resistance.

Object 0x2A04: OUTPut:MONitor:AMPLitude

Description	Sets or queries the range for output monitor amplitude.
Index	0x2A04
Sub-Index	0x00
Value	0 = ±2.5 LOW 1 = ±10 HIGH
Type	Unsigned8
Data size	1 Byte
Access	rw
Example (SDO)	23 04 2A 00 01 00 00 00 (:OUTP:MON:AMPL HIGH)
	Sets the amplitude range to high.

Object 0x2A05: OUTPut:MONitor:SOURce<1|2>

Description	Sets or queries the source for monitor output1 or monitor output2.(For single-phase, only L1 can be set. For single-phase three-wire, L1 and L2,can be set.)	
Index	0x2A05	
Sub-Index	0x00 ~ 0x01 (Output 1 ~ 2)	
Value	0 = L1Voltage	L1 phase voltage
	1 = L2Voltage	L2 phase voltage
	2 = L3Voltage	L3phase voltage
	3 = L1Current	L1 phase current
	4 = L2Current	L2 phase current
	5 = L3Current	L3 phase current
Type	Unsigned8	
Data size	1 Byte	
Access	rw	
Example (SDO)	23 05 2A 00 01 00 00 00 (:OUTP:MON:SOUR1 L2Voltage)	

Sets the monitor source1 L2 phase voltage.

Object 0x2A0A: OUTPut[:STATe]

Description	Sets or queries the output state of power source.	
Index	0x2A0A	
Sub-Index	0x00	
Value	0 = OFF	Turns the output off.
	1 = ON	Turns the output on.

Type	Unsigned8
Data size	1 Byte
Access	rw
Example (SDO)	23 0A 2A 00 00 00 00 00 (:OUTP 0)
	Sets power output off.

Object 0x2A06: OUTPut:PON

Description	Sets the output state at power-on.	
Index	0x2A06	
Sub-Index	0x00	
Value	0 = OFF	Disabled
	1 = ON	Enabled
	2 = SEQ	Sequence function
	3 = SIM	Simulate function
Type	Unsigned8	
Data size	1 Byte	
Access	rw	
Example (SDO)	23 06 2A 00 02 00 00 00 (:OUTPut:PON 2)	
	Sets sequence function on at power-on.	

Object 0x2A07: OUTPut:PROtection:CLEAr

Description	The Command will clear alarms like Over Current, Over Peak Current, Output Over-Power, Output Short, Output Overvoltage, Sensing Voltage Error.
Index	0x2A07
Sub-Index	0x00
Value	-
Type	Unsigned8
Data size	1 Byte
Access	wo

Object 0x2A08: OUTPut:RELay

Description	Sets or queries the output relay of power source.
Index	0x2A08
Sub-Index	0x00
Value	0 = OFF Turns the output relay Disable. 1 = ON Turns the output relay Enable.
Type	Unsigned8
Data size	1 Byte
Access	rw
Example (SDO)	23 08 2A 00 00 00 00 00 (:OUTP:REL 1) Sets output relay Enable.

System Function Commands

Object 0x2C02: SYSTem:ARBitrary:EDIT:BUILtin	167
Object 0x2C0B: SYSTem:ARBitrary:EDIT:SURGe	168
Object 0x2C08: SYSTem:ARBitrary:EDIT:STAir	170
Object 0x2C03: SYSTem:ARBitrary:EDIT:CFACtor<1 2>	170
Object 0x2C04: SYSTem:ARBitrary:EDIT:CLIP	172
Object 0x2C09: SYSTem:ARBitrary:EDIT:STORe	172
Object 0x2C0C: SYSTem:ARBitrary:EDIT:TRlngle	174
Object 0x2C05: SYSTem:ARBitrary:EDIT:DIP	174
Object 0x2C06: SYSTem:ARBitrary:EDIT:LFRing	176
Object 0x2C07: SYSTem:ARBitrary:EDIT:RIPPlE.....	179
Object 0x2C0A: SYSTem:ARBitrary:EDIT:STORe:APPLy<1 3>.....	180
Object 0x2C0E: SYSTem:BEEPer:STATe	183
Object 0x2C11: SYSTem:COMMunicate:INTerface:ADDRes	183
Object 0x2C12: SYSTem:COMMunicate:INTerface:BAUD	184
Object 0x2C13: SYSTem:COMMunicate:LAN:DHCP	185
Object 0x2C14: SYSTem:COMMunicate:LAN:DNS.....	185
Object 0x2C15: SYSTem:COMMunicate:LAN:GATeway	186
Object 0x2C17: SYSTem:COMMunicate:LAN:IPADdress	186
Object 0x2C18: SYSTem:COMMunicate:LAN:MAC	187
Object 0x2C19: SYSTem:COMMunicate:LAN:SMASK	188
Object 0x2C1C: SYSTem:COMMunicate:RLSTate.....	189
Object 0x2C1D:	
SYSTem:COMMunicate:SERial[:RECeive]:TRANsmit:BAUD.....	190
Object 0x2C1E:	
SYSTem:COMMunicate:SERial[:RECeive]:TRANsmit:BITS	191
Object 0x2C1F:	
SYSTem:COMMunicate:SERial[:RECeive]:TRANsmit:PARity.....	191
Object 0x2C20:	
SYSTem:COMMunicate:SERial[:RECeive]:TRANsmit:SBITs.....	192
Object 0x2C21: SYSTem:COMMunicate:TCPIP:CONTRol.....	193
Object 0x2C22: SYSTem:COMMunicate:USB:FRONT:STATe.....	194
Object 0x2C24: SYSTem:COMMunicate:USB:REAR:STATe.....	194
Object 0x2C27: SYSTem:CONFigure[:MODE]	194
Object 0x2C25: SYSTem:CONFigure:EXTio[:STATe]	195
Object 0x2C26: SYSTem:CONFigure:PHASe	195
Object 0x2C28: SYSTem:CONFigure:TRIGger:OUTPut:SOURce.....	196
Object 0x2C29: SYSTem:CONFigure:TRIGger:OUTPut:WIDTh	197

Object 0x2C32: SYSTem:HOLD:STATe..... 197
 Object 0x2C2E: SYSTem:PKHold:TIME 198
 Object 0x2C2C: SYSTem:KLOCK 198
 Object 0x2C2F: SYSTem:REBoot 199
 Object 0x2C0D: SYSTem:VUNit..... 199

Object 0x2C02: SYSTem:ARBitrary:EDIT:BUILtin

Description	Sets or queries the built in function of arbitrary edit.
Index	0x2C02
Sub-Index	0x00
Value	0 = TRIangle Built In Triangle Wave Function 1 = STAir Built In Stair Wave Function 2 = CLIP Built In Clip Wave Function 3 = CFACTOR1 Built In CF-1 Wave Function 4 = CFACTOR2 Built In CF-2 Wave Function 5 = SURGe Built In Surge Wave Function 6~27 = DST01 ~ DST22 Built In DST01 ~ DST22 Wave 28 = RIPPLE Built In DC Ripple Wave Function 29 = DIP Built In DIP Wave Function. 30 = LFRing

	Built In LFRing Wave Function.
Type	Unsigned8
Data size	1 Byte
Access	rw
Example (SDO)	40 02 2C 00 00 00 00 00 (:SYST:ARB:EDIT:BUIL?)
	Return data is 0 (TRI) 43 02 2C 00 01 00 00 00
	Returns the built in function of arbitrary edit.

Object 0x2C0B: SYSTem:ARBitrary:EDIT:SURGe

Description	Sets or queries the type and ACV and site parameter for built in Surge wave function.	
Index	0x2C0B	
Sub-Index	0x00 (Type)	
Value	0 = SQU	Square waveform type
	1 = SIN	Sine waveform type
Type	Unsigned8	
Data size	1 Byte	
Access	rw	
Sub-Index	0x01 (ACV)	
Value	ACV Ratio : 0 ~100(0 ~ 100%)	
Type	Unsigned16	
Data size	2 Bytes	
Access	rw	

Sub-Index	0x02 (Site)
Value	Site Ratio : 0 ~100(0 ~ 100%)
Type	Unsigned16
Data size	2 Bytes
Access	rw

Example
(SDO)
40 0B 2C 00 00 00 00 00
40 0B 2C 01 00 00 00 00
40 0B 2C 02 00 00 00 00
(:SYST:ARB:EDIT:SURG?)

Sub-Index 0 return data is 0 (SIN)
43 0B 2C 00 00 00 00 00

Sub-Index 1 return data is 50 (ACV: 50%)
43 0B 2C 01 32 00 00 00

Sub-Index 2 return data is 25 (Site: 25%)
43 0B 2C 02 19 00 00 00

Returns the type and ACV and site parameter for built in Surge wave function.

Object 0x2C08: SYSTem:ARBitrary:EDIT:STAir

Description	Sets or queries the stair parameter for built in stair wave function.
Index	0x2C08
Sub-Index	0x00
Value	stair : 1 ~ 100
Type	Unsigned8
Data size	1 Byte
Access	rw
Example (SDO)	40 08 2C 00 00 00 00 00 (:SYST:ARB:EDIT:STA?)
	Return data is 5 (Stairs: 5) 43 08 2C 00 05 00 00 00
	Returns the stair parameter for built in stair wave Function.

Object 0x2C03: SYSTem:ARBitrary:EDIT:CFACTOR<1|2>

Description	Sets or queries the crest factor parameter for built in CF-1, CF-2 wave function.
Index	0x2C03
Sub-Index	0x00 (CF-1)
Value	crest factor : 1.1 ~ 10.0 (Set Value = Value * 10)
Type	Unsigned16
Data size	2 Bytes
Access	rw

Example (SDO)	40 03 2C 00 00 00 00 00 (:SYST:ARB:EDIT:CFAC1?)
	Return data is 20 (CF: 2.0) 43 03 2C 00 02 00 00 00
	Returns the crest factor parameter for built in CF-1 wave function
Sub-Index	0x01 (CF-2)
Value	crest factor : 1.5 ~ 2.0 (Set Value = Value * 10)
Type	Unsigned8
Data size	1 Byte
Access	rw
Example (SDO)	40 03 2C 01 00 00 00 00 (:SYST:ARB:EDIT:CFAC2?)
	Return data is 15 (CF: 1.5) 43 03 2C 01 14 00 00 00
	Returns the crest factor parameter for built in CF-2 wave function

Object 0x2C04: SYSTem:ARBitrary:EDIT:CLIP

Description	Sets or queries the ratio parameter for built in clip wave function.
Index	0x2C04
Sub-Index	0x00
Value	clip ratio : 0.00 ~ 1.00 (Set Value = Value * 100)
Type	Unsigned16
Data size	2 Bytes
Access	rw
Example (SDO)	40 04 2C 00 00 00 00 00 (:SYST:ARB:EDIT:CLIP?) Return data is 50 (CF: 0.50) 43 04 2C 00 32 00 00 00 Returns the ratio parameter for built in clip wave function.

Object 0x2C09: SYSTem:ARBitrary:EDIT:STORe

Description	Saves the waveform data of built in into ARB1 ~ARB16.
Index	0x2C09
Sub-Index	0x00
Value	0 = ARB1 Saves the waveform data of built in into ARB1 1 = ARB2 Saves the waveform data of built in into ARB2 2 = ARB3 Saves the waveform data

of built in into ARB3

3 = ARB4 Saves the waveform data of built in into ARB4

4 = ARB5 Saves the waveform data of built in into ARB5

5 = ARB6 Saves the waveform data of built in into ARB6

6 = ARB7 Saves the waveform data of built in into ARB7

7 = ARB8 Saves the waveform data of built in into ARB8

8 = ARB9 Saves the waveform data of built in into ARB9

9 = ARB10 Saves the waveform data of built in into ARB10

10 = ARB11 Saves the waveform data of built in into ARB11

11 = ARB12 Saves the waveform data of built in into ARB12

12 = ARB13 Saves the waveform data of built in into ARB13

13 = ARB14 Saves the waveform data of built in into ARB14

14 = ARB15 Saves the waveform data of built in into ARB15

15 = ARB16 Saves the waveform data of built in into ARB16

Type	Unsigned8
Data size	1 Byte
Access	w0
Example (SDO)	23 09 2C 00 00 00 00 00 (:SYST:ARB:EDIT:STOR ARB1)

Saves the waveform data of built in into ARB1

Object 0x2C0C: SYSTem:ARBitrary:EDIT:TRlangle

Description	Sets or queries the symmetry parameter for built in triangle wave function.
Index	0x2C0C
Sub-Index	0x00
Value	Symmetry : 0 ~ 100 (0 ~ 100%)
Type	Unsigned16
Data size	2 Bytes
Access	rw
Example (SDO)	40 0C 2C 00 00 00 00 00 (:SYST:ARB:EDIT:TRI?)
	Return data is 50 (Sym: 0.50) 43 0C 2C 00 32 00 00 00
	Returns the symmetry parameter for built in triangle wave function.

Object 0x2C05: SYSTem:ARBitrary:EDIT:DIP

Description	Sets or queries the ST Phs and SP Phs and End Phs parameter for built in DIP wave function.
Index	0x2C05
Sub-Index	0x00 (STPhs)
Value	0.1 ~ (SP Phs - 0.1) (Set Value = Value * 10)

Type	Unsigned32
Data size	4 Bytes
Access	rw
Sub-Index	0x01 (SPPhs)
Value	(ST Phs+ 0.1) ~ (End Phs - 0.1) (Set Value = Value * 10)
Type	Unsigned32
Data size	4 Bytes
Access	rw
Sub-Index	0x02 (EndPhs)
Value	(SP Phs+ 0.1) ~ 359.9 (Set Value = Value * 10)
Type	Unsigned32
Data size	4 Bytes
Access	rw
Example (SDO)	40 05 2C 00 00 00 00 00 40 05 2C 01 00 00 00 00 40 05 2C 02 00 00 00 00 (:SYSTem:ARBITrary:EDIT:DIP?)
	Sub-Index 0 return data is 450 (ST Phs: 45.0) 43 05 2C 00 C2 01 00 00
	Sub-Index 1 return data is 540 (SP Phs: 54.0) 43 05 2C 01 02 1C 00 00
	Sub-Index 2 return data is 1720 (End Phs:

172.0)

43 05 2C 02 B8 06 00 00

Returns the ST Phs and SP Phs and End Phs parameter for built in DIP wave function.

Object 0x2C06: SYSTem:ARBITrary:EDIT:LFRing

Description	Sets or queries the ACV and Amp and Base_F and Ring_F and Decay and ST Phs and End Phs and Ring Phs parameter for built in LFRing wave function.
Index	0x2C06
Sub-Index	0x00 (ACV)
Value	0.00 ~ 400.0 (Set Value = Value * 100)
Type	Unsigned32
Data size	4 Bytes
Access	rw
Sub-Index	0x01 (Amp)
Value	140 ~ 200
Type	Unsigned32
Data size	4 Bytes
Access	rw
Sub-Index	0x02 (Base_F)
Value	50.0 ~ 200.0 (Set Value = Value * 10)
Type	Unsigned32
Data size	4 Bytes

Access	rw
Sub-Index	0x03 (Ring_F)
Value	200.0 ~ 5000.0 (Set Value = Value * 10)
Type	Unsigned32
Data size	4 Bytes
Access	rw
Sub-Index	0x04 (Decay)
Value	-0.100 ~ 0.100 (Set Value = Value * 1000)
Type	Unsigned32
Data size	4 Bytes
Access	rw
Sub-Index	0x05 (STPhs)
Value	0.1 ~ (End Phs - 0.1) (Set Value = Value * 10)
Type	Unsigned32
Data size	4 Bytes
Access	rw
Sub-Index	0x06 (EndPhs)
Value	(ST Phs+ 0.1) ~ 359.9 (Set Value = Value * 10)
Type	Unsigned32
Data size	4 Bytes
Access	rw
Sub-Index	0x07 (RingPhs)
Value	0.1 ~ 359.9

(Set Value = Value * 10)

Type	Unsigned32
Data size	4 Bytes
Access	rw

Example 40 06 2C 00 00 00 00 00

(SDO) 40 06 2C 01 00 00 00 00

40 06 2C 02 00 00 00 00

40 06 2C 03 00 00 00 00

40 06 2C 04 00 00 00 00

40 06 2C 05 00 00 00 00

40 06 2C 06 00 00 00 00

40 06 2C 07 00 00 00 00

(:SYSTem:ARBitrary:EDIT:LFRing?)

Sub-Index 0 return data is 0 (ACV: 45.0)

43 06 2C 00 00 00 00 00

Sub-Index 1 return data is 140 (Amp: 140%)

43 06 2C 01 8C 00 00 00

Sub-Index 2 return data is 500 (Base_F: 50.0)

43 06 2C 02 F4 01 00 00

Sub-Index 3 return data is 2000 (Ring_F: 200.0)

43 06 2C 03 D0 07 00 00

Sub-Index 4 return data is 5 (Decay: 0.005)

43 06 2C 04 05 00 00 00

Sub-Index 5 return data is 600 (ST Phs: 60)

43 06 2C 05 58 02 00 00

Sub-Index 6 return data is 1200 (End Phs: 120.0)

43 06 2C 06 B0 04 00 00

Sub-Index 7 return data is 300 (Ring Phs: 30.0)

43 06 2C 07 2C 01 00 00

Returns the ACV and Amp and Base_F and Ring_F and Decay and ST Phs and End Phs and Ring Phs parameter for built in LFRing wave function.

Object 0x2C07: SYSTEM:ARbitrary:EDIT:RIPPLE

Description	Sets or queries the Times and VDC and Level parameter for built in DC Ripple wave function.
Index	0x2C07
Sub-Index	0x00 (Times)
Value	Times : 1 2 3 6
Type	Unsigned8
Data size	1 Byte
Access	rw
Sub-Index	0x01 (VDC)
Value	VDC Value : 1 ~ 100

Type	Unsigned16
Data size	2 Bytes
Access	rw
Sub-Index	0x02 (Level)
Value	Level Ratio : 1 ~ 30(1 ~ 30%)
Type	Unsigned16
Data size	2 Bytes
Access	rw
Example	40 07 2C 00 00 00 00 00
(SDO)	40 07 2C 01 00 00 00 00
	40 07 2C 02 00 00 00 00
	(:SYST:ARB:EDIT:RIPP?)

Sub-Index 0 return data is 1 (Times: 1)

43 07 2C 00 01 00 00 00

Sub-Index 1 return data is 48 (VDC: 48)

43 07 2C 01 30 00 00 00

Sub-Index 2 return data is 15 (Level: 15%)

43 07 2C 02 0F 00 00 00

Returns the Times and VDC and Level parameter for built in DC Ripple wave function.

Object 0x2C0A: SYSTem:ARBItrary:EDIT:STORe:APPLy<1|3>

Description	Saves the waveform to L1 or L2 or L3 phase(into ARB1 ~ ARB16)/Output Mode/ACV/DCV/VPK+ Limit/VPK-
-------------	---------------------------------------------------------------------------------------------------

Limit/V Unit(TRI, ARB) data(for Built in is RIPPLE)

Saves the waveform to L1 or L2 or L3 phase(into ARB1 ~ ARB16)/Output Mode/ACV/DCV/VPK+ Limit/VPK-Limit/V Unit(TRI, ARB)/Freq/Freq Hi Limit/Freq Lo Limit data(for Built in is LFRing)

For single-phase, only L1 can be set. For single-phase three-wire, L1 and L2,can be set.

If instrument edit setting all,apply all phase.

Index	0x2C0A
Sub-Index	0x00 ~ 0x02 (SAVE & APPLY L1 ~ L3)
Value	<p>0 = ARB1 Saves the waveform data of built in into ARB1</p> <p>1 = ARB2 Saves the waveform data of built in into ARB2</p> <p>2 = ARB3 Saves the waveform data of built in into ARB3</p> <p>3 = ARB4 Saves the waveform data of built in into ARB4</p> <p>4 = ARB5 Saves the waveform data of built in into ARB5</p> <p>5 = ARB6 Saves the waveform data of built in into ARB6</p> <p>6 = ARB7 Saves the waveform data of built in into ARB7</p> <p>7 = ARB8 Saves the waveform data of built in into ARB8</p> <p>8 = ARB9 Saves the waveform data of built in</p>

into ARB9

9 = ARB10 Saves the waveform data of built in into ARB10

10 = ARB11 Saves the waveform data of built in into ARB11

11 = ARB12 Saves the waveform data of built in into ARB12

12 = ARB13 Saves the waveform data of built in into ARB13

13 = ARB14 Saves the waveform data of built in into ARB14

14 = ARB15 Saves the waveform data of built in into ARB15

15 = ARB16 Saves the waveform data of built in into ARB16

Type	Unsigned8
Data size	1 Byte
Access	wo
Example (SDO)	23 0A 2C 00 01 00 00 00 (:SYST:ARB:EDIT:STOR:APPL1 ARB2)

Saves the waveform(into ARB2) and Output Mode(AC+DC-INT) / ACV / DCV / VPK+ Limit(max) / VPK- Limit(min) / /V Unit(TRI, ARB)(p-p) data(for Built in is RIPPLE)

Saves the waveform(into ARB2) and Output Mode(AC+DC-INT) / ACV / DCV / VPK+ Limit(max) / VPK- Limit(min) / /V Unit(TRI, ARB)(p-p)/Freq/Freq Hi Limit(max)/Freq Lo Limit(min) data(for Built in is LFRing).

Object 0x2C0E: SYSTm:BEEPer:STATe

Description	Sets or queries the buzzer state on/off.
Index	0x2C0E
Sub-Index	0x00
Value	0 = OFF Turns the buzzer off. 1 = ON Turns the buzzer on.
Type	Unsigned8
Data size	1 Byte
Access	rw

Object 0x2C11: SYSTEM:COMMunicate:INTERface:ADDRes

Description	Sets or queries the GPIB address or CAN Node ID or DeviceNet MAC ID.
Index	0x2C11
Sub-Index	0x00
Value	0~30 (GPIB address) 1~127 (CAN Bus Node ID) 0~63 (DeviceNet MAC ID)
Type	Unsigned8
Data size	1 Byte
Access	rw
Note	Depends on Option interface device. The setting will only be valid after the power has been cycled.
Example (SDO)	23 11 2C 00 0F 00 00 00 (SYST:COMM:INT:ADDR 15)
	Sets the GPIB address or CAN Node ID or DeviceNet MAC ID to 15.

Object 0x2C12: SYSTem:COMMunicate:INTerface:BAUD

Description	Sets or queries the CAN Baudrate or DeviceNet Baudrate.
Index	0x2C12
Sub-Index	0x00
Value	<p>0 = 125000</p> <p>1 = 250000</p> <p>2 = 500000</p> <p>3 = 1000000</p> <p>4 = Auto (CAN Baudrate)</p> <p>0 = 125000</p> <p>1 = 250000</p> <p>2 = 500000</p> <p>3 = Auto (DeviceNet Baudrate)</p>
Type	Unsigned8
Data size	1 Byte
Access	rw
Note	Depends on Option interface device.The setting will only be valid after the power has been cycled.
Example (SDO)	<p>40 12 2C 00 00 00 00 00</p> <p>(:MEASure:AVERage:COUNt?)</p> <p>Return data is 1 (250000)</p> <p>43 12 2C 00 01 00 00 00</p> <p>Returns the baud rate settings.</p>

Object 0x2C13: SYSTEM:COMMunicate:LAN:DHCP

Description	Turns DHCP on/off. Queries the DHCP status.	
Index	0x2C13	
Sub-Index	0x00	
Value	0 = OFF	DHCP off
	1 = ON	DHCP on
Type	Unsigned8	
Data size	1 Byte	
Access	rw	
Note	The setting will only be valid after the power has been cycled.	

Object 0x2C14: SYSTEM:COMMunicate:LAN:DNS

Description	Sets or queries the DNS address.	
Index	0x2C14	
Note	The setting will only be valid after the power has been cycled.	
Sub-Index	0x00	
Value	0 ~ 255	
Type	Unsigned8	
Data size	4 Bytes	
Access	rw	
Example (SDO)	22 14 2C 00 FC 01 10 AC (SYST:COMM:LAN:DNS "172.16.1.252")	
	Sets the DNS to 172.16.1.252.	

Object 0x2C15: SYSTem:COMMunicate:LAN:GATeway

Description	Sets or queries the Gateway address.
Index	0x2C15
Note	The setting will only be valid after the power has been cycled.
Sub-Index	0x00
Value	0 ~ 255
Type	Unsigned8
Data size	4 Bytes
Access	rw
Example (SDO)	22 15 2C 00 FE 00 10 AC (SYST:COMM:LAN:GAT "172.16.0.254")
	Sets the LAN gateway to 172.16.0.254.

Object 0x2C17: SYSTem:COMMunicate:LAN:IPADdress

Description	Sets or queries LAN IP address.
Index	0x2C17
Note	The setting will only be valid after the power has been cycled.
Sub-Index	0x00
Value	0 ~ 255
Type	Unsigned8
Data size	4 Bytes
Access	rw
Example (SDO)	22 17 2C 00 6F 05 10 AC (SYST:COMM:LAN:IPAD "172.16.5.111")
	Sets the IP address to 172.16.5.111.

Object 0x2C18: SYSTem:COMMunicate:LAN:MAC

Description	Returns the unit MAC address as a string. The MAC address cannot be changed.
Index	0x2C18
Sub-Index	0x00
Value	Returns the MAC address in the following format "FF-FF-FF-FF-FF-FF"
Type	char
Data size	17 Bytes
Access	ro
Example (SDO)	<p>Send</p> <pre>40 18 2C 00 00 00 00 00 60 18 2C 00 00 00 00 00 70 18 2C 00 00 00 00 00 60 18 2C 00 00 00 00 00 (SYST:COMM:LAN:MAC?)</pre> <p>Return (MAC: 02:80:AD:20:31:B1)</p> <pre>41 18 2C 00 11 00 00 00 (Data length is 17 Bytes) 00 30 32 2D 38 30 2D 41 (Data: 02:80:A) 10 44 2D 32 30 2D 33 31 (Data: D:20:31) 09 2D 42 31 00 00 00 00 (Data: :B1)</pre> <p>Returns the MAC address.</p>

Object 0x2C19: SYSTem:COMMunicate:LAN:SMASk

Description	Sets or queries the LAN subnet mask.
Index	0x2C19
Note	The setting will only be valid after the power has been cycled.
Sub-Index	0x00
Value	0 ~ 255
Type	Unsigned8
Data size	4 Bytes
Access	rw
Example (SDO)	22 19 2C 00 00 00 FF FF (SYST:COMM:LAN:SMASk "255.255.0.0")
	Sets the LAN mask to 255.255.0.0.

Object 0x2C1C: SYSTem:COMMunicate:RLSTate

Description	Enables or disables local/remote state of the instrument.
Index	0x2C1C
Sub-Index	0x00
Value	<p>0 = LOCAL All keys are valid. This instrument is controlled by the front panel controls.</p> <p>1 = REMote All keys are invalid, except for the [local] key and the ability to turn the output off.</p> <p>2 = RWLock All keys are invalid. The instrument can only be controlled remotely.</p> <p>3 = LREMote All keys are valid. This instrument is controlled by the front panel controls and remotely.</p>
Type	Unsigned8
Data size	1 Byte
Access	rw
Example (SDO)	<p>23 1C 2C 00 00 00 00 00</p> <p>(:SYST:COMM:RLST LOCAL)</p> <p>Sets the operating mode to local.</p>

Object 0x2C1D:

SYSTEM:COMMunicate:SERial[:RECEive]:TRANsmit:BAUD

Description	Sets or queries the UART baud rate.
Index	0x2C1D
Sub-Index	0x00
Value	0 = 1200 1 = 2400 2 = 4800 3 = 9600 4 = 19200 5 = 38400 6 = 57600 7 = 115200
Type	Unsigned8
Data size	1 Byte
Access	rw
Note	The setting will only be valid after the power has been cycled.
Example (SDO)	40 1D 2C 00 00 00 00 00 (SYST:COMM:SER:TRAN:BAUD?) Return data is 3 (Baud rate: 9600) 43 1D 2C 00 03 00 00 00 Returns the baud rate settings.

Object 0x2C1E:

SYSTEM:COMMunicate:SERial[:RECEive]:TRANsmit:BITS

Description	Sets or queries the UART number of data bits.	
Index	0x2C1E	
Sub-Index	0x00	
Value	0 = 7 bits 1 = 8 bits	
Type	Unsigned8	
Data size	1 Byte	
Access	rw	
Note	The setting will only be valid after the power has been cycled.	
Example (SDO)	40 1E 2C 00 00 00 00 00 (SYST:COMM:SER:TRAN:BITS?)	
	Return data is 1 43 1E 2C 00 01 00 00 00	
	Indicates that 8 data bits are used for the UART connection.	

Object 0x2C1F:

SYSTEM:COMMunicate:SERial[:RECEive]:TRANsmit:PARity

Description	Sets or queries the parity of the UART connection.	
Index	0x2C1F	
Sub-Index	0x00	
Value	0 = NONE	No parity
	1 = ODD	Odd parity

	2 = EVEN	Even parity
Type	Unsigned8	
Data size	1 Byte	
Access	rw	
Note	The setting will only be valid after the power has been cycled.	
Example (SDO)	40 1F 2C 00 00 00 00 00 (SYST:COMM:SER:TRAN:PARity?)	
	Return data is 0 43 1F 2C 00 00 00 00 00	
	Indicates that no parity is used for the UART connection.	

Object 0x2C20:

SYSTEM:COMMunicate:SERial[:RECEive]:TRANsmit:SBITs

Description	Sets or queries the number of stop bits used for the UART connection.	
Index	0x2C20	
Sub-Index	0x00	
Value	0 = 1 stop bit 1 = 2 stop bits	
Type	Unsigned8	
Data size	1 Byte	
Access	rw	
Note	The setting will only be valid after the power has been cycled.	
Example (SDO)	40 20 2C 00 00 00 00 00 (SYST:COMM:SER:TRAN:SBITs?)	

Return data is 1

43 20 2C 00 01 00 00 00

Indicates that one stop bit is used for the UART connection.

Object 0x2C21: SYSTem:COMMunicate:TCPIP:CONTROL

Description	Queries the socket port number.
Index	0x2C21
Sub-Index	0x00
Value	0000 ~ 9999
Type	Unsigned16
Data size	2 Bytes
Access	ro
Example (SDO)	40 21 2C 00 00 00 00 00 (SYST:COMM:TCP:CONT?)

Return data is 5025

43 21 2C 00 A1 13 00 00

Returns the socket port number.

Object 0x2C22: SYSTem:COMMunicate:USB:FRONT:STATe

Description	Queries the front panel USB-A port state.
Index	0x2C22
Sub-Index	0x00
Value	0 = Absent 1 = Mass Storage
Type	Unsigned8
Data size	1 Byte
Access	ro

Object 0x2C24: SYSTem:COMMunicate:USB:REAR:STATe

Description	Queries the rear panel USB-B port state.
Index	0x2C24
Sub-Index	0x00
Value	0 = Absent 1 = Connected to the PC
Type	Unsigned8
Data size	1 Byte
Access	ro

Object 0x2C27: SYSTem:CONFigure[:MODE]

Description	Sets or queries the test mode for the power supply.
Index	0x2C27
Sub-Index	0x00
Value	0 = CONTinuous Continuous mode (normal operating mode) 1 = SEQuence Sequence mode 2 = SIMulation Simulation mode

Type	Unsigned8
Data size	1 Byte
Access	rw

Object 0x2C25: SYSTEM:CONFigure:EXTIo[:STATe]

Description	Sets or queries the external control state on/off.	
Index	0x2C25	
Sub-Index	0x00	
Value	0 = OFF	Turns the external control off.
	1 = ON	Turns the external control on.
Type	Unsigned8	
Data size	1 Byte	
Access	rw	

Object 0x2C26: SYSTEM:CONFigure:PHASe

Description	Sets or queries the phase configuration. (Only Continuous Mode Active)	
Index	0x2C26	
Sub-Index	0x00	
Value	From 0 - 2 which represent different configure phase, respectively.	
	0 = 3P4W	
	1 = 1P2W	
	2 = 1P3W	
Type	Unsigned8	
Data size	1 Byte	
Access	rw	
Example	40 26 2C 00 00 00 00 00	

Object 0x2C29:

SYSTem:CONFigure:TRIGger:OUTPut:WIDTh

Description	Sets or queries the type of trigger output. The trigger output can be set as a user-defined pulse width or as a trigger output level.
Index	0x2C29
Sub-Index	0x00
Value	0.1 ~ 60 mSec (Set Value = Value * 10)
Type	Unsigned32
Data size	4 Bytes
Access	rw
Example (SDO)	23 29 2C 00 05 00 00 00 (:SYST:CONF:TRIG:OUTP:WIDT 0.5)
Sets the trigger output width to 5ms.	

Object 0x2C32: SYSTem:HOLD:STATe

Description	Sets or queries the freeze hold state on/off.	
Index	0x2C32	
Sub-Index	0x00	
Value	0 = OFF	Turns the freeze hold off.
	1 = ON	Turns the freeze hold on.
Type	Unsigned8	
Data size	1 Byte	
Access	rw	

Object 0x2C2E: SYSTem:PKHold:TIME

Description	Sets or queries the Ipeak hold time for peak current measurement when output on.
Index	0x2C2E
Sub-Index	0x00
Value	1 ~ 60,000
Type	Unsigned16
Data size	2 Bytes
Access	rw
Example (SDO)	23 2E 2C 00 0A 00 00 00 (:SYST:PKH:TIME 10)
	Sets the Ipeak hold time 10ms to measure when output on.

Object 0x2C2C: SYSTem:KLOCK

Description	Enables or disables the front panel key lock.
Index	0x2C2C
Sub-Index	0x00
Value	0 = OFF Panel keys unlocked 1 = ON Panel keys locked
Type	Unsigned8
Data size	1 Byte
Access	rw

Object 0x2C2F: SYSTem:REBoot

Description	Reboots the ASR system.
Index	0x2C2F
Sub-Index	0x00
Value	-
Type	Unsigned8
Data size	1 Byte
Access	wo

Object 0x2C0D: SYSTem:VUNit

Description	Sets or Queries the Unit of Voltage Setting in Specific Wave Shape(TRI or ARB)
Index	0x2C0D
Sub-Index	0x00
Value	0 = RMS Sets V Unit (TRI, ARB) as rms 1 = P-P Sets V Unit (TRI, ARB) as p-p
Type	Unsigned8
Data size	1 Byte
Access	rw
Example (SDO)	23 0D 2C 00 01 00 00 00 (:SYSTem:VUNit?)
	Returns the V Unit(TRI, ARB) setting.

Source Commands

Object 0x2701: INSTRument:EDIT	201
Object 0x2702: INSTRument:SELect.....	202
Object 0x3001: [:SOURce]:CURRent:LIMit:PEAK:HIGH.....	202
Object 0x3002: [:SOURce]:CURRent:LIMit:PEAK:LOW	203
Object 0x3004: [:SOURce]:CURRent:LIMit:RMS[:AMPLitude]	204
Object 0x3003: [:SOURce]:CURRent:LIMit:PEAK:MODE	205
Object 0x3005: [:SOURce]:CURRent:LIMit:RMS:MODE	205
Object 0x3006: [:SOURce]:FREQuency:LIMit:HIGH.....	206
Object 0x3007: [:SOURce]:FREQuency:LIMit:LOW	206
Object 0x3008: [:SOURce]:FREQuency[:IMMEDIATE]	207
Object 0x3009: [:SOURce]:FUNctIon[:SHAPE][:IMMEDIATE]	207
Object 0x300A: [:SOURce]:FUNctIon:THD:FORMat	209
Object 0x300B: [:SOURce]:LINE:VOLTag[:LEVel][:IMMEDIATE][:AMPLitude]	210
Object 0x300C: [:SOURce]:LINE:VOLTag[:LEVel][:IMMEDIATE]:OFFSet	211
Object 0x310A: [:SOURce]:MODE.....	212
Object 0x300D: [:SOURce]:PHASe:BALance.....	213
Object 0x300E: [:SOURce]:PHASe:MODE	213
Object 0x300F: [:SOURce]:PHASe:PHASe.....	214
Object 0x3010: [:SOURce]:PHASe:RELock	215
Object 0x3011: [:SOURce]:PHASe:SETChange:STATe	215
Object 0x3013: [:SOURce]:PHASe:START:STATe.....	216
Object 0x3015: [:SOURce]:PHASe:STOP:STATe	217
Object 0x3012: [:SOURce]:PHASe:START[:IMMEDIATE]	217
Object 0x3014: [:SOURce]:PHASe:STOP[:IMMEDIATE]	218
Object 0x3016: [:SOURce]:PHASe:SYNC[:IMMEDIATE].....	219
Object 0x3017: [:SOURce]:READ	219
Object 0x3106: [:SOURce]:VOLTag:e:RANGe	221
Object 0x3107: [:SOURce]:VOLTag:e:RESPonse.....	222
Object 0x3103: [:SOURce]:VOLTag:e:LIMit:RMS.....	223
Object 0x3102: [:SOURce]:VOLTag:e:LIMit:PEAK	224
Object 0x3104: [:SOURce]:VOLTag:e:LIMit:HIGH	224
Object 0x3105: [:SOURce]:VOLTag:e:LIMit:LOW	225
Object 0x3108: [:SOURce]:VOLTag[:LEVel][:IMMEDIATE][:AMPLitude]	226
Object 0x3109: [:SOURce]:VOLTag[:LEVel][:IMMEDIATE]:OFFSet	226

Object 0x3101: [:SOURce]:SQUare:DCYCLE.....227

Object 0x2701: INSTRument:EDIT

Description	Sets or queries instrument edit. It is convenient to use a programmed command to set all phases at the same time. If INST:EDIT ALL has been programmed, it will sent all phases. (Only three-phase four-wire Active)
Index	0x2701
Sub-Index	0x00
Value	0 = EACH Each phase 1 = ALL All phase
Type	Unsigned8
Data size	1 Byte
Access	rw
Example (SDO)	23 01 27 00 01 00 00 00 (:INST:EDIT ALL) Sets instrument edit all phase.

Object 0x2702: INSTrument:SElect

Description	Sets or queries the phase to set continuous mode. This command affects the setting of the measurement phase. If INST: EDIT ALL has been programmed, all remote operation commands will send to all output phases. (For single-phase, only L1 can be set. For singlephase three-wire, L1and L2 can be set.)
Index	0x2702
Sub-Index	0x00
Value	From 0 ~ 2, which represent different phase to set sequence, respectively. 0 = L1 L1 phase 1 = L2 L2 phase 2 = L3 L3 phase
Type	Unsigned8
Data size	1 Byte
Access	rw
Example (SDO)	23 02 27 00 01 00 00 00 (:INST:SEL L2) Sets the L2 phase to set continuous mode.

Object 0x3001: [:SOURce]:CURRent:LIMit:PEAK:HIGH

Description	Sets or queries the Ipk-High Limit parameter forthe continuous operation mode.
Index	0x3001

Sub-Index	0x00
Value	Ipk-High Limit in Arms. (Set Value = Value * 100)
Type	Unsigned32
Data size	4 Bytes
Access	rw
Example (SDO)	40 01 30 00 00 00 00 00 (CURR:LIM:PEAK:HIGH?) Return data is 4200 (42.00) 43 01 30 00 68 10 00 00 Returns the peak current high limit as +42.0 A.

Object 0x3002: [:SOURce]:CURRent:LIMit:PEAK:LOW

Description	Sets or queries the Ipk-Low Limit parameter for the continuous operation mode.
Index	0x3002
Sub-Index	0x00
Value	Ipk-Low Limit in Arms. (Set Value = Value * 100)
Type	Signed32
Data size	4 Bytes
Access	rw
Example (SDO)	40 02 30 00 00 00 00 00 (:CURR:LIM:PEAK:LOW?)

Return data is -4200 (-42.00)

43 02 30 00 98 EF FF FF

Returns the peak current low limit as -42.0 A.

Object 0x3004: [:SOURce]:CURRent:LIMit:RMS[:AMPLitude]

Description	Sets or queries the Irms parameter for the continuous operation mode.
Index	0x3004
Sub-Index	0x00
Value	Irms in A. (Set Value = Value * 100)
Type	Unsigned32
Data size	4 Bytes
Access	rw
Example (SDO)	40 04 30 00 00 00 00 00 (:CURR:LIM:RMS?) Return data is 1050 (10.50) 43 04 30 00 1A 04 00 00 Returns the Irms setting.

Object 0x3003: [:SOURce]:CURRent:LIMit:PEAK:MODE

Description	Sets or queries Ipk limit enabled or disabled.	
Index	0x3003	
Sub-Index	0x00	
Value	0 = OFF	Ipk limit off
	1 = ON	Ipk limit on
Type	Unsigned8	
Data size	1 Byte	
Access	rw	
Example (SDO)	23 03 30 00 01 00 00 00 (:CURR:LIM:PEAK:MODE ON)	
	Sets Ipk limit enabled.	

Object 0x3005: [:SOURce]:CURRent:LIMit:RMS:MODE

Description	Sets or queries IRMS limit status.	
Index	0x3005	
Sub-Index	0x00	
Value	0 = OFF	IRMS limit off
	1 = ON	IRMS limit on
Type	Unsigned8	
Data size	1 Byte	
Access	rw	
Example (SDO)	23 05 30 00 01 00 00 00 (:CURR:LIM:RMS:MODE ON)	

Sets IRMS limit enabled.

Object 0x3006: [:SOURce]:FREQuency:LIMit:HIGH

Description	Sets or queries the frequency upper limit range. (Only AC+DC-INT or AC-INT or AC+DC-ADD or AC-ADD or AC-VCA Active)
Index	0x3006
Sub-Index	0x00
Value	Frequency in Hz. (Set Value = Value * 100)
Type	Unsigned32
Data size	4 Bytes
Access	rw
Example (SDO)	40 06 30 00 00 00 00 00 (FREQ:LIM:HIGH?) Return data is 99990 (999.90) 43 06 30 00 96 86 01 00 Returns the frequency upper limit.

Object 0x3007: [:SOURce]:FREQuency:LIMit:LOW

Description	Sets or queries the frequency lower limit range. (Only AC+DC-INT or AC-INT or AC+DC-ADD or AC-ADD or AC-VCA Active)
Index	0x3007
Sub-Index	0x00
Value	Frequency in Hz. (Set Value = Value * 100)

Type	Unsigned32
Data size	4 Bytes
Access	rw
Example (SDO)	40 07 30 00 00 00 00 00 (FREQ:LIM:LOW?) Return data is 100 (1.00) 43 07 30 00 64 00 00 00 Returns the frequency lower limit.

Object 0x3008: [:SOURce]:FREQuency[:IMMediate]

Description	Sets or queries the frequency for the immediate trigger. (Only AC+DC-INT or AC-INT or AC+DC- ADD or AC-ADD or AC-VCA Active)
Index	0x3008
Sub-Index	0x00
Value	Frequency setting in Hz. (Set Value = Value * 100)
Type	Unsigned32
Data size	4 Bytes
Access	rw
Example (SDO)	23 08 30 00 70 17 00 00 (:FREQ 60) Sets the frequency of 60Hz.

Object 0x3009: [:SOURce]:FUNCTion[:SHAPe][:IMMediate]

Description	Sets or queries the waveforms of power supply. (Not available for DC-INT,
-------------	---------------------------------------------------------------------------

AC+DC-EXT and AC-EXT)	
Index	0x3009
Sub-Index	0x00
Value	0 = ARB1 Arbitrary wave 1 1 = ARB2 Arbitrary wave 2 2 = ARB3 Arbitrary wave 3 3 = ARB4 Arbitrary wave 4 4 = ARB5 Arbitrary wave 5 5 = ARB6 Arbitrary wave 6 6 = ARB7 Arbitrary wave 7 7 = ARB8 Arbitrary wave 8 8 = ARB9 Arbitrary wave 9 9 = ARB10 Arbitrary wave 10 10 = ARB11 Arbitrary wave 11 11 = ARB12 Arbitrary wave 12 12 = ARB13 Arbitrary wave 13 13 = ARB14 Arbitrary wave 14 14 = ARB15 Arbitrary wave 15 15 = ARB16 Arbitrary wave 16 16 = SIN Sin wave 17 = SQU Square wave 18 = TRI Triangle wave
Type	Unsigned8
Data size	1 Byte
Access	rw
Example (SDO)	40 09 30 00 00 00 00 00 (:SOUR:FUNC:SHAP:IMM?)
Return data is 18 (TRI)	

43 09 30 00 12 00 00 00

Returns the waveform as Triangle wave.

Object 0x300A: [:SOURce]:FUNctIon:THD:FORMat

Description	Sets or queries the THD format.	
Index	0x300A	
Sub-Index	0x00	
Value	0 = IEC	IEC THD format
	1 = CSA	CSA THD format
Type	Unsigned8	
Data size	1 Byte	
Access	rw	
Example (SDO)	40 0A 30 00 00 00 00 00 (:SOUR:FUNC:THD:FORM?)	

Return data is 0 (IEC)

43 0A 30 00 00 00 00 00

Returns the THD format as IEC.

Object 0x300B:

[:SOURce]:LINE:VOLTage[:LEVel][:IMMediate][:AMPLitude]

Description	Sets or queries the RMS line voltage for the continuous operation mode. (Not available in phase mode unbalance and DC-INT, AC+DC-EXT, AC-EXT , AC+DC-ADD, AC-ADD and AC-VCA)
Index	0x300B
Sub-Index	0x00
Value	Vrms. (Set Value = Value * 100)
Type	Unsigned32
Data size	4 Bytes
Access	rw
Example (SDO)	23 0B 30 00 98 3A 00 00 (:LINE:VOLT 150.0) Sets the line voltage to 150.0 ACV.

Object 0x300C:

[[:SOURce]:LINE:VOLTage[:LEVel]][:IMMEDIATE]:OFFSet

Description	Sets or queries the line voltage offset value. (Not available in phase mode unbalance and only AC+DC-INT or AC+DC-Sync Active)
Index	0x300C
Sub-Index	0x00
Value	Voltage offset value (Set Value = Value * 100)
Type	Signed32
Data size	4 Bytes
Access	rw
Example (SDO)	23 0C 30 00 98 3A 00 00 (:LINE:VOLT:OFFS) Sets the line voltage offset value to 150.0 DCV.

Object 0x310A: [:SOURce]:MODE

Description	Sets or queries the output mode of power supply.
Index	0x310A
Sub-Index	0x00
Value	From 0 - 9, which represent different output modes, respectively. 0 = AC+DC-INT 1 = AC-INT 2 = DC-INT 3 = AC+DC-EXT 4 = AC-EXT 5 = AC+DC-ADD 6 = AC-ADD 7 = AC+DC-SYNC 8 = AC-SYNC 9 = AC-VCA
Type	Unsigned8
Data size	1 Byte
Access	rw
Example	40 0A 31 00 00 00 00 00 (MODE?) (SDO) Return data is 0 (ACDC-INT) 43 0A 31 00 00 00 00 00 Returns the output mode as AC+DC-INT.

Object 0x300D: [:SOURce]:PHASe:BALance

Description	Sets or queries the balance setting phase or line. (Only phase mode is balance Active)	
Index	0x300D	
Sub-Index	0x00	
Value	0 = PHASe	Phase setting
	1 = LINE	Line setting
Type	Unsigned8	
Data size	1 Byte	
Access	rw	
Example	40 0D 30 00 00 00 00 00 (:PHAS:BAL?) (SDO)	
	Return data is 1 (LINE)	
	43 0D 30 00 01 00 00 00	
	Returns the balance setting as LINE.	

Object 0x300E: [:SOURce]:PHASe:MODE

Description	Sets or queries the balance mode. (Only three-phase four-wire or single-phase three-wire Active)	
Index	0x300E	
Sub-Index	0x00	
Value	0 = Unbalance	
	1 = Balance	
Type	Unsigned8	
Data size	1 Byte	
Access	rw	

Example 40 0E 30 00 00 00 00 00 (:PHAS:MODE?)
(SDO)

Return data is 1 (Balance)

43 0E 30 00 01 00 00 00

Returns the phase mode as Balance.

Object 0x300F: [:SOURce]:PHASe:PHASe

Description Sets or queries the target and phase angle parameter. (For three-phase four-wire, L12 and L13 can be set. For single-phase three-wire, L12 can be set.)

Index 0x300F

Sub-Index 0x00 (Phase angle between L1-L2)

Value 0° ~ 359.9°
(Set Value = Value * 10)

Type Unsigned16

Data size 2 Bytes

Access rw

Sub-Index 0x01 (Phase angle between L1-L3)

Value 0° ~ 359.9°
(Set Value = Value * 10)

Type Unsigned16

Data size 2 Bytes

Access rw

Example 40 0F 30 00 00 00 00 00 (:PHAS:PHAS? L12)
(SDO)

Return data is 1200 (120.0)

43 0F 30 00 B0 04 00 00

Returns the Phase angle 120.0 between L1-L2.

Object 0x3010: [:SOURce]:PHASe:RELock

Description	Sets or queries the relock function in three-phase mode.	
Index	0x3010	
Sub-Index	0x00	
Value	0 = OFF	Phase relock off
	1 = ON	Phase relock on
Type	Unsigned8	
Data size	1 Byte	
Access	rw	
Example	23 10 30 00 01 00 00 00 (:PHAS:REL ON) (SDO)	
	Sets Phase relock enabled.	

Object 0x3011: [:SOURce]:PHASe:SETChange:STATe

Description	Sets or queries the set change phase state.	
Index	0x3011	
Sub-Index	0x00	
Value	0 = OFF	Set change phase off
	1 = ON	Set change phase on
Type	Unsigned8	
Data size	1 Byte	
Access	rw	
Example	23 11 30 00 01 00 00 00 (:PHAS:SETC:STAT	

(SDO) ON)

Sets change phase enabled.

Object 0x3013: [:SOURce]:PHASe:STARt:STATe

Description	Sets or queries state of start phase. (Not available for DC-INT, AC+DC-EXT and AC-EXT)	
Index	0x3013	
Sub-Index	0x00	
Value	0 = FREE	Start phase Free
	1 = FIXED	Start phase Fixed
Type	Unsigned8	
Data size	1 Byte	
Access	rw	
Example (SDO)	40 13 30 00 00 00 00 00 (:PHAS:STAR:STAT?)	
	Return data is 0 (FREE)	
	43 13 30 00 00 00 00 00	
	Returns the state of start phase as Free.	

Object 0x3015: [:SOURce]:PHASe:STOP:STATe

Description	Sets or queries state of stop phase. (Not available for DC-INT, AC+DC-EXT and AC-EXT)	
Index	0x3015	
Sub-Index	0x00	
Value	0 = FREE	Stop phase Free
	1 = FIXED	Stop phase Fixed
Type	Unsigned8	
Data size	1 Byte	
Access	rw	
Example (SDO)	40 15 30 00 00 00 00 00 (:PHAS:STOP:STAT?)	
	Return data is 0 (FIXED)	
	43 15 30 00 01 00 00 00	
	Returns the state of stop phase as Fixed.	

Object 0x3012: [:SOURce]:PHASe:START[:IMMEDIATE]

Description	Sets or queries the start phase. (Not available for DC-INT, AC+DC-EXT and AC-EXT)	
Index	0x3012	
Sub-Index	0x00	
Value	Start phase value $0^{\circ} \sim 359.9^{\circ}$ (Set Value = Value * 10)	
Type	Unsigned16	
Data size	2 Bytes	

Access	rw
Example (SDO)	23 12 30 00 00 00 00 00 (:PHAS:STAR 0)
	Sets the starting phase to 0.

Object 0x3014: [:SOURce]:PHASe:STOP[:IMMediate]

Description	Sets or queries the off phase of the waveform. (Notavailable for DC-INT, AC+DC-EXT and AC-EXT)
Index	0x3014
Sub-Index	0x00
Value	Stop phase value 0° ~ 359.9° (Set Value = Value * 10)
Type	Unsigned16
Data size	2 Bytes
Access	rw
Note	Sets the off phase of the waveform after the output has been turned off.
Example (SDO)	23 14 30 00 58 02 00 00 (:PHAS:STOP 60)
	Sets the stop phase to 60.

Object 0x3016: [:SOURce]:PHASe:SYNC[:IMMEDIATE]

Description	Sets or queries the sync delay phase. (Only AC+DC-sync or AC-sync Active)
Index	0x3016
Sub-Index	0x00
Value	Sync delay phase value $0^{\circ} \sim 359.9^{\circ}$ (Set Value = Value * 10)
Type	Unsigned16
Data size	2 Bytes
Access	rw
Example	23 16 30 00 00 00 00 00 (:PHAS:SYNC 0) (SDO)
	Sets the sync delay phase to 0.

Object 0x3017: [:SOURce]:READ

Description	Returns the measurement readouts.
Index	0x3017
Sub-Index	0x00 = L1 Vrms 0x01 = L1 Vavg 0x02 = L1 Vmax 0x03 = L1 Vmin 0x04 = L1 Vpkh 0x05 = L1 Irms 0x06 = L1 Iavg 0x07 = L1 Imax 0x08 = L1 Imin 0x09 = L1 Ipkh 0x0A = L1 P

0x0B = L1 S (Invalid in DC-INT mode.)
0x0C = L1 Q (Invalid in DC-INT mode.)
0x0D = L1 PF (Invalid in DC-INT mode.)
0x0E = L1 CF (Invalid in DC-INT mode.)
0x0F = L1 THD_v (AC-INT mode only) / L1
Freq (AC+DC-Sync and AC-Sync modes only)
0x10 = L1 THD_i (AC-INT mode only)
0x11 = L2 V_{rms}
0x12 = L2 V_{avg}
0x13 = L2 V_{max}
0x14 = L2 V_{min}
0x15 = L2 V_{pkh}
0x16 = L2 I_{rms}
0x17 = L2 I_{avg}
0x18 = L2 I_{max}
0x19 = L2 I_{min}
0x1A = L2 I_{pkh}
0x1B = L2 P
0x1C = L2 S (Invalid in DC-INT mode.)
0x1D = L2 Q (Invalid in DC-INT mode.)
0x1E = L2 PF (Invalid in DC-INT mode.)
0x1F = L2 CF (Invalid in DC-INT mode.)
0x20 = L2 THD_v (AC-INT mode only) / L2
Freq (AC+DC-Sync and AC-Sync modes only)
0x21 = L2 THD_i (AC-INT mode only)
0x22 = L3 V_{rms}
0x23 = L3 V_{avg}
0x24 = L3 V_{max}
0x25 = L3 V_{min}
0x26 = L3 V_{pkh}

0x27 = L3 Irms
 0x28 = L3 Iavg
 0x29 = L3 Imax
 0x2A = L3 Imin
 0x2B = L3 Ipkh
 0x2C = L3 P
 0x2D = L3 S (Invalid in DC-INT mode.)
 0x2E = L3 Q (Invalid in DC-INT mode.)
 0x2F = L3 PF (Invalid in DC-INT mode.)
 0x30 = L3 CF (Invalid in DC-INT mode.)
 0x31 = L3 THDv (AC-INT mode only) / L3
 Freq (AC+DC-Sync and AC-Sync modes only)
 0x32 = L3 THDi (AC-INT mode only)

Type	Signed32
Data size	4 Bytes
Access	ro

Object 0x3106: [:SOURce]:VOLTage:RANGe

Description	Sets or queries the voltage range.
Index	0x3106
Sub-Index	0x00
Value	From 0 - 2, which represent different voltage ranges, respectively. 0 = 100V 1 = 200V 2 = AUTO (Only AC+DC-INT or AC-INT or DC-INT or AC+DC-sync or AC-sync Active)
Type	Unsigned8

Data size	1 Byte
Access	rw
Example (SDO)	40 06 31 00 00 00 00 00 (:SOUR:VOLT:RANG?)
	Return data is 1 (200V) 43 06 31 00 01 00 00 00
	Returns the voltage range as 200V.

Object 0x3107: [:SOURce]:VOLTage:RESPonse

Description	Sets or queries the voltage response. (Fast not available for single-phase or output impedance set to on.)
Index	0x3107
Sub-Index	0x00
Value	From 0 - 2, which represent different voltage response ,respectively. 0 = SLOW Voltage response slow. 1 = MEDium Voltage response medium. 2 = FAST Voltage response fast.
Type	Unsigned8
Data size	1 Byte
Access	rw
Example (SDO)	40 07 31 00 00 00 00 00 (:VOLT:RESP?)
	Return data is 1 (Medium) 43 07 31 00 01 00 00 00

Returns the voltage response as medium.

Object 0x3103: [:SOURce]:VOLTage:LIMit:RMS

Description	Sets or queries the voltage limit for the continuous operation mode. (Only AC-INT or AC-ADD or AC-Sync Active)
Index	0x3103
Sub-Index	0x00
Value	Vrms. (Set Value = Value * 100)
Type	Unsigned32
Data size	4 Bytes
Access	rw
Example (SDO)	40 03 31 00 00 00 00 00 (VOLT:LIM:RMS?) Return data is 35000 (350.00) 43 03 31 00 B8 88 00 00 Returns the Vrms limit.

Object 0x3102: [:SOURce]:VOLTage:LIMit:PEAK

Description	Sets or Queries the Value of Vpp in Specific Mode(AC-INT or AC-ADD or AC-Sync) and Specific Wave Shape(TRI or ARB) and Specific V Unit(p-p)
Index	0x3102
Sub-Index	0x00
Value	Vpp (Set Value = Value * 100)
Type	Unsigned32
Data size	4 Bytes
Access	rw
Example (SDO)	40 02 31 00 00 00 00 00 (VOLT:LIM:PEAK?) Return data is 50000 (500.00) 43 02 31 00 50 C3 00 00 Returns the Vpp limit.

Object 0x3104: [:SOURce]:VOLTage:LIMit:HIGH

Description	Sets or queries the voltage high limit. (Only AC+DC-INT or DC-INT or AC+DC-ADD or AC+DC-Sync Active)
Index	0x3104
Sub-Index	0x00
Value	Voltage high limit (Set Value = Value * 100)
Type	Unsigned32

Data size	4 Bytes
Access	rw
Example (SDO)	40 04 31 00 00 00 00 00 (VOLT:LIM:HIGH?) Return data is 50000 (500.00) 43 04 31 00 50 C3 00 00 Returns the voltage high limit.

Object 0x3105: [:SOURce]:VOLTage:LIMit:LOW

Description	Sets or queries the voltage low limit. (Only AC+DC-INT or DC-INT or AC+DC-ADD or AC+DC-Sync Active)
Index	0x3105
Sub-Index	0x00
Value	Voltage low limit (Set Value = Value * 100)
Type	Signed32
Data size	4 Bytes
Access	rw
Example (SDO)	40 05 31 00 00 00 00 00 (VOLT:LIM:LOW?) Return data is -50000 (-500.00) 43 05 31 00 B0 3C FF FF Returns the voltage low limit.

Object 0x3108:

[:SOURce]:VOLTage[:LEVel][:IMMediate][:AMPLitude]

Description	Sets or queries the RMS voltage for the continuous operation mode. (Not available for DC-INT, AC+DC-EXT, AC-EXT and AC-VCA)
Index	0x3108
Sub-Index	0x00
Value	Vrms. (Set Value = Value * 100)
Type	Unsigned32
Data size	4 Bytes
Access	rw
Example (SDO)	23 08 31 00 98 3A 00 00 (:VOLT 150.0) Sets the voltage to 150.0 ACV.

Object 0x3109:

[:SOURce]:VOLTage[:LEVel][:IMMediate]:OFFSet

Description	Sets or queries the voltage offset value. (Only AC+DC-INT or DC-INT or AC+DC-ADD or AC+DC-Sync Active)
Index	0x3109
Sub-Index	0x00
Value	Voltage offset value (Set Value = Value * 100)
Type	Signed32
Data size	4 Bytes

Access	rw
Example (SDO)	40 09 31 00 00 00 00 00 (:VOLT:OFFS?) Return data is 15000 (150.00) 43 09 31 00 98 3A 00 00 Returns the voltage offset value as 150.0.

Object 0x3101: [:SOURce]:SQUare:DCYcle

Description	Sets or queries the square wave signal duty cycle. The settable range depends on the frequency. Not available for DC-INT, AC+DC-EXT and ACEXT)
Index	0x3101
Sub-Index	0x00
Value	Square wave signal duty cycle. (Set Value = Value * 10)
Type	Unsigned16
Data size	2 Bytes
Access	rw
Example (SDO)	40 01 31 00 00 00 00 00 (:SQU:DCYC?) Return data is 500 (50.0) 43 01 31 00 F4 01 00 00 Returns the square wave signal duty cycle as 50.0%.

Sequence Commands

Object 0x3031: [:SOURce]:SEQuence:CPARAmeter.....	228
Object 0x3032: [:SOURce]:SEQuence:CSTep.....	231
Object 0x3033: [:SOURce]:SEQuence:INSTrument:SELect.....	232
Object 0x3034: [:SOURce]:SEQuence:SPARAmeter.....	233
Object 0x3035: [:SOURce]:SEQuence:STEP.....	235
Object 0x3030: [:SOURce]:SEQuence:CONDition.....	236
Object 0x2E05: TRIGger:SEQuence:SELected:EXECute.....	237
Object 0x3060: [:SOURce]:SEQuence:NSParameter.....	237

Object 0x3031: [:SOURce]:SEQuence:CPARAmeter

Description	Sets the common parameters for the Sequence mode. Please see the user manual for a full description of each parameter. (Only SequenceMode Active)
Index	0x3031
Sub-Index	0x00 (Step Time)
Value	0.0001 ~ 999.9999 (Set Value = Value * 10000)
Type	Unsigned32
Data size	4 Bytes
Access	rw
Sub-Index	0x01 (On phase)
Value	0.0 ~ 359.9 (Set Value = Value * 10)
Type	Unsigned16
Data size	2 Bytes
Access	rw
Sub-Index	0x02 (On Phase fixed/ free)

Value	1 = on (fixed) 0 = off (free)
Type	Unsigned8
Data size	1 Byte
Access	rw
Sub-Index	0x03 (Off phase)
Value	0.0 ~ 359.9 (Set Value = Value * 10)
Type	Unsigned16
Data size	2 Bytes
Access	rw
Sub-Index	0x04 (Off Phase fixed/ free)
Value	1 = on (fixed) 0 = off (free)
Type	Unsigned8
Data size	1 Byte
Access	rw
Sub-Index	0x05 (Term)
Value	0 = Continue 1 = End 2 = Hold
Type	Unsigned8
Data size	1 Byte
Access	rw
Sub-Index	0x06 (Jump step number)
Value	0 ~ 999
Type	Unsigned16

Data size	2 Bytes
Access	rw
Sub-Index	0x07 (Jump To)
Value	1 = on 0 = off
Type	Unsigned8
Data size	1 Byte
Access	rw
Sub-Index	0x08 (Jump Cnt)
Value	0~ 9999
Type	Unsigned16
Data size	2 Bytes
Access	rw
Sub-Index	0x09 (Sync Code)
Value	0 = LL 1 = LH 2 = HL 3 = HH
Type	Unsigned8
Data size	1 Byte
Access	rw
Sub-Index	0x0A (Branch1)
Value	0 ~ 999
Type	Unsigned16
Data size	2 Bytes
Access	rw
Sub-Index	0x0B (Branch1 on/off)
Value	1 = on

	0 = off
Type	Unsigned8
Data size	1 Byte
Access	rw
Sub-Index	0x0C (Branch2)
Value	0 ~ 999
Type	Unsigned16
Data size	2 Bytes
Access	rw
Sub-Index	0x0D (Branch2 on/off)
Value	1 = on 0 = off
Type	Unsigned8
Data size	1 Byte
Access	rw
Sub-Index	0x0E (Reserved)
Value	-
Type	Unsigned8
Data size	1 Byte
Access	rw

Object 0x3032: [:SOURce]:SEQuence:CSTep

Description	Returns the currently running step number. (OnlySequence Mode Active)
Index	0x3032
Sub-Index	0x00
Value	Current step number

Type	Unsigned16
Data size	2 Bytes
Access	ro
Example (SDO)	40 32 30 00 00 00 00 00 (:SEQ:CSTep?) Return data is 1 43 32 30 00 01 00 00 00 Returns the Current step number as 1.

Object 0x3033: [:SOURce]:SEQuence:INSTrument:SElect

Description	Sets or queries the phase to set sequence. (Only Sequence Mode Active. For single-phase and single-phase three-wire, only L1 can be set.)
Index	0x3033
Sub-Index	0x00
Value	From 0 ~ 2, which represent different phase to set sequence, respectively. 0 = L1 L1 phase 1 = L2 L2 phase 2 = L3 L3 phase
Type	Unsigned8
Data size	1 Byte
Access	rw
Example (SDO)	23 33 30 00 01 00 00 00 (:SEQ:INST:SEL L2) Sets the L2 phase to set sequence.

Object 0x3034: [:SOURce]:SEQuence:SPARAmeter

Description	Sets or queries the parameters for a specified step. (Only Sequence Mode Active)
Index	0x3034
Sub-Index	0x00 (ACV setting)
Value	ACV (Set Value = Value * 100)
Type	Unsigned32
Data size	4 Bytes
Access	rw
Sub-Index	0x01 (ACV mode)
Value	0 = Constant 1 = Keep 2 = Sweep
Type	Unsigned8
Data size	1 Byte
Access	rw
Sub-Index	0x02 (DCV. Not applicable. This parameter will be ignored.)
Value	DCV (Set Value = Value * 100)
Type	Signed32
Data size	4 Bytes
Access	rw
Sub-Index	0x03 (DCV mode)
Value	0 = Constant 1 = Keep 2 = Sweep

Type	Unsigned8	
Data size	1 Byte	
Access	rw	
Sub-Index	0x04 (Frequency)	
Value	1.00 ~ 2000.0 (Set Value = Value * 100)	
Type	Unsigned32	
Data size	4 Bytes	
Access	rw	
Sub-Index	0x05 (Frequency mode)	
Value	0 = Constant 1 = Keep 2 = Sweep	
Type	Unsigned8	
Data size	1 Byte	
Access	rw	
Sub-Index	0x06 (Waveform)	
Value	0 = ARB1	Arbitrary wave 1
	1 = ARB2	Arbitrary wave 2
	2 = ARB3	Arbitrary wave 3
	3 = ARB4	Arbitrary wave 4
	4 = ARB5	Arbitrary wave 5
	5 = ARB6	Arbitrary wave 6
	6 = ARB7	Arbitrary wave 7
	7 = ARB8	Arbitrary wave 8
	8 = ARB9	Arbitrary wave 9
	9 = ARB10	Arbitrary wave 10
	10 = ARB11	Arbitrary wave 11
	11 = ARB12	Arbitrary wave 12
	12 = ARB13	Arbitrary wave 13
	13 = ARB14	Arbitrary wave 14
	14 = ARB15	Arbitrary wave 15
	15 = ARB16	Arbitrary wave 16
	16 = SIN	Sin wave
	17 = SQU	Square wave

	18 = TRI	Triangle wave
Type	Unsigned8	
Data size	1 Byte	
Access	rw	
Sub-Index	0x08 (Phase angle)	
Value	Phase angle. (L1 phase Fixed to 0.) 0 ~ 359.9 (Set Value = Value * 10)	
Type	Unsigned16	
Data size	2 Bytes	
Access	rw	

Object 0x3035: [:SOURce]:SEQuence:STEP

Description	Sets or queries the current step number. (OnlySequence Mode Active)	
Index	0x3035	
Sub-Index	0x00	
Value	Step number	
Type	Unsigned16	
Data size	2 Bytes	
Access	rw	
Example	23 35 30 00 01 00 00 00 (:SEQ:STEP 1)	
(SDO)	Sets the step number to 1.	

Object 0x3030: [:SOURce]:SEQUence:CONDition

Description	Returns the sequence status.(Only Sequence Mode Active)
Index	0x3030
Sub-Index	0x00
Value	Current sequence status 0 = Idle mode 1 = Run mode 2 = Hold mode
Type	Unsigned8
Data size	1 Byte
Access	ro
Example (SDO)	40 30 30 00 00 00 00 00 (:SEQ:COND?) Return data is 1 (Run mode) 43 30 30 00 01 00 00 00 Returns the Current sequence status as 1.

Object 0x2E05: TRIGger:SEQuence:SELEcted:EXECute

Description	Sets to execute actions for sequence mode. (Only Sequence Mode Active)	
Index	0x3035	
Sub-Index	0x00	
Value	0 = STOP	Stops sequence execution
	1 = START	Starts sequence execution
	2 = HOLD	Holds sequence execution
	3 = BRAN1	Jumps to Branch 1 execution
	4 = BRAN2	Jumps to Branch 2 execution
Type	Unsigned8	
Data size	1 Byte	
Access	rw	
Example (SDO)	23 05 2E 00 01 00 00 00 (TRIG:SEQ:SEL:EXEC STAR) Starts sequence execution.	

Object 0x3060: [:SOURce]:SEQuence:NSParameter

Description	Sets or queries the parameters for a specified step. (Only Sequence Mode Active)	
Index	0x3060	
Sub-Index	0x00 (ACV setting)	
Value	ACV (Set Value = Value * 100)	
Type	Unsigned32	
Data size	4 Bytes	

Access	rw
Sub-Index	0x01 (ACV mode)
Value	0 = Constant 1 = Keep 2 = Sweep
Type	Unsigned8
Data size	1 Byte
Access	rw
Sub-Index	0x02 (DCV. Not applicable. This parameter will be ignored.)
Value	DCV (Set Value = Value * 100)
Type	Signed32
Data size	4 Bytes
Access	rw
Sub-Index	0x03 (DCV mode)
Value	0 = Constant 1 = Keep 2 = Sweep
Type	Unsigned8
Data size	1 Byte
Access	rw
Sub-Index	0x04 (Frequency)
Value	1.00 ~ 2000.0 (Set Value = Value * 100)
Type	Unsigned32
Data size	4 Bytes
Access	rw
Sub-Index	0x05 (Frequency mode)
Value	0 = Constant

	1 = Keep
	2 = Sweep
Type	Unsigned8
Data size	1 Byte
Access	rw
Sub-Index	0x06 (Waveform)
Value	0 = ARB1 Arbitrary wave 1 1 = ARB2 Arbitrary wave 2 2 = ARB3 Arbitrary wave 3 3 = ARB4 Arbitrary wave 4 4 = ARB5 Arbitrary wave 5 5 = ARB6 Arbitrary wave 6 6 = ARB7 Arbitrary wave 7 7 = ARB8 Arbitrary wave 8 8 = ARB9 Arbitrary wave 9 9 = ARB10 Arbitrary wave 10 10 = ARB11 Arbitrary wave 11 11 = ARB12 Arbitrary wave 12 12 = ARB13 Arbitrary wave 13 13 = ARB14 Arbitrary wave 14 14 = ARB15 Arbitrary wave 15 15 = ARB16 Arbitrary wave 16 16 = SIN Sin wave 17 = SQU Square wave 18 = TRI Triangle wave
Type	Unsigned8
Data size	1 Byte
Access	rw
Sub-Index	0x07 (Duty)
Value	Square wave signal duty cycle. (Set Value = Value * 10)
Type	Unsigned16
Data size	2 Bytes
Access	rw
Sub-Index	0x08 (Phase angle)

Value	Phase angle. (L1 phase Fixed to 0.) 0 ~ 359.9 (Set Value = Value * 10)
Type	Unsigned16
Data size	2 Bytes
Access	rw

Simulate Commands

Object 0x3036: [:SOURce]:SIMulation:CONDition	242
Object 0x3037: [:SOURce]:SIMulation:ABNormal:CODE	243
Object 0x3038: [:SOURce]:SIMulation:ABNormal:FREQuency	243
Object 0x3039:	
[:SOURce]:SIMulation:ABNormal:PHASe:STARt:ENABle	244
Object 0x303A:	
[:SOURce]:SIMulation:ABNormal:PHASe:STARt[:IMMediate]	245
Object 0x303B [:SOURce]:SIMulation:ABNormal:PHASe:STOP:ENABle	245
Object 0x303C:	
[:SOURce]:SIMulation:ABNormal:PHASe:STOP[:IMMediate]	246
Object 0x303D: [:SOURce]:SIMulation:ABNormal:TIME	247
Object 0x303E: [:SOURce]:SIMulation:ABNormal:VOLTagE	247
Object 0x303F: [:SOURce]:SIMulation:CSTep	248
Object 0x3040: [:SOURce]:SIMulation:INITial:CODE	249
Object 0x3041: [:SOURce]:SIMulation:INITial:FREQuency	250
Object 0x3042: [:SOURce]:SIMulation:INITial:PHASe:STARt:ENABle	250
Object 0x3043:	
[:SOURce]:SIMulation:INITial:PHASe:STARt[:IMMediate]	251
Object 0x3044: [:SOURce]:SIMulation:INITial:PHASe:STOP:ENABle	252
Object 0x3045:	
[:SOURce]:SIMulation:INITial:PHASe:STOP[:IMMediate]	252
Object 0x3046: [:SOURce]:SIMulation:INITial:VOLTagE	253
Object 0x3048: [:SOURce]:SIMulation:NORMal<1 2>:CODE	254
Object 0x3049: [:SOURce]:SIMulation:NORMal 1:FREQuency	255
Object 0x304A:	
[:SOURce]:SIMulation:NORMal<1 2>:PHASe:STARt:ENABle	256
Object 0x304B:	
[:SOURce]:SIMulation:NORMal<1 2>:PHASe:STARt[:IMMediate]	257
Object 0x304C:	
[:SOURce]:SIMulation:NORMal<1 2>:PHASe:STOP:ENABle	258
Object 0x304D:	
[:SOURce]:SIMulation:NORMal<1 2>:PHASe:STOP[:IMMediate]	259
Object 0x304E: [:SOURce]:SIMulation:NORMal<1 2>:TIME	260
Object 0x304F: [:SOURce]:SIMulation:NORMal 1:VOLTagE	261
Object 0x3050: [:SOURce]:SIMulation:REPeat:COUNt	262

Object 0x3051: [:SOURce]:SIMulation:REPeat:ENABle 262
 Object 0x3053: [:SOURce]:SIMulation:TRANsition<1 | 2>:TIME 263
 Object 0x3052: [:SOURce]:SIMulation:TRANsition<1 | 2>:CODE 264
 Object 0x2E06: TRIGger:SIMulation:SELEcted:EXECute 265

Object 0x3036: [:SOURce]:SIMulation:CONDition

Description	Returns the simulation status. (Only SimulationMode Active)
Index	0x3036
Sub-Index	0x00
Value	Current simulation status 0 = Idle mode 1 = Run mode 2 = Hold mode
Type	Unsigned8
Data size	1 Byte
Access	ro
Example (SDO)	40 36 30 00 00 00 00 00 (:SIM:COND?) Return data is 1 (Run mode) 43 36 30 00 01 00 00 00 Returns the Current simulation status as 1.

Object 0x3037: [:SOURce]:SIMulation:ABNormal:CODE

Description	Sets the external trigger output for the abnormalstep parameter. This option is only applicable when in the Simulation mode. (Only Simulation Mode Active)
Index	0x3037
Sub-Index	0x00
Value	External trigger output 0 = LL 1 = LH 2 = HL 3 = HH
Type	Unsigned8
Data size	1 Byte
Access	rw
Example (SDO)	23 37 30 00 01 00 00 00 (SIM:ABN:CODE 1) Set the external trigger output to LH

Object 0x3038:

[:SOURce]:SIMulation:ABNormal:FREQuency

Description	Sets or queries the frequency of the abnormal step of the simulation mode. (Only Simulation ModeActive)
Index	0x3038
Sub-Index	0x00
Value	Frequency of abnormal step 1.00 ~ 2000.0 (Set Value = Value * 100)
Type	Unsigned32

Data size	4 Bytes
Access	rw
Example (SDO)	23 38 30 00 7C 15 00 00 (:SIM:ABN:FREQ 55)
	Sets the frequency to 55Hz.

Object 0x3039:

[:SOURce]:SIMulation:ABNormal:PHASe:STARt:ENABle

Description	Enables/Disables (Fixed/Free) the ON Phs parameter of the abnormal step for the Simulation mode. (Only Simulation Mode Active)
Index	0x3039
Sub-Index	0x00
Value	0 = Disabled 1 = Enabled
Type	Unsigned8
Data size	1 Byte
Access	rw
Example (SDO)	23 39 30 00 01 00 00 00 (:SIM:ABN:PHAS:STAR:ENAB 1)
	Enable the ON Phs.

Object 0x303A:

[:SOURce]:SIMulation:ABNormal:PHASe:STAR[:IMMediate]

Description	Sets or queries the ON Phs parameter of the abnormal step for the Simulation mode. (OnlySimulation Mode Active)
Index	0x303A
Sub-Index	0x00
Value	ON Phs (start phase) 0° ~ 359.9° (Set Value = Value * 10)
Type	Unsigned16
Data size	2 Bytes
Access	rw
Example (SDO)	23 3A 30 00 00 00 00 00 (:SIM:ABN:PHAS:STAR 0)
	Sets ON Phs to 0.

Object 0x303B

[:SOURce]:SIMulation:ABNormal:PHASe:STOP:ENABLE

Description	Enables/Disables (Fixed/Free) the OFF Phs parameter of the abnormal step for the Simulation mode. (Only Simulation Mode Active)
Index	0x303B
Sub-Index	0x00
Value	0 = Disabled 1 = Enabled

Type	Unsigned8
Data size	1 Byte
Access	rw
Example (SDO)	23 3B 30 00 01 00 00 00 (:SIM:ABN:PHAS:STOP:ENAB 1)
Enable the OFF Phs.	

Object 0x303C:

[:SOURce]:SIMulation:ABNormal:PHASe:STOP[:IMMediate]

Description	Sets or queries the OFF Phs parameter of the abnormal step for the Simulation mode. (OnlySimulation Mode Active)
Index	0x303A
Sub-Index	0x00
Value	ON Phs (Stop phase) 0° ~ 359.9° (Set Value = Value * 10)
Type	Unsigned16
Data size	2 Bytes
Access	rw
Note	Sets the off phase of the waveform after the output has been turned off.
Example (SDO)	23 3C 30 00 00 00 00 00 (:SIM:ABN:PHAS:STOP 0)
Sets OFF Phs to 0.	

Object 0x303D: [:SOURce]:SIMulation:ABNormal:TIME

Description	Sets or queries the Time parameter of the abnormal step for the Simulation mode. (Only SimulationMode Active)
Index	0x303D
Sub-Index	0x00
Value	Time of the abnormal step in seconds 0.0001 ~ 999.9999 s (Set Value = Value * 10000)
Type	Unsigned32
Data size	4 Bytes
Access	rw
Example (SDO)	23 3D 30 00 10 27 00 00 (:SIM:ABN:TIME 1) Sets the abnormal step time to 1 second.

Object 0x303E: [:SOURce]:SIMulation:ABNormal:VOLTage

Description	Sets or queries the Vset parameter of the abnormalstep for the Simulation mode. (Only Simulation Mode Active)
Index	0x303E
Sub-Index	0x00
Value	Voltage of the abnormal step. (Set Value = Value * 100)
Type	Unsigned32
Data size	4 Bytes
Access	rw
Example (SDO)	23 3E 30 00 10 27 00 00 (:SIM:ABN:VOLT 100)

Sets the abnormal step voltage to the 100.

Object 0x303F: [:SOURce]:SIMulation:CSTep

Description	Returns the currently running step. (Only Simulation Mode Active)
Index	0x303F
Sub-Index	0x00
Value	Current step 0 = Initial step 1 = Normal1 step 2 = Transition1 step 3 = Abnormal step 4 = Transition2 step 5 = Normal2 step
Type	Unsigned8
Data size	1 Byte
Access	rw
Example (SDO)	40 3F 30 00 00 00 00 00 (:SIM:CSTep?) Return data is 1 (Normal1 step) 43 3F 30 00 01 00 00 00 Returns the Current step as Normal1.

Object 0x3040: [:SOURce]:SIMulation:INITial:CODE

Description	Sets the external trigger output for the initial step parameter. This option is only applicable when in the Simulation mode. (Only Simulation Mode Active)
Index	0x3040
Sub-Index	0x00
Value	0 = LL 1 = LH 2 = HL 3 = HH
Type	Unsigned8
Data size	1 Byte
Access	rw
Example (SDO)	23 40 30 00 01 00 00 00 (:SIM:INIT:CODE 1) Sets the initial step code to the LH.

Object 0x3041: [:SOURce]:SIMulation:INITial:FREQuency

Description	Sets the external trigger output for the initial step parameter. This option is only applicable when in the Simulation mode. (Only Simulation Mode Active)
Index	0x3041
Sub-Index	0x00
Value	Frequency of initial step 1.00 ~ 2000.0 (Set Value = Value * 100)
Type	Unsigned32
Data size	4 Bytes
Access	rw
Example (SDO)	23 41 30 00 70 17 00 00 (:SIM:INIT:FREQ 60) Sets the frequency of the initial step to 60Hz.

Object 0x3042:

[:SOURce]:SIMulation:INITial:PHASe:STARt:ENABle

Description	Enables/Disables (Fixed/Free) the ON Phs parameter of the initial step for the Simulation mode. (Only Simulation Mode Active)
Index	0x3042
Sub-Index	0x00
Value	0 = Disabled 1 = Enabled
Type	Unsigned8
Data size	1 Byte

Access	rw
Example (SDO)	23 42 30 00 01 00 00 00 (:SIM:INIT:PHAS:STAR:ENAB 1)
Enable the ON Phs.	

Object 0x3043:

[[:SOURce]:SIMulation:INITial:PHASe:STARt[:IMMediate]

Description	Sets or queries the ON Phs parameter of the initialstep for the Simulation mode. (Only Simulation Mode Active)
Index	0x3043
Sub-Index	0x00
Value	ON Phs (start phase) 0° ~ 359.9° (Set Value = Value * 10)
Type	Unsigned16
Data size	2 Bytes
Access	rw
Note	Sets the off phase of the waveform after the output has been turned off.
Example (SDO)	23 43 30 00 00 00 00 00 (:SIM:INIT:PHAS:STAR 0)
Sets ON Phs to 0.	

Object 0x3044:

[:SOURCE]:SIMulation:INITial:PHASe:STOP:ENABLE

Description	Enables/Disables (Fixed/Free) the OFF Phs parameter of the initial step for the Simulation mode. (Only Simulation Mode Active)
Index	0x3044
Sub-Index	0x00
Value	0 = Disabled 1 = Enabled
Type	Unsigned8
Data size	1 Byte
Access	rw
Example (SDO)	23 44 30 00 01 00 00 00 (:SIM:INIT:PHAS:STOP:ENAB 1)
	Enable the OFF Phs.

Object 0x3045:

[:SOURCE]:SIMulation:INITial:PHASe:STOP[:IMMediate]

Description	Sets or queries the OFF Phs parameter of the initial step for the Simulation mode. (Only Simulation Mode Active)
Index	0x3043
Sub-Index	0x00
Value	OFF Phs (Stop phase) 0° ~ 359.9° (Set Value = Value * 10)

Type	Unsigned16
Data size	2 Bytes
Access	rw
Note	Sets the off phase of the waveform after the output has been turned off.
Example (SDO)	23 45 30 00 00 00 00 00 (:SIM:INIT:PHAS:STOP 0)
	Sets OFF Phs to 0.

Object 0x3046: [:SOURce]:SIMulation:INITial:VOLTage

Description	Sets or queries the Vset parameter of the initial step for the Simulation mode. (Only Simulation Mode Active)
Index	0x3046
Sub-Index	0x00
Value	Voltage of the initial step. (Set Value = Value * 100)
Type	Unsigned32
Data size	4 Bytes
Access	rw
Example (SDO)	23 46 30 00 10 27 00 00 (:SIM:INIT:VOLT 100)
	Sets the initial step voltage to the 100.

Object 0x3048: [:SOURce]:SIMulation:NORMal<1|2>:CODE

Description	Sets the external trigger output for the normal 1 or normal 2 step parameter. This option is only applicable when in the Simulation mode. (Only Simulation Mode Active)
Index	0x3048
Sub-Index	0x00 (Normal 1 Code)
Value	0 = LL 1 = LH 2 = HL 3 = HH
Type	Unsigned8
Data size	1 Byte
Access	rw
Sub-Index	0x01 (Normal 2 Code)
Value	0 = LL 1 = LH 2 = HL 3 = HH
Type	Unsigned8
Data size	1 Byte
Access	rw
Example (SDO)	23 48 30 00 01 00 00 00 (:SIM:NORM1:CODE 1)
	Sets the Normal 1 Code to the LH.

Object 0x3049: [:SOURce]:SIMulation:NORMal

1:FREQUENCY

Description	Sets or queries the frequency of the normal1 step of the simulation mode. (Only Simulation Mode Active)
Index	0x3049
Sub-Index	0x00 (Normal 1 Frequency)
Value	Frequency of abnormal step 1.00 ~ 2000.0 (Set Value = Value * 100)
Type	Unsigned32
Data size	4 Bytes
Access	rw
Sub-Index	0x01 (Normal 2 Frequency)
Value	Frequency of abnormal step 1.00 ~ 2000.0 (Set Value = Value * 100)
Type	Unsigned32
Data size	4 Bytes
Access	rw
Example (SDO)	23 49 30 00 70 17 00 00 (:SIM:NORM1:FREQ 60)
	Sets the Normal 1 Frequency to 60Hz.

Object 0x304A:

[:SOURce]:SIMulation:NORMal<1|2>:PHASe:STARt:ENABle

Description	Enables/Disables (Fixed/Free) the ON Phs parameter of the normal1 or normal2 step for the Simulation mode. (Only Simulation Mode Active)
Index	0x304A
Sub-Index	0x00 (Normal 1)
Value	0 = Disabled 1 = Enabled
Type	Unsigned8
Data size	1 Byte
Access	rw
Sub-Index	0x01 (Normal 2)
Value	0 = Disabled 1 = Enabled
Type	Unsigned8
Data size	1 Byte
Access	rw
Example (SDO)	23 4A 30 00 01 00 00 00 (:SIM:NORM1:PHAS:STAR:ENAB 1)
	Enable the ON Phs.

Object 0x304B:

[[:SOURce]:SIMulation:NORMal<1|2>:PHASe:STARt[:IMMEDIATE]]

Description	Sets or queries the ON Phs parameter of the normal1 or normal2 step for the Simulation mode. (Only Simulation Mode Active)
Index	0x304B
Sub-Index	0x00 (Normal 1 ON Phs (start phase))
Value	0° ~ 359.9° (Set Value = Value * 10)
Type	Unsigned16
Data size	2 Bytes
Access	rw
Sub-Index	0x01 (Normal 2 ON Phs (start phase))
Value	0° ~ 359.9° (Set Value = Value * 10)
Type	Unsigned16
Data size	2 Bytes
Access	rw
Example (SDO)	23 4B 30 00 00 00 00 00 (:SIM:NORM1:PHAS:STAR 0)
	Sets ON Phs to 0.

Object 0x304C:

[:SOURce]:SIMulation:NORMal<1|2>:PHASe:STOP:ENABLE

Description	Enables/Disables (Fixed/Free) the OFF Phs parameter of the normal1 or normal2 step for the Simulation mode. (Only Simulation Mode Active)
Index	0x304C
Sub-Index	0x00 (Normal 1)
Value	0 = Disabled 1 = Enabled
Type	Unsigned8
Data size	1 Byte
Access	rw
Sub-Index	0x01 (Normal 2)
Value	0 = Disabled 1 = Enabled
Type	Unsigned8
Data size	1 Byte
Access	rw
Example (SDO)	23 4C 30 00 01 00 00 00 (:SIM:NORM1:PHAS:STOP:ENAB 1)
	Enable the OFF Phs.

Object 0x304D:

[[:SOURce]:SIMulation:NORMal<1|2>:PHASe:STOP[:IMMEDIATE]]

Description	Sets or queries the OFF Phs parameter of the normal1 or normal2 step for the Simulation mode. (Only Simulation Mode Active)
Index	0x304D
Note	Sets the off phase of the waveform after the output has been turned off.
Sub-Index	0x00 (Normal 1 OFF Phs (Stop phase))
Value	0° ~ 359.9° (Set Value = Value * 10)
Type	Unsigned16
Data size	2 Bytes
Access	rw
Sub-Index	0x01 (Normal 2 OFF Phs (Stop phase))
Value	0° ~ 359.9° (Set Value = Value * 10)
Type	Unsigned16
Data size	2 Bytes
Access	rw
Example (SDO)	23 4D 30 00 00 00 00 00 (:SIM:NORM1:PHAS:STOP 0)
	Sets OFF Phs to 0.

Object 0x304E: [:SOURce]:SIMulation:NORMal<1|2>:TIME

Description	Sets or queries the Time parameter of the normal1 or normal2 step for the Simulation mode. (OnlySimulation Mode Active)
Index	0x304E
Sub-Index	0x00 (Normal 1 Time of the step in seconds)
Value	0.0001 ~ 999.9999 s (Set Value = Value * 10000)
Type	Unsigned32
Data size	4 Bytes
Access	rw
Sub-Index	0x01 (Normal 2 Time of the step in seconds)
Value	0.0001 ~ 999.9999 s (Set Value = Value * 10000)
Type	Unsigned32
Data size	4 Bytes
Access	rw
Example (SDO)	23 4E 30 00 10 27 00 00 (:SIM:NORM1:TIME 1)
	Sets the step time to 1 second.

Object 0x304F: [:SOURce]:SIMulation:NORMAL 1:VOLTage

Description	Sets or queries the Vset parameter of the normal1step for the Simulation mode. (Only Simulation Mode Active)
Index	0x304F
Sub-Index	0x00 (Normal 1)
Value	Voltage of the abnormal step. (Set Value = Value * 100)
Type	Unsigned32
Data size	4 Bytes
Access	rw
Sub-Index	0x01 (Normal 2)
Value	Voltage of the abnormal step. (Set Value = Value * 100)
Type	Unsigned32
Data size	4 Bytes
Access	rw
Example (SDO)	23 4F 30 00 10 27 00 00 (:SIM:NORM1:VOLT 100)
	Sets the normal1step voltage to the 100.

Object 0x3050: [:SOURce]:SIMulation:REPeat:COUNT

Description	Sets or queries the repeat count for the Simulation mode. (Only Simulation Mode Active)
Index	0x3050
Sub-Index	0x00
Value	0 ~ 9999 (0 = infinite loop)
Type	Unsigned16
Data size	2 Bytes
Access	rw
Example (SDO)	23 50 30 00 01 00 00 00 (:SIM:REP:COUN 1) Sets the repeat count to 1.

Object 0x3051: [:SOURce]:SIMulation:REPeat:ENABLE

Description	Turns the repeat function on or off for the Simulation mode. (Only Simulation Mode Active)
Index	0x3051
Sub-Index	0x00
Value	0 = Disabled 1 = Enabled
Type	Unsigned8
Data size	1 Byte
Access	rw
Example (SDO)	23 51 30 00 01 00 00 00 (:SIM:REP:ENAB 1) Enables the repeat function.

Object 0x3053:

[:SOURce]:SIMulation:TRANSition<1|2>:TIME

Description	Sets or queries the Time parameter of the transitionstep for the Simulation mode. (Only Simulation Mode Active)
Index	0x3053
Sub-Index	0x00 (Transition 1 Time of the step in seconds)
Value	0.0001 ~ 999.9999 s (Set Value = Value * 10000)
Type	Unsigned32
Data size	4 Bytes
Access	rw
Sub-Index	0x01 (Transition 2 Time of the step in seconds)
Value	0.0001 ~ 999.9999 s (Set Value = Value * 10000)
Type	Unsigned32
Data size	4 Bytes
Access	rw
Example (SDO)	23 53 30 00 10 27 00 00 (:SIM:TRAN1:TIME 1)
	Sets the step time to 1 second.

Object 0x3052:

[:SOURce]:SIMulation:TRANSition<1|2>:CODE

Description	Sets the external trigger output for the transitionstep parameter. This option is only applicable when in the Simulation mode. (Only Simulation Mode Active)
Index	0x3052
Sub-Index	0x00 (Transition 1 Code)
Value	0 = LL 1 = LH 2 = HL 3 = HH
Type	Unsigned8
Data size	1 Byte
Access	rw
Sub-Index	0x01 (Transition 2 Code)
Value	0 = LL 1 = LH 2 = HL 3 = HH
Type	Unsigned8
Data size	1 Byte
Access	rw
Example (SDO)	23 52 30 00 01 00 00 00 (:SIM:TRAN1:CODE 1)
	Set the transition 1 code to LH.

Object 0x2E06: TRIGger:SIMulation:SElected:EXECute

Description	Sets to execute actions for simulate mode. (OnlySimulation Mode Active)	
Index	0x2E06	
Sub-Index	0x00	
Value	0 = STOP	Stops simulate execution
	1 = START	Starts simulate execution
	2 = HOLD	Holds simulate execution
Type	Unsigned8	
Data size	1 Byte	
Access	rw	
Example (SDO)	23 06 2E 00 01 00 00 00 (:TRIG:SIM:SEL:EXEC STAR)	
	Starts simulate execution.	

Input Subsystem Command

Object 0x2603: INPut:GAIN.....	266
Object 0x2604: INPut:SOURce.....	267
Object 0x2605: INPut:SYNC:SOURce.....	268

Object 0x2603: INPut:GAIN

Description	Sets or queries the input gain value. (Only AC+DC-EXT or AC-EXT or AC+DC-ADD or AC-ADD or AC-VCA Active)
Index	0x2603
Sub-Index	0x00
Value	Input gain value (Set Value = Value * 10)
Type	Unsigned16
Data size	2 Bytes
Access	rw
Example (SDO)	40 03 26 00 00 00 00 00 (:INP:GAIN?) Return data is 1500 (150.0) 43 03 26 00 DC 05 00 00 Returns the input gain value as 150.0.

Object 0x2604: INPut:SOURce

Description	Sets or queries state of source. (Only AC+DC-EXT or AC-EXT or AC+DC-ADD or AC-ADD or AC-VAC Active)
Index	0x2604
Sub-Index	0x00
Value	0 = L1EXT L1 EXT source 1 = L2EXT L2 EXT source 2 = L3EXT L3 EXT source
Type	Unsigned8
Data size	1 Byte
Access	rw
Example (SDO)	40 04 26 00 00 00 00 00 (:INP:SOUR?) Return data is 0 (L1EXT) 43 04 26 00 00 00 00 00 Returns the input gain value as 150.0.

Object 0x2605: INPut:SYNC:SOURce

Description	Sets or queries state of sync source. (Only AC+DC-sync or AC-sync Active)	
Index	0x2605	
Sub-Index	0x00	
Value	0 = L1 LINE	L1 LINE sync source
	1 = L2 LINE	L2 LINE sync source
	2 = L3 LINE	L3 LINE sync source
	3 = EXT	EXT sync source
Type	Unsigned8	
Data size	1 Byte	
Access	rw	
Example (SDO)	40 05 26 00 00 00 00 00 (:INP:SYNC:SOUR?)	
	Return data is 3 (EXT)	
	43 05 26 00 03 00 00 00	
	Returns the state of sync source as EXT.	

Display Command

Object 0x2301: DISPlay[:WINDow]:DESIgn:MODE 269
 Object 0x2302: DISPlay[:WINDow]:MEASure:SOURce<1 | 2 | 3 | 4> ..270
 Object 0x2310: DISPLAY_ADDRESS..... 272

Object 0x2301: DISPlay[:WINDow]:DESIgn:MODE

Description	Sets or queries state of sync source. (Only AC+DC-sync or AC-sync Active)
Index	0x2301
Sub-Index	0x00
Value	0 = NORMAl Configure setup and Measurement. 1 = TOTAl Configure setup and Measurement include total information. 2 = SIMPlE All measurement times.
Type	Unsigned8
Data size	1 Byte
Access	wo
Example (SDO)	23 01 23 00 00 00 00 00 (:DISP:DES:MODE NORM) Sets standard normal display.

Object 0x2302:

DISPlay[:WINDow]:MEASure:SOURce<1|2|3|4>

Description	Sets standard normal display to measurement items 1 - 4.
Index	0x2302
Sub-Index	0x00 (Item 1)
Value	0 = VRMS 1 = VAVG 2 = VMAX 3 = VMIN 4 = VPKH 10 = RPOWer 11 = SPOWer (Not available for DC-INT) 12 = QPOWer (Not available for DC-INT) 16 = THDV (Available for AC-INT only) 18 = LRMS 19 = LAVG 20 = LMAX 21 = LMIN
Type	Unsigned8
Data size	1 Byte
Access	rw
Sub-Index	0x01 (Item 2)
Value	5 = IRMS 6 = IAVG 7 = IMAX 8 = IMIN 9 = IPKH 14 = PFACTOR (Not available for DC-INT) 15 = CFACTOR (Not available for DC-INT) 17 = THDI (Available for AC-INT only)

Type	Unsigned8
Data size	1 Byte
Access	rw
Sub-Index	0x02 (Item 3)
Value	9 = IPKH, 10 = RPOWer 11 = SPOWer 12 = QPOWer (Not available for DC-INT) 13 = FREQuency (Available for AC+DC-Sync & AC-Synonly) 14 = PFACtor (Not available for DC-INT) 15 = CFACtor (Not available for DC-INT)

Type	Unsigned8
Data size	1 Byte
Access	rw
Sub-Index	0x03 (Item 4)

Value	Available for DC-INT only: 5 = IRMS 6 = IAVG 7 = IMAX 8 = IMIN 9 = IPKH Not available for DC-INT: 11 = SPOWer 12 = QPOWer 14 = PFACtor 15 = CFACtor 18 = LRMS 19 = LAVG 20 = LMAX 21 = LMIN Common: 10 = RPOWer
-------	-------------------------------------------------------------------------------------------------------------------------------------------------------------------------------------------------------------------------------------------------------------------------

Type	Unsigned8
Data size	1 Byte
Access	rw
Example (SDO)	23 02 23 00 00 00 00 00 (:DISP:MEAS:SOUR1 VRMS)

Sets measurement source 1 VRMS display.

Object 0x2310: DISPLAY_ADDRESS

Description	Display the CAN Bus/DeviceNet address on screen.
Index	0x2301
Sub-Index	0x00
Value	-
Type	Unsigned8
Data size	1 Byte
Access	wo
Example (SDO)	23 10 23 00 00 00 00 00 (DISPLAY_ADDRESS)

Display the CAN Bus/DeviceNet address on screen.

Read Data Range Commands

Object 0x3601: DATA_RANGE_MAX.....	273
Object 0x3602: DATA_RANGE_MIN.....	276

Object 0x3601: DATA_RANGE_MAX

Description	Read the maximum settable value in normal mode.
Index	0x2302
Sub-Index	0x00 (ACV)
Value	Set Value = Value * 100
Type	Unsigned32
Data size	4 Bytes
Access	ro
Sub-Index	0x01 (DCV)
Value	Set Value = Value * 100
Type	Signed32
Data size	4 Bytes
Access	rw
Sub-Index	0x02 (Freq)
Value	Set Value = Value * 100
Type	Unsigned32
Data size	4 Bytes
Access	ro
Sub-Index	0x03 (Irms)
Value	Set Value = Value * 100
Type	Unsigned32

Data size	4 Bytes
Access	ro
Sub-Index	0x04 (On phase)
Value	Set Value = Value * 10
Type	Unsigned16
Data size	2 Bytes
Access	ro
Sub-Index	0x05 (Off phase)
Value	Set Value = Value * 10
Type	Unsigned16
Data size	2 Bytes
Access	ro
Sub-Index	0x06 (Balance L12)
Value	Set Value = Value * 10
Type	Unsigned16
Data size	2 Bytes
Access	ro
Sub-Index	0x07 (Balance L13)
Value	Set Value = Value * 10
Type	Unsigned16
Data size	2 Bytes
Access	ro
Sub-Index	0x08 (GAIN)
Value	Set Value = Value * 10
Type	Unsigned16
Data size	2 Bytes
Access	ro

Sub-Index	0x09 (Sync Phase)
Value	Set Value = Value * 10
Type	Unsigned16
Data size	2 Bytes
Access	ro
Sub-Index	0x0A (Vpk limit High)
Value	Set Value = Value * 100
Type	Unsigned32
Data size	4 Bytes
Access	ro
Sub-Index	0x0B (Vpk limit Low)
Value	Set Value = Value * 100
Type	Signed32
Data size	4 Bytes
Access	ro
Sub-Index	0x0C (Ipk limit High)
Value	Set Value = Value * 100
Type	Unsigned32
Data size	4 Bytes
Access	ro
Sub-Index	0x0D (Ipk limit Low)
Value	Set Value = Value * 100
Type	Signed32
Data size	4 Bytes
Access	ro
Sub-Index	0x0E (Frequency limit High)
Value	Set Value = Value * 100

Type	Unsigned32
Data size	4 Bytes
Access	ro
Sub-Index	0x0F (Frequency limit Low)
Value	Set Value = Value * 100
Type	Unsigned32
Data size	4 Bytes
Access	ro
Example (SDO)	40 01 36 00 00 00 00 00 Return data is 17500 (175.00) 43 01 36 00 5C 44 00 00 Returns the ACV maximum settable value as 175.00.

Object 0x3602: DATA_RANGE_MIN

Description	Read the minimum settable value in normal mode.
Index	0x2302
Sub-Index	0x00 (ACV)
Value	Set Value = Value * 100
Type	Unsigned32
Data size	4 Bytes
Access	ro
Sub-Index	0x01 (DCV)
Value	Set Value = Value * 100
Type	Signed32

Data size	4 Bytes
Access	rw
Sub-Index	0x02 (Freq)
Value	Set Value = Value * 100
Type	Unsigned32
Data size	4 Bytes
Access	ro
Sub-Index	0x03 (Irms)
Value	Set Value = Value * 100
Type	Unsigned32
Data size	4 Bytes
Access	ro
Sub-Index	0x04 (On phase)
Value	Set Value = Value * 10
Type	Unsigned16
Data size	2 Bytes
Access	ro
Sub-Index	0x05 (Off phase)
Value	Set Value = Value * 10
Type	Unsigned16
Data size	2 Bytes
Access	ro
Sub-Index	0x06 (Balance L12)
Value	Set Value = Value * 10
Type	Unsigned16
Data size	2 Bytes
Access	ro

Sub-Index	0x07 (Balance L13)
Value	Set Value = Value * 10
Type	Unsigned16
Data size	2 Bytes
Access	ro
Sub-Index	0x08 (GAIN)
Value	Set Value = Value * 10
Type	Unsigned16
Data size	2 Bytes
Access	ro
Sub-Index	0x09 (Sync Phase)
Value	Set Value = Value * 10
Type	Unsigned16
Data size	2 Bytes
Access	ro
Sub-Index	0x0A (Vpk limit High)
Value	Set Value = Value * 100
Type	Unsigned32
Data size	4 Bytes
Access	ro
Sub-Index	0x0B (Vpk limit Low)
Value	Set Value = Value * 100
Type	Signed32
Data size	4 Bytes
Access	ro
Sub-Index	0x0C (Ipk limit High)
Value	Set Value = Value * 100

Type	Unsigned32
Data size	4 Bytes
Access	ro
Sub-Index	0x0D (Ipk limit Low)
Value	Set Value = Value * 100
Type	Signed32
Data size	4 Bytes
Access	ro
Sub-Index	0x0E (Frequency limit High)
Value	Set Value = Value * 100
Type	Unsigned32
Data size	4 Bytes
Access	ro
Sub-Index	0x0F (Frequency limit Low)
Value	Set Value = Value * 100
Type	Unsigned32
Data size	4 Bytes
Access	ro
Example	40 02 36 00 00 00 00 00
(SDO)	Return data is 0 (0)
	43 02 36 00 00 00 00 00
	Returns the ACV minimum settable value as 0.

SDO Abort Transmission (CANopen Errors)

Overview

SDO Abort Transmission is a mechanism employed in CANopen communication to address errors that arise during the transfer of Service Data Objects (SDOs) between CANopen devices. In the event of an error during an SDO transfer, the receiving device can initiate an SDO Abort Transmission to inform the transmitting device about the error and cease the ongoing data exchange.

The receiving device triggers an SDO Abort Transmission when it encounters an error condition during SDO communication. Various reasons can lead to this, including:

Timeout: If the receiving device does not receive the expected SDO within a predetermined time frame, it can initiate an SDO Abort Transmission to indicate a timeout error.

Data Corruption: If the receiving device detects that the received data is corrupted or inconsistent, it can initiate an SDO Abort Transmission to indicate a data error.

Invalid Parameters: If the receiving device receives an SDO request with parameters that are invalid or out of range, it can trigger an SDO Abort Transmission to indicate an invalid parameter error.

Object Does Not Exist: If the receiving device receives an SDO request for an object that does not exist in its object dictionary, it can initiate an SDO Abort Transmission to indicate the non-existence of the requested object.

Access Denied: If the receiving device lacks the necessary access rights or permissions to execute the requested SDO operation, it can initiate an SDO Abort Transmission to indicate an access denied error.

Upon occurrence of an SDO Abort Transmission, the receiving device transmits an abort message to the transmitting device. The abort message carries an error code that specifies the type of encountered error, enabling the transmitting device to identify and appropriately handle the error.

When the transmitting device receives the abort message, it must take appropriate actions to address the error condition. This may involve notifying the higher-level application, attempting to retry the SDO transfer, or executing error recovery procedures based on the specific error code received.

SDO Abort Transmission plays a crucial role in ensuring reliable and robust communication within CANopen networks by providing a means to detect and manage errors during SDO transfers.

The protocol defined in the table below will be used to implement the SDO abort transmission service. When an abnormality occurs in the communication, the SDO will return the Abort code.

Abort code	Description
0x05030000	Toggle bit not alternated.
0x05040000	SDO protocol timed out.
0x05040001	Client/server command specifier not valid or unknown.
0x05040002	Invalid block size (block mode only).
0x05040003	Invalid sequence number (block mode only).
0x05040004	CRC error (block mode only).
0x05040005	Out of memory.
0x06010000	Unsupported access to an object.
0x06010001	Attempt to read a write only object.
0x06010002	Attempt to write a read only object.
0x06020000	Object does not exist in the object dictionary.
0x06040041	Object cannot be mapped to the PDO.
0x06040042	The number and length of the objects to be mapped would exceed PDO length.
0x06040043	General parameter incompatibility reason.
0x06040047	General internal incompatibility in the device.
0x06060000	Access failed due to an hardware error.
0x06070010	Data type does not match, length of service parameter does not match
0x06070012	Data type does not match, length of service parameter too high
0x06070013	Data type does not match, length of service parameter too low

0x06090011	Sub-index does not exist.
0x06090030	Invalid value for parameter (download only).
0x06090031	Value of parameter written too high (download only).
0x06090032	Value of parameter written too low (download only).
0x06090036	Maximum value is less than minimum value.
0x060A0023	Resource not available: SDO connection
0x08000000	General error
0x08000020	Data cannot be transferred or stored to the application
0x08000021	Data cannot be transferred or stored to the application because of local control.
0x08000022	Data cannot be transferred or stored to the application because of the present device state
0x08000023	Object dictionary dynamic generation fails or no object dictionary is present (e.g. object dictionary is generated from file and generation fails because of an file error).
0x08000024	No data available

A PPENDIX

Factory Default Settings

The following default settings are the factory configuration settings for the ASR-6000 series. For details on how to return to the factory default settings, see the User's Manual.

Continuous Mode	ASR-6450		ASR-6600	
	3P4W	1P2W	3P4W	1P2W
MODE	AC+DC-INT		AC+DC-INT	
Range	100V		100V	
ACV	0.00 Vrms		0.00 Vrms	
DCV	+0.00 Vdc		+0.00 Vdc	
FREQ	50.00Hz		50.00 Hz	
IRMS	15.75 A	47.25 A	21 A	63 A
ON Phs	Fixed 0.0°		Fixed 0.0°	
OFF Phs	Fixed 0.0°		Fixed 0.0°	
GAIN	100		100	
SIG	L1 LINE		L1 LINE	
Syc Phs	0.0		0.0	
SRC	L1 EXT		L1 EXT	
Wave	SIN		SIN	
Freq Limit	2000		2000	
Vrms Limit	175.0 Vrms		175.0 Vrms	
VPK+ Limit	+250 V		+250 V	
VPK- Limit	-250 V		-250 V	
IPK+ Limit	+63.00 A	+189.00 A	+84.00 A	+252.00 A
IPK- Limit	-63.00 A	-189.00 A	-84.00 A	-252.00 A

MISC Configuration	ASR-6450	ASR-6600
T peak , hold(msec)	1	1
Phase Mode	Unbalance	Unbalance
Peak CLR	ALL	ALL
Power ON	OFF	OFF
Buzzer	ON	ON
Remote Sense	OFF	OFF
V Response	Medium	Medium
Output Relay	Enable	Enable
THD Format	IEC	IEC
External Control	OFF	OFF
V Unit(TRI,ARB)	rms	rms
Set Change Phase	OFF	OFF
Monitor Output1	L1 Voltage	L1 Voltage
Monitor Output2	L1 Current	L1 Current
Monitor Output Amp	±2.5	±2.5
TrgOut Width(ms)	0.1	0.1
TrgOut Source	L1	L1
Re-Lock	ON	ON
Data Average Count	8	8
Data Update Rate	Fast	Fast

LAN	ASR-6450	ASR-6600
DHCP	ON	ON

USB Device	ASR-6450	ASR-6600
Speed	Full	Full
Mode	TMC	TMC

RS232C	ASR-6450	ASR-6600
Baudrate	9600	9600
Databits	8bits	8bits
Parity	None	None
Stopbits	1bit	1bit

GPIB	ASR-6450	ASR-6600
Address	10	10

CAN BUS	ASR-6450	ASR-6600
Baudrate	125K	125K
Node ID	127	127

DeviceNet	ASR-6450	ASR-6600
Baudrate	125K	125K
MAC ID	63	63

Output Impedance	ASR-6450	ASR-6600
Output Impedance	OFF	OFF
L1 Output Inductance	0.1 μ H	0.1 μ H
L2 Output Inductance	0.1 μ H	0.1 μ H
L3 Output Inductance	0.1 μ H	0.1 μ H
L1 Output Resistance	0.1 Ω	0.1 Ω
L2 Output Inductance	0.1 Ω	0.1 Ω
L3 Output Inductance	0.1 Ω	0.1 Ω

Sequence Mode	ASR-6450			ASR-6600		
Step	0			0		
Time	0.1000 s			0.1000 s		
Jump To	OFF			OFF		
Jump Cnt	1			1		
Branch 1	OFF			OFF		
Branch 2	OFF			OFF		
Term	CONTI			CONTI		
Sync Code	LL			LL		
Item	L1	L2	L3	L1	L2	L3
ACV	0.00, CT	0.00, CT	0.00, CT	0.00, CT	0.00, CT	0.00, CT
DCV	0.00, CT	0.00, CT	0.00, CT	0.00, CT	0.00, CT	0.00, CT
Fset	50.0 , CT	50.0 , CT	50.0 , CT	50.0 , CT	50.0 , CT	50.0 , CT
Wave	SIN	SIN	SIN	SIN	SIN	SIN
ON Phs	Free	Free	Free	Free	Free	Free
OFF Phs	Free	Free	Free	Free	Free	Free
Phase	Fixed (0)	120	240	Fixed (0)	120	240

Simulate Mode	ASR-6450			ASR-6600		
Step	Initial			Initial		
Repeat	OFF			OFF		
Time	0.1000 s			0.1000 s		
Term	Free			Free		
Code	LL			LL		
Item	L1	L2	L3	L1	L2	L3
ACV	0.00	0.00	0.00	0.00	0.00	0.00
Fset	50.00	50.00	50.00	50.00	50.00	50.00
Wave	SIN	SIN	SIN	SIN	SIN	SIN
ON Phs	Free	Free	Free	Free	Free	Free
OFF Phs	Free	Free	Free	Free	Free	Free

Default Waveform Setting

ARB 1 Ramp (rising)

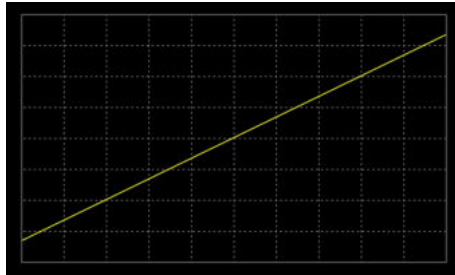

ARB 2 Ramp (falling)

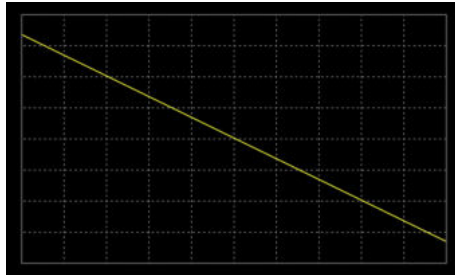

ARB 3 Sine wave, half-cycle(positive pole)

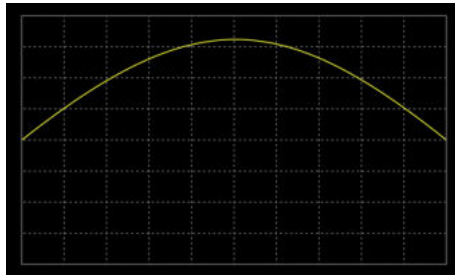

ARB 4 Sine wave, half-cycle(negative pole)

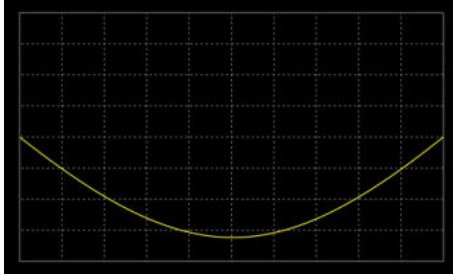

ARB 5 Sine wave, half-wave rectification (positive polarity)

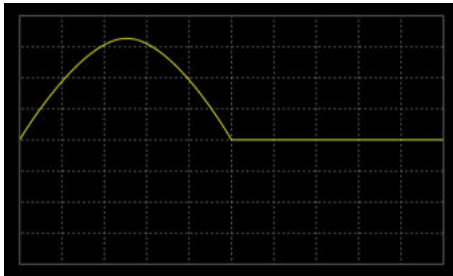

ARB 6 Sine wave, half-wave rectification(negative polarity)

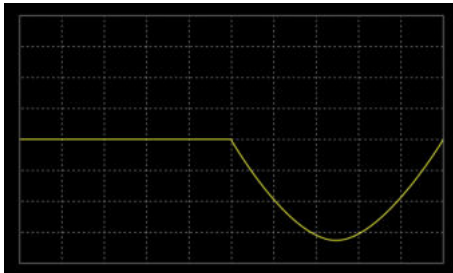

ARB 7 Sine wave, full-wave
rectification(positive polarity)

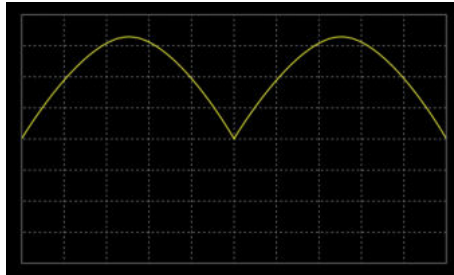

ARB 8 Sine wave, full-wave
rectification(negative polarity)

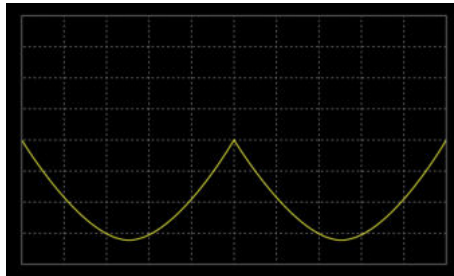

ARB 9 Second order step response(damping
coefficient 0.1)

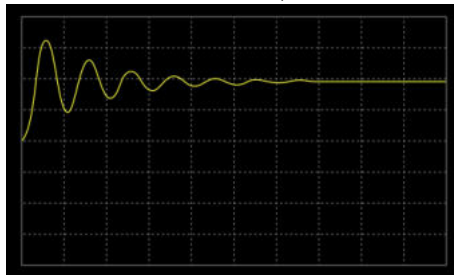

ARB 10 Second order step response(damping coefficient 0.2)

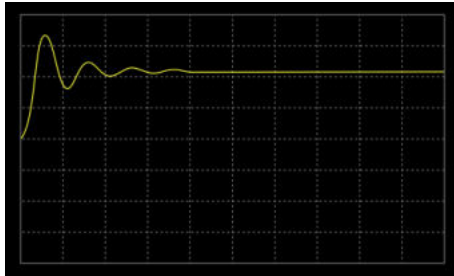

ARB 11 Second order step response(damping coefficient 0.7)

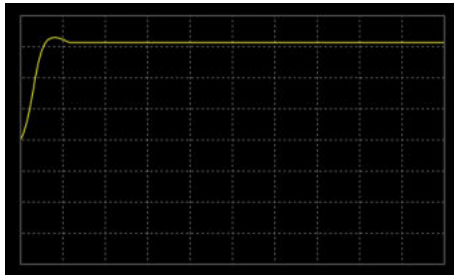

ARB 12 Second order impulse response(damping coefficient 0.1)

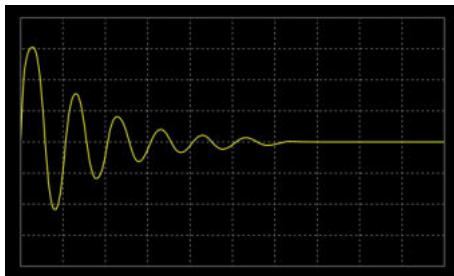

ARB 13 Second order impulse response(damping coefficient 0.2)

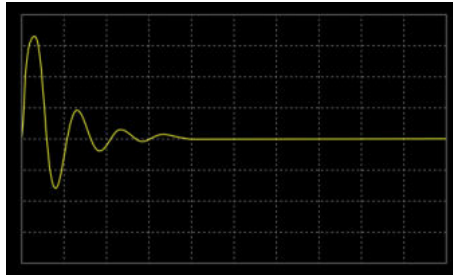

ARB 14 Second order impulse response(damping coefficient 0.7)

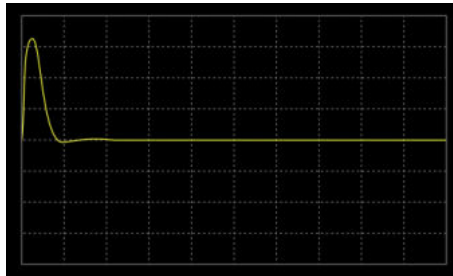

ARB 15 Exponential (rising)

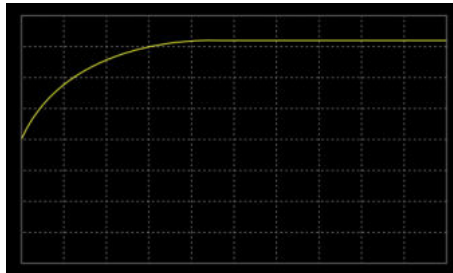

ARB 16 Exponential (falling)

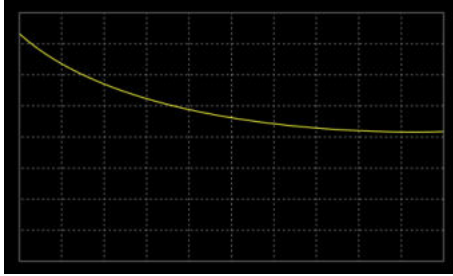

Default Sequence Setting

SEQ6 Momentary drop in supply voltage

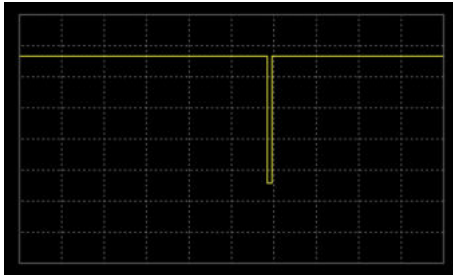

SEQ7 Reset test for Level1 systems with 12V

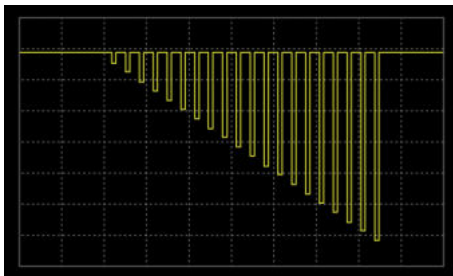

SEQ8 Starting Profile

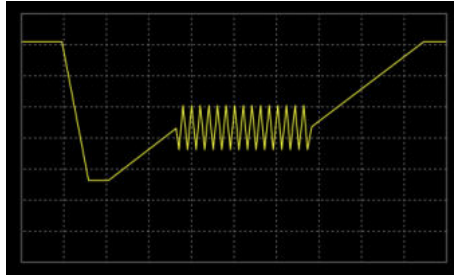

SEQ9 Test2 Tr: 10ms, Td: 40ms

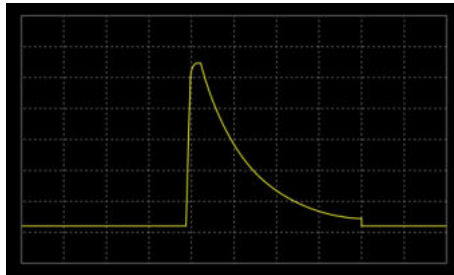

INDEX

Accessories	11	List of features	10
Caution symbol	4	Model differences	9
Cleaning the instrument	7	Power on/off	
Default settings	284	safety instruction	6
Disposal instructions	7	Remote control	21, 40
EN61010		Command list	74, 80
pollution degree	7	RS232	41
Environment		Status registers	280
safety instruction	7	Service operation	
Front panel diagram	13	about disassembly	5
Ground		Warning symbol	4
symbol	4		