

Ribbon

SPECIFICATION SHEET

Version: 2019-1



Ribbon

The Ribbon Drain has a distinctively alluring silhouette - the result of a special project commissioned by Aquabocci to see how far we could go with our product development. The Ribbon's flowing shape embodies today's ever changing design landscape.

Profile

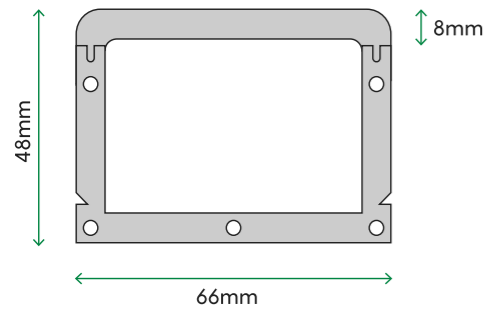

Lengths

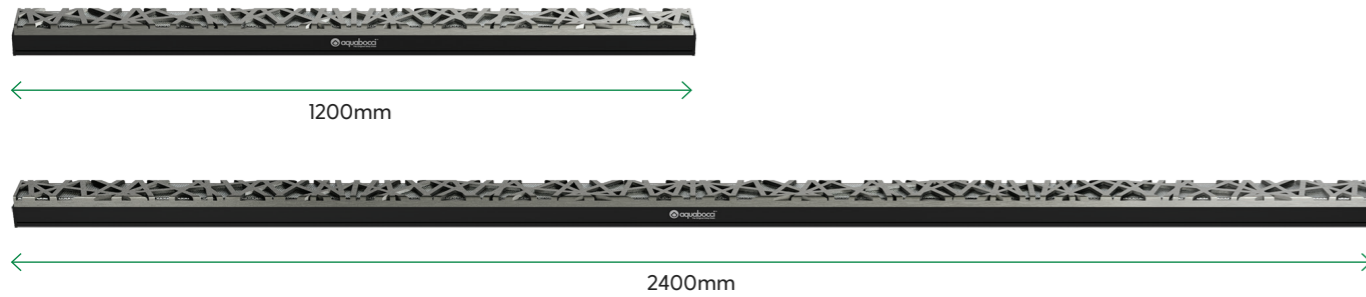

Performance and finish

LOCATIONS	Wet Rooms, balconies and thresholds
FLOW RATES	90 litres per minute
SLIP RATING	Optional Aquabocci WunderGrip (CSIRO R-13) / Non Slip finish available on all Aquabocci products
ANTI CORROSION	Guaranteed not to rust, corrode or tea stain around salt water or chlorine
HEELGUARD SAFE?	Yes
FUNCTION	Can be cut to any length
AQUABOCCI CUSTOM	4 colours available

System fittings

Aquabocci accessories are as durable as our drainage systems themselves. Corner pieces, end caps and connectors have EPDM rubber seals which screw into place for fast and easy installation.

Connector

With EPDM seals and screws

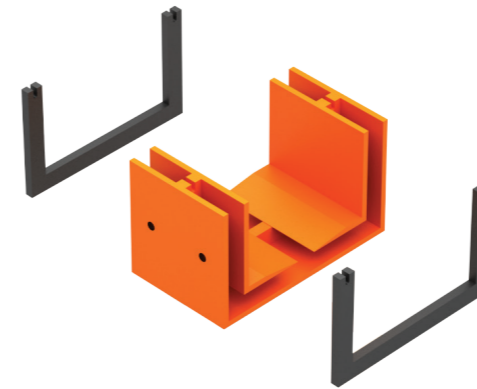

Corner



End Cap

With EPDM seals and screws

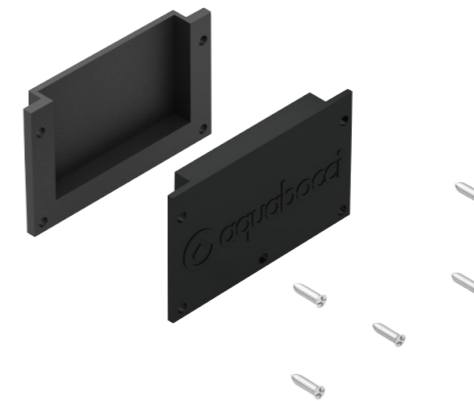

Spigot



Colours

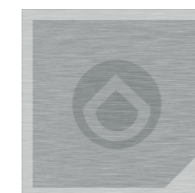

GT Silver

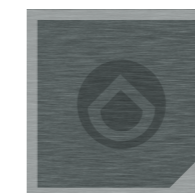

Titanium

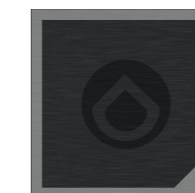

Black



Champagne

Ribbon INSTALLATION GUIDE

Slab Installation

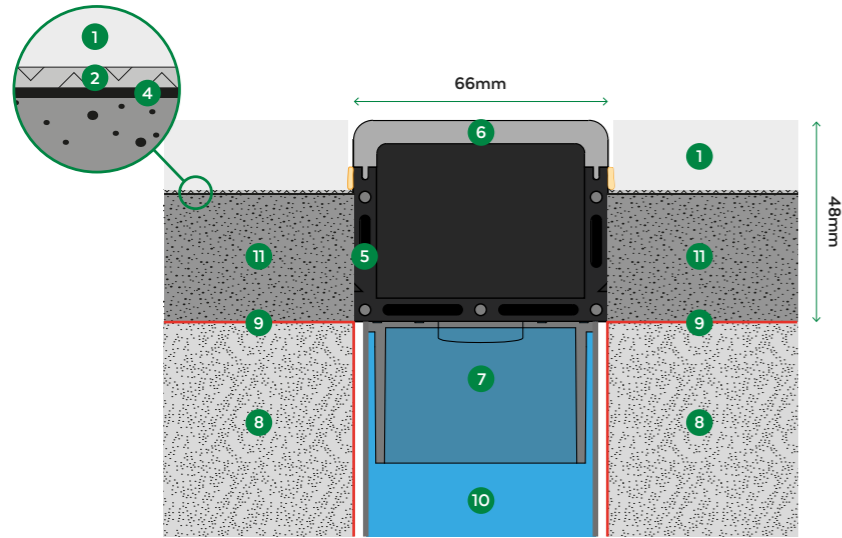

- 1 Tile
- 2 Tile adhesive
- 3 Silicon joint
- 4 Waterproof tape (Optional)
- 5 RIBBON extrusion channel
- 6 RIBBON removable grate
- 7 Spigot 50mm
- 8 Concrete slab
- 9 Waterproof membrane
- 10 Pipe 50mm, 80mm or 100mm
- 11 Screed

Timber Installation without Mortar Screed

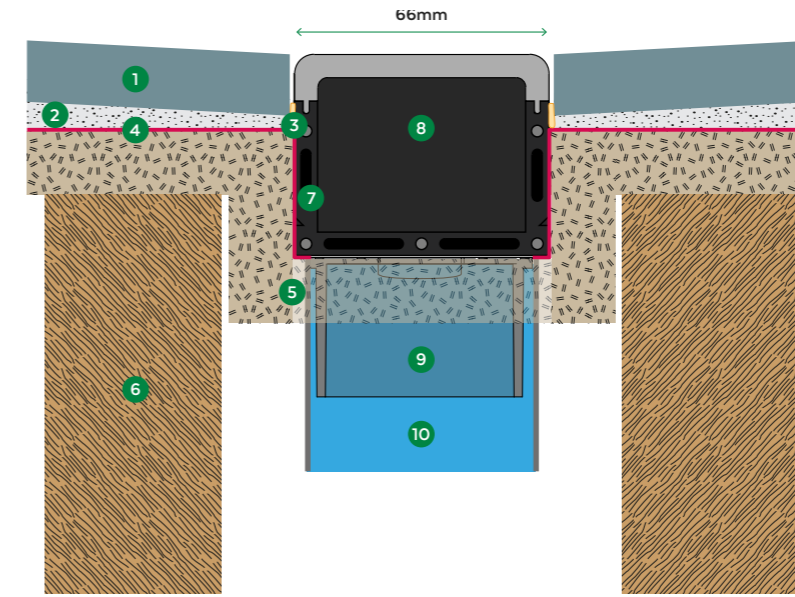

- 1 Tile
- 2 C2 Tile adhesive
- 3 Silicon joint
- 4 Waterproof membrane
- 5 Plywood supports plastic channel
- 6 Timber joist
- 7 RIBBON extrusion channel
- 8 RIBBON removable grate
- 9 Spigot 50mm
- 10 Pipe 50mm, 80mm or 100mm

Timber Installation with Mortar Screed

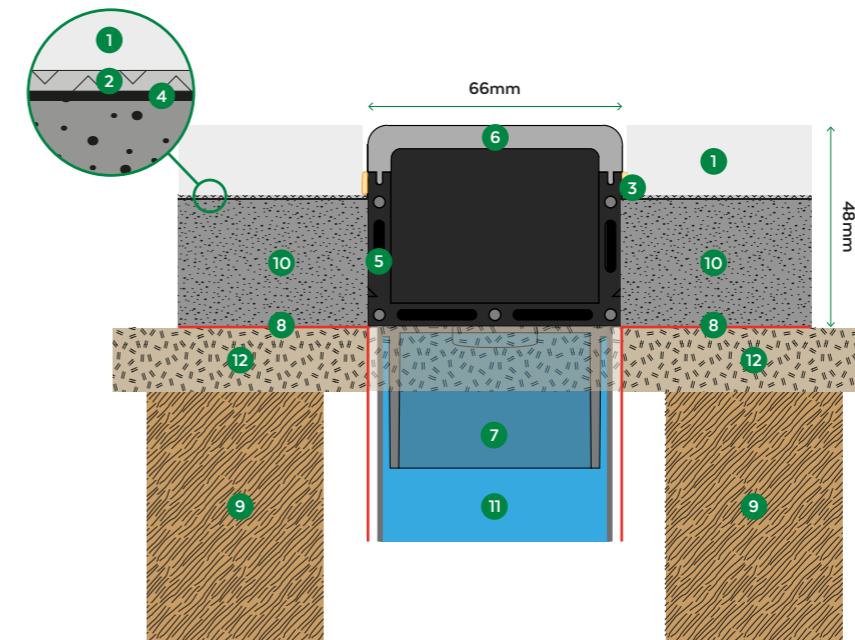

- 1 Tile
- 2 Tile adhesive
- 3 Silicon joint
- 4 Waterproof tape (Optional)
- 5 RIBBON extrusion channel
- 6 RIBBON removable grate
- 7 Spigot 50mm
- 8 Waterproof membrane
- 9 Timber joist
- 10 Screed
- 11 Pipe 50mm, 80mm or 100mm
- 12 Plywood supports plastic channel

