

Blade-T

SPECIFICATION SHEET

Version: 1



Blade-T

The Blade-T drain was one of our most testing projects to date. The challenge was to develop an external slot drain with these 4 very important features: a minimal slot, a low profile, a big flow rate and the ability to adjust to any tile or stone thickness. Firstly we built a 124mm x 32mm chamber capable of draining 90 litres of water. Secondly we built a cradle in the top of the chamber to hold the Blade drain. Finally we designed the aquabocci spacer system making the Blade grate height adjustable. The final result is the only low profile slot drain on the market capable of functioning like a traditional channel drain, whilst maintaining a discreet minimal design.

Profile

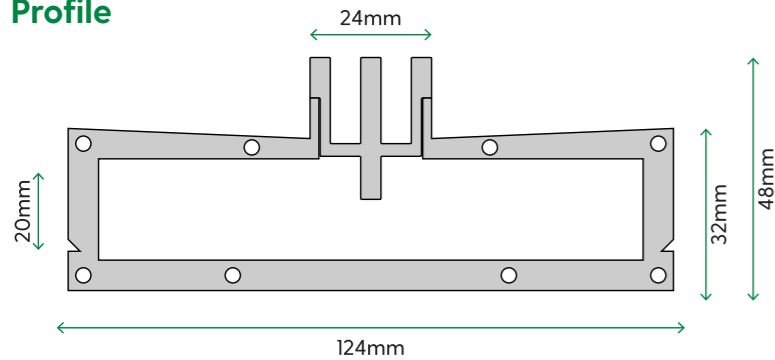

Lengths

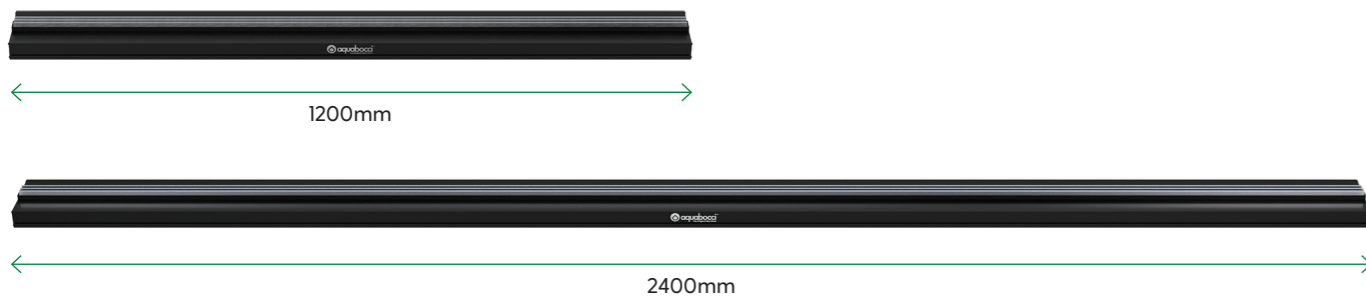

Performance and finish

LOCATIONS	Swimming Pools, Balconies and Courtyards
FLOW RATES	90 litres per minute
SLIP RATING	Optional Aquabocci WunderGrip (CSIRO R-13). Non Slip finish available on all Aquabocci products
ANTI CORROSION	Guaranteed not to rust, corrode or tea stain around salt water or chlorine
HEELGUARD SAFE?	Yes
FUNCTION	Can be cut to any length
AQUABOCCI CUSTOM	4 colours available

System fittings

With a smooth metal surface in 4 custom colours, it seamlessly integrates into any interior design or landscape setting, meaning you can install the Blade-T system in more external places than ever before.

Corner pieces, end caps and connectors have EPDM rubber seals which screw into place for fast and easy installation.

Connector

With EPDM seals and screws

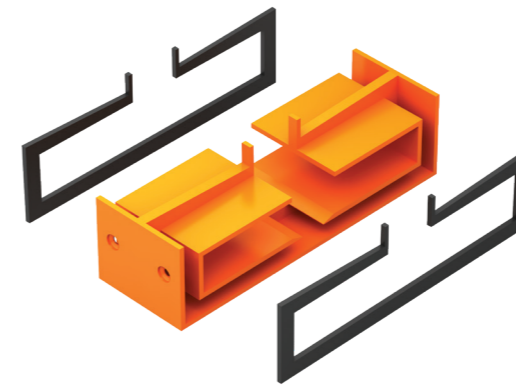

Corner



End Cap

With EPDM seals and screws

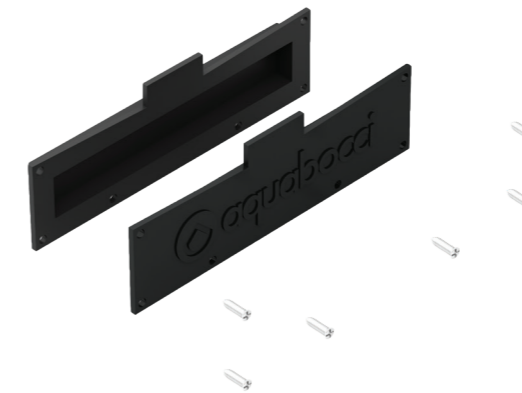

Spigot

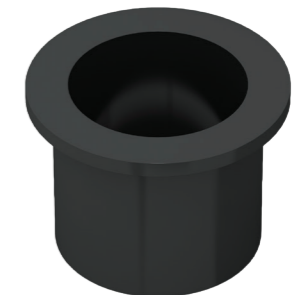

Colours

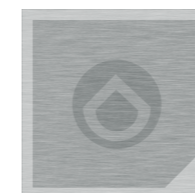

GT Silver

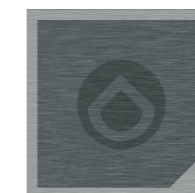

Titanium

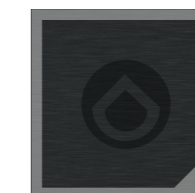

Black



Champagne



Blade-T INSTALLATION GUIDE

Slab Installation

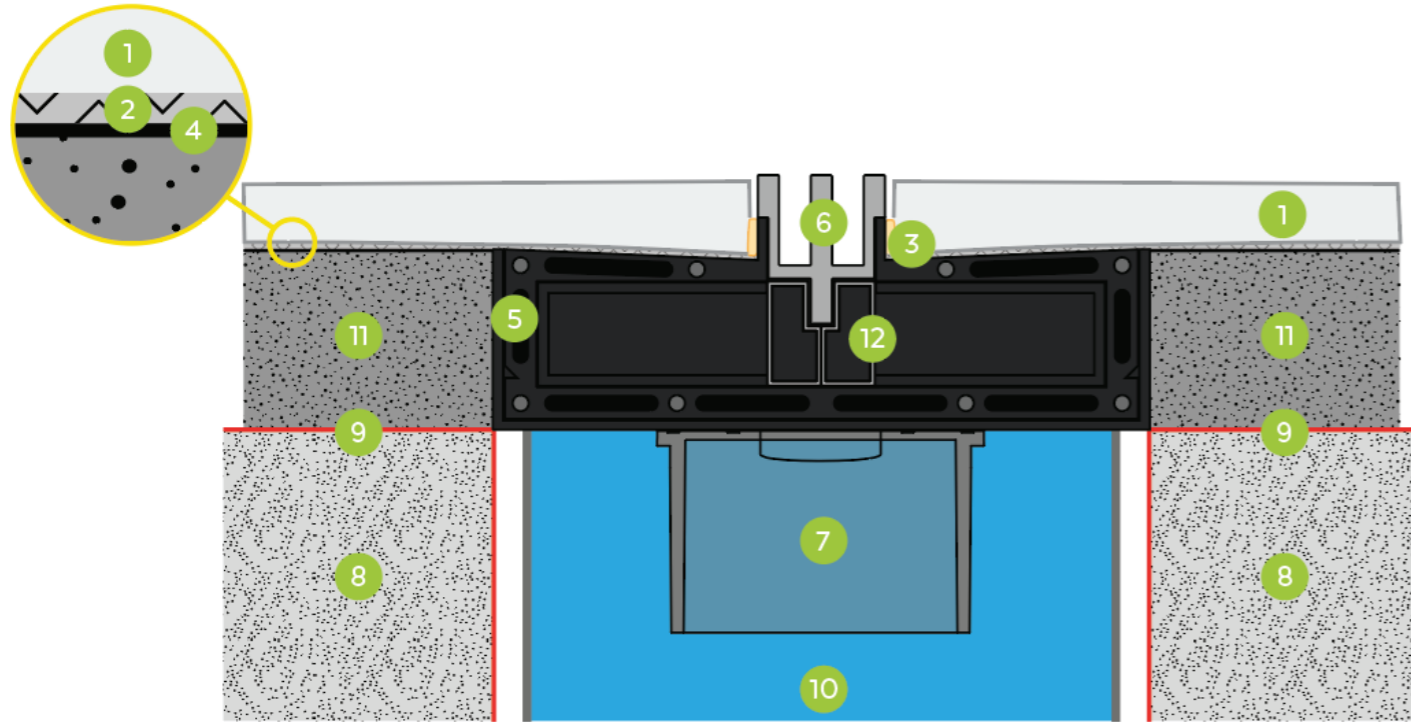

- 1 Tile
- 2 Tile adhesive
- 3 Silicon joint
- 4 Waterproof tape (Optional)
- 5 Extrusion channel
- 6 Removable grate
- 7 Spigots available to fit 50mm/1.97", 80mm/3.14" and 100mm/3.94"
- 8 Concrete slab or timber
- 9 Waterproof membrane
- 10 Pipe 50mm/1.97", 80mm/3.14" or 100mm/3.94"
- 11 Screed
- 12 Height adjustable spacers