

| 自

律

| 自

由



R12

FRAMESET USER MANUAL

YOELEO

Frameset Diagrams

The R12's component parts are listed from ①–⑭. You will receive all the parts inside your package.

- ① Rear brake hose
- ② Front derailleur cable
- ③ Rear derailleur cable
- ④ Front brake hose
- ⑤ Sponge tube

- ⑫ Bottle cage bolt
- ⑬ Hanger bolts
- ⑭ Hole Cover

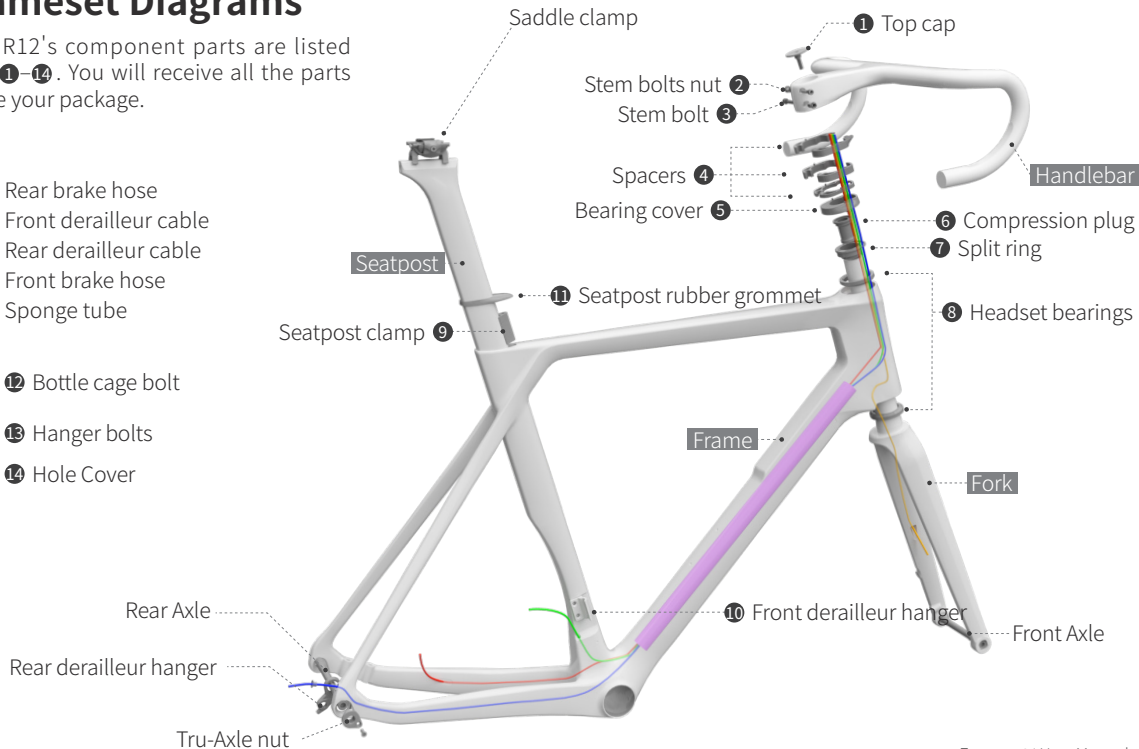

Brake & Gear Housing Routing - Mechanical

Route the housing into the down tube of the frame from the hole where each hose comes out.

Please measure the correct length of the brake and shifter housing before cutting.

- Red Rear brake hose
- Green Front derailleur cable
- Blue Rear derailleur cable
- Orange Front brake hose
- Purple Sponge tube

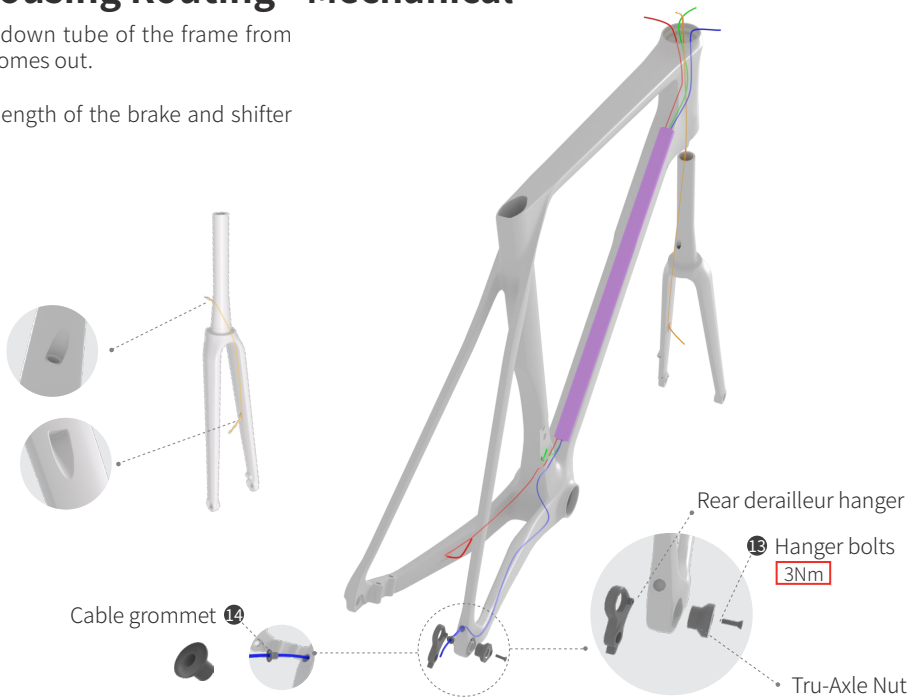

Headset Bearing Installation

Please route the cable housing FIRST before install the bearings.

Lightly grease the contact point between metal and carbon surface.

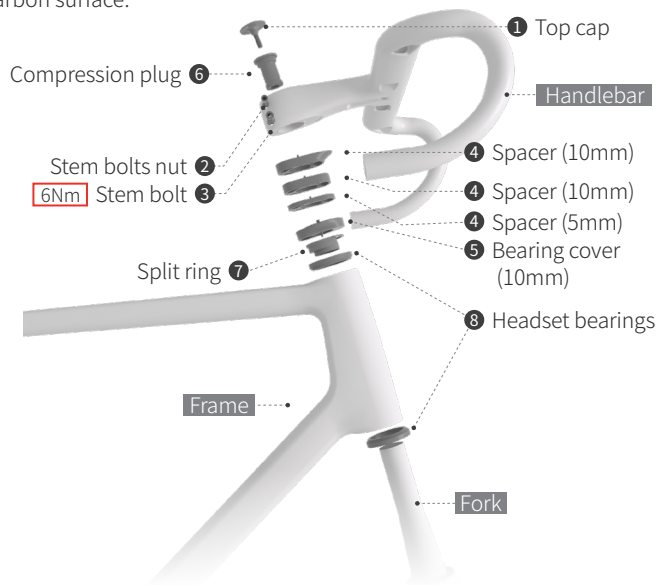
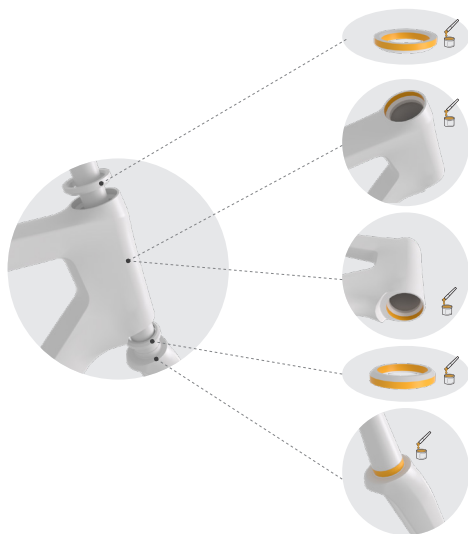

Spacers Installation

Pick the right spacer height to adjust your riding position. Remember to route the housing inside bearing cover ring before routing inside the handlebar.

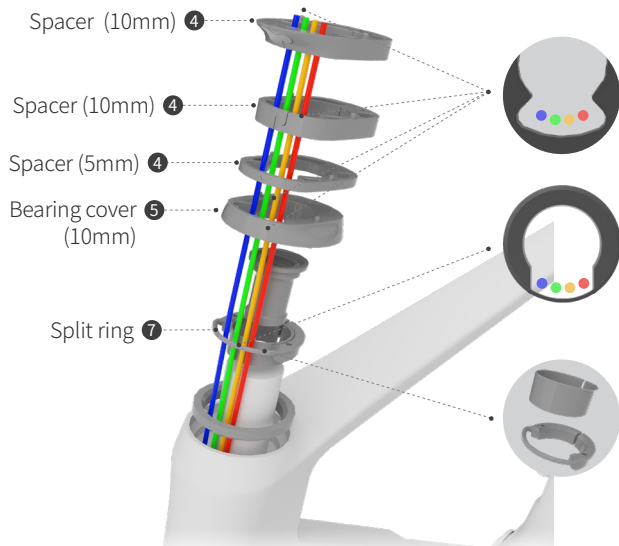

Handlebar Internal Routing

Route housing to the lever from this hole.

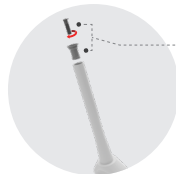

⑥ Compression plug **9Nm**

Compression Plug

Put the compression plug into the steerer tube.



① Top cap

Top Cap Bolt Tightening

Eliminate play in the steering tube by tightening top cap bolt.

Seatpost Installation

If needed, change the height of the seats and cut off any extra length. Remember that the minimum insertion is 10 CM.

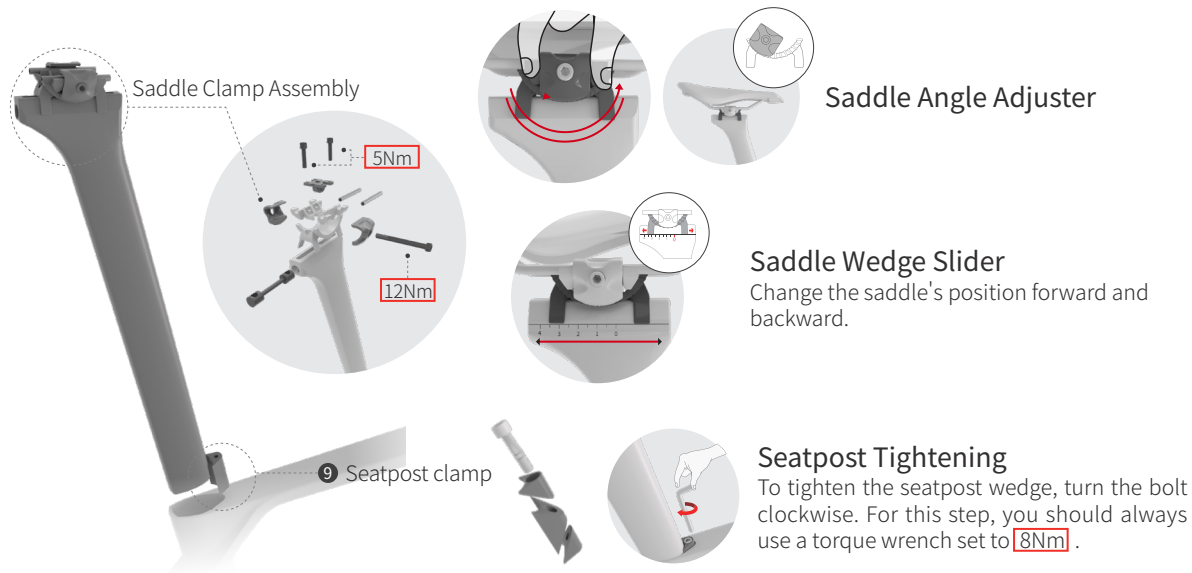

Mount Fixing Points

Carefully observe the bolt's length before attempting to tighten.



12 Bottle cage bolt*8 4Nm



Bottle cage



Safety

WARNING

Properly tighten hardware

always tighten hardware to the specified torque.

Over-tightening hardware could deform or break the hardware or components. Under-tightening hardware could cause hardware or components to become loose. Either situation could damage the bicycle and result in injury to the rider.

WARNING

Reapply threadlocker

All reused-fasteners with pre-applied threadlocker must be cleaned with isopropyl alcohol and have new thread locker applied before re-assembly. If threadlocker is not applied, the fasteners may loosen which could damage the bicycle and result in injury to the rider.

Legend



Apply appropriate grease



Apply threadlocker



Torque



Cable (zip) tie



Di2 wire 

A Quick guide for *H9/H27* installation

Shifting cable and brake hose routing

Rear brake hose		Rear derailleur cable	
Front derailleur cable		Front brake hose	

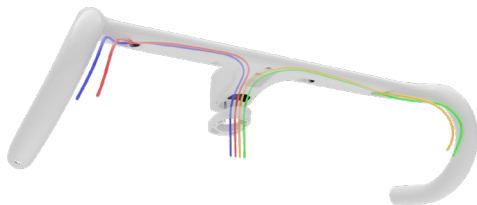

Internal Routing Frameset

In order to use the complete internal cables routing, the frame and the fork have to be compatible.

Fork: The fork must have a hole for the entrance of the brake front cable in the fork-tube to allow the cable routing up to the exit near front brake caliper.

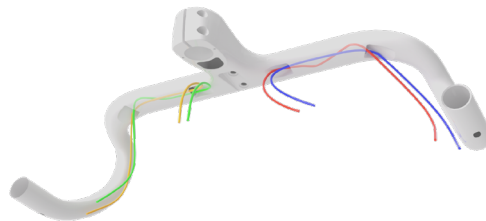

Traditional Frameset

In case of assembling on traditional frameset, cables will enter close to the levers and will go out from central holes. Here above a picture showing the cables passages.

Shifter/Brake lever Installation

Carefully observe the bolt's length before attempting to tighten. Use torque wrench to tighten the bolt around **6-8Nm**

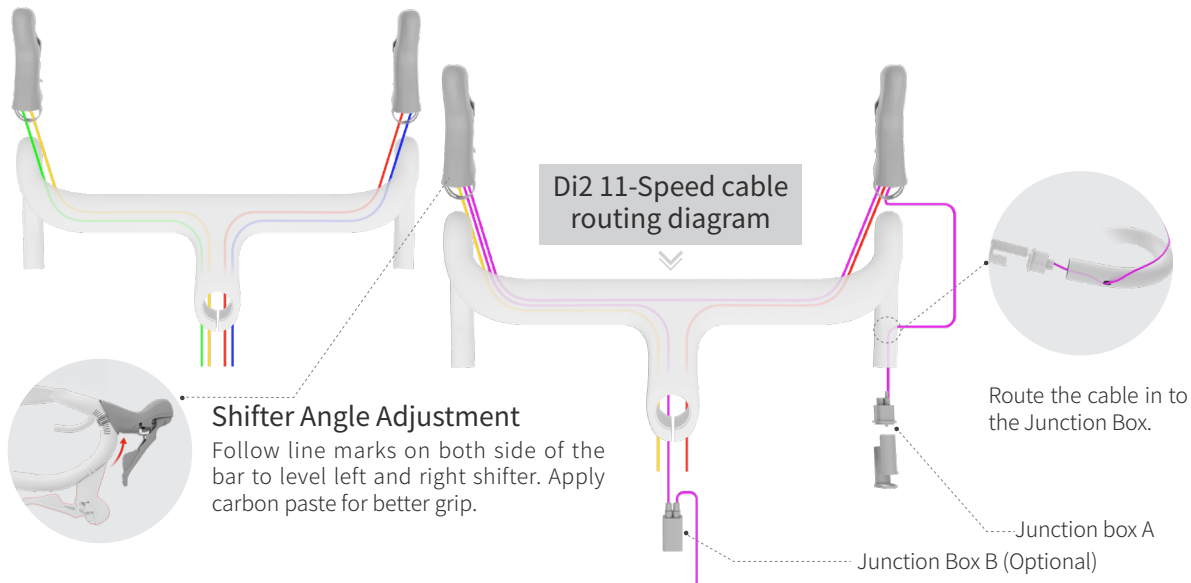

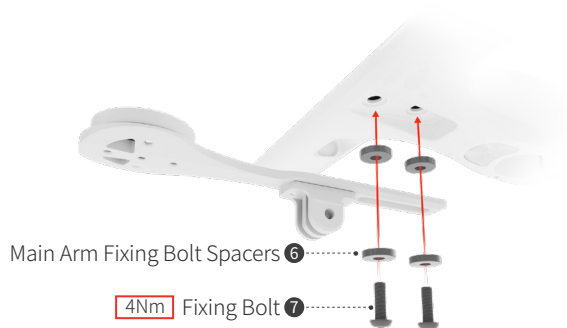
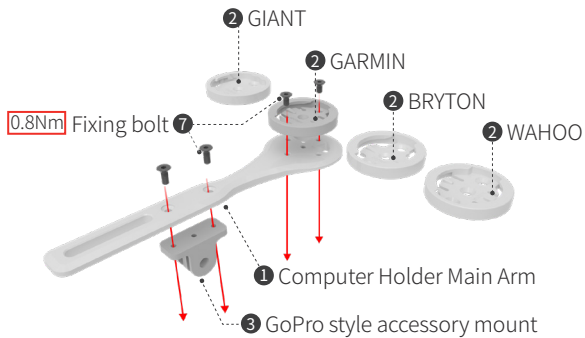
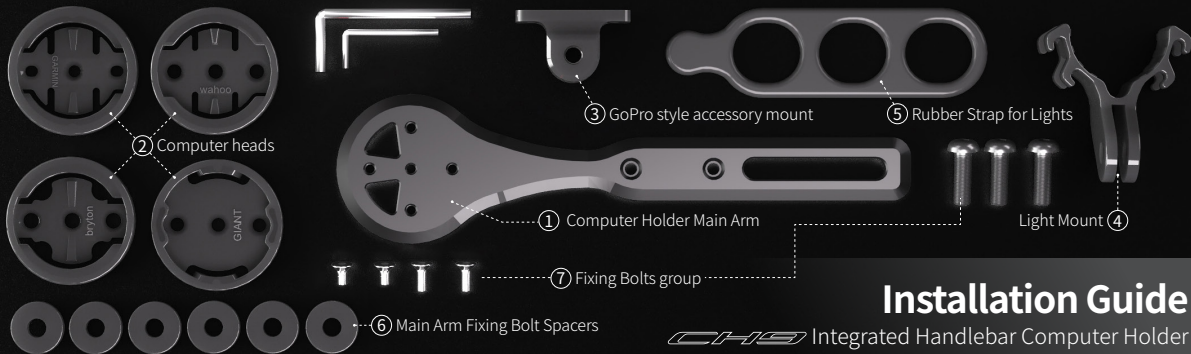

Installation Guide

CHS Integrated Handlebar Computer Holder

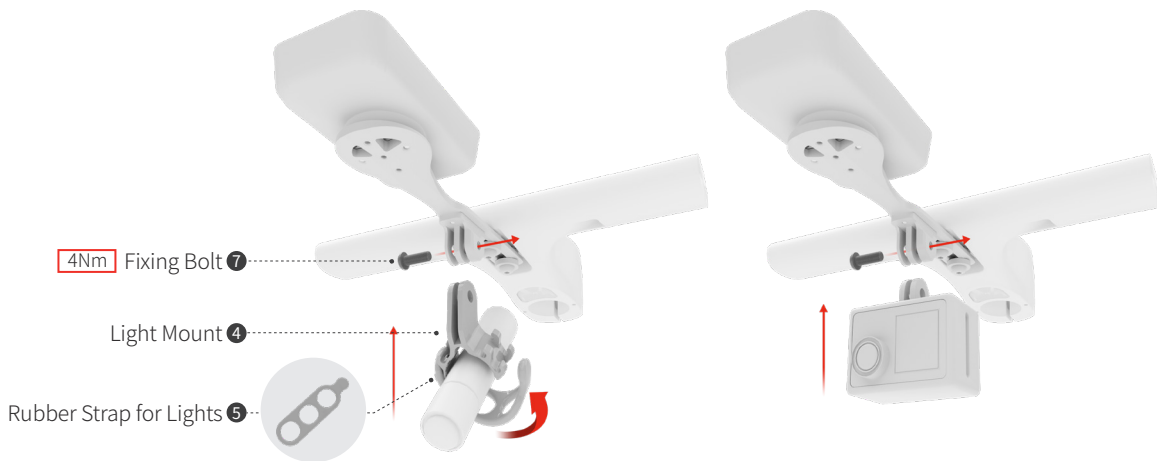

The background of the top half of the page features large, stylized Chinese characters in a dark grey, 3D-like font. The characters are arranged in a way that suggests the words '自由律' (Freedom Law) and '律由' (Law by). The 'YOELEO' logo is centered over these characters.

YOELEO