



JY-105/JY-105W Household oxygen concentrator Operation Instructions

Please read and understand this manual carefully before using the product

Key Points

Special warning:

In order to prevent power failure or oxygen generator failure, persons in urgent need of oxygen and Critically Ill Patient shall be provided

I. Before Installation

- Keep oxygen generator upright! Inclined angle is not more than 5 degree.
- If power supply voltage is not stable, exceeding the specified voltage, please use voltage regulator (1000W)! (Unstable power supply voltage normally occurs in the countryside)
- Please select safe and qualified socket and terminal block! (1100W better)
- Unprofessional person must not open the case!

II.Placement

- Oxygen generator shall be placed in a well-ventilated place and avoid direct sunshine, at least 10cm away from the wall and other objects.
- Oxygen generator shall not place in the following environment: near heat source, open fire and potential fire, wet, no shelter, temperature too high ($\geq 55^{\circ}\text{C}$), too low ($\leq -20^{\circ}\text{C}$).
- Never put any heavy object, sundries or container with water or oil on the oxygen generator.
- Never put sundries at the bottom of oxygen generator to avoid inlet and outlet from being blocked resulting in stoppage or oxygen concentration decrease because the temperature is too high.

III. In use

- Oxygen is inflammable, No smoking and far away from open fire and potential fire to avoid fire accident.
- Do not start oxygen generator frequently. Restart it in at least 30 seconds after it shuts down.
- Do not apply oil or grease on any part of oxygen generator to avoid oxygen from being polluted or avoid fire accident.

Product Characteristics

I. General

➤ Health Care

By means of supplying oxygen to the patient, oxygen status in the body can be improved to get health care, which is suitable for a middle-aged or elderly person, a person with poor health, pregnant women and students preparing for college entrance examination, who have different physiological hypoxia, It is also used to dissipate fatigue and restore body functions after heavy physical or mental labor.

II. Principle of oxygen supply and characteristics

Principle of oxygen supply

Household Oxygen Generator adopts international advanced technology PSA (Pressure Swing Adsorption), use air as raw material, power on at ambient temperature, absorb nitrogen by molecular sieve based on different molecular diameters, so oxygen with 90% purity can be separated from air for medical use.

Structural features

- All plastic shell, safe and reliable
- With time-consuming function: display the total working time through the display screen
- Equipped with timed shutdown function, easy to use
- Equipped with remote control function: it can operate the machine remotely and is easy to use
- The remote control is equipped with "call" button: one button call for help function. After pressing, the sound of "I need help" will be sent until pressing again.

Product Characteristics

III. Main Technical Data

- 1、 Power supply: AC220V±10%,AC230V±10%,AC110V±10%
50Hz 60Hz
- 2、 Output power: 150 (W)
- 3、 Oxygen concentration: 40%~90% (Adjustable by flow)
- 4、 oxygen flow: 1~7L/min
- 5、 Noise: ≤55dB (A)
- 6、 Net weight: 5.5kg
- 7、 Outline size: 305x180x300mm
- 8、 Safety system:
 - Current overload protection
 - High temperature of compressor, shutdown
- 9、 Electrical classification: II
- 10、 Operating mode: continuous
- 11、 Normal working environment
 - Ambient Temperature: 5°C-40°C;
 - Relative humidity: ≤80%;
 - Atmosphere pressure: 86kPa~106 kPa;

Note: When storage temperature is lower than 5°C, the equipment shall be placed at normal operating temperature for 4 hours before use.

Installation and Use

I. Unpacking for inspection

Before installation and operation, check if the appearance is good, if accessory range and number conform to Appendix List. If there is something missing, please contact local representative or the manufacturer.

II. Outline diagram and function introduction

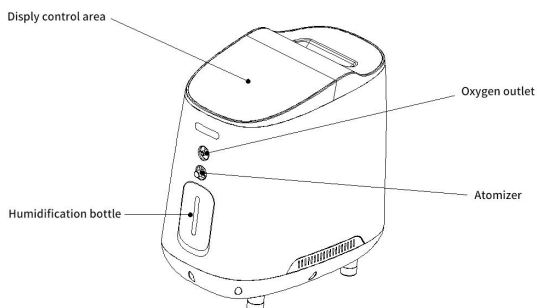

Figure 1: front side view of the whole machine

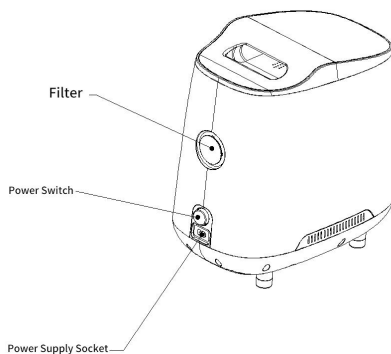

Figure 2: rear side view of the whole machine

Installation and Use

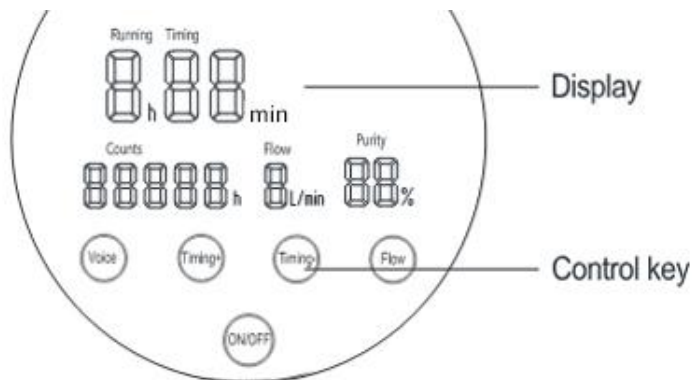

Figure 3: schematic diagram of display control area

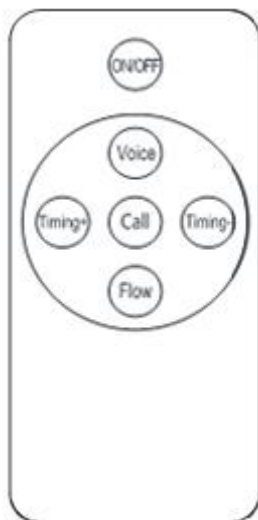
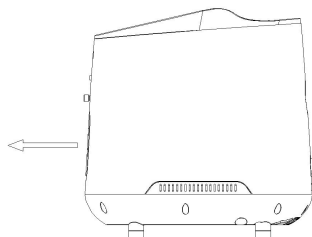

Figure 4: remote control

Installation and Use

III. Preparation

- Pull out the humidification bottle gently along the direction shown in the figure, pull out the rubber plug at the top and add cold the purified water of exceeding the maximum water level, (Figure 5)



Note: the water tank can be positive without adding water regular oxygen production

Figure 5

- Close the water tank with rubber plug, and replace the humidified water tank with the machine
- Connect the power supply, connect one end of the power line to the outlet hole of the oxygen generator, and the other end to the outlet with power output
- Press the power switch to "I", then enter the standby state. Press the "switch" key, then enter the normal operation state. When the oxygen generator is working, it makes a sound of "Chi ~" every few seconds, which is a normal breath sound.

IV. Oxygen Intake Operation

- Press the "flow" button in the control button area to adjust to the required flow rate. The oxygen outlet should have oxygen output..
- Connect oxygen pipe nozzle to oxygen outlet of moisture bottle. Adjust nasal tube to make the inhaler comfortable, then allow to inhale oxygen.

Installation and Use

V. Timing Function Operation

The generator has timing function. The user can set the time within 5 hours.

- At the initial startup, the display screen displays "working time", indicating that the timing shutdown function is not set and is in continuous operation until the switch is pressed to shut down.
- Press the "timing +" key to change the "working time" to "timing". Press the "timing +" key once to increase the display number by 10 minutes. Press the "timing -" key to decrease the display number by 10 minutes. If the timing key is not pressed, the timing will be fixed and decrease with the running time.
- After the set time, the oxygen generator will automatically shut down. At this time, the display screen displays "timing -- h -- min", press the on key to restart.

VI. Voice operation

- Press the "voice" button in the control button area to turn voice on and off.

VII. Shut down

- If it is necessary to stop oxygen absorption temporarily during use, press the "switch" key on the control panel to stop and start oxygen supply.
- After use, first press the "switch" key to stop oxygen production, then turn off the power switch, then unplug the power plug and cut off the power supply of the network.







Installation and Use

VIII. Wireless Remote Control

When oxygen generator is in normal operation or standby mode, start, shut down or adjust the oxygen generator by means of wireless remote control.

Note: the remote control should be in front of the machine.

IX. Symbols and meanings of safety requirements in this machine

Symbol	Signification	Symbol	Signification
	Alternating current		Consult the manual
	ON(power)		OFF(power)
	Keep up		Fragile
	Keep dry		

X. How to use the oxygen absorber

➤ Introduction to oxygen absorber

Nasal oxygen tube: can be hung on the ear, easy to operate, easy to use.

➤ Usage method

1. Before oxygen absorption, connect the connector end of the oxygen pipeline to the oxygen port, and the other end of the oxygen pipeline to the nasal oxygen pipe joint. Rotate the oxygen inhaler to an appropriate Angle and wear it as shown in figure 6

Installation and Use

2. Wearing method of nasal oxygen tube (see Fig. 6 and 7)



Figure 6



Figure 7

3. Oxygen head cleaning: wipe with medical alcohol.

4. Cleaning: generally once a week, it can be cleaned with a lighter detergent, and then washed with clean water. The water in the bottle should be dried before use.

XI. How to use the atomizer (JY-105W)

- Add the liquid medicine into the atomizing cup, insert the atomizing mouthpiece into the atomizing cup mouth; unscrew the atomizing mouth joint anticlockwise; connect the atomizing mouth and the atomizing cup with an air catheter, the atomizing cup begins to produce fog, the mouth contains the atomizing mouthpiece, and start the atomizing treatment with the mouth breathing

Maintenance and Service

Warning: before maintenance of the oxygen generator, first cut off the power supply. To avoid electric shock, do not disassemble the casing.

I. Clean the housing

Keep the housing clean: first power off, use wet and soft cloth immersed in sterilizing fluid to clean and prevent any liquid from going into the clearance of the housing.

II. Replace filter

The replacement of filter is very important to protect compressor and molecular sieve and prolong the service life of oxygen generator. Please replace it in time. If the concentrator has been used for 300 hours, the filter shall be replaced once.

Warning: do not operate the oxygen generator when the filter is not installed, which will damage the machine for a long time.

- Pull out the filter cover (see Figure 8);
- Pull out the filter and replace it with a new one (see Fig. 9).
- Press the filter cover back in place.
-

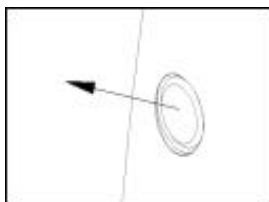

Figure 8

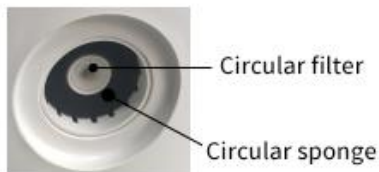

Figure 9

Maintenance and Service

The actual replacement time of the filter shall be determined according to the actual use time and environmental impact. If the filter element is blackened, it shall be replaced immediately regardless of the use time.

III. Clean the humidification water tank

- Water in the humidification water tank shall be replaced every day.
- Clean the humidification water tank once a week, and wash it with clean water repeatedly to ensure oxygen sanitation. When cleaning the humidification water tank, pay attention to clean the rubber plug.

Note: if there is scale or peculiar smell in the water tank due to long time of cleaning or water change, soak it in white vinegar for more than half an hour, shake it vigorously, clean it and then rinse it with water.

- Disassemble the humidification water tank
 - (1) Pull out the humidification water tank along the direction shown in the figure (Figure 10)
 - (2) Remove the rubber plug (Figure 11)

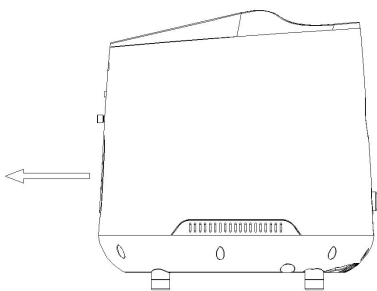

Figure 10

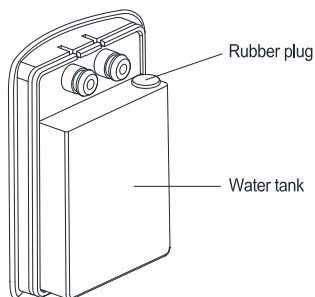

Figure 11

Maintenance and Service

IV. Wash oxygen pipe

- Normally, oxygen pipe shall be washed three times a day. Nosal head of oxygen pipe shall be washed after each use. Immerse it in white vinegar for 5 minutes and then wash it with water or clean it with medical alcohol. It is suggested to replace oxygen pipe once every two months.

Note: keep the inside of oxygen pipe dry, without any water.

V. Replace fuse

- First, cut off the power supply. The fuse holder is located at the bottom of the machine. Use a cross screwdriver to screw out the fuse holder cover anticlockwise, and then take it out for replacement.

(Note: fuse model:220V~:T1.6AL250V/ 110V~:T2.5AL250V, $\Phi 5 * 20$)

VI. Common troubleshooting guide

Fault phenomenon	Possible causes	Elimination method
The oxygen generator has power supply, but the machine does not work and the display does not show	1) Fuse of power supply is broken	1) Replace fuse tube
	2) Insufficient power at power outlet	2) Do not use extension cords to move the concentrator to another power outlet or circuit
	3) If the concentrator is still not working, contact the equipment supplier or manufacturer	

Maintenance and Service

The oxygen generator works, but there is little or no air output at the oxygen inlet	1) Kinked or blocked oxygen pipeline	1) Straighten out the pipeline
	2) The rubber plug of the humidification bottle is not covered tightly or is missing	2) Retighten
	3) Blocked humidification water tank	3) Clean the humidification water tank
	4) Filter dirty	4) Replace filter
	5) Contact supplier or manufacturer if persistent	
The oxygen generator has power supply, but the machine does not work, and the display shows "fault"	1) Compressor overheating protection, shutdown	1) Shut down and restart the machine after it cools down
	2) If this condition persists, stop using the machine and contact the equipment supplier or manufacturer immediately	

Note: if the failure of oxygen generator cannot be eliminated, please contact the supplier or manufacturer

Other Notes

I. Air line principle:

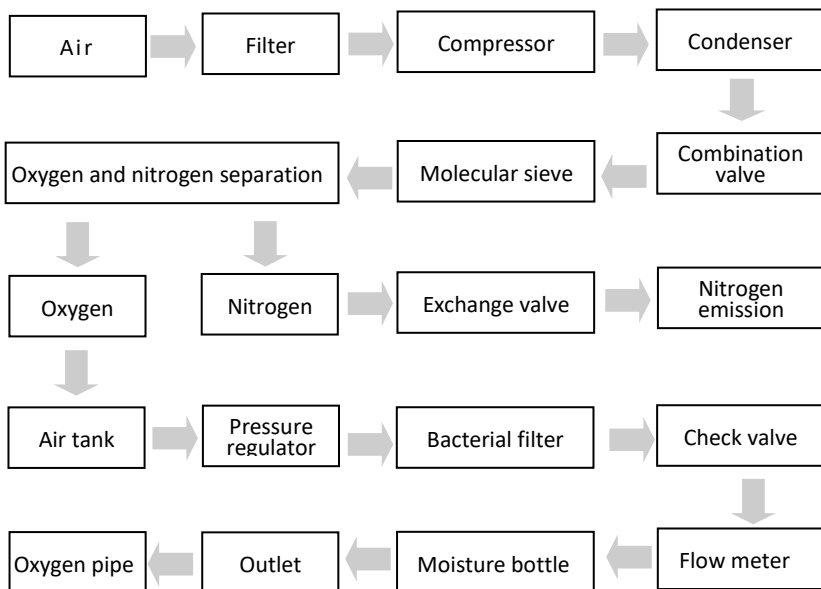

II. Use electromagnetic environment guidance

In order to avoid the interference of the machine by the strong electromagnetic environment or other electrical products, please keep the machine at least 1m away from other household appliances in use

III. Non professionals are not allowed to disassemble the case of the oxygen generator. If professional maintenance personnel need the electrical schematic diagram of the product, please contact the manufacturer or after-sales service point

IV. After-sale service

- If the oxygen generator is used and kept in normal conditions, it can be repaired or replaced free of charge if there is any quality problem within half a year since it is sold. In half a year, if there is any fault, repair it free of charge. In one year, if there is any fault, the company provides parts for which have to be paid and repairs free of charge.
- Beyond guarantee scope: (1) Damages caused by human factors, including use under abnormal operating environment, damages caused by non-compliance with user's manual and improper storage. (2) The customer disassembles, maintains, refits at will or any unauthorized company repairs; (3) Damages caused by improper transportation after it is sold; (4) Loss caused by force majeure (flood, fire, lightning strike and earthquake).
- If necessary, circuit diagram and documents for maintenance. If there is any question about electric circuit troubleshooting, please contact the manufacturer.

V. Packing list

1、Oxygenator	1 set
2、Power cord	1roots
3、Nasal oxygen tube	1sets
4、Filter	2sets
5、Fuse	2sets
6、Instruction	1copy

VI. Disposal of waste and residue

The disposal of wastes and residues shall conform to the relevant national laws and regulations.