

# 智能并网逆变器GTB-1200使用说明

## 参数表

型号	GTB-1200	
最大输入功率	1200Watt	
MPP跟踪电压	22-50V	
最小/最大启动电压	22-50V	
最大DC短路电流	60A	
最大输入工作电流	54.5A	
<b>输出参数</b>	<b>@120V</b>	<b>@230V</b>
输出峰值功率	1200Watt	1200Watt
额定输出功率	1200Watt	1200Watt
额定输出电流	10A	5.2A
额定电压范围	80-160VAC	180-280VAC
额定频率范围	48-51Hz/58-61Hz	48-51Hz/58-61Hz
功率因素	>99%	
每串电路连接台数	3台 (单相)	5台 (单相)
<b>输出效率</b>	<b>@120V</b>	<b>@230V</b>
MPP跟踪效率	99.5%	99.5%
最大输出效率	95%	95%
夜间损耗功率	<1W	<1W
总谐波失真	<5%	<5%
<b>外观及技术特点</b>		
工作温度范围	-40°C to +60°C	
尺寸 (长×宽×高)	365mm×300mm×40mm	
重量	2.81kg	
防水等级	IP65	
散热方式	自冷	
通讯模式	Wi-Fi通讯	
电力传输模式	逆向传输, 负载优先使用	
监控系统	手机APP	
电磁兼容	EN50081_part1 EN50082.Part1	
电网扰动	EN61000-3-2 安规EN62109	
电网检测	CE,EN-50438	
证书	CE,	

## 注意事项

- ★请按说明正确安装逆变器, 如有疑问请与相关人员联系。
- ★非专业人员请勿拆机, 只有合格的维修人员才可以修理本产品。
- ★请将逆变器安装在低湿度和通风良好的地方, 以避免逆变器过热, 并清除周围易燃物品。
- ★使用本产品时, 避免小孩子触摸、玩耍, 以免触电。
- ★只能连接太阳能电池板。

## 产品配件

1. 用户手册1份;
2. 逆变器固定螺丝1包;
3. AC连接线1根;

## LED显示说明

1. 红灯长亮3秒-----开机红灯长亮3秒, 设备进入正常工作状态;
2. 绿灯快闪-----MPPT搜索;
3. 绿灯慢闪-----MPPT+功率微调;
4. 红灯慢闪-----MPPT-功率微调;
5. 绿灯亮3秒, 灭0.5秒---MPPT锁定;
6. 红灯长亮-----a. 孤岛保护; b. 温度保护; c. AC电压过、欠压保护; d. DC电压过、欠压保护; e. 故障;

注:

正常工作指示灯闪烁过程: 逆变器连接上AC、DC端 → 红灯长亮3秒 → 绿灯快闪(MPPT搜索) → 绿灯慢闪(MPPT+功率微调)/红灯慢闪(MPPT-功率微调)/绿灯亮3秒, 灭0.5秒(MPPT锁定)。

## 逆变器安装指南

**第一步** 用本机附带的螺丝将逆变器安装在光伏板的支架上, 如下图所示:

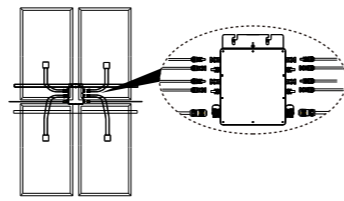

**第三步** 打开逆变器AC输出接头的防水盖并将AC连接线连接到AC防水插头上, 连接方法如插头连接图:

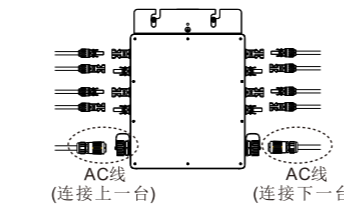

**第四步** 将AC输出线连接到AC主电缆上;

**第五步** 重复第一至第三步, 安装并连接好所有的逆变器;

**第六步** 将AC主电缆连接到市电电网。

**第二步** 将光伏板上的DC连接MC4插头正反连接到逆变器的DC输入端, 如下图所示:

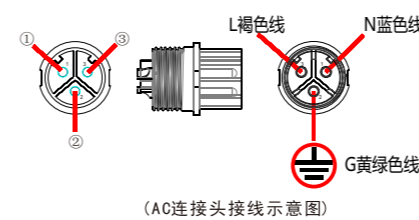
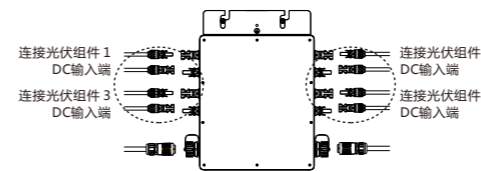

## 智能光伏系统架构

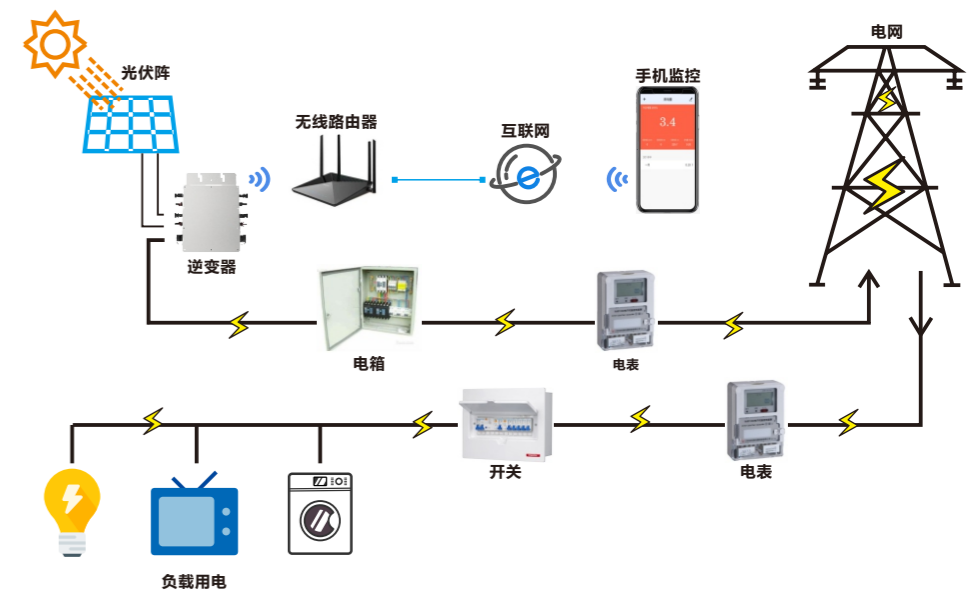

## 单相接法

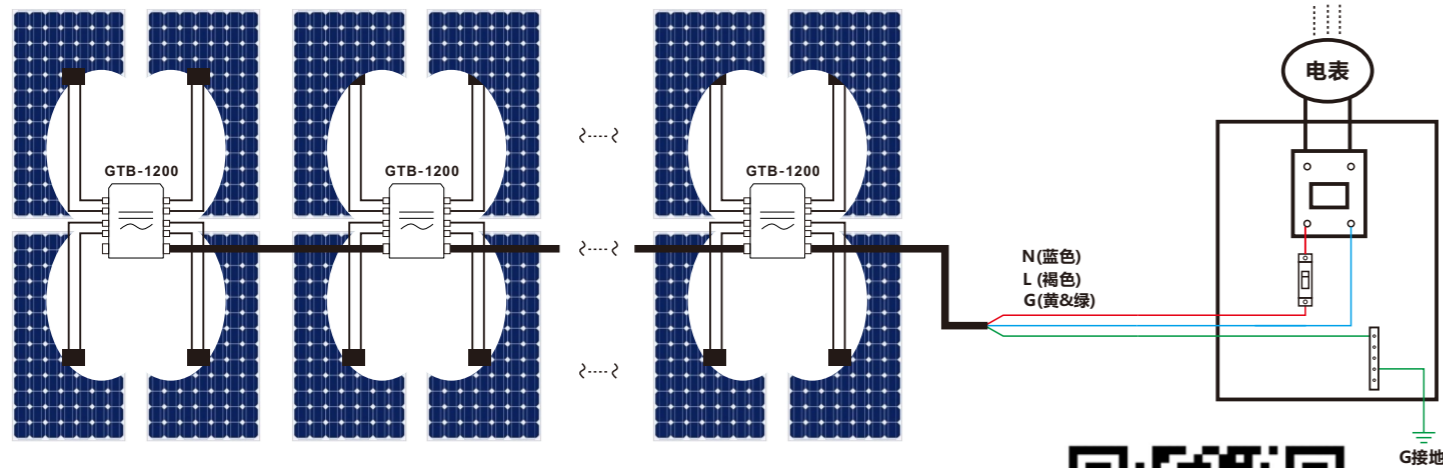

## 三相接法

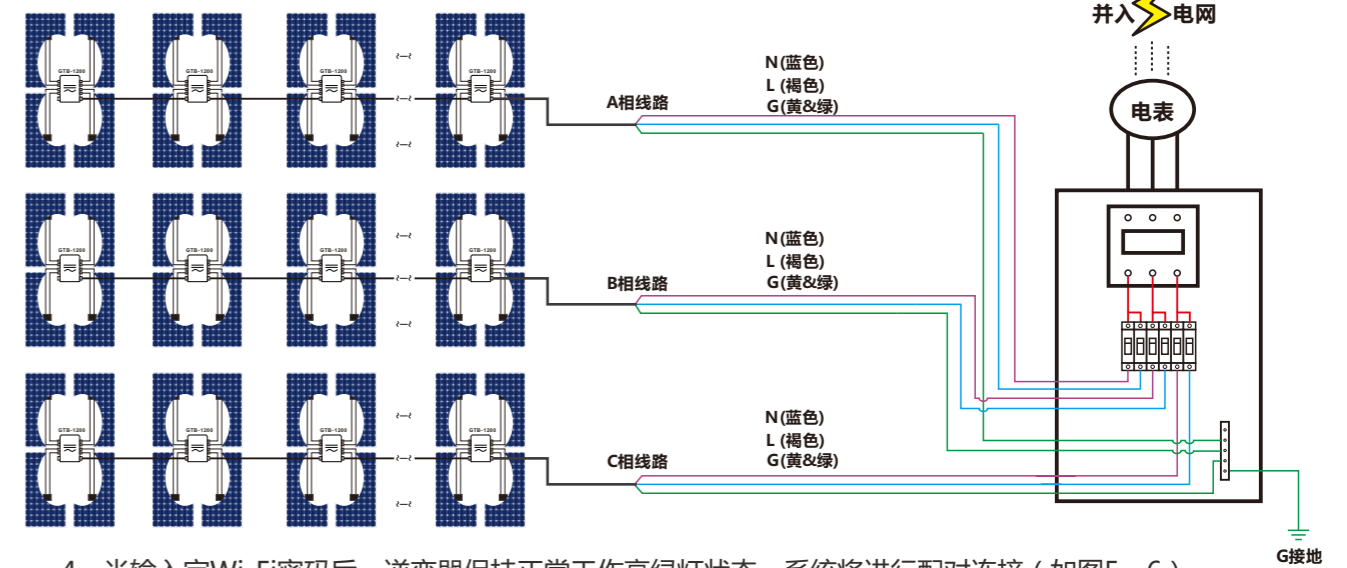

## 智能光伏监控系统操作步骤

- 1、在手机应用程序下载 '智能家居' 或直接扫码右侧二维码并安装监控系统APP (支持安卓及IOS系统多国语言);
- 2、点击创建新用户进行帐号注册;
- 3、提示输入家庭中的Wi-Fi密码时, 请输入Wi-Fi密码并确认;



- 4、当输入完Wi-Fi密码后, 逆变器保持正常工作亮绿灯状态, 系统将进行配对连接 (如图5、6)
  - 5、逆变器正确添加后, 并且光伏系统是在并网中正常运行时, 将显示为逆变器已开启 (如图6)
  - 6、如逆变器没在当前网络中运行, 则显示为逆变器关闭 (如图7)
  - 7、点击各台逆变器, 将可查看逆变器各项数据统计, 更多功能请在APP中点击进行查阅
- 备注: 安装多台逆变器app监控操作步骤一样。(该系统是为未来LOT物联网5g时代而设计, 与所有家用电器兼容。)

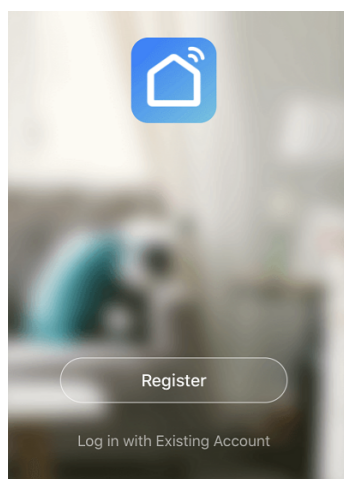

(图1)

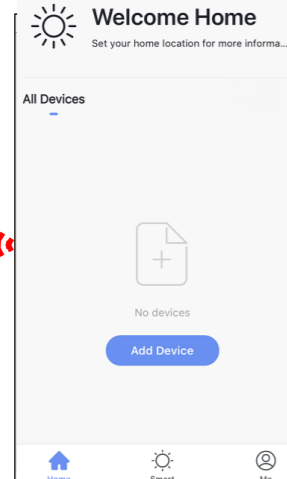

(图2)

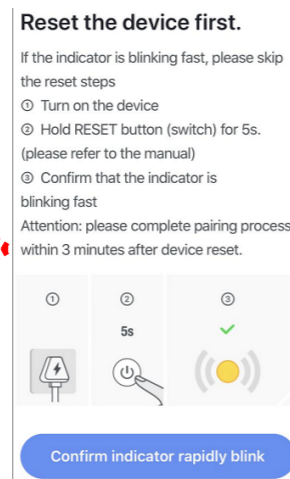

(图3)

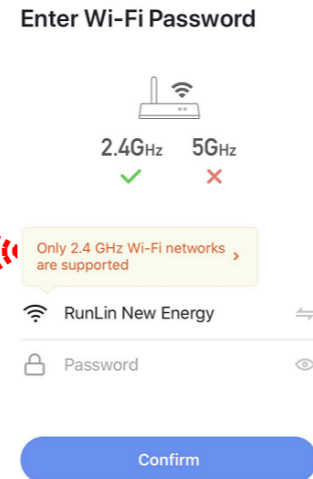

(图4)

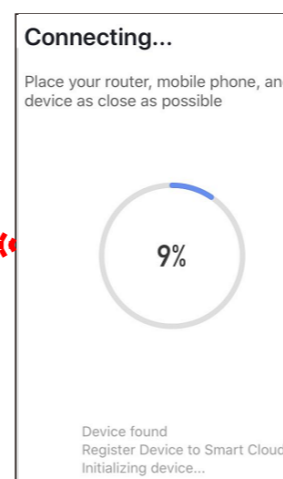

(图5)

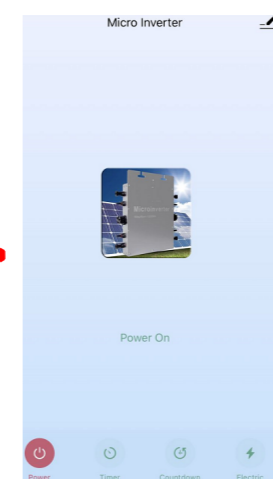

(图6)

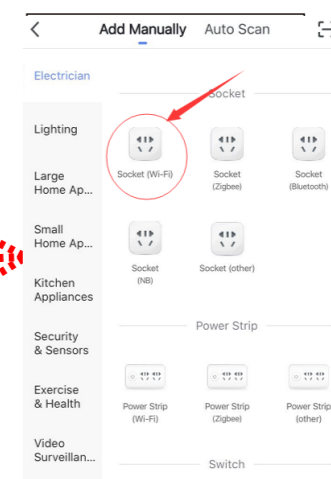

(图7)

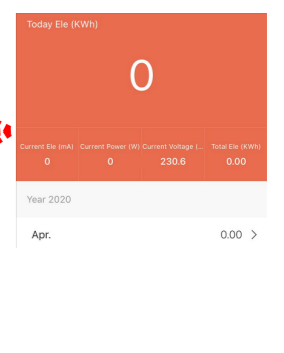

(图8)

# SMART GRID INVERTER GTB-1200 Manual

## Parameter Table

Model	GTB-1200	
Maximum input power	1200Watt	
Peak power tracking voltage	22-50V	
Min / max starting voltage	22-55V	
Maximum DC short-circuit	60A	
Maximum input operating current	54.5A	
<b>Output Data</b>	<b>@ 120V</b>	<b>@ 230V</b>
Peak power output	1200Watt	1200Watt
Rated output power	1200Watt	1200Watt
Rated output current	10A	5.2A
Rated voltage range	80-160VAC	180-260VAC
Rated frequency range	48-51/58-61Hz	48-51/58-61Hz
Power Factor	>99%	>99%
Max unit per branch circuit	3pcs (Single-phase)	
<b>Output Efficiency</b>	<b>@ 120V</b>	<b>@ 230V</b>
Static MPPT efficiency	99.5%	99.5%
Maximum output efficiency	95%	95%
Night time power consumption	<1W	<1W
THD	<5%	<5%
<b>Exterior &amp; Feature</b>		
Ambient temperature range	-40°C to +60°C	
Dimensions (L x W x H)	365mmx300mmx40mm	
Weight	2.81kg	
Waterproof rating	IP65	
Cooling	Self-cooling	
Communication Mode	WiFi mode	
Power transmission mode	Reverse transfer, load priority	
Monitoring System	Mobile APP, PC browser	
Electromagnetic Compatibility	EN50081.part1 EN50082.Part1	
Grid disturbance	EN61000-3-2 Safety EN62109	
Grid detection	CE EN-50438	
Certificate	CE,	

## Notes:

- ★Please connect the inverter following the operation instruction show above. If have any question please contact with relative persons.
- ★Non-professionals do not disassemble. Only qualified personnel may repair this product.
- ★Please install inverter in the low humidity and well-ventilated place to avoid the inverter over-heating and clear around the inflammable and explosive materials.
- ★When using this product, avoid children touching, playing, to avoid electric shock.
- ★Connected solar panels, battery or wind generators DC input DC power supply cable.

## Accessories for product:

1. One warranty card;
2. One user manual;
3. One certificate of quality;
4. 1 pouch of screw for micro inverter installation;
5. One AC Cable;

## LED Display

1. Red light 3 second---Red LED light 3 second while device starts, then in working condition;
  2. Green flash fast---MPPT searching;
  3. Green flash slow---MPPT + searching;
  4. Red flash slow---MPPT - searching;
  5. Green lights on 3s and off 0.5s---MPPT locked;
  6. Red light steady---a. Islanding protection; b. Over-temperature protection; c. Over / low AC voltage protection; d. Over / low DC voltage protection; e. Fault
- Remarks:  
LED flashing in the process of being working condition: inverters connected to AC & DC sides → Red LED light 3 second → Green LED flash fast (MPPT searching) → Green LED flash slow (MPPT + searching) / Red LED flash slow (MPPT - searching) / Green LED lights on 3s and off 0.5s (MPPT locked).

**Step1** Installation for fixed the inverter on the PV holder with the screws attached is as following:

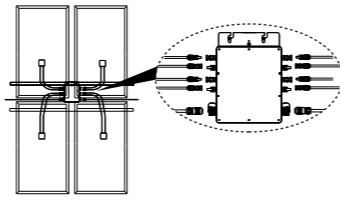

**Step2** Connect the DC terminal of the PV to the inverter, positive to positive, negative to negative. Show below:

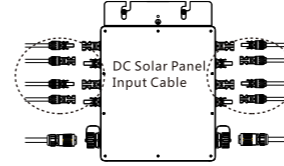

**Step3** Open the waterproof cap on AC output side of the micro inverter, then plug to AC power line. Show below:

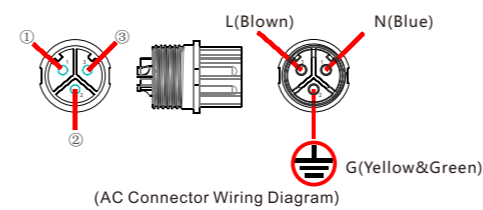
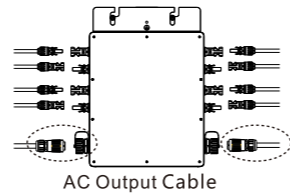

**Step4** Plug the AC output line to main AC cable;

**Step5** Repeat the first step to the third step to complete the installation of micro inverters;

**Step6** Finally, please connect the AC main cable to the utility grid.

## Structure of Solar power system

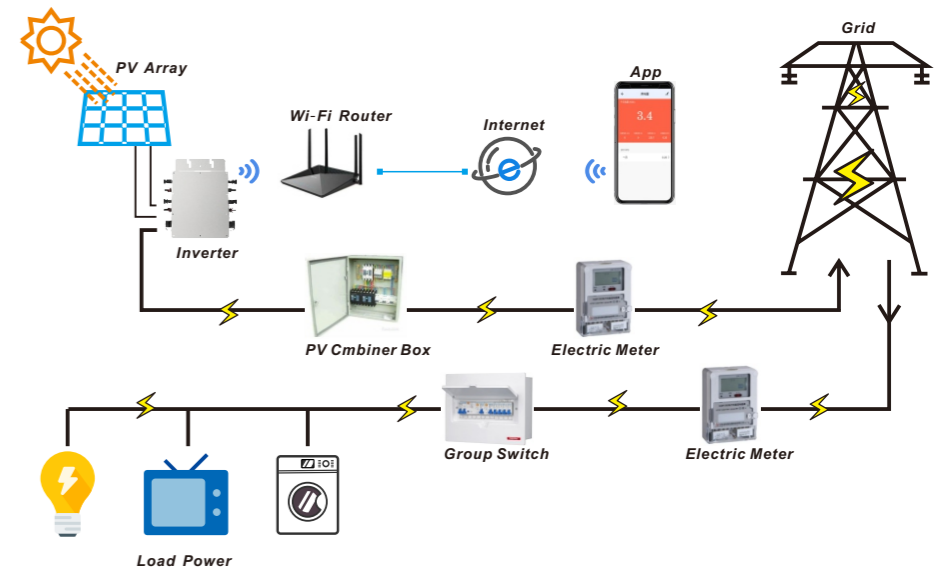

## Single-Phase Connection

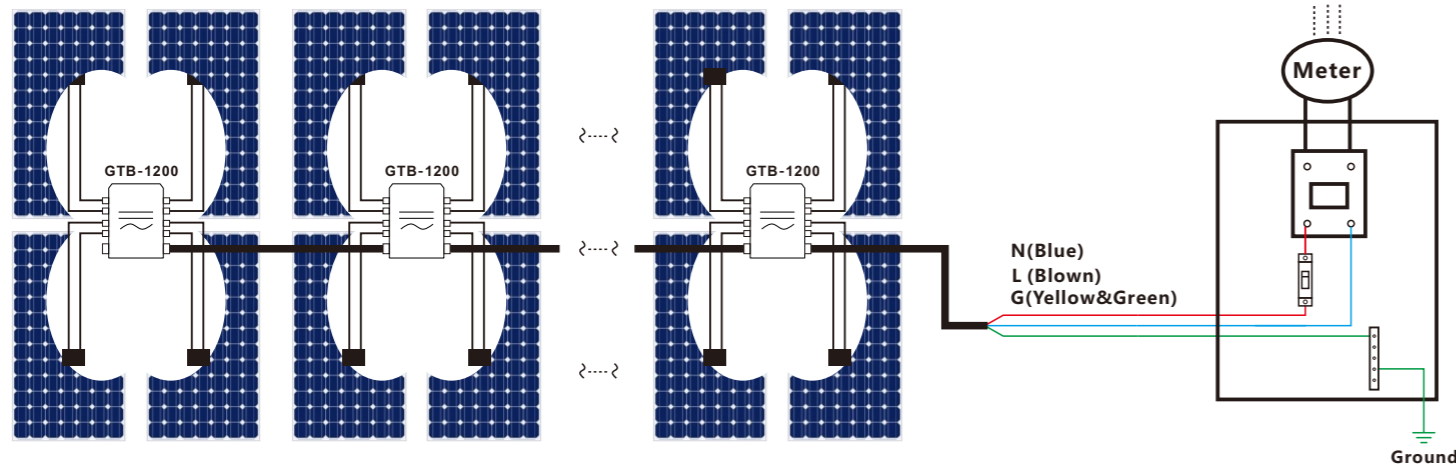

## Three-Phase Connection

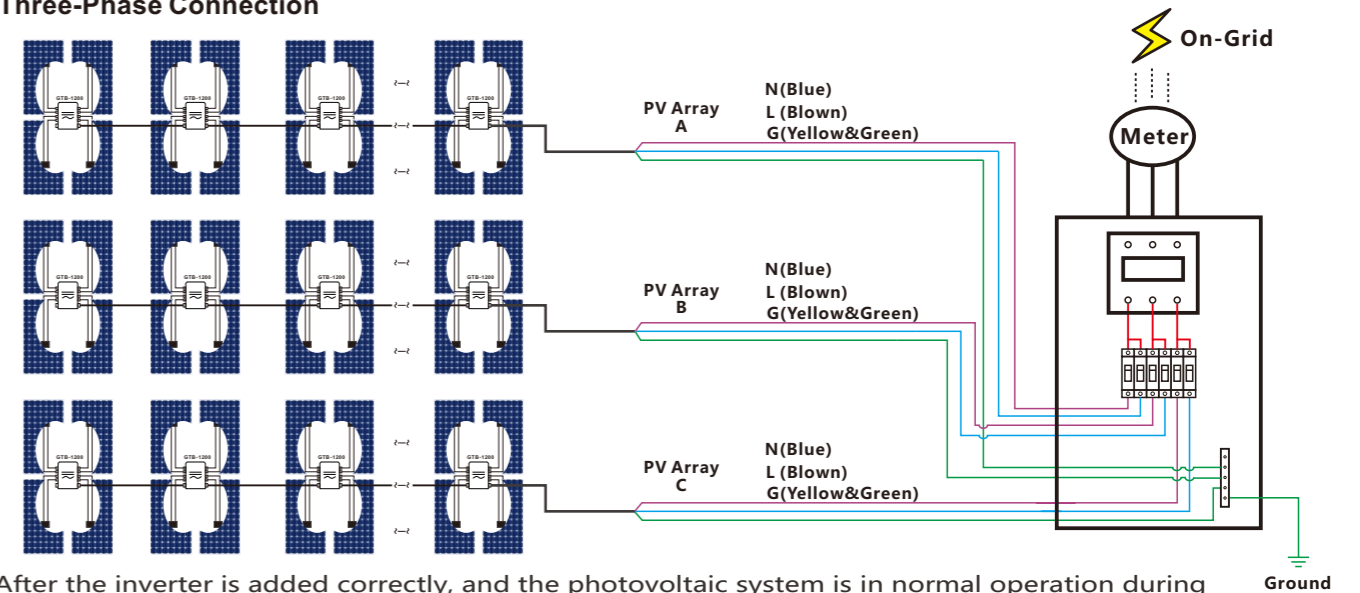

## PV Monitoring System Operating Instructions

1. Download 'smart home' or direct scan code to the right qr code and install the monitoring system app(the multi-language language of the ios system);
2. Click and create the new user to register the account;
3. Please enter the password and confirm the password when you enter the password in the family.
4. After entering the wi-fi password, the inverter will remain in the normal working green light state, and the system will make a paired connection (as shown in figure 5 and 6).



Before installation, switch on AC power for APP monitoring and debugging.

5. After the inverter is added correctly, and the photovoltaic system is in normal operation during grid-connection, it will be shown that the inverter is turned on (see figure 6.)
  6. If the inverter is not running in the current network, it will be shown as the inverter is closed (see figure 7).
  7. click each inverter, will be able to view the inverter data statistics, more functions, please click in the APP to check
- Note: install multiple inverter app monitoring operation procedure. (the system is designed for the future lot of Internet 5g, with all home appliances compatible)

(1) Register screen with 'Register' button.

(2) 'Welcome Home' screen with 'Add Device' button.

(3) 'Reset the device first.' screen with 'Confirm indicator rapidly blink' button.

(4) 'Enter Wi-Fi Password' screen showing 2.4GHz and 5GHz options, with 'Confirm' button.

(5) 'Connecting...' screen showing 9% progress and 'Device found Register Device to Smart Cloud Initializing device...'.

(6) 'Power On' screen showing the inverter is online.

(7) 'Add Manually' screen showing device selection options like 'Socket (Wi-Fi)', 'Socket (2ghz)', etc.

(8) Summary screen showing 'Today Ele (kWh)' as 0 and 'Year 2020' data.