

4KVA/5KVA Parallel Installation Guide

1. Introduction

This inverter can be used in parallel with two different operation modes.

1. Parallel operation in single phase with up to 6 units. The supported maximum output power is 24KW/30KVA.
2. Maximum six units work together to support three-phase equipment. Four units support one phase maximum. The supported maximum output power is 24KW/30KVA and one phase can be up to 16KW/20KVA.

NOTE: If this unit is bundled with share current cable and parallel cable, this inverter is default supported parallel operation. You may skip section 3. If not, please purchase parallel kit and install this unit by following instruction from professional technical personnel in local dealer.

2. Package Contents

In parallel kit, you will find the following items in the package:



Parallel board



Parallel communication cable



Current sharing cable

3. Parallel board installation

This installation steps are only applied to 4K/5K models.

Step 1: Remove wire cover by unscrewing all screws.

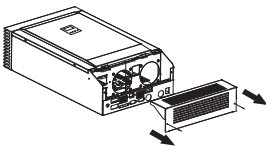

Step 2: Remove communication board by unscrewing two screws as below chart.

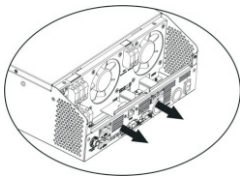

Step 3: Remove two screws as below chart and remove 2-pin and 14-pin cables. Take out the board under the communication board.

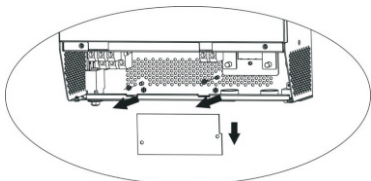

Step 4: Remove two screws as below chart to take out cover of parallel communication.

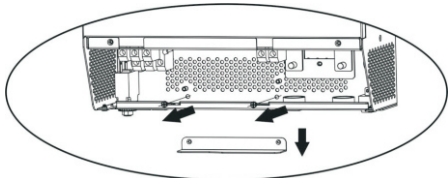

Step 5: Install new parallel board with 2 screws tightly.

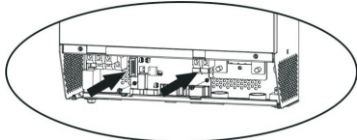

Step 6: Re-connect 2-pin and 14-pin to original position.

Parallel board

Communication board

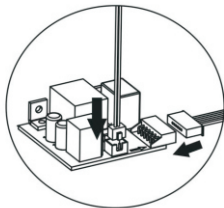
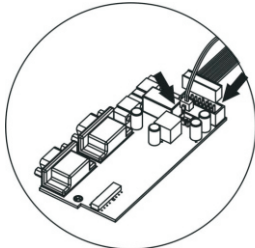

Step 7: Put communication board back to the unit.

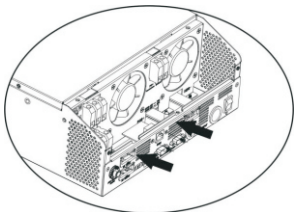

Step 8: Put wire cover back to the unit. Now the inverter is providing parallel operation function.

4. Mounting the Unit

When installing multiple units, please follow below chart.

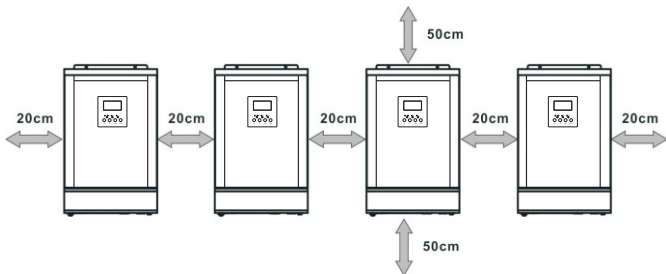

NOTE: For proper air circulation to dissipate heat, allow a clearance of approx. 20 cm to the side and approx. 50 cm above and below the unit. Be sure to install each unit in the same level.

5. Wiring Connection

The cable size of each inverter is shown as below:

Recommended battery cable and terminal size for each inverter:

Model	Wire Size	Cable mm ²	Ring Terminal Dimensions		Torque value
			D (mm)	L (mm)	
4KVA	1*4AWG	22	6.4	33.2	2~ 3 Nm
	2*8AWG	14	6.4	29.2	
5KVA	1*4AWG	22	6.4	33.2	2~ 3 Nm
	2*8AWG	14	6.4	29.2	

Ring terminal:

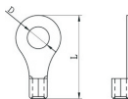

WARNING: Be sure the length of all battery cables is the same. Otherwise, there will be voltage difference between inverter and battery to cause parallel inverters not working.

Recommended AC input and output cable size for each inverter:

Model	AWG no.	Torque
4KVA	10 AWG	1.4~1.6Nm
5KVA	8 AWG	1.4~1.6Nm

You need to connect the cables of each inverter together. Take the battery cables for example: You need to use a connector or bus-bar as a joint to connect the battery cables together, and then connect to the battery terminal. The cable size used from joint to battery should be X times cable size in the tables above. "X" indicates the number of inverters connected in parallel.

Regarding AC input and output, please also follow the same principle.

CAUTION!! Please install the breaker at the battery and AC input side. This will ensure the inverter can be securely disconnected during maintenance and fully protected from over current of battery or AC input. The recommended mounted location of the breakers is shown in the figures in 5-1 and 5-2.

Recommended breaker specification of battery for each inverter:

Model	1 unit*
4KVA	80A/60VDC
5KVA	100A/60VDC

*If you want to use only one breaker at the battery side for the whole system, the rating of the breaker should be X times current of 1 unit. "X" indicates the number of inverters connected in parallel.

Recommended breaker specification of AC input with single phase:

Model	2 units	3 units	4 units	5 units	6 units
4KVA	80A/230VAC	120A/230VAC	160A/230VAC	200A/230VAC	240A/230VAC
5KVA	100A/230VAC	150A/230VAC	200A/23VAC	250A/23VAC	300A/23VAC

Note1: Also, you can use 40A breaker (50A for 5KVA) for only 1 unit, and each inverter has a breaker at its AC input.

Note2: Regarding three phase system, you can use 4 poles breaker, the rating is up to the current of the phase which has the maximum units. Or you can follow the suggestion of note 1.

Recommended battery capacity

Inverter parallel numbers	2	3	4	5	6
Battery Capacity	400AH	600AH	800AH	1000AH	1200AH

WARNING! Be sure that all inverters will share the same battery bank. Otherwise, the inverters will transfer to fault mode.

5-1. Parallel Operation in Single phase

Two inverters in parallel:

Power Connection

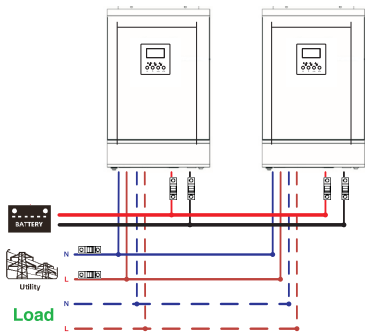

Communication Connection



Three inverters in parallel:

Power Connection

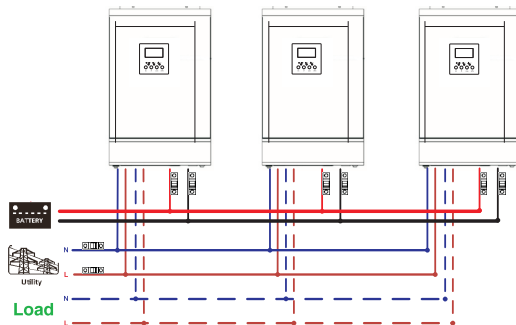

Communication Connection

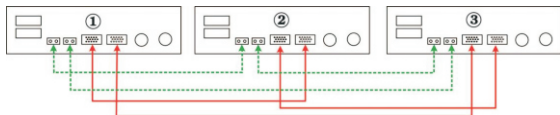

Four inverters in parallel:

Power Connection

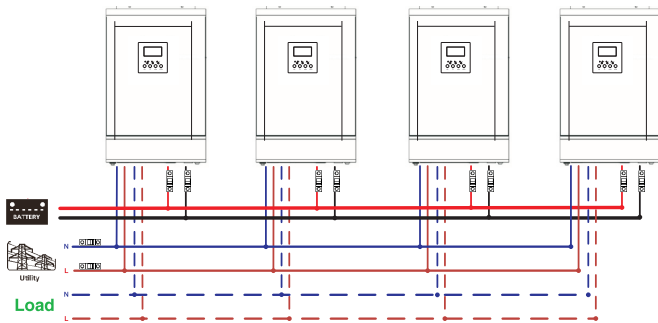

Communication Connection

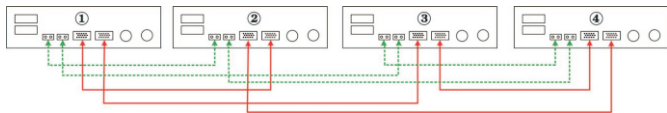

Five inverters in parallel:

Power Connection

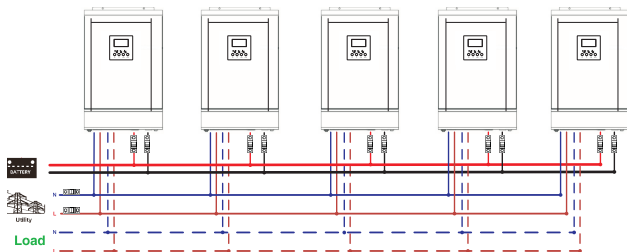

Communication Connection



Six inverters in parallel:

Power Connection

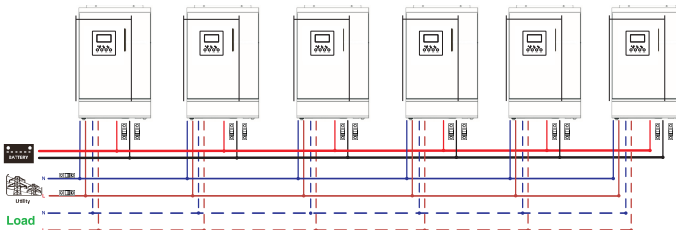

Communication Connection



5-2. Support 3-phase equipment

Two inverters in each phase:

Power Connection

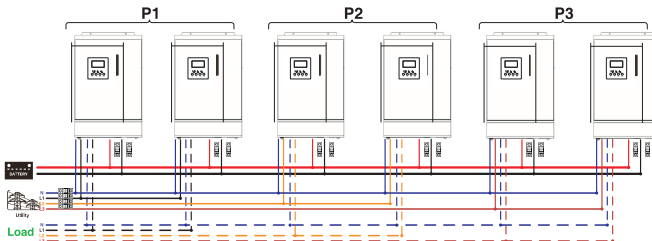

Communication Connection

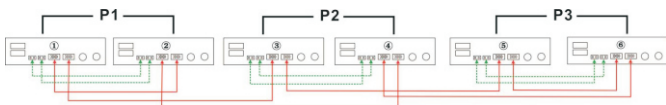

Four inverters in one phase and one inverter for the other two phases:

Power Connection

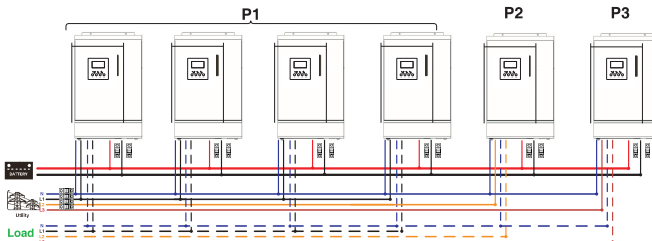

Note: It's up to customer's demand to pick 4 inverters on any phase.

P1: L1-phase, P2: L2-phase, P3: L3-phase.

Communication Connection

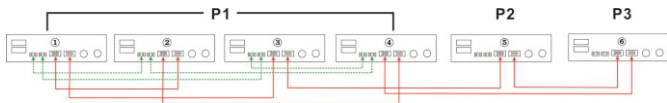

Three inverters in one phase, two inverters in second phase and one inverter for the third phase:

Power Connection

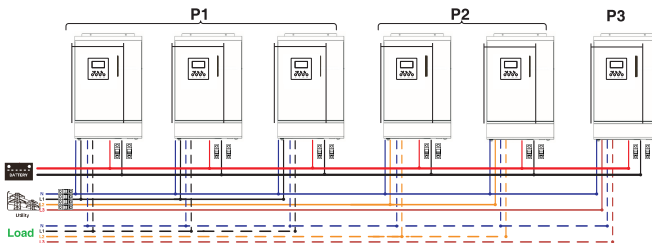

Communication Connection

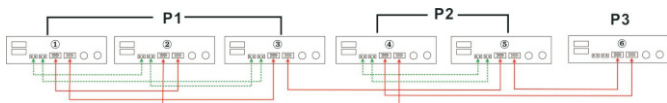

Three inverters in one phase and only one inverter for the remaining two phases:

Power Connection

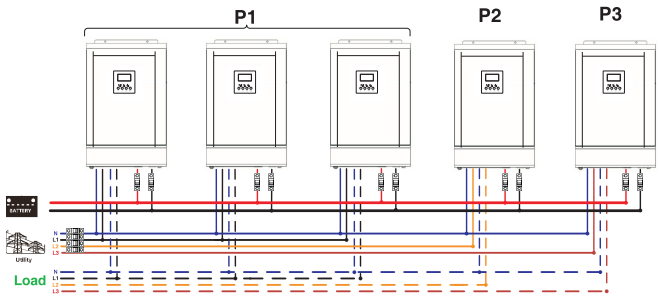

Communication Connection

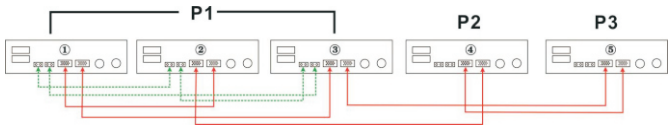

Two inverters in two phases and only one inverter for the remaining phase:

Power Connection

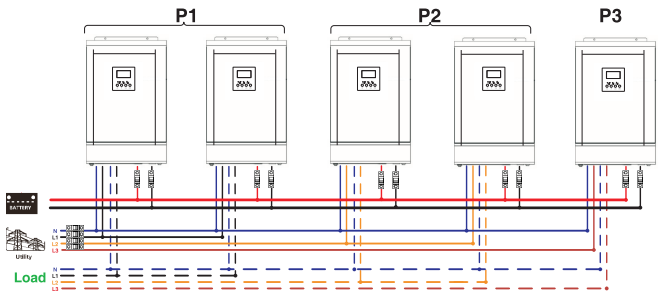

Communication Connection

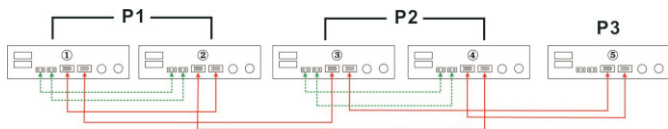

Two inverters in one phase and only one inverter for the remaining phases:

Power Connection

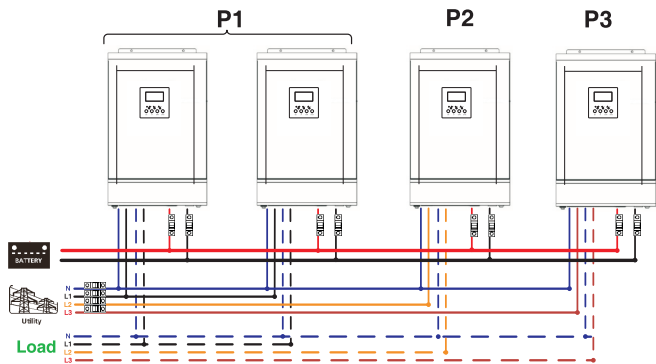

Communication Connection

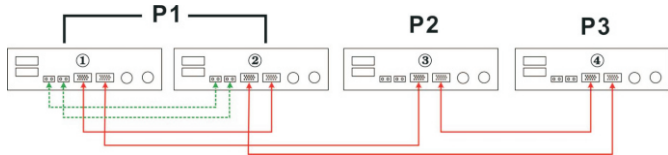

One inverter in each phase:

Power Connection

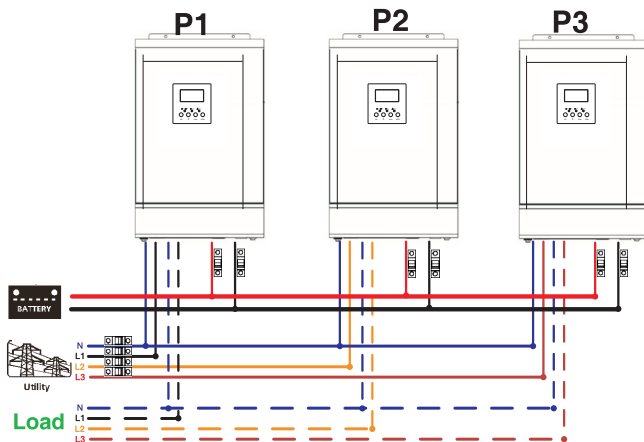

Communication Connection

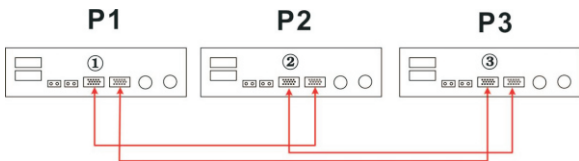

WARNING: Do not connect the current sharing cable between the inverters which are in different phases. Otherwise, it may damage the inverters.



6. PV Connection

Please refer to user manual of single unit for PV Connection.







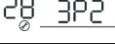
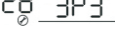



CAUTION: Each inverter should connect to PV modules separately.

7. LCD Setting and Display

Setting Program:

Program	Description	Selectable option	
28	AC output mode *This setting is only available when the inverter is in standby mode (Switch on, later Switch off).	Single: 	When the units are used in parallel with single phase, please select "PAL" in program 28.
		Parallel: 	It is required to have at least 3 inverters or maximum 6 inverters to support three-phase equipment. It's required to have at least one inverter in each phase or it's up to four inverters in one phase. Please refers to 5-2 for detailed information.
		L1 phase: 	Please select "3P1" in program 28 for the inverters connected to L1 phase, "3P2" in program 28 for the inverters connected to L2 phase and "3P3" in program 28 for the inverters connected to L3 phase.
		L2 phase: 	Be sure to connect share current cable to units which are on the same phase. Do NOT connect share current cable between units on different phases.
		L3 phase: 	Besides, power saving function will be automatically disabled.

Fault code display:

Fault Code	Fault Event	Icon on
60	Power feedback protection	
71	Firmware version inconsistent	
72	Current sharing fault	
80	CAN fault	
81	Host loss	
82	Synchronization loss	
83	Battery voltage detected different	
84	AC input voltage and frequency detected different	
85	AC output current unbalance	
86	AC output mode setting is different	

8. Commissioning

Parallel in single phase





Step 1: Check the following requirements before commissioning:

- Correct wire connection
- Ensure all breakers in Line wires of load side are open and each Neutral wires of each unit are connected together.

Step 2: Turn on each unit and set "PAL" in LCD setting program 28 of each unit. And then shut down all units.

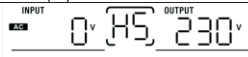
NOET: It's necessary to turn off switch when setting LCD program. Otherwise, the setting can not be programmed.

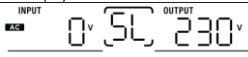
Step 3: Turn on each unit.

LCD display in Master unit	LCD display in Slave unit
 	 

NOTE: Master and slave units are randomly defined.

Step 4: Switch on all AC breakers of Line wires in AC input. It's better to have all inverters connect to utility at the same time. If not, it will display fault 82 in following-order inverters. However, these inverters will automatically restart. If detecting AC connection, they will work normally.

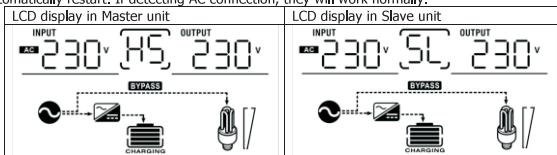

Step 5: If there is no more fault alarm, the parallel system is completely installed.

Step 6: Please switch on all breakers of Line wires in load side. This system will start to provide power to the load.

Support three-phase equipment

Step 1: Check the following requirements before commissioning:

- Correct wire connection
- Ensure all breakers in Line wires of load side are open and each Neutral wires of each unit are connected together.

Step 2: Turn on all units and configure LCD program 28 as P1, P2 and P3 sequentially. And then shut down all units.

NOET: It's necessary to turn off switch when setting LCD program. Otherwise, the setting can not be programmed.

Step 3: Turn on all units sequentially.

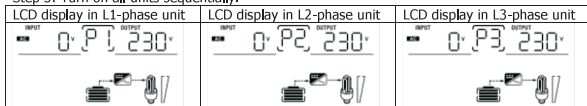

Step 4: Switch on all AC breakers of Line wires in AC input. If AC connection is detected and three phases are matched with unit setting, they will work normally. Otherwise, the AC icon will flash and they will not work in line mode.

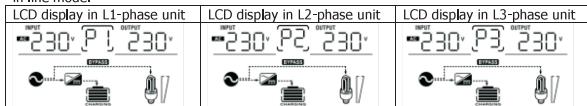

Step 5: If there is no more fault alarm, the system to support 3-phase equipment is completely installed.

Step 6: Please switch on all breakers of Line wires in load side. This system will start to provide power to the load.

Note 1: To avoid overload occurring, before turning on breakers in load side, it's better to have whole system in operation first.

Note 2: Transfer time for this operation exists. Power interruption may happen to critical devices, which cannot bear transfer time.

9. Trouble shooting

Situation		Solution
Fault Code	Fault Event Description	
60	Current feedback into the inverter is detected.	<ol style="list-style-type: none"> Restart the inverter. Check if L/N cables are not connected reversely in all inverters. For parallel system in single phase, make sure the sharing are connected in all inverters. For supporting three-phase system, make sure the sharing cables are connected in the inverters in the same phase, and disconnected in the inverters in different phases. If the problem remains, please contact your installer.
71	The firmware version of each inverter is not the same.	<ol style="list-style-type: none"> Update all inverter firmware to the same version. Check the version of each inverter via LCD setting and make sure the CPU versions are same. If not, please contact your installer to provide the firmware to update. After updating, if the problem still remains, please contact your installer.
72	The output current of each inverter is different.	<ol style="list-style-type: none"> Check if sharing cables are connected well and restart the inverter. If the problem remains, please contact your installer.
80	CAN data loss	<ol style="list-style-type: none"> Check if communication cables are connected well and restart the inverter. If the problem remains, please contact your installer.
81	Host data loss	
82	Synchronization data loss	
83	The battery voltage of each inverter is not the same.	<ol style="list-style-type: none"> Make sure all inverters share same groups of batteries together. Remove all loads and disconnect AC input and PV input. Then, check battery voltage of all inverters. If the values from all inverters are close, please check if all battery cables are the same length and same material type. Otherwise, please contact your installer to provide SOP to calibrate battery voltage of each inverter. If the problem still remains, please contact your installer.
84	AC input voltage and frequency are detected different.	<ol style="list-style-type: none"> Check the utility wiring connection and restart the inverter. Make sure utility starts up at same time. If there are breakers installed between utility and inverters, please be sure all breakers can be turned on AC input at same time. If the problem remains, please contact your installer.
85	AC output current unbalance	<ol style="list-style-type: none"> Restart the inverter. Remove some excessive loads and re-check load information from LCD of inverters. If the values are different, please check if AC input and output cables are in the same length and material type. If the problem remains, please contact your installer.
86	AC output mode setting is different.	<ol style="list-style-type: none"> Switch off the inverter and check LCD setting #28. For parallel system in single phase, make sure no 3P1, 3P2 or 3P3 is set on #28. For supporting three-phase system, make sure no "PAL" is set on #28. If the problem remains, please contact your installer.

技术要求:

- 1: 材质: 80克书写纸, 黑白印刷;
- 2: 装订后成品尺寸: **104*145** (公差+/-2MM);
- 3: 印刷效果: 图片、字体、线条需清晰, 无重影, 无毛边, 无多余杂点;