

# All-in-one solar charge inverter

## User Manual



Product models:

HF4830S60 | HF4840S60 | HF4850S80

HF4825U60 | HF4830U60 | HF4835U80

## **Important safety instructions**

### **Please keep this manual for future use.**

This manual contains all safety, installation and operating instructions for the HF Series all-in-one solar charge inverter.

Please read all instructions and precautions in the manual carefully before installation and use.

- Non-safety voltage exists inside the all-in-one solar charge inverter. To avoid personal injury, users shall not disassemble the all-in-one solar charge inverter themselves. Contact our professional maintenance personnel if there is a need for repair.
- Do not place the all-in-one solar charge inverter within the reach of children.
- Do not install the all-in-one solar charge inverter in harsh environments such as moist, oily, flammable or explosive, or heavily dusty areas.
- The mains input and AC output are high voltage, so please do not touch the wiring terminals.
- The housing of the all-in-one solar charge inverter is hot when it is working. Do not touch it.
- Do not open the terminal protective cover when the all-in-one solar charge inverter is working.
- It is recommended to attach proper fuse or circuit breaker to the outside of the all-in-one solar charge inverter.
- Always disconnect the fuse or circuit breaker near the terminals of PV array, mains and battery before installing and adjusting the wiring of the all-in-one solar charge inverter.
- After installation, check that all wire connections are tight to avoid heat accumulation due to poor connection, which is dangerous.
- The all-in-one solar charge inverter is off-grid. It is necessary to confirm that it is the only input device for load, and it is forbidden to use it in parallel with other input AC power to avoid damage.

# Contents

1. General information.....	4
1.1 Product overview and features.....	4
1.2 Basic system introduction.....	5
1.3 Appearance.....	6
2. Installation instructions.....	7
2.1 Installation precautions.....	7
2.2 Wiring specifications and circuit breaker selection.....	8
2.3 Installation and wiring.....	11
3. Operating modes.....	17
3.1 Charging mode.....	17
3.2 Output mode.....	18
4. LCD screen operating instructions.....	19
5. Other functions.....	29
5.1 Dry node.....	29
5.2 RS485 communication port.....	29
5.3 CAN communication port (optional).....	29
5.4 USB communication port.....	29
6. Protection.....	31
6.1 Protections provided.....	31
6.2 Fault code meaning.....	32
6.3 Handling measures for part of faults.....	33
7. System maintenance.....	34
8. Technical parameters.....	35

# 1. General information

## 1.1 Product overview and features

HF series is a new all-in-one hybrid solar charge inverter, which integrates solar energy storage & means charging energy storage and AC sine wave output. Thanks to DSP control and advanced control algorithm, it has high response speed, high reliability and high industrial standard. Four charging modes are optional, i.e. Only Solar, Mains Priority, Solar Priority and Mains & Solar hybrid charging; and two output modes are available, i.e. Inverter and Mains, to meet different application requirements. The solar charging module applies the latest optimized MPPT technology to quickly track the maximum power point of the PV array in any environment and obtain the maximum energy of the solar panel in real time.

Through a state of the art control algorithm, the AC-DC charging module realizes fully digital voltage and current double closed loop control, with high control precision in a small volume. Wide AC voltage input range and complete input/output protections are designed for stable and reliable battery charging and protection.

Based on full-digital intelligent design, the DC-AC inverter module employs advanced SPWM technology and outputs pure sine wave to convert DC into AC. It is ideal for AC loads such as household appliances, power tools, industrial equipment, and electronic audio and video equipment. The product comes with a segment LCD display design which allows real-time display of the operating data and status of the system. Comprehensive electronic protections keep the entire system safer and more stable.

### **Features:**

1. Full digital voltage and current double closed loop control, advanced SPWM technology, output of pure sine wave.
2. Two output modes: mains bypass and inverter output; uninterrupted power supply.
3. Available in 4 charging modes: Only Solar, Mains Priority, Solar Priority and Mains & Solar hybrid charging.
4. Advanced MPPT technology with an efficiency of 99.9%.
5. Designed with a LCD screen and 3 LED indicators for dynamic display of system data and operating status.
6. ON/OFF rocker switch for AC output control.
7. Power saving mode available to reduce no-load loss.
8. Intelligent variable speed fan to efficiently dissipate heat and extend system life.
9. Lithium battery activation design, allowing access of lead-acid battery and lithium battery.
10. 360 ° all-round protection with a number of protection functions.
11. Complete protections, including short circuit protection, over voltage and under voltage protection, overload protection, reverse protection, etc.

## 1.2 Basic system introduction

The figure below shows the system application scenario of this product. A complete system consists of the following parts:

1. PV module: Convert light energy into DC power, and charge the battery through the all-in-one solar charge inverter, or directly invert into AC power to drive the load.
  2. Mains or generator: Connected at the AC input, to power the load while charging the battery. If the mains or generator is not connected, the system can also operate normally, and the load is powered by the battery and PV module.
  3. Battery: Provided to ensure normal power supply to the system loads when solar energy is insufficient and the Mains is not connected.
  4. Household load: Allow connection of various household and office loads, including refrigerators, lamps, TVs, fans and air conditioners.
  5. All-in-one solar charge inverter: The energy conversion unit of the whole system.
- Specific system wiring method depends on the actual application scenario.

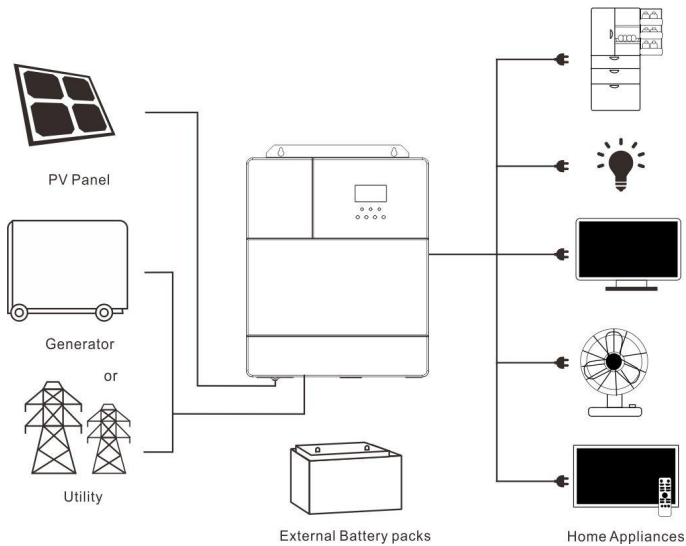

### 1.3 Appearance

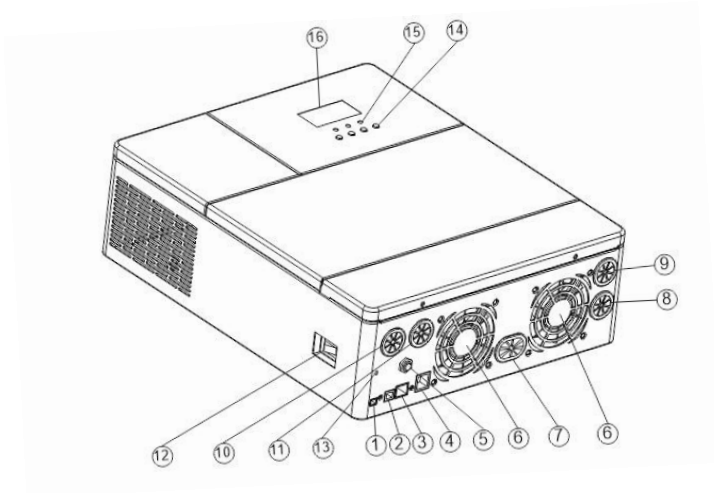

①	CAN communication port	⑨	PV1 port
②	USB communication port	⑩	AC input port
③	RS485 communication port	⑪	AC output port
④	Dry node port	⑫	ON/OFF rocker switch
⑤	Overload protector	⑬	Grounding screw hole
⑥	Cooling fan	⑭	Touch button
⑦	Battery port	⑮	Indicator
⑧	PV2 port	⑯	LCD screen

# 2. Installation instructions

## 2.1 Installation precautions

Please read this manual carefully prior to installation to familiarize yourself with the installation steps.

- Be very careful when installing the battery. Wear safety goggles when installing a lead-acid liquid battery. Once coming into contact with the battery acid, rinse with clean water timely.
- Do not place metal objects near the battery to prevent short-circuit of the battery.
- Acid gas may be generated when the battery is charged. So, please ensure good ventilation.
- When installing the cabinet, be sure to leave enough space around the all-in-one solar charge inverter for heat dissipation. Do not install the all-in-one solar charge inverter and lead-acid battery in the same cabinet to avoid corrosion by acid gas generated during battery operation.
- Only the battery that meets the requirements of the all-in-one unit can be charged.
- Poorly connected connections and corroded wires may cause great heat which will melt the wire insulation, burn the surrounding materials, and even cause fires. So, make sure the connectors have been tightened, and the wires are secured with ties to avoid looseness of connections caused by shaking of wires during mobile application.
- The system connection wires are selected according to a current density of not more than 5 A/mm<sup>2</sup>.
- Avoid direct sunlight and rainwater infiltration for outdoor installation.
- Even after the power is turned off, there is still high voltage inside the unit. Do not open or touch the internal components, and avoid related operations until the capacitor completely discharges.
- Do not install the all-in-one solar charge inverter in harsh environments such as moist, oily, flammable or explosive, or heavily dusty areas.
- Polarity at the battery input end of this product shall not be reversed, otherwise it may damage the device or cause unpredictable danger.
- The mains input and AC output are high voltage, so please do not touch the wiring terminals.
- When the fan is working, do not touch it to prevent injury.
- Load equipment input power needs to confirm that this all-in-one solar charge inverter is the only input device, and it is forbidden to use in parallel with other input AC power to avoid damage. It is necessary to confirm that the solar charge inverter is the only input device for load equipment, and it is forbidden to use it in parallel with other input AC power to avoid damage.

## 2.2 Wiring specifications and circuit breaker selection

Wiring and installation must comply with national and local electrical codes.

Recommended PV array wiring specifications and circuit breaker selection: Since the output current of the PV array is affected by the type, connection method and illumination angle of the PV module, the minimum wire diameter of the PV array is calculated according to its short-circuit current; refer to the short-circuit current value in the PV module specification (the short-circuit current is constant when the PV modules are connected in series; the short-circuit current is the sum of the short-circuit currents of all PV modules connected in parallel); the short-circuit current of the PV array shall not exceed the maximum input current.

➤ **Refer to the table below for PV input wire diameter and switch:**

Models	Recommended battery wiring	Maximum PV input current	Recommended air switch or circuit breaker
HF4830S60	10mm <sup>2</sup> /7AWG	50A	2P—63A
HF4840S60	10mm <sup>2</sup> /7AWG	50A	2P—63A
HF4850S80	10mm <sup>2</sup> /7AWG	50A	2P—63A
HF4825U60	10mm <sup>2</sup> /7AWG	50A	2P—63A
HF4830U60	10mm <sup>2</sup> /7AWG	50A	2P—63A
HF4835U80	10mm <sup>2</sup> /7AWG	50A	2P—63A

Note: The voltage in series shall not exceed the maximum PV input open circuit voltage of 145V.



➤ **Refer to the table below for recommended AC input wire diameter and switch:**

Models	Recommended battery wiring	Maximum bypass input	Recommended air switch or circuit breaker
HF4830S60	10mm <sup>2</sup> /7AWG	40A	2P—40A
HF4840S60	10mm <sup>2</sup> /7AWG	40A	2P—40A
HF4850S80	10mm <sup>2</sup> /7AWG	40A	2P—40A
HF4825U60	10mm <sup>2</sup> /7AWG	40A	2P—40A
HF4830U60	10mm <sup>2</sup> /7AWG	40A	2P—40A
HF4835U80	10mm <sup>2</sup> /7AWG	40A	2P—40A

Note: There is already an appropriate circuit breaker at the Mains input wiring terminal, so it is not necessary to add one more.

➤ **Recommended battery input wire diameter and switch selection**

Models	Recommended battery wiring	Rated battery discharge current	Maximum charge current	Recommended air switch or circuit breaker
HF4830S60	20mm <sup>2</sup> /4AWG	85A	120A	2P—140A
HF4840S60	25mm <sup>2</sup> /3AWG	110A	120A	2P—160A
HF4850S80	30mm <sup>2</sup> /2AWG	125A	140A	2P—200A
HF4825U60	20mm <sup>2</sup> /4AWG	75A	90A	2P—120A
HF4830U60	20mm <sup>2</sup> /4AWG	85A	90A	2P—120A
HF4835U80	25mm <sup>2</sup> /3AWG	100A	140A	2P—160A

➤ **Recommended AC output wiring specifications and circuit breaker selection**

Models	Recommended battery wiring	Rated inverter AC output current	Maximum bypass output	Recommended air switch or circuit breaker
HF4830S60	10mm <sup>2</sup> /7AWG	13A	40A	2P—40A
HF4840S60	10mm <sup>2</sup> /7AWG	17.5A	40A	2P—40A
HF4850S80	10mm <sup>2</sup> /7AWG	22A	40A	2P—40A
HF4825U60	10mm <sup>2</sup> /7AWG	21A	40A	2P—40A
HF4830U60	10mm <sup>2</sup> /7AWG	25A	40A	2P—40A
HF4835U80	10mm <sup>2</sup> /7AWG	30A	40A	2P—40A

Note: The wiring diameter is for reference only. If the distance between the PV array and the all-in-one solar charge inverter or the distance between the all-in-one solar charge inverter and the battery is relatively long, using a thicker wire can reduce the voltage drop to improve system performance.

Note: The above are only recommended wiring diameter and circuit breaker. Please select the appropriate wiring diameter and circuit breaker according to actual situations.

## 2.3 Installation and wiring

### Installation steps: :

**Step 1:** Determine the installation position and the space for heat dissipation. Determine the installation position of the all-in-one solar charge inverter, such as wall surface; when installing the all-in-one solar charge inverter, ensure that there is enough air flowing through the heat sink, and space of at least 200mm to the left and right air outlets of the inverter shall be left to ensure natural convection heat dissipation. Refer to the installation diagram of the whole machine as above.



Warning: Danger of explosion! Never install the all-in-one solar charge inverter and lead-acid battery in the same confined space! Also do not install in a confined place where battery gas may collect.

**Step 2:**  
Remove  
terminal

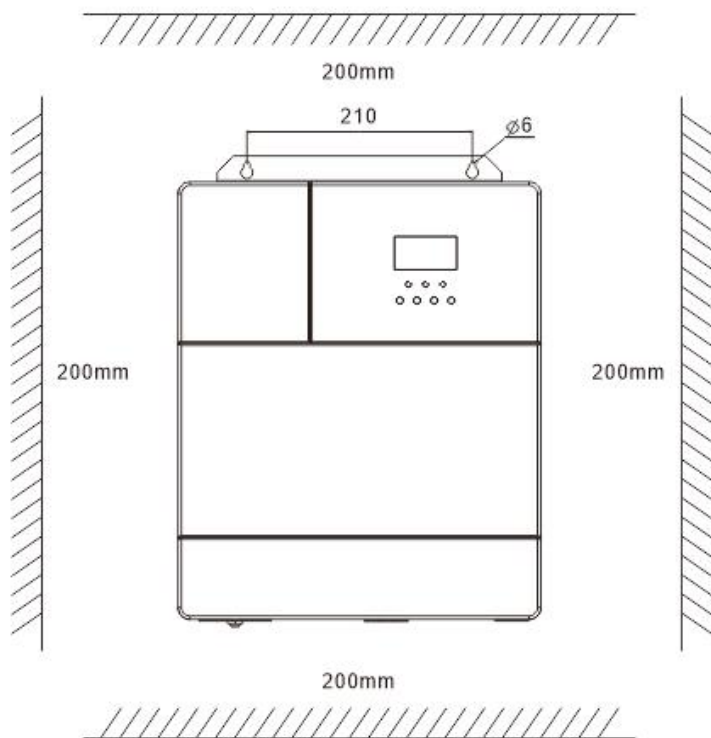

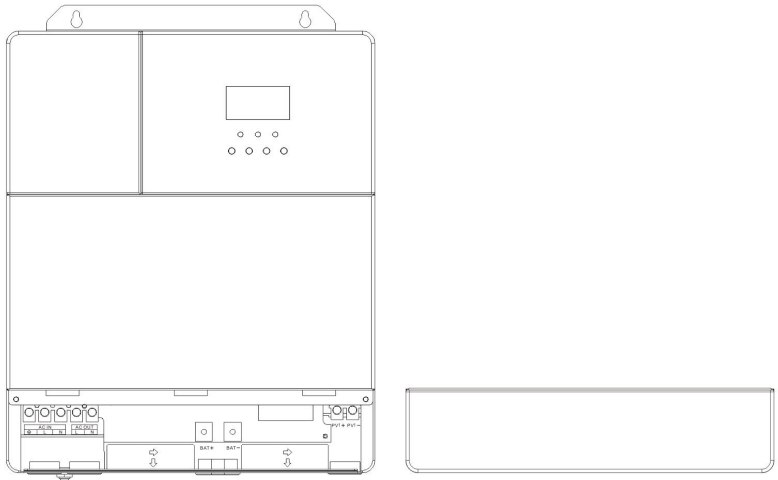

### Step3: Wiring

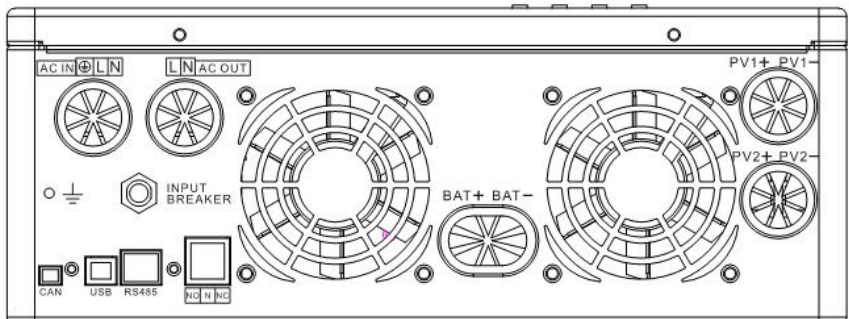

#### AC input / output wiring method:

- ① Prior to AC input/output wiring, disconnect the external circuit breaker and confirm that the wire used is thick enough. Please refer to Section 2.2 “Wiring Specifications and Circuit Breaker Selection” ;
- ② Properly connect the AC input wire according to the wire sequence and terminal position shown in the figure below. Please connect the ground wire first, and then the live wire and the neutral wire;

 : **Ground**    **L** : **Live**    **N** : **Neutral**

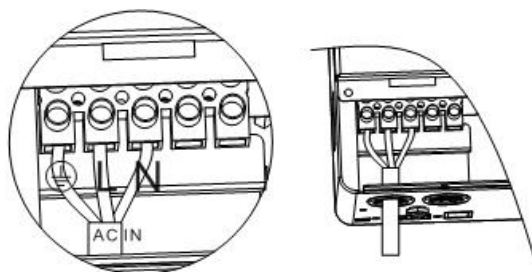

③ Properly connect the AC output wire according to the wire sequence and terminal position shown in the figure below. Please connect the ground wire first, and then the live wire and the neutral wire. The ground wire is connected to the grounding screw hole on the cabinet through the O-type terminal.

⏚ : **Ground**    **L** : **Live**    **N** : **Neutral**

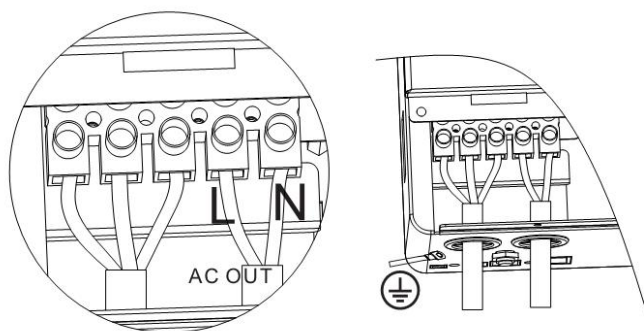

Note: The grounding wire shall be as thick as possible (cross-sectional area is not less than 4mm<sup>2</sup>). The grounding point shall be as close as possible to the all-in-one solar charge inverter. The shorter the grounding wire, the better.

**PV input wiring method:**

① Prior to wiring, disconnect the external circuit breaker and confirm that the wire used is thick enough. Please refer to Section 2.2 "Wiring Specifications and Circuit Breaker Selection" ;

② Properly connect the PV input wire according to the wire sequence and terminal position shown in the figure below. The PV1 port is the preferred port for wiring and the PV2 port is an optional expansion port. It is invalid to connect a standard machine to the PV2 port.

**PV1+:PV1 input positive pole**

**PV1-:PV1input negative pole**

**PV2+:PV1 input positive pole**

**PV2-:PV1 input negative pole**

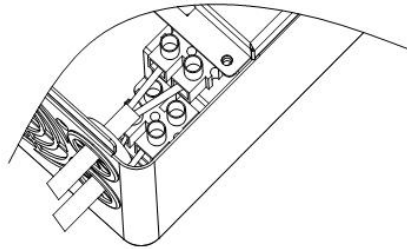
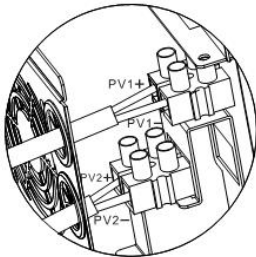

**BAT wiring method:**

① Prior to wiring, disconnect the external circuit breaker and confirm that the wire used is thick enough. Please refer to Section 2.2 "Wiring Specifications and Circuit Breaker Selection" . The BAT wire needs to be connected to the machine through the O-type terminal. The O-type terminal with an inner diameter of 5 mm is recommended. The O-type terminal shall firmly press the BAT wire to prevent excessive heat generation caused by excessive contact resistance;

② Properly connect the BAT wire according to the wire sequence and terminal position shown in the figure below.

**BAT+: Battery positive electrode**

**BAT-: Battery negative electrode**

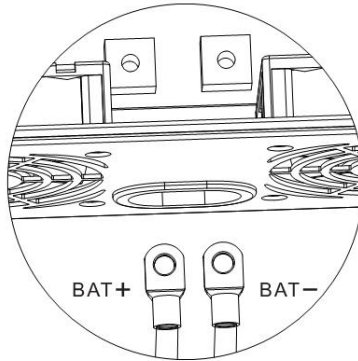

**Warnings:**

- ① Mains input, AC output and PV array will generate high voltage. So, before wiring, be sure to disconnect the circuit breaker or fuse;
- ② Be very careful during wiring; do not close the circuit breaker or fuse during wiring, and ensure that the “+” and “-” pole leads of each component are connected properly; a circuit breaker must be installed at the battery terminal. Refer to Section 2.2 “Wiring Specifications and Circuit Breaker Selection” to select a right circuit breaker. Before wiring, be sure to disconnect the circuit breaker to prevent strong electric sparks and avoid battery short circuit; if the all-in-one solar charge inverter is used in an area with frequent lightning, it is recommended to install an external lightning arrester at the PV input terminal.

**Step 4:** Check if the wiring is correct and firm. In particular, check if the battery polarity is reversed, if the PV input polarity is reversed and if the AC input is properly connected.

**Step 5:** Install the terminals cover.



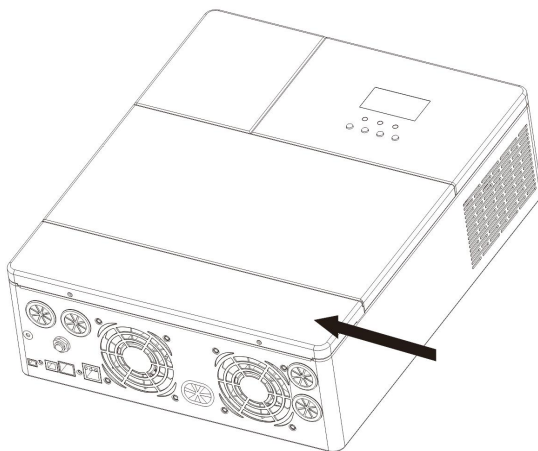

**Step 6:** Turn on the all-in-one solar charge inverter

First, close the circuit breaker at the battery terminal, and then turn the rocker switch on the left side of the machine to the "ON" state. The "AC/INV" indicator flashing indicates that the inverter is working normally. Close the circuit breakers of the PV array and the Mains. Finally, turn on AC loads one by one as the AC output is normal to avoid a protection action caused by a large momentary shock due to simultaneous turning on the loads simultaneously. Now, the machine goes into a normal operation according to the set mode.

Note: If power is supplied to different AC loads, it is recommended to first turn on the load with a large surge current. After the load is stable, turn on the load with a small surge current.

Note: If the all-in-one solar charge inverter does not work properly or the **LCD** or indicator is abnormal, refer to Chapter 6 to handle the exceptions.

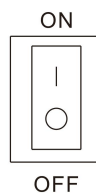

# 3. Operating modes

## 3.1 Charging mode

1) PV priority: PV module will charge the battery preferentially, and the battery is charged by the Mains only when the PV system fails. During the day, solar energy is fully used to charge, while at night, it converts to the Mains. This can maintain battery level, and is ideal for areas where the grid is relatively stable and electricity price is relatively high.

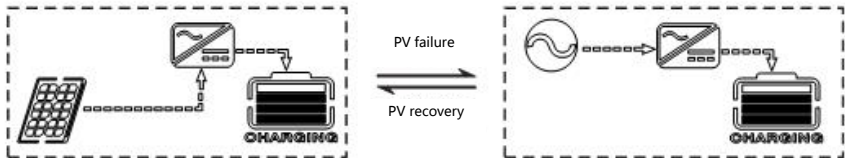

2. Mains priority: The Mains supply is preferentially used to charge the battery. Only when the Mains fails, the PV charging can be activated.

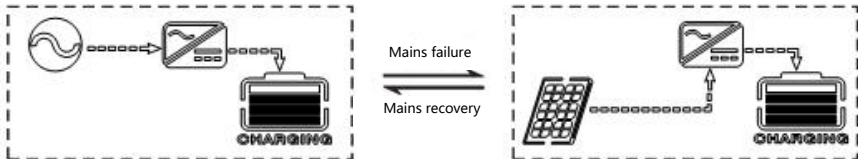

3. Hybrid charging: PV and mains hybrid charging. PV MPPT charging is a priority, and when PV energy is insufficient, the mains supply supplements. When the PV energy is sufficient again, the mains stops charging. This is the fastest charging mode, suitable for the areas where power grid is unstable, providing sufficient backup power supply at any time.

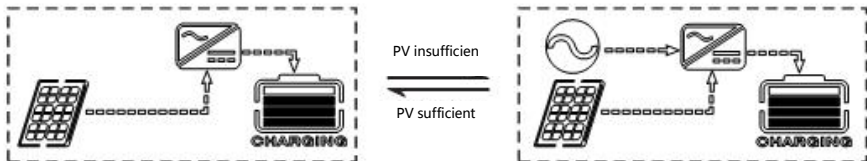

4. Only Solar (Only Solar): Only PV charging, without Mains charging. This is the most energy-efficient way in which battery is charged only by solar panels, and is usually used in areas with good lighting conditions.

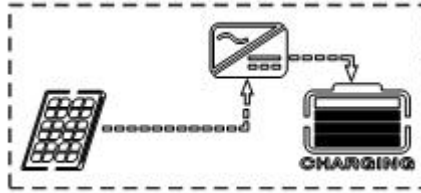

### 3.2 Output mode

- **PV priority mode:** Loads are powered by the PV module and battery. Diversified charging mode and output mode are optional. When PV priority mode is selected, utilization of green solar energy can be maximized to achieve energy saving and emission reduction. Switch to mains supply when the PV charging fails. This mode maximizes the use of solar energy while maintaining battery power, suitable for use in the areas with relatively stable grid.

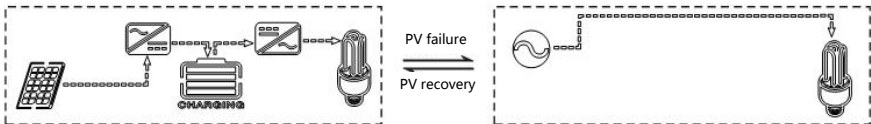

- **Mains priority mode:** Switch to inverter only when the mains fails. Then, the unit is equivalent to a backup UPS, suitable for areas with unstable grid.

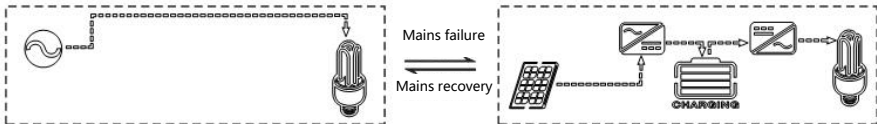

- **Inverter priority mode:** Switch to mains supply only when the battery is under voltage. This mode maximizes the use of DC power and is used in the area with stable grid.

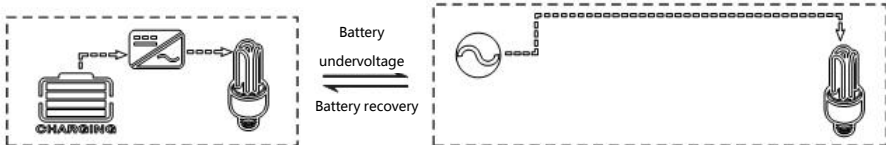

# 4. LCD screen operating instructions

## 4.1 Operation and display panel

The operation and display panel is as shown below, including 1 LCD screen, 3 indicators and 4 operation buttons.

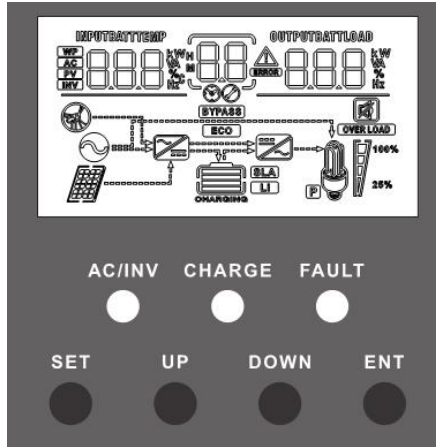

### Operation buttons introduction

Function buttons	Description
SET	Enter/Exit Settings menu
UP	Previous choice
DOWN	Next choice
ENT	Confirm/Enter Options under the settings menu,







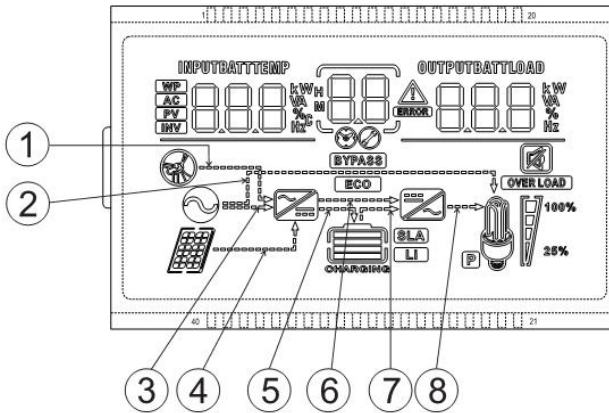







### Indicators introduction

Indicators	Colors	Description
AC/INV	Yellow	Steady on: Mains output
		Flash: Inverter output
CHARGE	Green	Flash: Battery charging
		Steady on: Charging completed
FAULT	Red	Steady on: Fault state

## LCD screen introduction

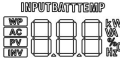

Icons	Functions	Icons	Functions
	Indicates that the AC input terminal has been connected to the grid		Indicates that the inverter circuit is working
	The icon is not displayed	<b>BYPASS</b>	Indicates that the machine is in the Mains Bypass mode
	Indicates that the PV input terminal has been connected to the solar panel	<b>OVER LOAD</b>	Indicates that the AC output is in an overload state
	Indicates that the machine has been connected to the battery: indicates that the remaining battery is 0%~24%; indicates that the remaining battery is 25%~49%; indicates that the remaining battery is 50%~74%;		Indicates the percentage of AC output loads: indicates that the load percentage is 0%~24%; indicates that the load percentage is 25%~49%, indicates that the load percentage is 50%~74%, indicates that the load percentage is ≥75%

	 indicates that the remaining battery is 75%~100%.		
	Indicates that the current battery type of the machine is a lithium battery		Indicates that the buzzer is not enabled
	Indicates that the current battery type of the machine is a lead-acid battery		Indicates that the machine has an alarm
<b>CHARGING</b>	Indicates that the battery is in charging state		Indicates that the machine is in a fault condition
	Indicates that the AC/PV charging circuit is working		Indicates that the machine is in setup mode
	Indicates that the AC output terminal has an AC voltage output		The parameters displayed in the middle of the screen: 1. In the non-setup mode, the alarm or fault code is displayed. 2. In the setup mode, the currently set parameter item code is displayed.
Parameters display on the left side of the screen: input parameters			
	Indicates AC input		
	Indicates PV input		
	Indicates inverter circuit		
	This icon is not displayed		
	Display battery voltage, battery charge total current, mains charge power, AC input voltage, AC input frequency, PV input voltage, internal heat sink temperature, software version		
Parameters display on the right side of the screen: Output parameters			

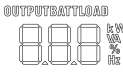
	<p>Indicates output voltage, output current, output active power, output apparent power, battery discharge current, software version; in setup mode, displays the set parameters under the currently set parameter item code</p>		
<p>Arrow display</p>			
①	The arrow is not displayed	⑤	Indicates the charging circuit charging the battery terminal
②	Indicates the grid supplying power to the load	⑥	The arrow is not displayed
③	Indicates grid supplying power to the charging circuit	⑦	Indicates the battery terminal supplying power to the inverter circuit
④	Indicates PV module supplying power to the charging circuit	⑧	Indicates the inverter circuit supplying power to the load

### Real-time data viewing method

On the LCD main screen, press the “UP” and “DOWN” buttons to scroll through the real-time data of the machine.

Page	Parameters on the left side of the screen	Parameters in the middle of the screen	Parameters on the right side of the screen
1	Battery input voltage	Fault code	Output voltage
2	Battery charge current		Output voltage
3	Mains AC charge power		Load current
4	AC input voltage		Load active power
5	AC input frequency		Load active power
6	PV input voltage		Load apparent power
7	Temperature dc-dc		Battery discharge current
8	Temperature inverter		Battery discharge current
9	APP software version		Bootloader software version

## 4.2 Setup parameters description

Buttons operation instructions: Press the “SET” button to enter the setup menu and exit the setup menu. After entering the setup menu, the parameter number [00] will flash. At this point, press the “UP” and “DOWN” buttons to select the code of parameter item to be set. Then, press the “ENT” button to enter the parameter editing mode, and the value of the parameter is flashing. Adjust the value of the parameter with the “UP” and “DOWN” buttons. Finally, press the “ENT” button to complete the parameter editing and return to the parameter selection state.



Parameter no.	Parameter name	Settings	Description
00	Exit setting menu	[00] ESC	Exit the setup menu
01	Output source priority	[01] SOL	PV priority mode, switching to the Mains when the PV fails or the battery is lower than the set value of parameter [04].
		[01] UTI	Mains priority mode, switching to inverter only when the mains fails.
		[01] SBU default	Inverter priority mode, switching to the mains only when the battery is under voltage or lower than the set value of parameter [04].
02	Output Frequency	[02] 50.0	Bypass self-adaptation; when the mains is connected, it automatically adapts to the mains frequency; when the mains is disconnected, the output frequency can be set through this menu. The default output frequency of the 230V machine is 50HZ, and the 120V machine 60HZ.
		[02] 60.0	
03	AC Input Voltage Range	[03] APL default	<b>Only valid for 230V machine, not for 120V machine.</b> Wide mains input voltage range of 230V machine: 90~280V Mains input voltage range of 120V machine: 90~140V
		[03] UPS	<b>Only valid for 230V machine, not for 120V machine.</b> Narrow mains input voltage range of 230V machine: 170~280V Mains input voltage range of 120V machine: 90~140V
04	Battery voltage to line	[04] 46.0 default	When the parameter [01] =SOL/SBU, the battery voltage is lower than the set value, and the output is switched from the inverter to the mains. Setting range: 44V~52V.
05	Battery voltage to inverter	[05] 56.0V default	When the parameter [01] =SOL/SBU, the battery voltage is higher than the set value, and the output is switched from the mains to the inverter. Setting range: 48V~60V.

Parameter no.	Parameter name	Settings	Description
06	Charger source priority	[06] CSO	PV priority charging; only when the PV charging fails, the mains charging is started.
		[06] CUB	Mains priority charging; only when the mains charging fails, the PV charging is started.
		[06] SNU default	PV and Mains hybrid charging; PV charging is a priority, and when the PV energy is insufficient, the Mains charging supplements. When the PV energy is sufficient, the Mains charging stops. Note: Only when the Mains bypass output is loaded, the PV charging and the mains charging can work at the same time. When the inverter works, only the PV charging can be started.
		[06] OSO	Only PV charging, with the Mains charging not activated.
07	Max charger current	[07] 60A default	Setting range: 0~140A ;
08	Battery Type	[08] USE	User-defined; all battery parameters can be set.
		[08] SLd	Sealed lead-acid battery; constant-voltage charge voltage: 57.6V, floating charge voltage: 55.2V.
		[08] FLd	Vented lead-acid battery; constant-voltage charge voltage: 58.4V, floating charge voltage: 55.2V.
		[08] GEL default	Colloidal lead-acid battery; constant-voltage charge voltage: 56.8V, floating charge voltage: 55.2V.
		[08] LF4/LF6	Lithium iron phosphate battery LF4/LF6, corresponding to 14 strings and 16 strings of lithium iron phosphate battery; for 16 strings, default constant-voltage charge voltage is 56.8V, and for 14 strings, default constant-voltage charge voltage is 49.2V, which are adjustable.

Parameter no.	Parameter name	Settings	Description
		[08] NCA	Ternary lithium battery; the default constant-voltage charge voltage is 56.8V, which is adjustable.
09	Battery boost charge voltage	[09] 57.6V default	Boost charge voltage setting; the setting range is 48V~58.4V, with step of 0.4V; it is valid for user-defined battery and lithium battery.
10	Battery boost charge time	[10] 120 default	Boost charge maximum time setting, which means the maximum charging time to reach the set voltage of parameter [09] during constant-voltage charging. The setting range is 5min~900min, with a step of 5 minutes. It is valid for user-defined battery and lithium battery.
11	Battery floating charge voltage	[11] 55.2V default	Floating charge voltage, setting range: 48V~58.4V, step: 0.4V, valid when battery type is user-defined.
12	Battery over discharge voltage (delay off)	[12] 42V default	Over-discharge voltage; when the battery voltage is lower than this judgment point, delay the time set by parameter [13] and turn off inverter output. Setting range is 40V~48V, with a step of 0.4V. It is valid for user-defined battery and lithium battery.
13	Battery over discharge delay time	[13] 5S default	Over-discharge delay time; when the battery voltage is lower than the parameter [12], the inverter output will be turned off after the time set by this parameter is delayed. The setting range is 5S~55S, with a step of 5S. It is valid for user-defined battery and lithium battery.
14	Battery under voltage alarm	[14] 44V default	Battery undervoltage alarm point; when the battery voltage is lower than the point, an undervoltage alarm is given, and the output is not turned off; the setting range is 40V~52V, with a step of 0.4V. It is valid for user-defined battery and lithium battery.

Parameter no.	Parameter name	Settings	Description
15	Battery discharge limit voltage	[15] 40V default	Battery discharge limit voltage; when the battery voltage is lower than the point, the output is turned off immediately; the setting range is 40V~52V, with a step of 0.4V. It is valid for user-defined battery and lithium battery.
16	Battery equalization enable	[16] DIS	Equalizing charge is disabled
		[16] ENA default	Equalizing charge is enabled, only valid for vented lead-acid battery and sealed lead-acid battery
17	Battery equalization voltage	[17] 58.4V default	Equalizing charge voltage; setting range: 48V~58.4V, with a step of 0.4V; valid for vented lead-acid battery and sealed lead-acid battery
18	Battery equalized time	[18] 120 default	Equalizing charge time; setting range: 5min~900min, with a step of 5 minutes; valid for vented lead-acid battery and sealed lead-acid battery
19	Battery equalized time out	[19] 120 default	Equalizing charge delay; setting range: 5min~900min, with a step of 5 minutes; valid for vented lead-acid battery and sealed lead-acid battery
20	Battery equalization interval	[20] 30 default	Equalizing charge derating time, 0~30days, with a step of 1 day; valid for vented lead-acid battery and sealed lead-acid battery
21	Battery equalization immediately	[21] DIS	Stop equalizing charge immediately.
		[21] ENA default	Start equalizing charge immediately.
22	Power saving mode	[22] DIS	Power saving mode disabled
		[22] ENA default	After the power saving mode is enabled, if the load is null or small, the inverter output is turned off after a delay for a certain period of time. The rocker switch is pressed to "OFF", and then pressed to "ON", to resume inverter output.

<b>Parameter no.</b>	<b>Parameter name</b>	<b>Settings</b>	<b>Description</b>
<b>23</b>	Restart when over load	[23] DIS	Automatic restart when overload is disabled. If an overload occurs and the output is turned off, the machine will not restart.
		[23] ENA default	Automatic restart when overload is enabled. If an overload occurs and the output is turned off, the machine will restart after a delay of 3 minutes. After it reaches 5 cumulative times, the machine will not restart.
<b>24</b>	Restart when over temperature	[24] DIS	Automatic restart when over temperature is disabled. If an over-temperature shutdown occurs, machine will not restart to turn the output on.
		[24] ENA default	Automatic restart when over temperature is enabled. If an over-temperature shutdown occurs, the machine will restart when the temperature drops.
<b>25</b>	Alarm enable	[25] DIS	Alarm is disabled
		[25] ENA default	Alarm is enabled
<b>26</b>	Beeps while primary source is interrupted	[26] DIS	Alarm beep is disabled when the status of the main input source changes
		[26] ENA default	Alarm beep is enabled when the status of the main input source changes
<b>27</b>	Bypass output when over load	[27] DIS	It is disabled to automatically switch to the Mains when the inverter is overloaded.
		[27] ENA default	It is enabled to automatically switch to the Mains when the inverter is overloaded.

### 4.3 Battery type parameters

Battery type Parameters	Sealed lead acid battery (SLD)	Colloidal lead acid battery (GEL)	Vented lead acid battery (FLD)	Lithium iron phosphate battery (LF6)	Lithium iron phosphate battery (LF4)	Ternary lithium battery (NCM/NCA)	User-defined (User)
Overvoltage disconnection voltage	60V	60V	62V	60V	60V	60V	36 ~ 60V
Equalizing charge voltage	58.4V	56.8V	59.2V	56.8V (Adjustable)	49.2V	-	36 ~ 60V
Boost charge voltage	57.6V	56.8V	58.4V	56.8V (Adjustable)	49.2V (Adjustable)	55.2V (Adjustable)	36 ~ 60V (Adjustable)
Floating charge voltage	55.2V	55.2V	55.2V	56.8V (Adjustable)	49.2 (Adjustable)	55.2V (Adjustable)	36 ~ 60V (Adjustable)
Undervoltage alarm voltage	48V	48V	48V	49.6V (Adjustable)	43.2V (Adjustable)	44.8V (Adjustable)	36 ~ 60V (Adjustable)
Low voltage disconnection voltage	44.4V	44.4V	44.4V	48.8V (Adjustable)	42V (Adjustable)	43.2V (Adjustable)	36 ~ 60V (Adjustable)
Discharge limit voltage	42.4V	42.4V	42.4V	44.8V (Adjustable)	40.8V (Adjustable)	41.6V (Adjustable)	36 ~ 60V (Adjustable)
Over-discharge delay time	5s	5s	5s	30s (Adjustable)	30s (Adjustable)	5s (Adjustable)	1 ~ 30s (Adjustable)
Equalizing charge duration	120 minutes	-	120 minutes	-	-	-	0 ~ 600 minutes (Adjustable)
Equalizing charge interval	30 days	-	30 days	-	-	-	0 ~ 250 days (Adjustable)
Boost charge duration	120 minutes	120 minutes	120 minutes	120 minutes (Adjustable)	120 minutes (Adjustable)	120 minutes (Adjustable)	10 ~ 600 minutes (Adjustable)

## 5. Other functions

### 5.1 Dry node

Working principle: This dry node can control the ON/OFF of the diesel generator to charge the battery. ① Normally, the terminals are that the NC-N point is closed and the NO-N point is open; ② When the battery voltage reaches the low voltage disconnection point, the relay coil is energized, and the terminals turn to that the NO-N point is closed while NC-N point is open. At this point, NO-N point can drive resistive loads: 125VAC/1A, 230VAC/1A, 30VDC/1A.

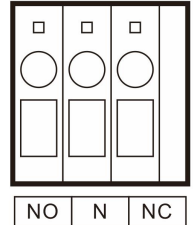

### 5.2 RS485 communication port

This port is an RS485 communication port which comes with two functions:

- ① It allows direct communication with the optional host computer (stored on the CD-ROM) developed by our company through this port, and enables monitoring of the equipment running status and setting of some parameters on the computer;
- ② It also allows direct connection with the optional RS485 to Bluetooth communication module developed by our company through this port. After the module is selected, you can connect the all-in-one solar charge inverter through the mobile phone Bluetooth APP, on which you can view the operating parameters and status of the device.

- ③ As shown in the figure: Pin 1 is 5V power supply, Pin 2 is GND, Pin 7 is RS485-A, and Pin 8 is RS485-B.

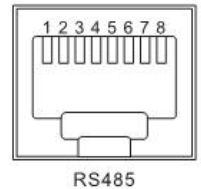

### 5.3 CAN communication port (optional)

CAN communication is an optional function, which is not available in the standard machine.

As shown in the figure: Pin 1 is CAN-L and Pin 2 is CAN-H.



### 5.4 USB communication port

This is a USB communication port, which can be used for USB communication with the optional PC host software in the CD-ROM. To use this port, you should install the corresponding "USB to serial chip CH340T driver" in the computer.

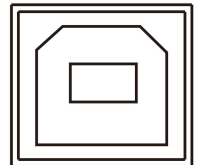

# 6. Protection

## 6.1 Protections provided

No.	Protections	Description
1	Current limiting protection	When charging current of the PV array configured exceeds the PV rated current, it will charge at the rated current.
2	Night reverse-current protection	At night, the battery is prevented from discharging through the PV module because the battery voltage is greater than the voltage of PV module.
3	Mains input overvoltage protection	When the mains voltage exceeds 280V (230V model) or 140V (120V model), the mains charging will be stopped and switched to the inverter mode.
4	Mains input undervoltage protection	When the mains voltage is lower than 170V (230V model) or 90V (120V model), the mains charging will be stopped and switched to the inverter mode.
5	Battery overvoltage protection	When the battery voltage reaches the overvoltage disconnection point, the PV and the mains will be automatically stopped to charge the battery to prevent the battery from being overcharged and damaged.
6	Battery low voltage protection	When the battery voltage reaches the low voltage disconnection point, the battery discharging will be automatically stopped to prevent the battery from being over-discharged and damaged.
7	Load output short circuit protection	When a short-circuit fault occurs at the load output terminal, the AC output is immediately turned off and turned on again after 1 minute. If the output load is still short-circuited after 3 attempts, the short-circuit fault of the load must be eliminated before manually powering on again to resume normal output.
8	Heat sink over temperature protection	When the internal temperature is too high, the all-in-one machine will stop charging and discharging; when the temperature returns to normal, charging and discharging will resume.
9	Overload protection	Output again 3 minutes after an overload protection, and turn the output off after 5 consecutive times of overload protection until the machine is re-powered. For the specific overload level and duration, refer to the technical parameters table in the manual.
10	PV reverse polarity protection	When the PV polarity is reversed, the machine will not be damaged.
11	AC reverse protection	Prevent battery inverter AC current from being reversely input to Bypass.
12	Bypass overcurrent protection	Built-in AC input overcurrent protection circuit breaker.



## 6.2 Fault code meaning

Fault code	Fault name	Whether it affects the output or not	Description
<b>[01]</b>	BatVoltLow	Yes	Battery undervoltage alarm
<b>[02]</b>	BatOverCurrSw	Yes	Battery discharge average current overcurrent software protection
<b>[03]</b>	BatOpen	Yes	Battery not-connected alarm
<b>[04]</b>	BatLowEod	Yes	Battery undervoltage stop discharge alarm
<b>[05]</b>	BatOverCurrHw	Yes	Battery overcurrent hardware protection
<b>[06]</b>	BatOverVolt	Yes	Charging overvoltage protection
<b>[07]</b>	BusOverVoltHw	Yes	Bus overvoltage hardware protection
<b>[08]</b>	BusOverVoltSw	Yes	Bus overvoltage software protection
<b>[09]</b>	PvVoltHigh	No	PV overvoltage protection
<b>[10]</b>	PvBuckOCSw	No	Buck overcurrent software protection
<b>[11]</b>	PvBuckOCHw	No	Buck overcurrent hardware protection
<b>[12]</b>	bLineLoss	No	Mains power down
<b>[13]</b>	OverloadBypass	Yes	Bypass overload protection
<b>[14]</b>	OverloadInverter	Yes	Inverter overload protection
<b>[15]</b>	AcOverCurrHw	Yes	Inverter overcurrent hardware protection
<b>[16]</b>	-	-	-
<b>[17]</b>	InvShort	Yes	Inverter short circuit protection
<b>[18]</b>	-	-	-
<b>[19]</b>	OverTemperMppt	No	Buck heat sink over temperature protection
<b>[20]</b>	OverTemperInv	Yes	Inverter heat sink over temperature protection
<b>[21]</b>	FanFail	Yes	Fan failure
<b>[22]</b>	EEPROM	Yes	Memory failure
<b>[23]</b>	ModelNumErr	Yes	Model setting error

### 6.3 Handling measures for part of faults

Faults	Handling measures
No display on the screen	Check if the battery air switch or the PV air switch has been closed; if the switch is in the "ON" state; press any button on the screen to exit the screen sleep mode.
Battery overvoltage protection	Measure if the battery voltage exceeds 60V, and turn off the PV array air switch and Mains air switch.
Battery undervoltage protection	Charge the battery until it returns to the low voltage disconnection recovery voltage.
Fan failure	Check if the fan is not turning or blocked by foreign object.
Heat sink over temperature protection	When the temperature of the device is cooled below the recovery temperature, normal charge and discharge control is resumed.
Bypass overload protection, inverter overload protection	① Reduce the use of power equipment; ② Restart the unit to resume load output.
Inverter short circuit protection	① Check the load connection carefully and clear the short-circuit fault points; ② Re-power up to resume load output.
PV overvoltage	Use a multimeter to check if the PV input voltage exceeds the maximum allowable input voltage of 145V.
Battery missed alarm	Check if the battery is not connected or if the battery circuit breaker is not closed.

## 7. System maintenance

- **In order to maintain the best long-term performance, it is recommended to conduct following checks twice a year.**
  1. Make sure that the airflow around the unit is not blocked and remove any dirt or debris from the heat sink.
  2. Check that all exposed wires are damaged by exposure to sunlight, friction with other objects around them, dryness, bite by insects or rodents, etc., and the wires shall be repaired or replaced if necessary.
  3. Verify for the consistency of indication and display with the operation of the device. Please pay attention to the display of any faults or errors, and take corrective actions if necessary.
  4. Check all wiring terminals for corrosion, insulation damage, signs of high temperature or burning/discoloration, and tighten the screws.
  5. Check for dirt, nesting insects and corrosion, and clean up as required.
  6. If the arrester has failed, replace in time to prevent lightning damage to the unit or even other equipment of the user.

**Warning: Danger of electric shock! When doing the above operations, make sure that all power supplies of the all-in-one machine have been disconnected, and all capacitors have been discharged, and then check or operate accordingly!**

- **The company does not assume any liability for damage caused by:**
  - ① Improper use or use in improper site.
  - ② Open circuit voltage of the PV module exceeds the maximum allowable voltage of 145V.
  - ③ Temperature in the operating environment exceeds the limited operating temperature range.
  - ④ Disassemble and repair the all-in-one solar charge inverter without permission.
  - ⑤ Force majeure: Damage that occurs in transportation or handling of the all-in-one solar charge inverter.

## 8. Technical parameters

Models	HF4830S60	HF4840S60	HF4850S80	HF4825U60	HF4830U60	HF4835U80
<b>Mains mode</b>						
Rated input voltage	220/230Vac			110/120Vac		
Input voltage range	(170Vac~280Vac) ±2% (90Vac-280Vac) ±2%			(90Vac~140Vac) ±2%		
Frequency	50Hz/ 60Hz (Auto detection)					
Frequency Range	47±0.3Hz ~ 55±0.3Hz (50Hz); 57±0.3Hz ~ 65±0.3Hz (60Hz);					
Overload/short circuit protection	Circuit breaker					
Efficiency	>95%					
Conversion time (bypass and inverter)	10ms (typical)					
AC reverse protection	Available					
Maximum bypass overload current	40A					
<b>Inverter mode</b>						
Output voltage waveform	Pure sine wave					
Rated output power (VA)	3000	4000	5000	2500	3000	3500
Rated output power (W)	3000	4000	5000	2500	3000	3500
Power factor	1					
Rated output voltage (Vac)	230Vac			120Vac		
Output voltage error	±5%					
Output frequency	50Hz ± 0.3Hz 60Hz ± 0.3Hz					

range (Hz)						
Efficiency	>90%					
Overload protection	(102% < load <125%) ±10%: report error and turn off the output after 5 minutes; (125% < load < 150%) ± 10%: report error and turn off the output after 10 seconds; Load >150% ±10%: report error and turn off the output after 5 seconds;			(102% < load <110%) ±10%: report error and turn off the output after 5 minutes; (110% < load < 125%) ± 10%: report error and turn off the output after 10 seconds; (Load >150% ±10%): report error and turn off the output after 5 seconds;		
Peak power	6000VA	8000VA	10000VA	5000VA	6000VA	7000VA
Loaded motor capability	2HP	3HP	4HP	1HP	1HP	2HP
Output short circuit protection	Circuit breaker					
Bypass breaker specifications	40A					
Rated battery input voltage	48V (Minimum starting voltage 44V)					
Battery voltage range	Undervoltage alarm/shutdown voltage/overvoltage alarm /overvoltage recovery... settable on LCD screen)					
Power saving mode	Load ≤25W					
<b><i>Mains charging</i></b>						
Battery type	Lead acid or lithium battery					
Maximum charge current	60A			30A		
Charge current error	± 5A <sub>dc</sub>					
Charge voltage range	40 –58V <sub>dc</sub>			40 –60V <sub>dc</sub>		
Short circuit protection	Circuit breaker and blown fuse					
Circuit breaker specifications	40A					
Overcharge protection	Alarm and turn off charging after 1 minute					
<b><i>PV charging</i></b>						
Maximum PV open circuit voltage	145V <sub>dc</sub>					

PV operating voltage range	60-145Vdc			
MPPT voltage range	60-115Vdc			
Battery voltage range	40-60Vdc			
Maximum output power	3200W	4200W	3200W	4200W
PV charging current range (can be set)	0-60A	0-80A	0-60A	0-80A
Charging short circuit protection	Blown fuse			
Wiring protection	Reverse polarity protection			
<b><i>Certified specifications</i></b>				
Certification	CE(EN62040-1)			
EMC certification level	EN62040-2, C2			
Operating temperature range	-15°C to 55°C			
Storage temperature range	-25°C ~ 60°C			
Humidity range	5% to 95% (Conformal coating protection)			
Noise	≤60dB			
Heat dissipation	Forced air cooling, variable speed of fan			
Communication interface	USB/RS485(Bluetooth/WiFi/GPRS)/Dry node control			
Size (L*W*D)	430mm*338mm*126mm			
Weight (kg)	10			

