

**Brick 'Em
Young™**

Washington DC Temple

1,368 Pieces
Product# DC 94:15
Ages 12+
www.brickemyoung.com

standard size bricks
Toy Brick Building Set

Figurines include multiple hair colors & skin tones

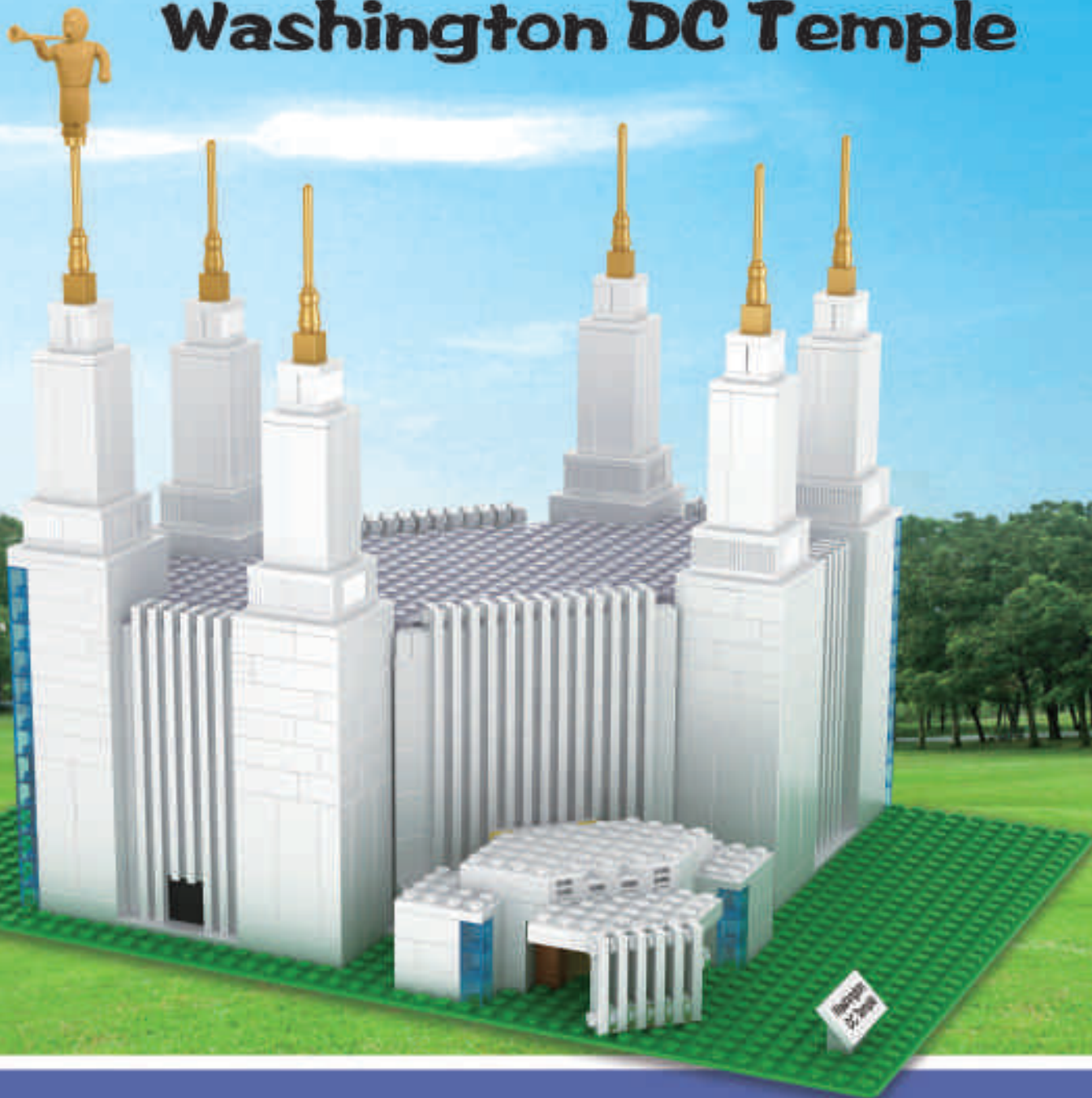

10 Interesting Facts about the Washington DC Temple

1. The Washington D.C. Temple was announced in 1968 and dedicated in 1974, making it the first temple in the eastern United States.

2. The Washington D.C. Temple is not physically located in Washington D.C. It is in Kensington, Maryland which is about ten miles north of Washington D.C.

3. The D.C. Temple is a well-known landmark and prominent landmark along the Capital Beltway. Many thousands of travelers pass by the temple daily.

4. The D.C. Temple is roughly 160,000 square feet and sits on 52 acres, making it the third largest temple of the Church.

5. The D.C. Temple is tallest of any temple, standing at 288 feet tall.

6. The design of the D.C. Temple has some similarities to the Salt Lake Temple as both temples have 6 spires with three towers on each end.

7. The quarry that supplied the original exterior and renovation is in Sylacauga, Alabama.

8. The temple grounds feature almost 10,000 shrubs and flowers, a fountain, and reflecting pool.

9. The D.C. Temple is one of just eight temples with a large assembly room. The other temples are St. George, Logan, Manti, Salt Lake, Los Angeles, Portland, and Nauvoo.

10. For a period of time when the Washington D.C. temple was the only temple in the eastern U.S., many members would travel to the temple on the weekend. To accommodate these travelers, the temple even offered overnight sessions from Friday night to Saturday morning.



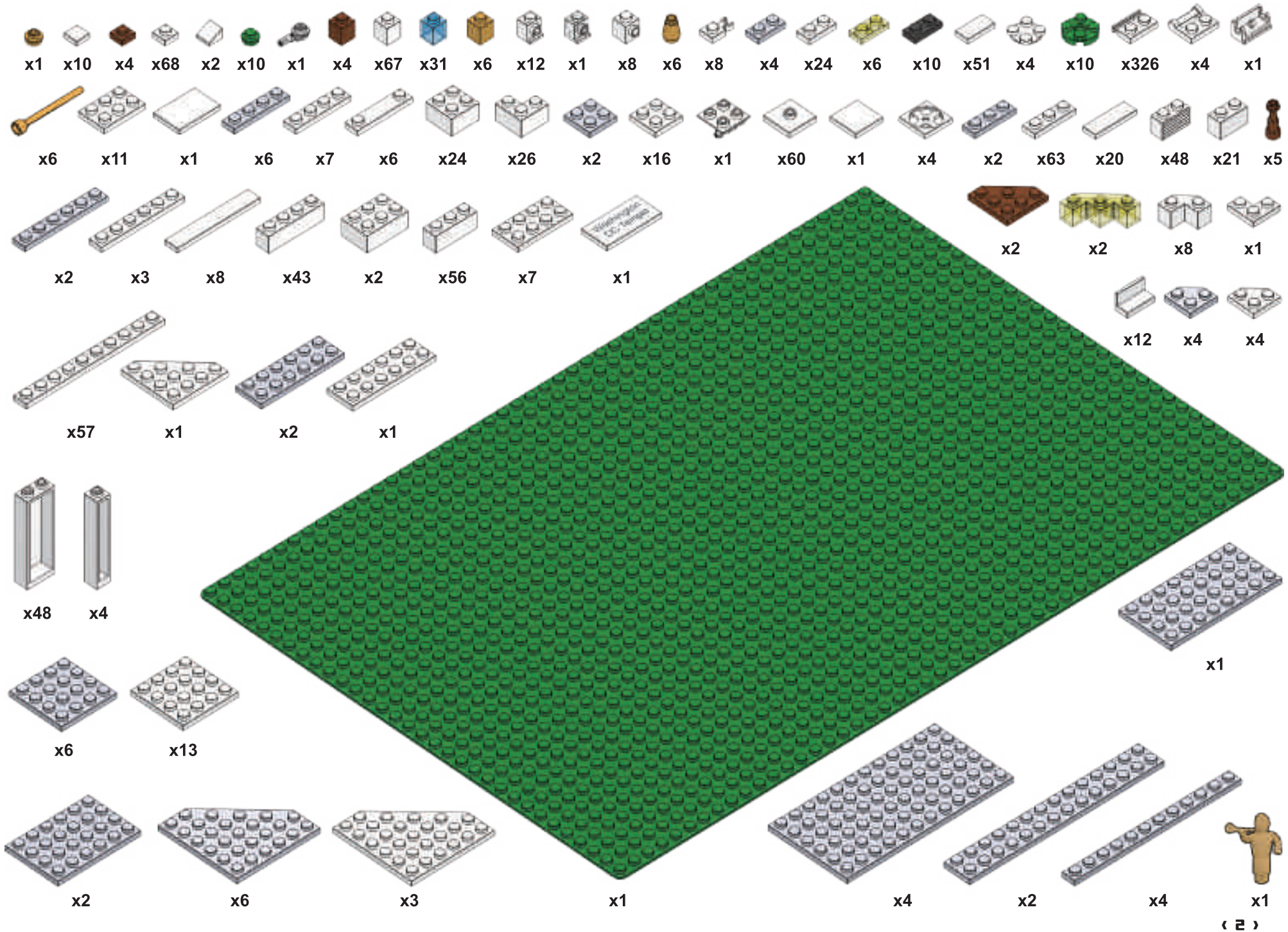

(2)

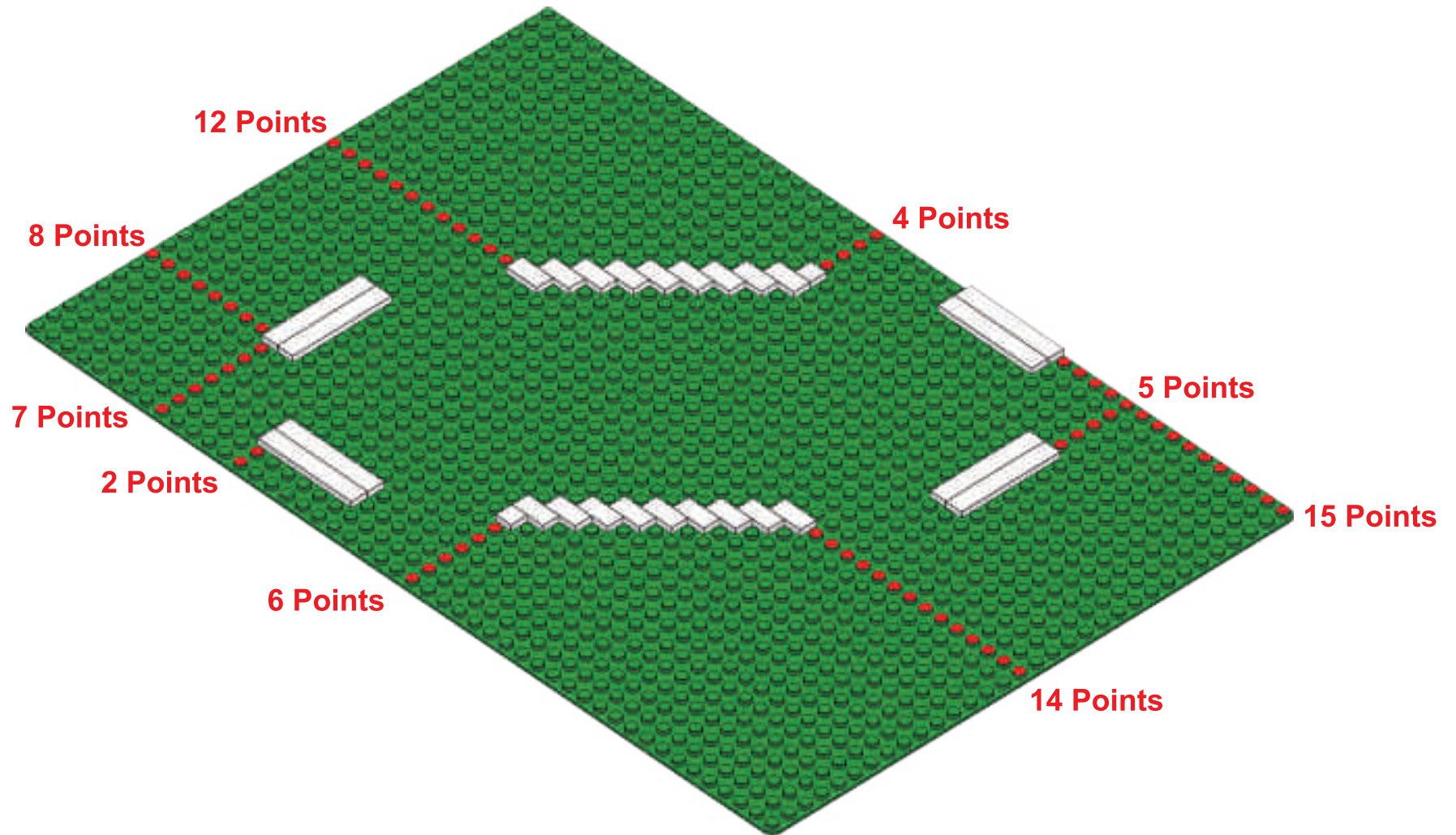
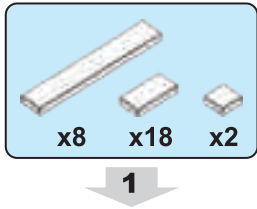

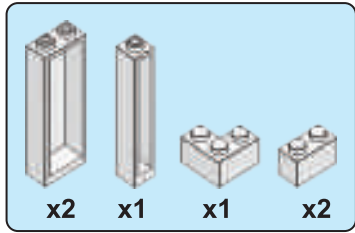

2

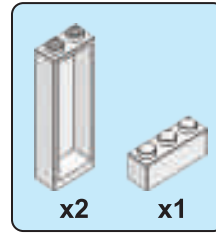
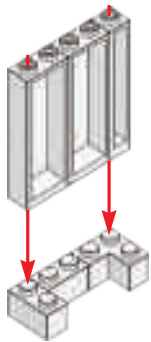

3

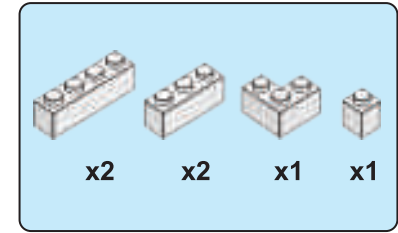
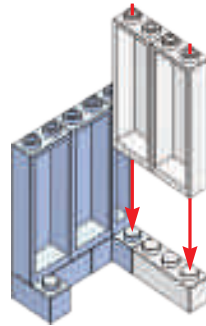

4

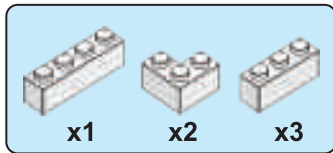
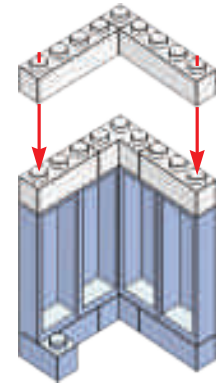

5

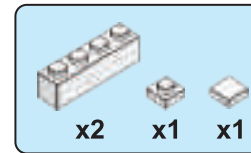
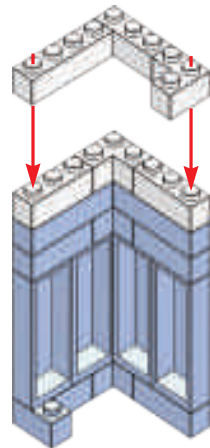

6

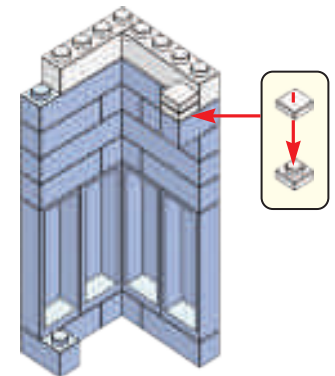

7

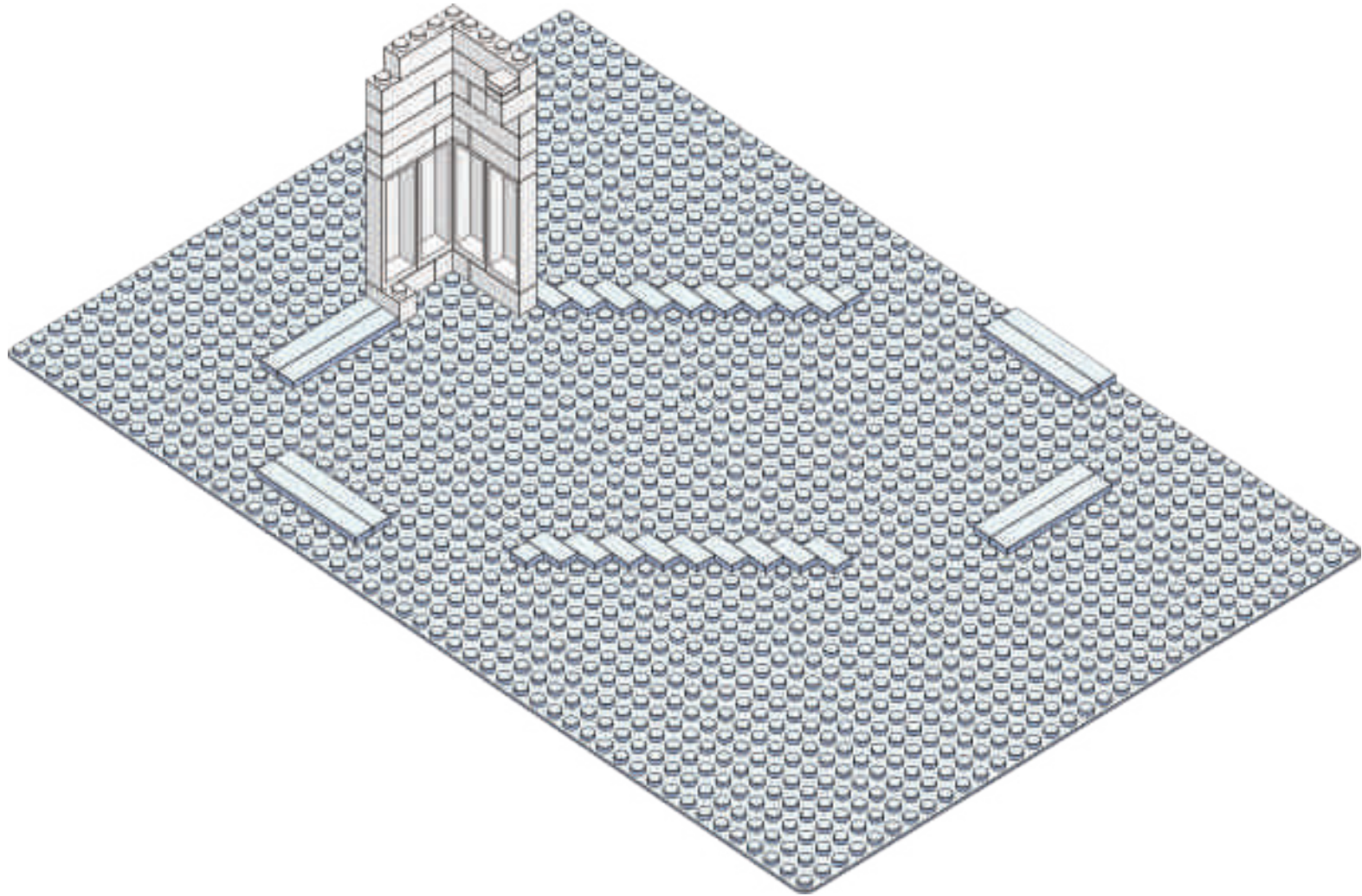

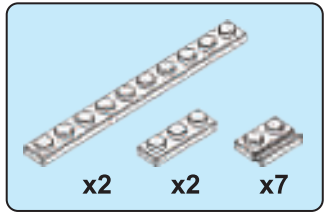

9

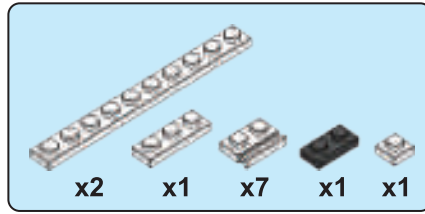
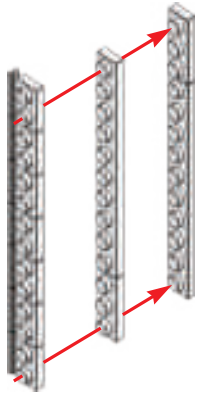

10

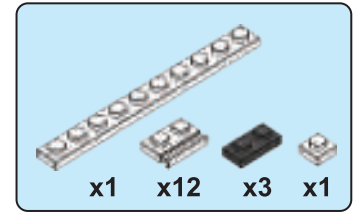
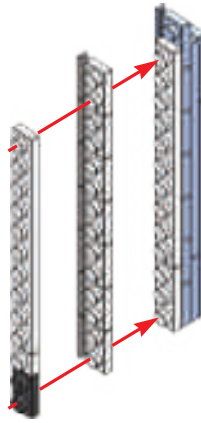

11

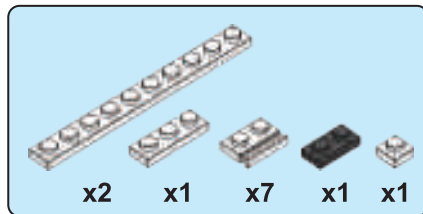
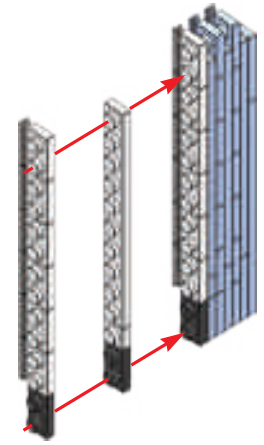

12

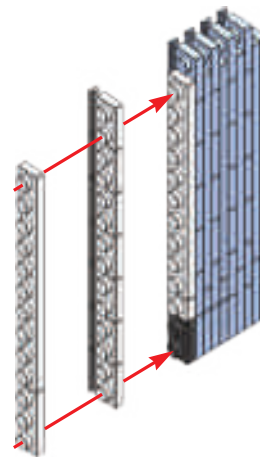

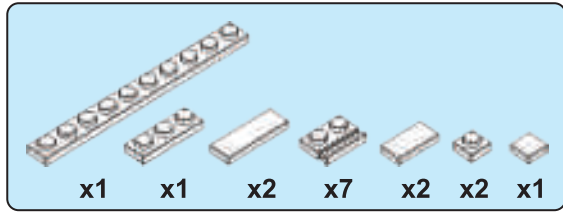

13

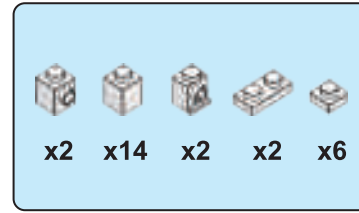

14

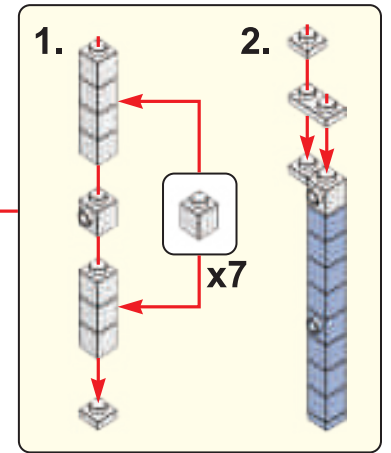
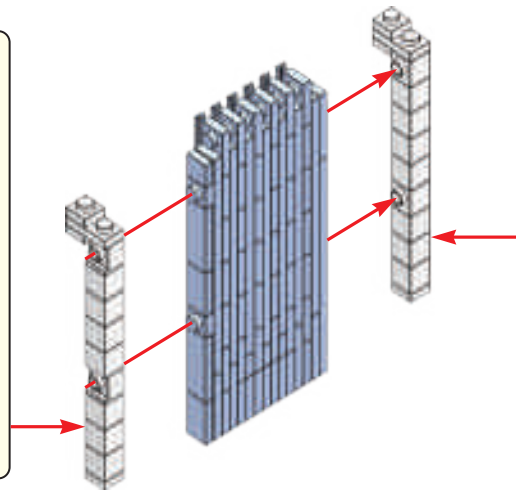
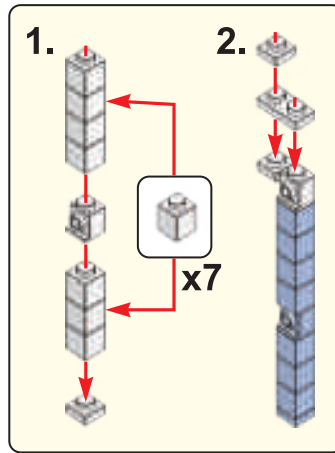
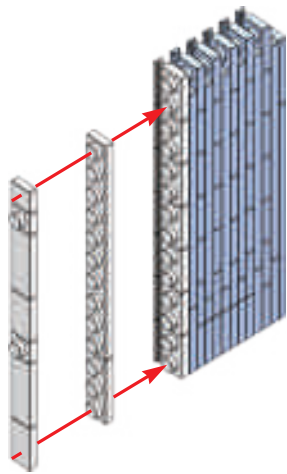

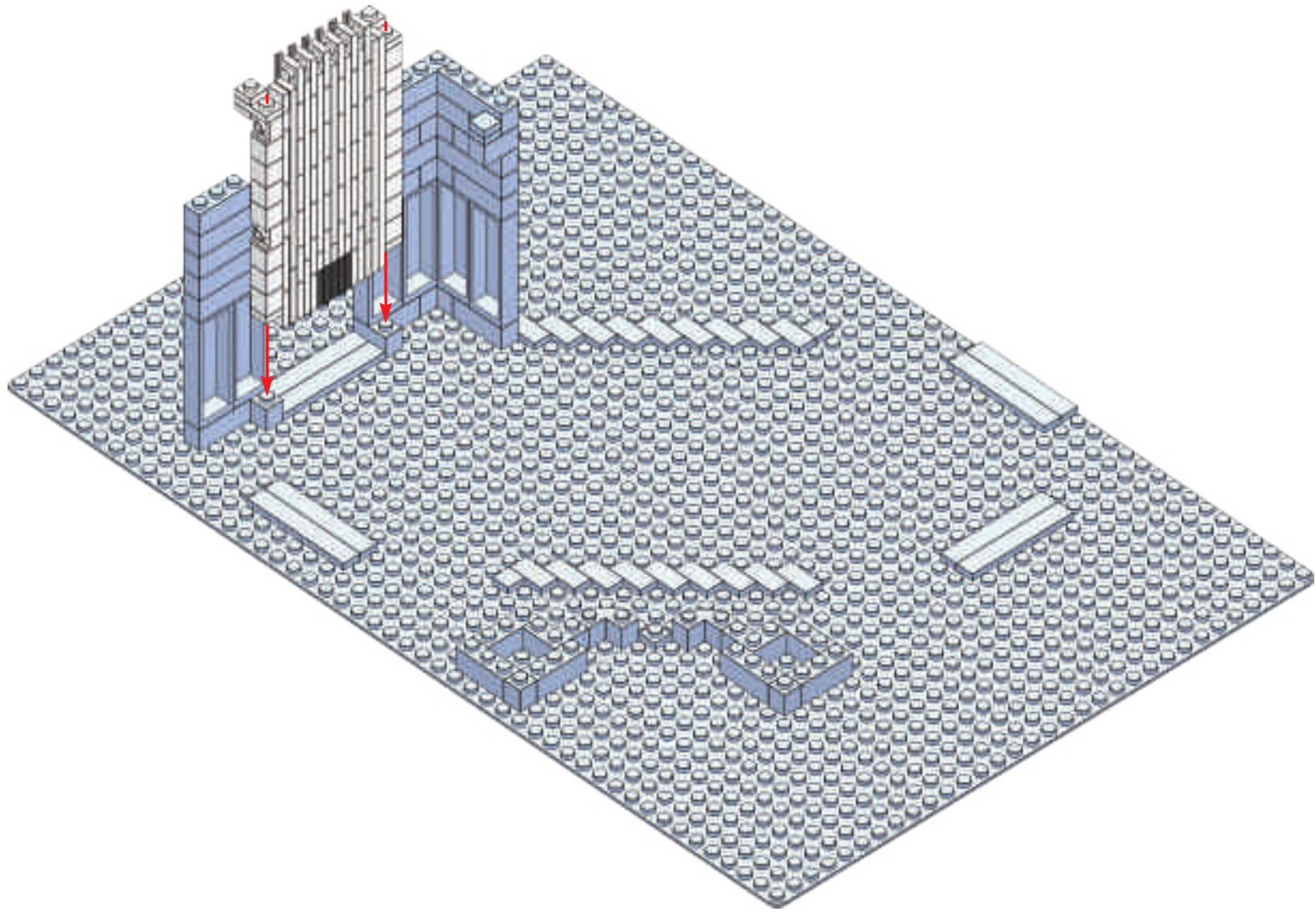

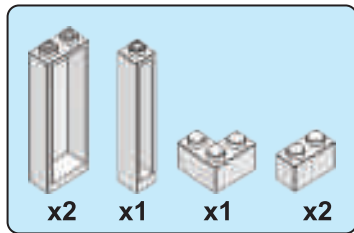

16

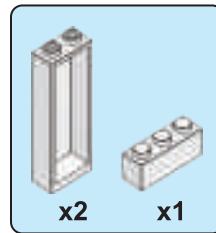
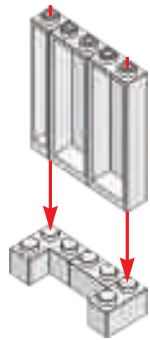

17

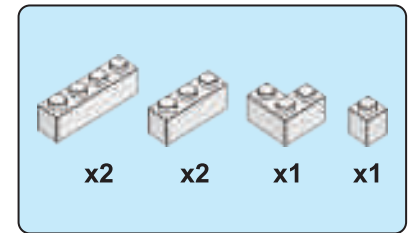
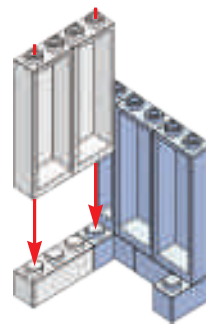

18

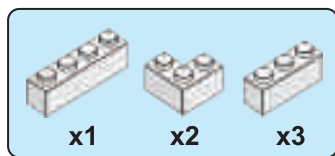
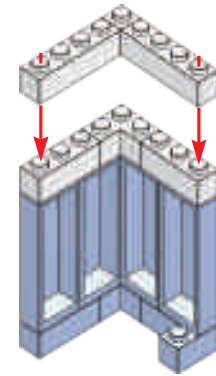

19

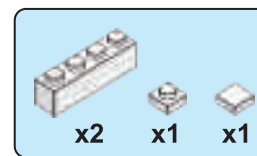
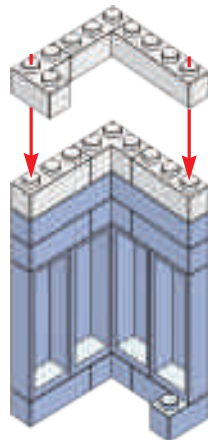

20

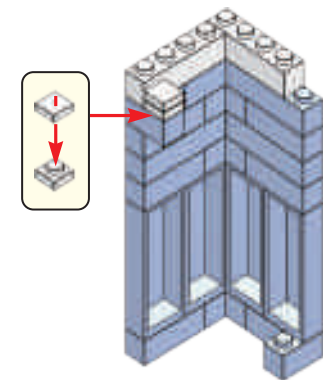

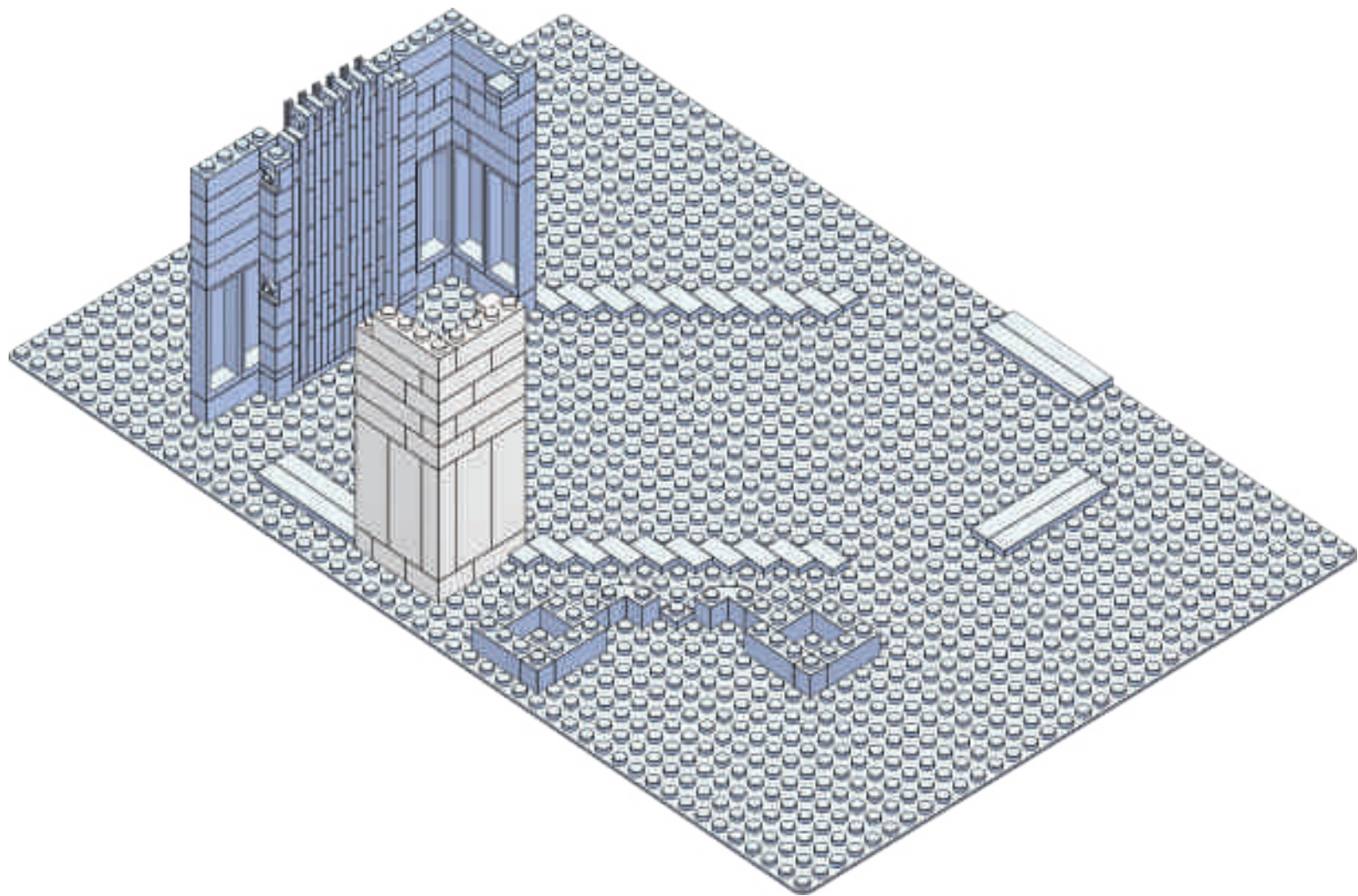

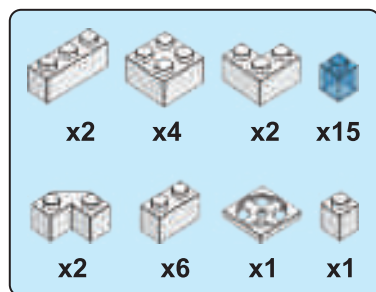

22

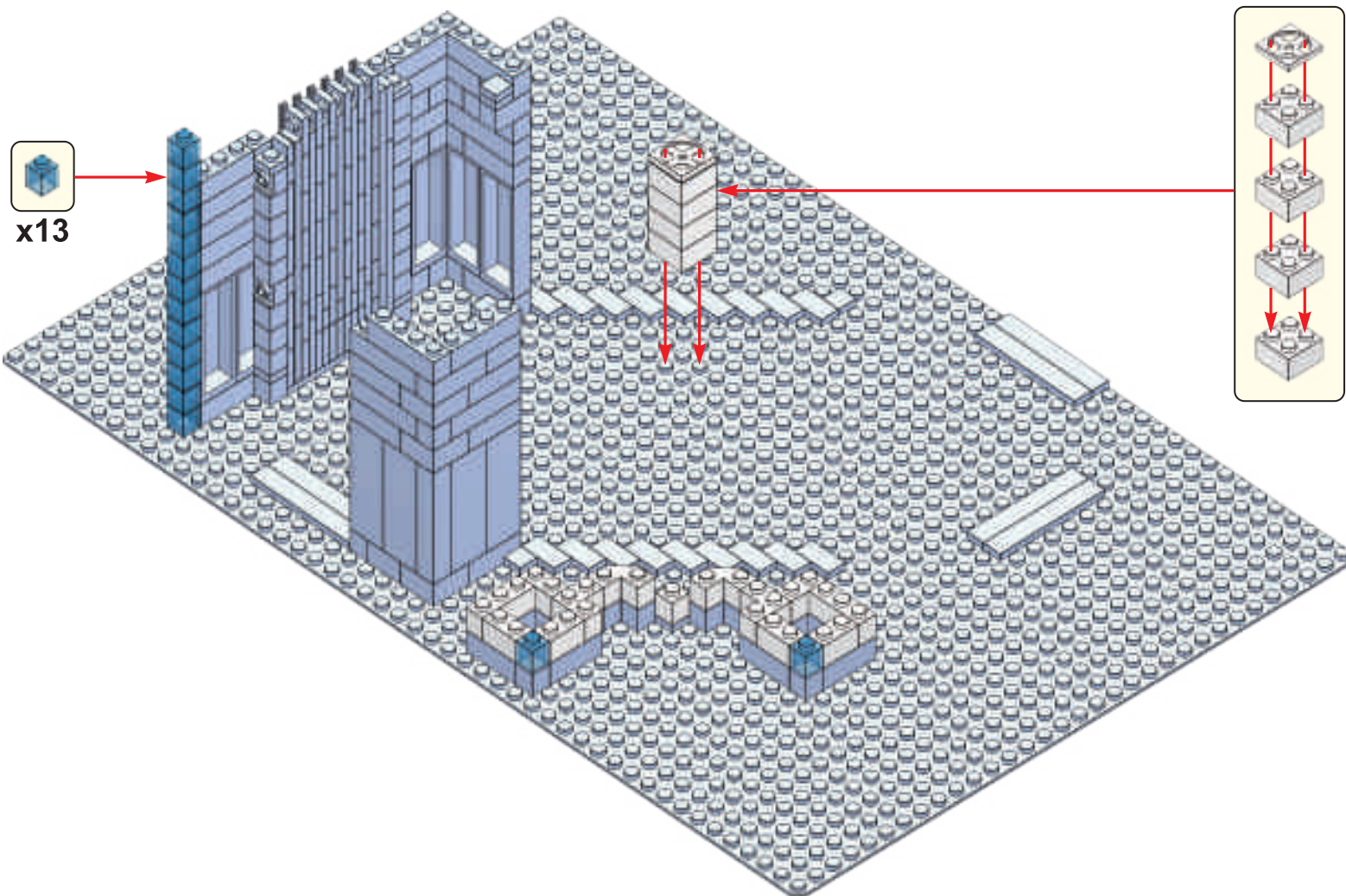

x13

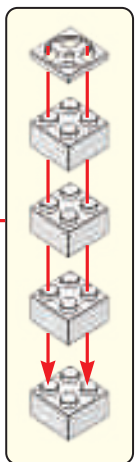

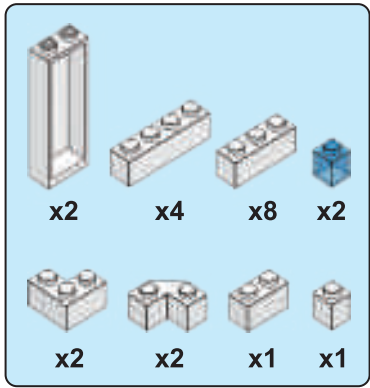

23

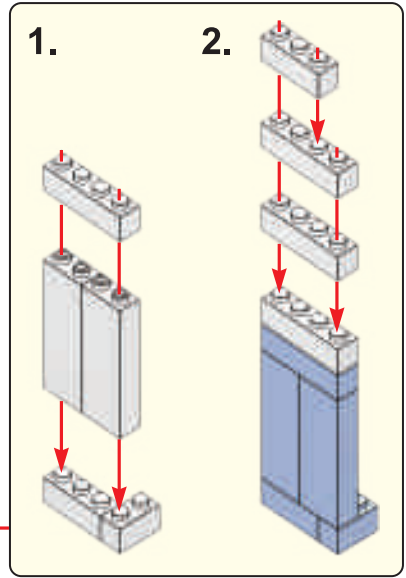
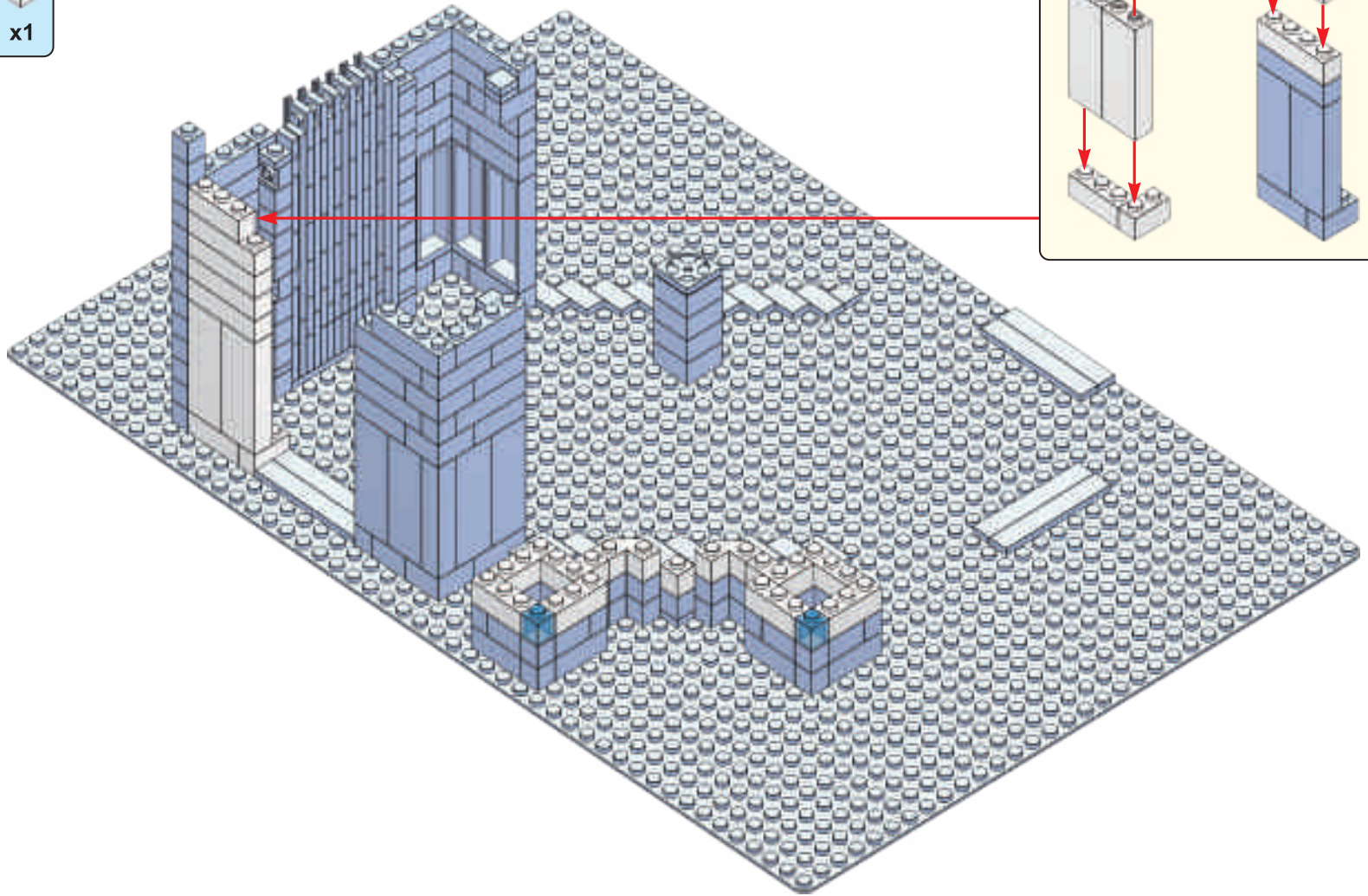

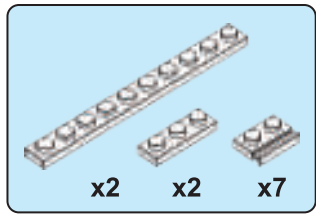

24

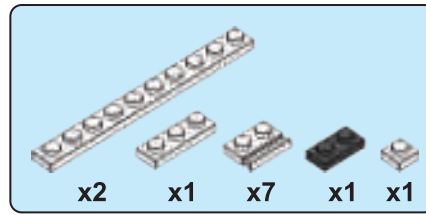
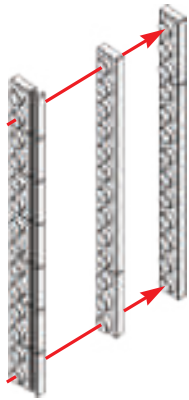

25

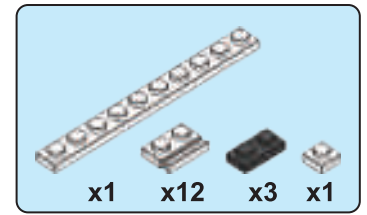
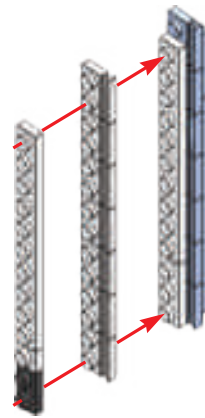

26

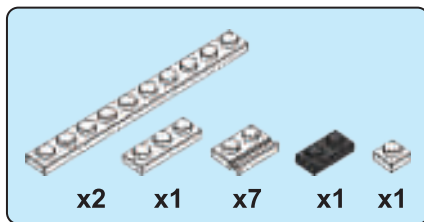
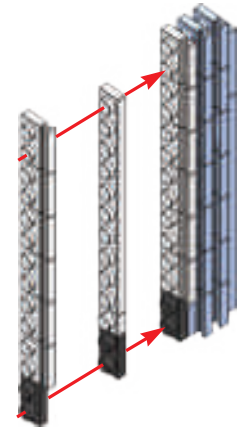

27

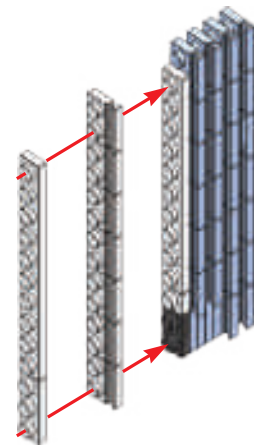

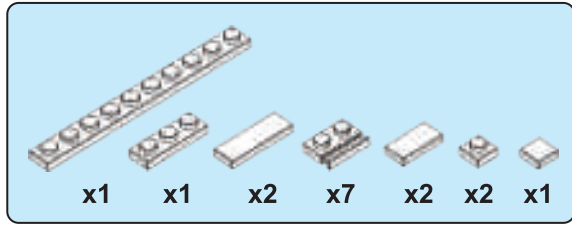

28

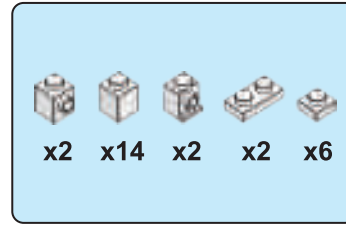

29

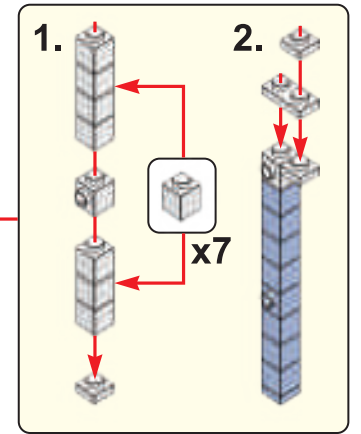
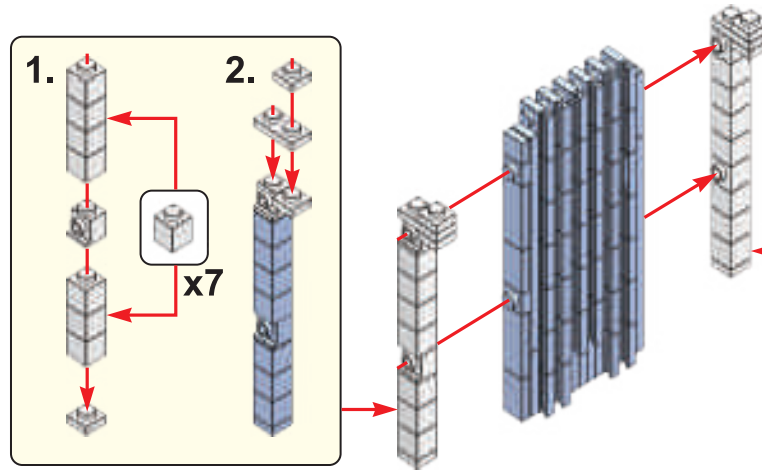
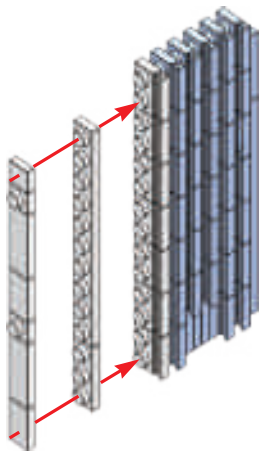

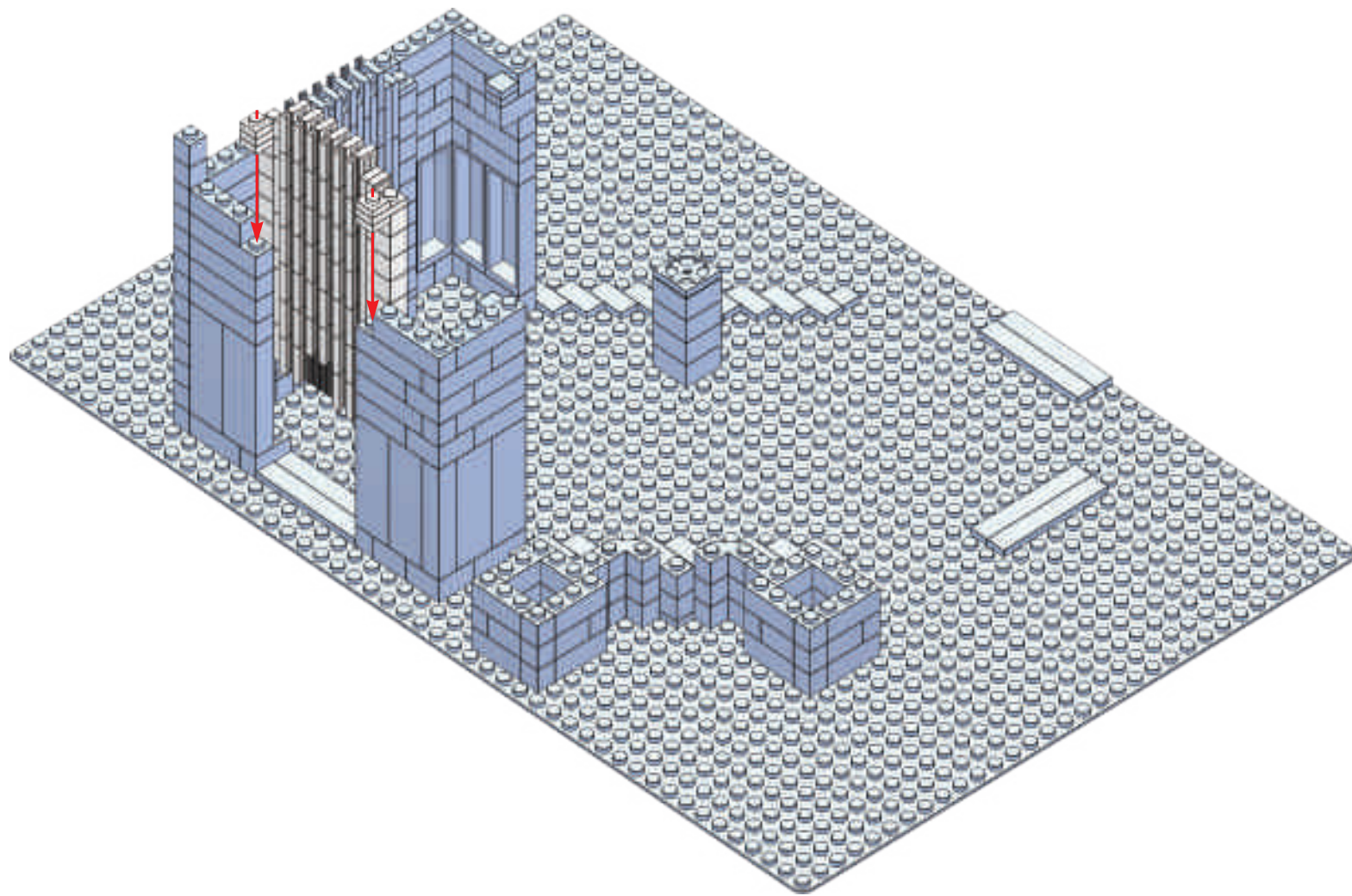

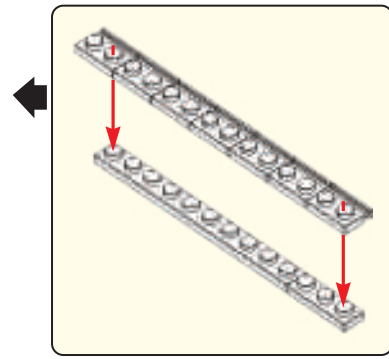
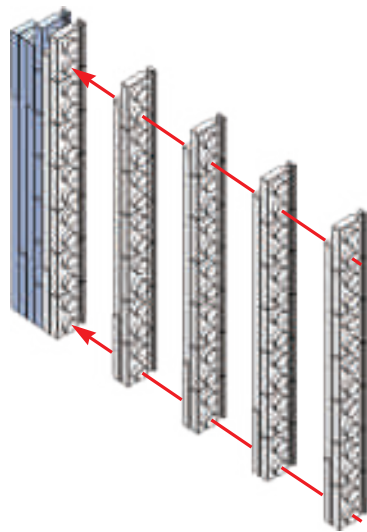
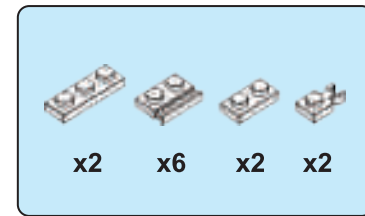
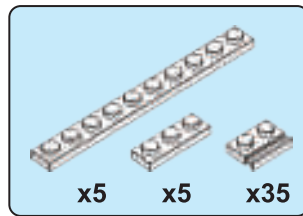
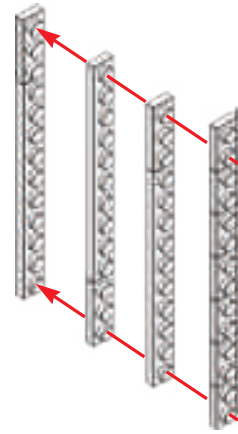
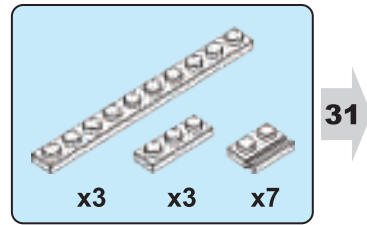

x5

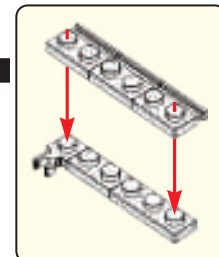
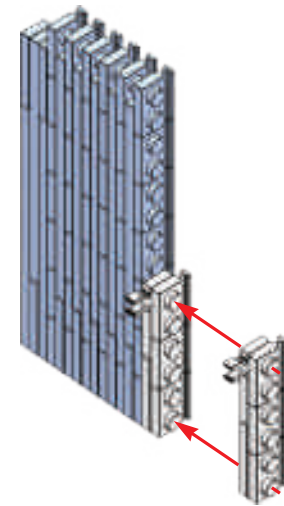

x2

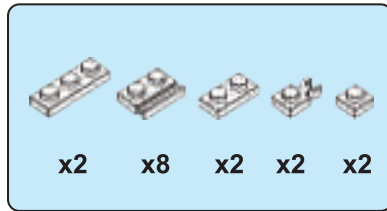

34

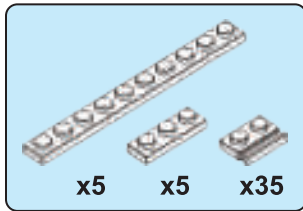

35

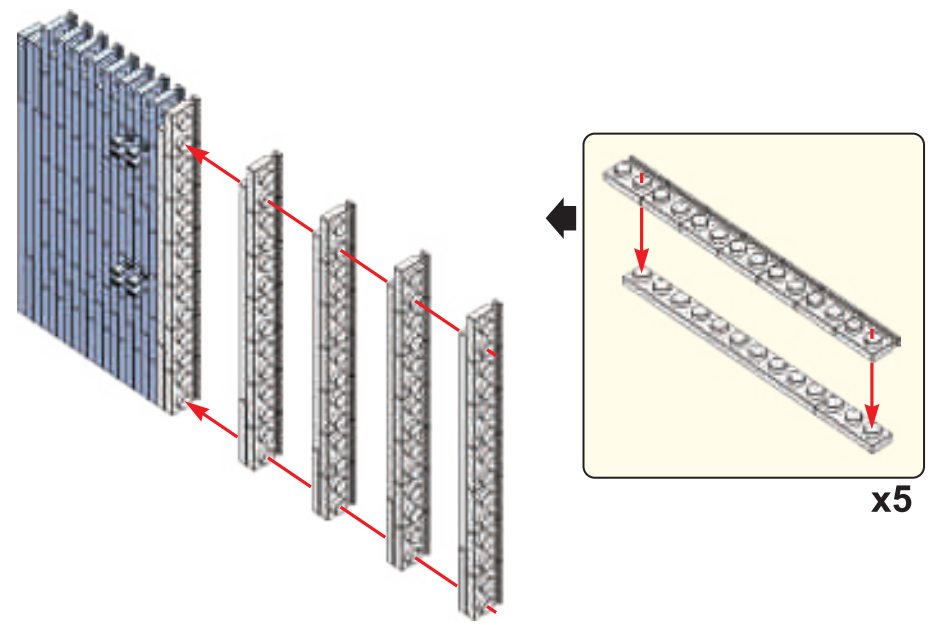
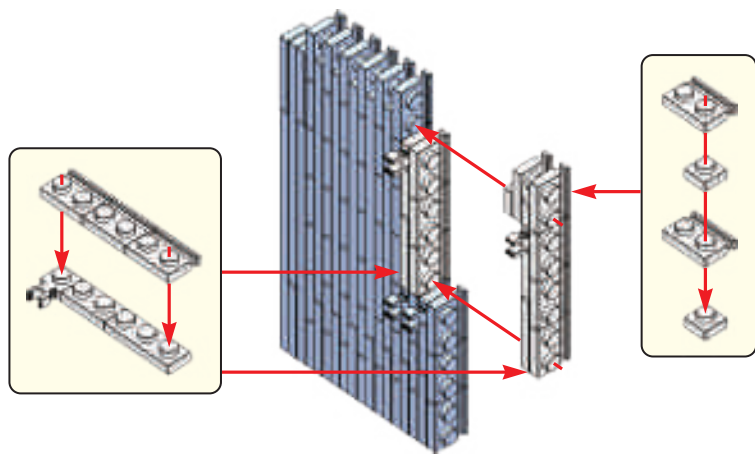

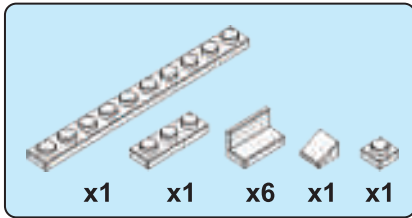

36

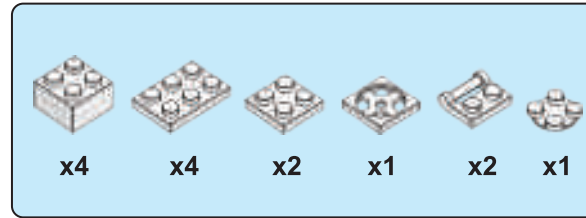

37

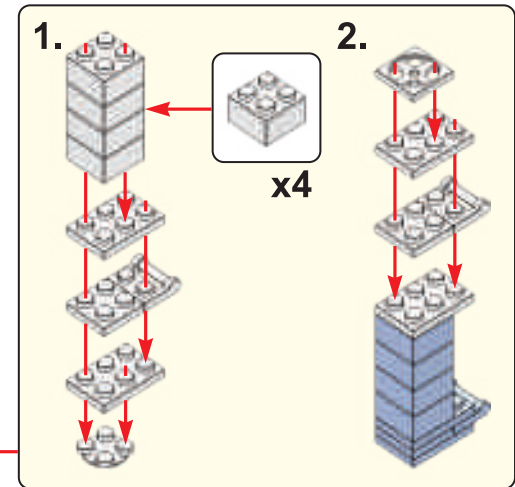
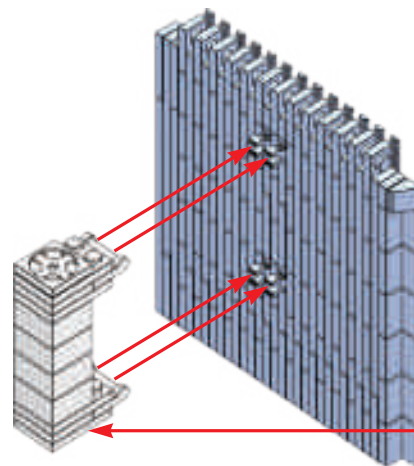
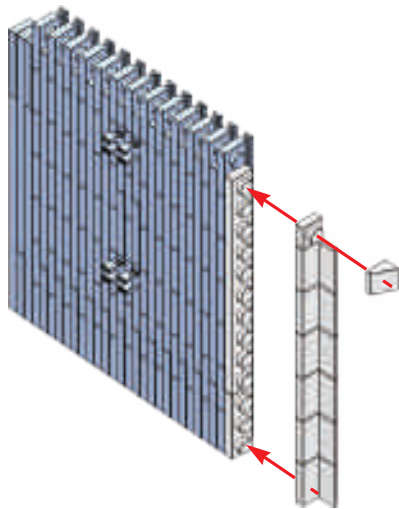

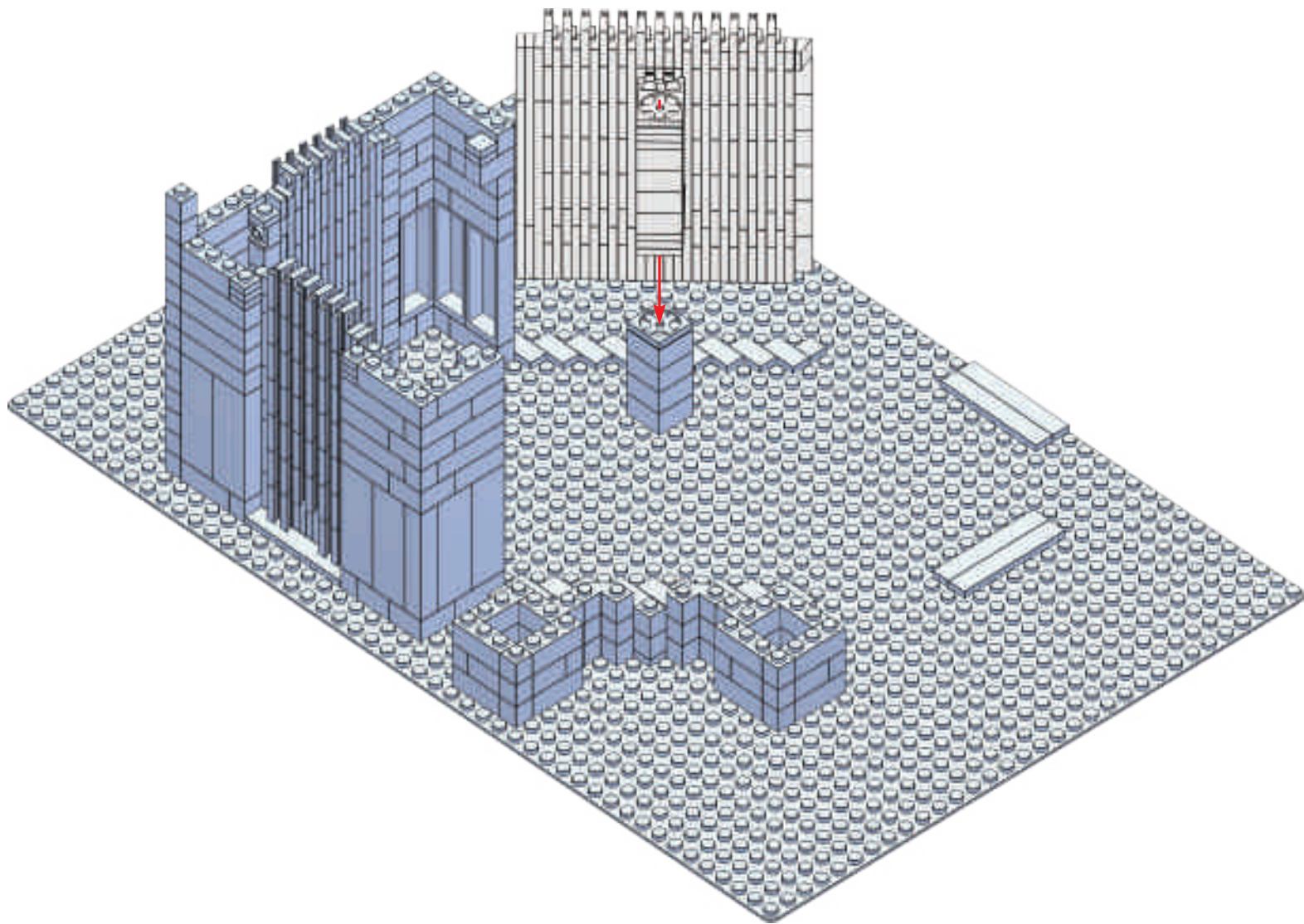

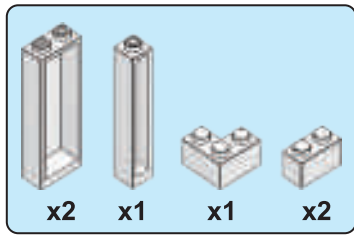

39

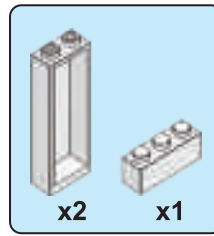
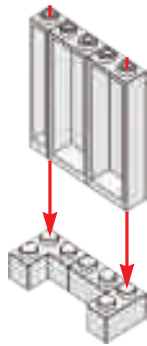

40

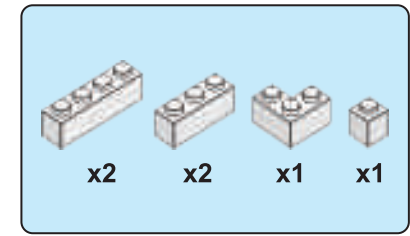
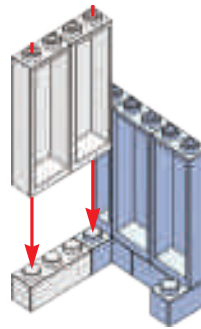

41

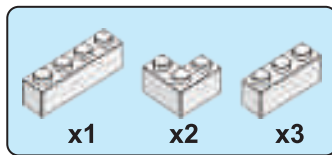
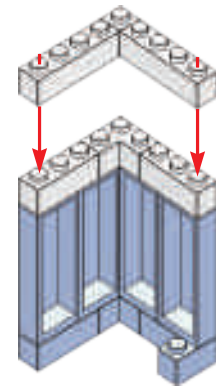

42

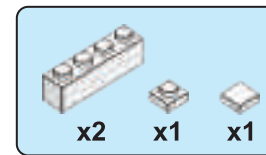
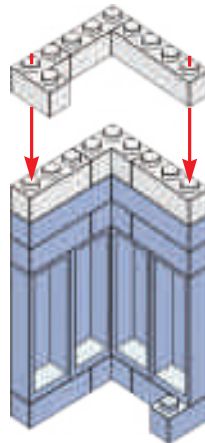

43

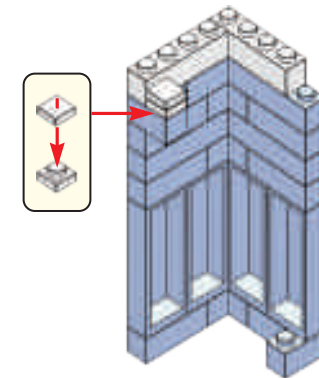

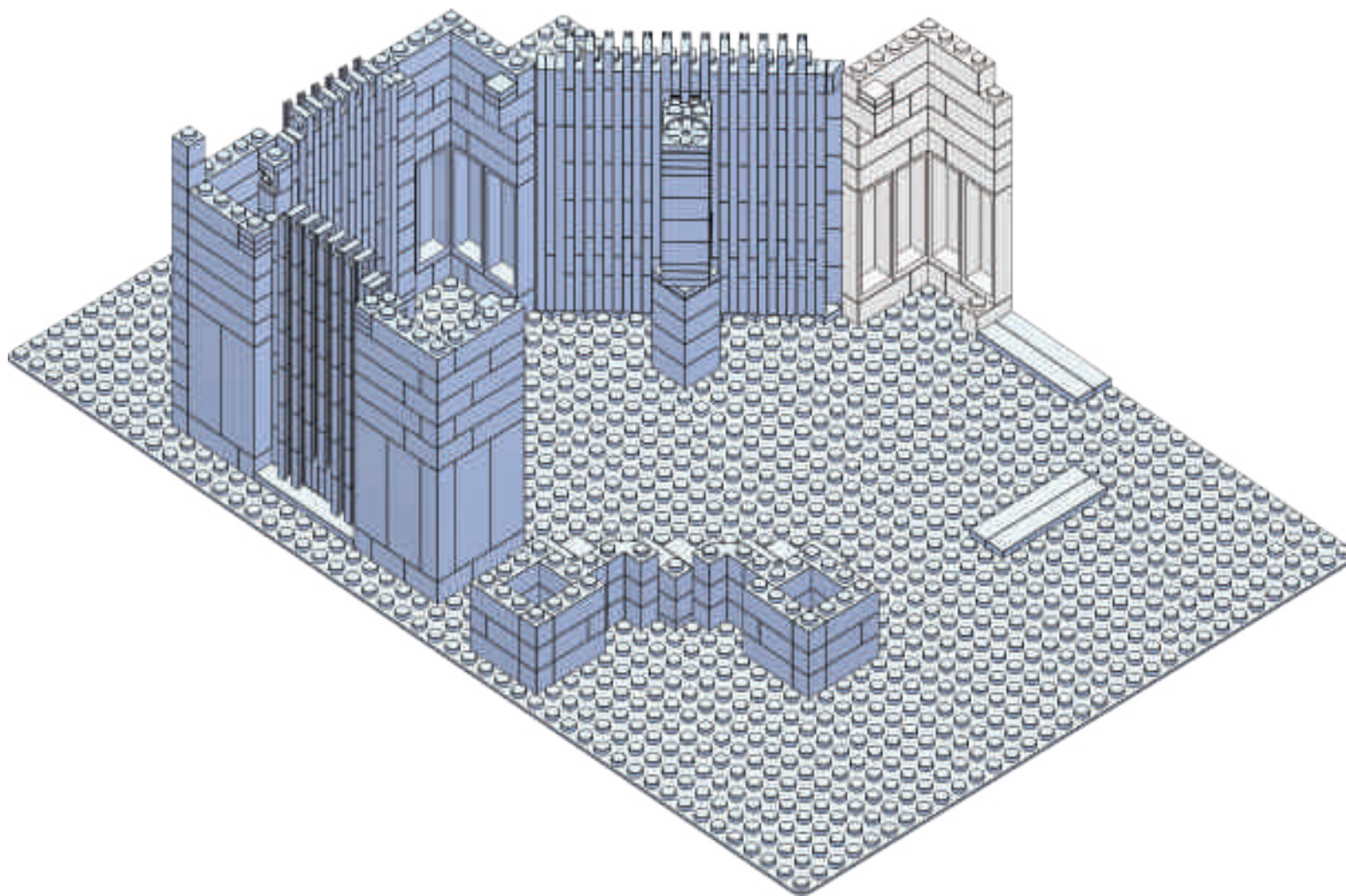

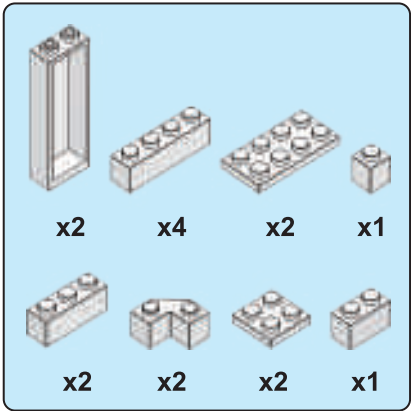

45

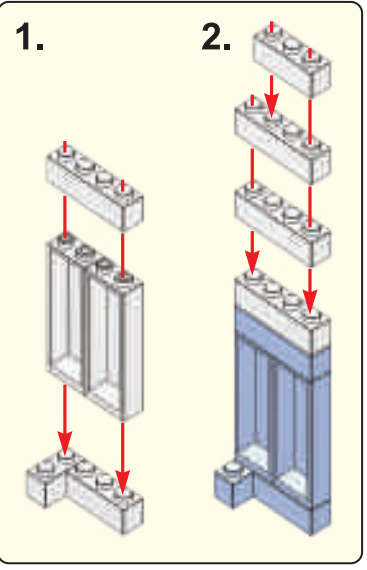
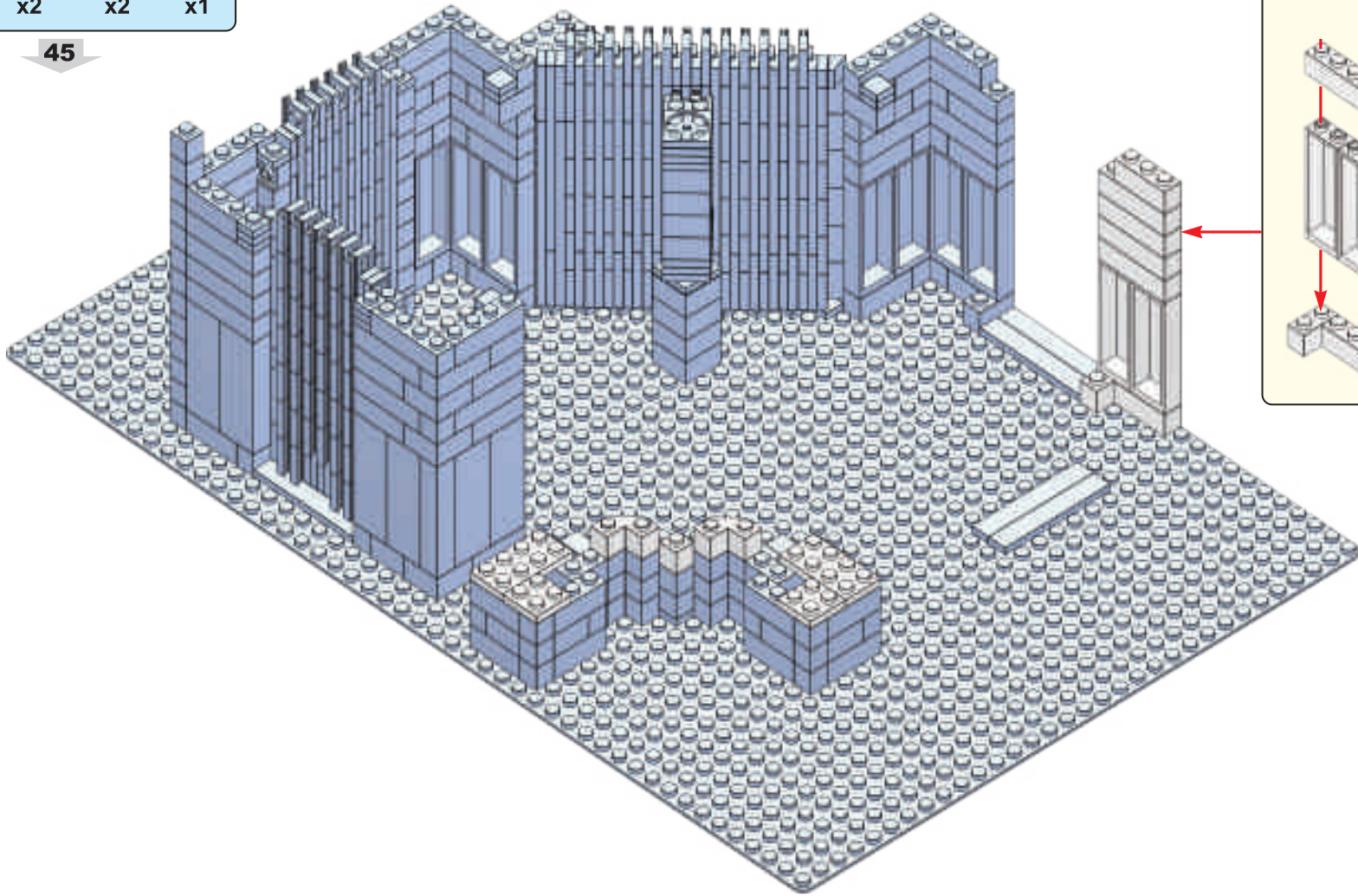

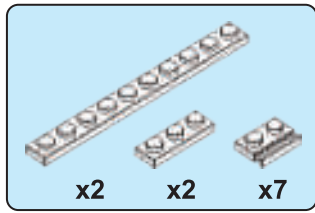

46

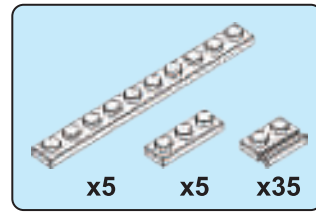

47

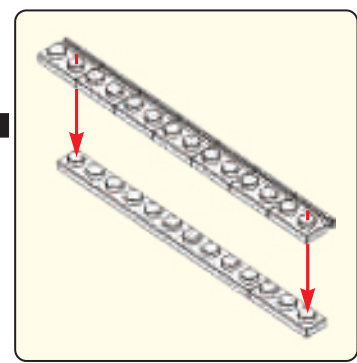
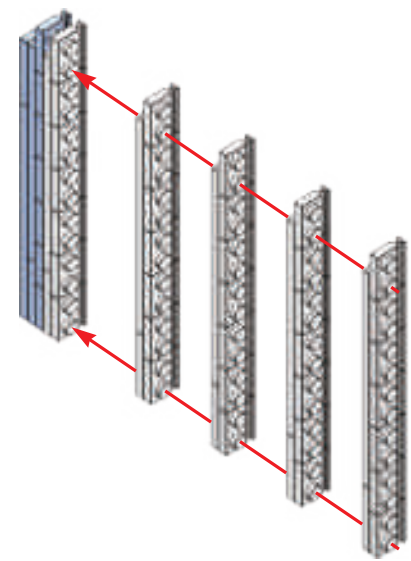
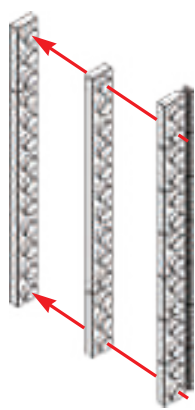

x5

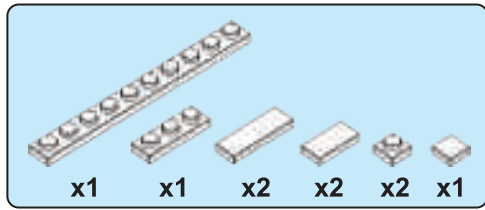

48

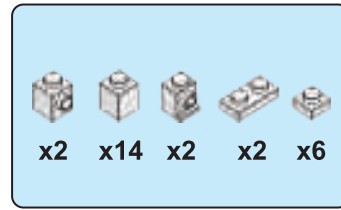

49

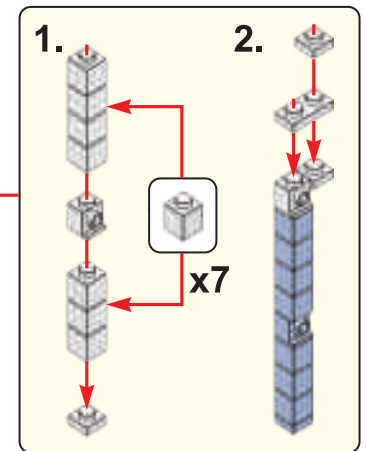
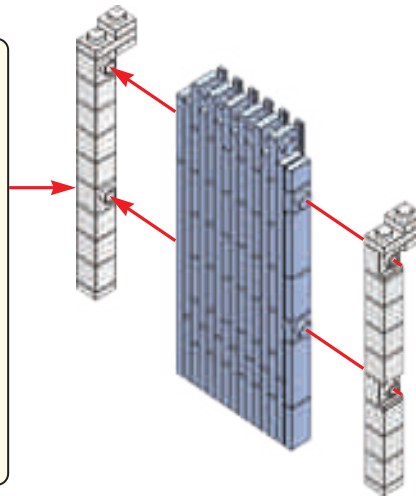
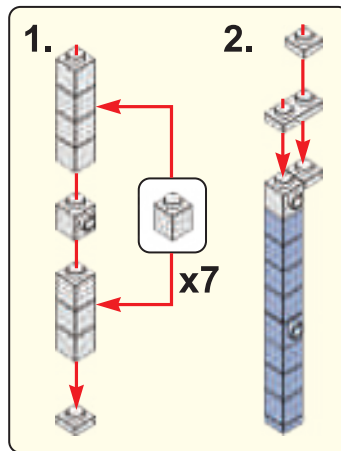
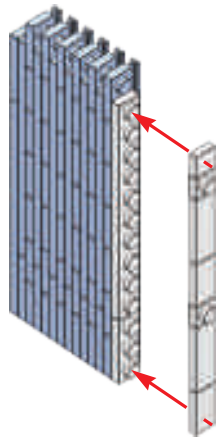

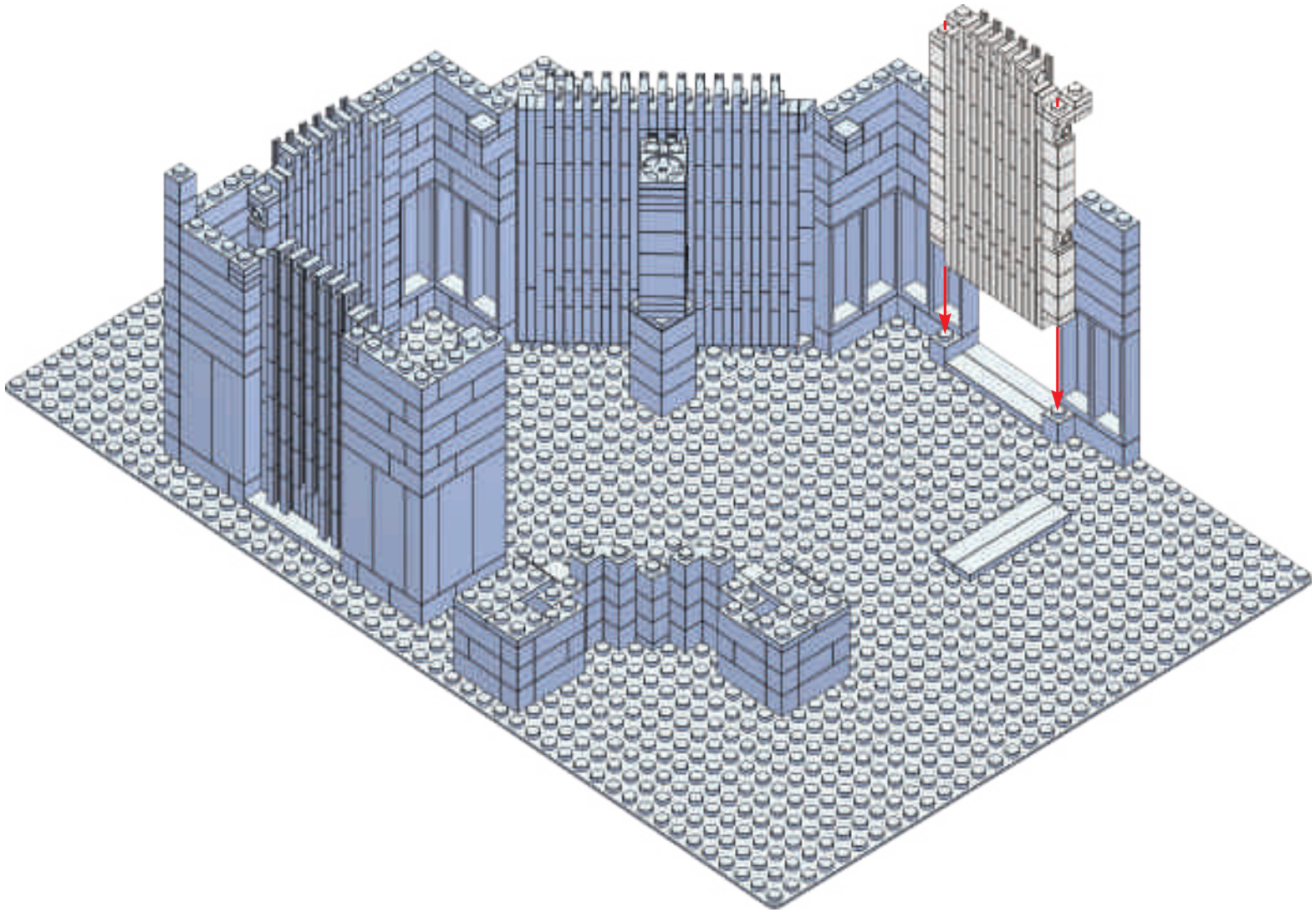

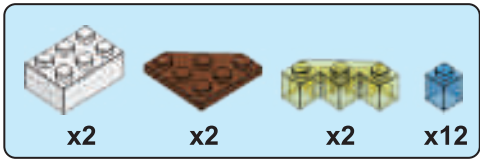

51

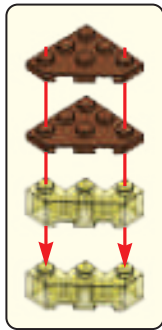
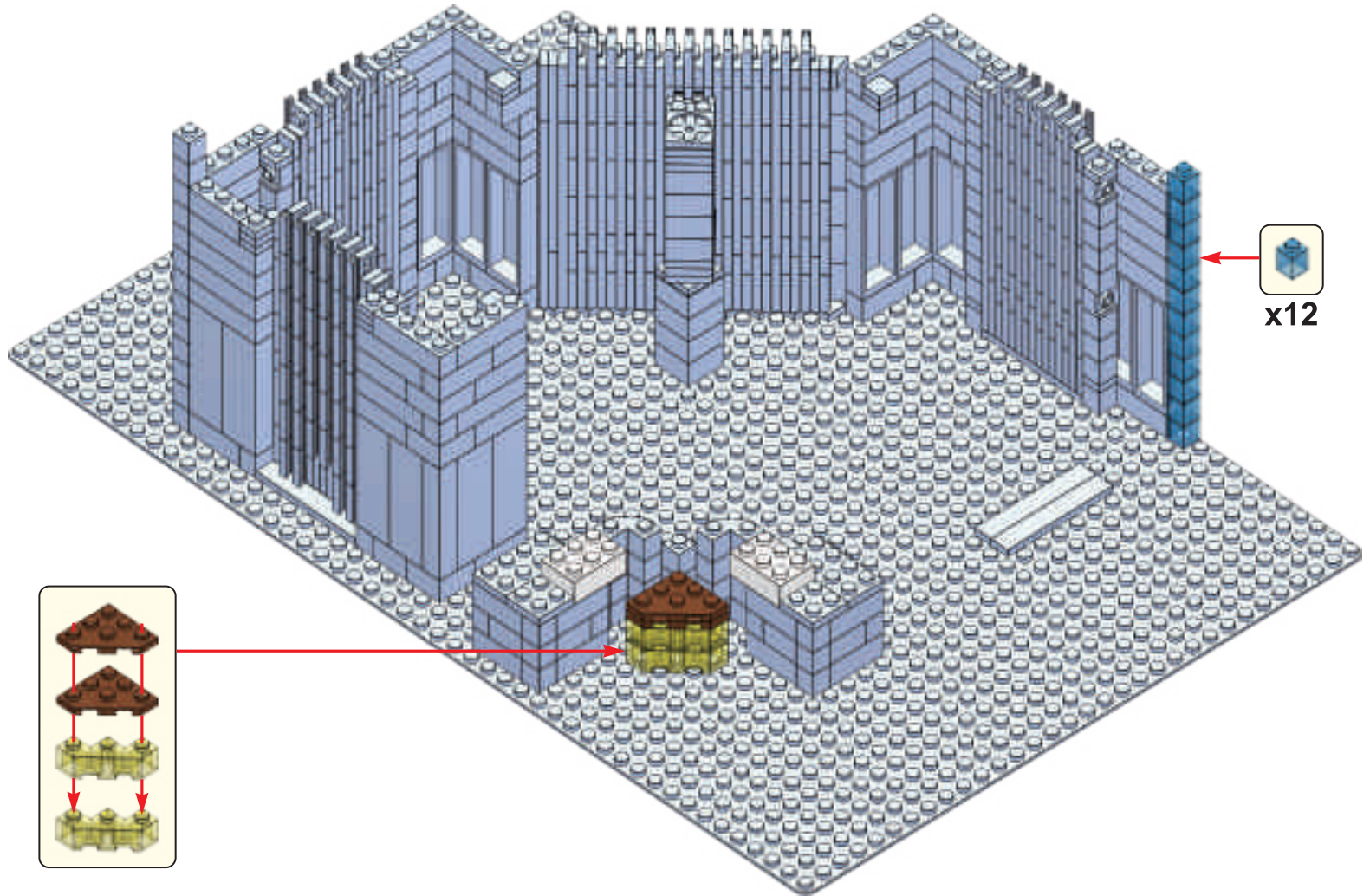

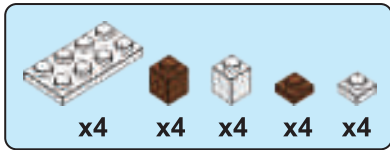

52

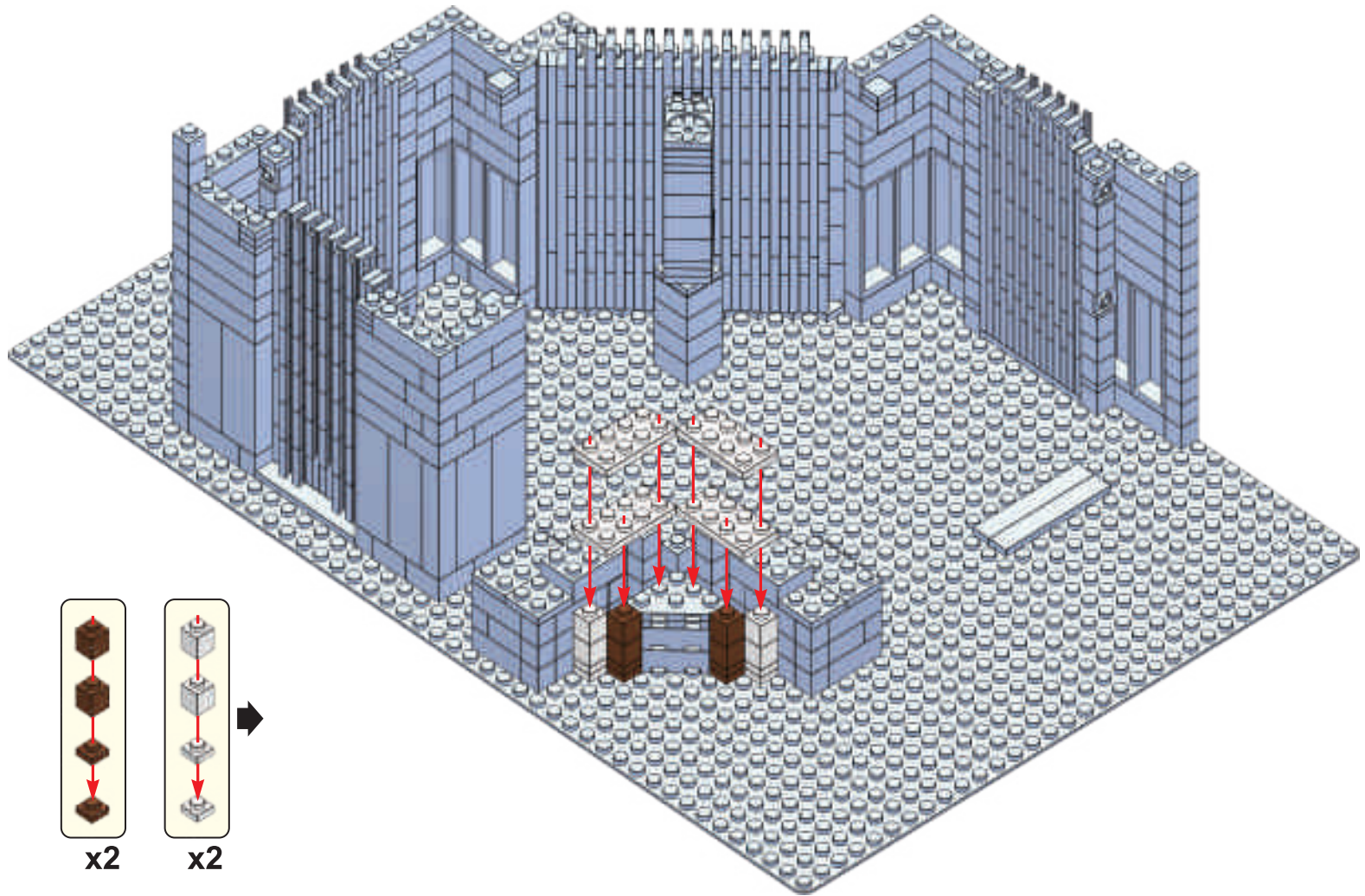

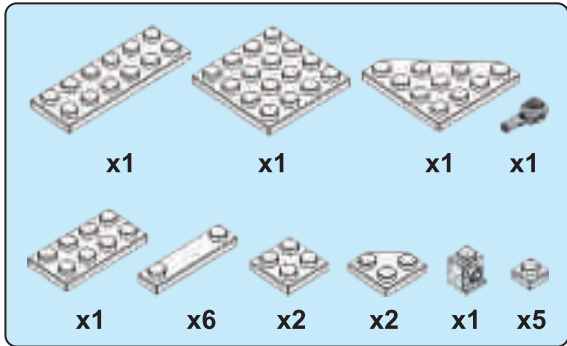

53

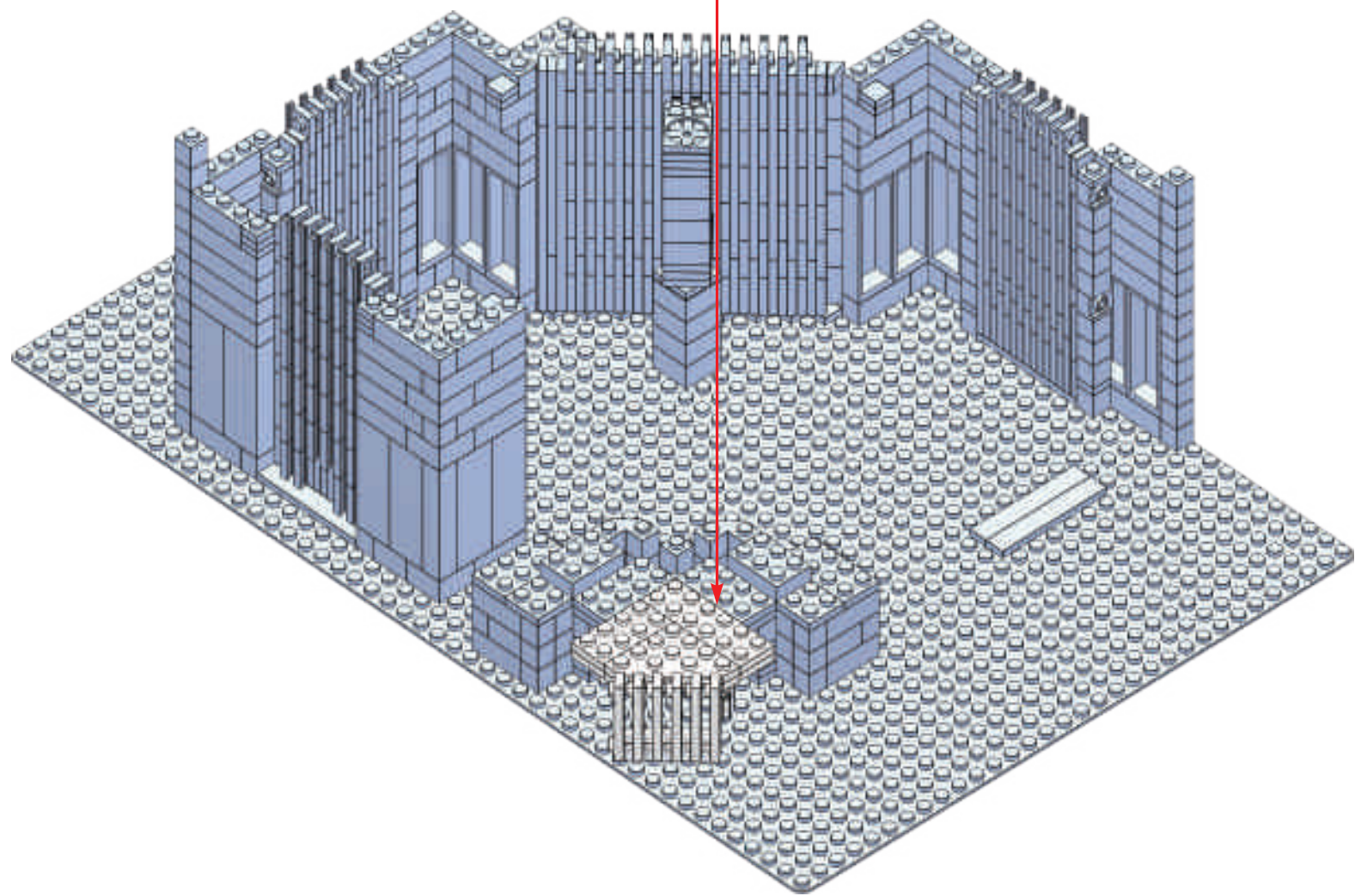
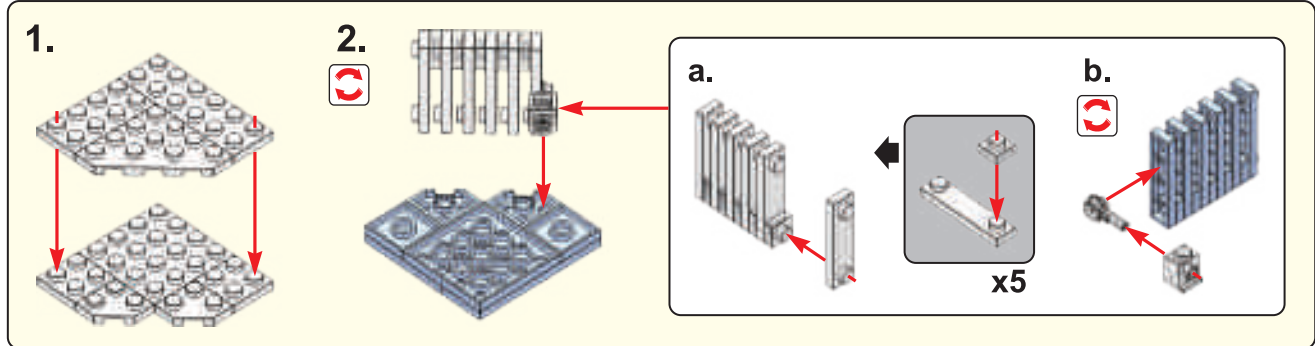

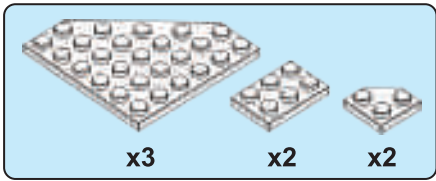

54

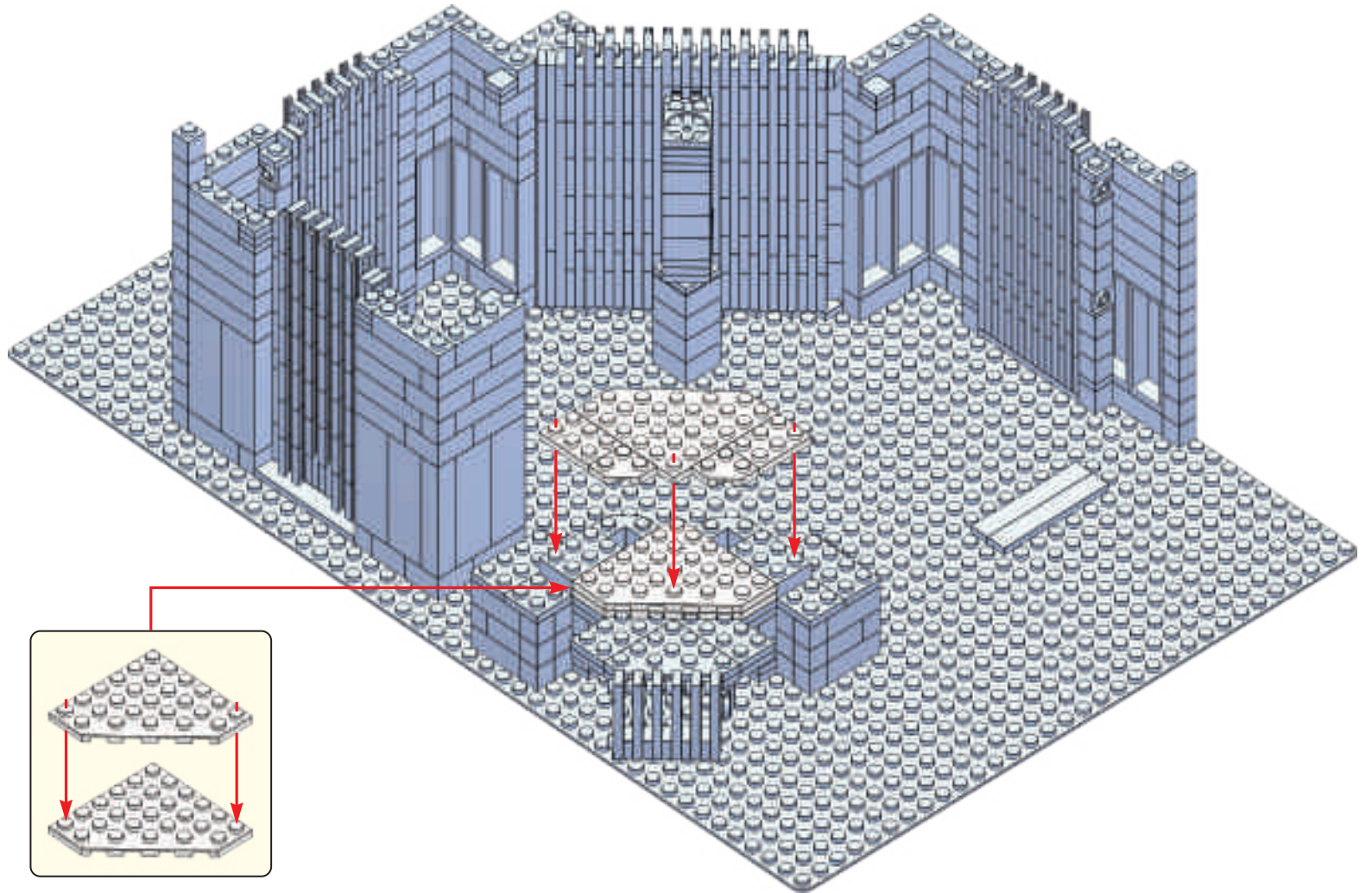

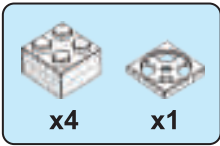

55

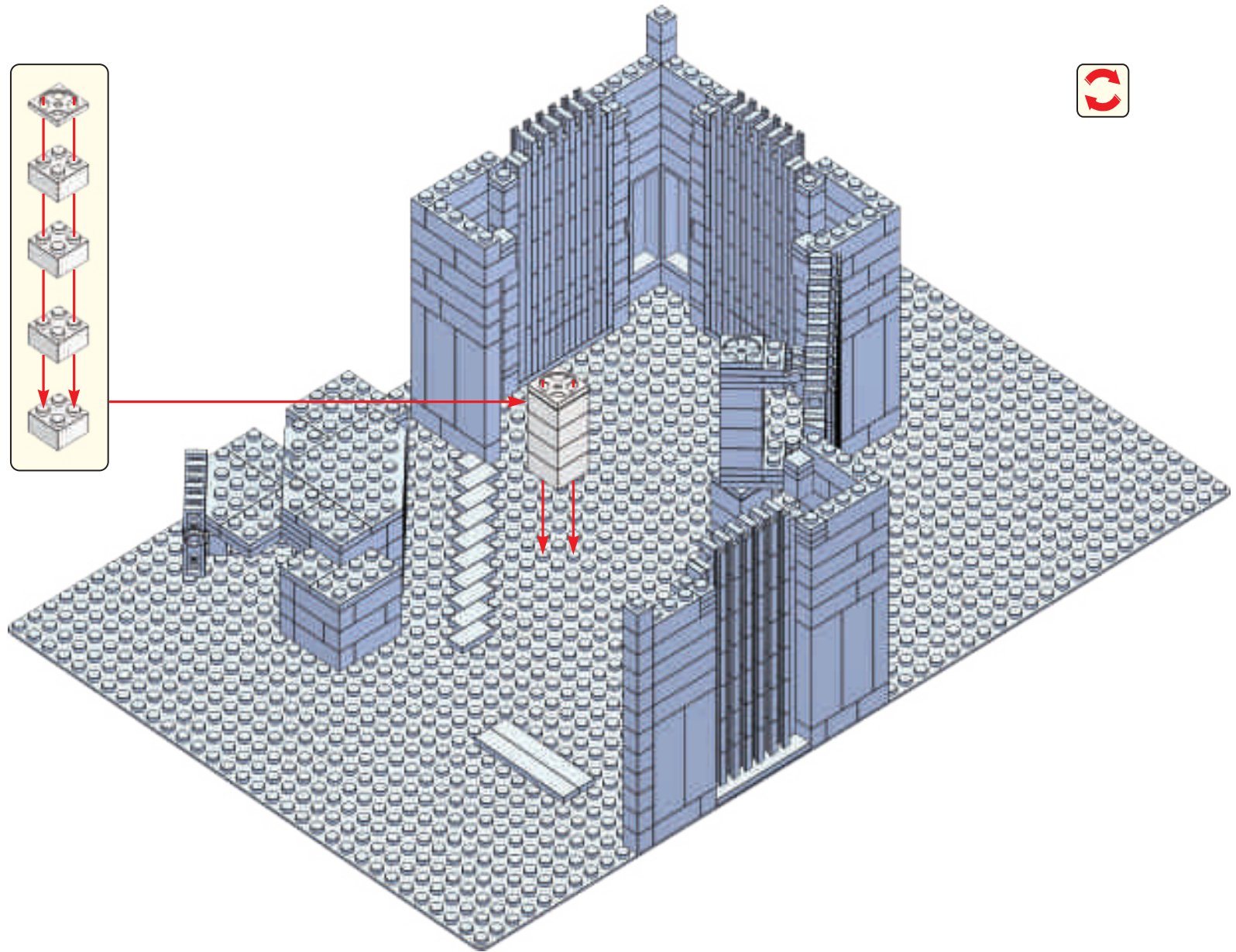
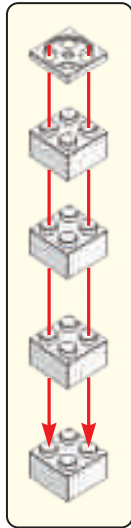

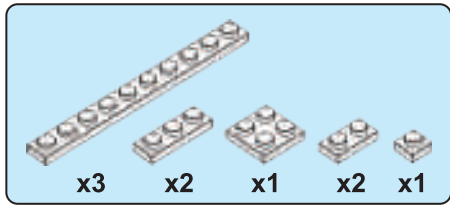

56

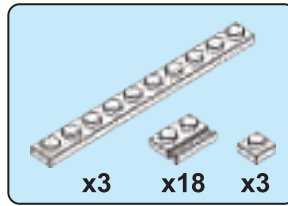

57

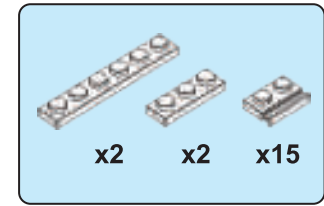

58

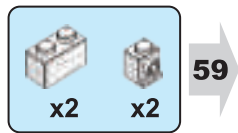
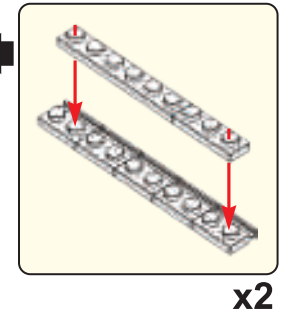
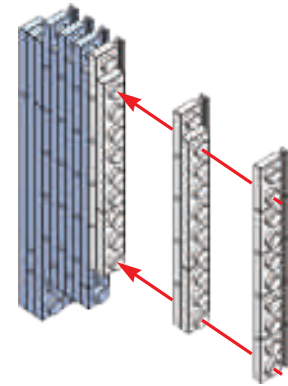
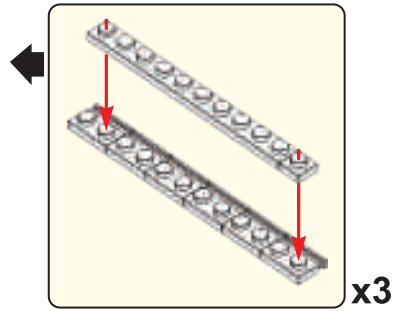
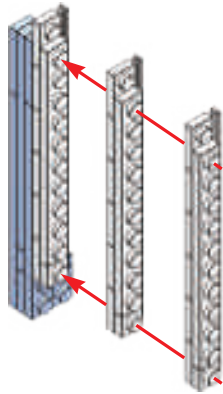
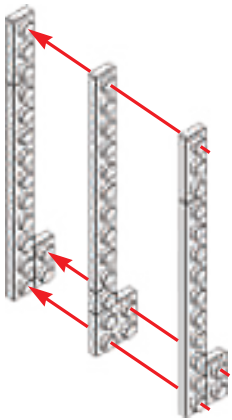

59

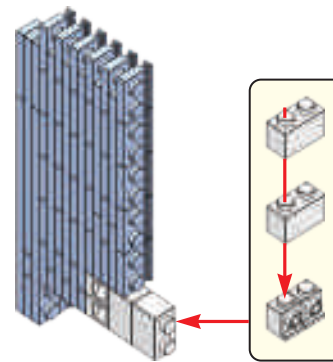

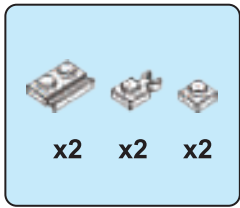

60

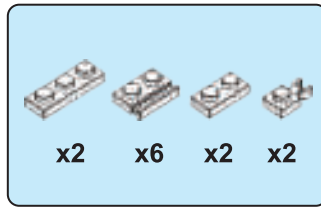

61

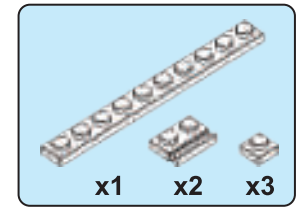

62

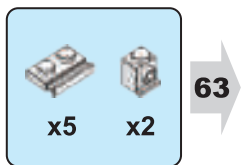
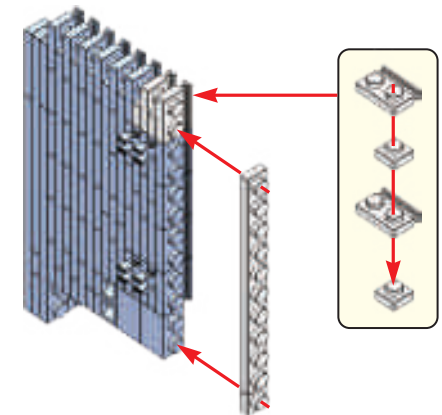
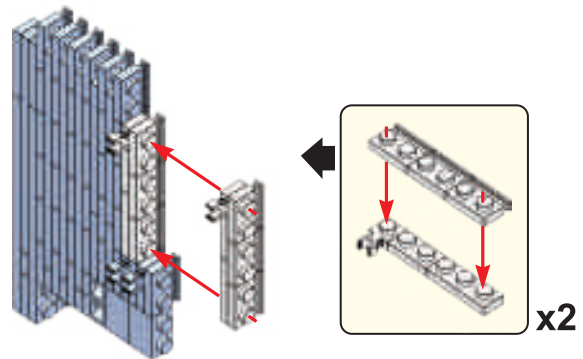
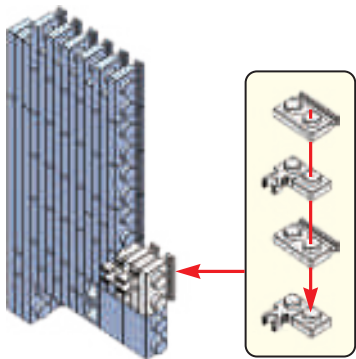

63

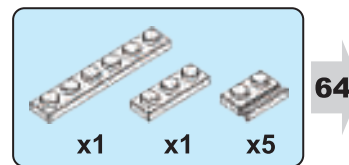
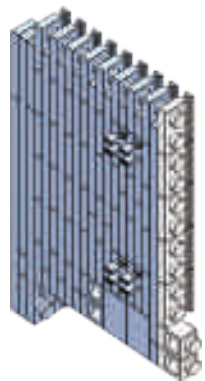

64

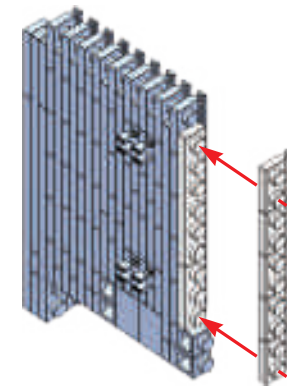

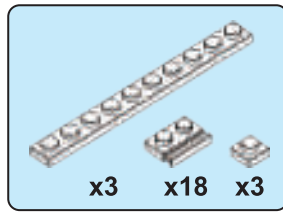

65

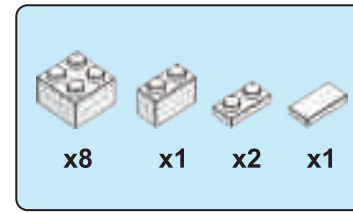

66

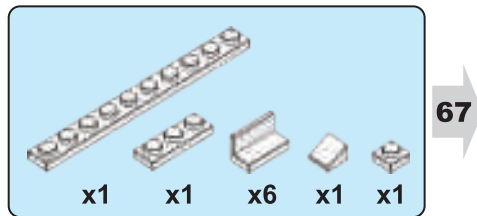
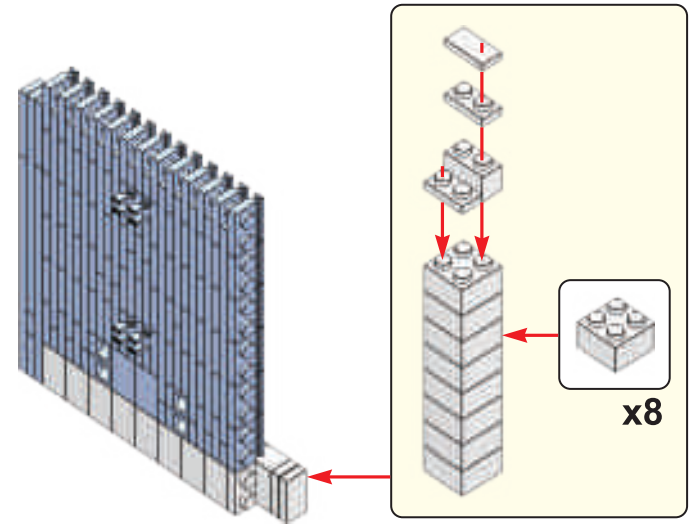
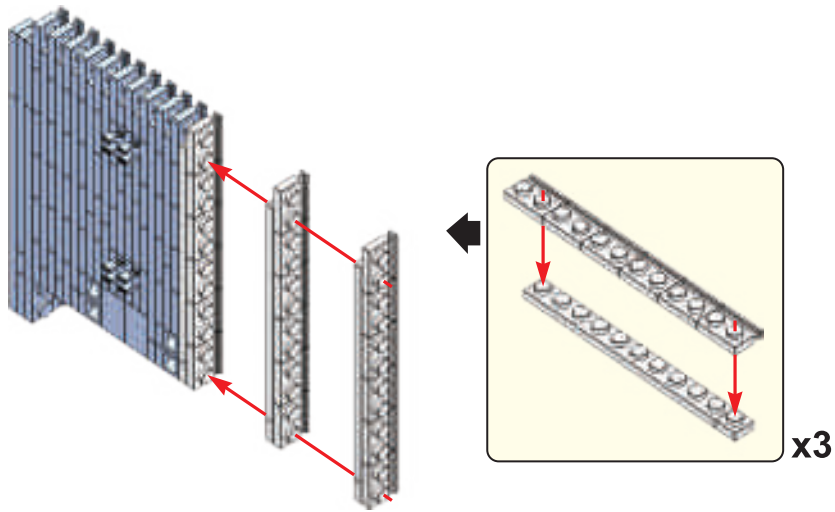

67

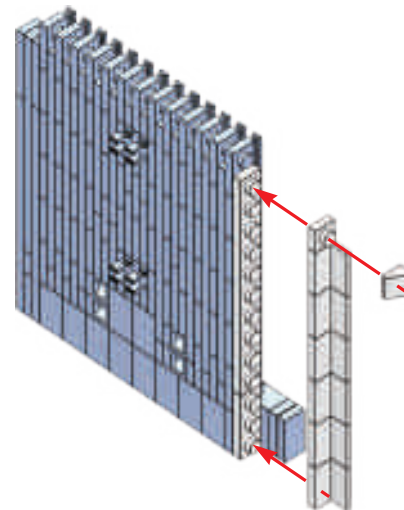

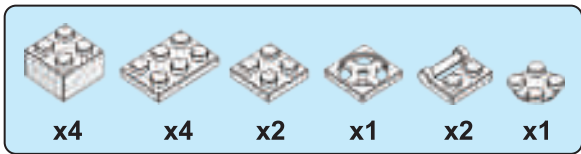

68

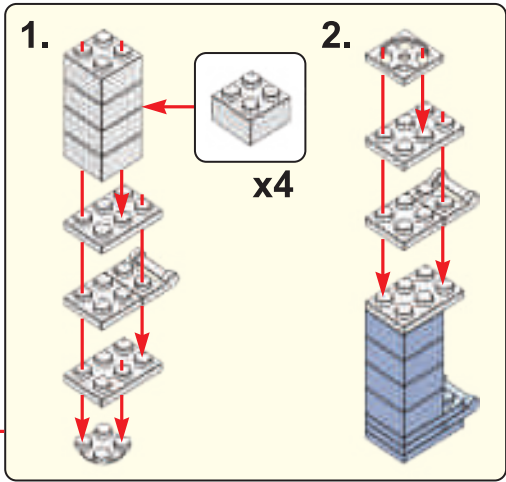
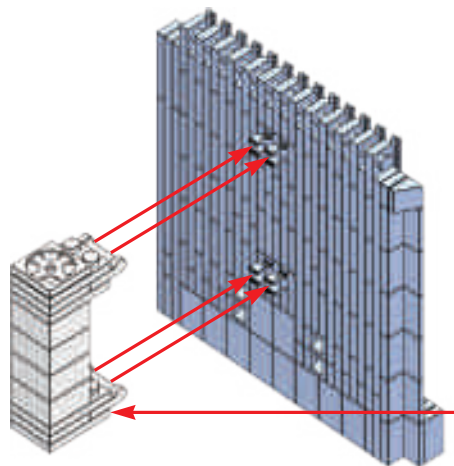

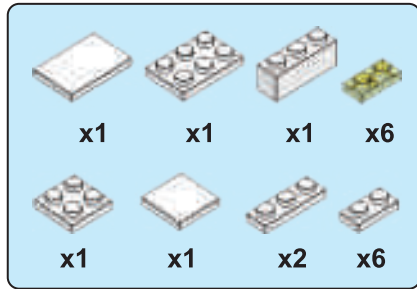

69

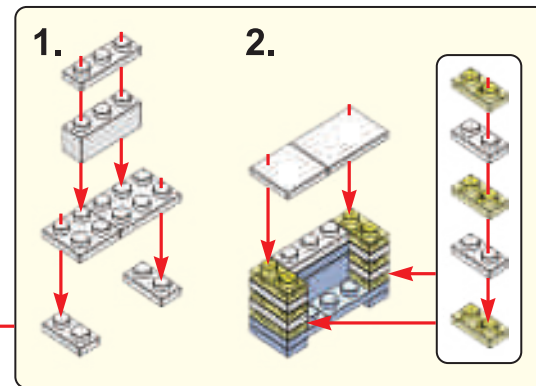
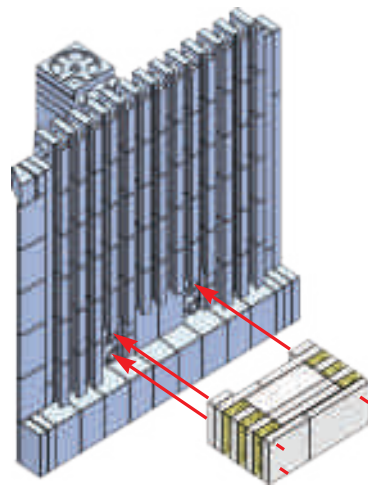

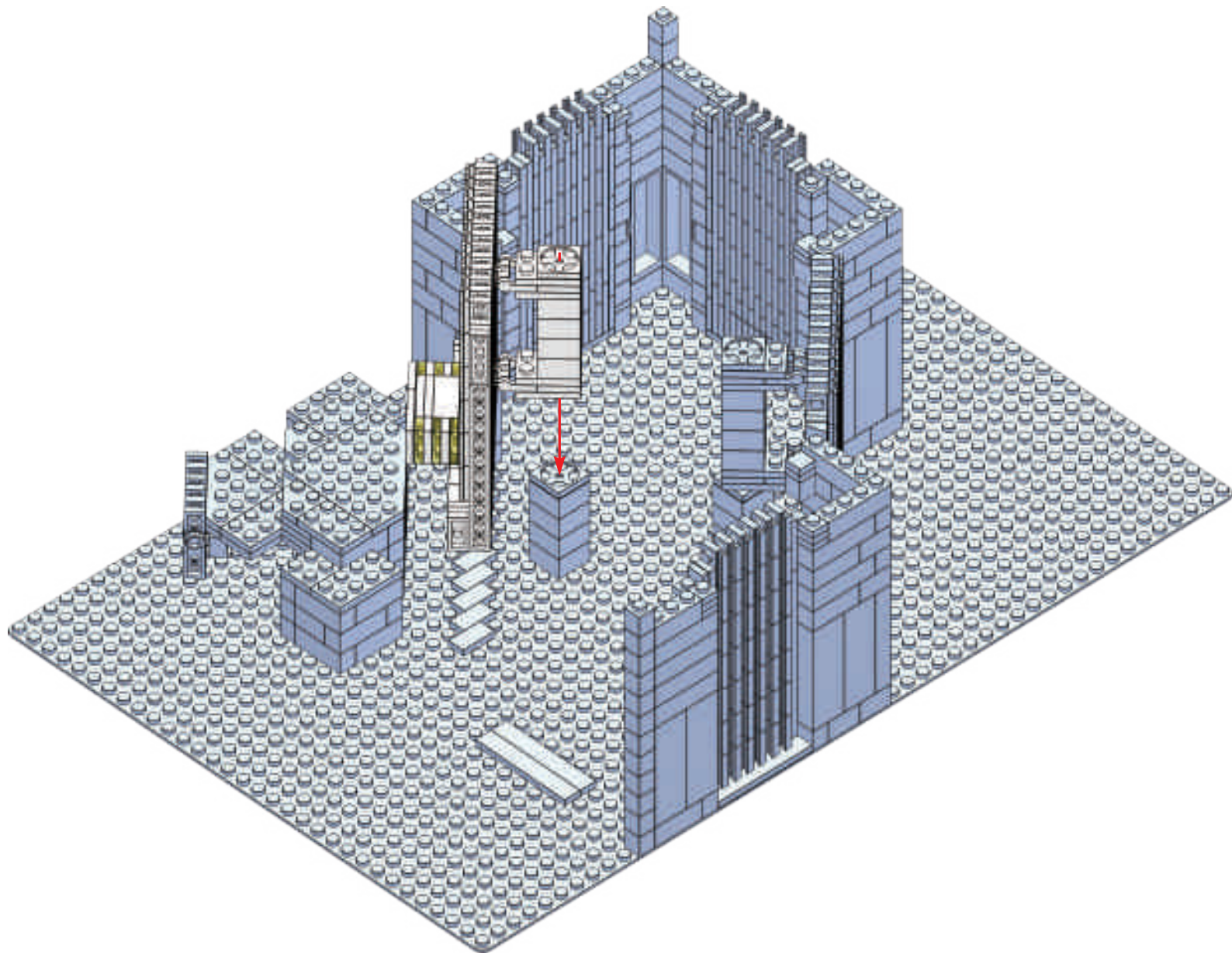

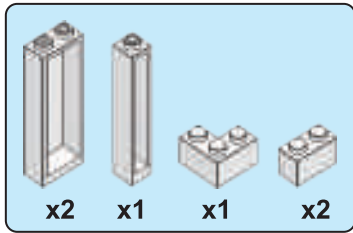

71

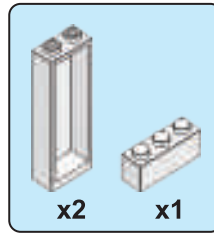
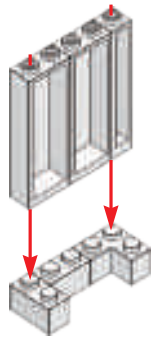

72

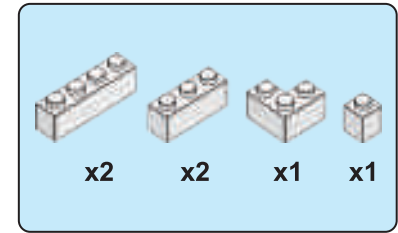
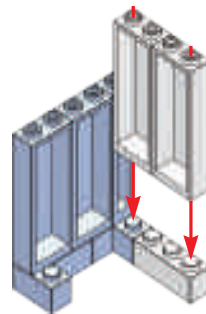

73

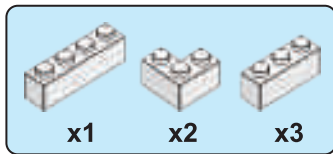
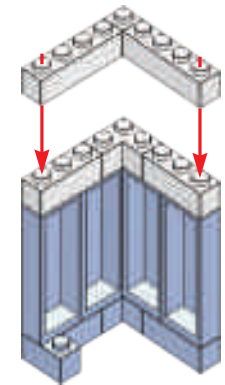

74

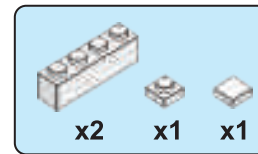
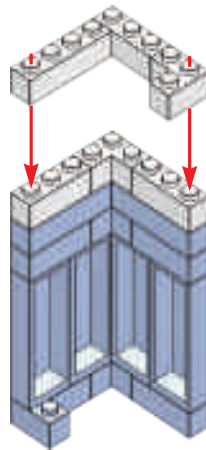

75

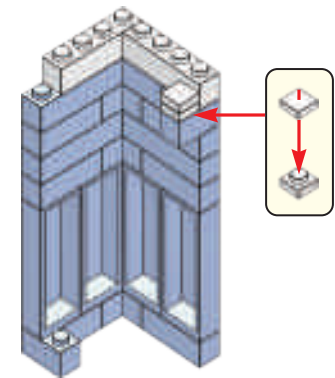

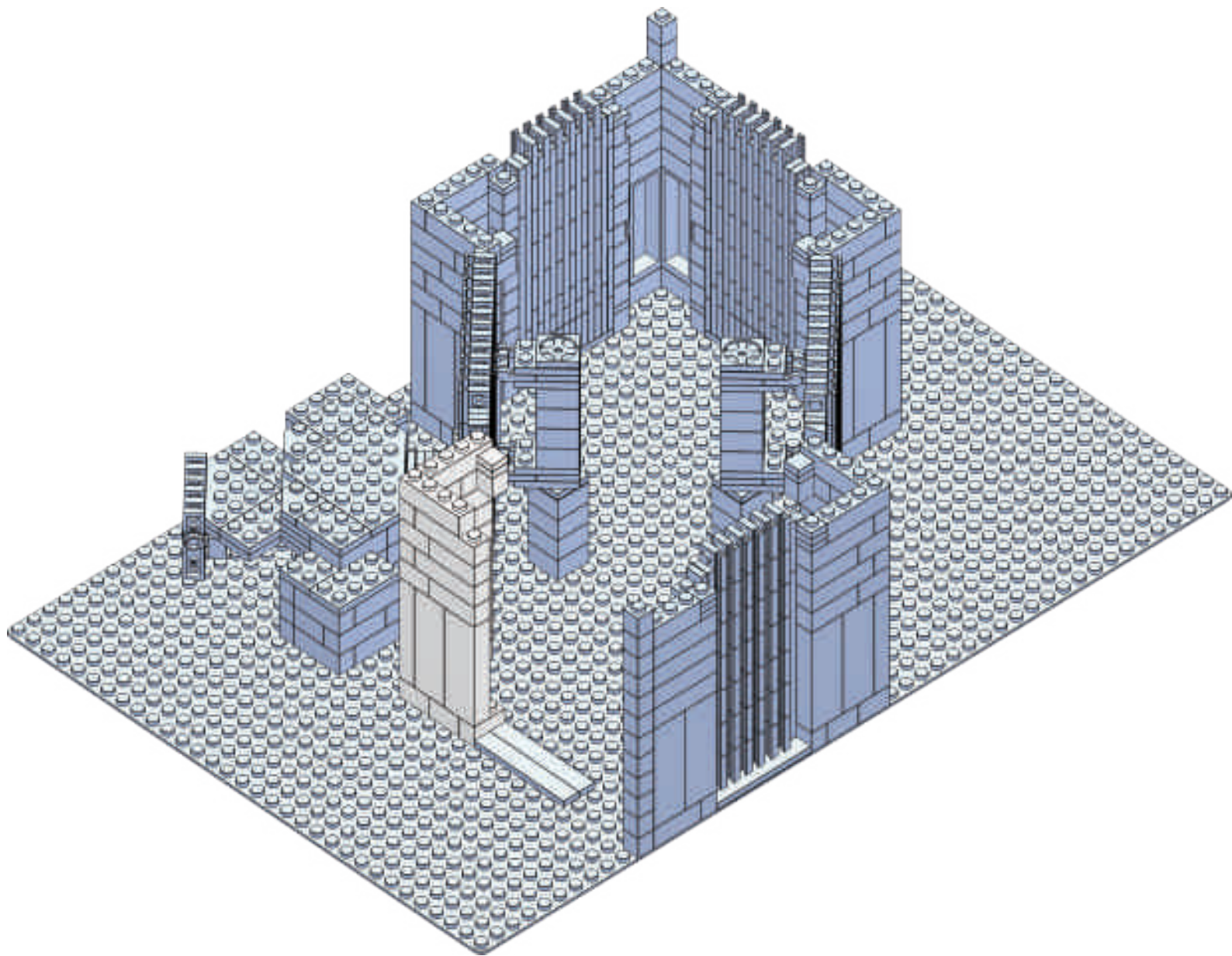

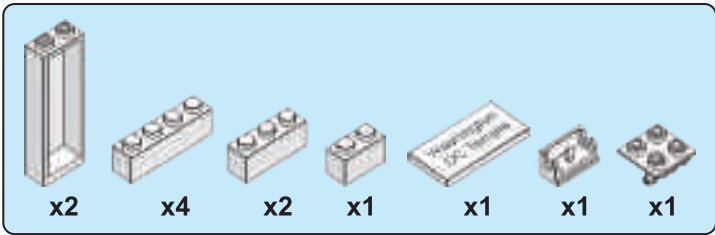

77

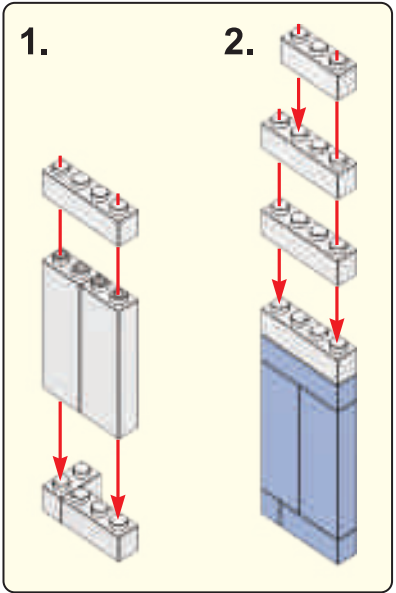
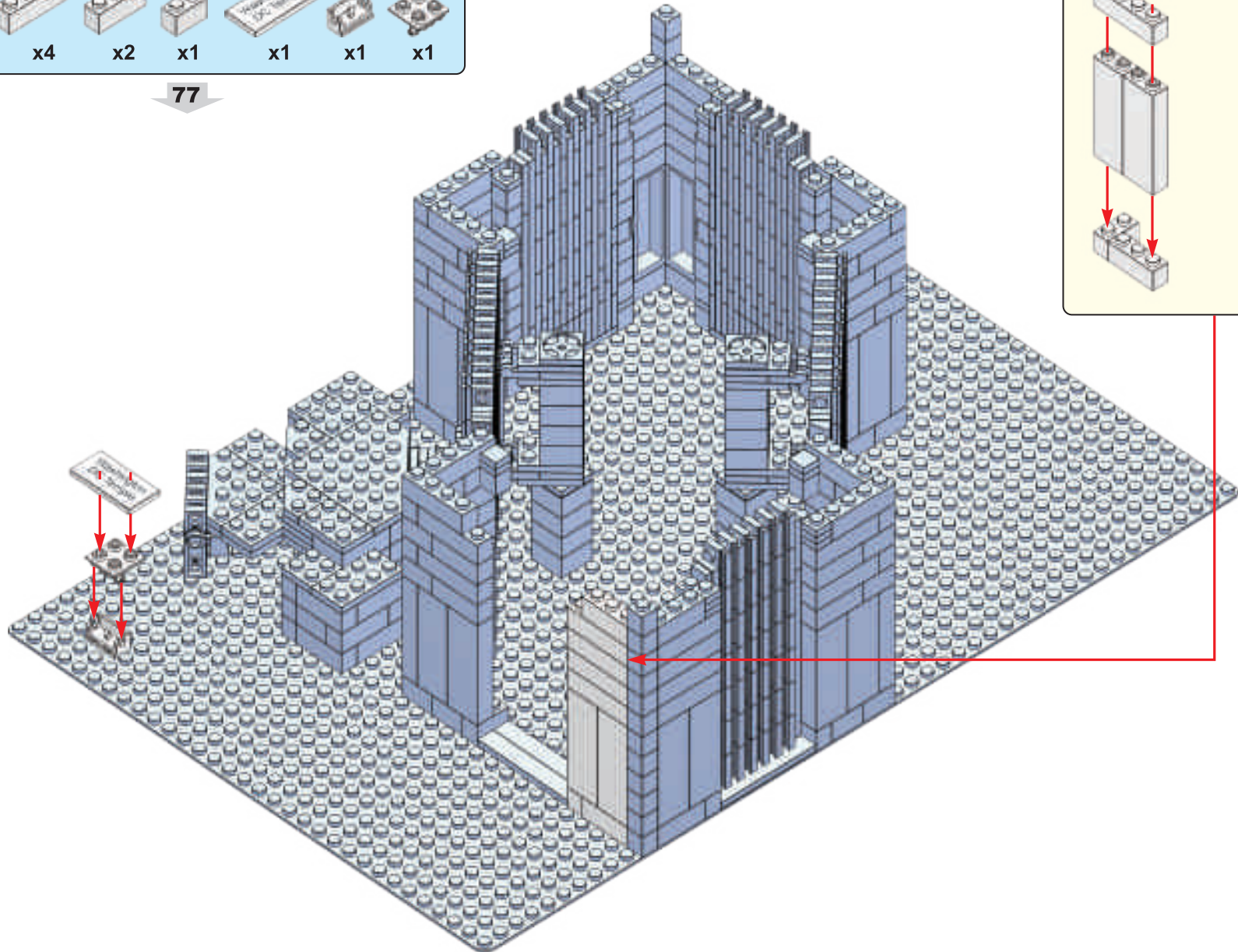

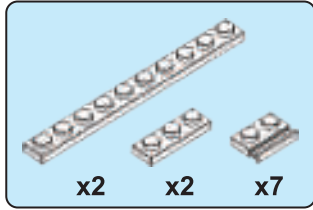

78

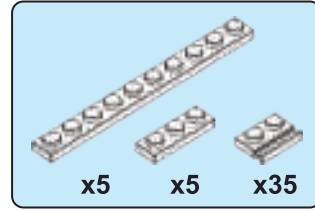

79

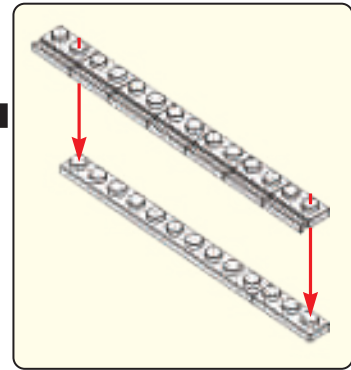
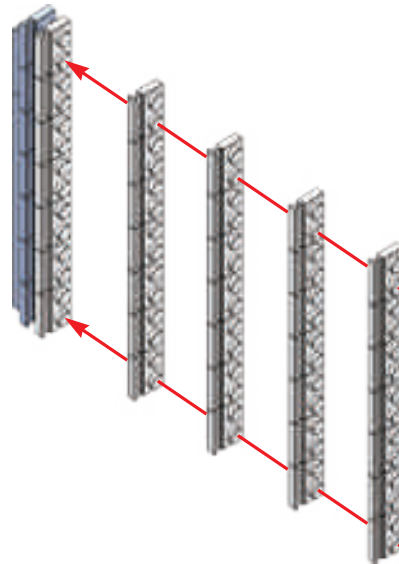
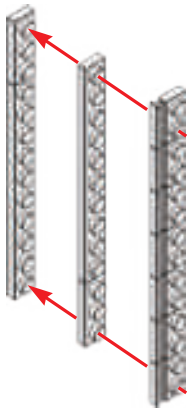

x5

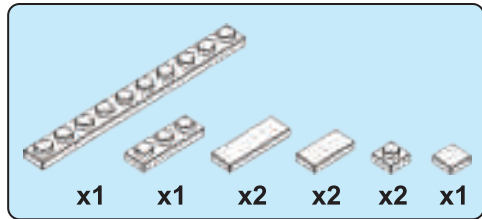

80

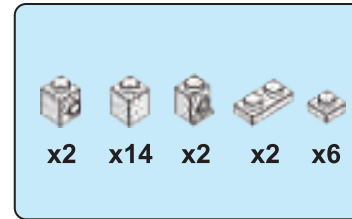

81

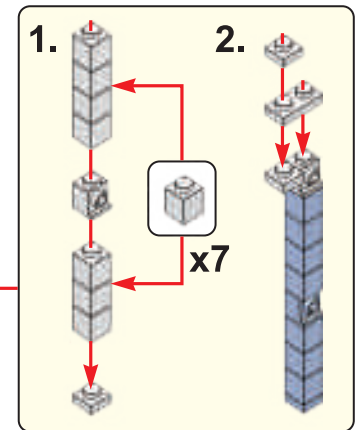
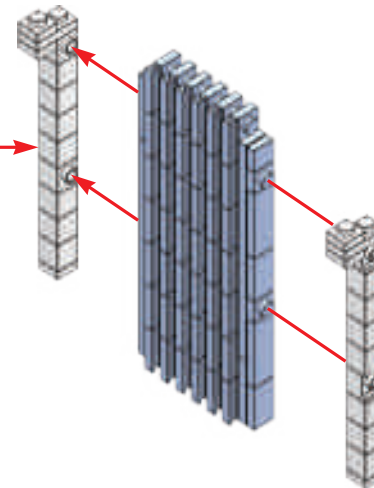
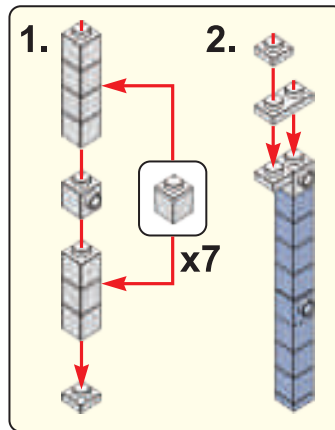
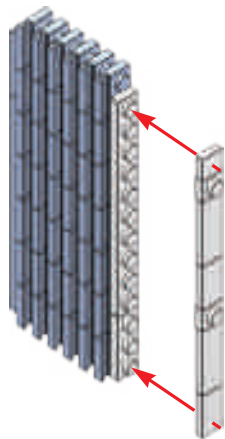

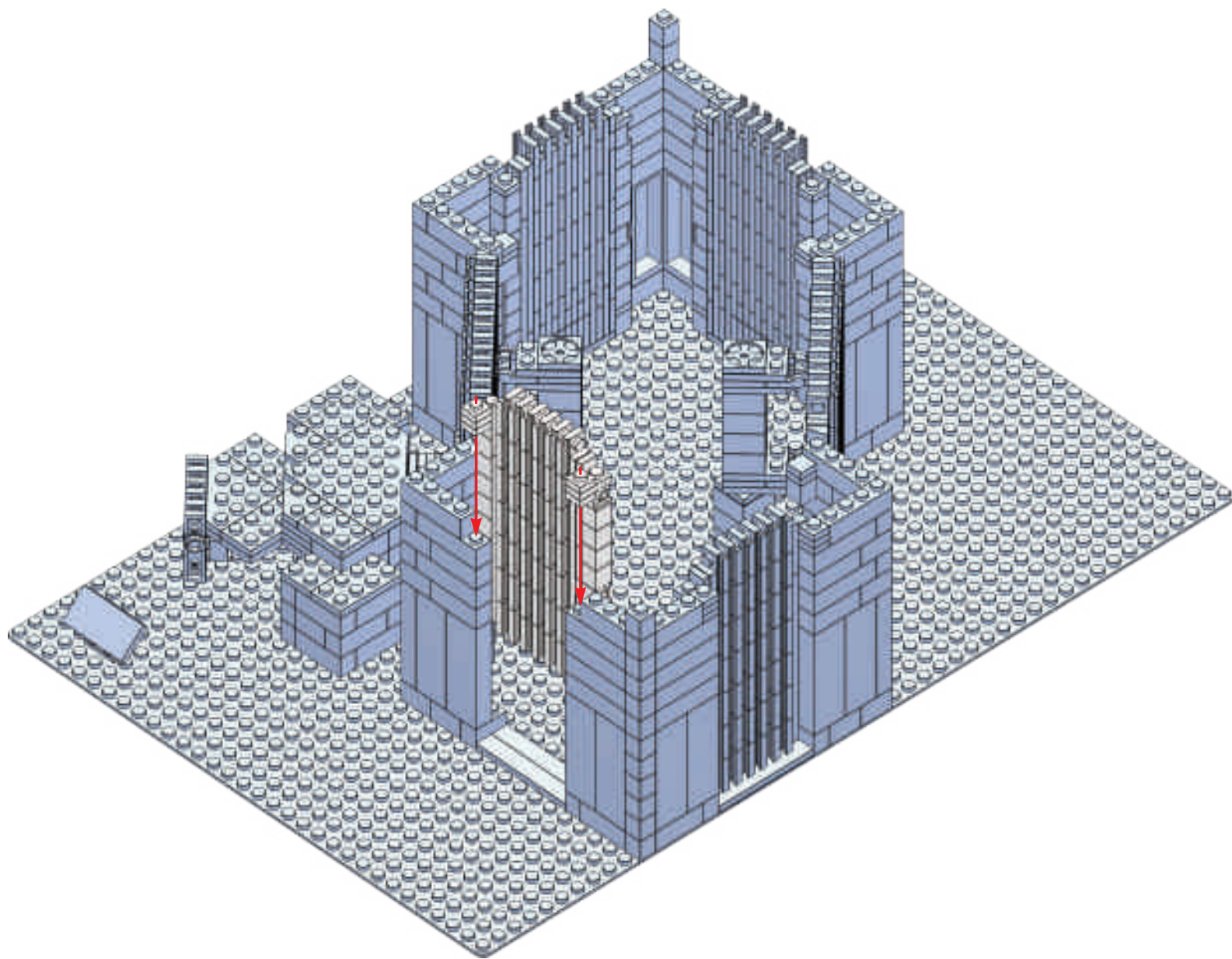

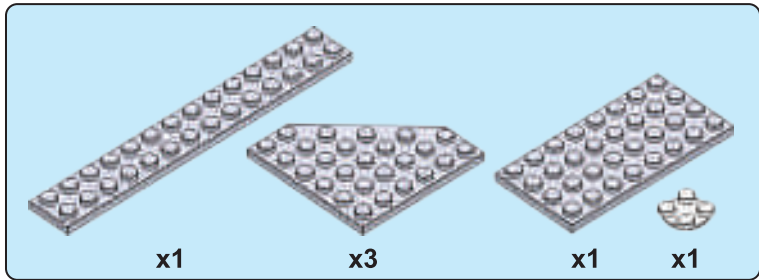

83

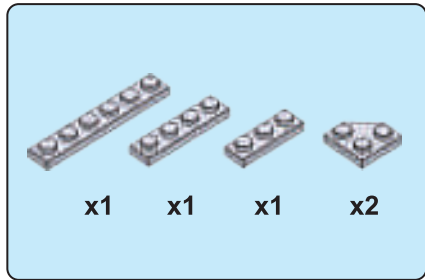

84

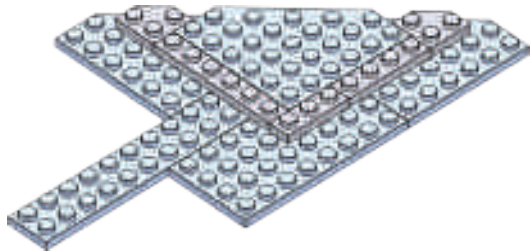
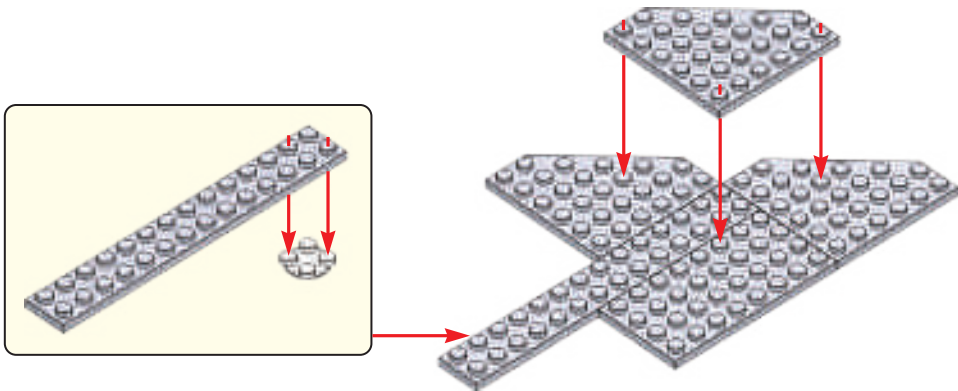

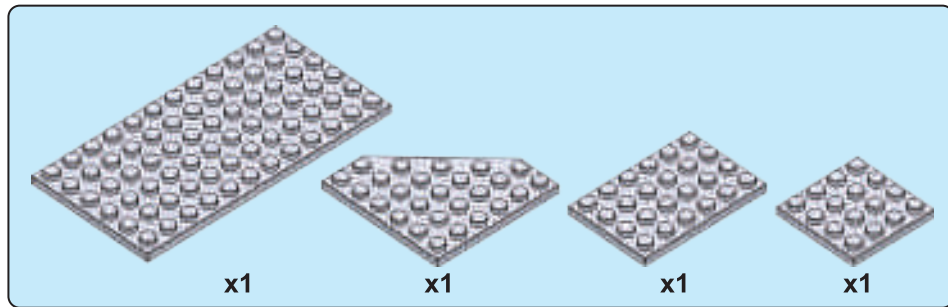

85

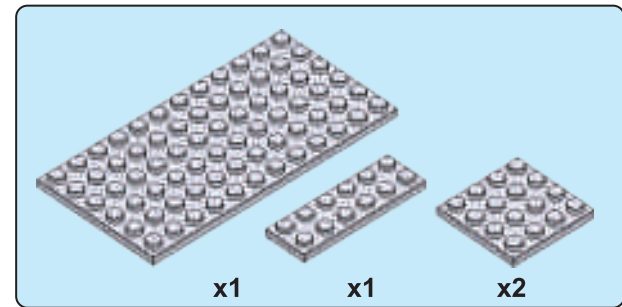

86

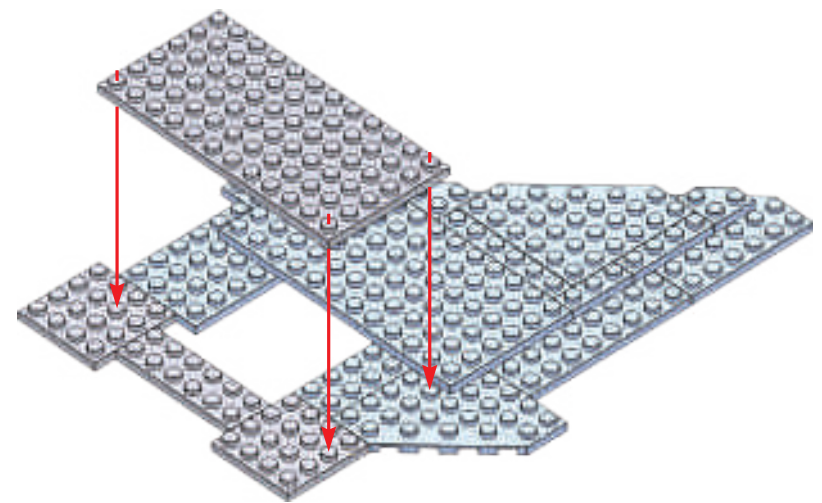
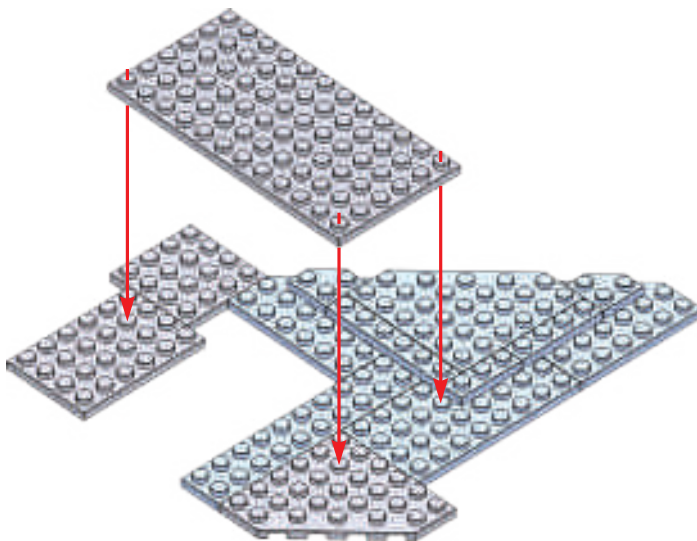

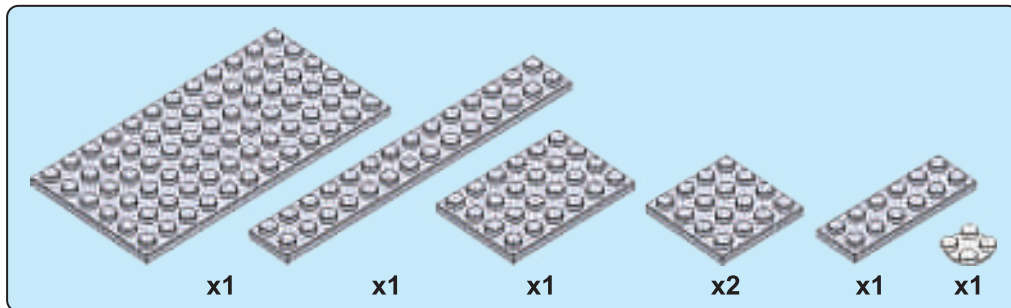

87

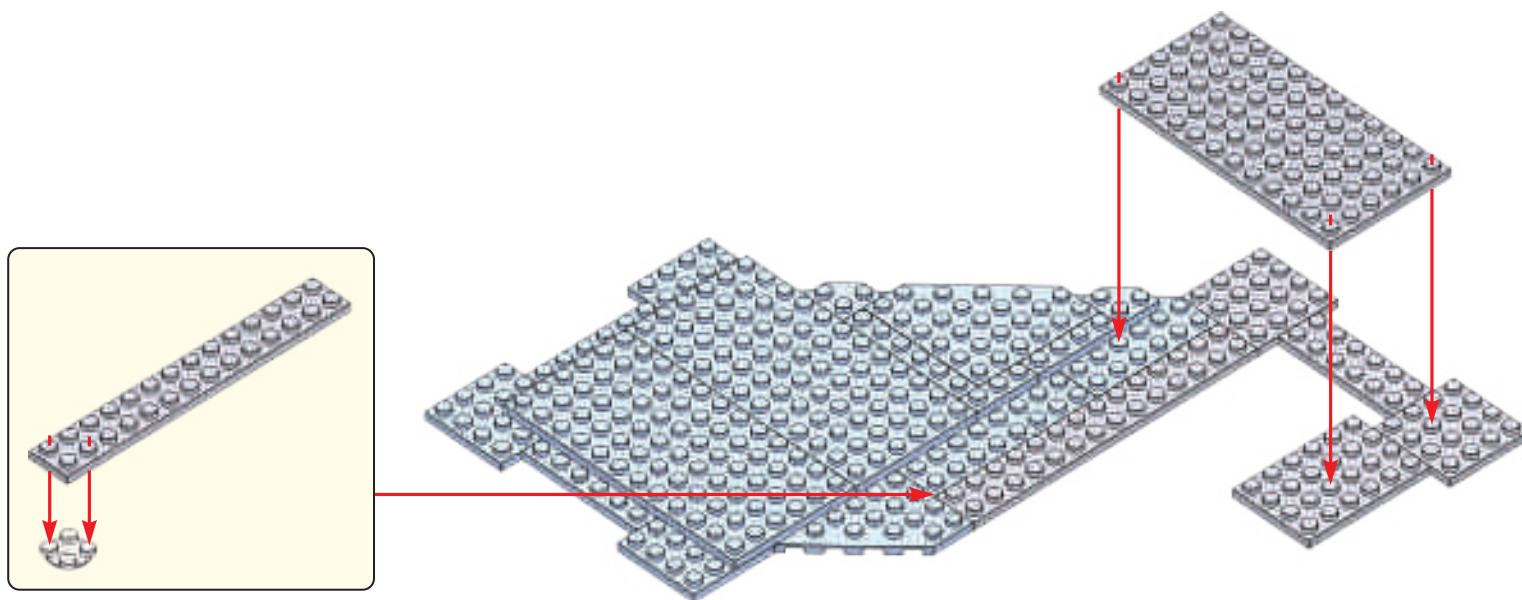

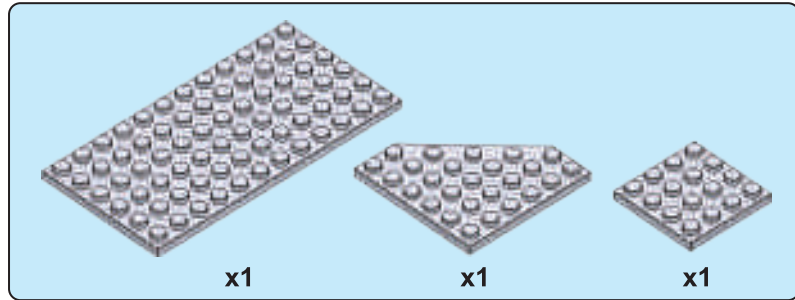

88

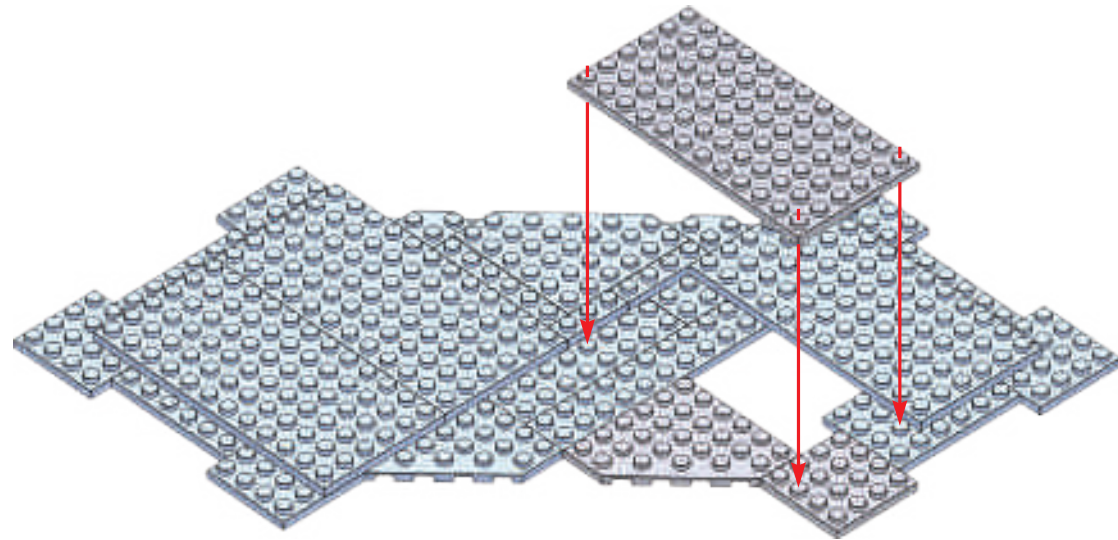

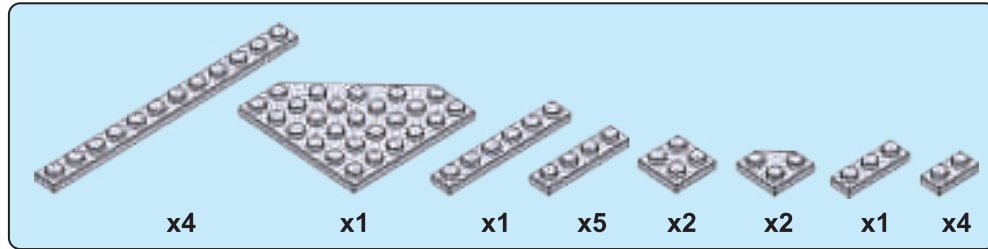

89

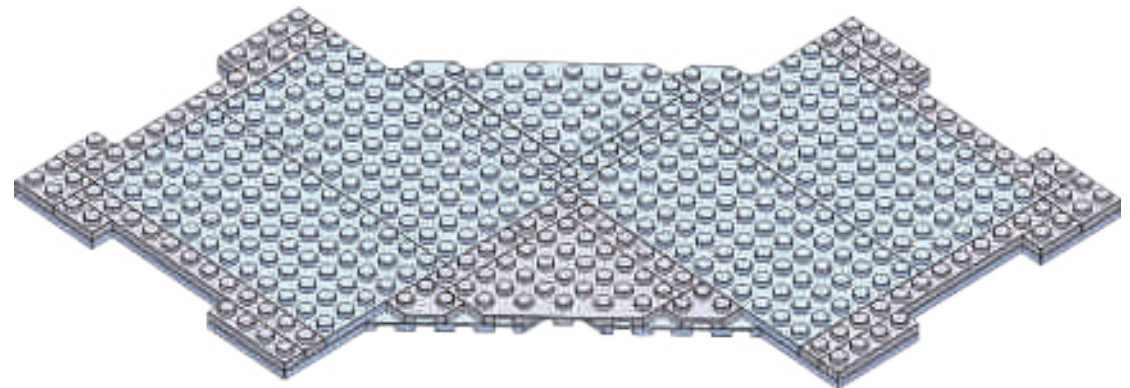

90

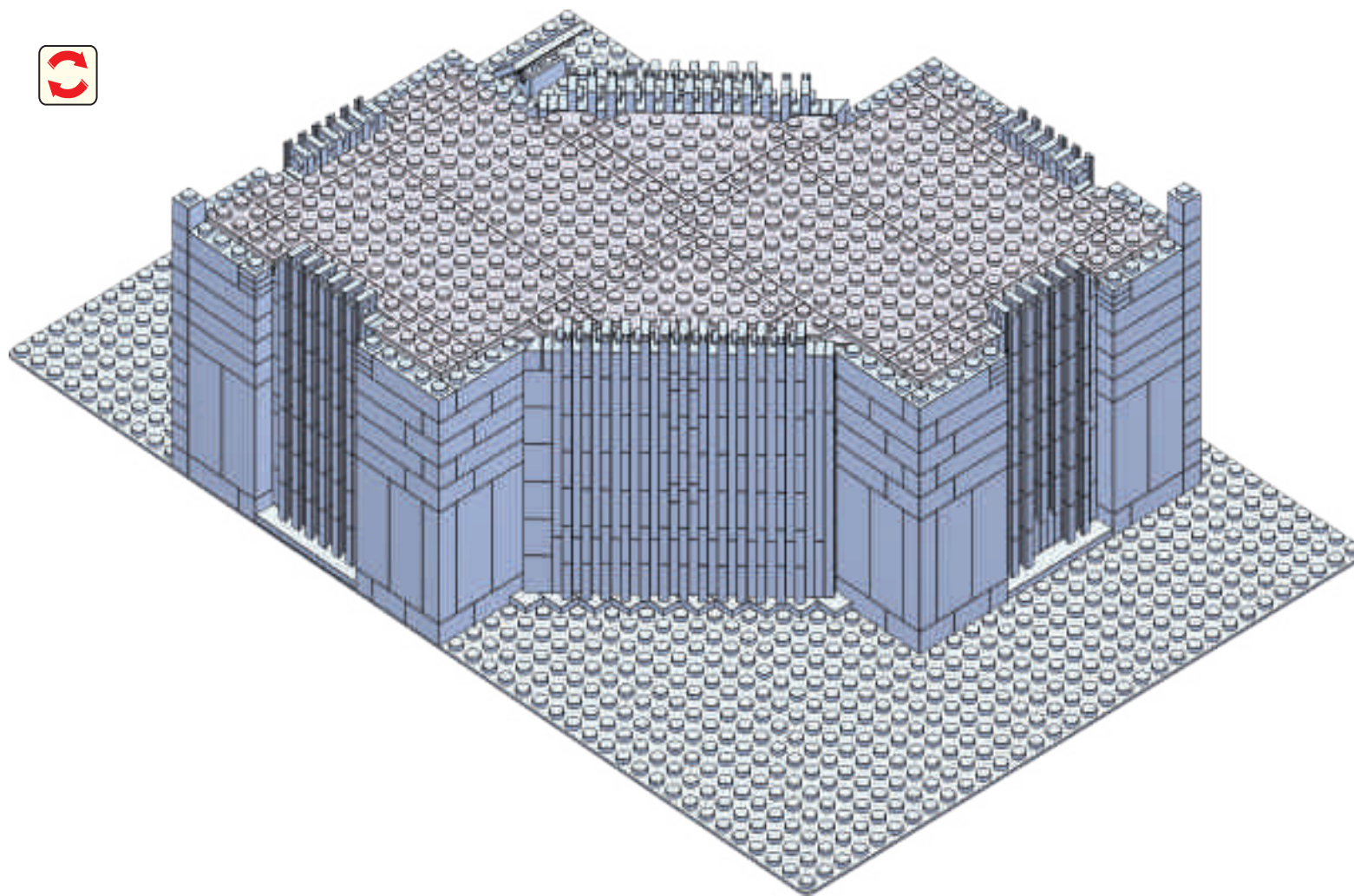

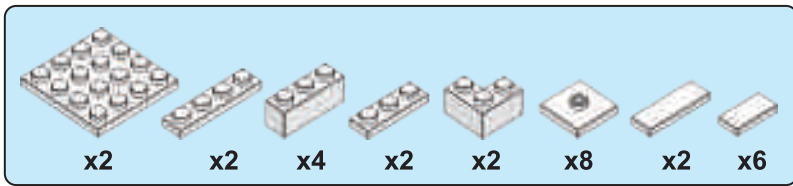

91

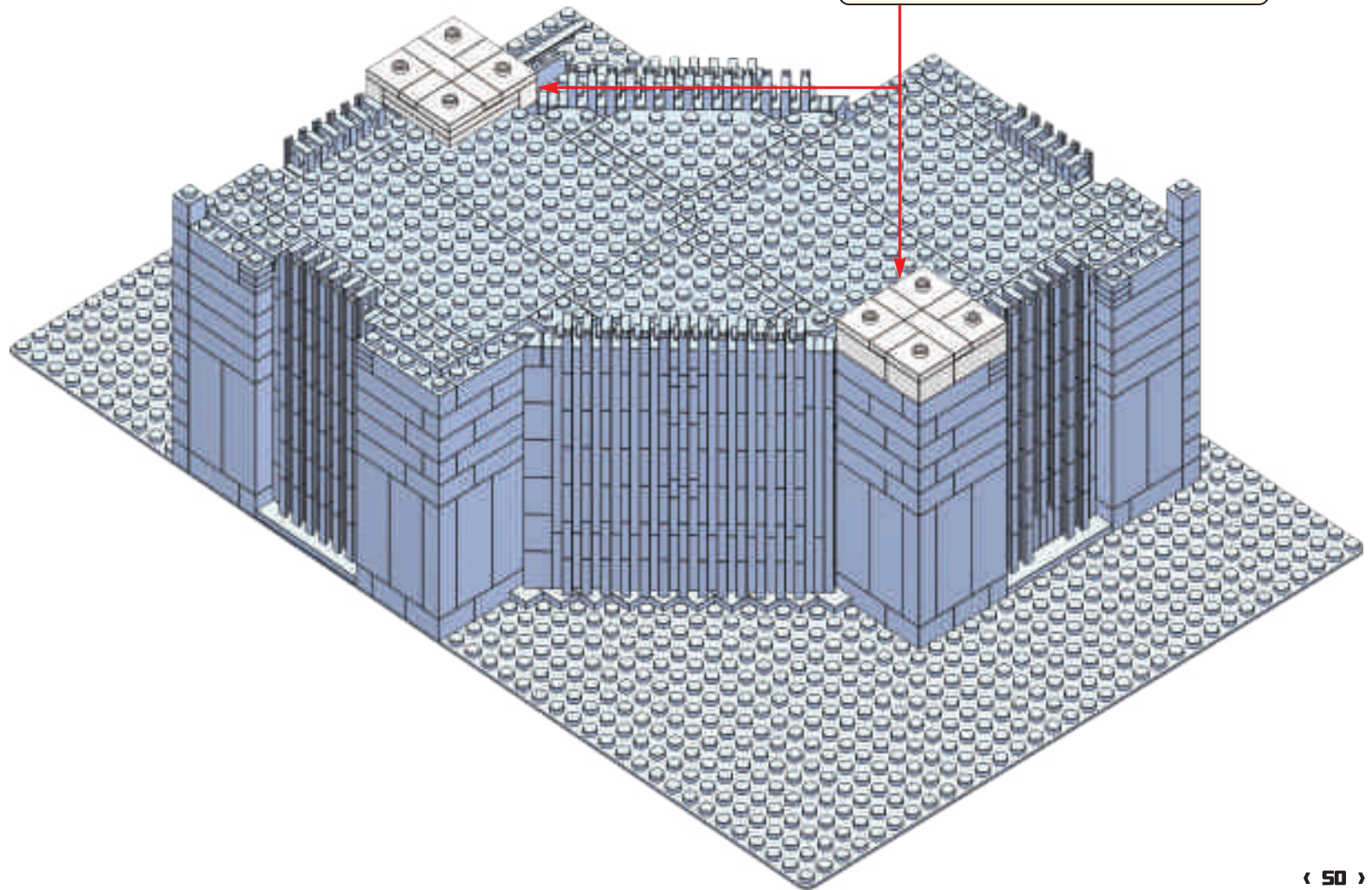
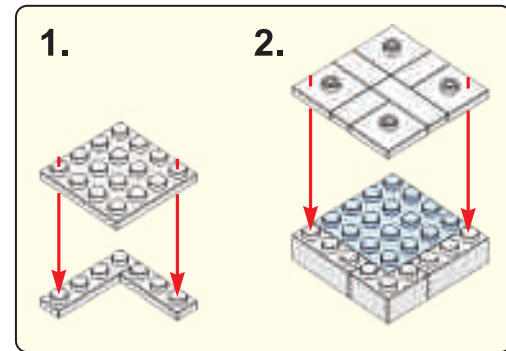

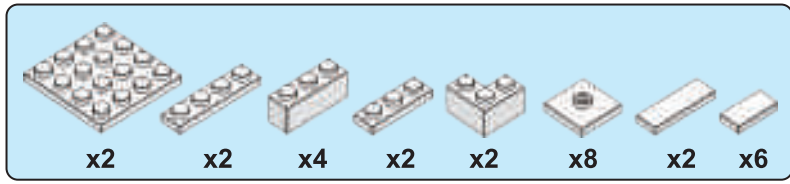

92

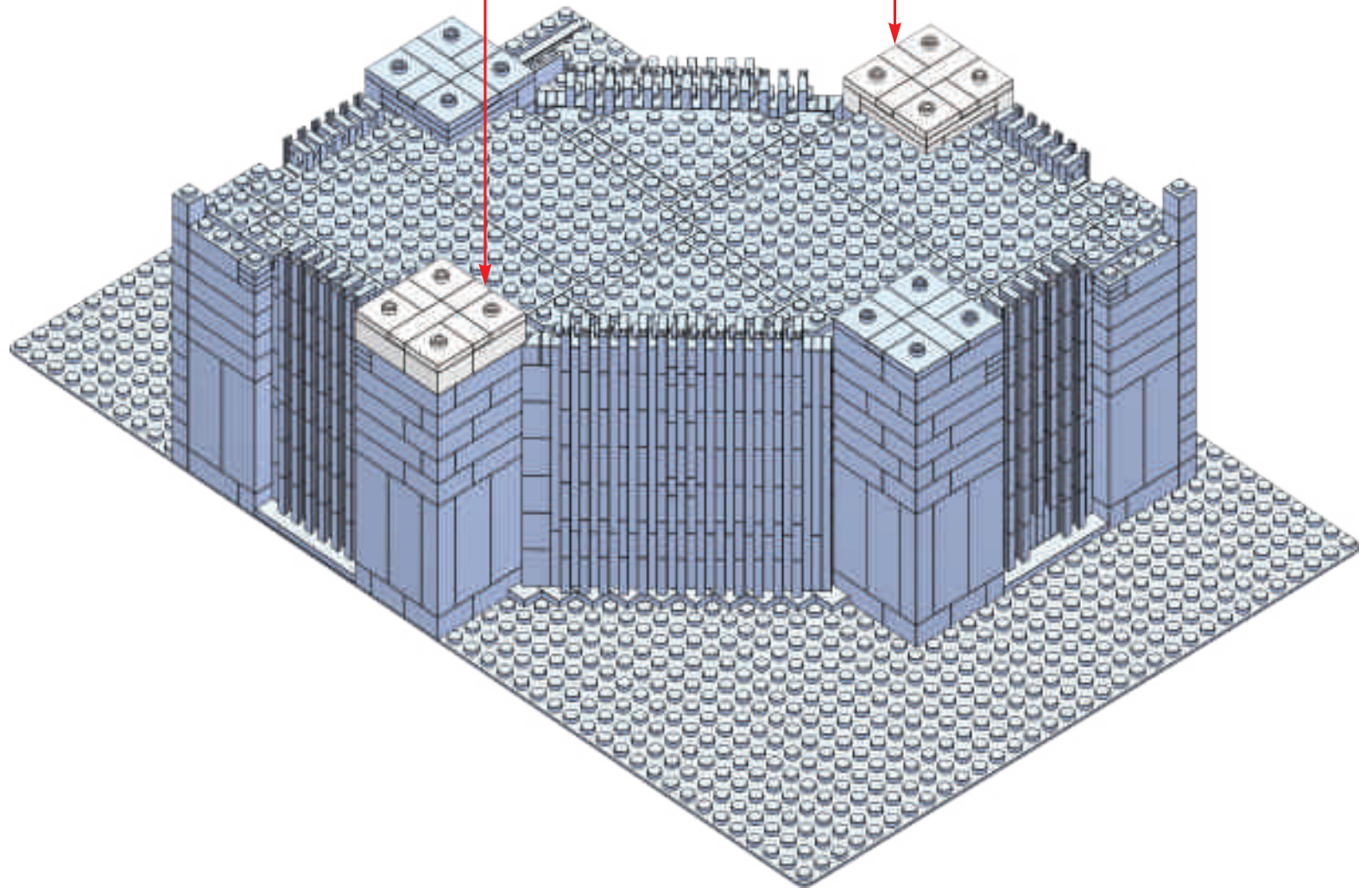
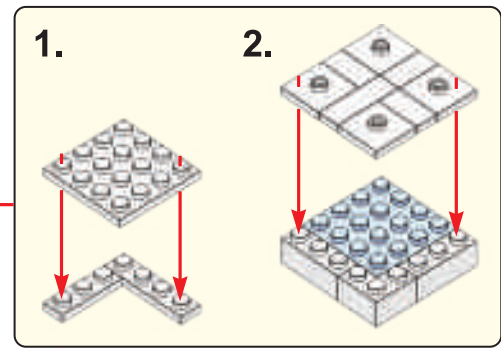

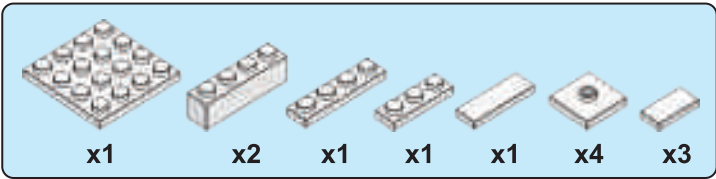

93

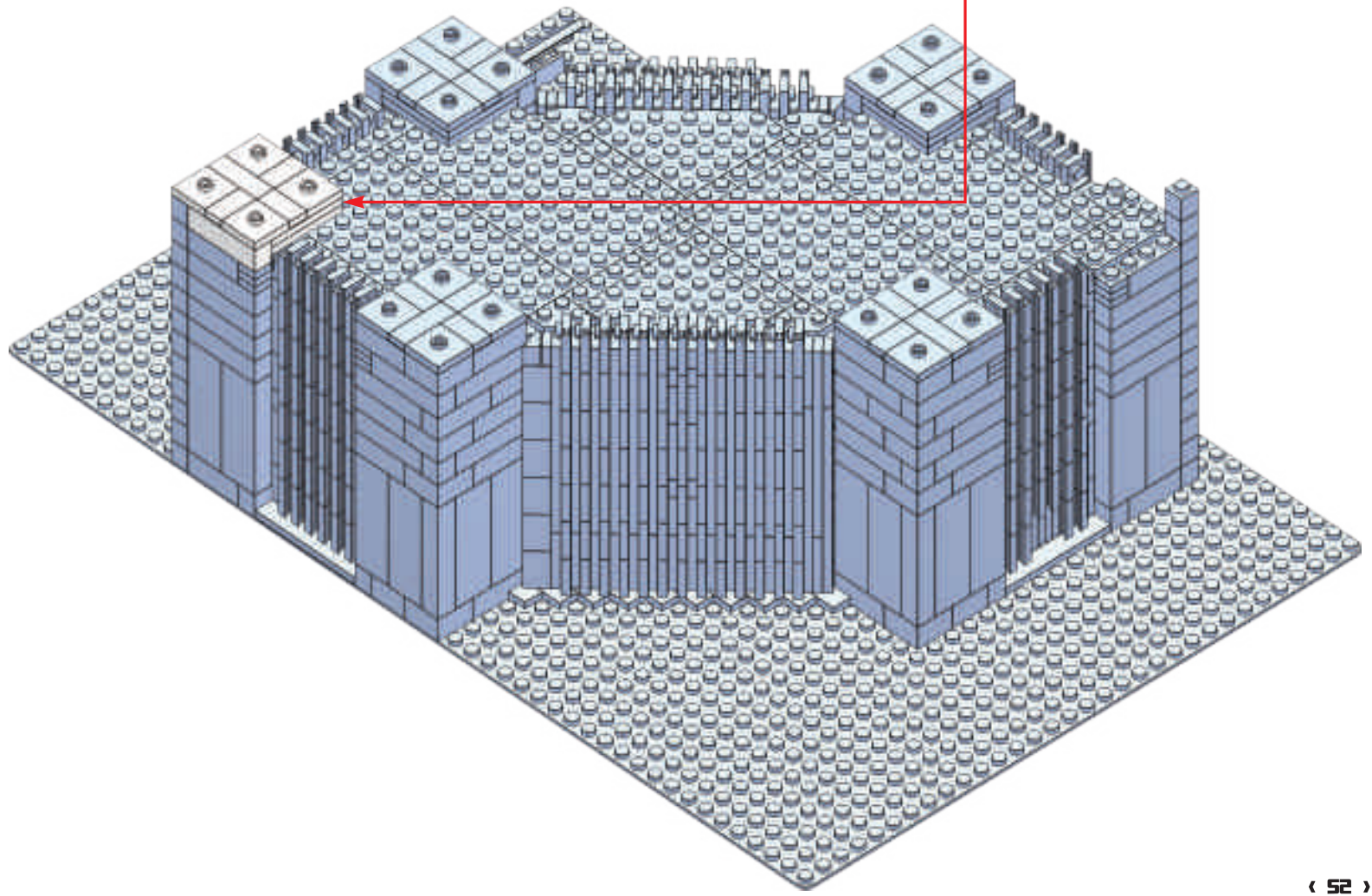
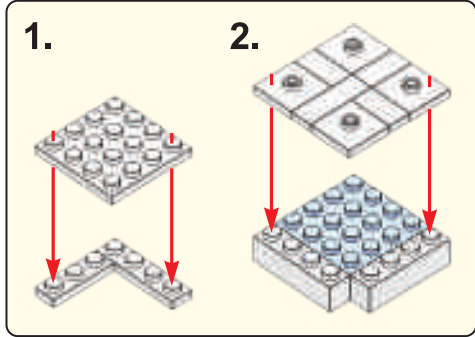

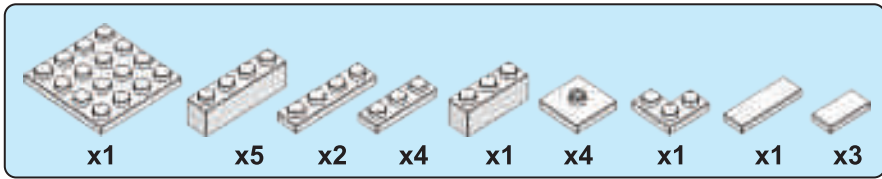

94

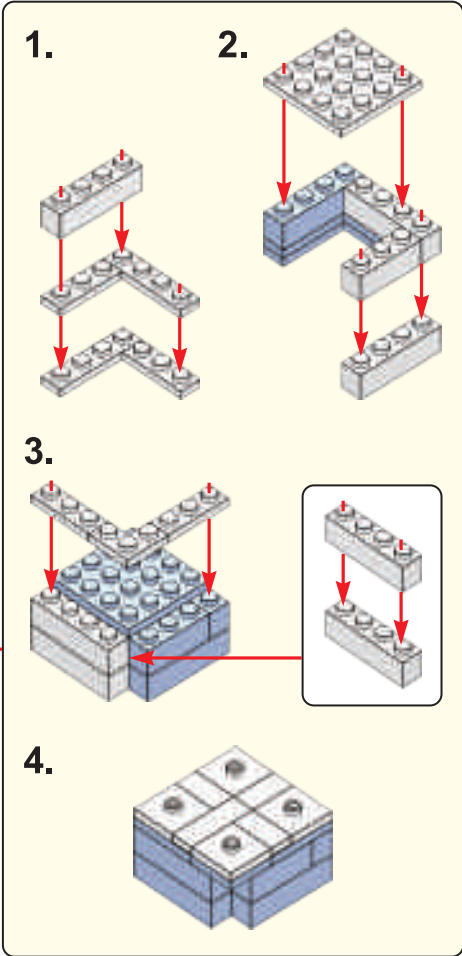
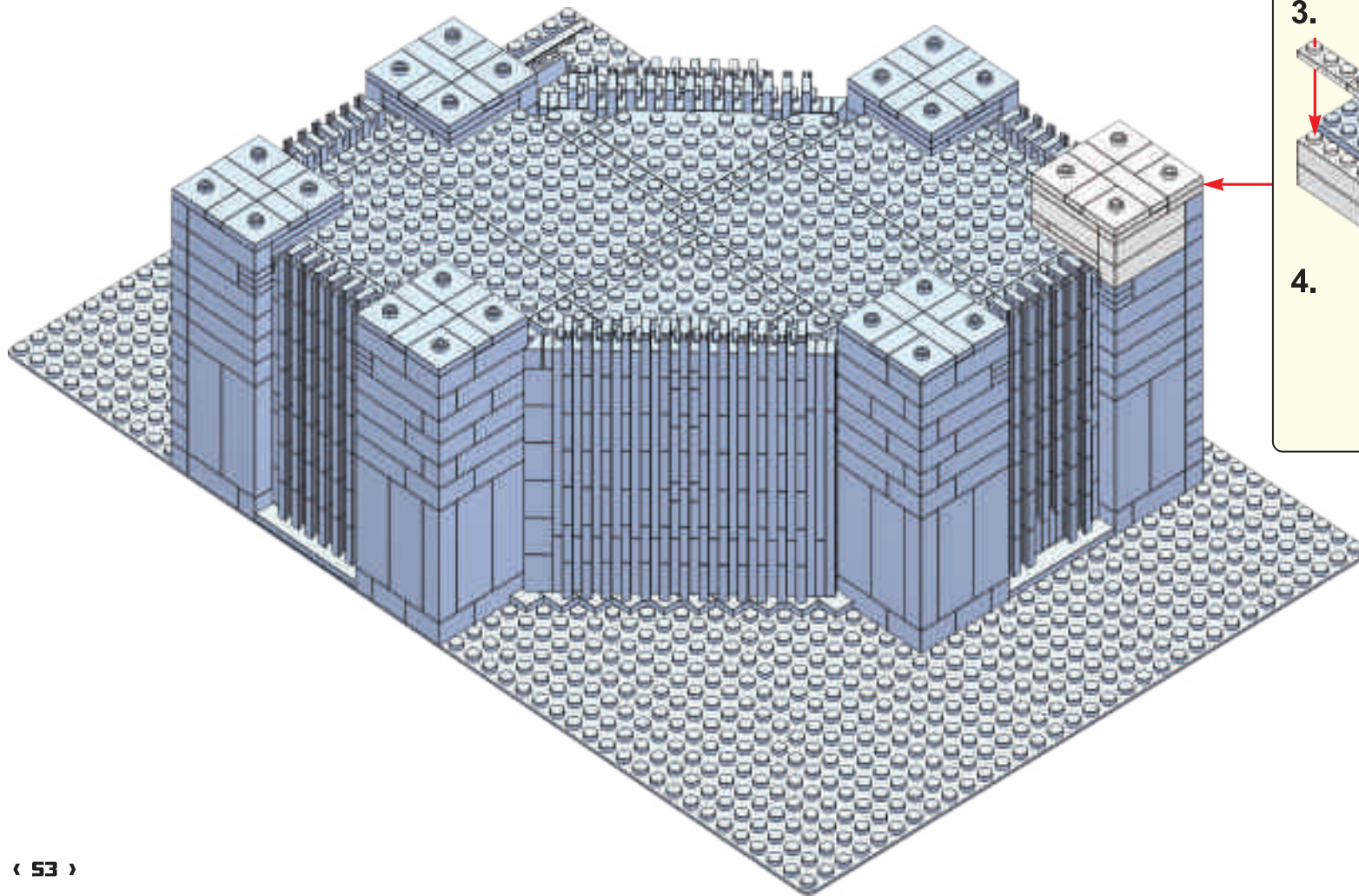

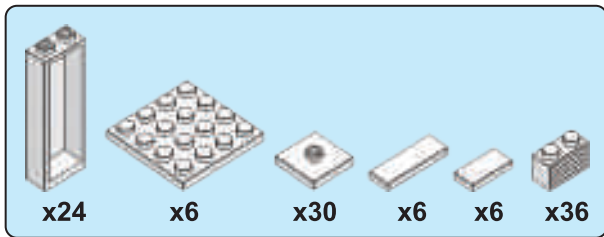

95

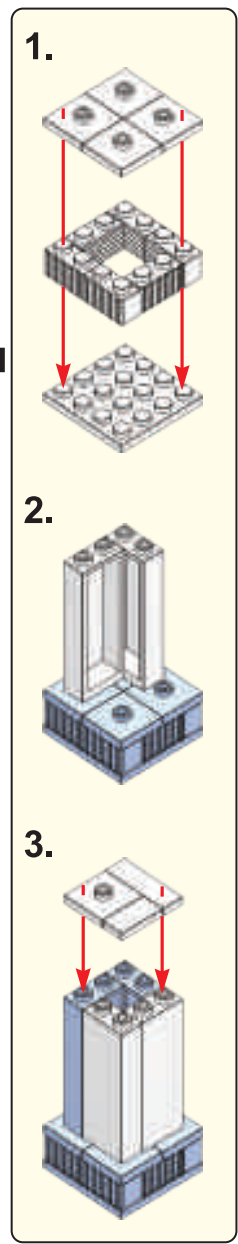
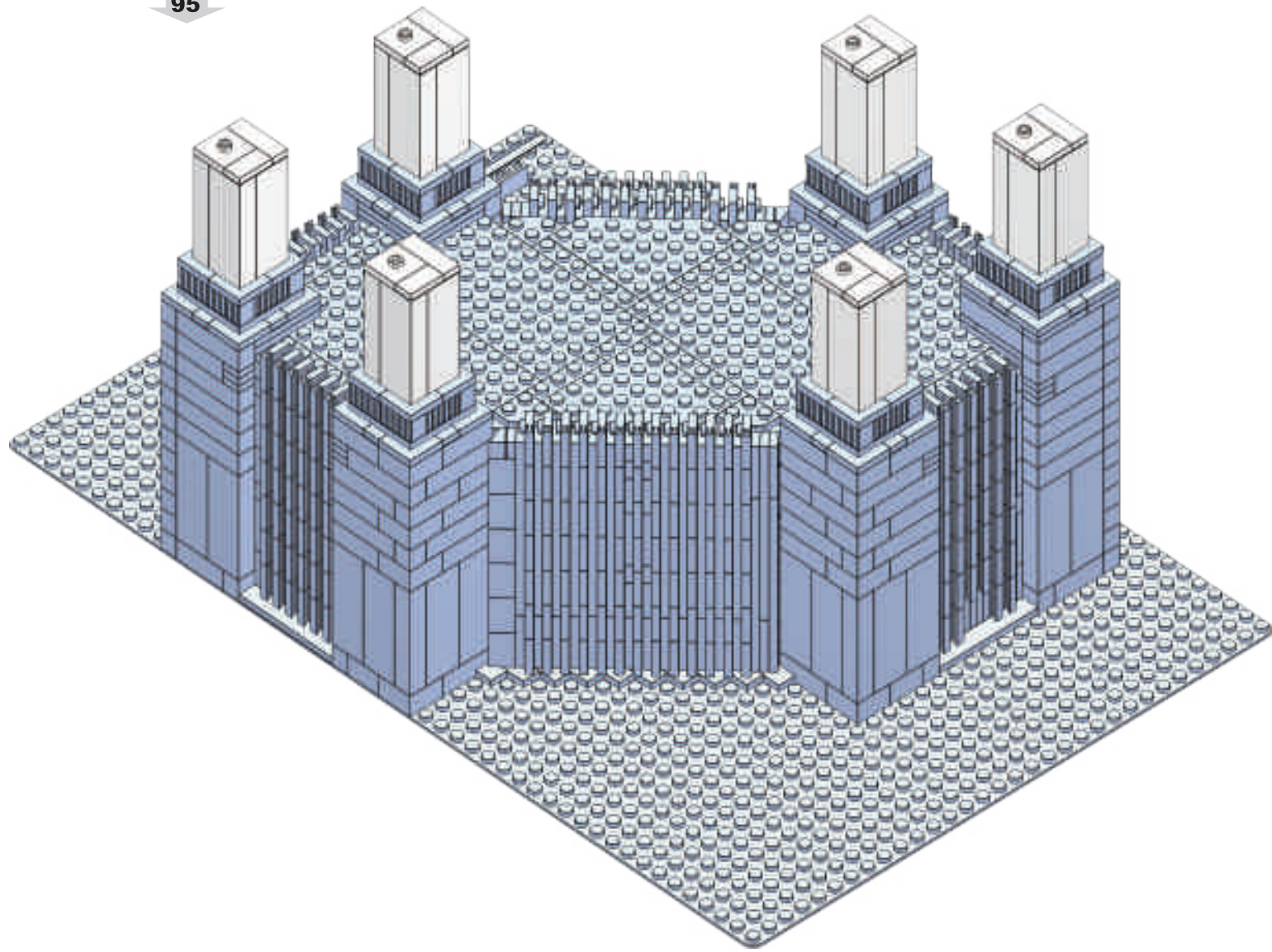

x6

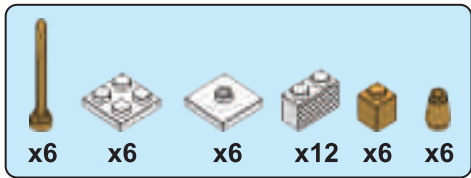

96

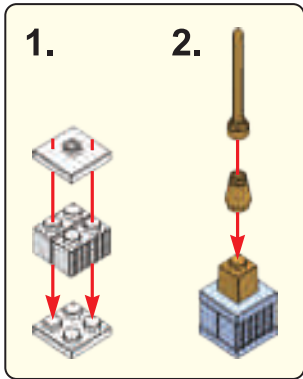

x6

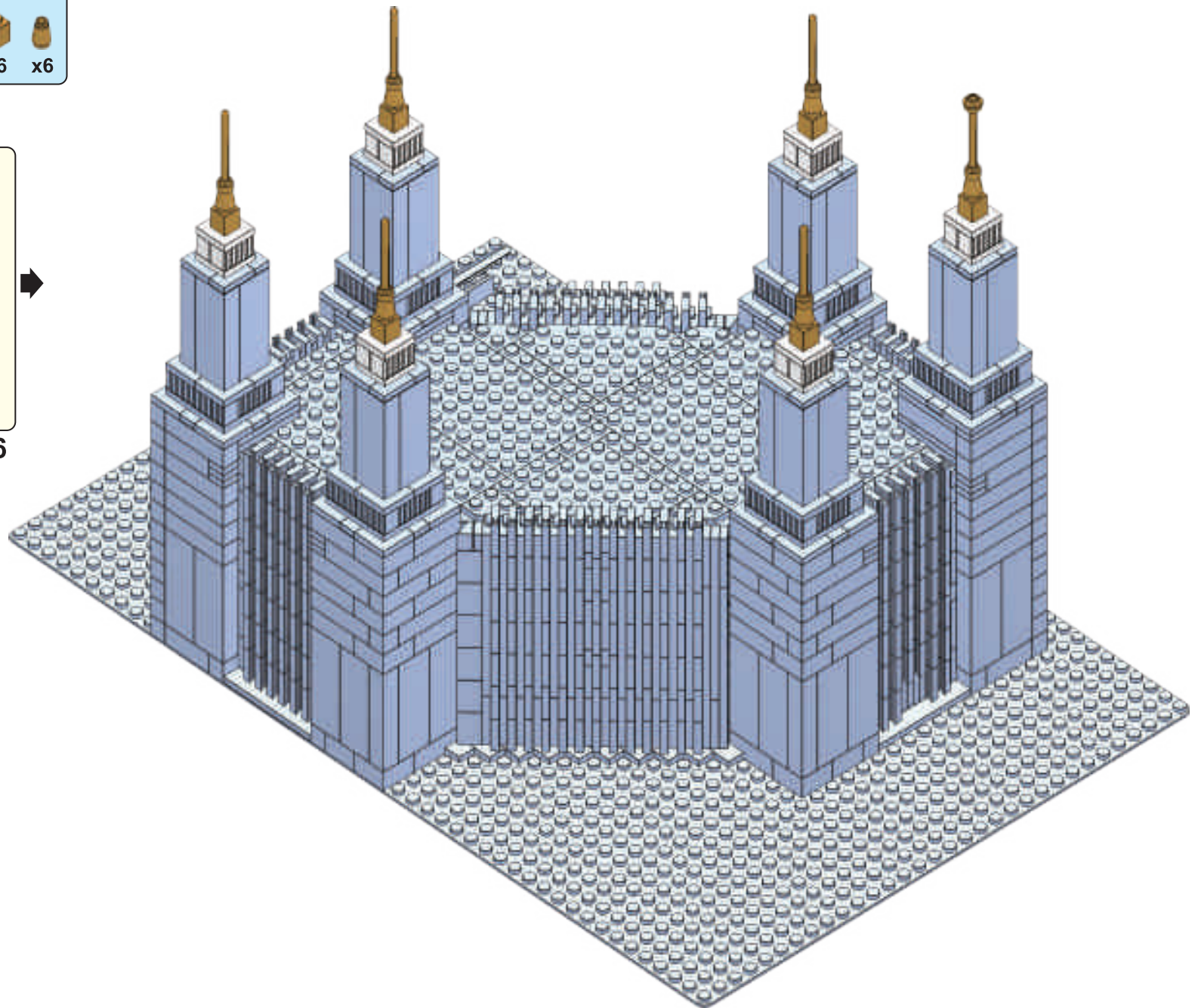



97

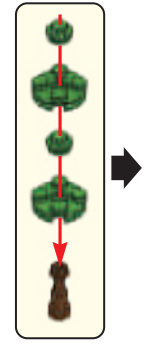
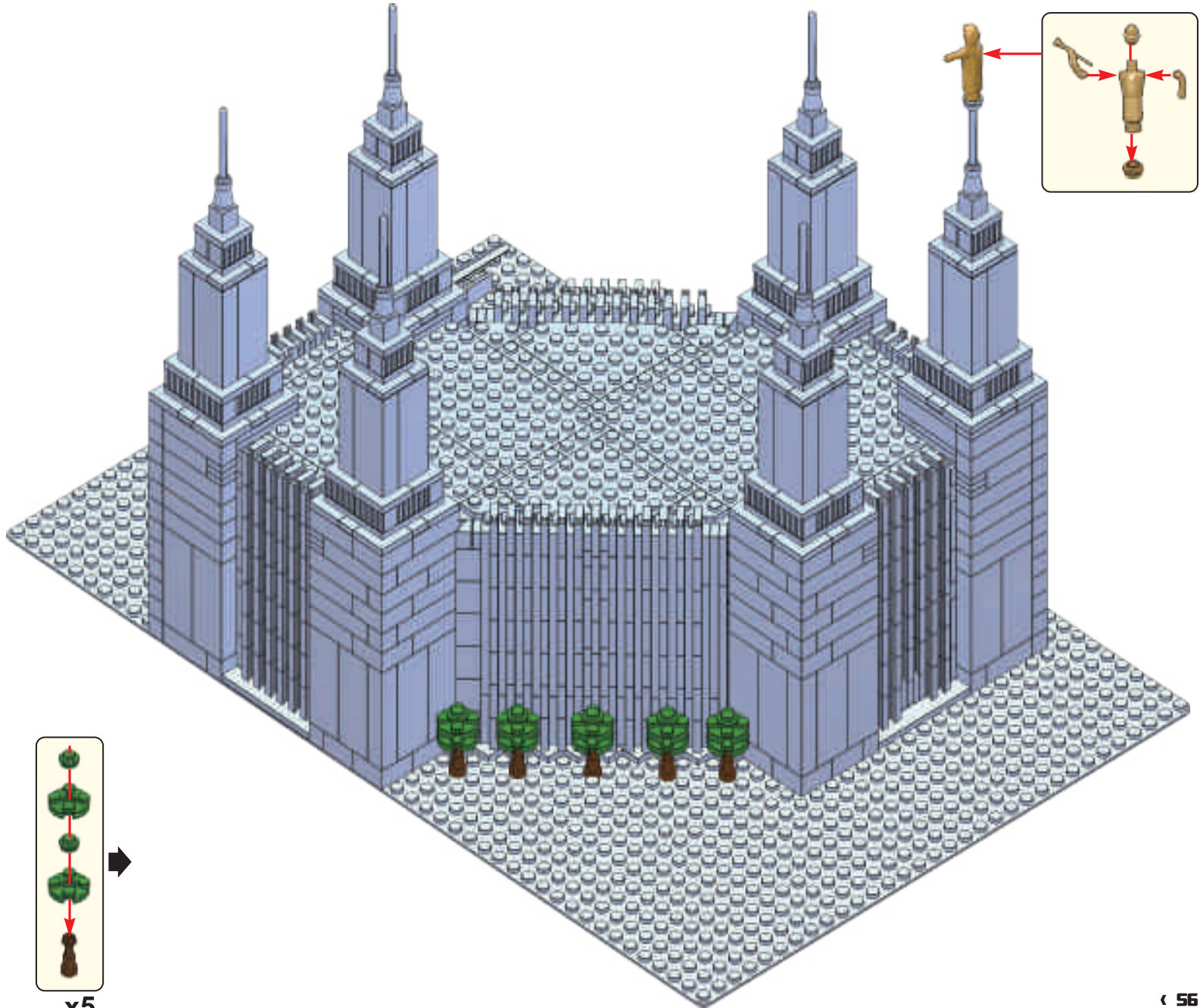
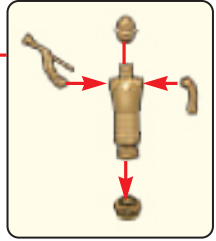

x5

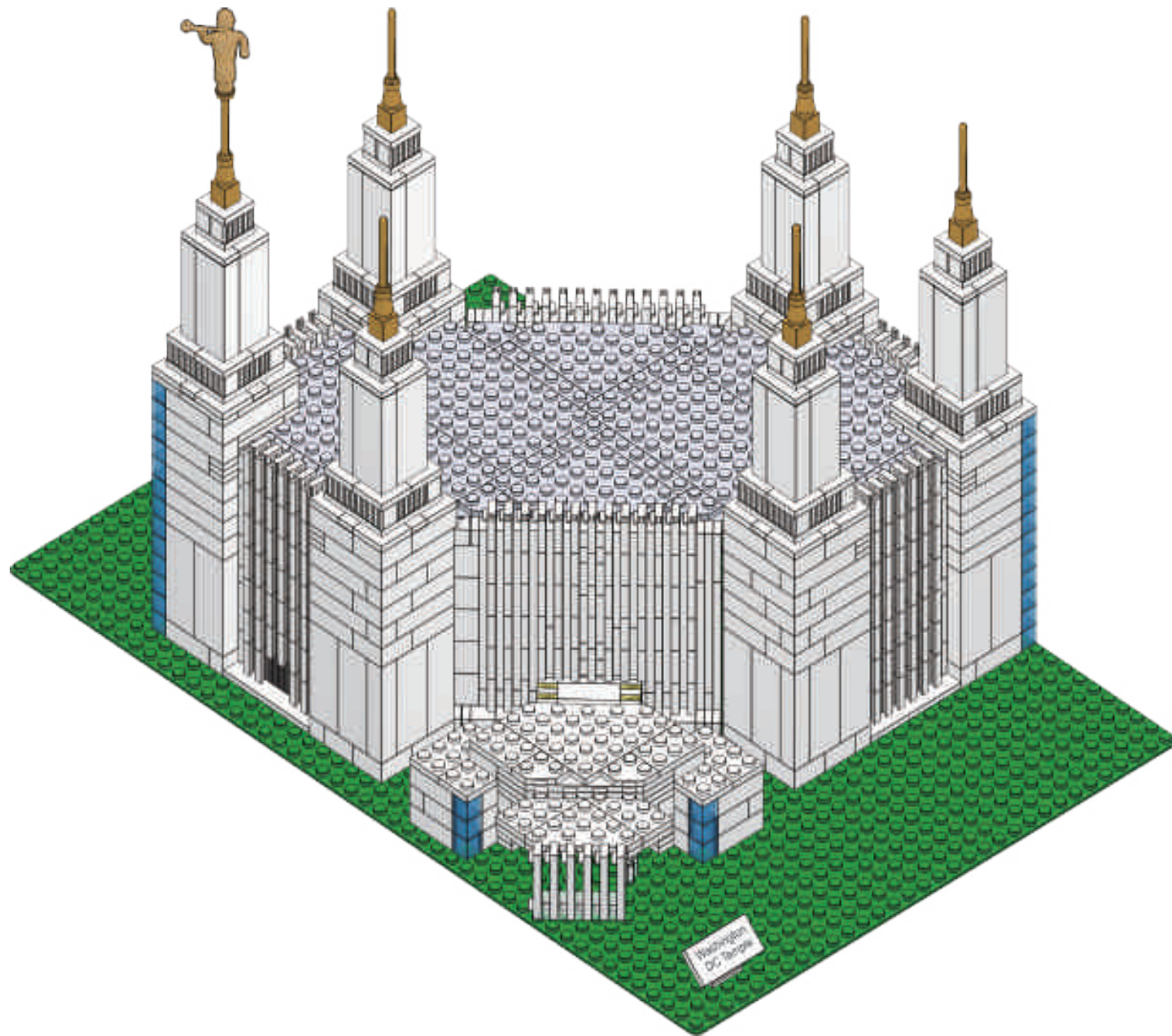

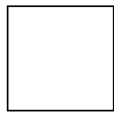

Send us a picture together with your completed temple set to info@brickemyoung.com and receive a free missionary figurine set!



or



Make social media a happy place 😊
 Post a picture using hashtag #BrickEmYoung
 Follow us on facebook, instagram, twitter & pinterest!

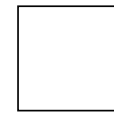
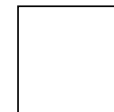

Warning! Choking hazard. Small parts.
Achtung! Erstickungsgefahr. Enthält Kleinteile.
Attention! Risque d'étouffement. Petites pièces.
Avvertenza! Pericolo di soffocamento. Contiene parti piccole.
Waarschuwing! Verstikkingsgevaar. Kleine deeltjes.
iAdvertencia! Riesgo de asfixia. Piezas pequeñas.
Advarsel! Kvælningsfare. Små dele.
Varoitus! Tukehtumisvaara. Pieniä osia.
Varning! Kvävningrisk. Innehåller smådelar.
Atenção! Perigo de asfixia. Peças pequenas.
Προειδοποίηση! Κίνδυνος πνιγμού. Μικρά κομμάτια.
警告! 窒息の危険性。小さな部品が入っていますので、ご
注意ください。
警告! 小心窒息。当心小物件。
경고! 질식 위험. 작은 부품 포함.
Внимание! Риск удушения. Содержит мелкие детали.

Ostrzeżenie! Zagrożenie zadławienia. Małe elementy.
Upozornění! Nebezpečí udušení. Obsahuje malé součástky.
Upozornenie! Nebezpečenstvo udusenja. Obsahuje malé súčasti.
Figyelmeztetés! Fulladásveszély! Kis elemeket tartalmaz.
Обережно! Ризик задухи. Містить дрібні деталі.
Upozorenje! Opasnost od gušenja. Sitni dijelovi.
Упозорење! Опасност од гушења. Мали делови.
Opozorilo! Nevarnost zadušitve. Majhni delčki.
Avertisment! Pericol de sufocare. Piese mici.
Внимание! Опасност от задавяне. Малки части.
Brīdinājums! Pastāv nosmakšanas risks. Satur sīkas daļas.
Hoiatuus! Lämbumisoht. Sisaldab väikseid osi.
Ispėjimas! Uždusimo pavojus! Komplekte yra mažų detalių.
Dikkat! Boğulma tehlikesi. Küçük parçalar.

All copyrights, trademarks, intellectual property and other information contained belong to Brick'em Young.
No unauthorized usage or distribution of this material (including instruction booklet)
without the expressed written consent of Brick'em Young.
Brick'em Young is not owned or affiliated with The Church of Jesus Christ of Latter-day Saints.
Further questions can be directed to: info@brickemyoung.com
This brick set contains many small bricks, Parental involvement is recommended!

www.brickemyoung.com

Product # 94:15



MADE IN CHINA