

Brick:Em

Young™

Logan Temple

1,165 Pieces

Product# 89: 18

Ages 12+

www.brickemyoung.com



standard size bricks
Toy Brick Building Set



10 Interesting Facts about the Logan Temple

1. Orson Pratt announced the Logan Temple site and groundbreaking on May 18, 1877.

2. Seven years after the groundbreaking the temple was completed and dedicated by President John Taylor on May 17, 1884.

3. The Logan Temple is the fourth temple constructed by The Church of Jesus Christ of Latter-day Saints. Previous constructed temples were Kirtland, Nauvoo and St. George.

4. Roughly 25,000 people worked on the construction of the Logan Temple.

5. Rocks and timber used for the temple were hauled from the Temple Fork area of Logan Canyon.

6. The exterior walls of the Logan Utah Temple were originally painted an off-white color. In the early 1900s the paint was allowed to weather away, uncovering the beautiful stone that characterizes the temple today.

7. The exterior walls consist primarily of dark colored, siliceous limestone and buff colored sandstone for detailed shapes.

8. In 1949, the temple was remodeled and received updated lighting, heating, air conditioning, elevators and other modern conveniences.

9. In 1977, more remodeling was undertaken and the interior was completely renovated. After remodeling, the temple was rededicated by President Spencer W. Kimball on March 13, 1979.

10. The Logan Temple was placed on the National Register of Historic Places on November 20, 1975



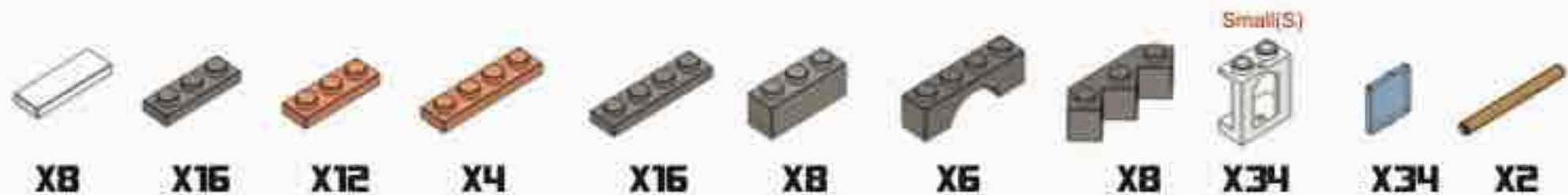

Large(L)



(2)

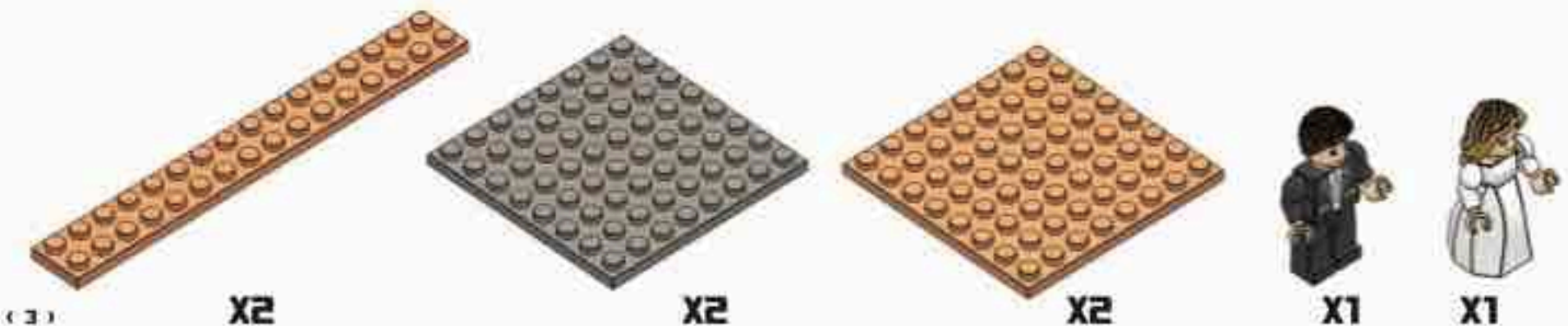
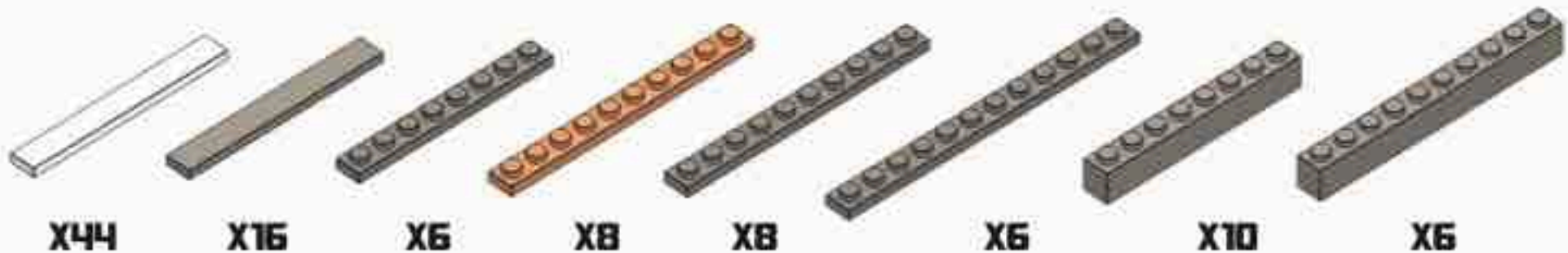

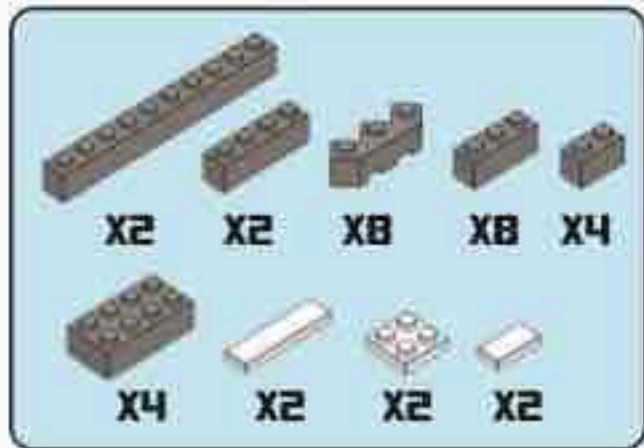

1

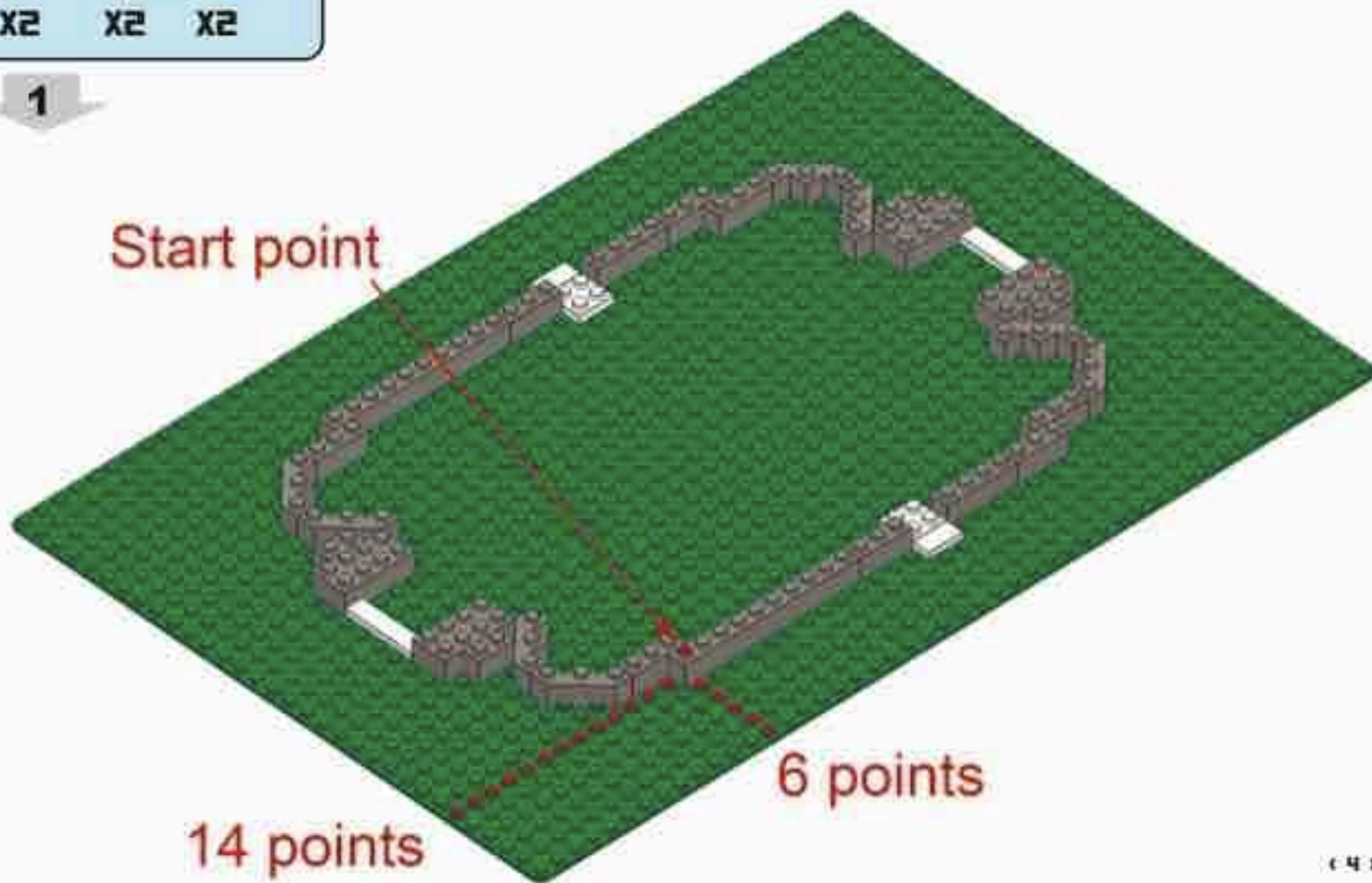

Large(E)

X4	X4	X16
X2	X4	X2

2

X8

X4

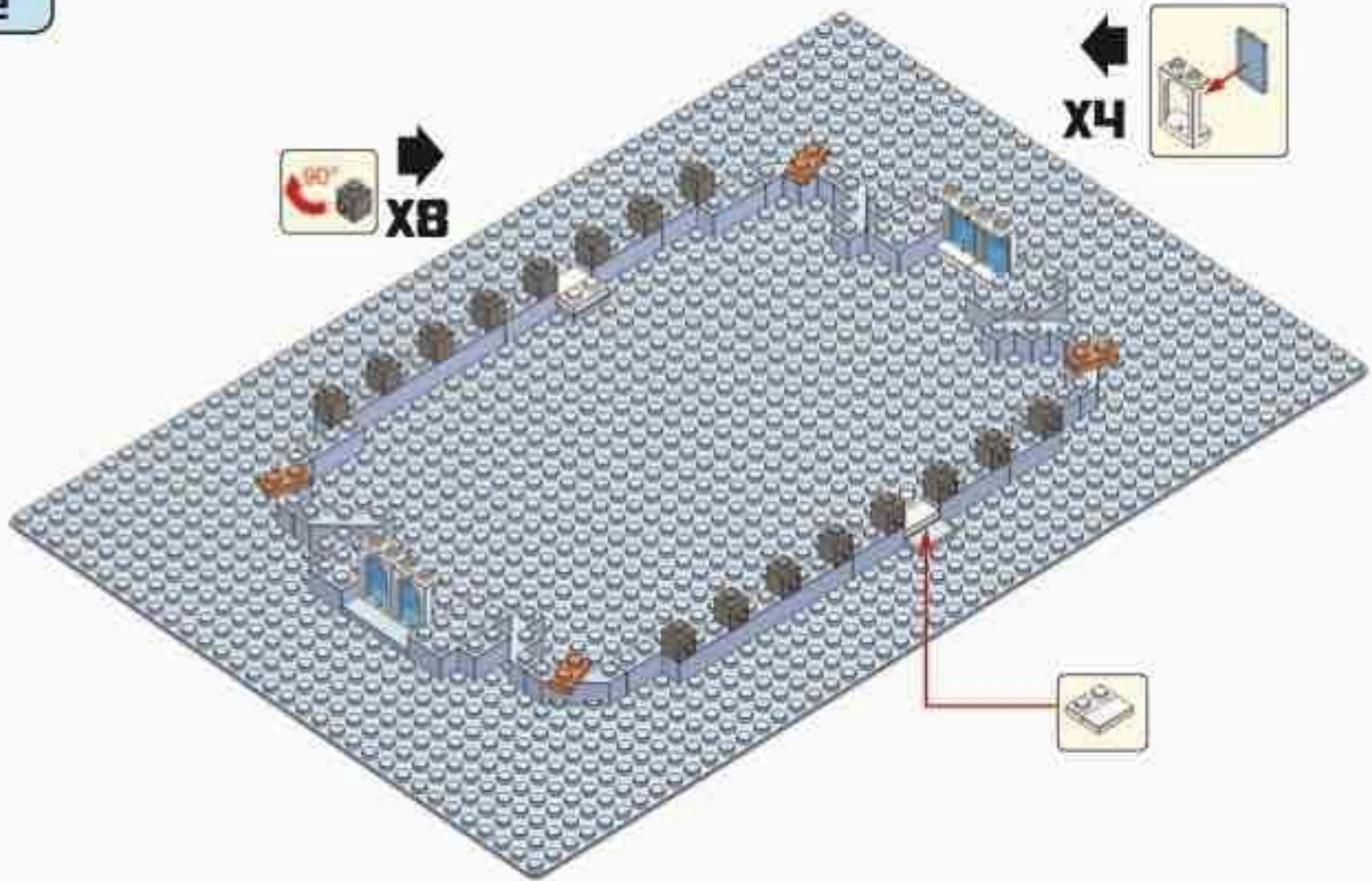

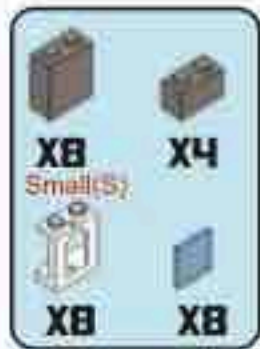

3

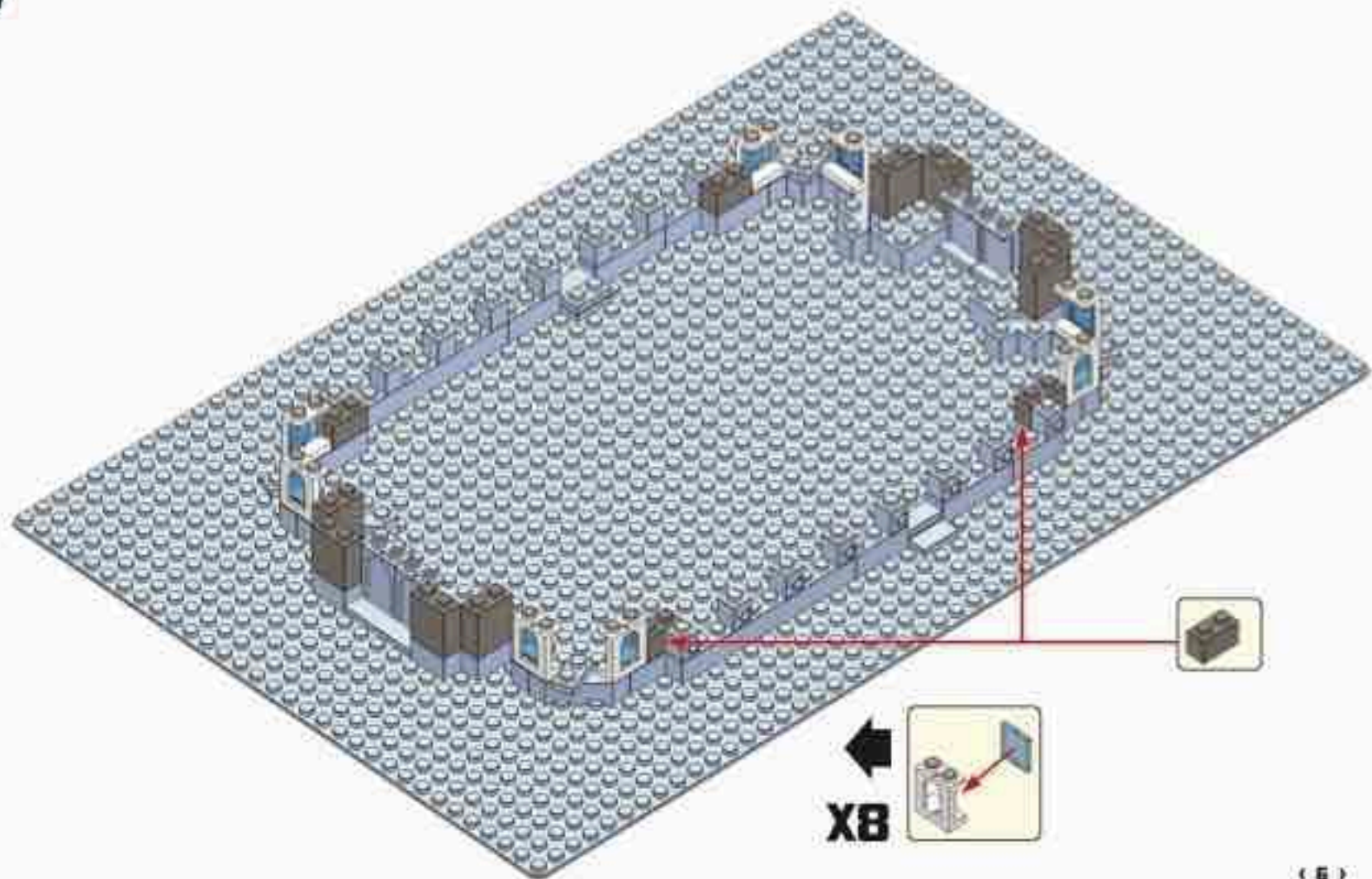



4

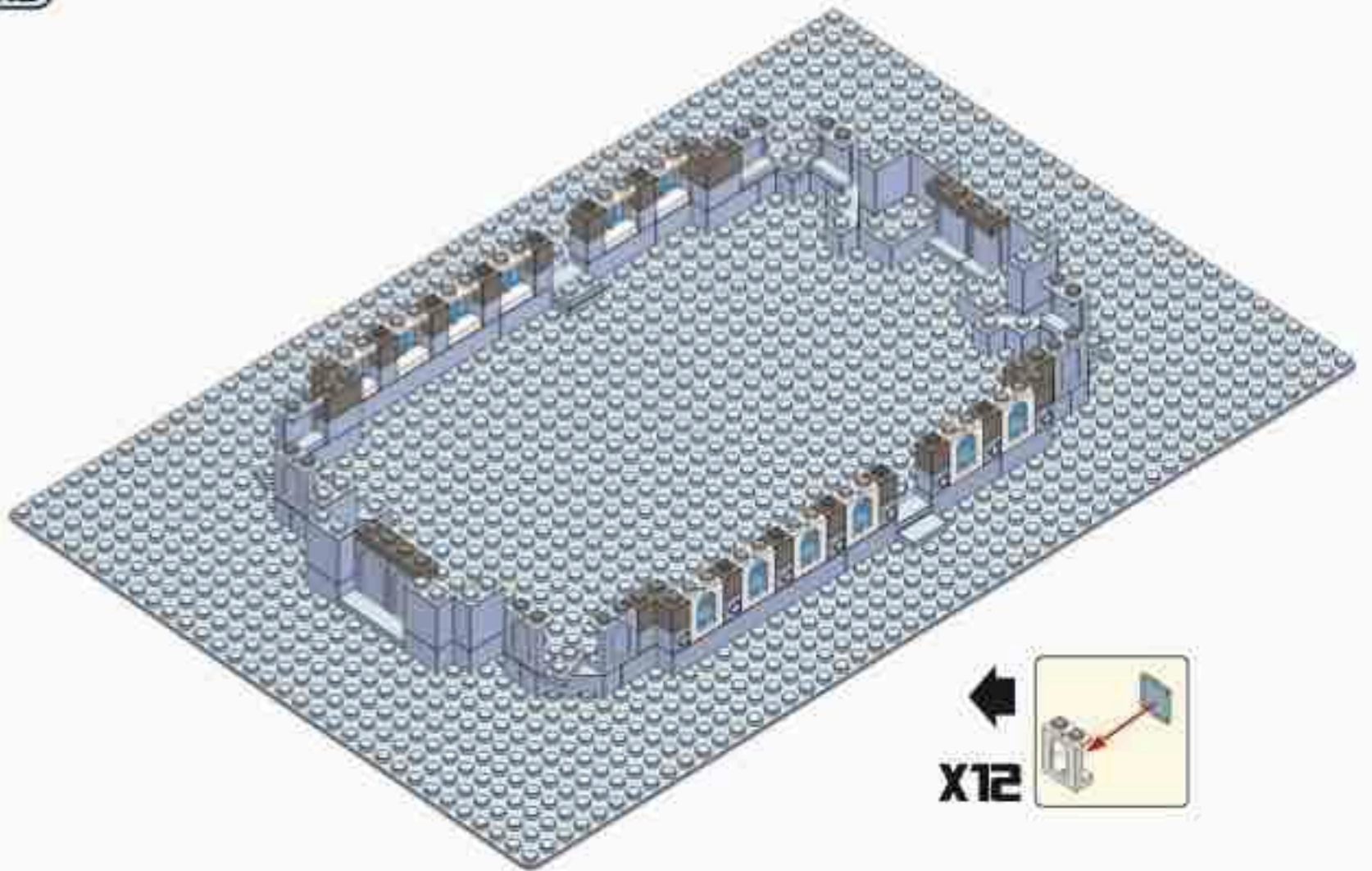

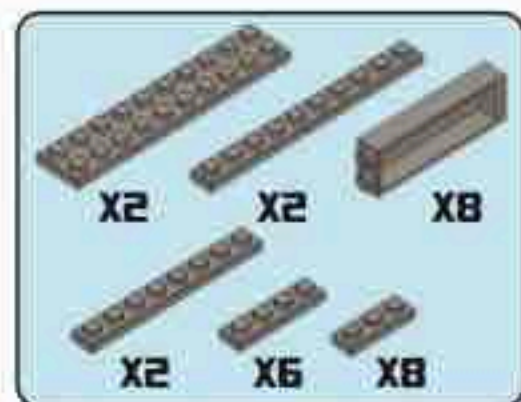
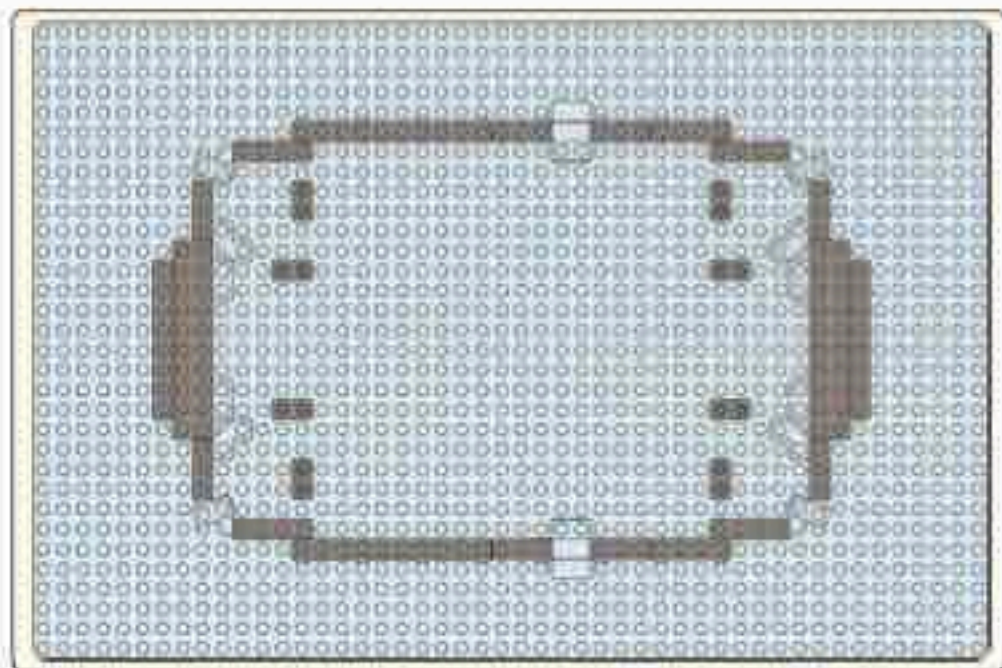

5

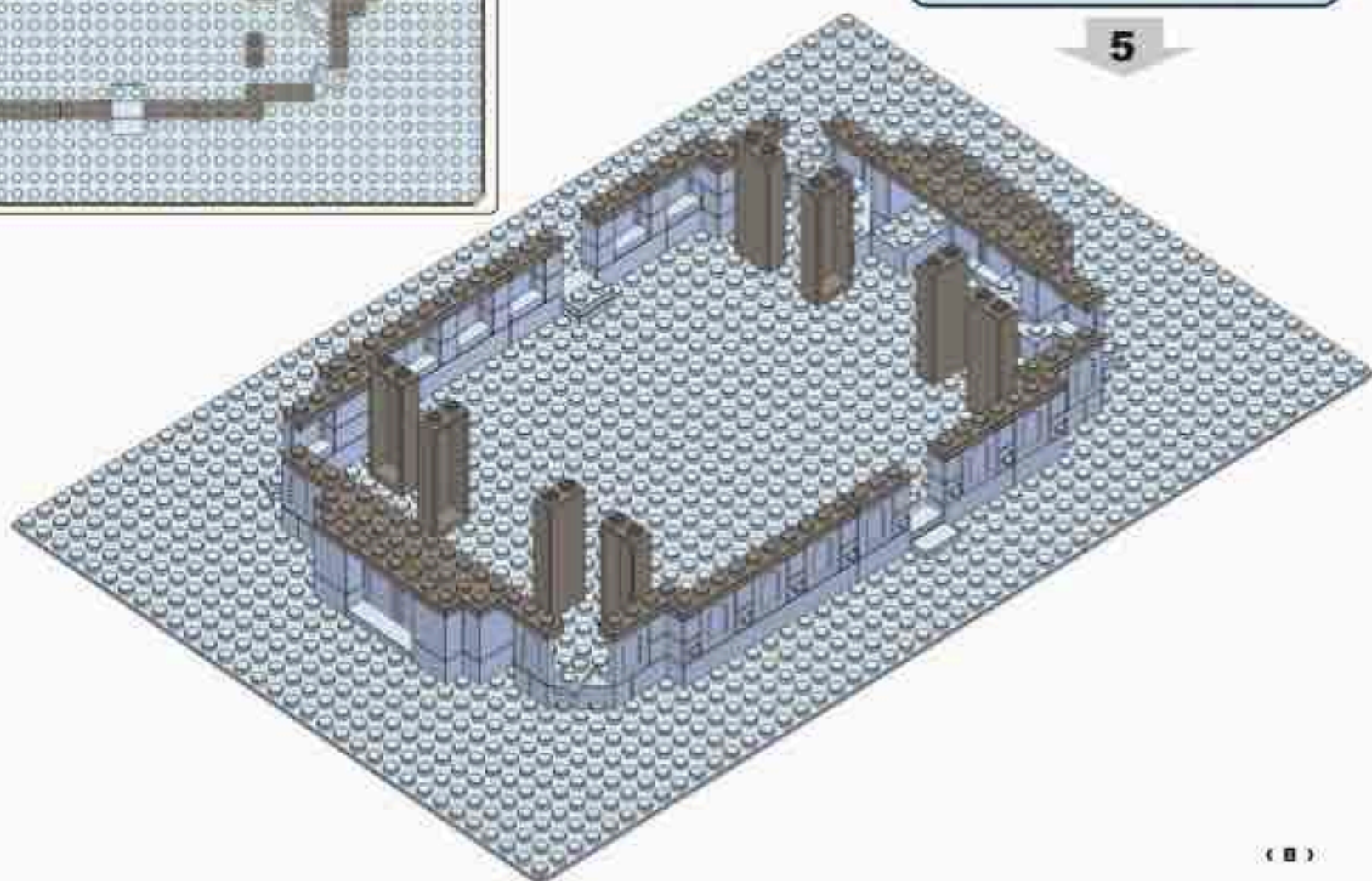

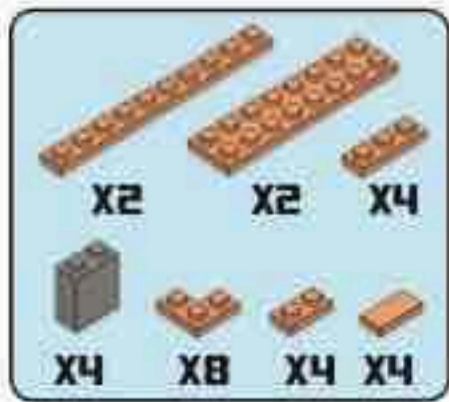

6

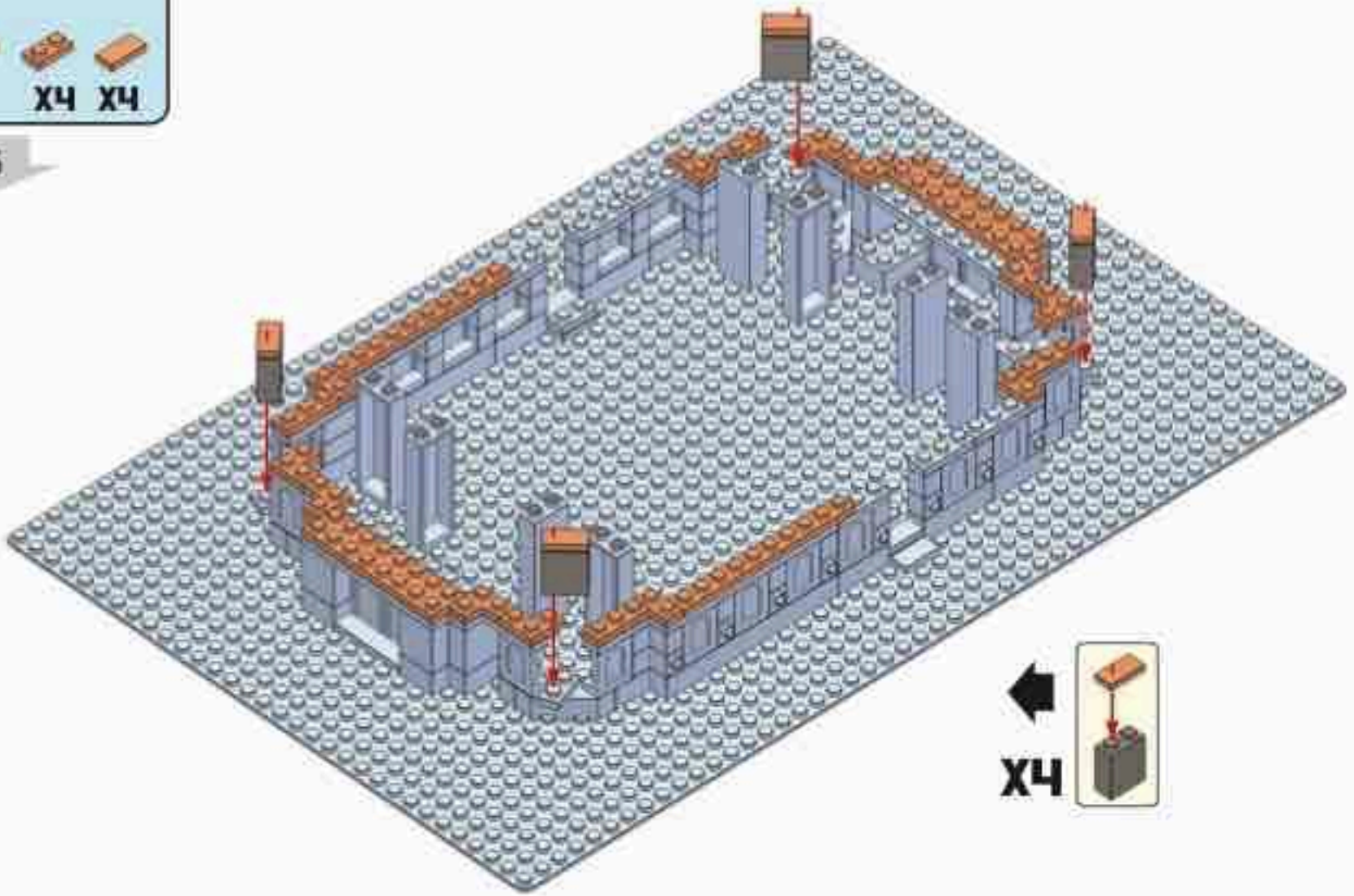

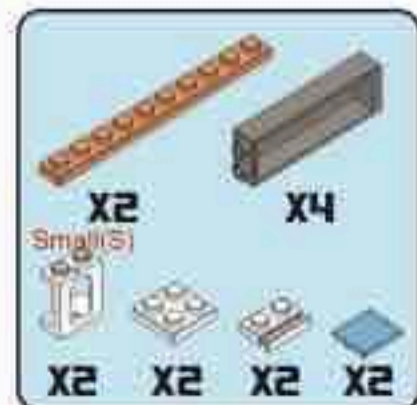
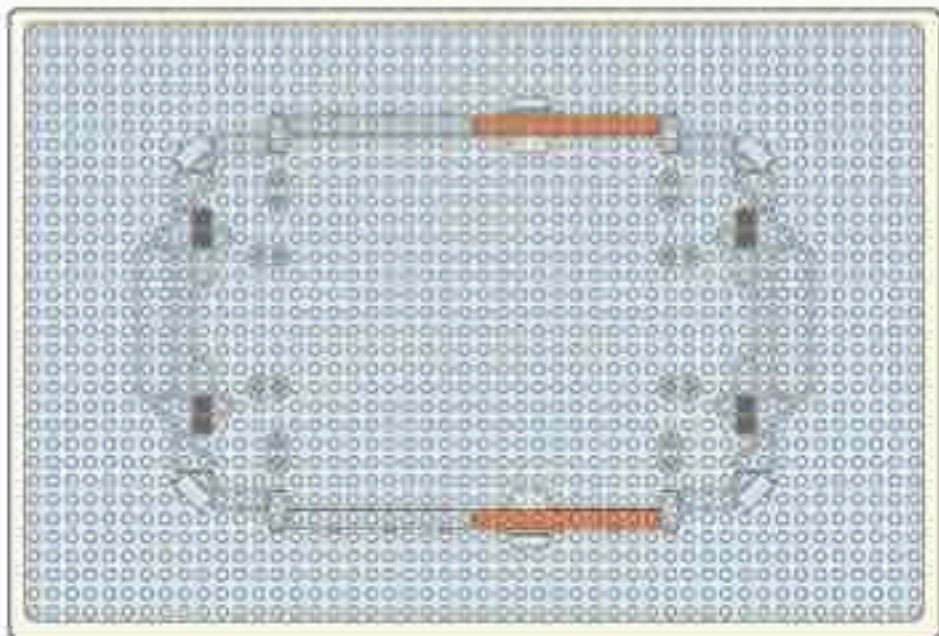

7

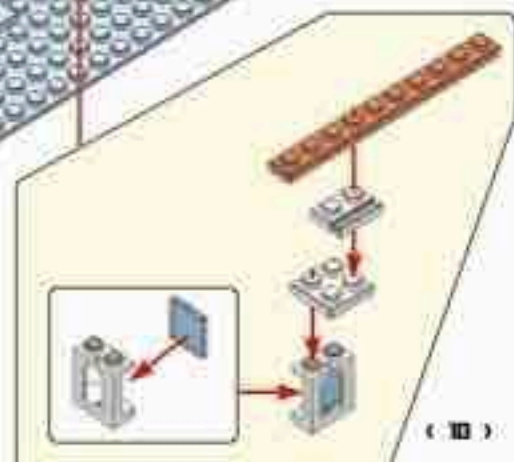
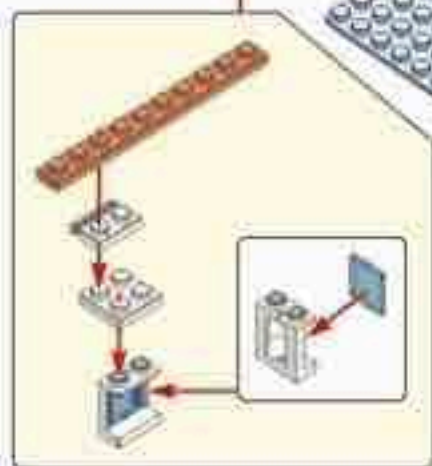
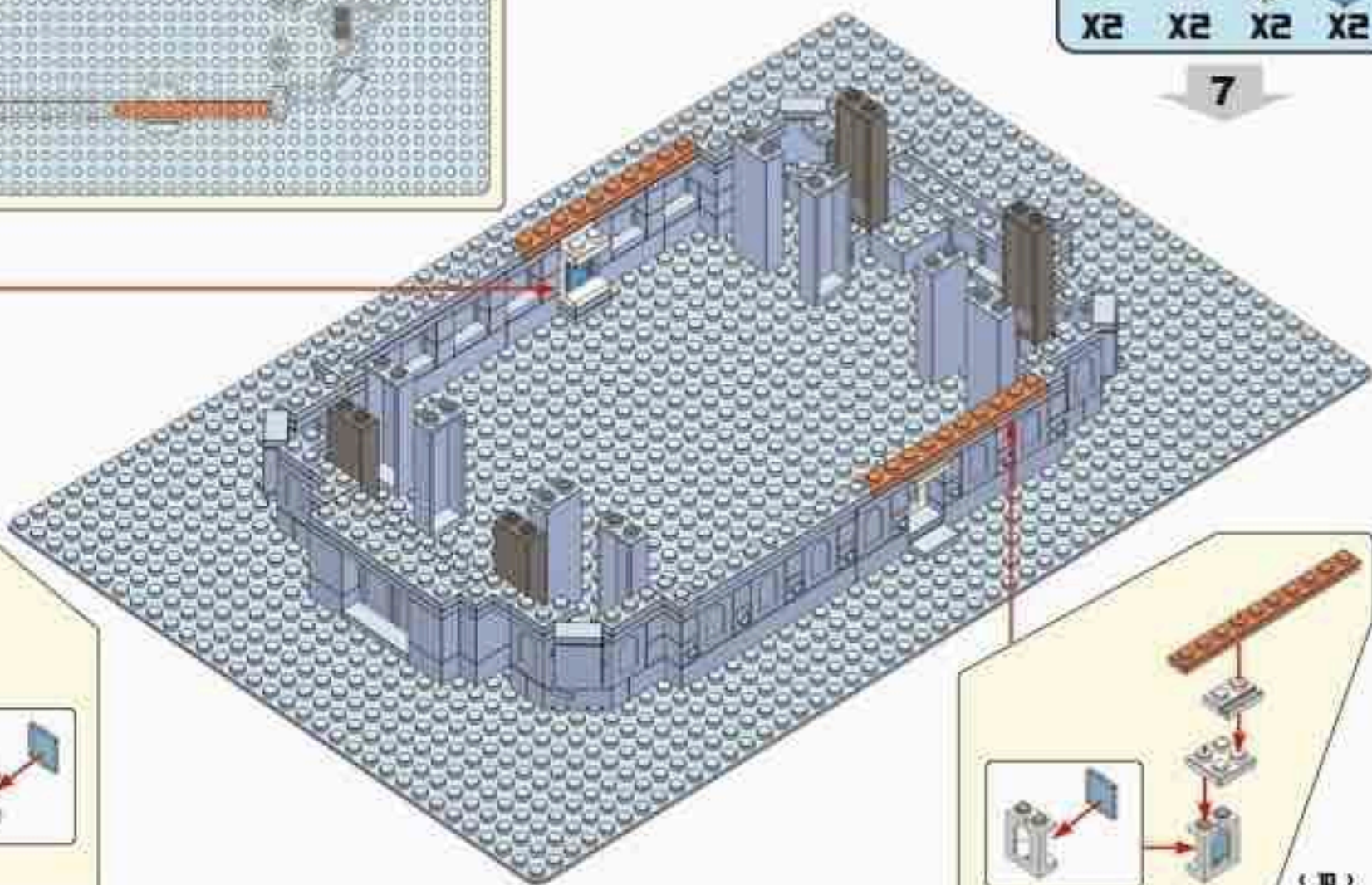

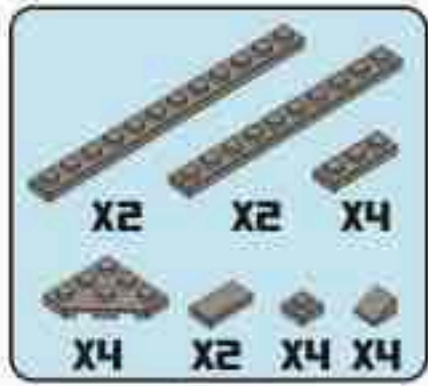

8

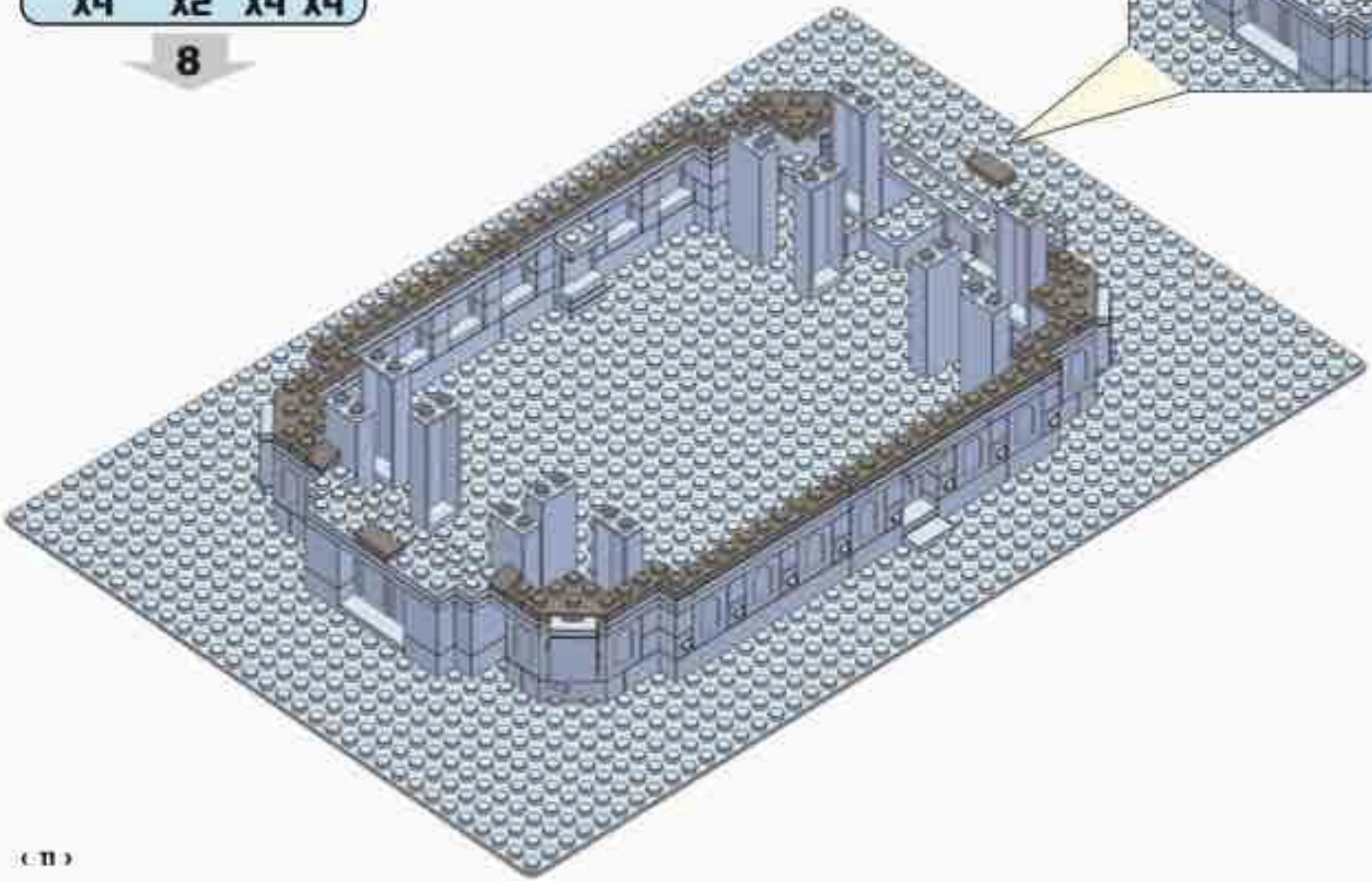
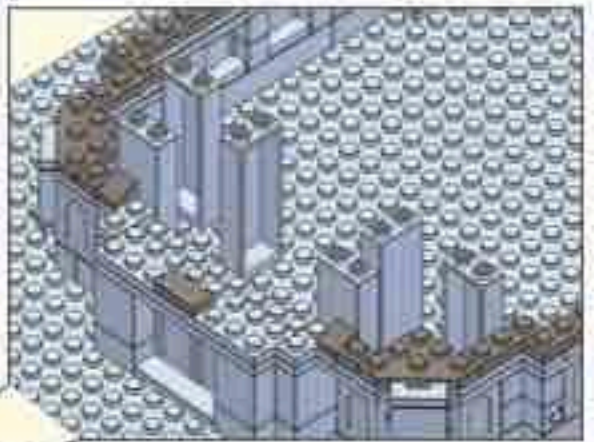



9

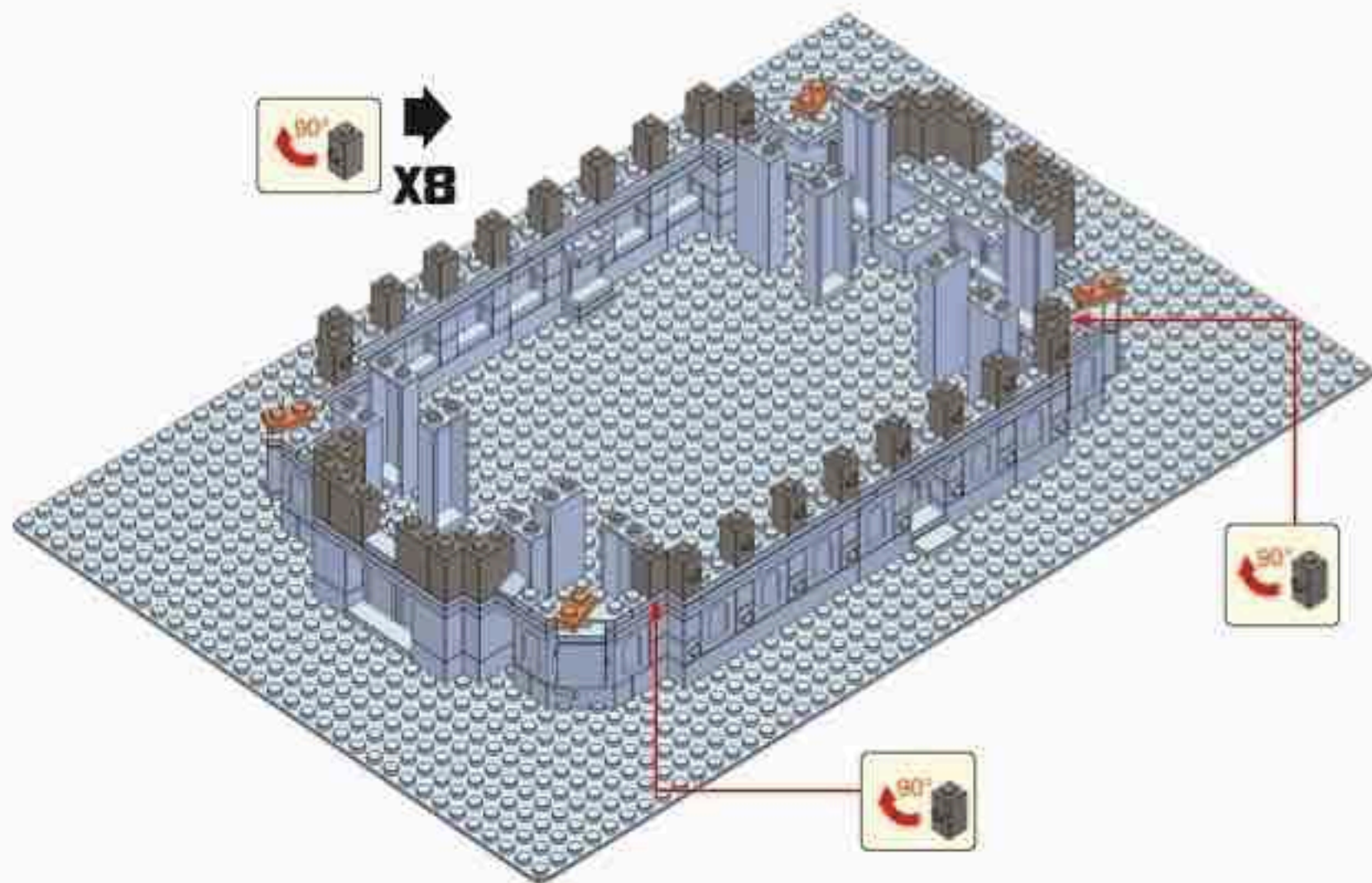

Large(L)

X22 X22 X4 X12 X4

10

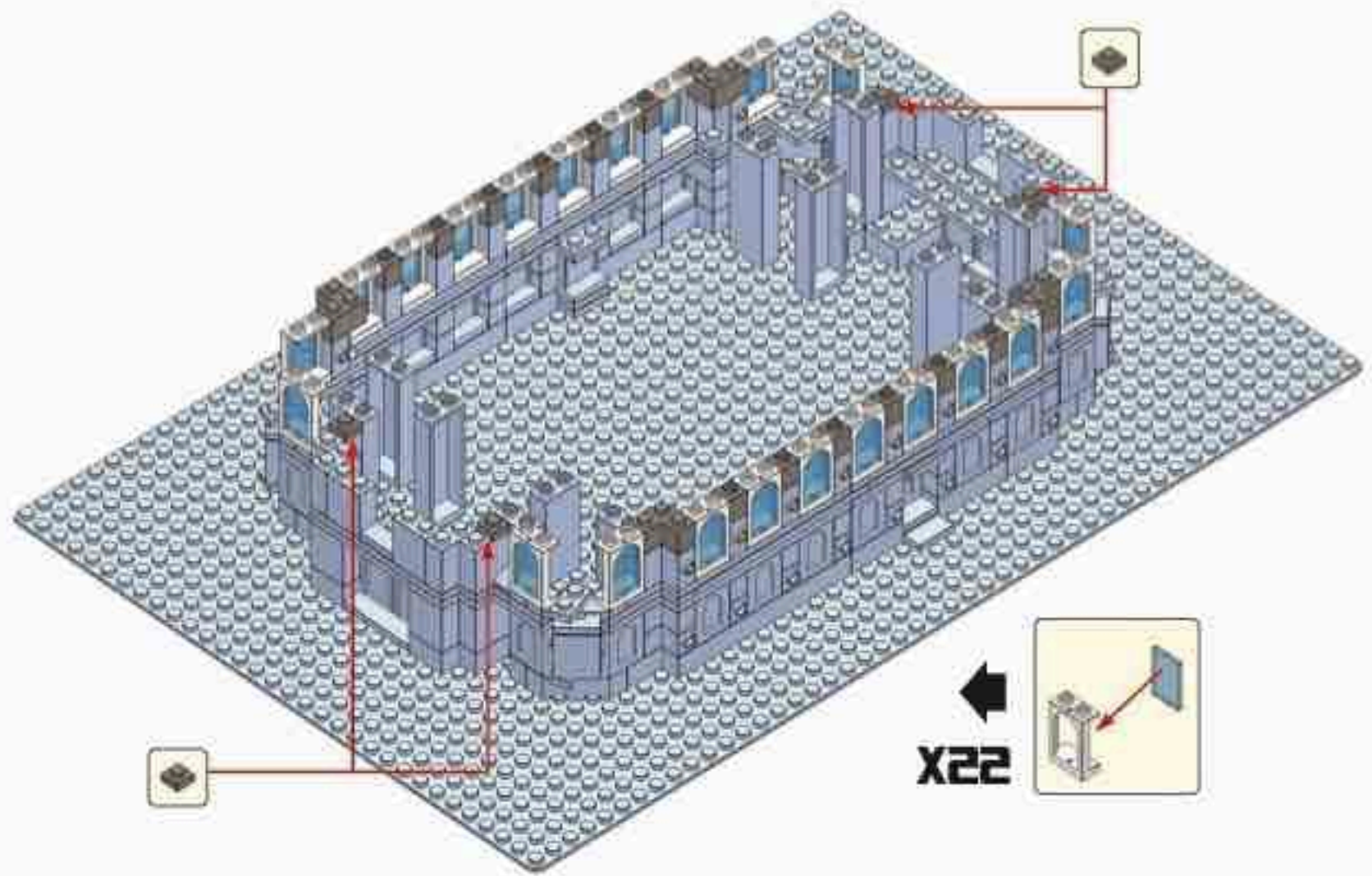

X22

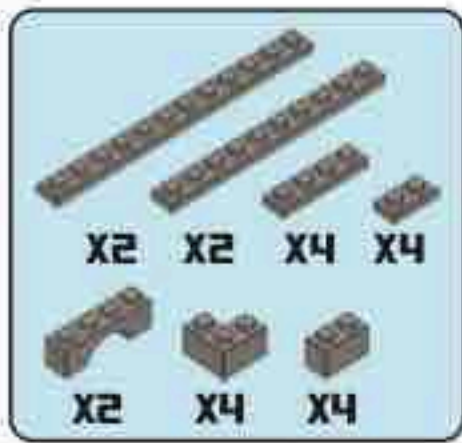

11

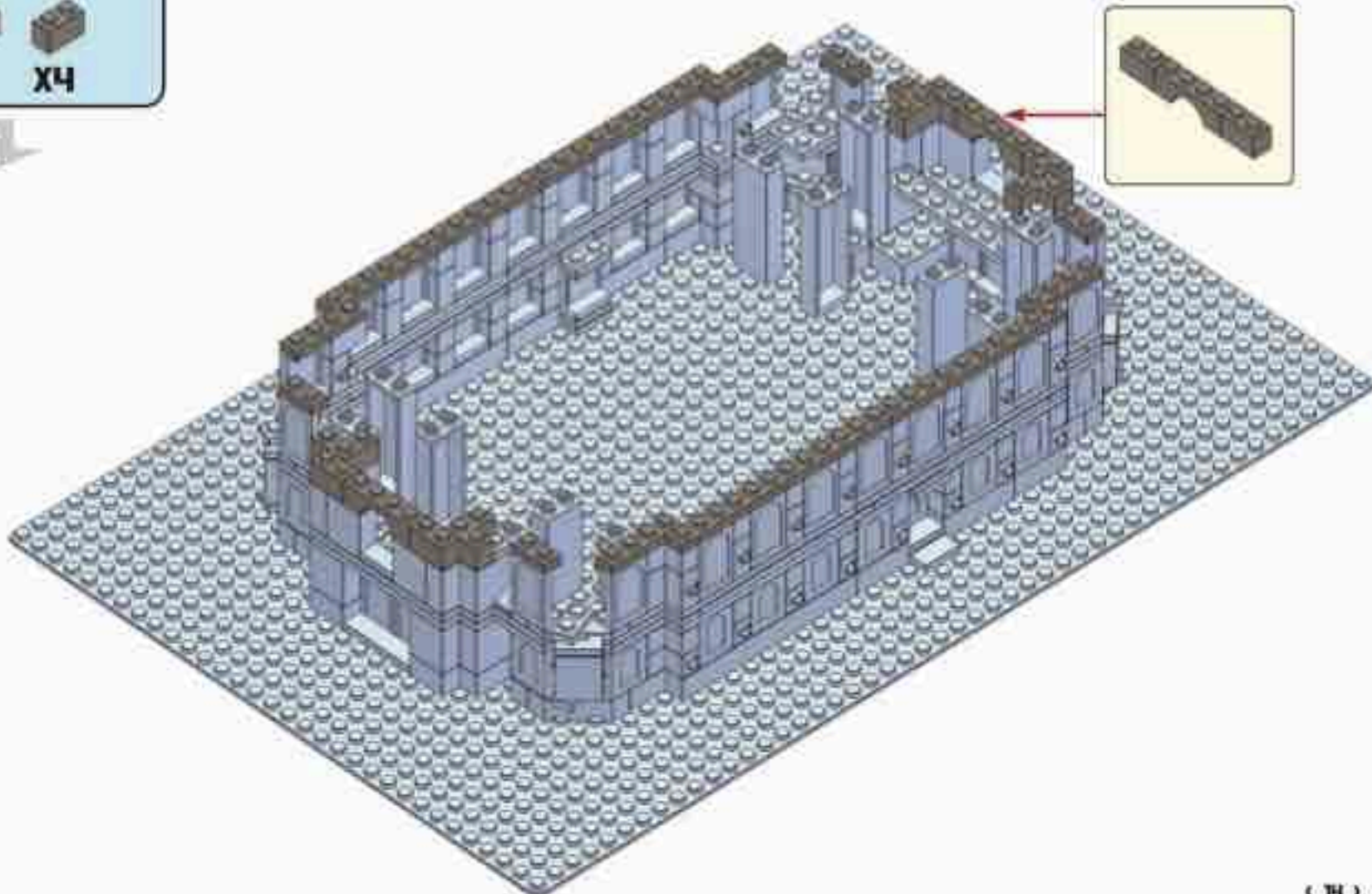



12

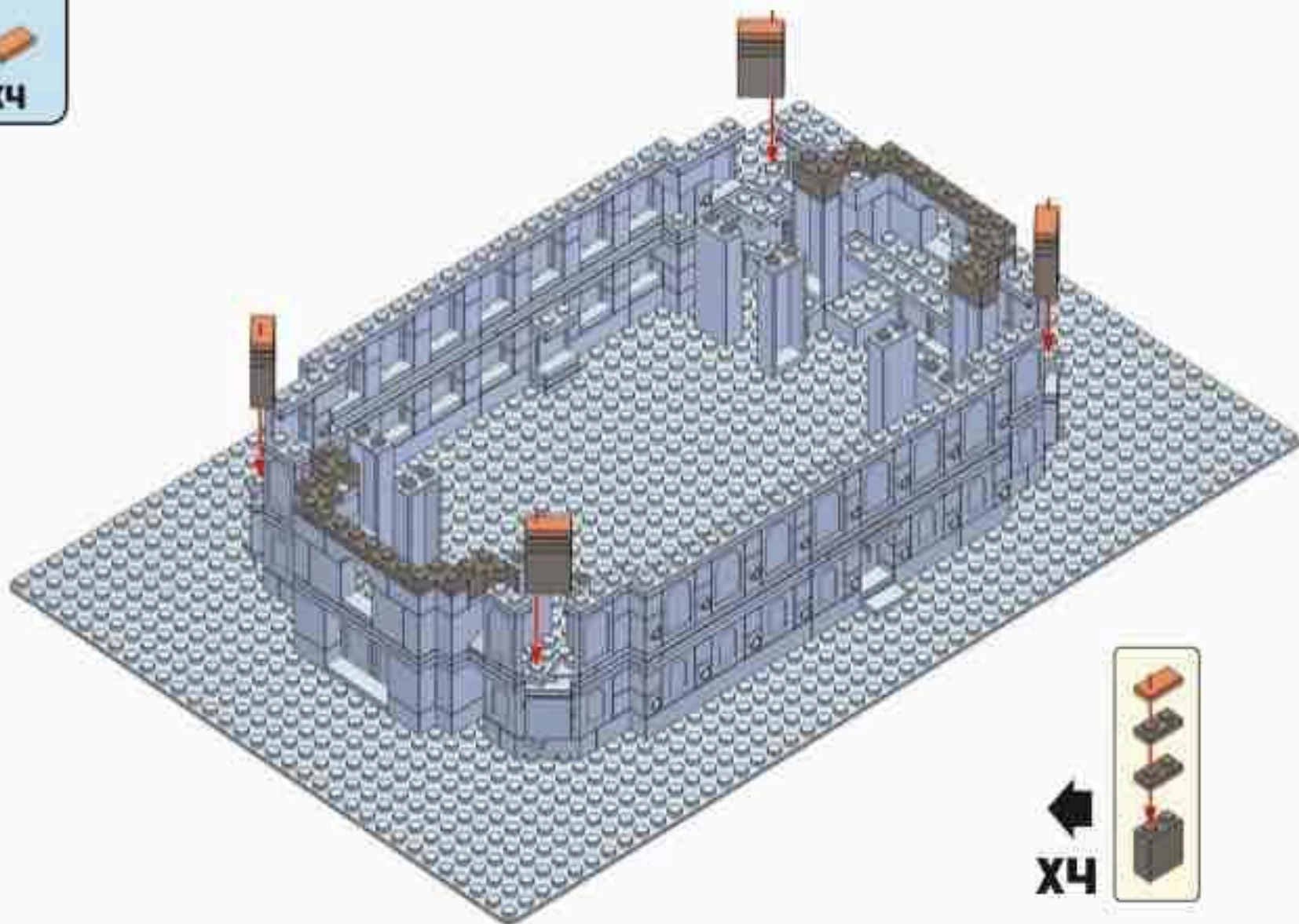

←
X4



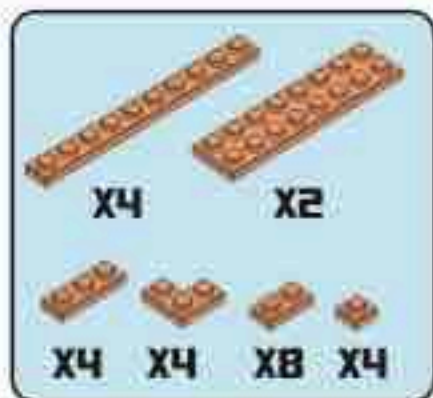

13

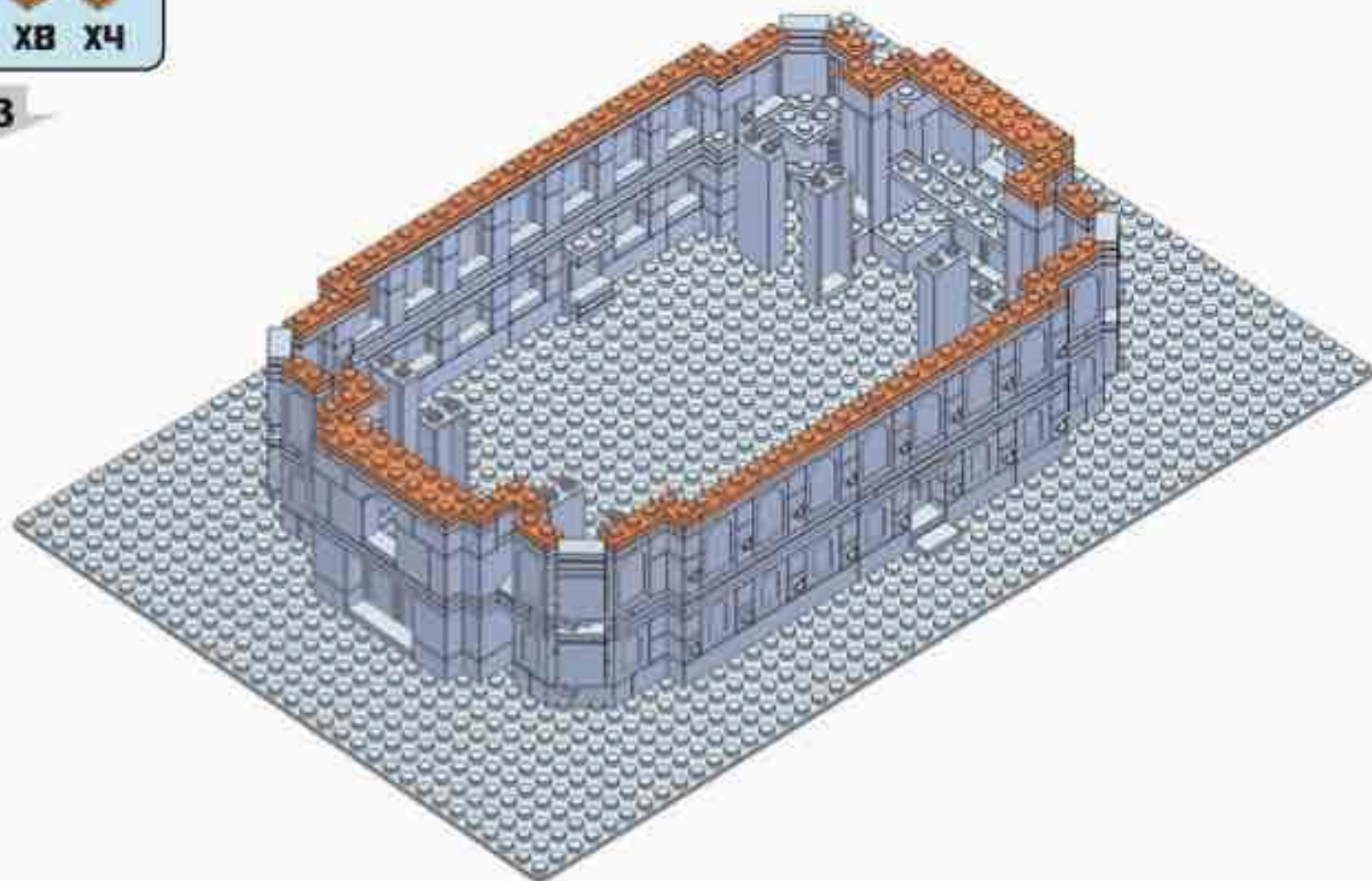

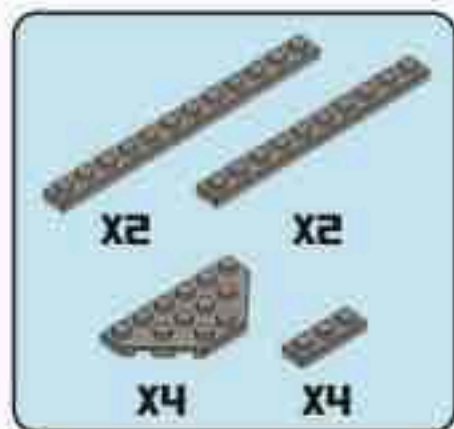

14

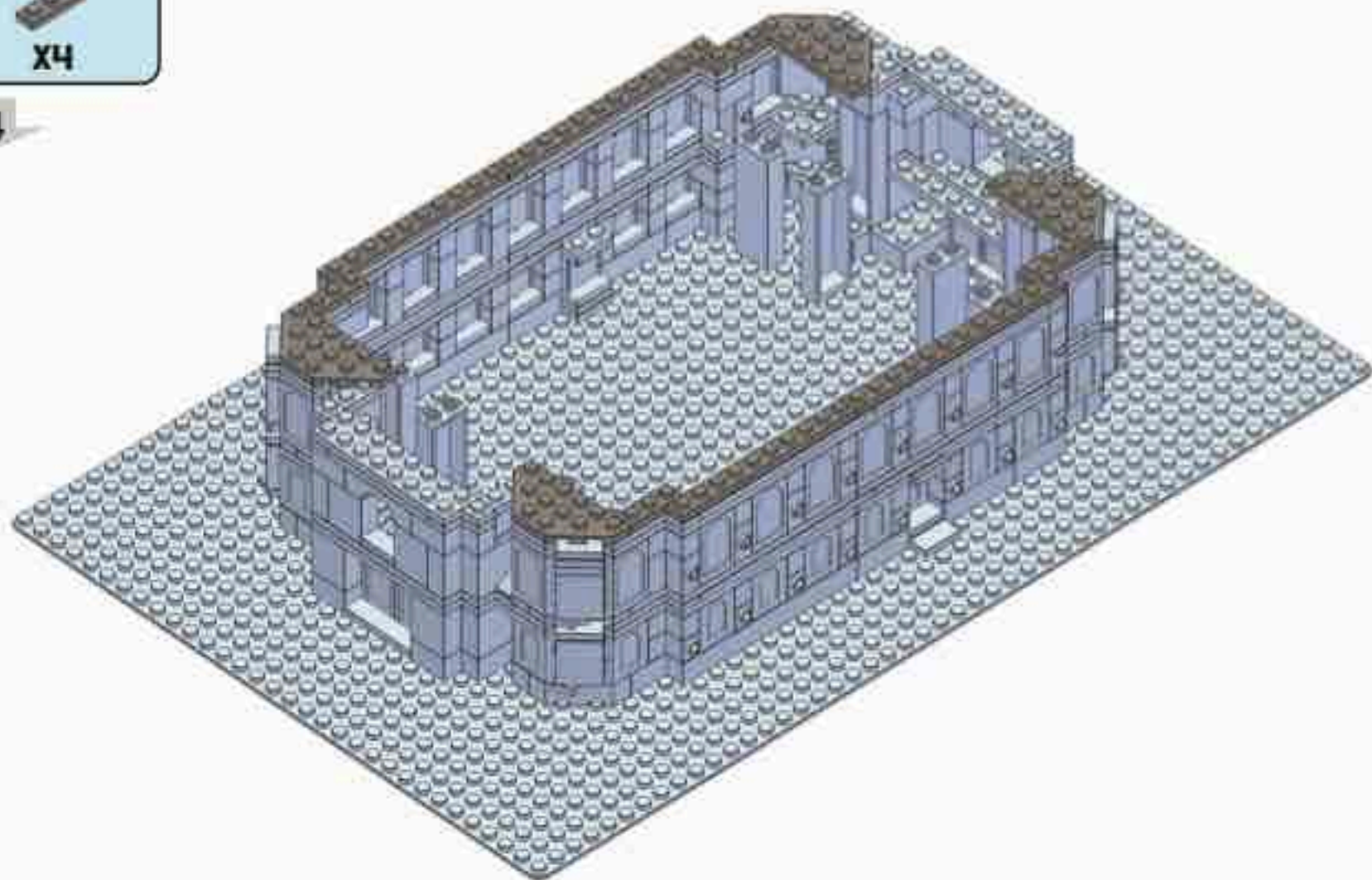



15

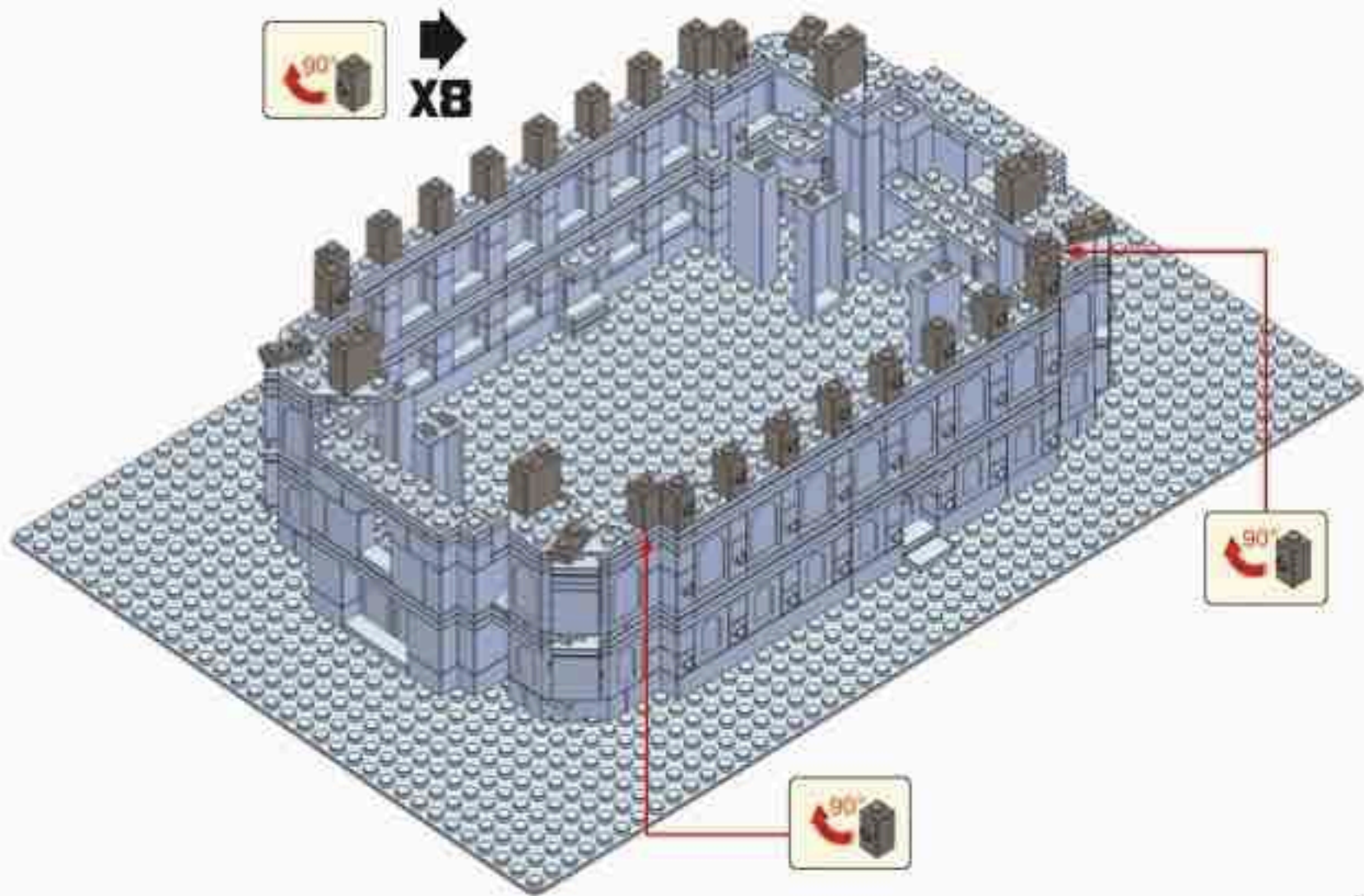
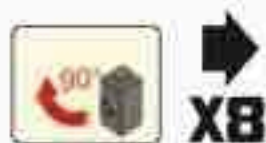

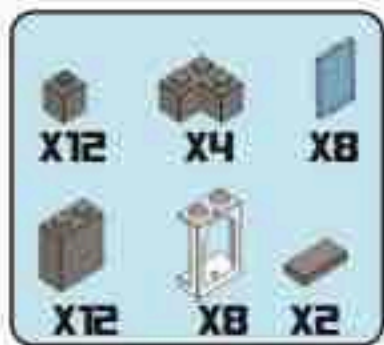

16

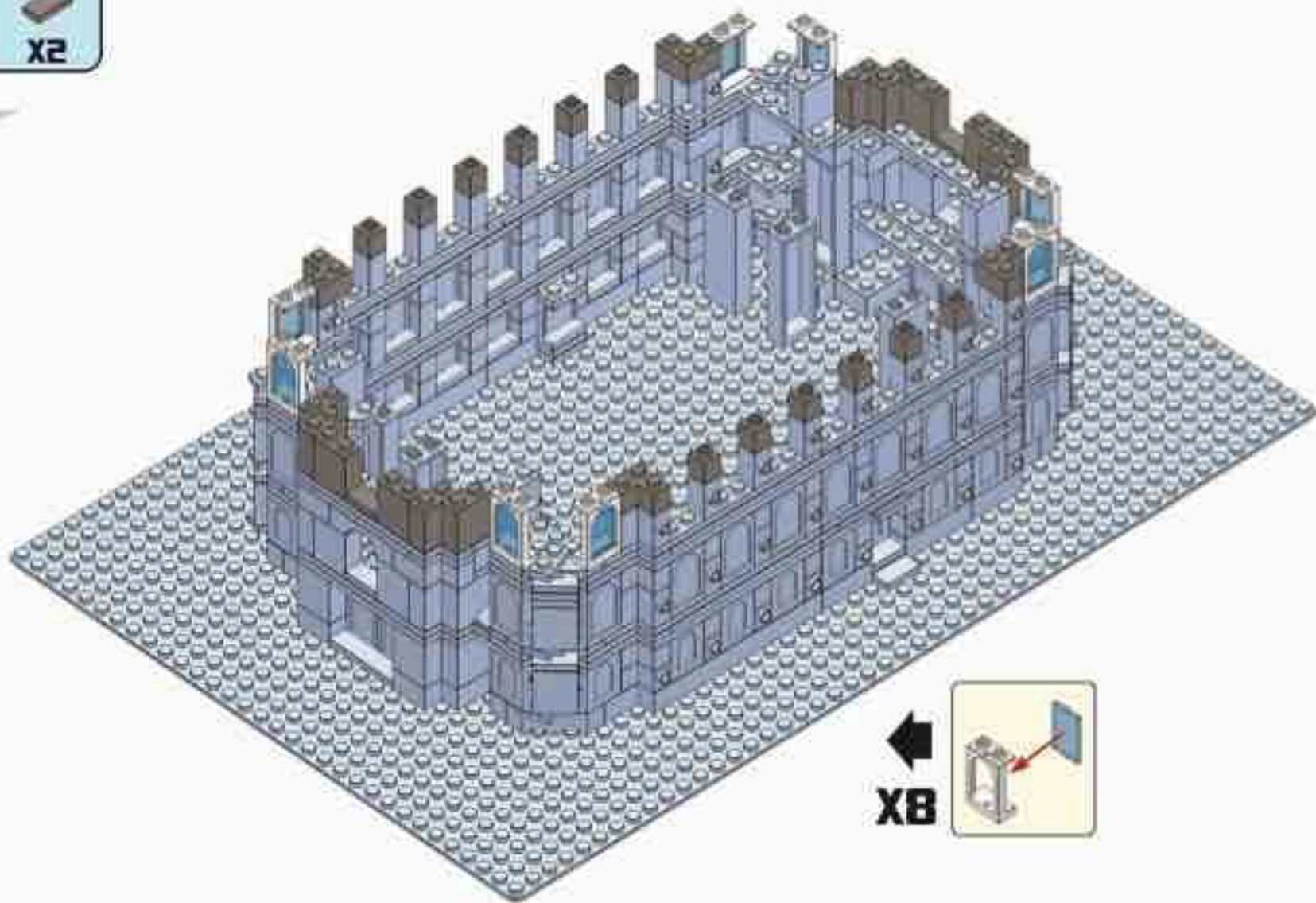



17

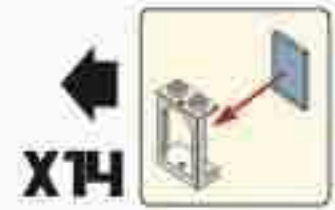
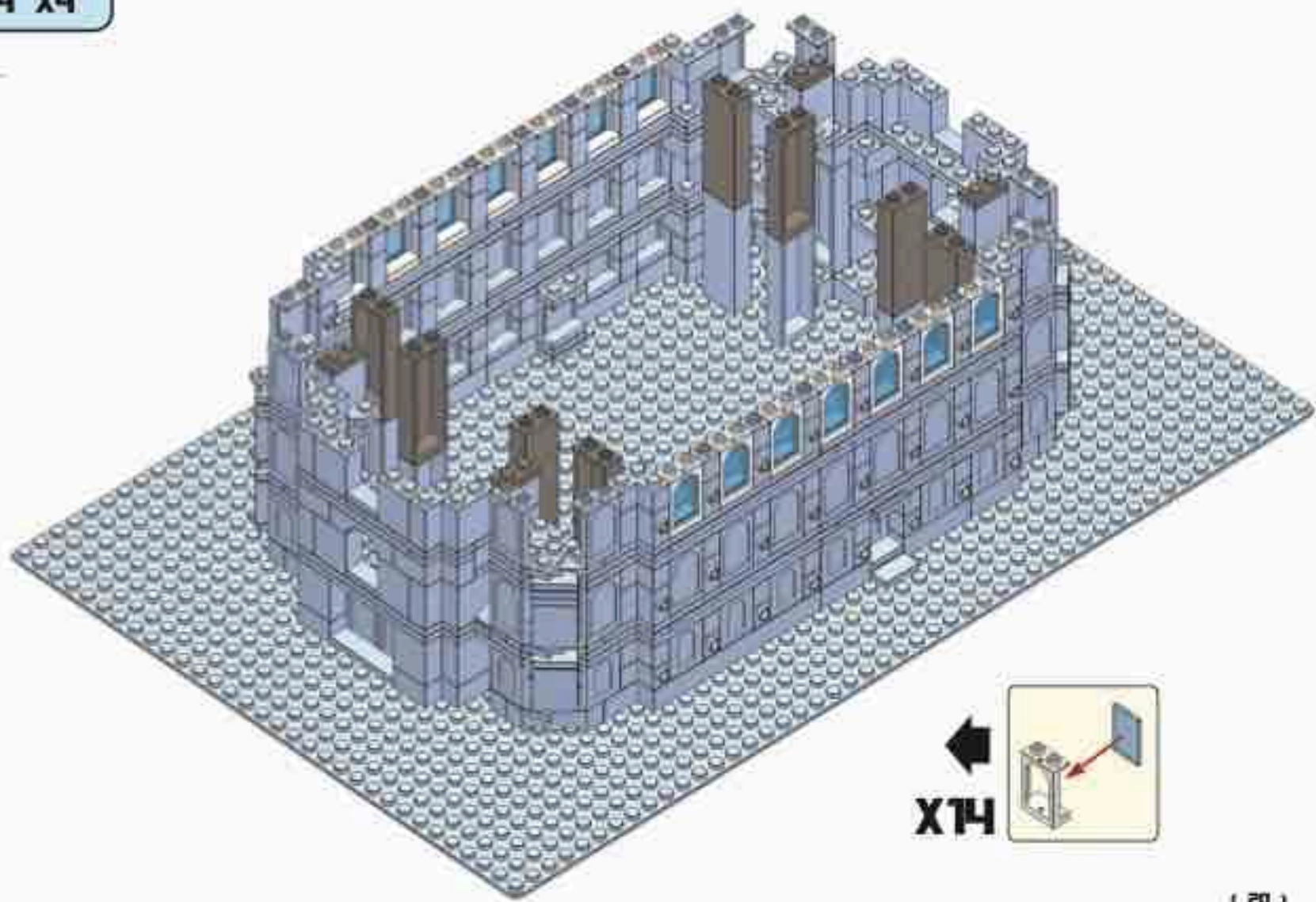



18

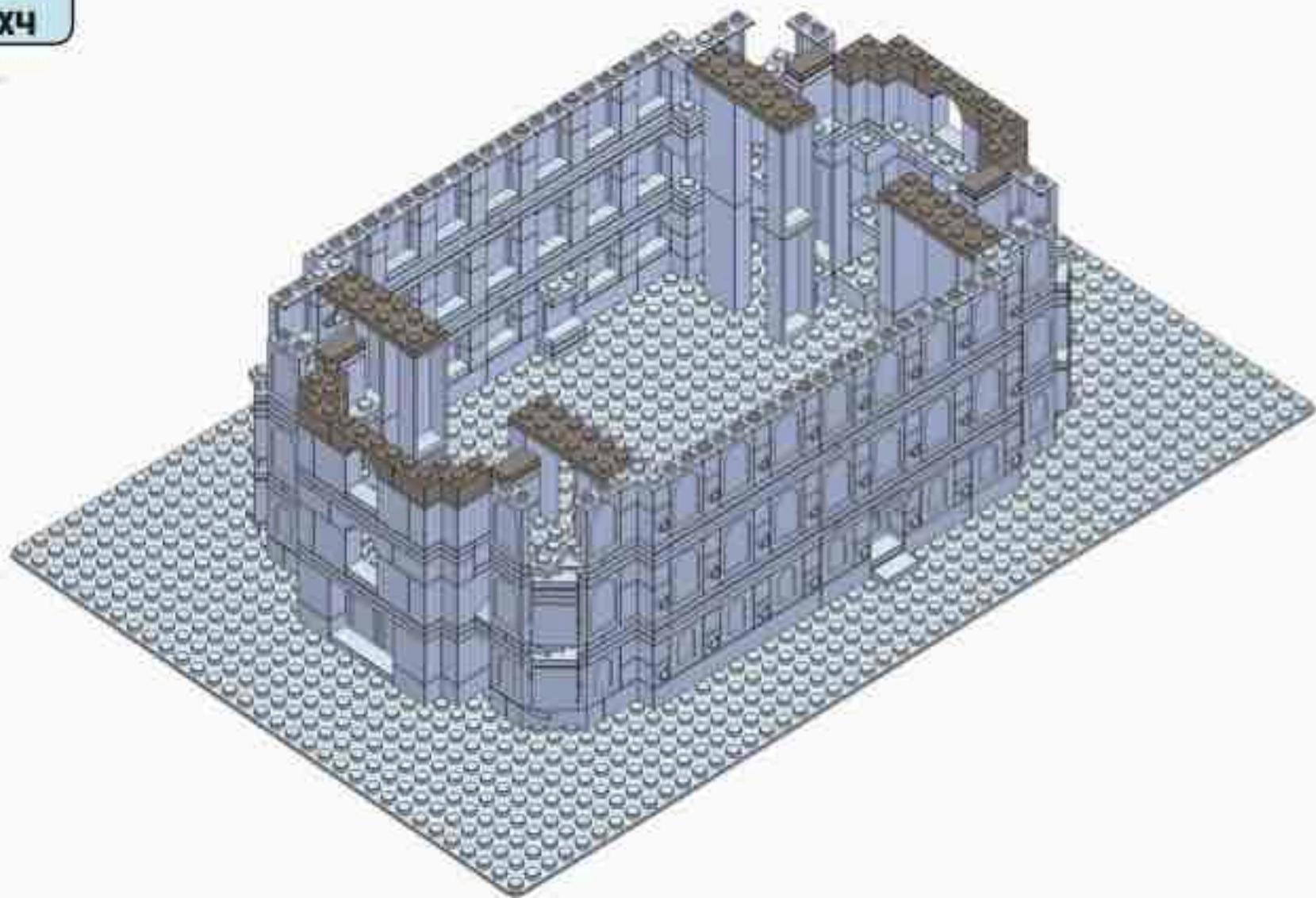

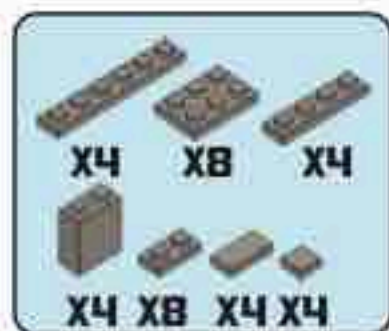

19

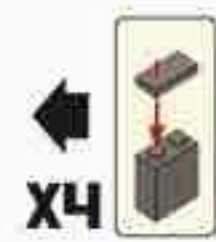
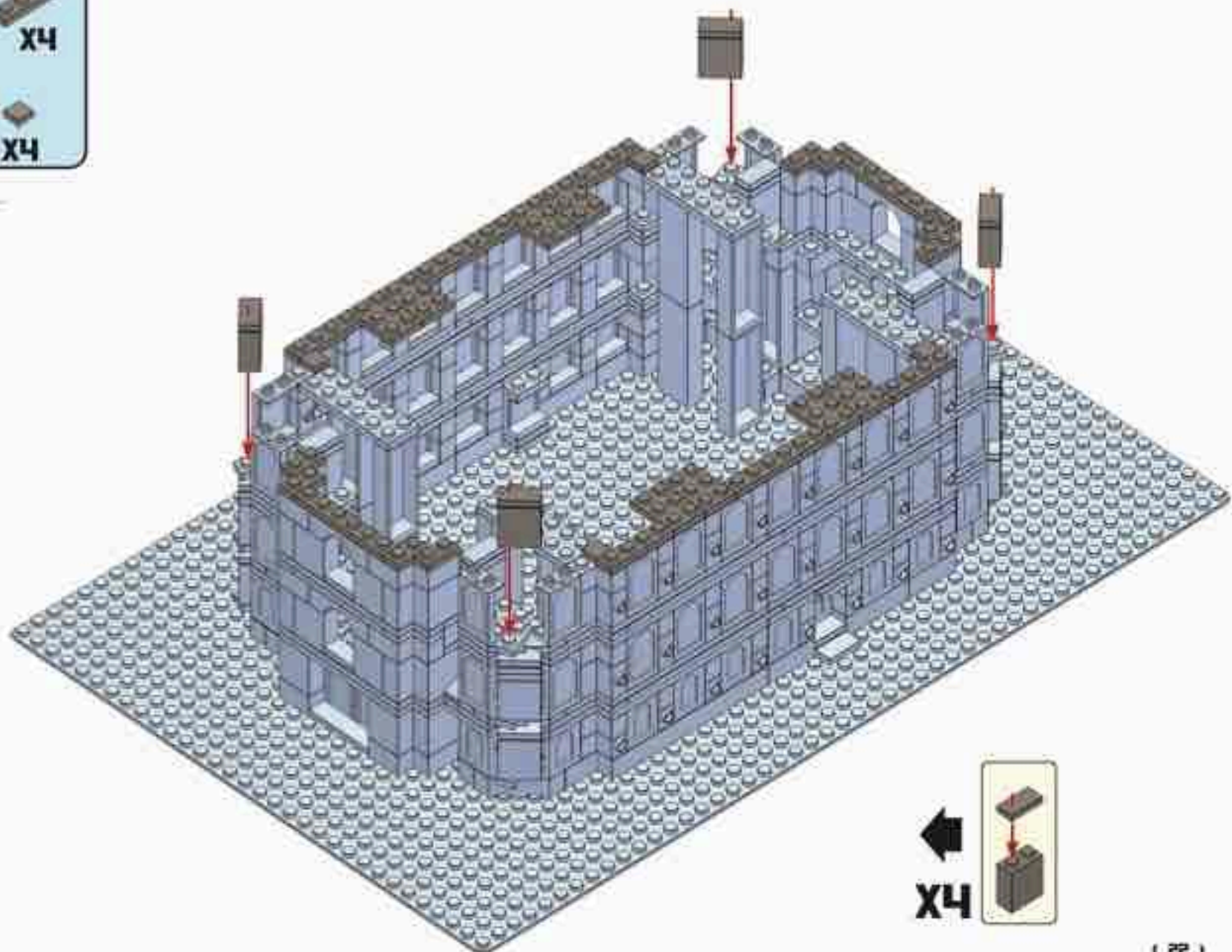

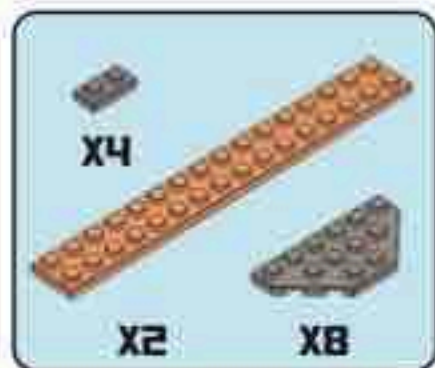

20

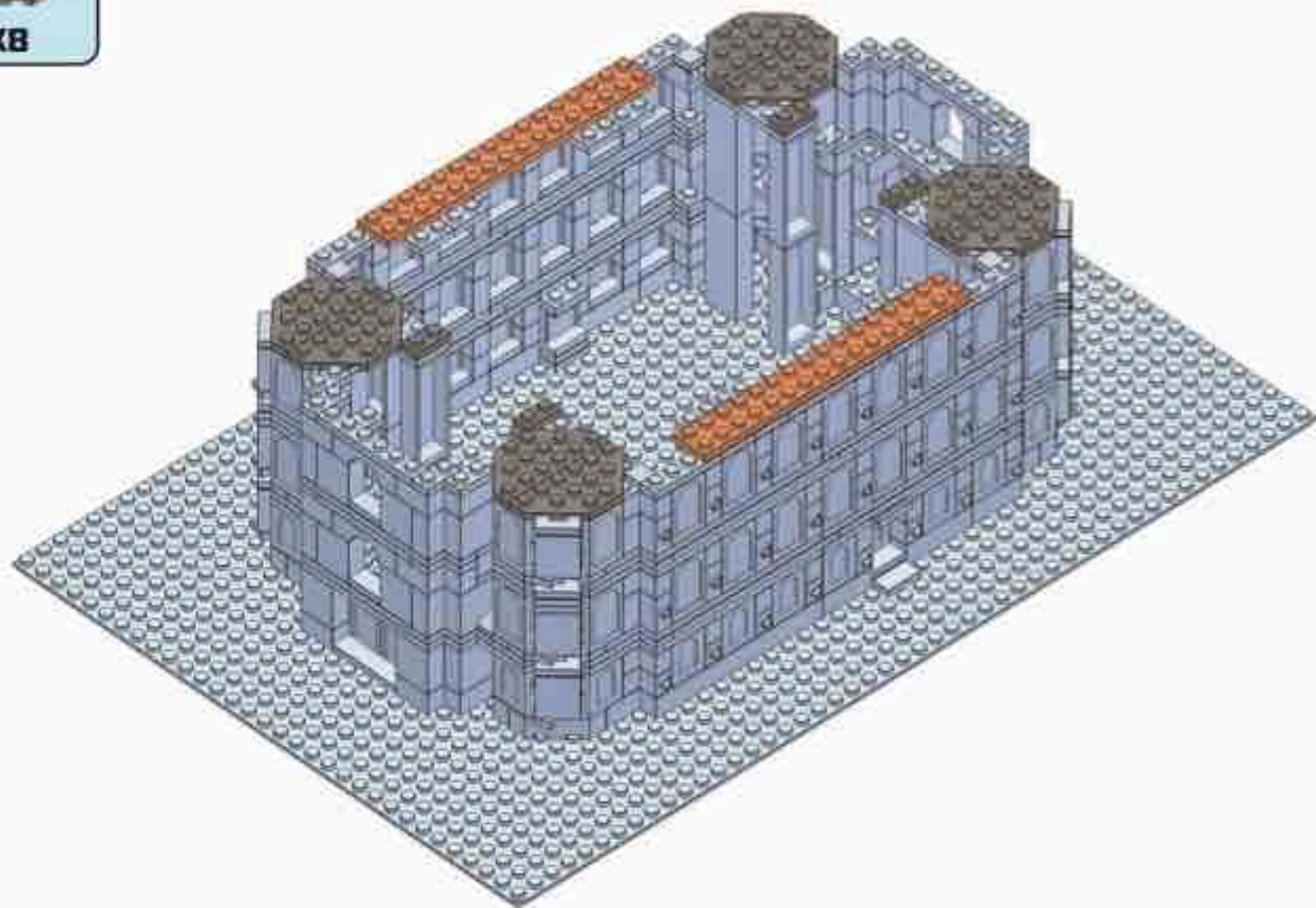

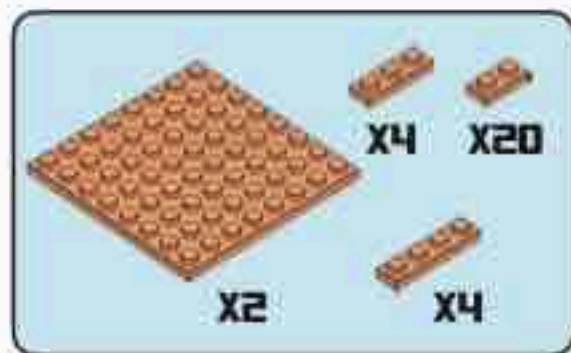

21





22

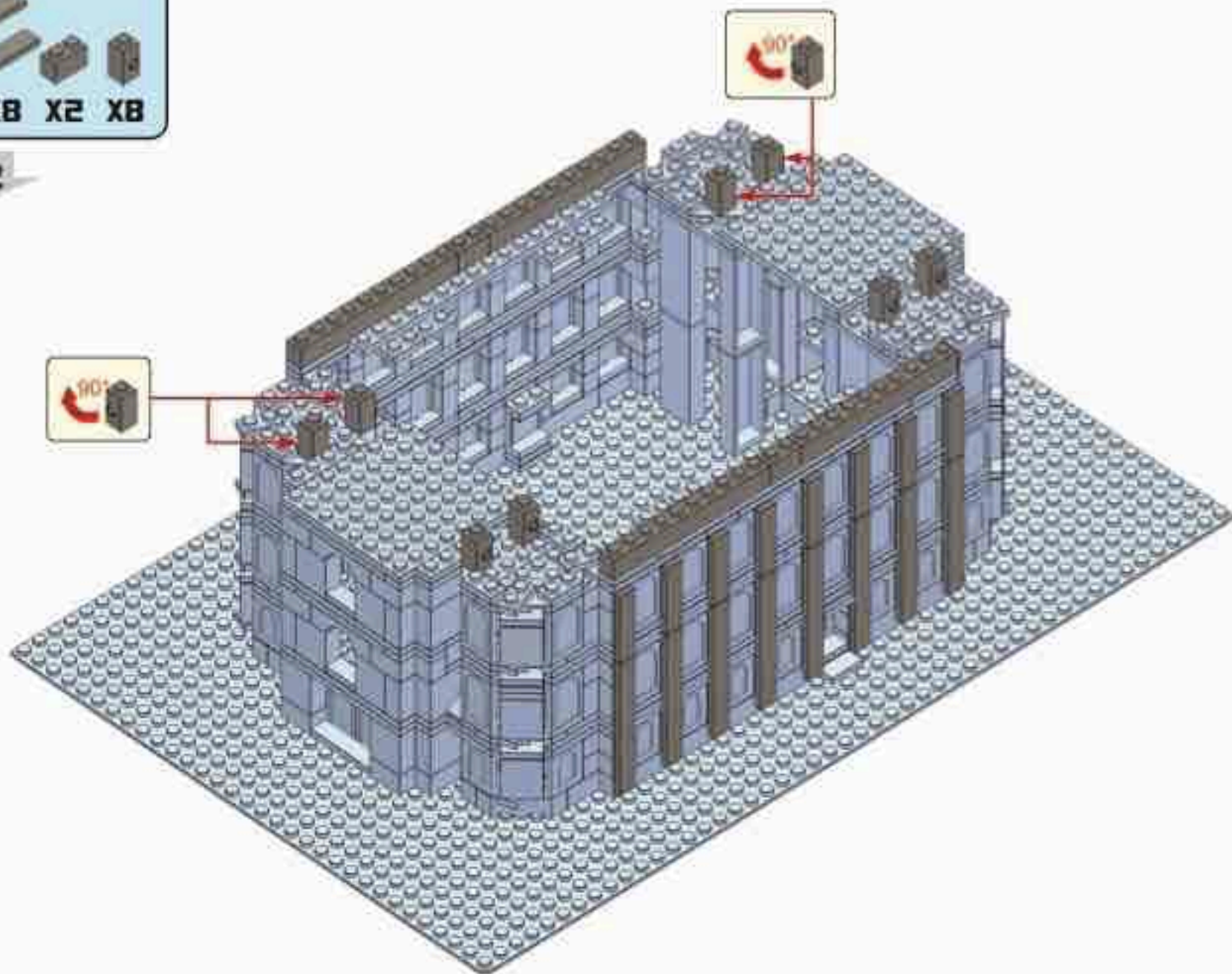

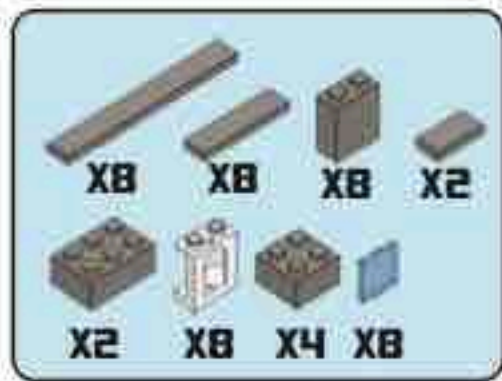

23

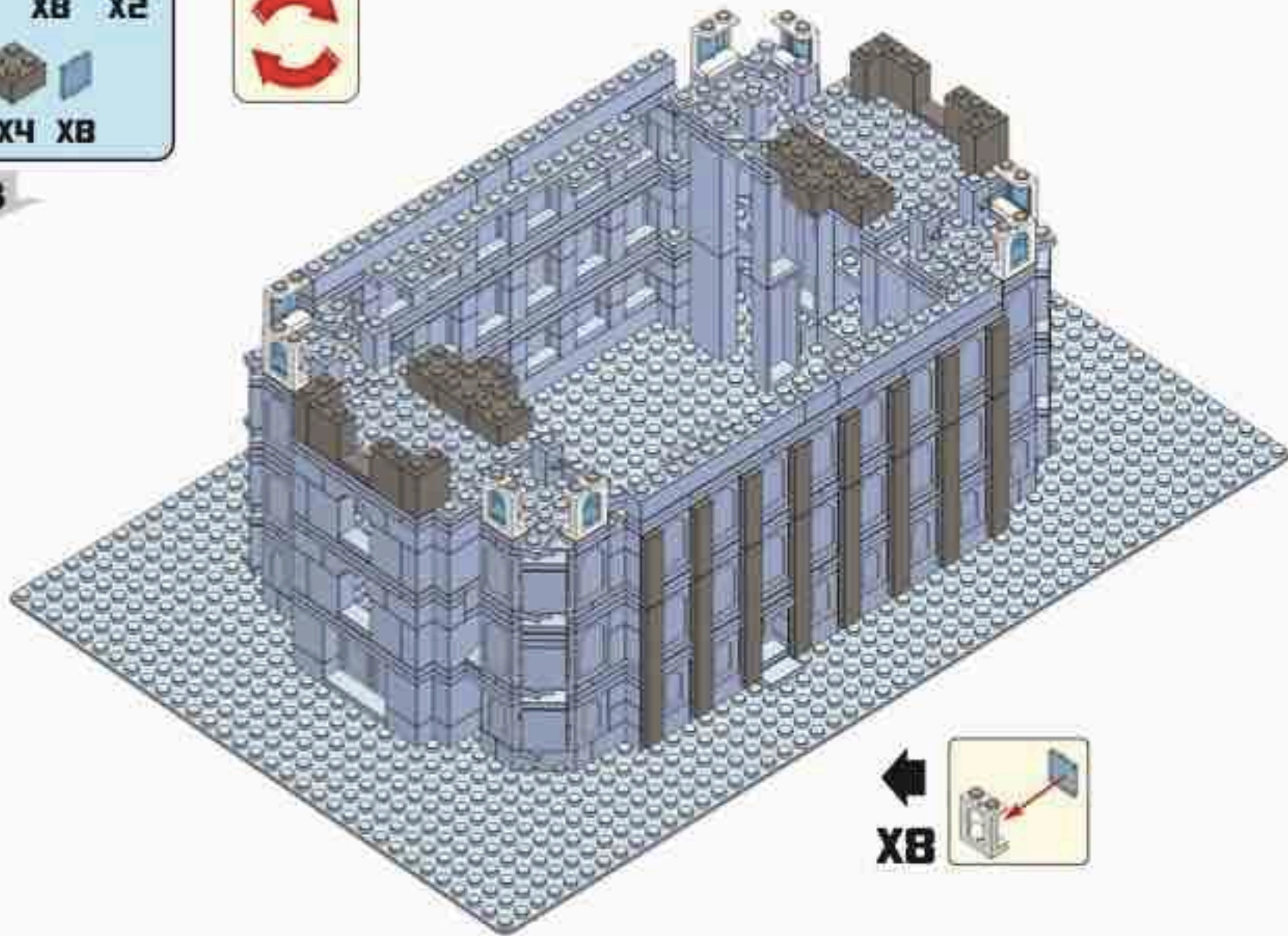

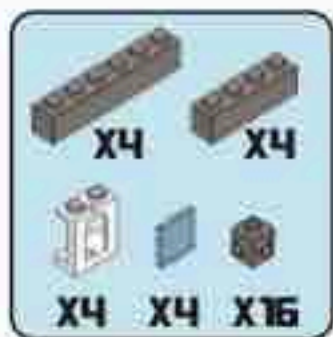

24

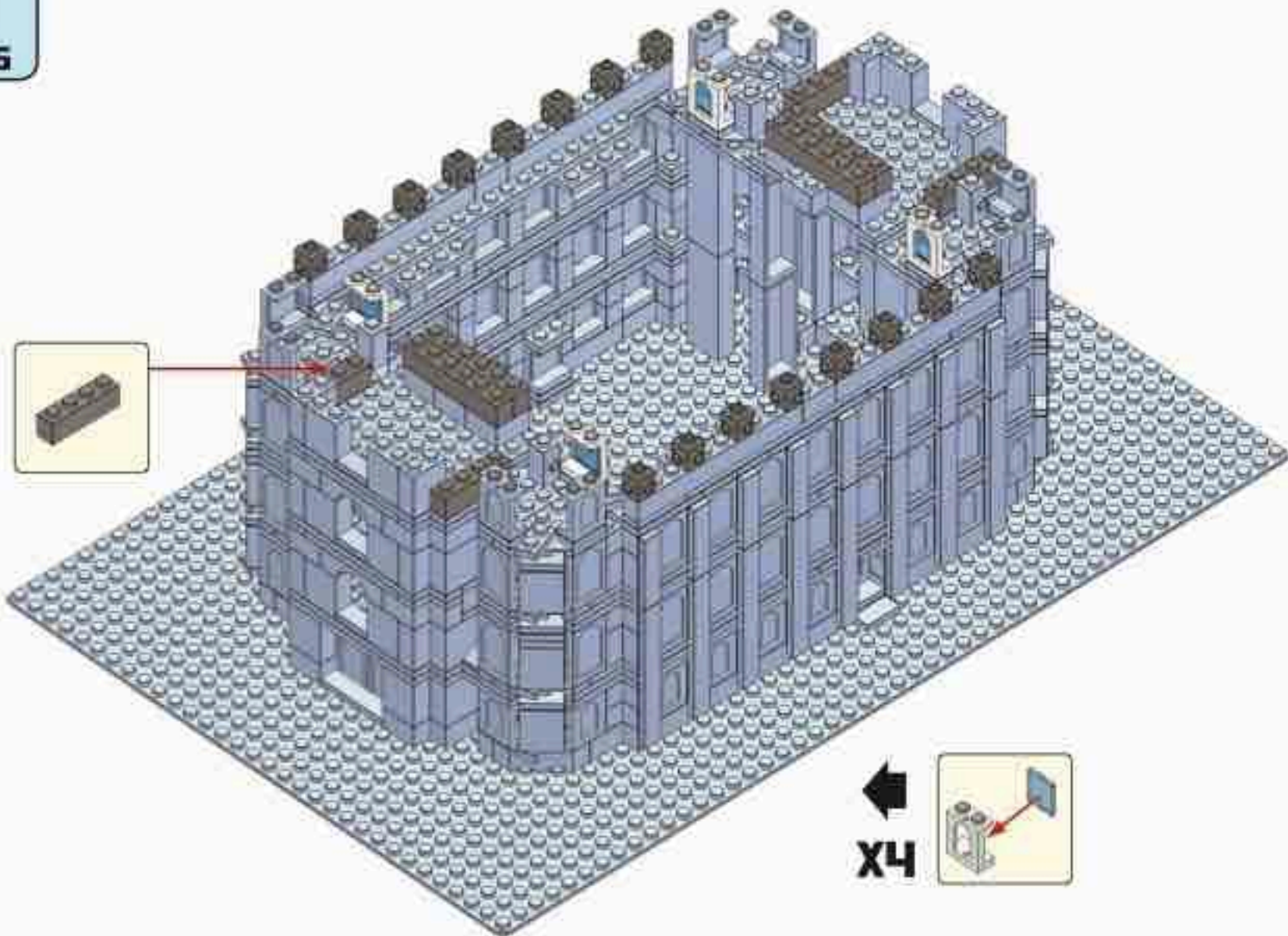



25

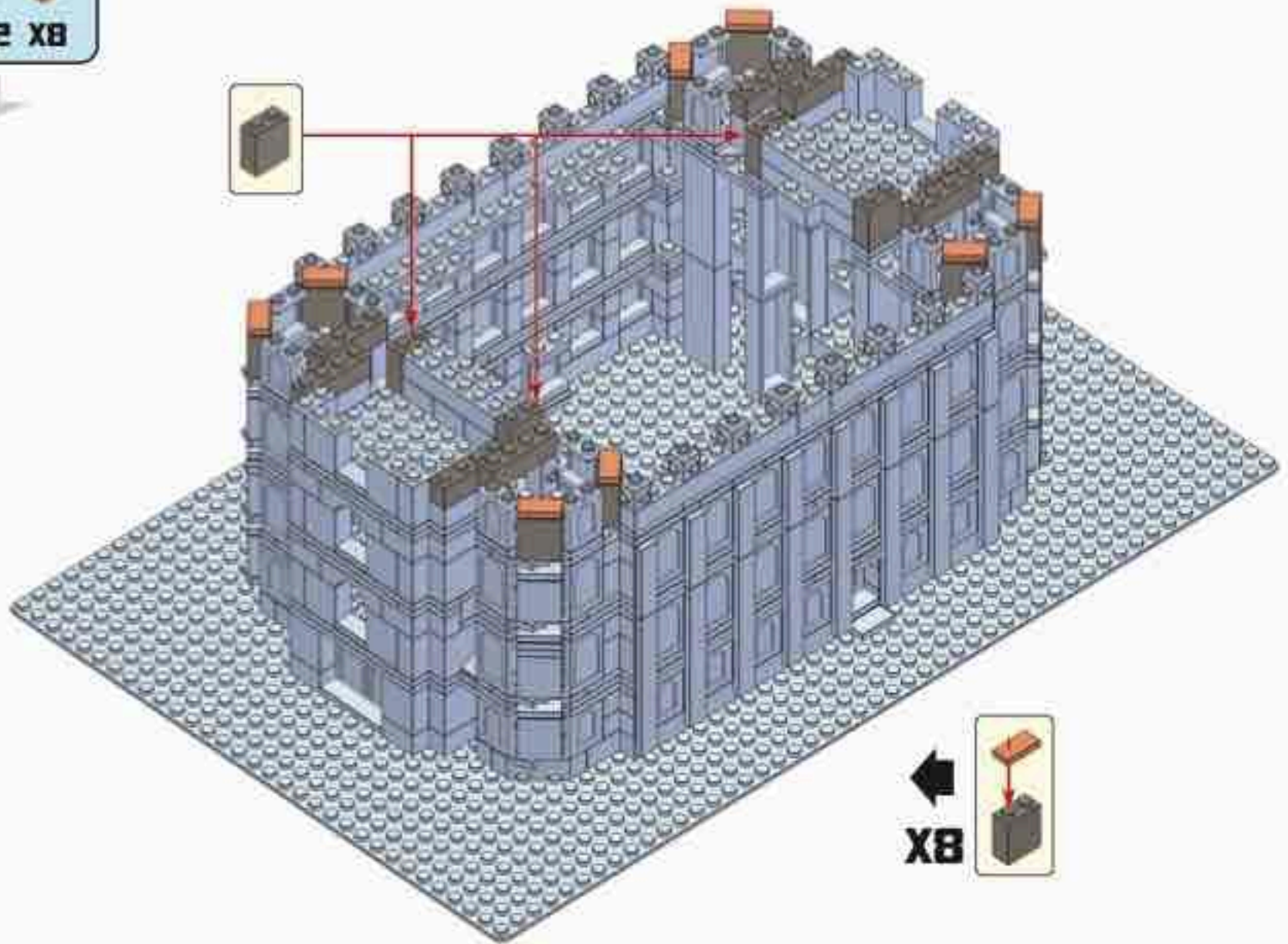



26

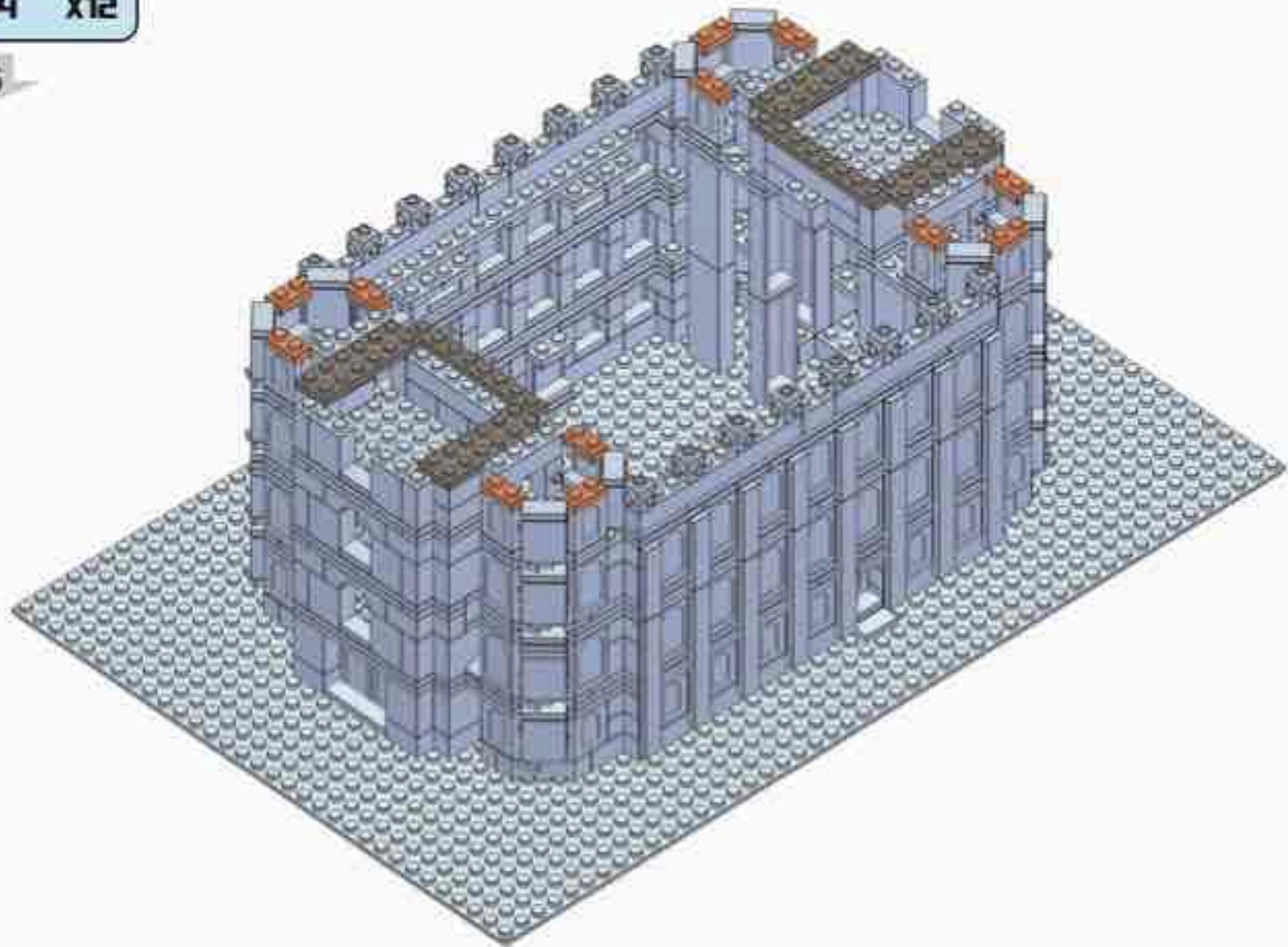

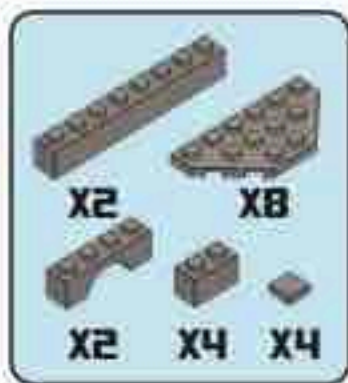

27

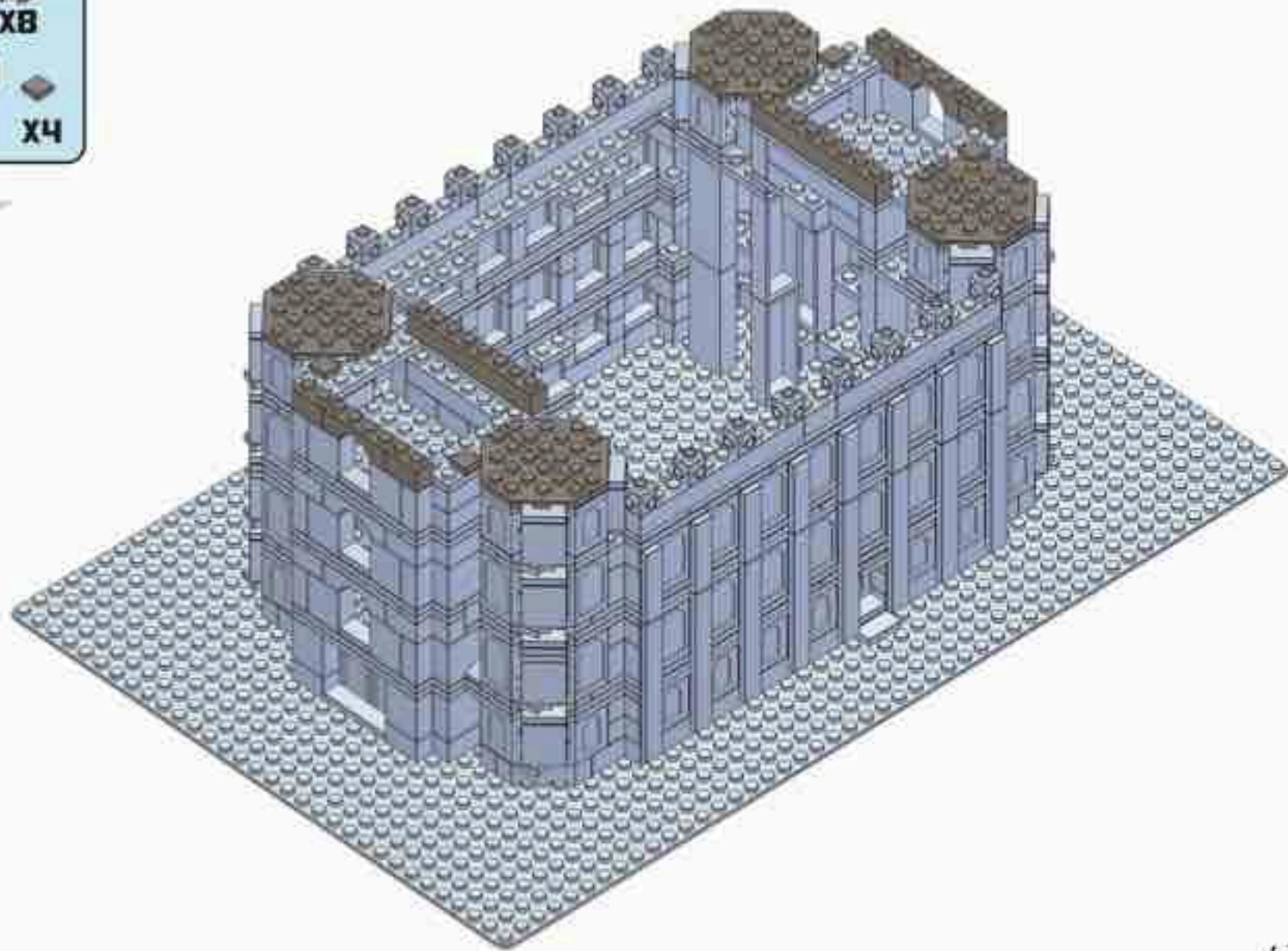

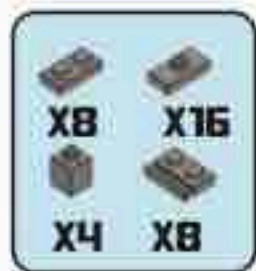

28

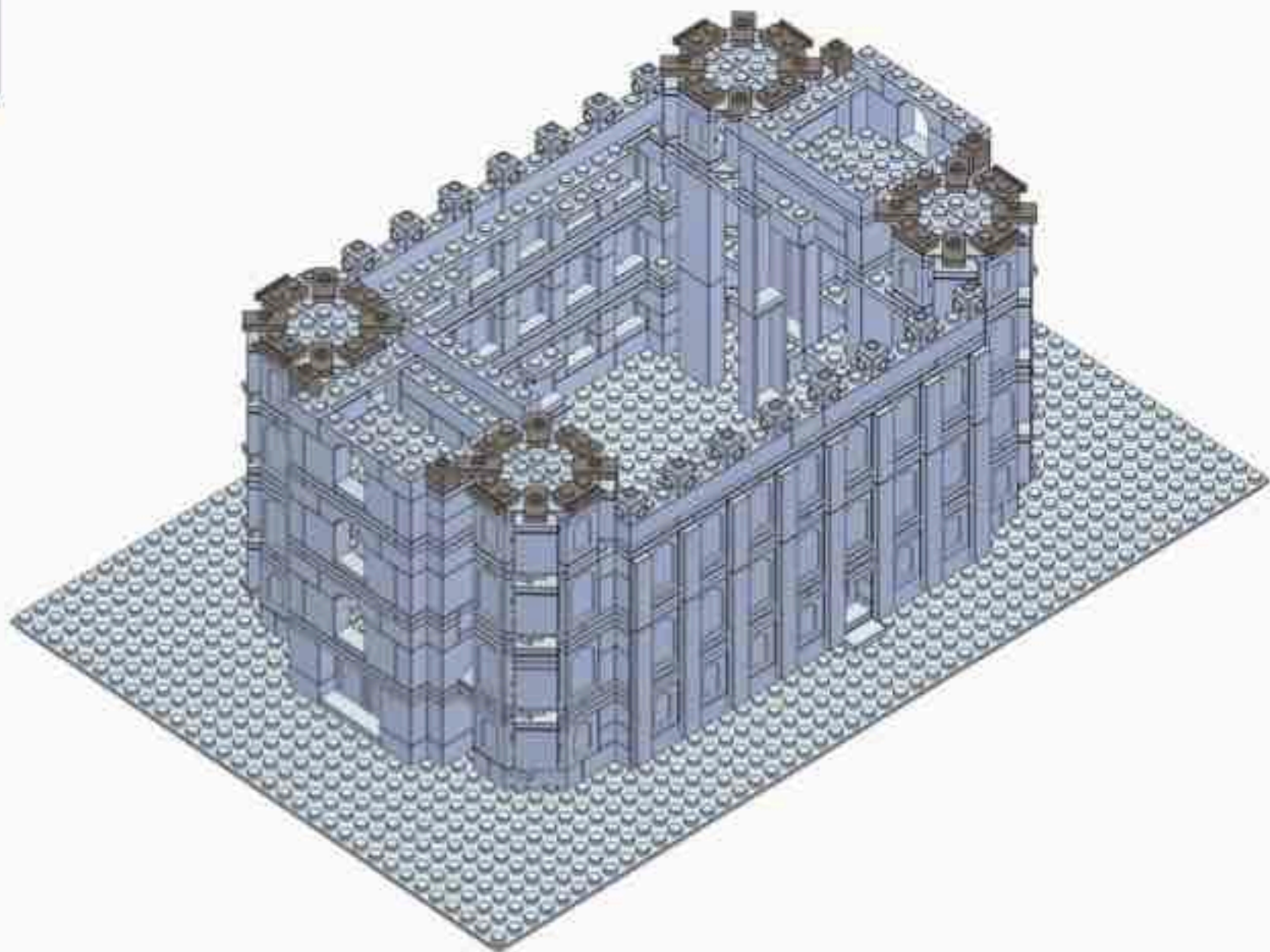



29

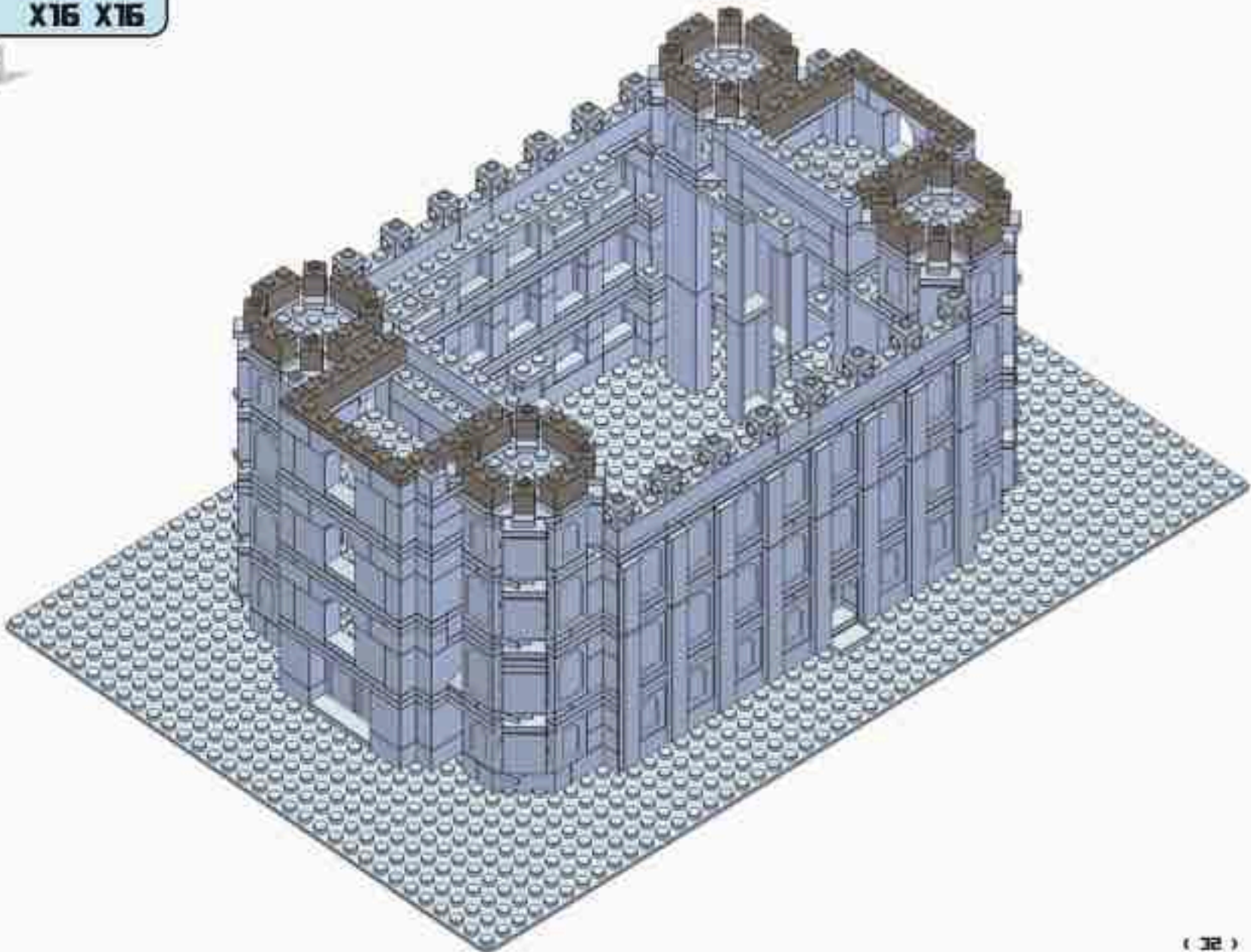



30

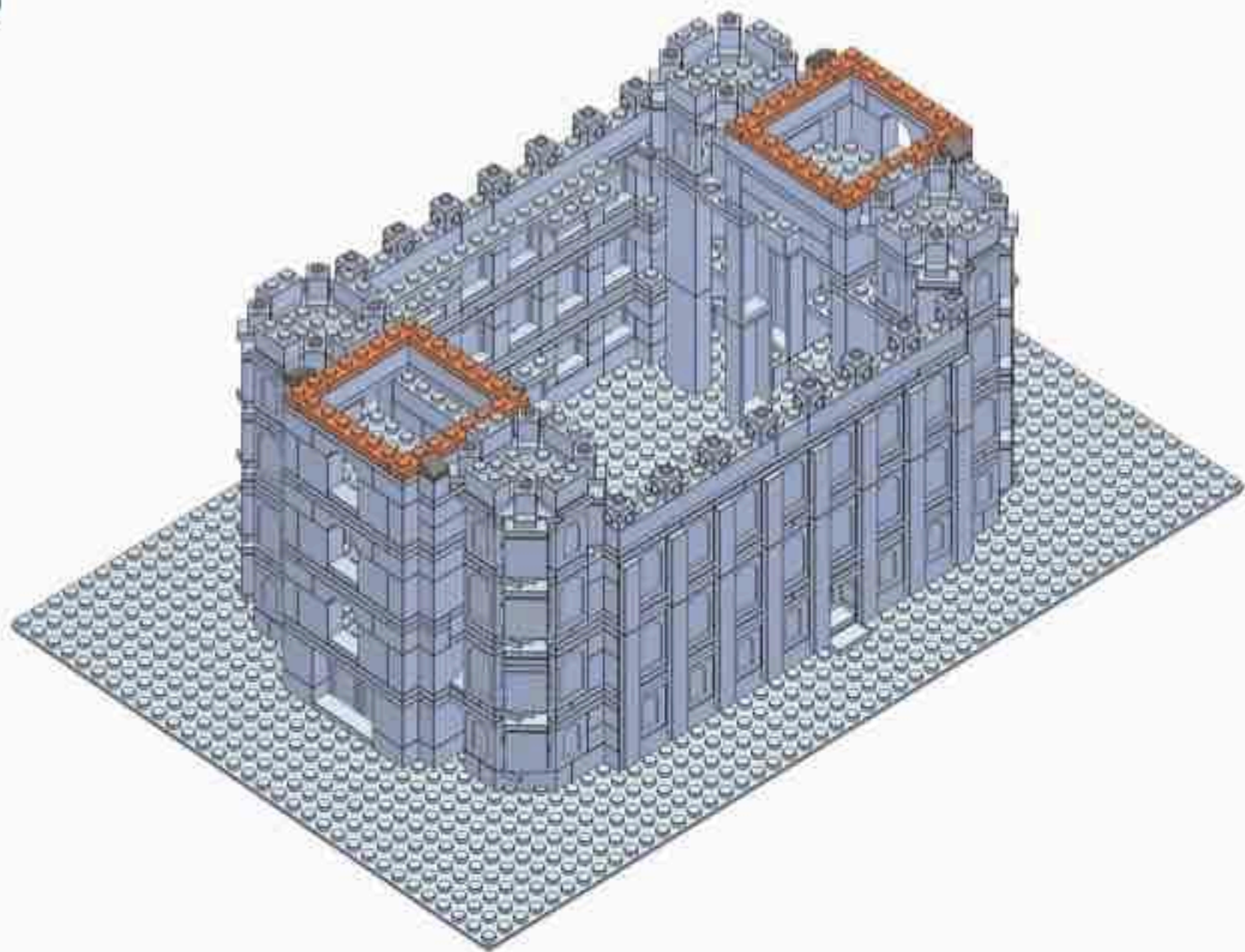

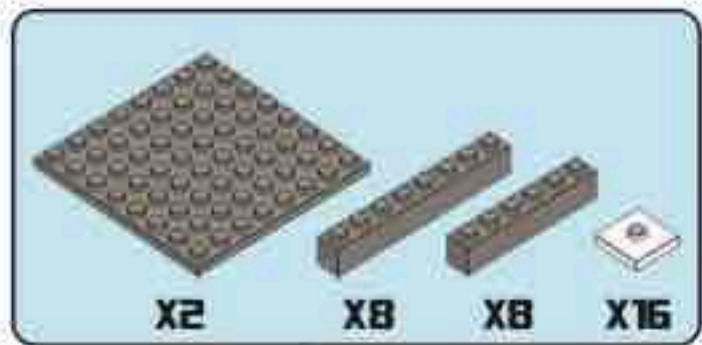

31

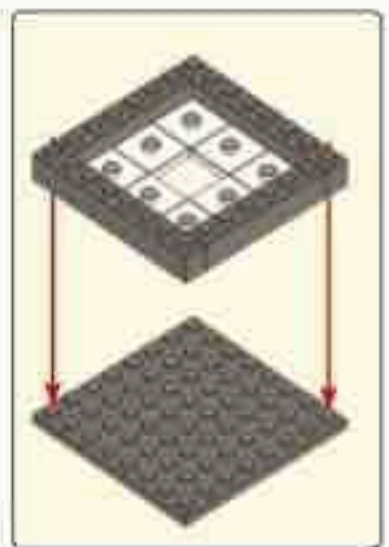
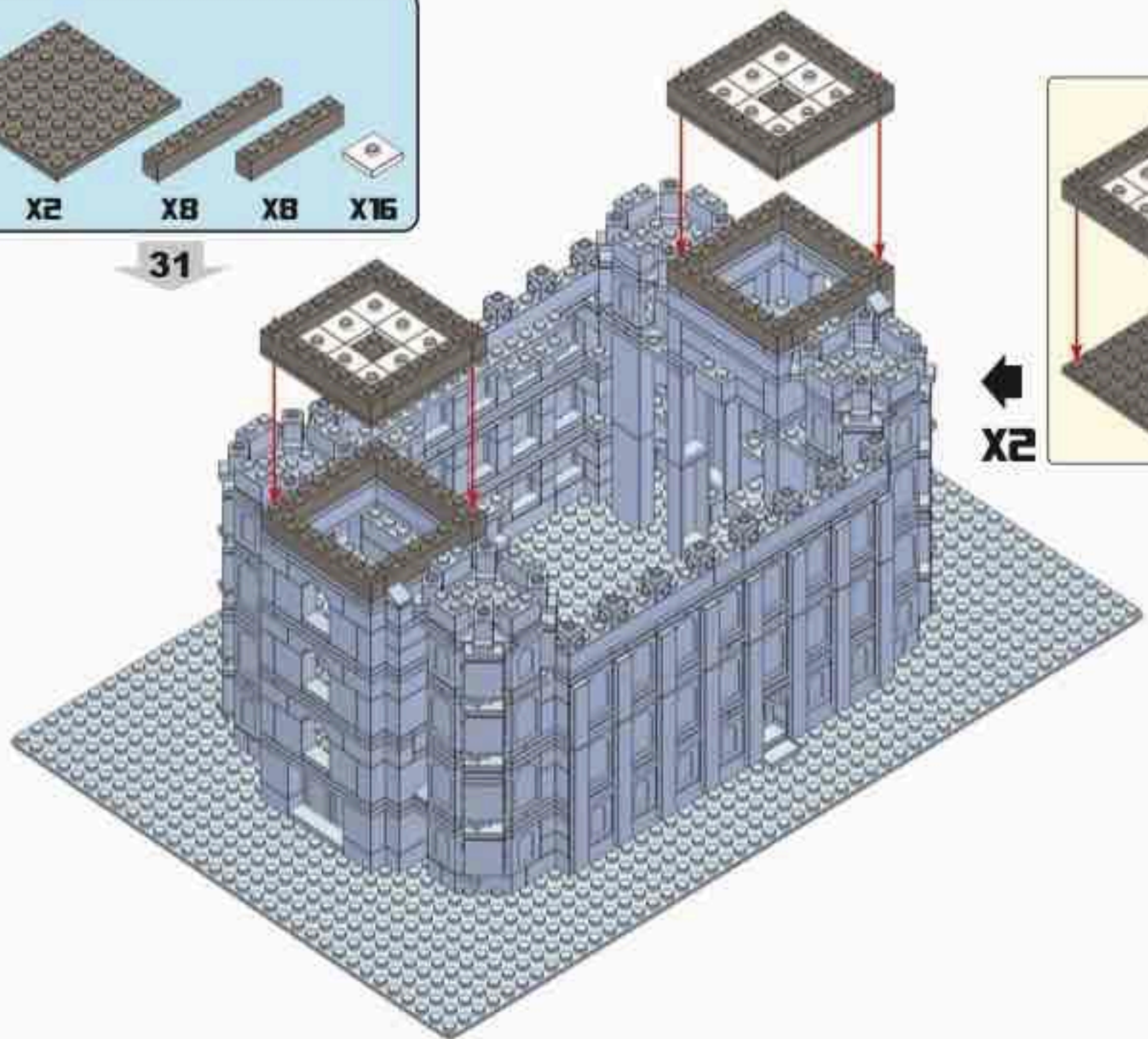

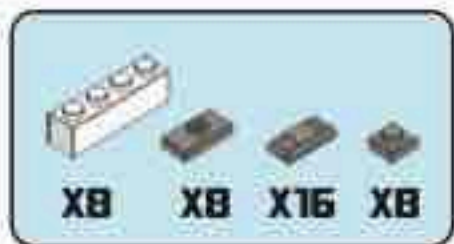

32

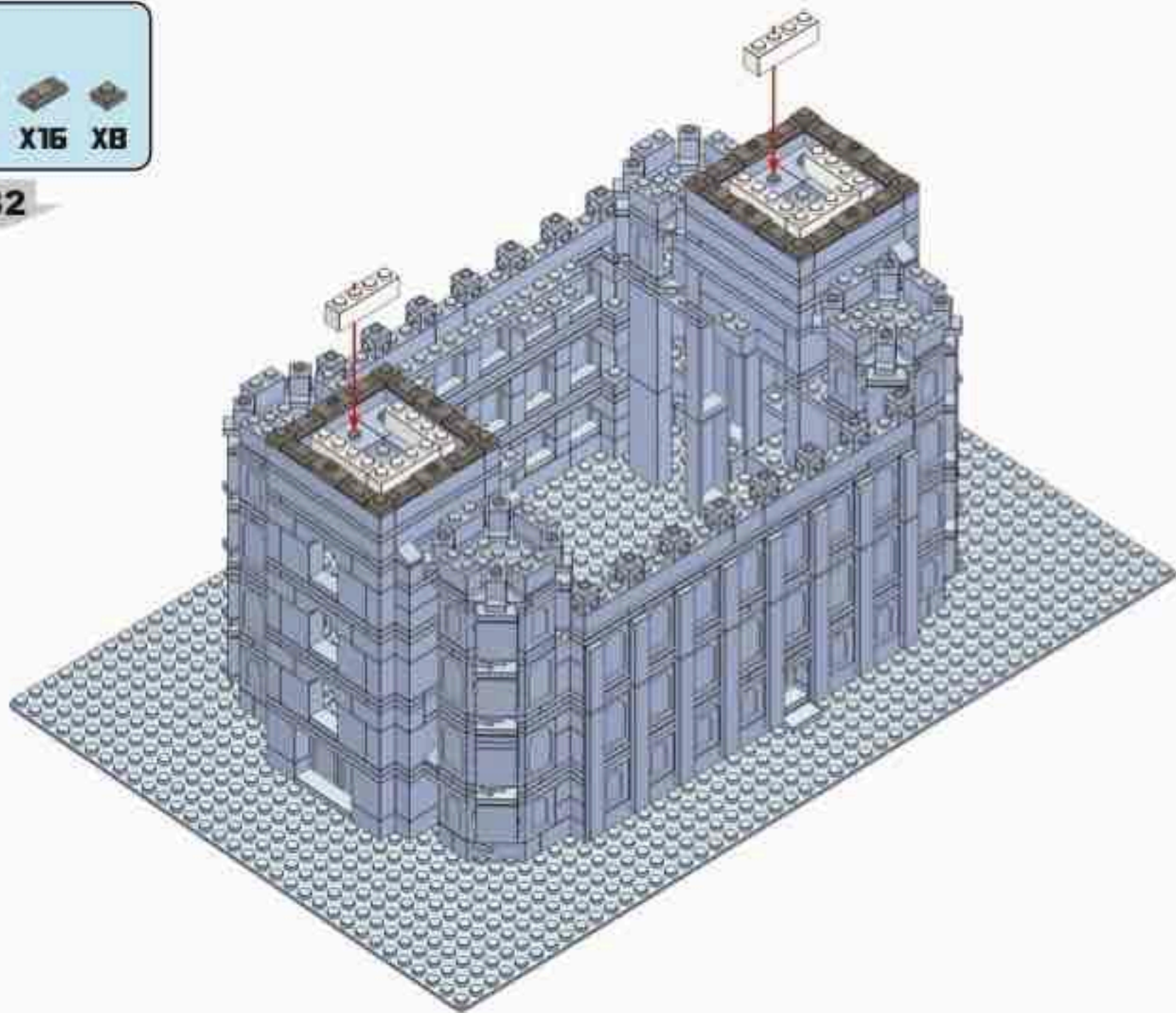



33

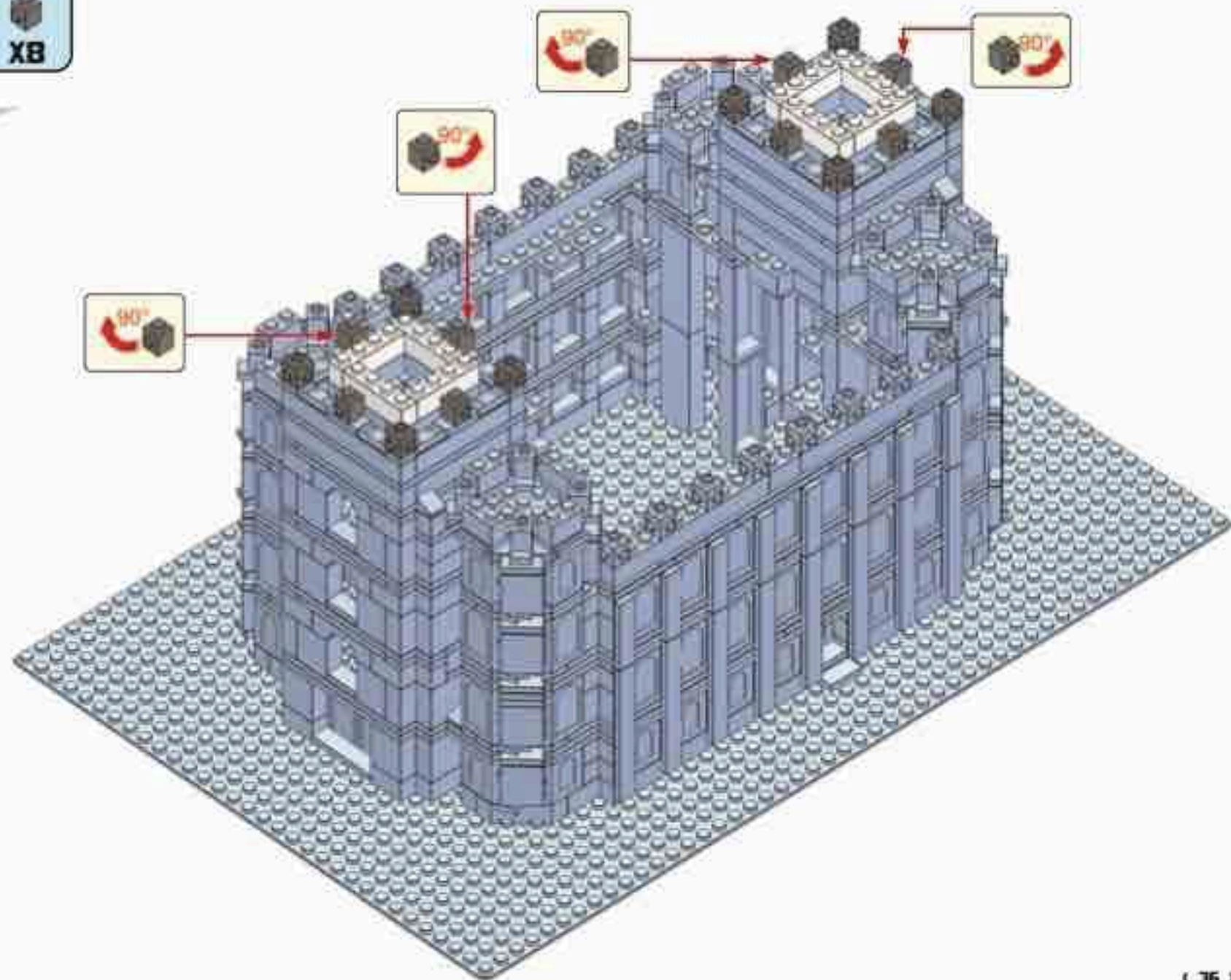

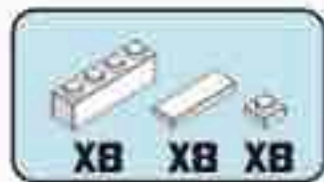

34

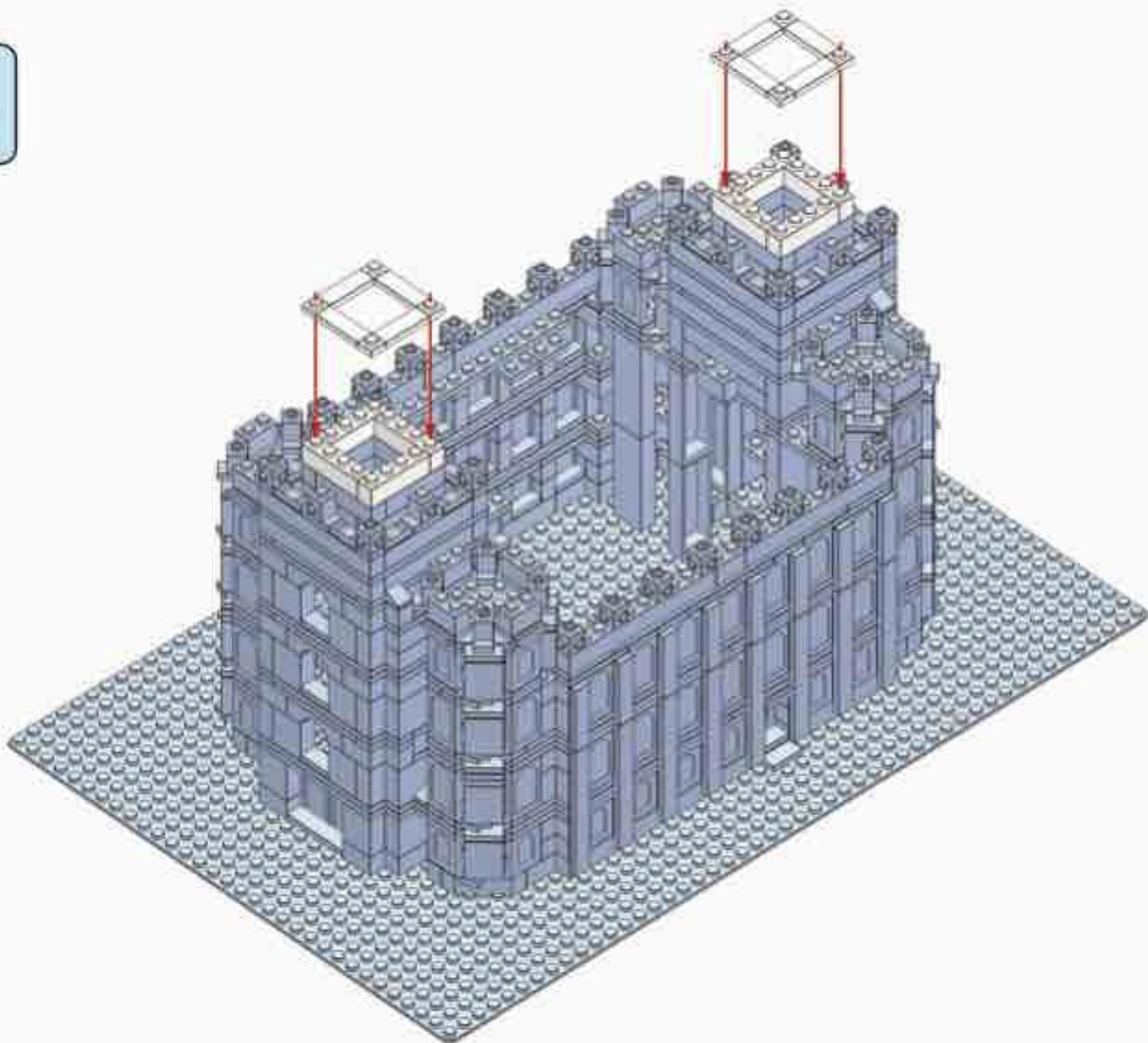

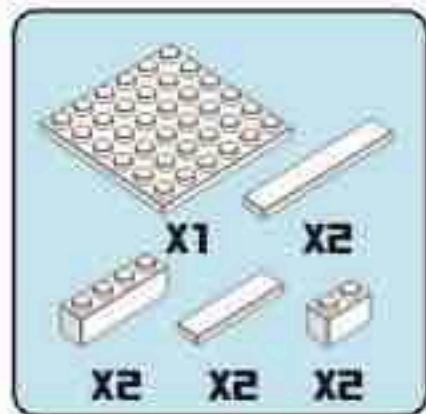

35

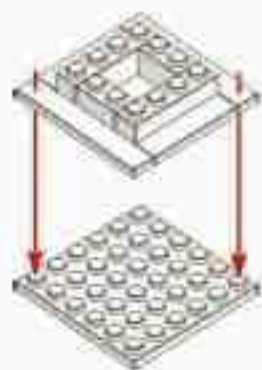

36

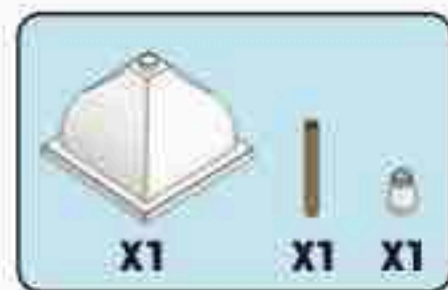
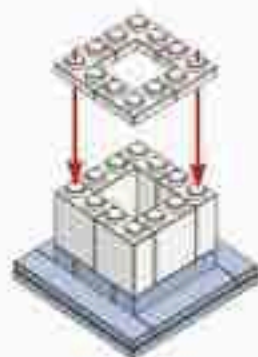

37

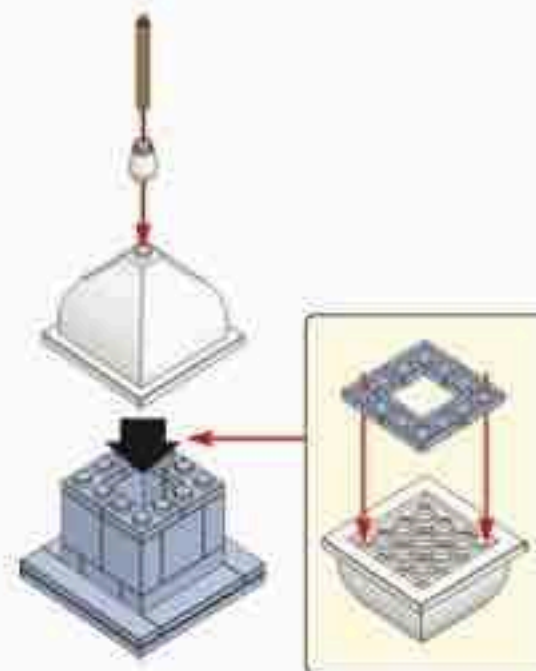

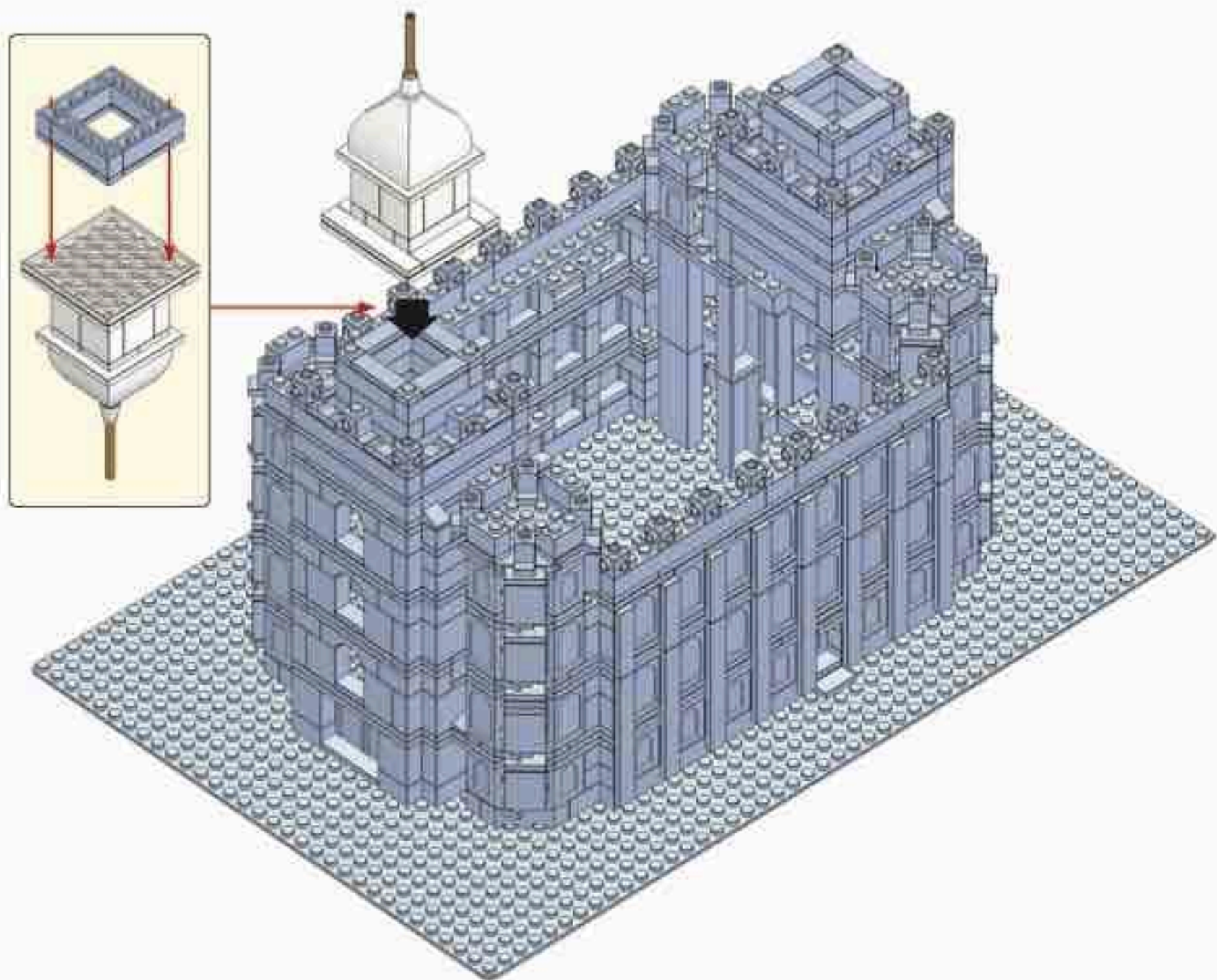

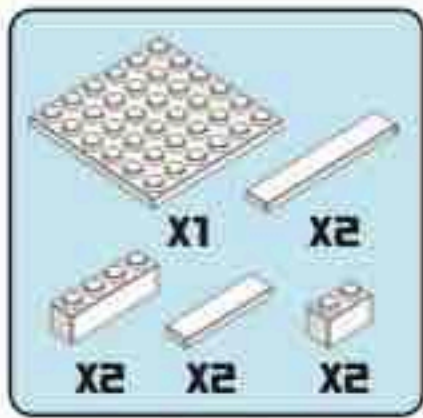

39

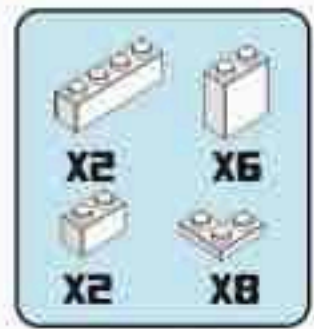
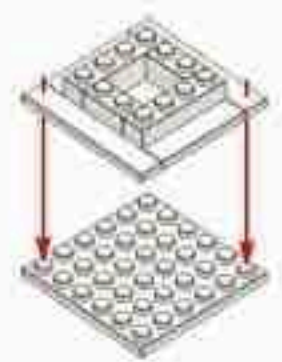

40

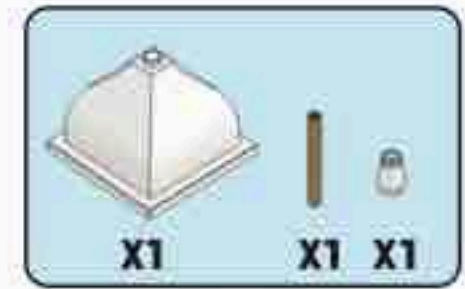
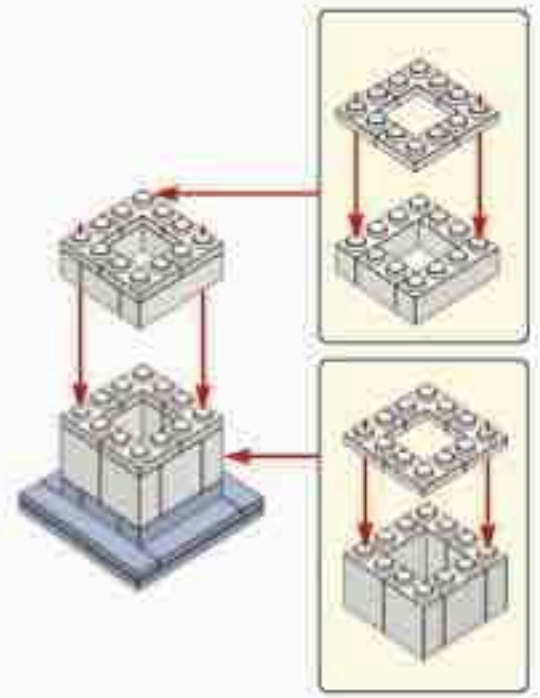

41

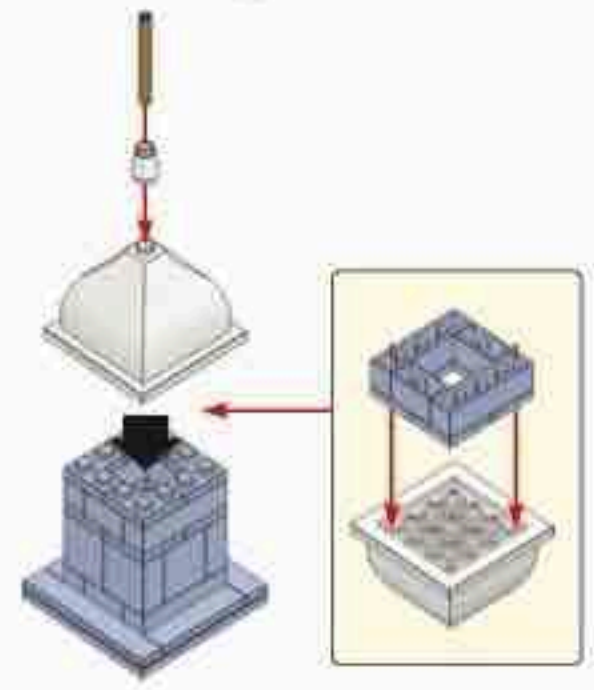

42

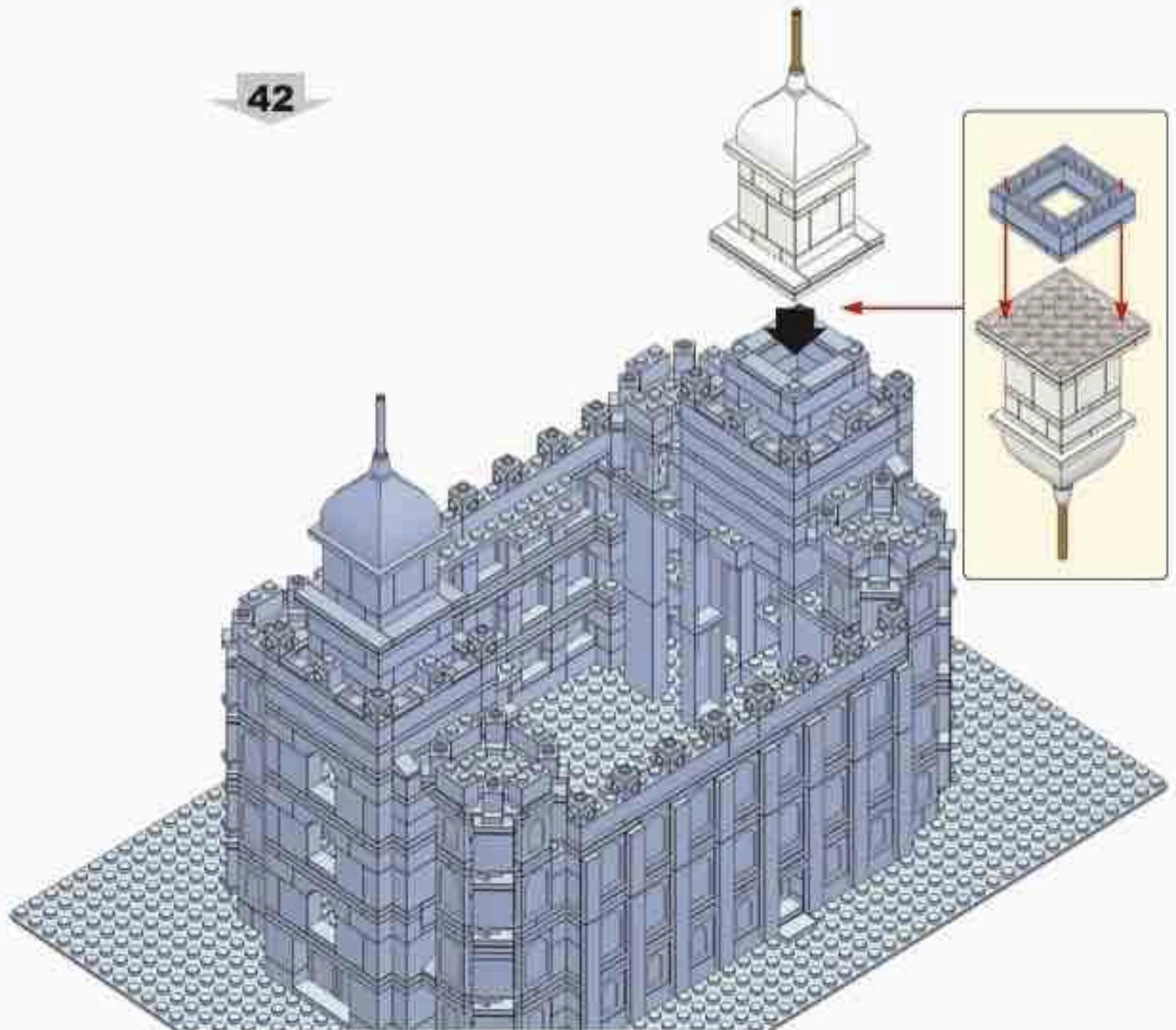

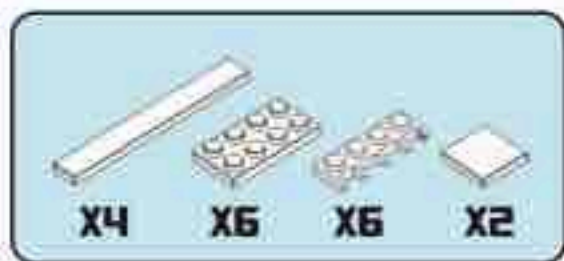

43

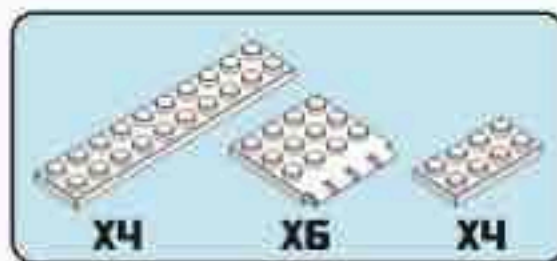

44

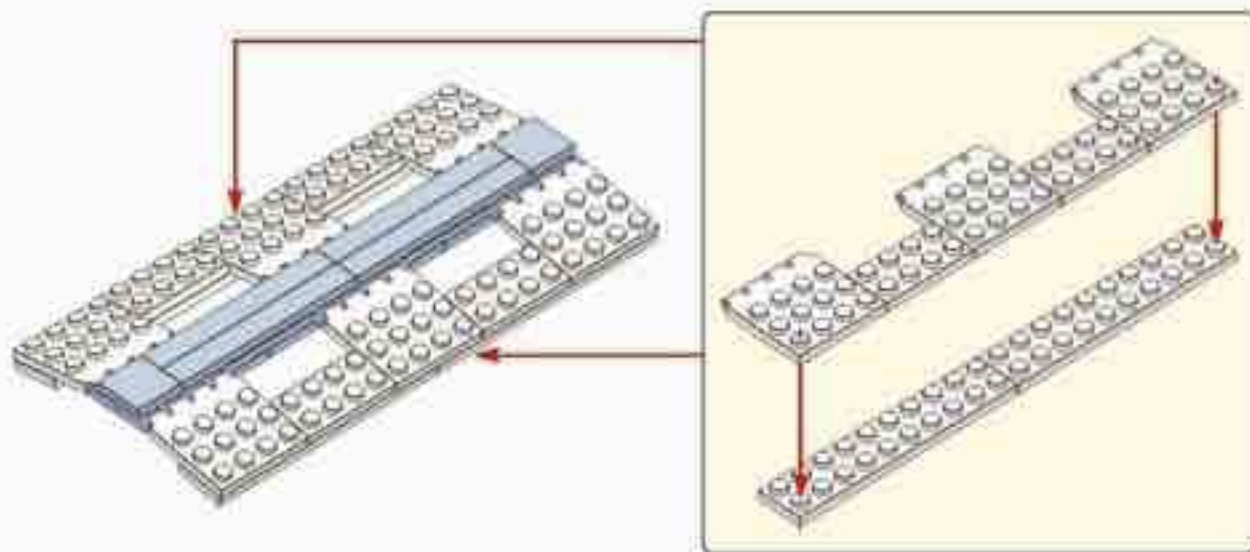
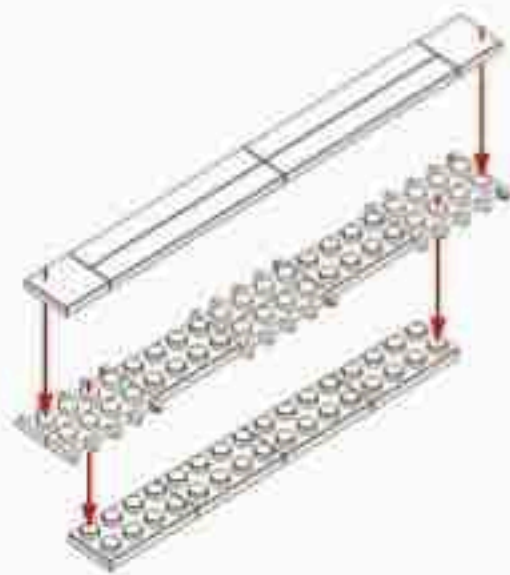



45

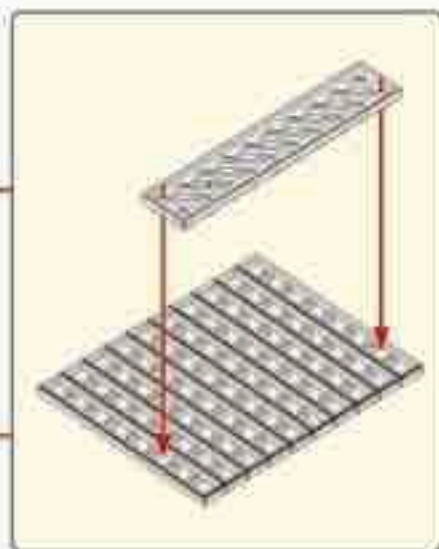
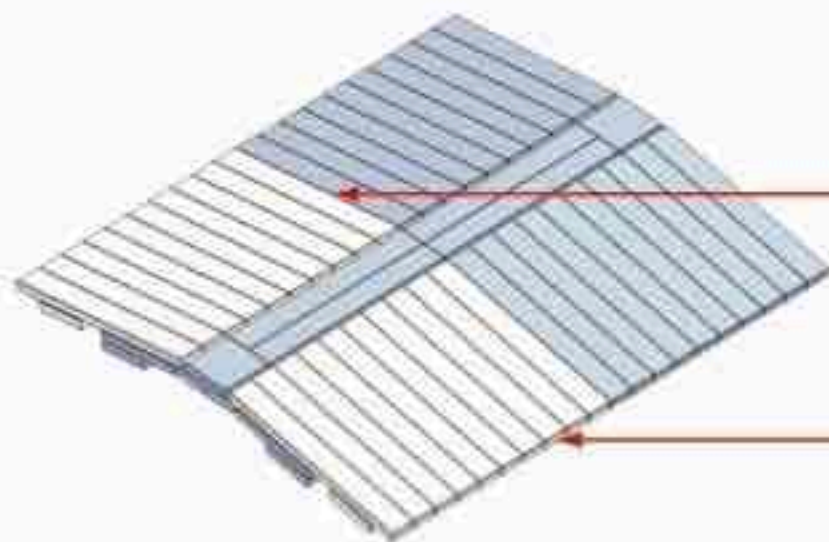
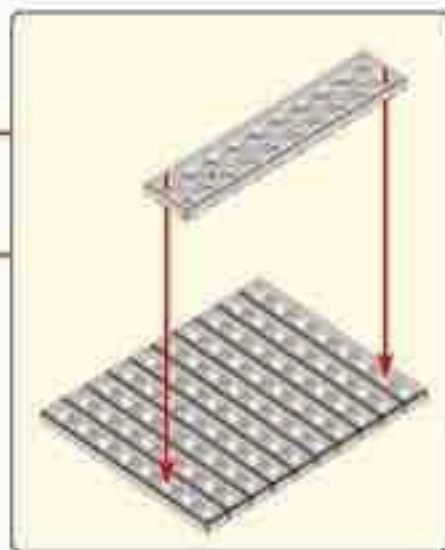
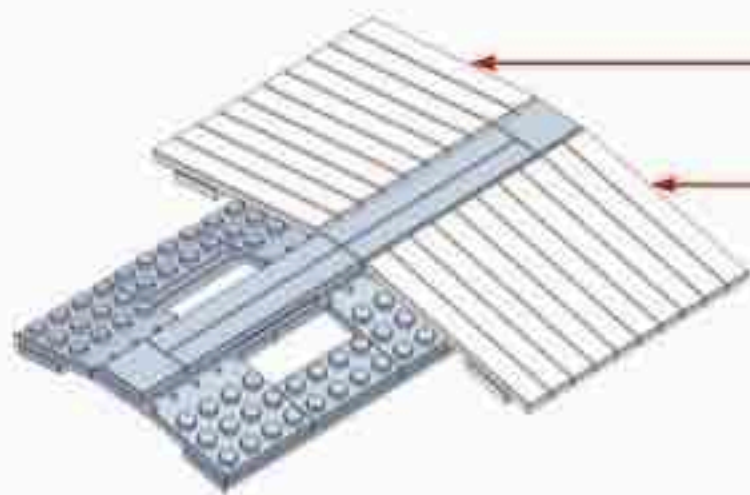

46

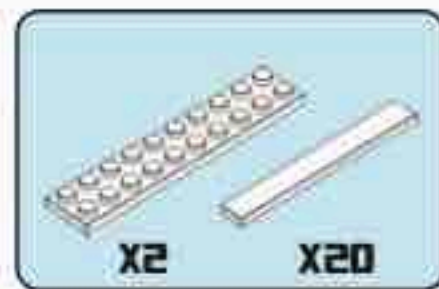

47

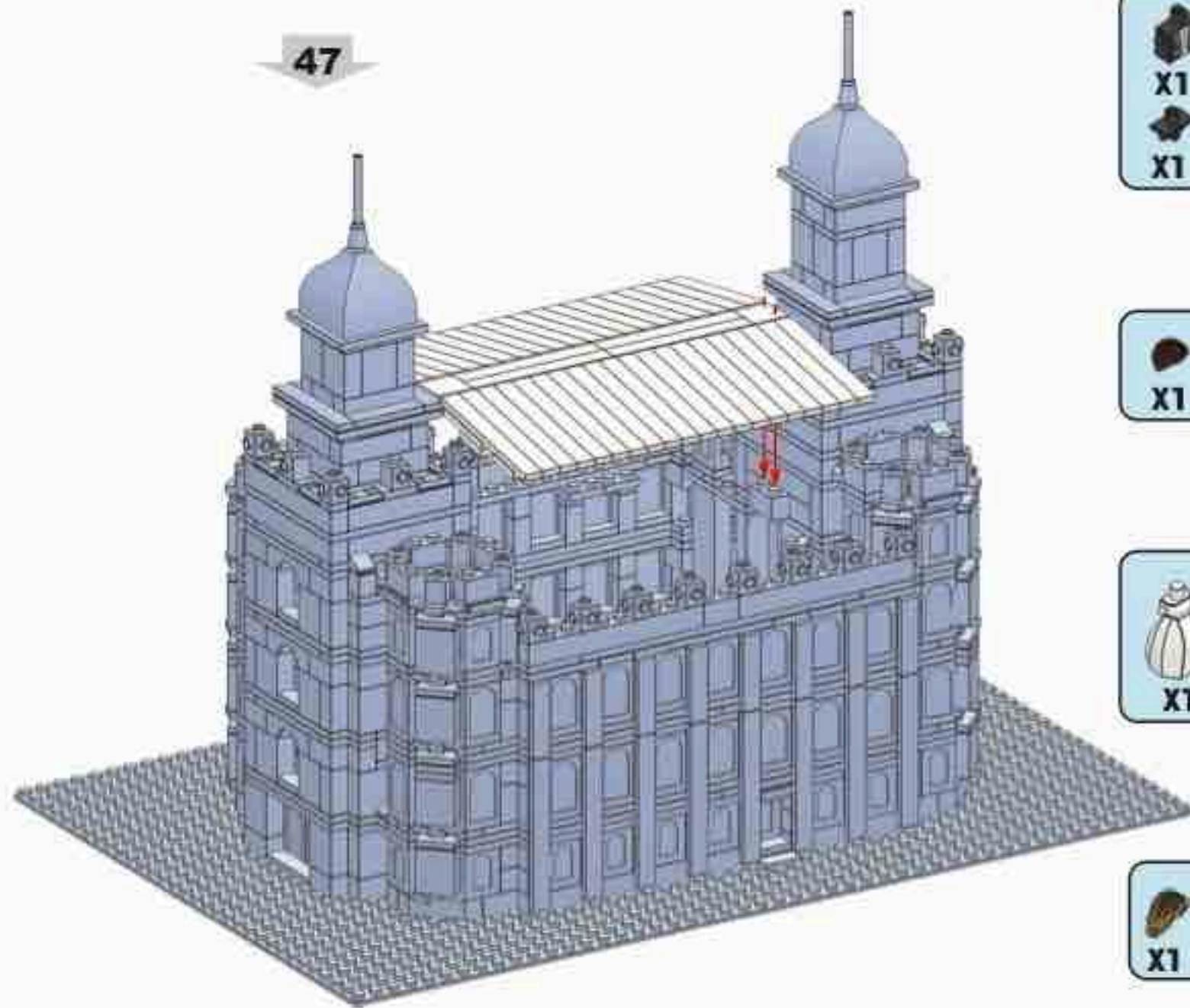

48



49



50



51



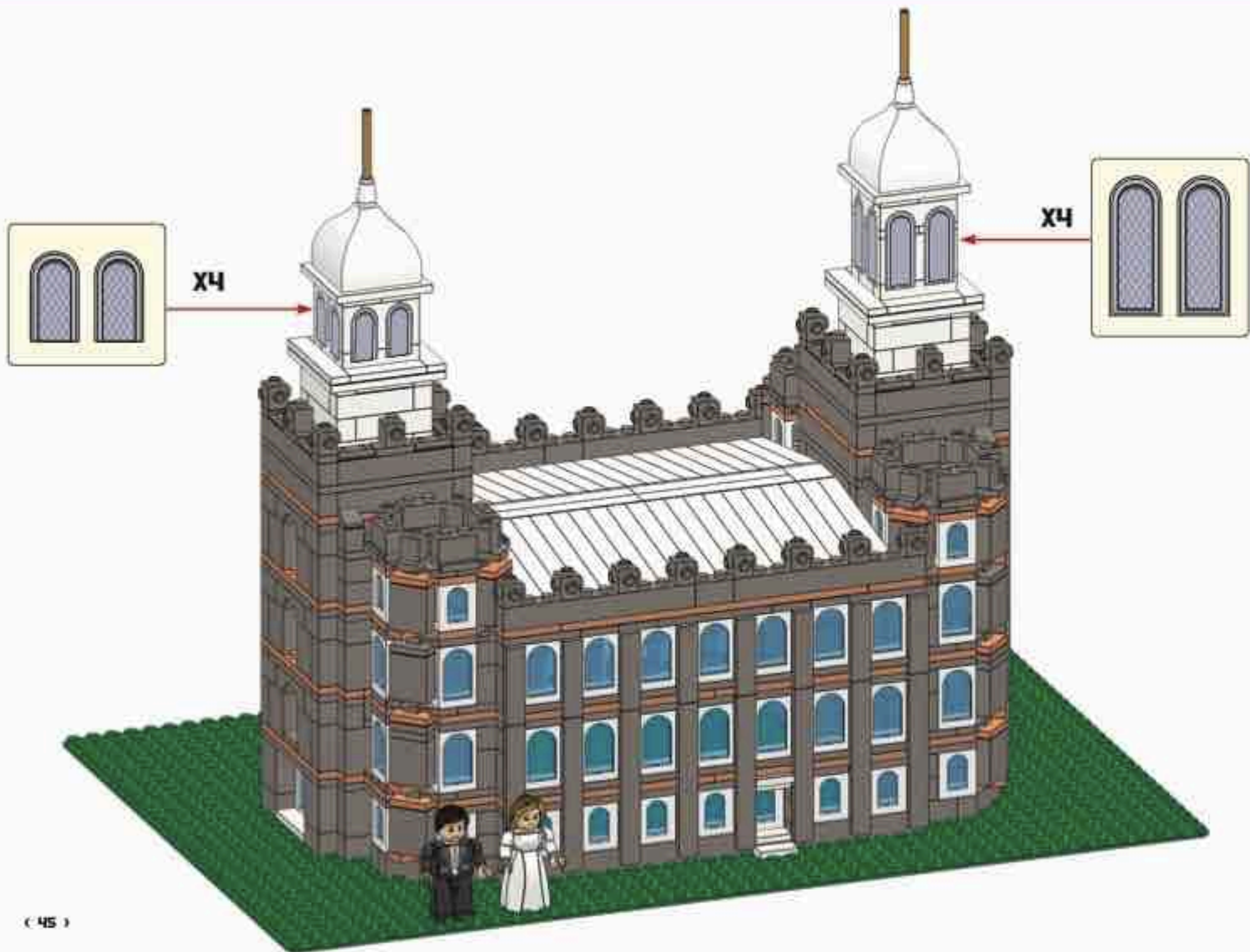

Send us a picture together with your completed temple set to info@brickemyoung.com and receive free Missionary figurines!



Warning! Choking hazard. Small parts.
 Achtung! Erstickungsgefahr. Enthält Kleinteile.
 Attention! Risque d'étouffement. Petites pièces.
 Avvertenza! Pericolo di soffocamento. Contiene parti piccole.
 Waarschuwing! Verstikkingsgevaar. Kleine deeltjes.
 Advertencia! Riesgo de asfixia. Piezas pequeñas.
 Advarsel! Kvælningsfare. Små dele.
 Varoitus! Tukehtumisvaara. Pieniä osia.
 Varning! Kvävningsrisk. Innehåller smådelar.
 Atenção! Perigo de asfixia. Peças pequenas.
 Προειδοποίηση! Κίνδυνος πνιγμού. Μικρά κομμάκια.
 警告! 窒息的危险性。小さな部品が入っていますので、ご注意ください。
 警告! 小心窒息。当心小物件。
 경고! 질식 위험. 작은 부품 포함.
 Внимание! Риск удушья. Содержит мелкие детали.

Ostrzeżenie! Zagrożenie zadławienia. Małe elementy.
 UPOZORNĚNÍ! Nebezpečí udusení. Obsahuje malé součástky.
 UPOZORNENIE! Nebezpečenstvo udusenja. Obsahuje malé súčasti.
 Figyelmeztetés! Fulladásveszély! Kis elemeket tartalmaz.
 Обережно! Ризик задужи. Митить дробн деталі.
 UPOZORNĚNÍ! Opasnost od dušení. Malé díly.
 УПОЗОРЕЊЕ! Опасност од гушења. Мале делови.
 OROZORLO! Nevartogat zadušiliva. Majhni delčki.
 Avertamen! Pericol de sufocare. Piese mici.
 Внимание! Опасност от задравене. Малки части.
 Brīdinājums! Pastāv nosmakāšanas risks. Satur sīkas daļiņas.
 Hojatus! Lämbumisohc. Sisaldab väikeid osi.
 Įspėjimas! Uždusimo pavojus! Komplekte yra mažų detalių.
 Dikkat! Boğulma tehlikesi. Küçük parçalar.

All copyrights, trademarks, intellectual property and other information contained belong to Brick'em Young.
 No unauthorized usage or distribution of this material (including instruction booklet)
 without the expressed written consent of Brick'em Young.
 Brick'em Young is not owned or affiliated with The Church of Jesus Christ of Latter-day Saints.
 Further questions can be directed to: service@brickemyoung.com.
 This brick set contains many small bricks, Parental involvement is recommended!

www.brickemyoung.com

Product # 89:18



MADE IN CHINA