

BrickEm

Young™

Cardston Temple

1239 Pieces

Product# 3:16

Ages 12+

www.brickemyoung.com

**standard size bricks
Toy Brick Building Set**



Top Ten Facts about the Cardston Alberta Canada Temple

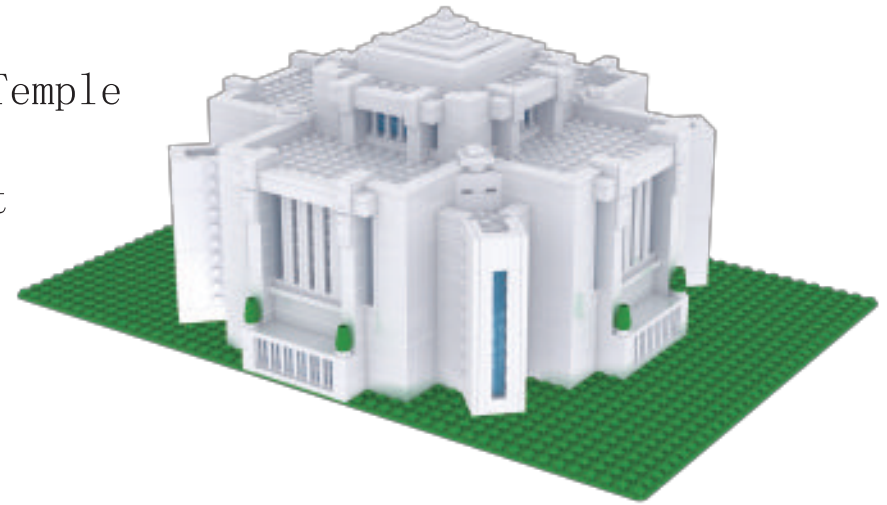

1. The Cardston Temple was the first temple built outside of the United States. This also makes it the first temple built in Canada. Cardston is located 15 miles (24KM) north of the U.S. border.
2. The Cardston Temple was originally named the Alberta Temple.
3. Similar to many of the other historical temples such as Logan, Manti, & St George; the Cardston Temple does not have an Angel Moroni.
4. The Cardston Temple was built on a hill in Cardston which is known as Temple Hill.
5. The site dedication was done by Joseph F. Smith on July 27, 1913.
6. The temple was dedicated by President Heber J. Grant on August 26, 1923.
7. Construction of the Cardston Temple lasted for 10 years making it one of the longest temples to construct. One of the primary reasons for it taking so long was due to delays related to World War I.
8. The Laie Hawaii was began construction after the Cardston Temple, but was completed prior to the Cardston Temple.
9. The exterior of the Cardston Temple consist of white/grey granite quarried from a site near Kootenai Lakes in Nelson, British Columbia.
10. On September 16, 1995, the government named the Cardston Temple a Canadian Historic Site. The commemorative plaque recognizes the temple as "the first consciously modern building in the province of Alberta."

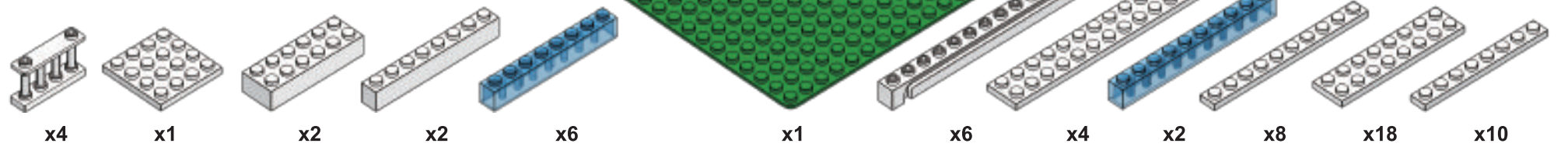
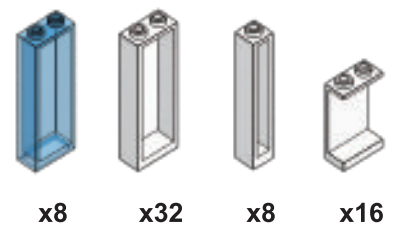
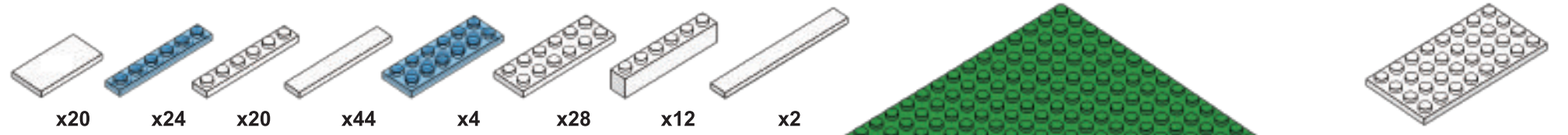
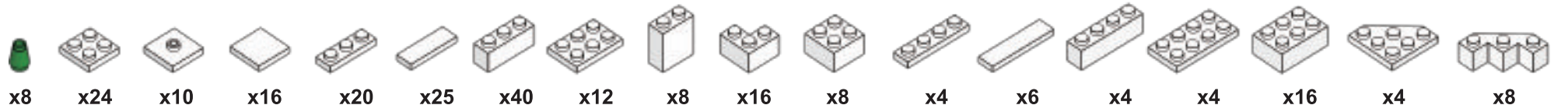

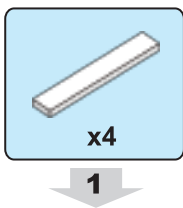

Hint #1: it took the pioneers 40 years to build the Salt Lake Temple, this model set may require several hours to build, enjoy the ride & take your time!

Hint#2: Find several bowls or other containers to divide up the pieces, this will greatly reduce the amount of time searching for different pieces later.

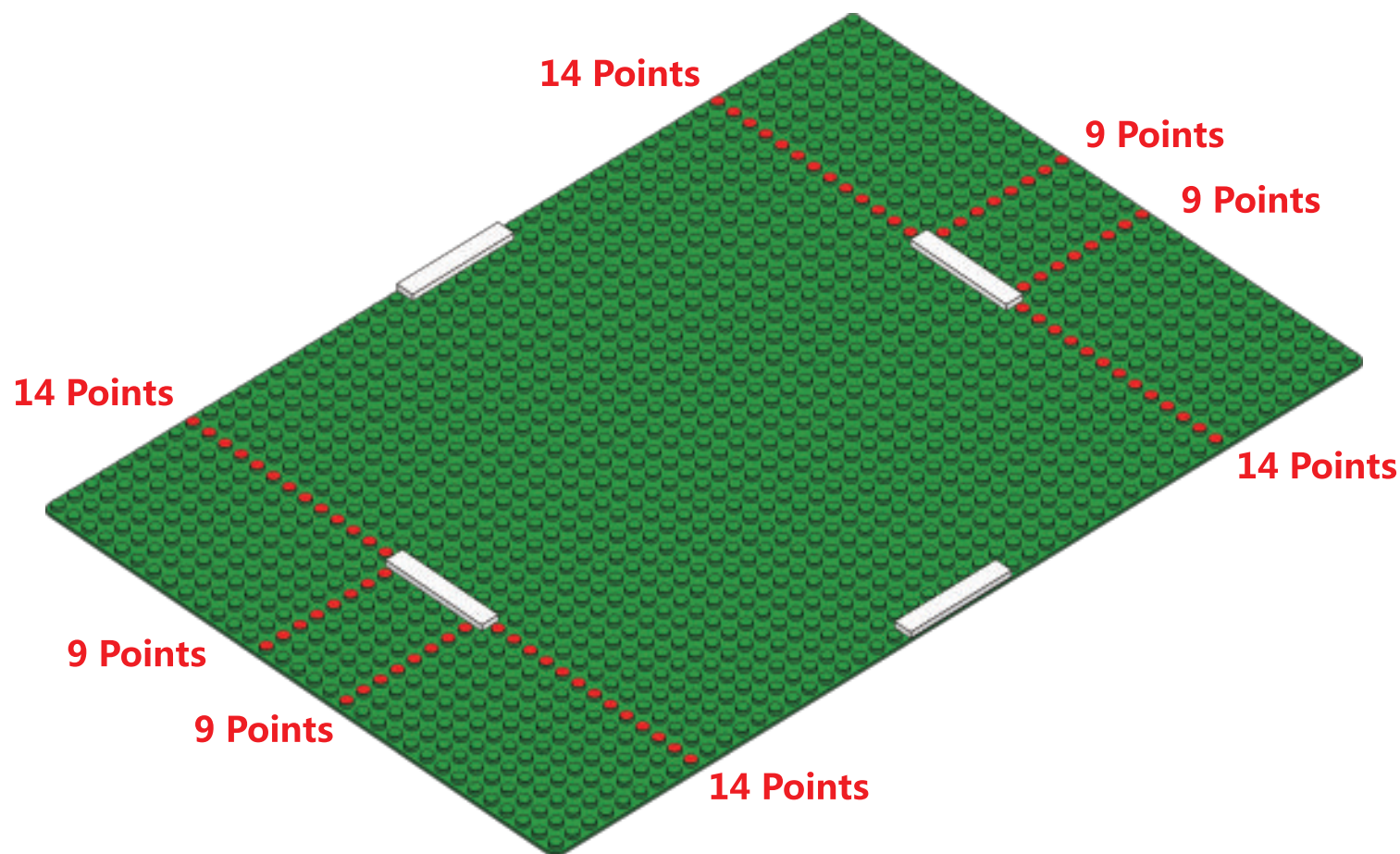

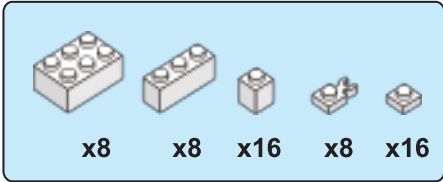

2

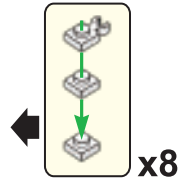
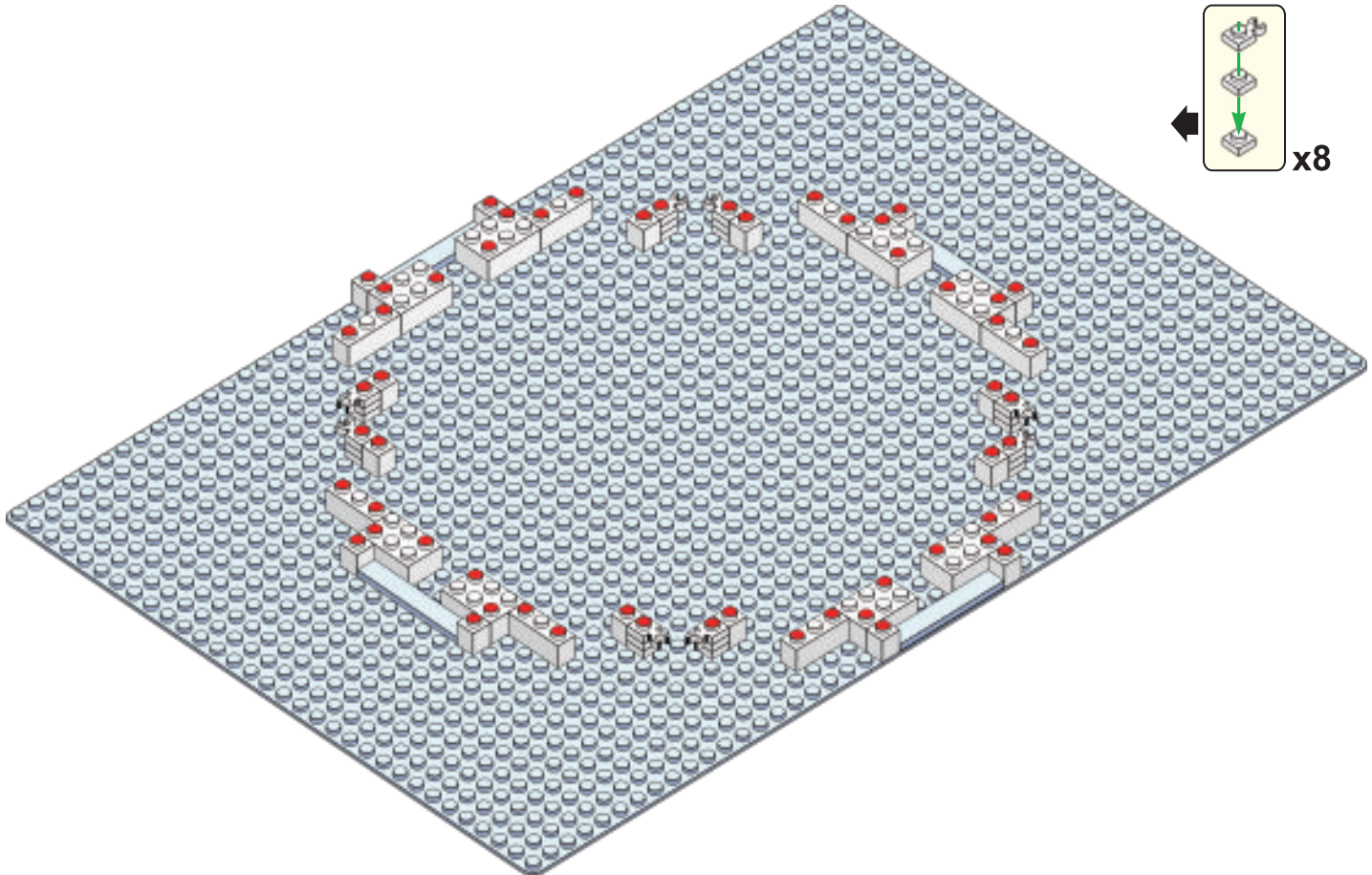

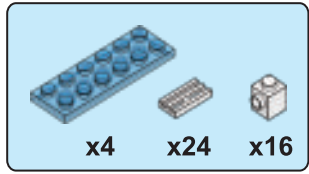

3

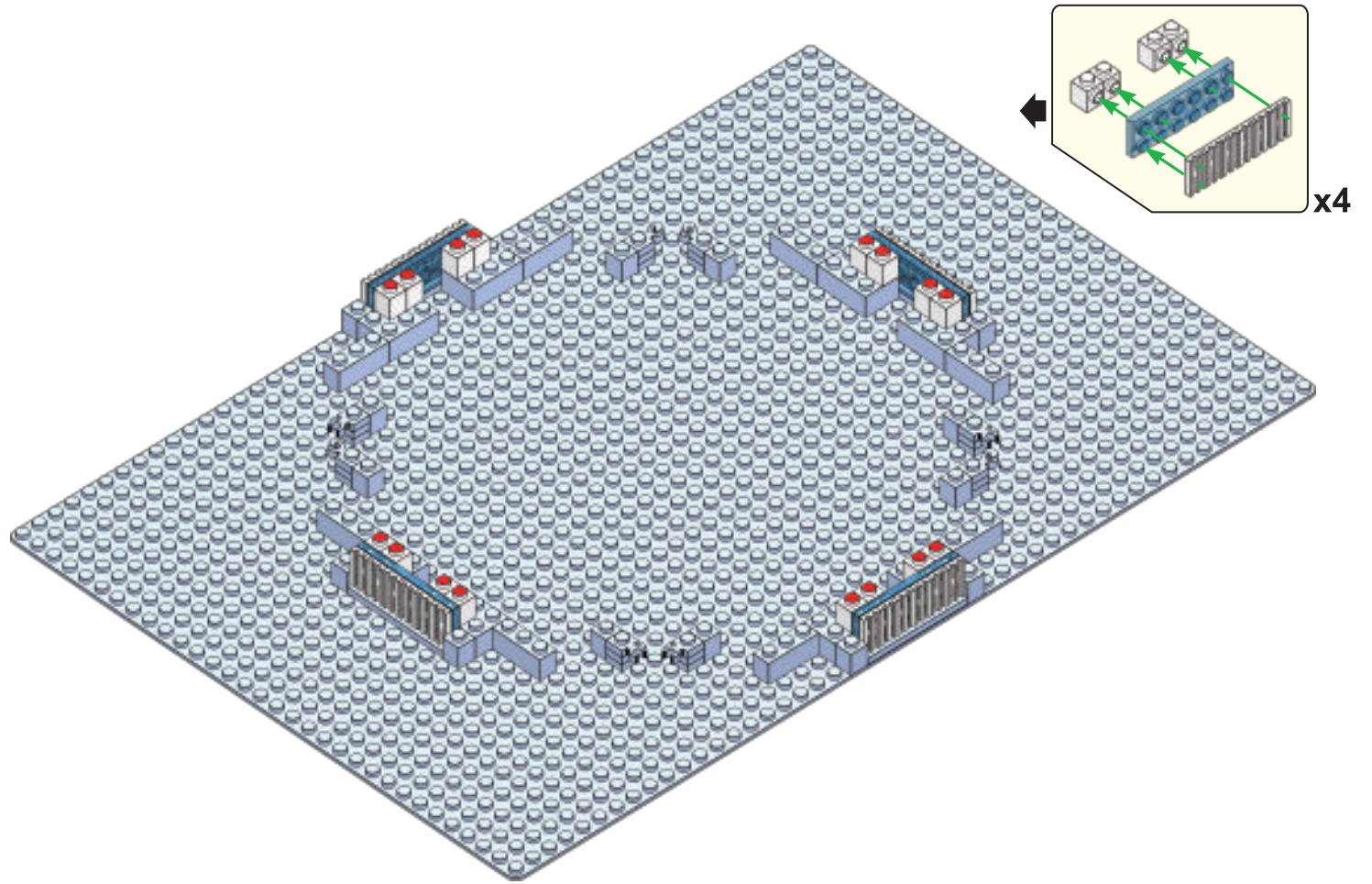

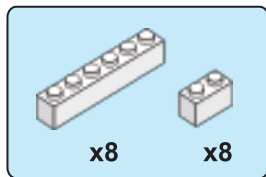

4

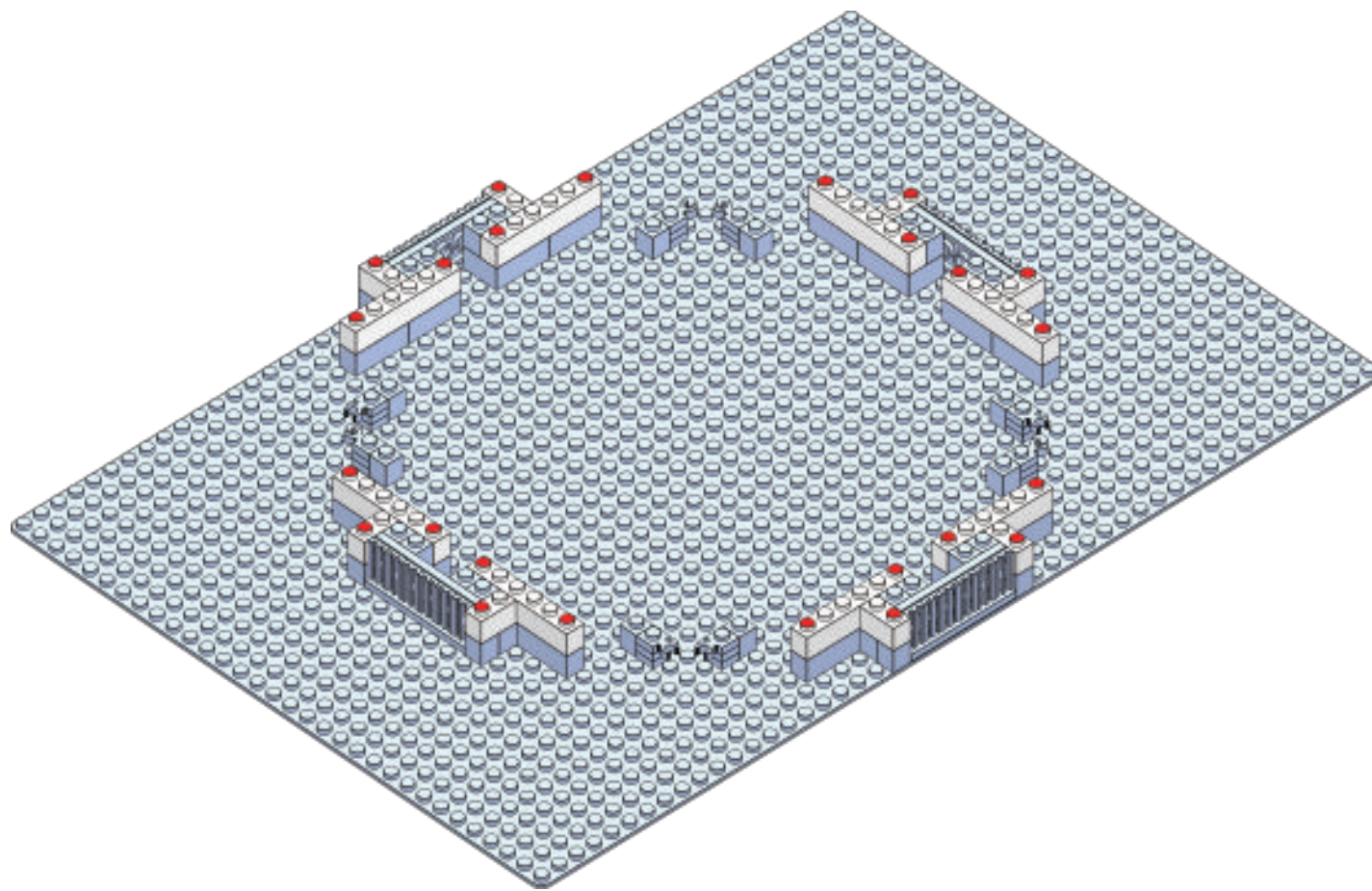

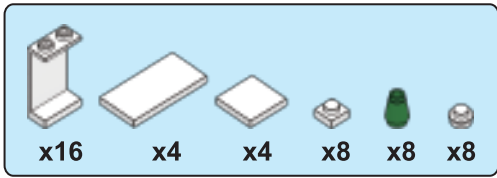

5

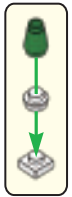
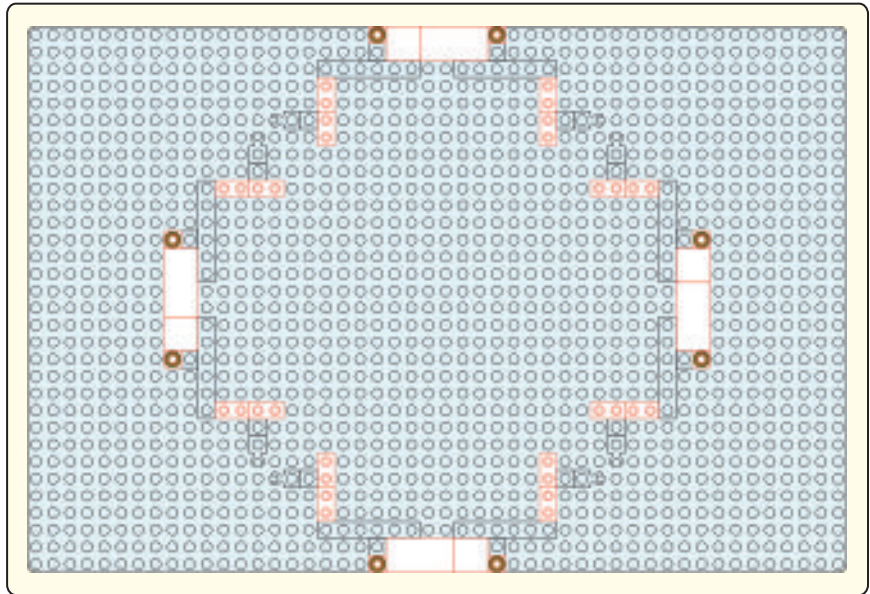

x8

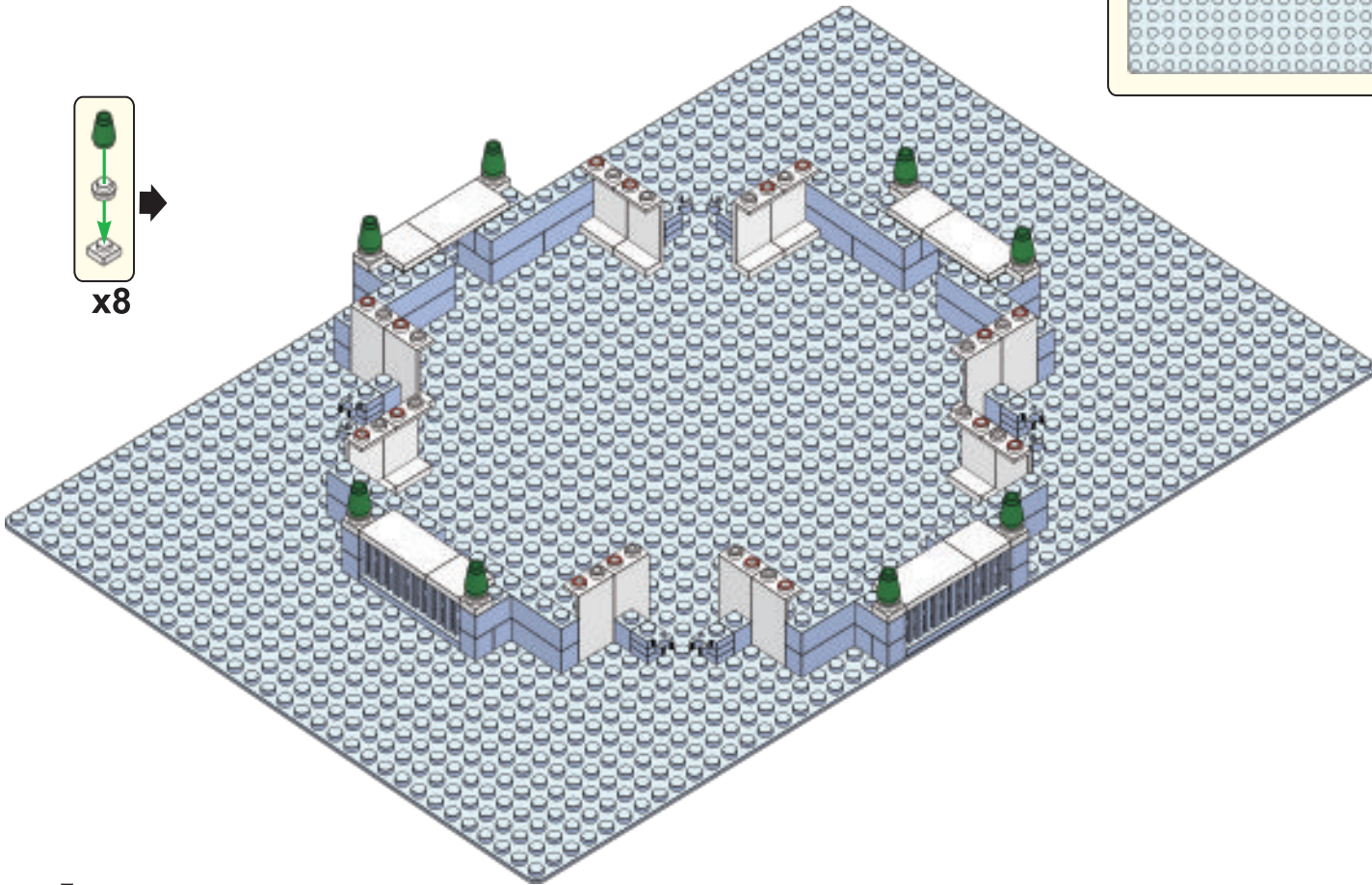

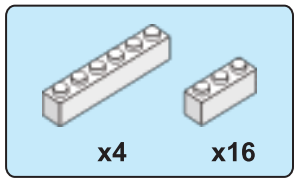

6

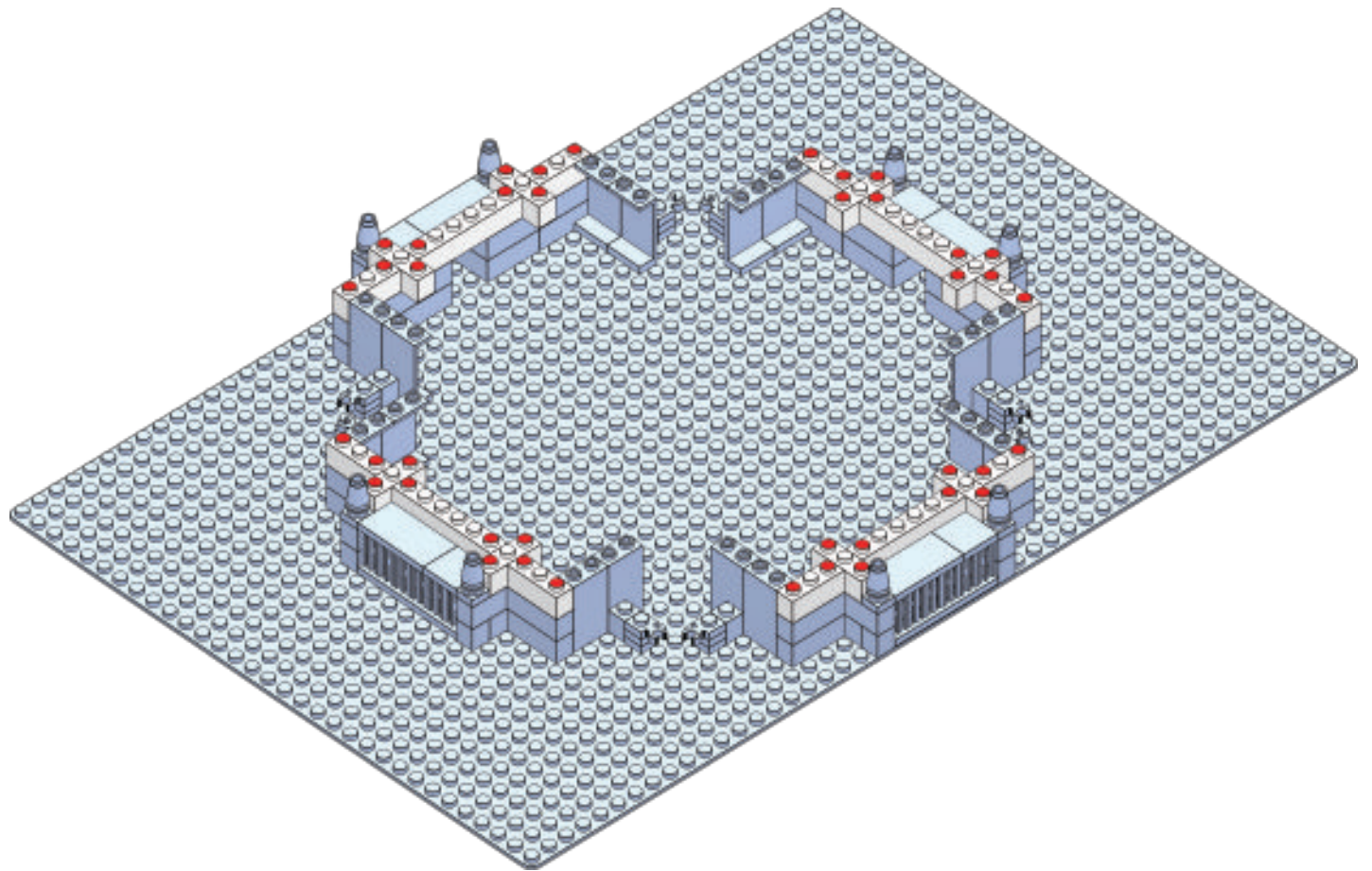

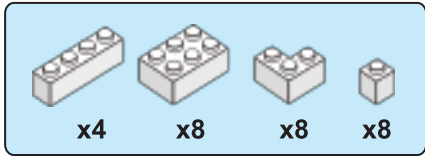

7

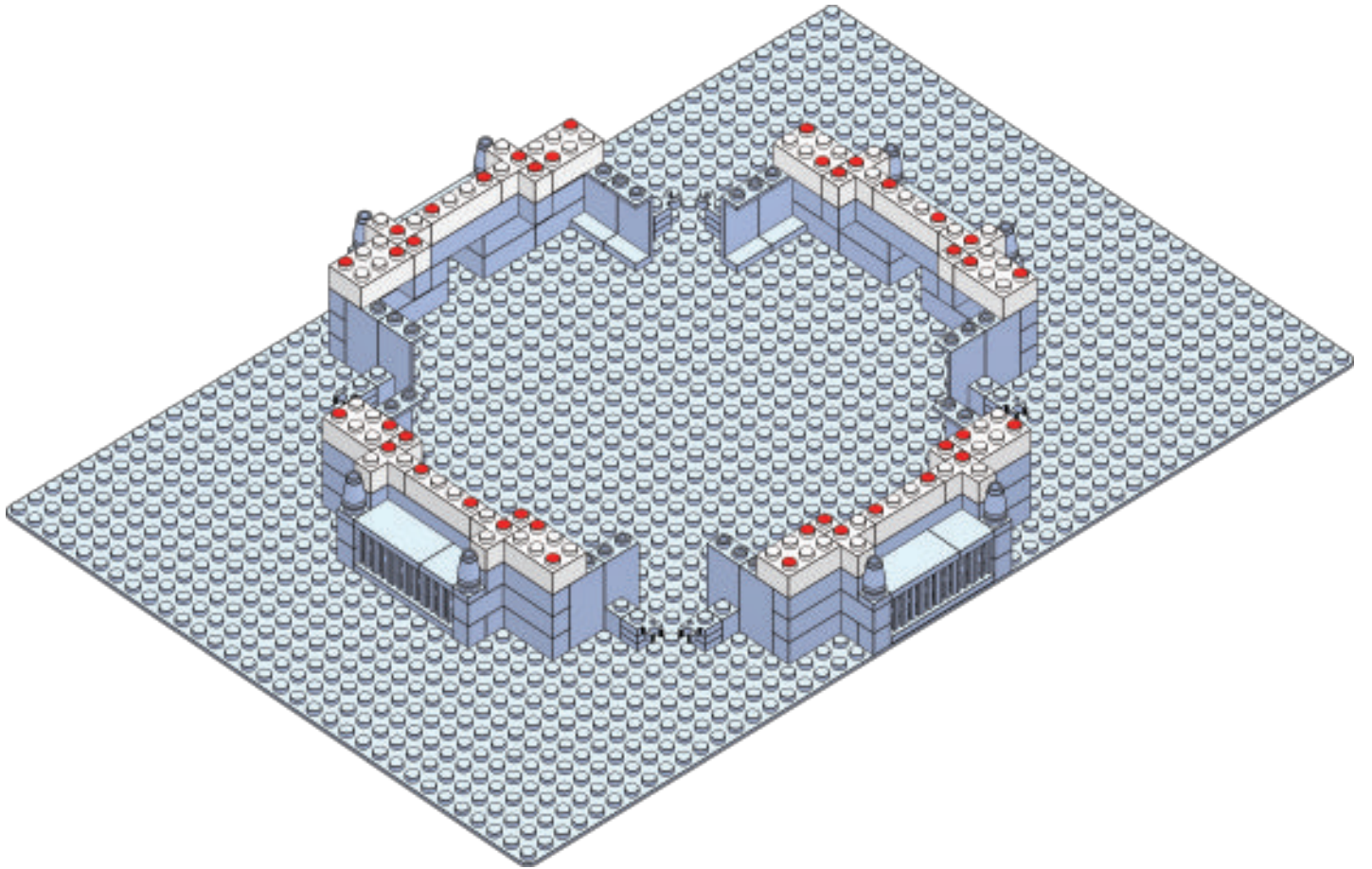

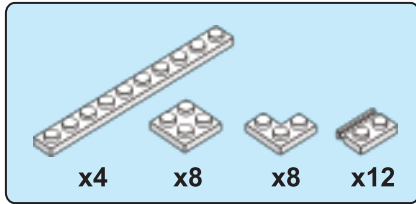

8

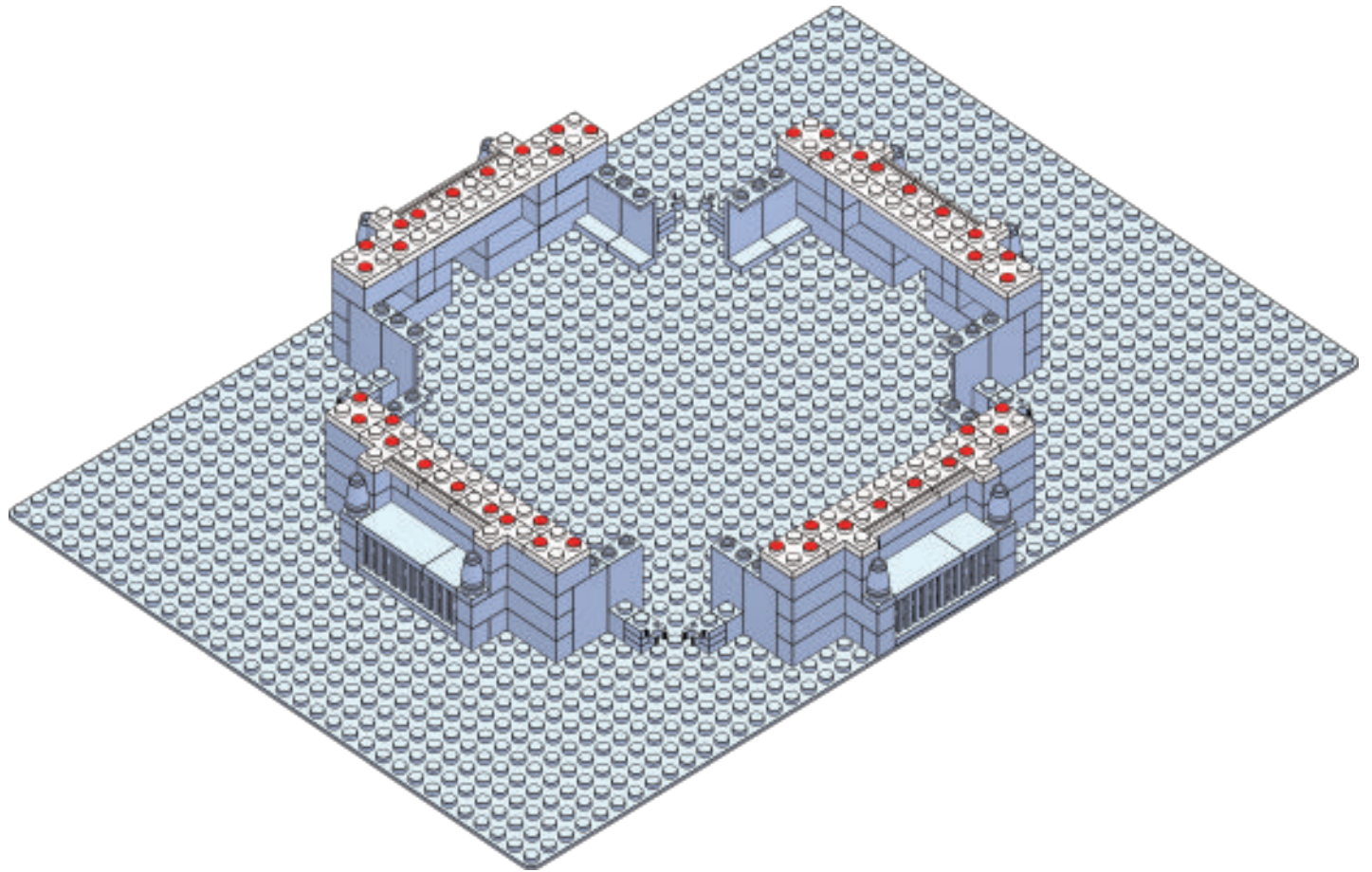

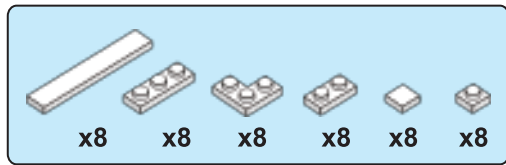

9

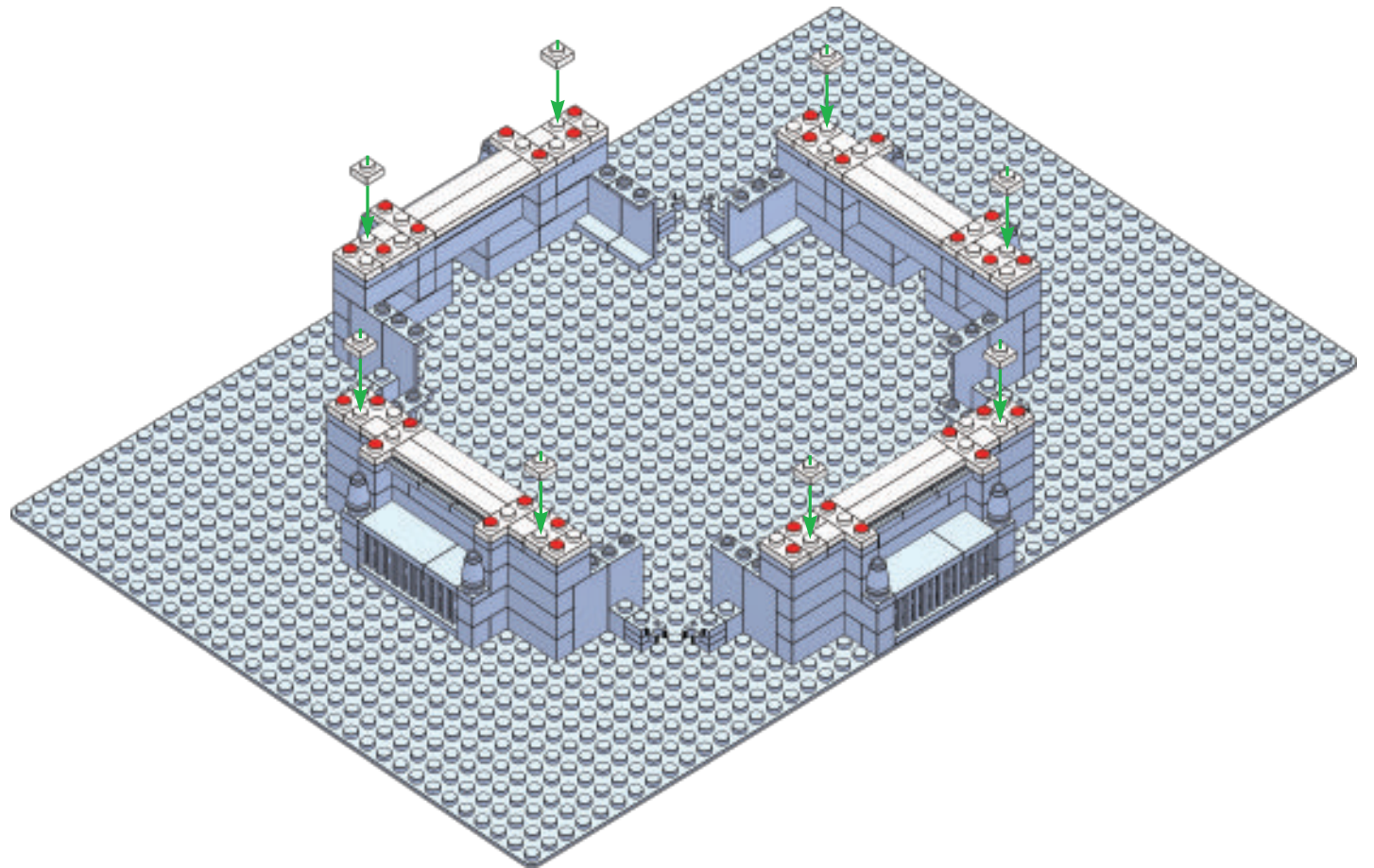

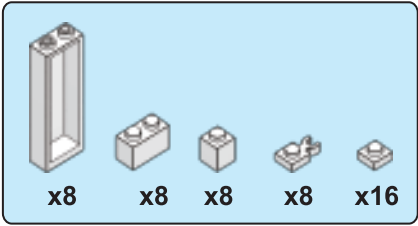

10

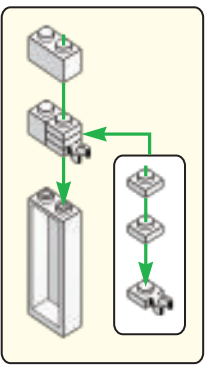
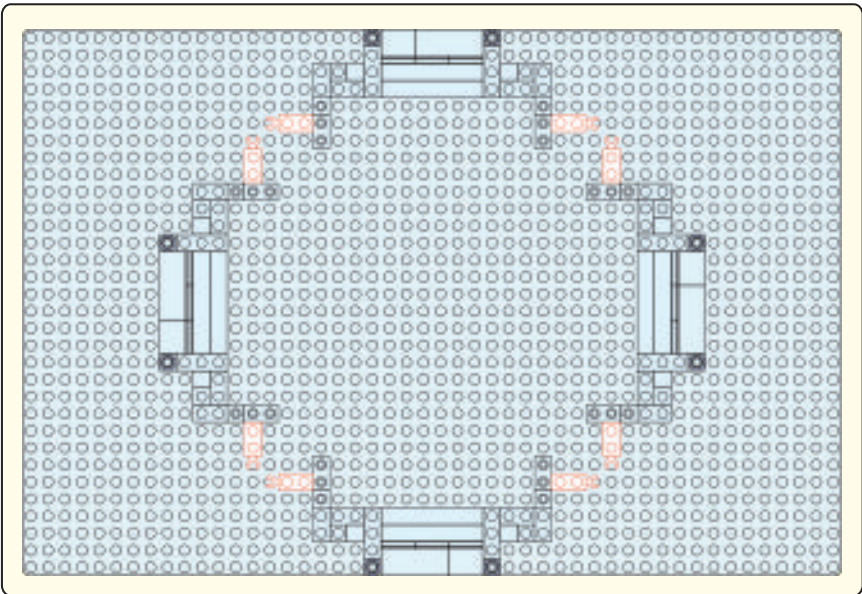

x4

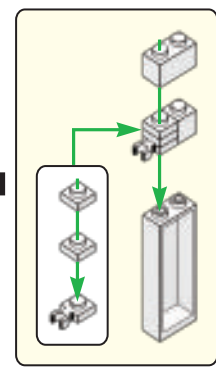
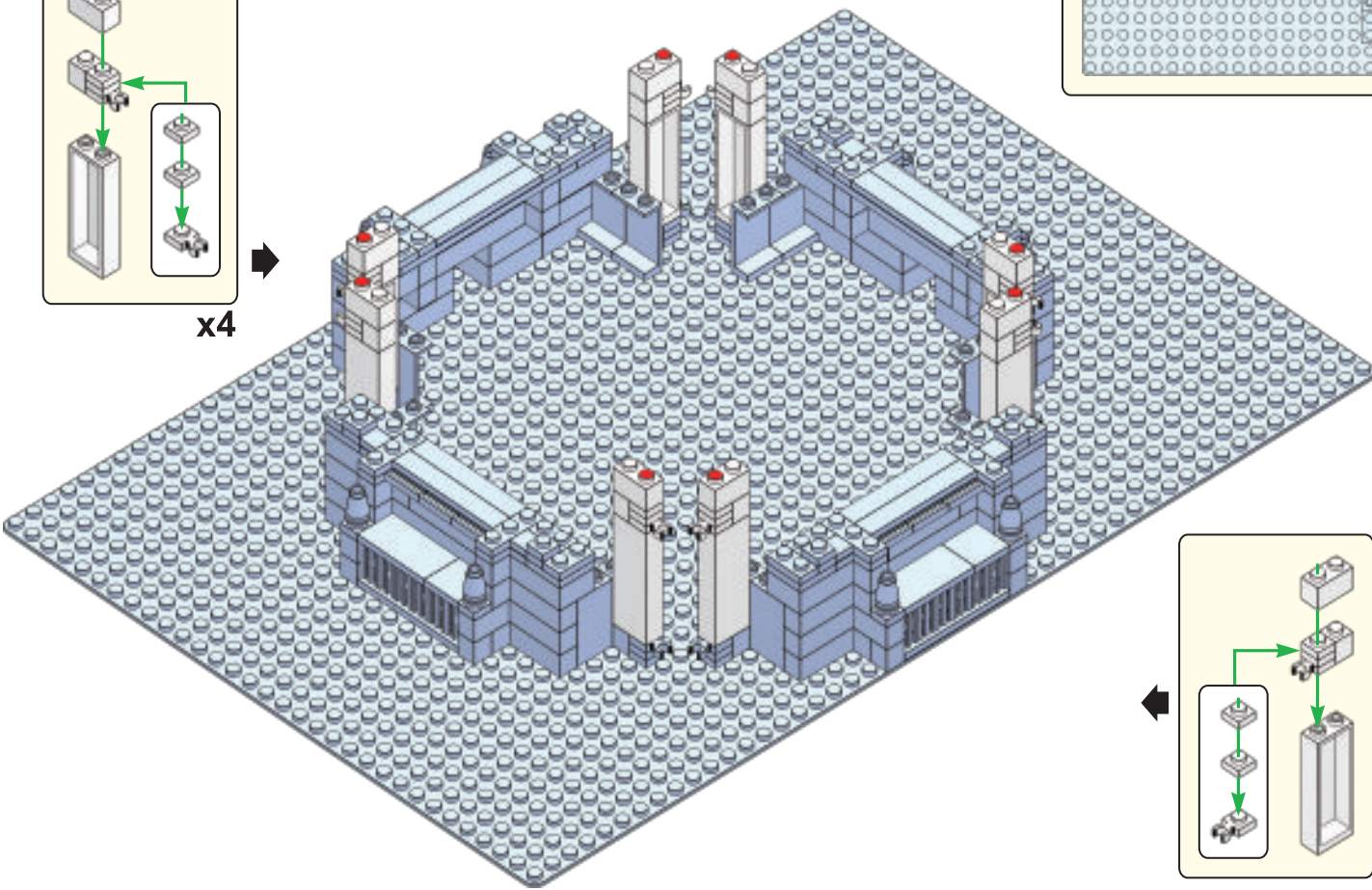

x4

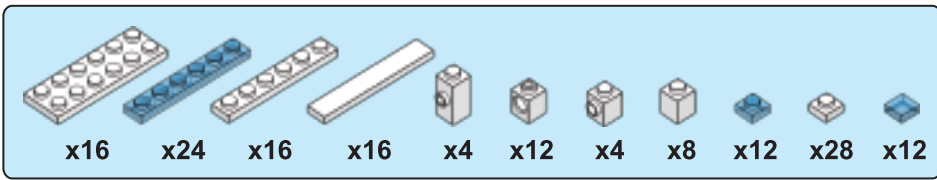

11

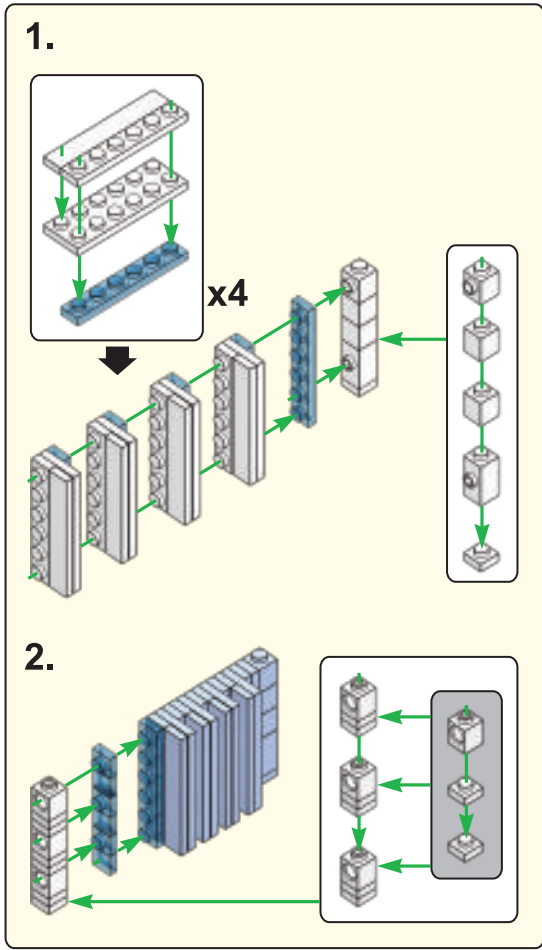

x4

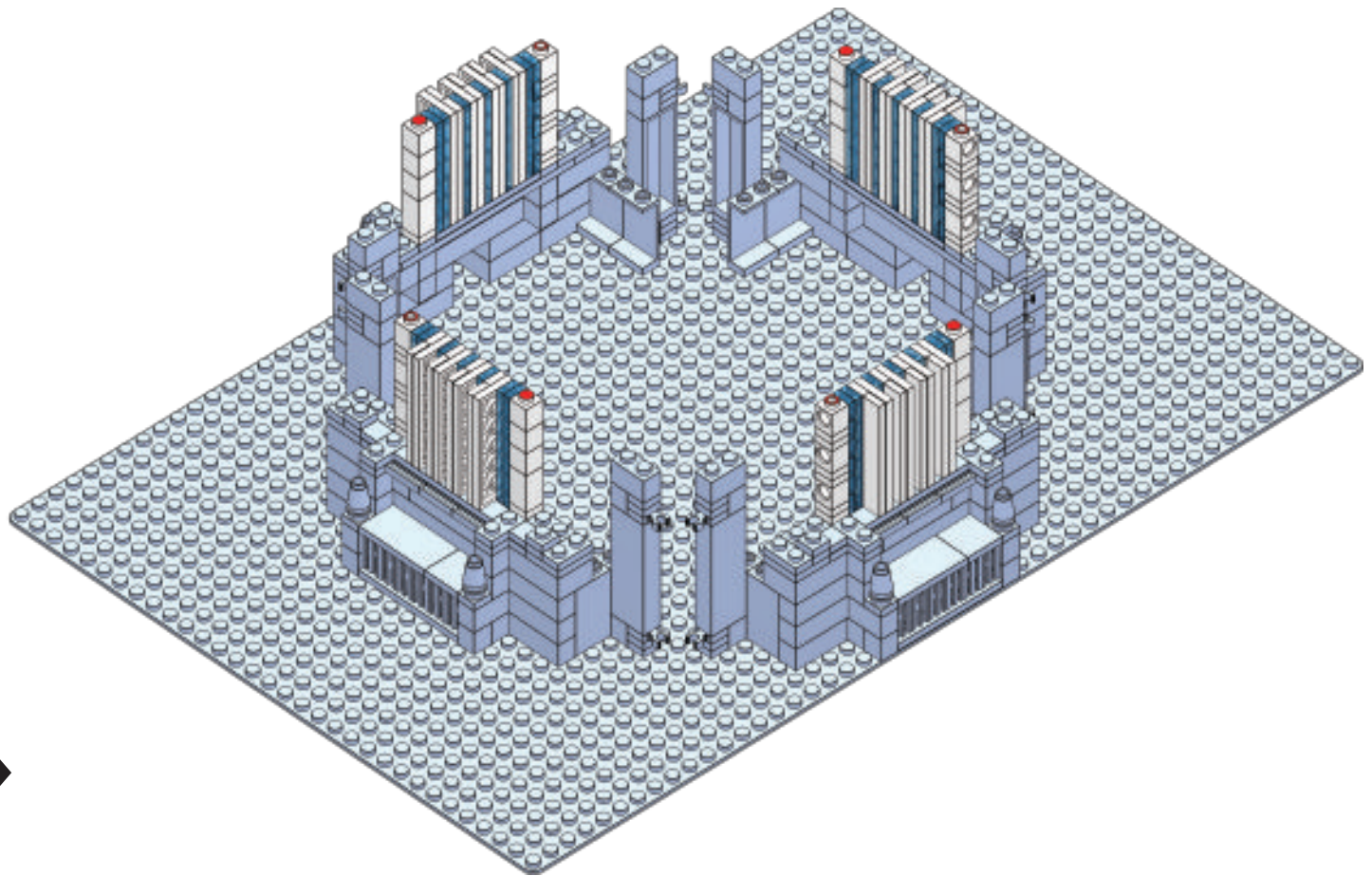

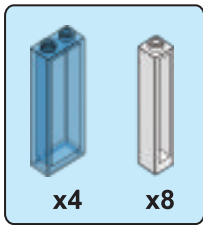

12

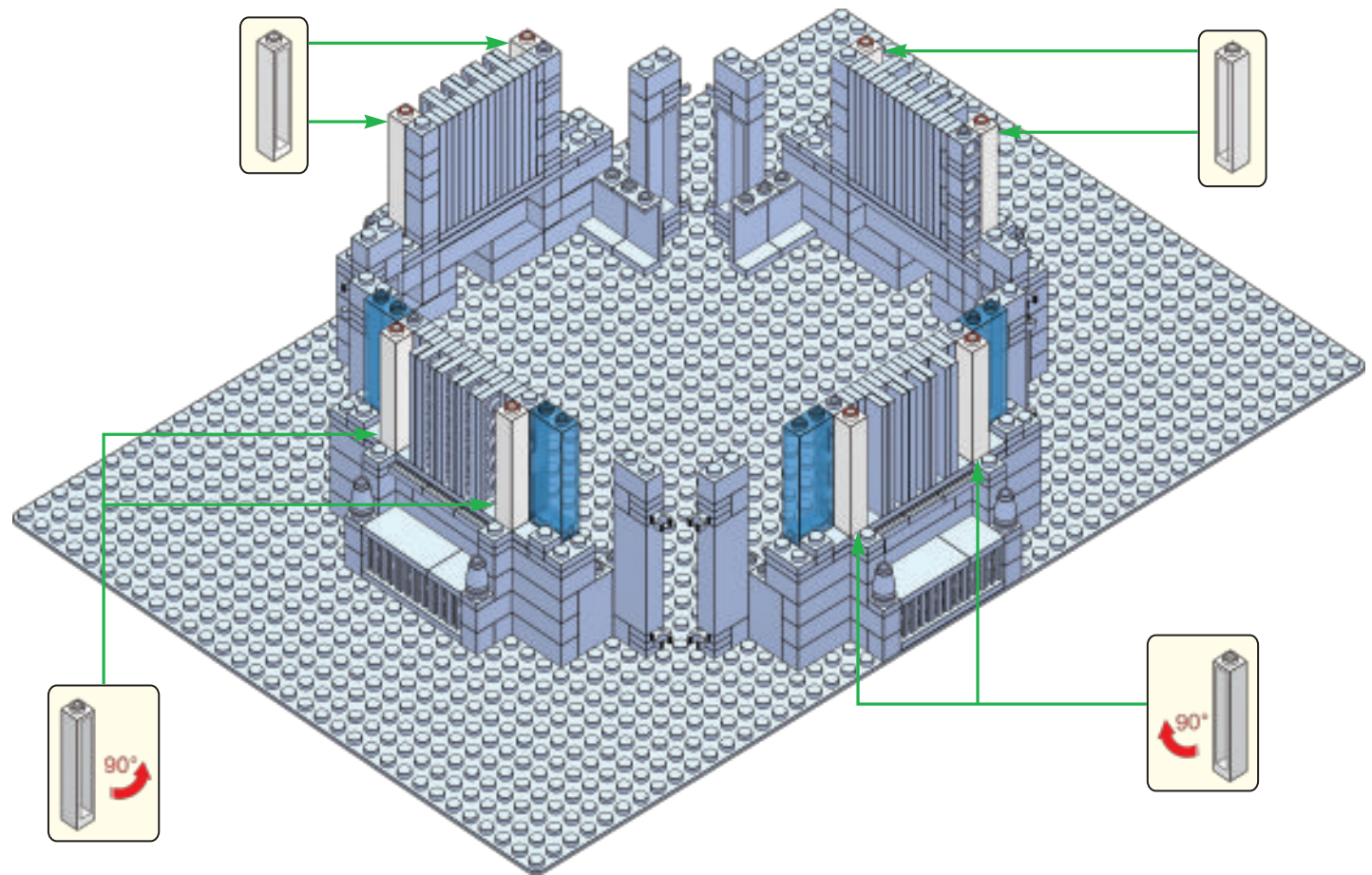

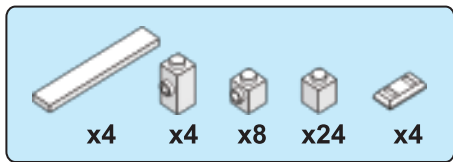

13

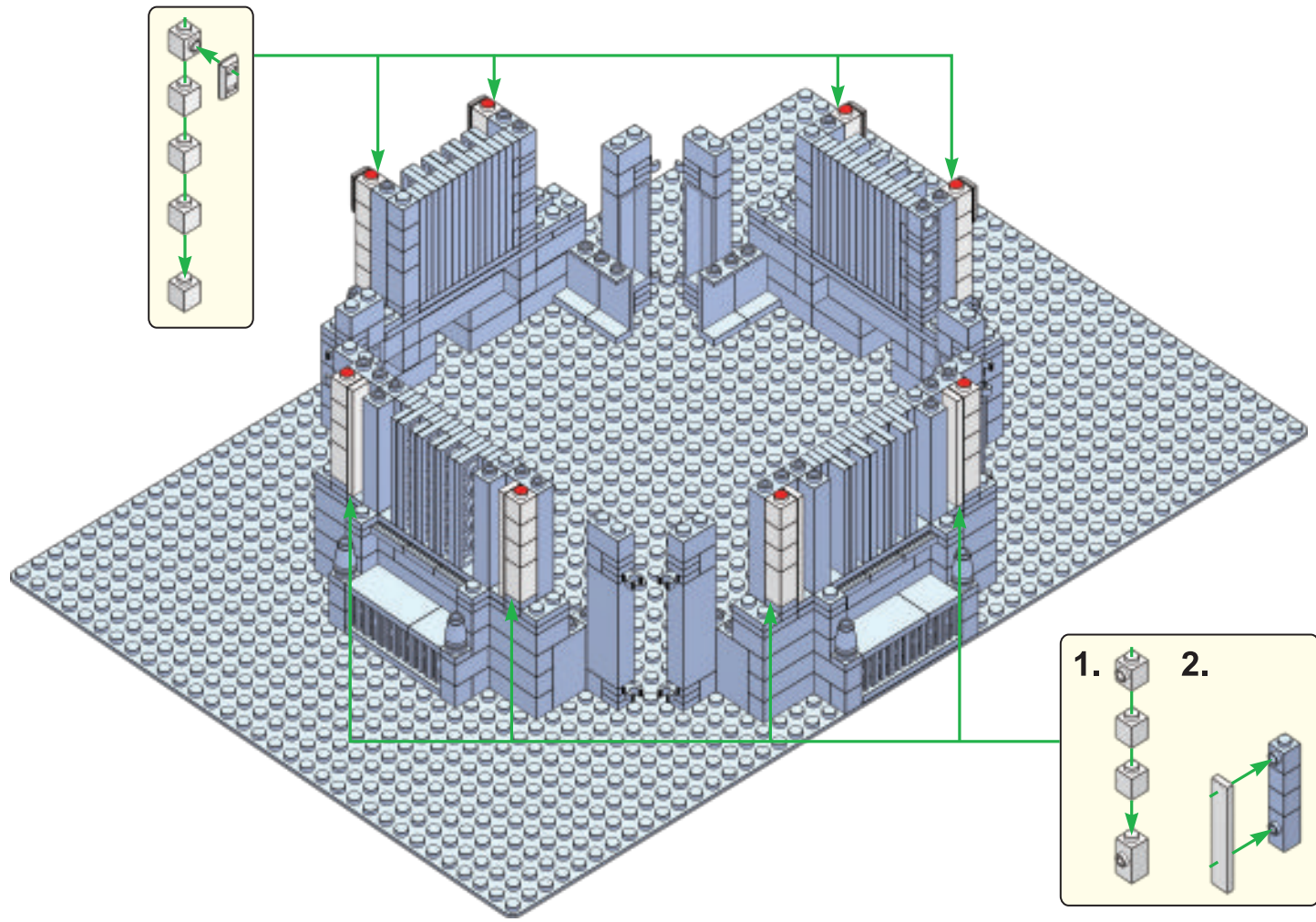

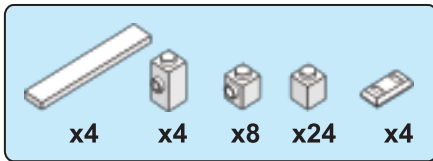

14

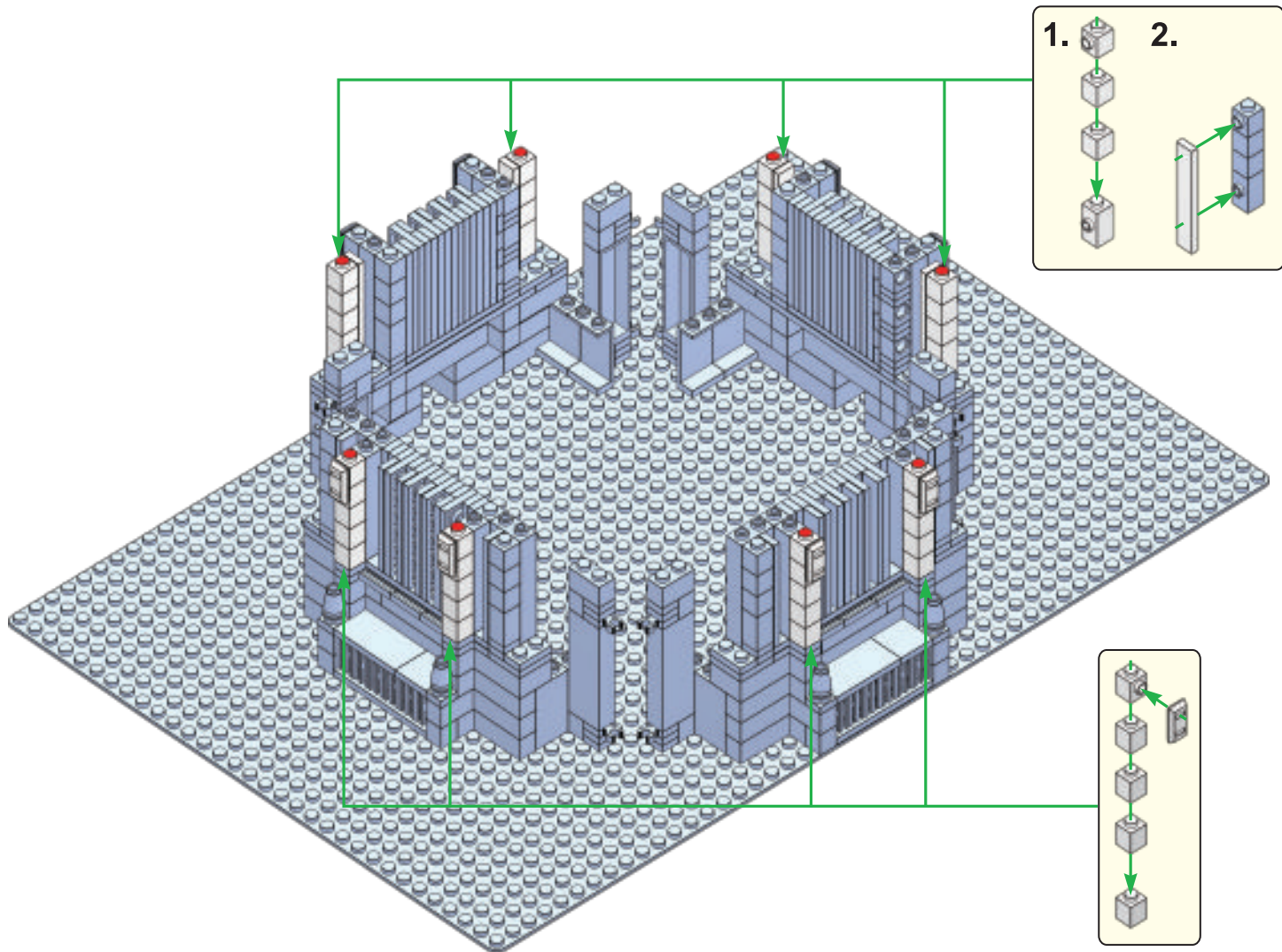

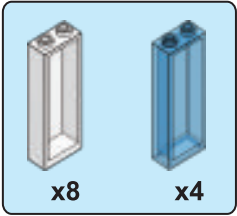

15

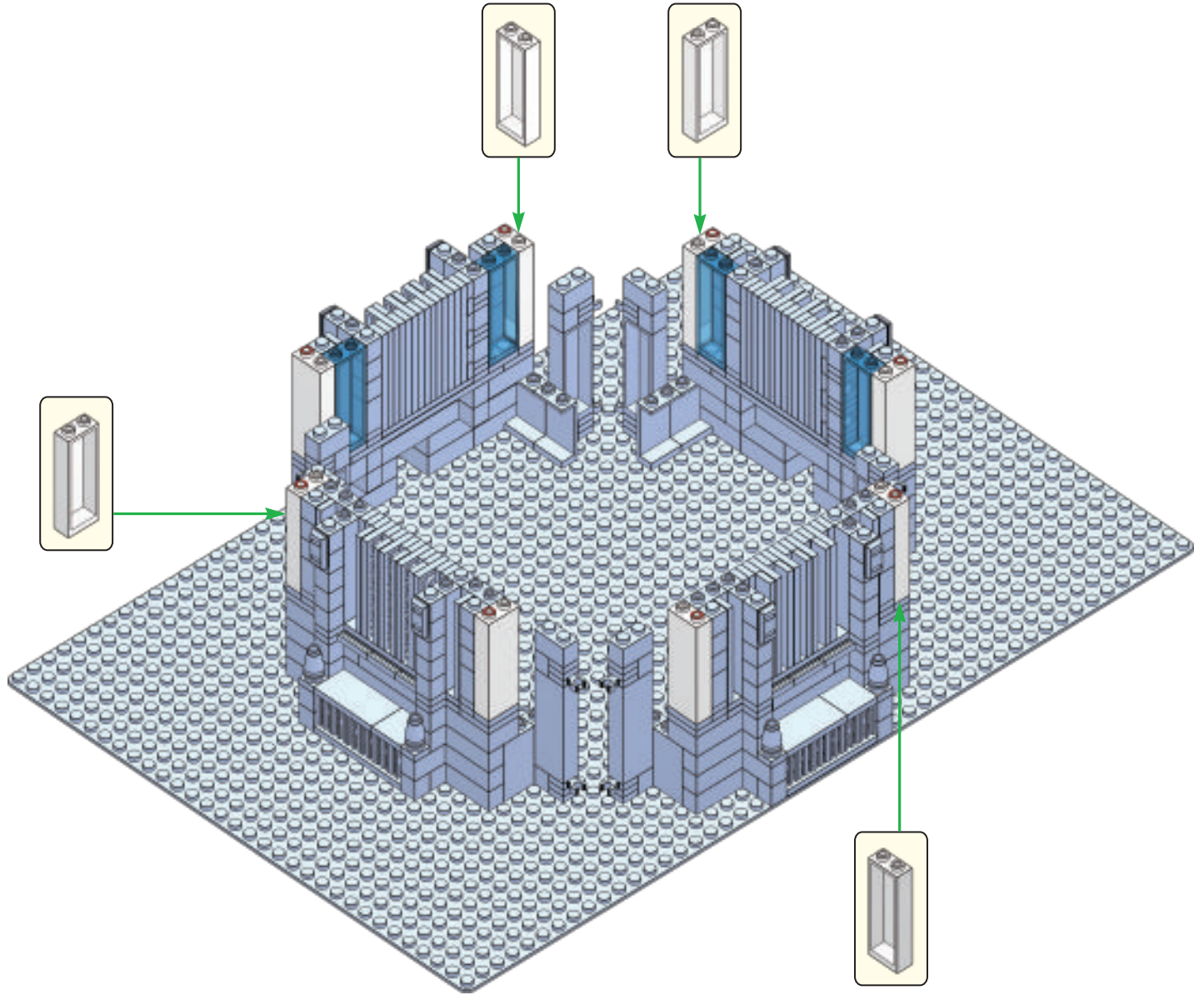

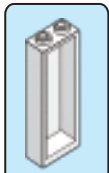

x16

16

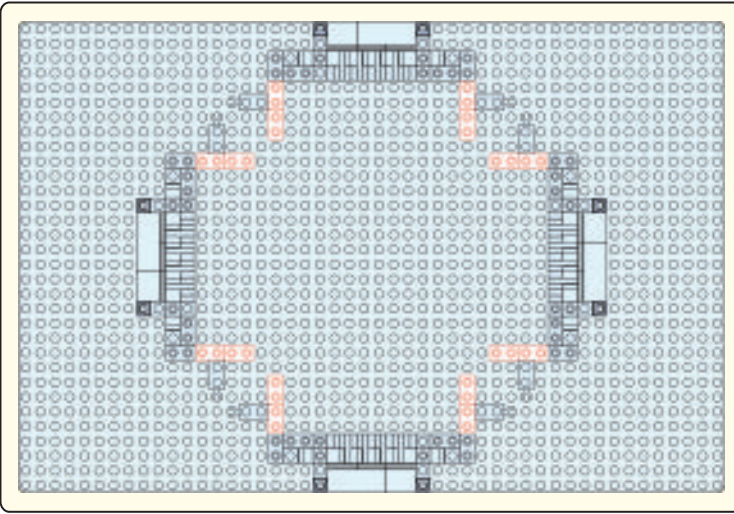
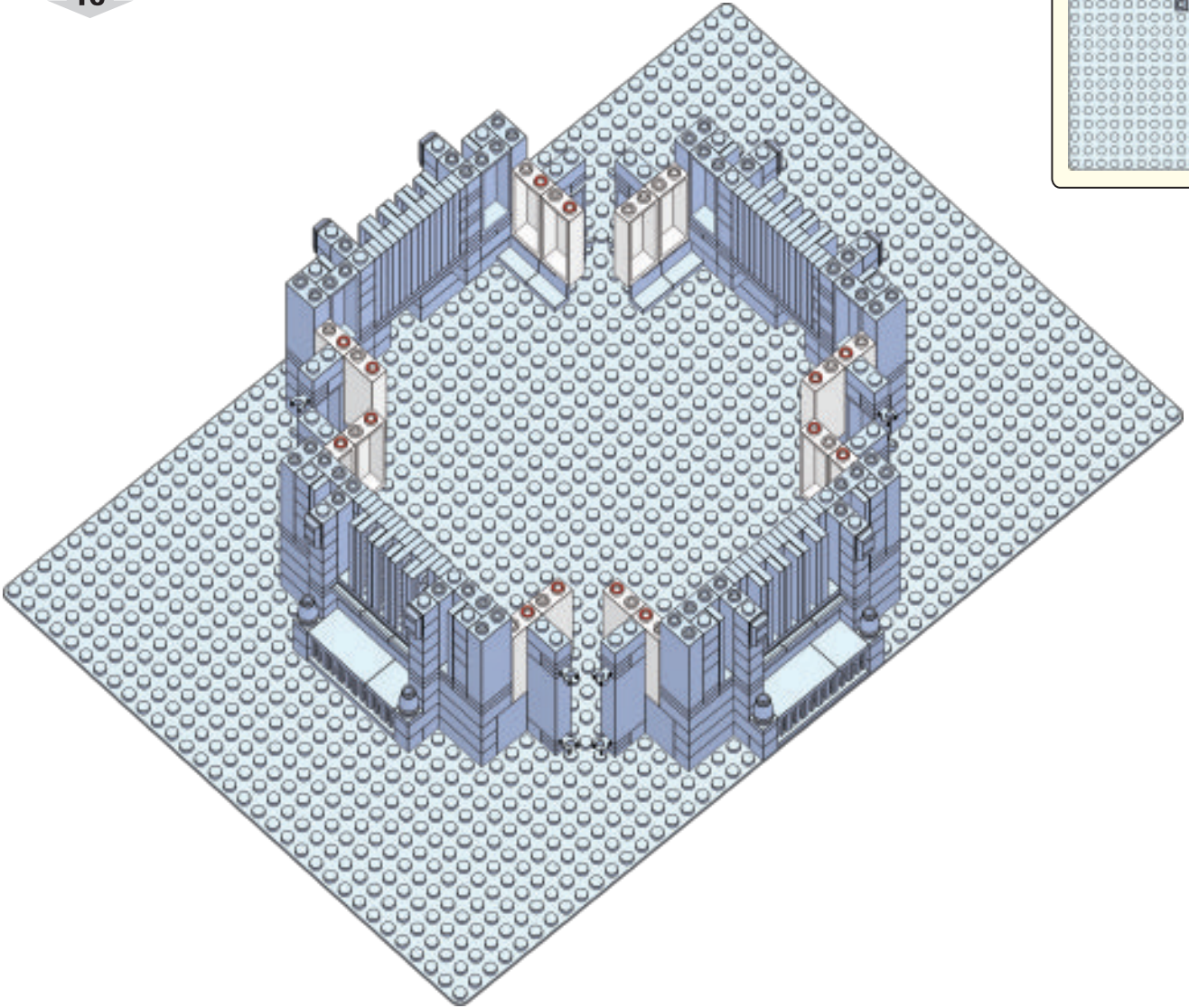

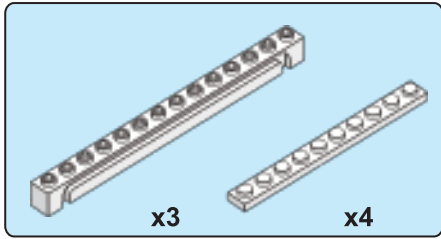

18

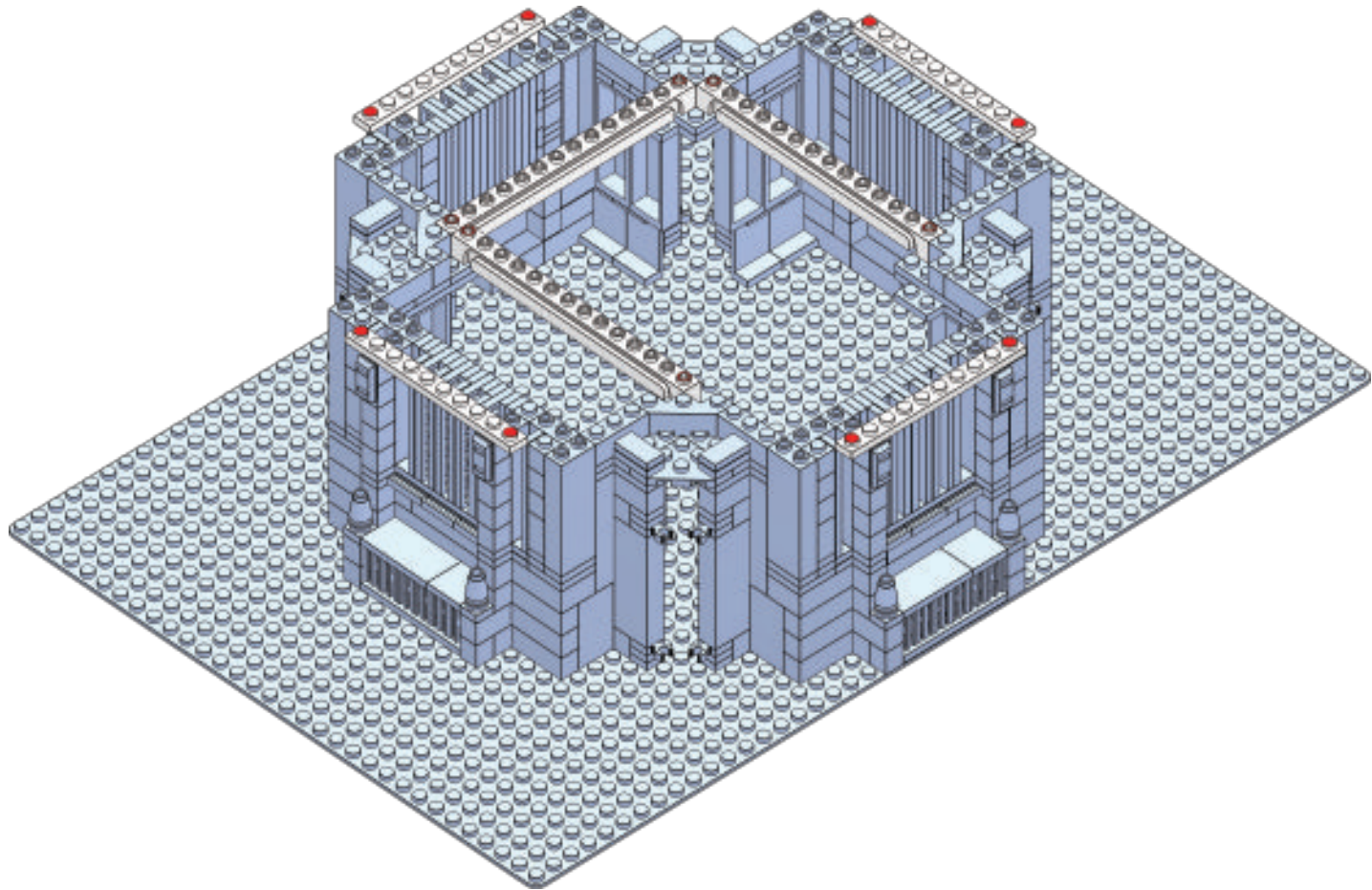

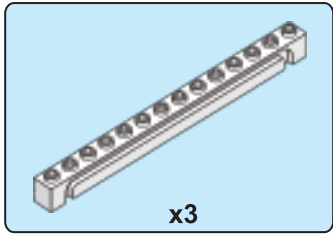

19

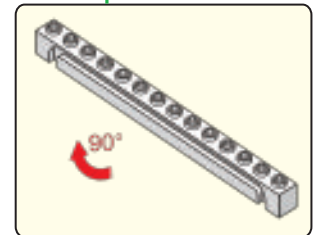
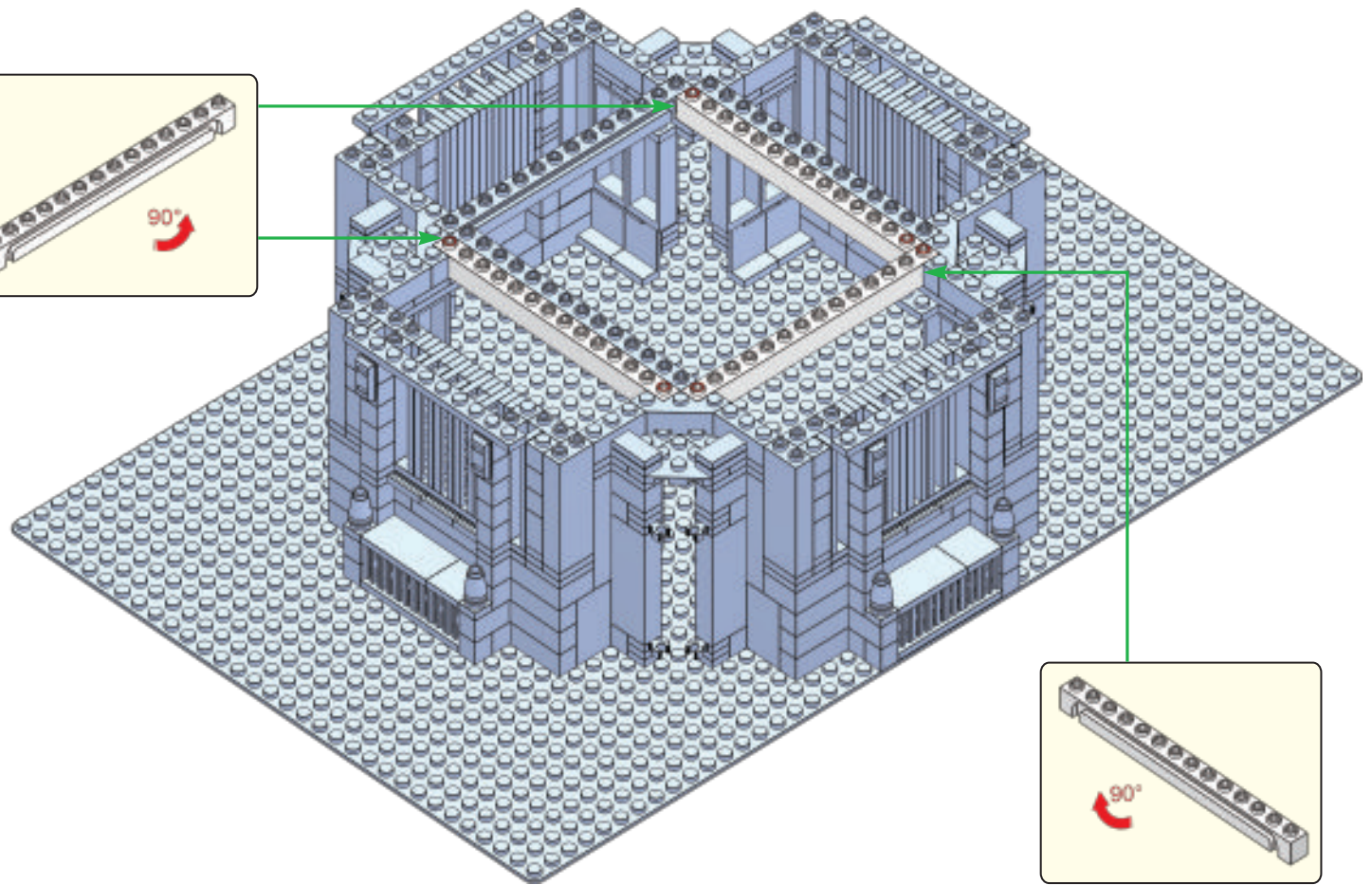
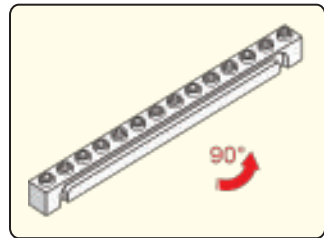

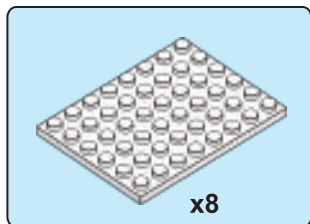

20

Please note: it is important to make sure the large flat plates are fully clicked to all corners of pieces underneath.

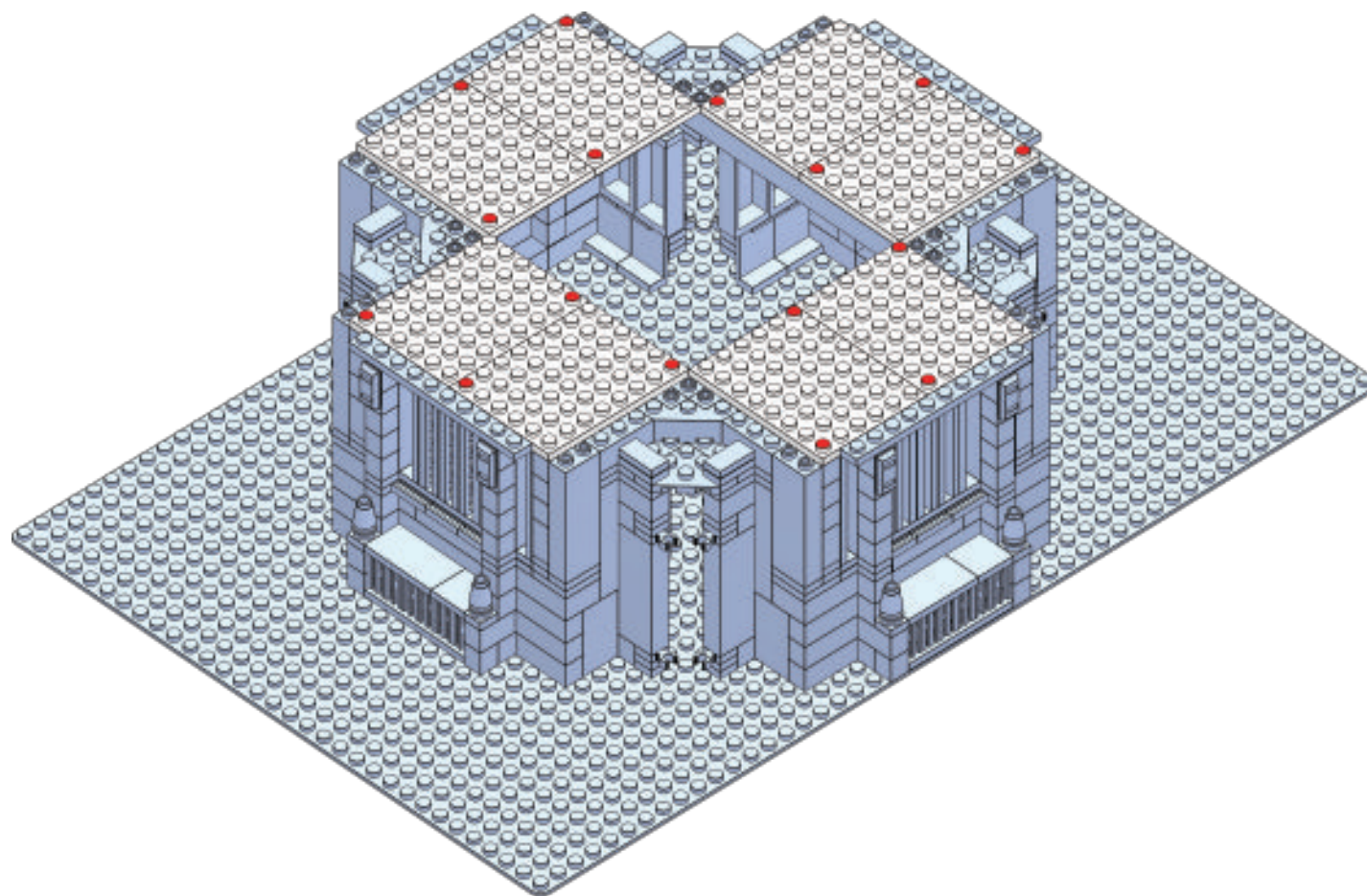

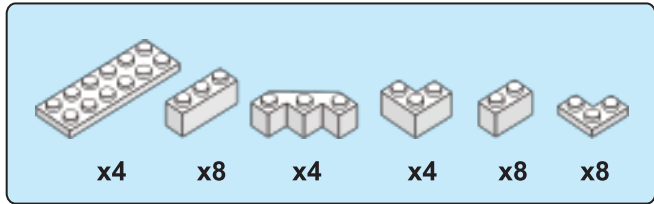

21

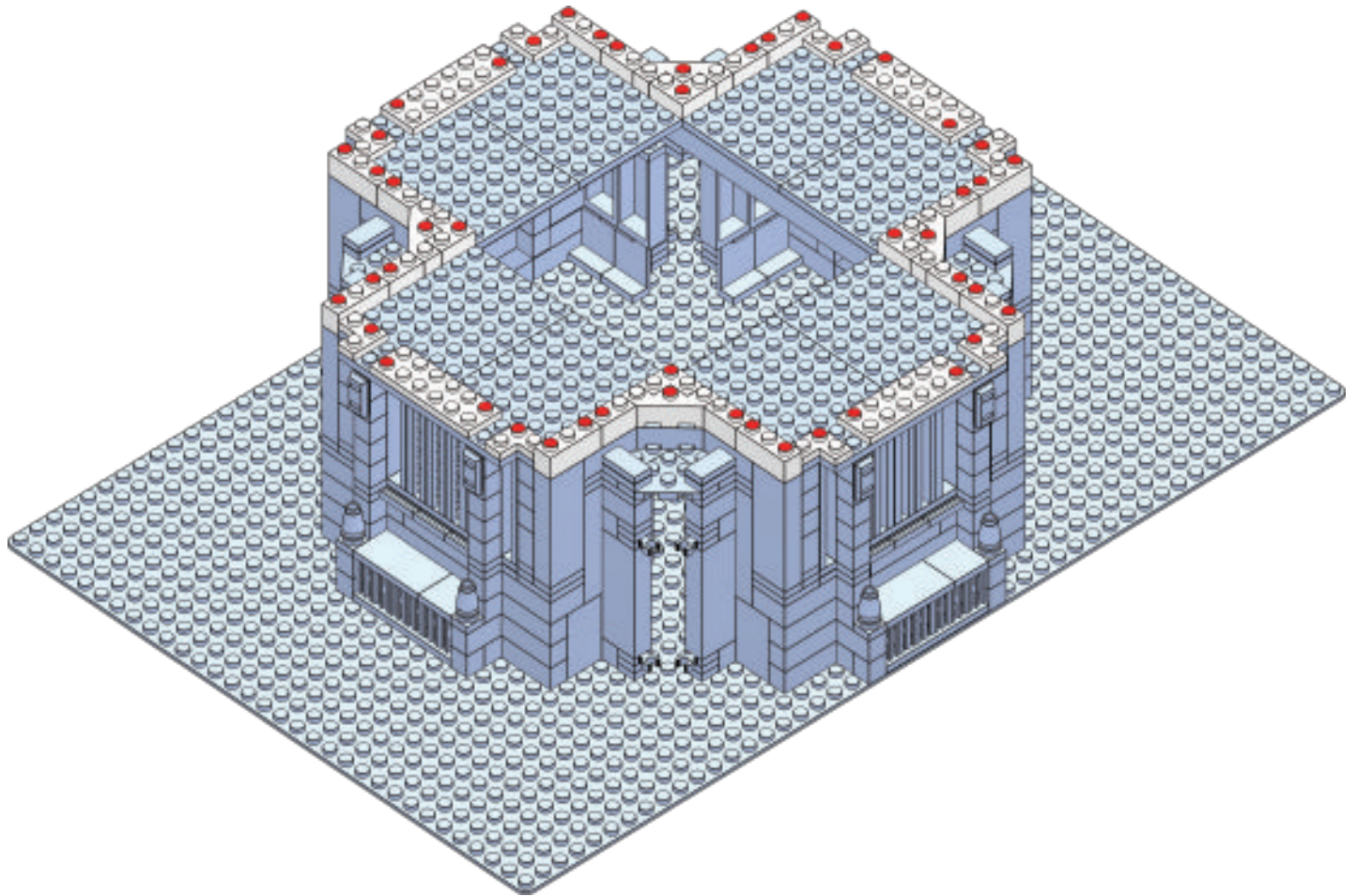

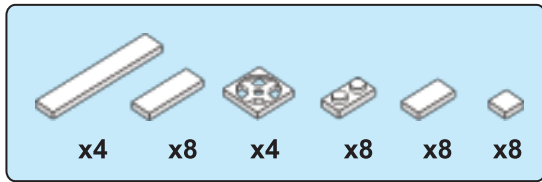

22

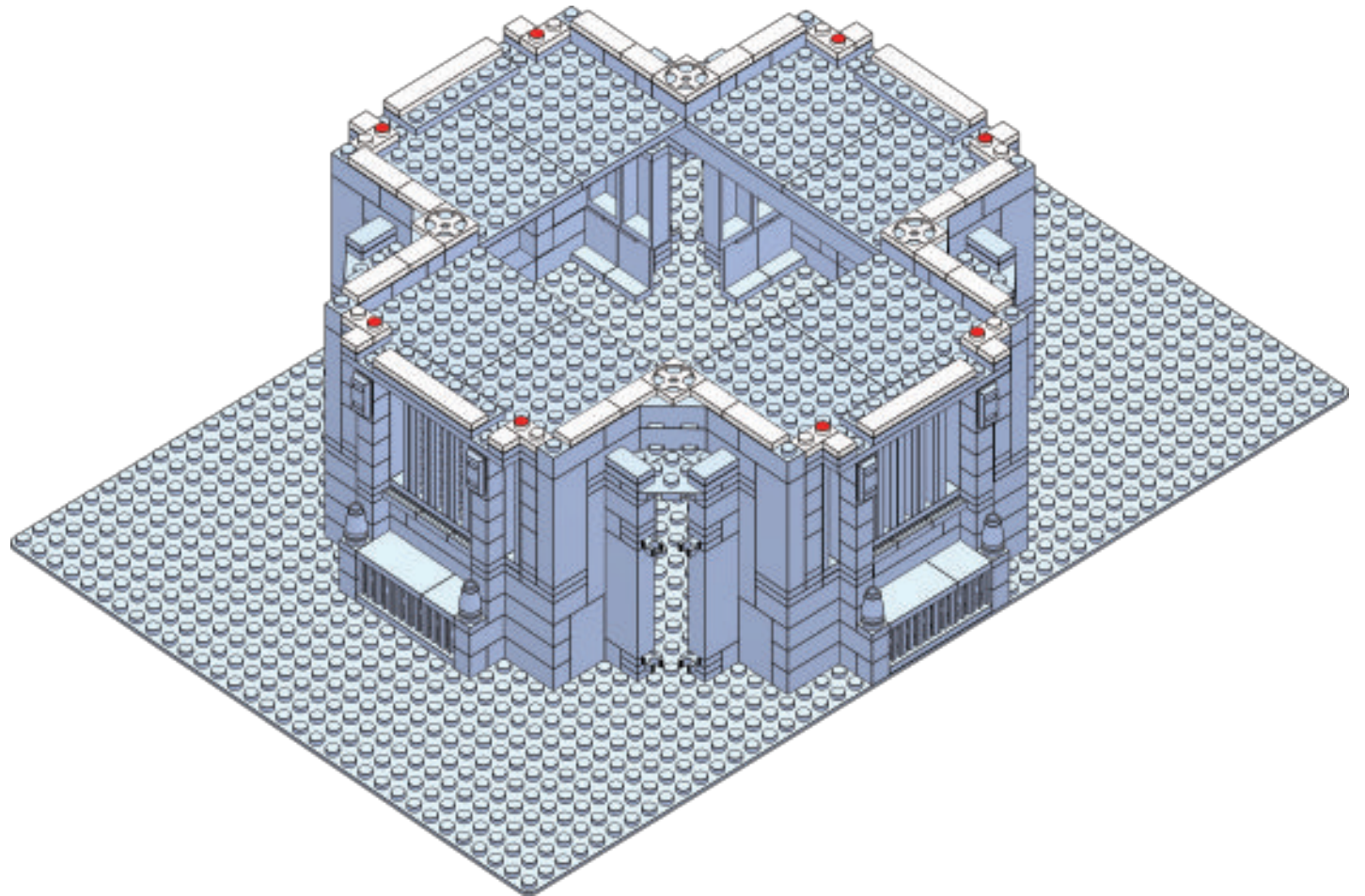

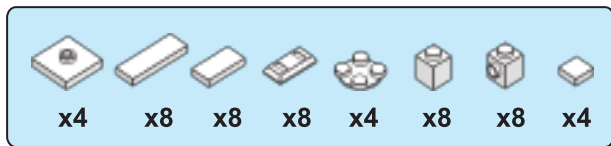

23

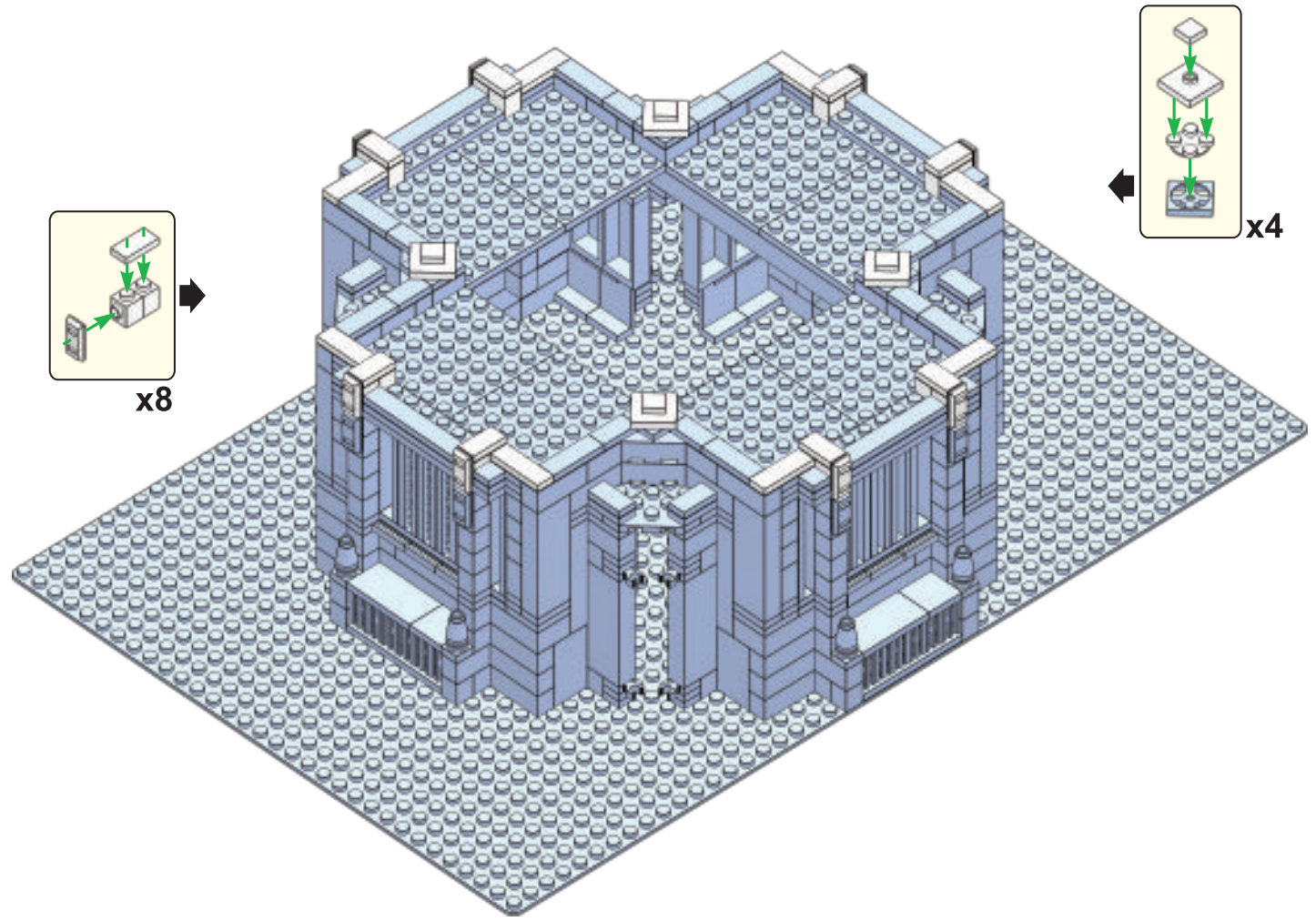

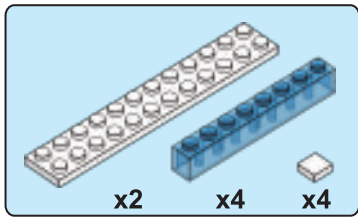

24

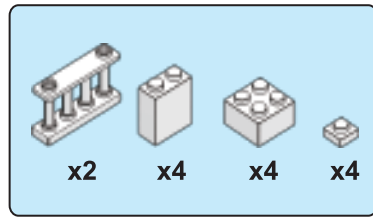

25

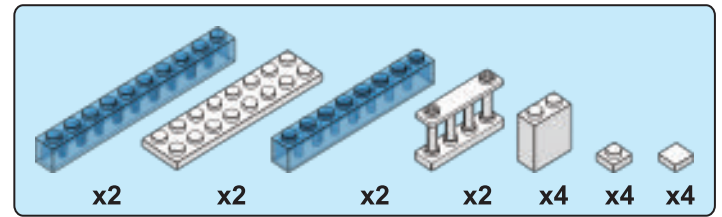

26

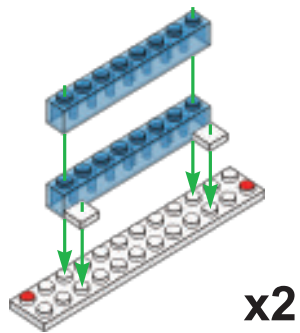

x2

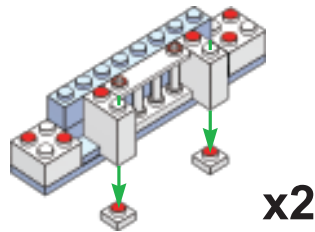

x2

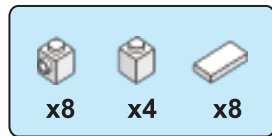
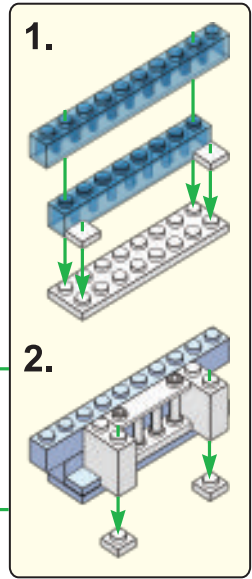
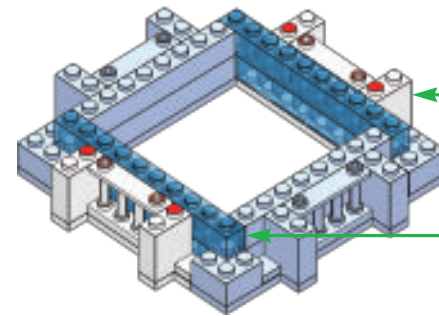

27

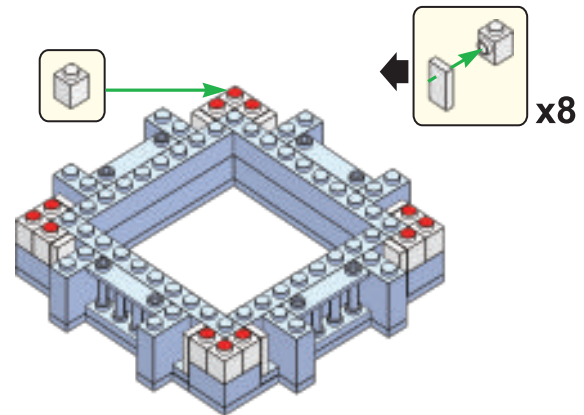

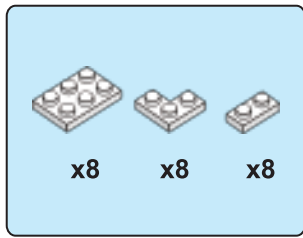

28

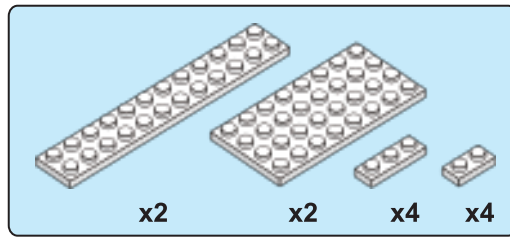

29

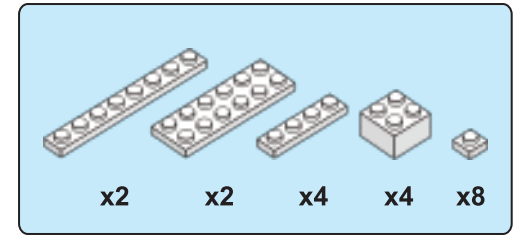

30

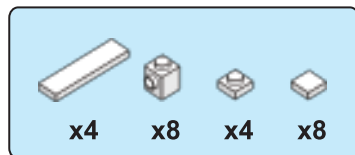
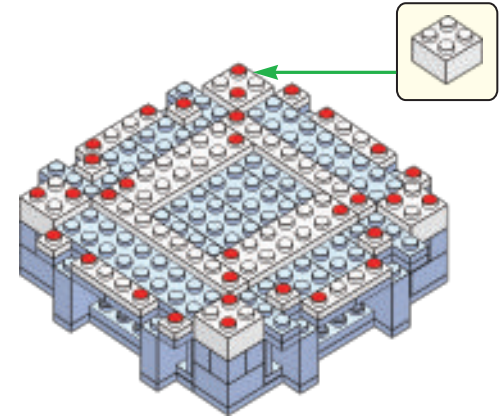
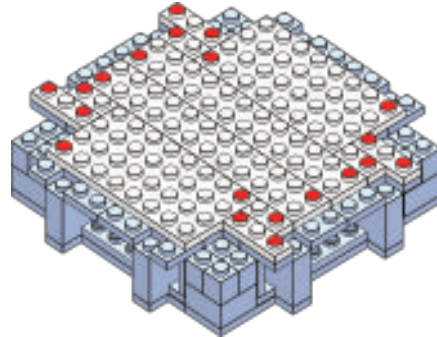
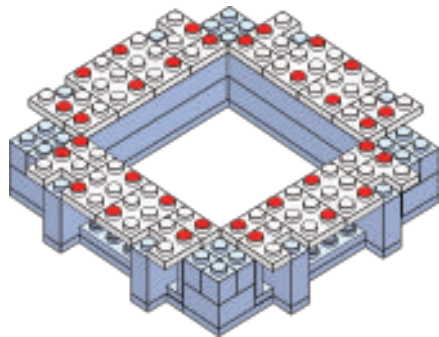

31

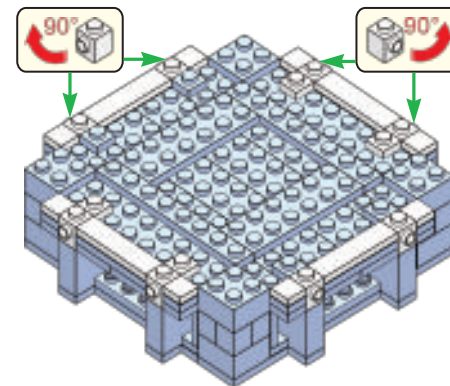

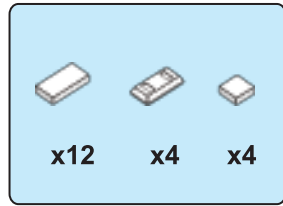

32

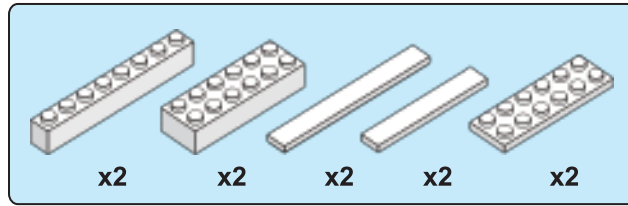

33

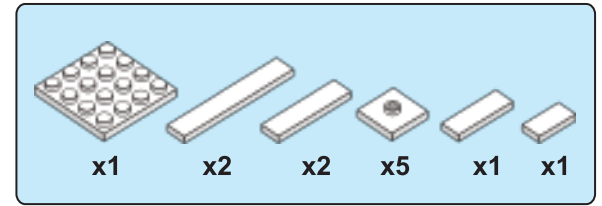

34

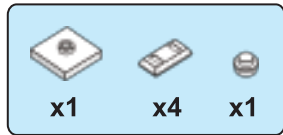
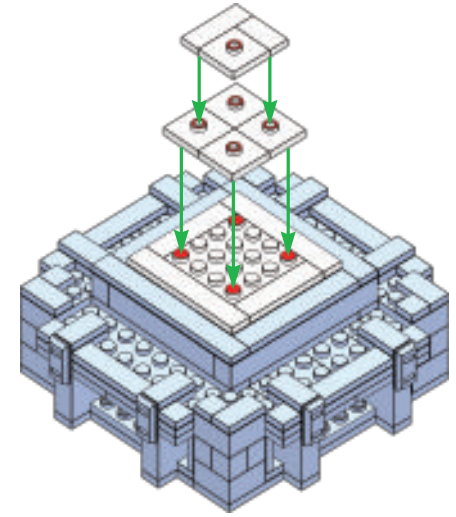
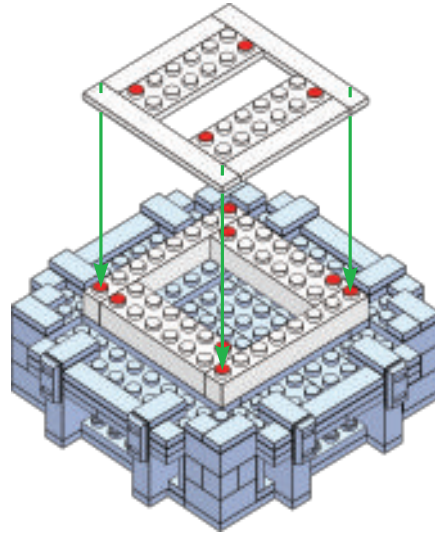
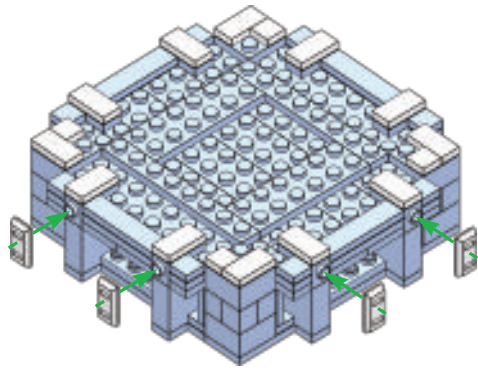

35

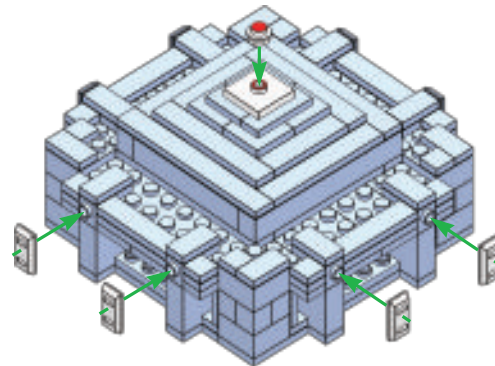

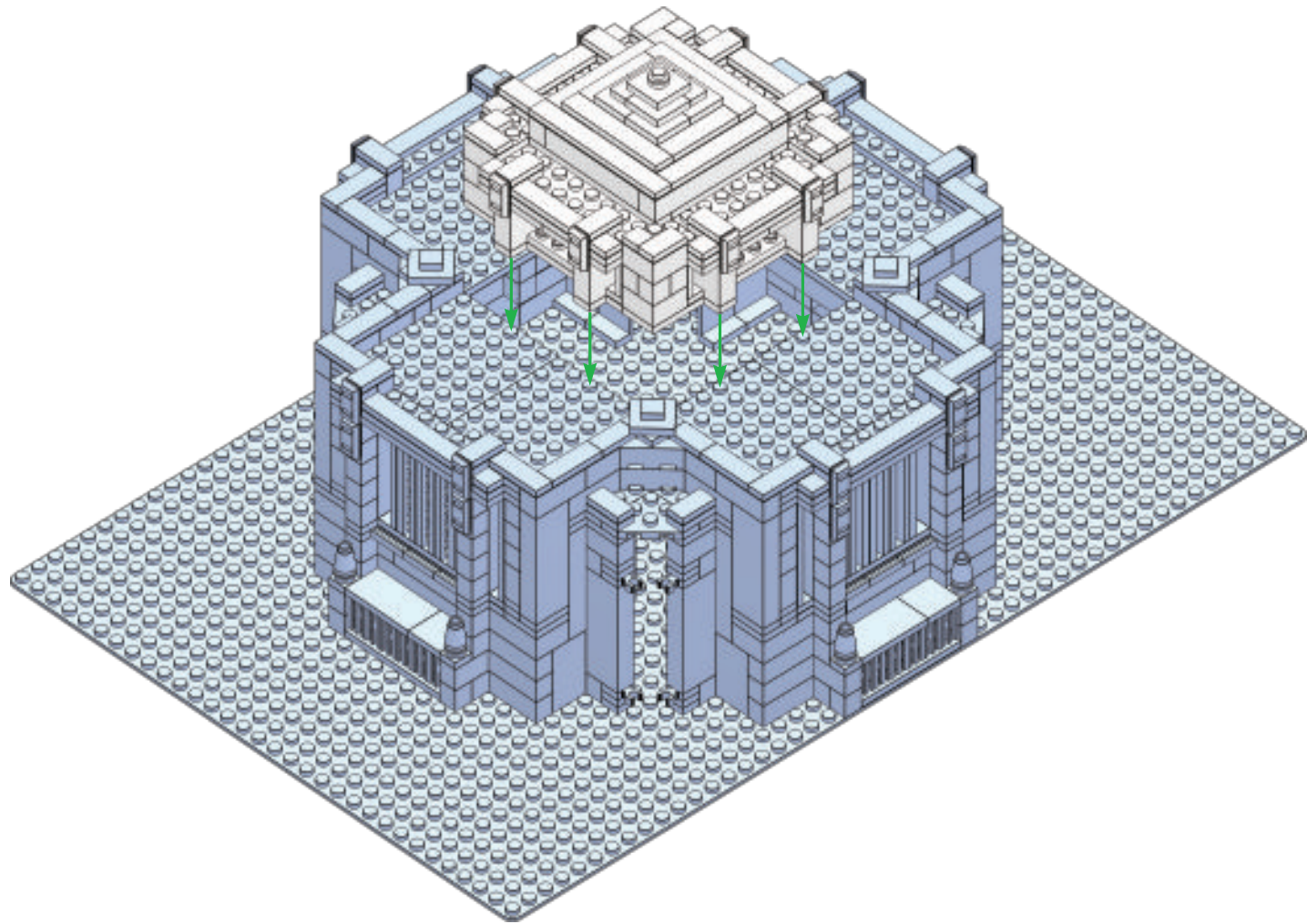

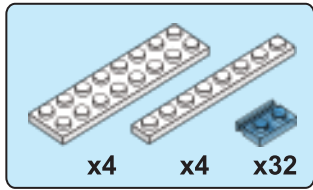

37

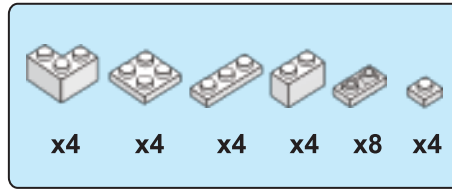
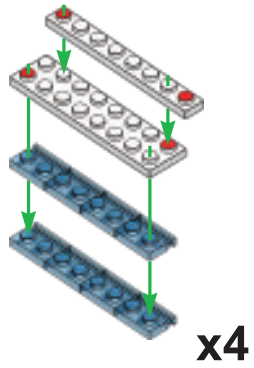

38

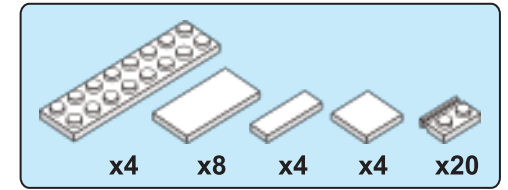
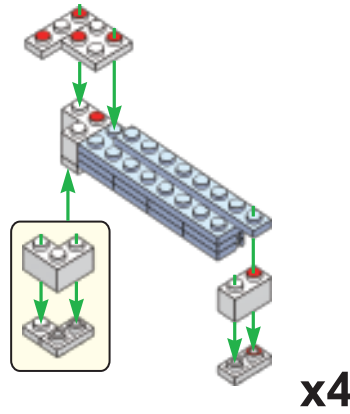

39

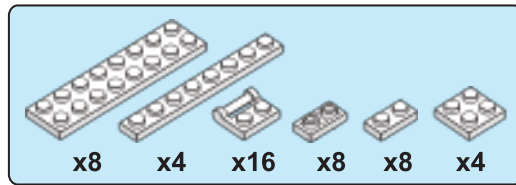
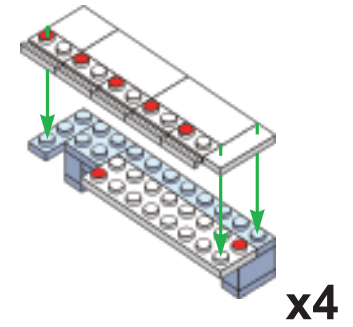

40

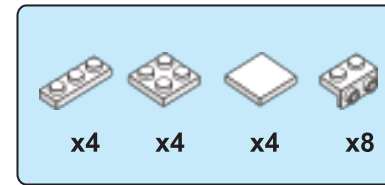
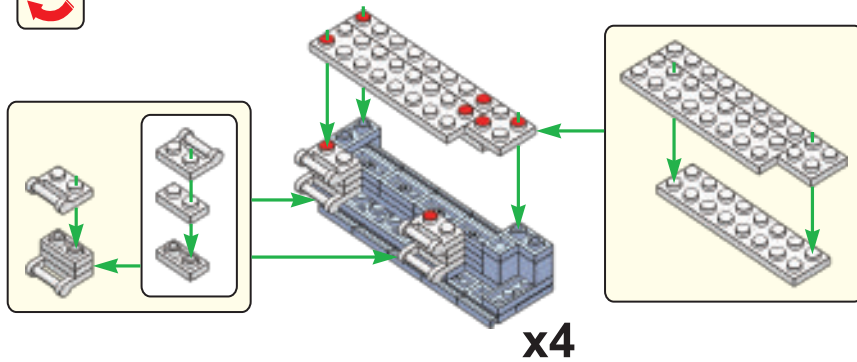

41

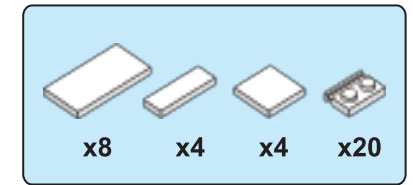
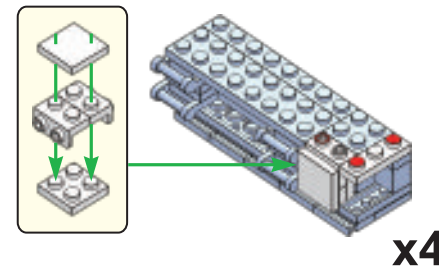

42

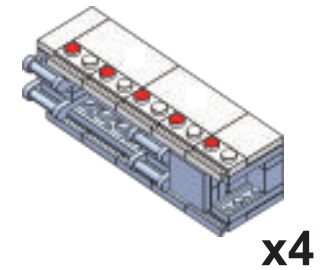

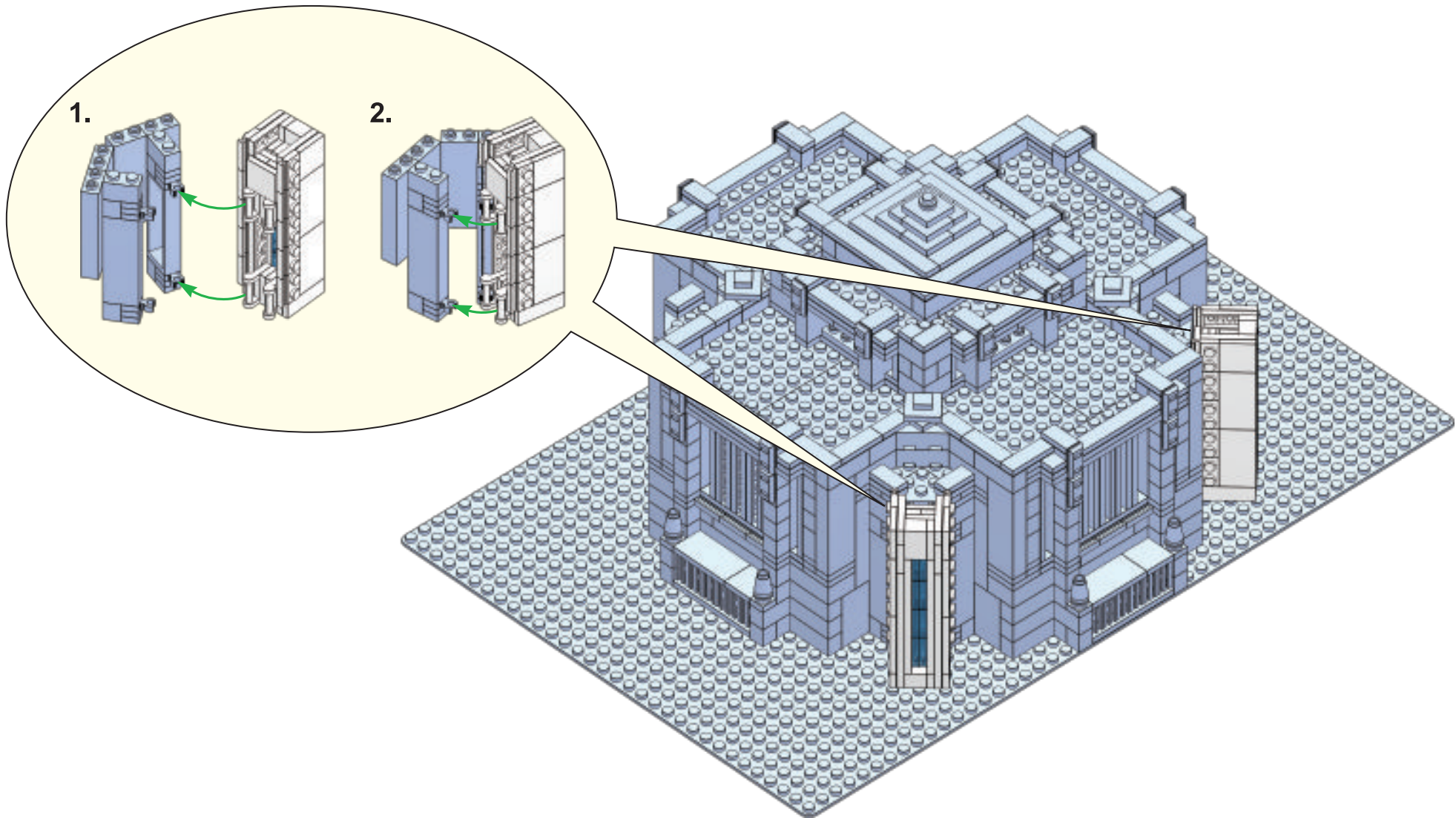

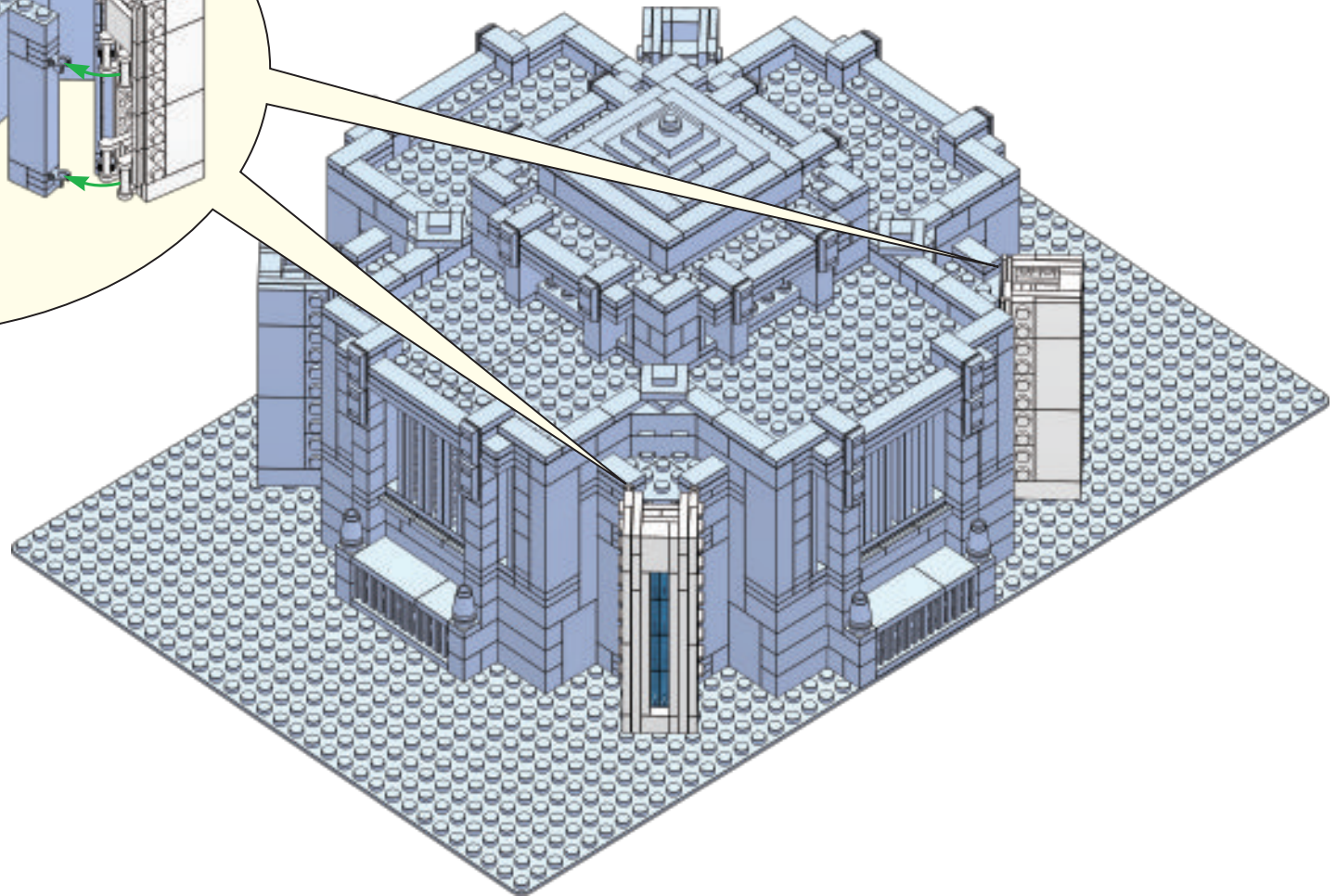
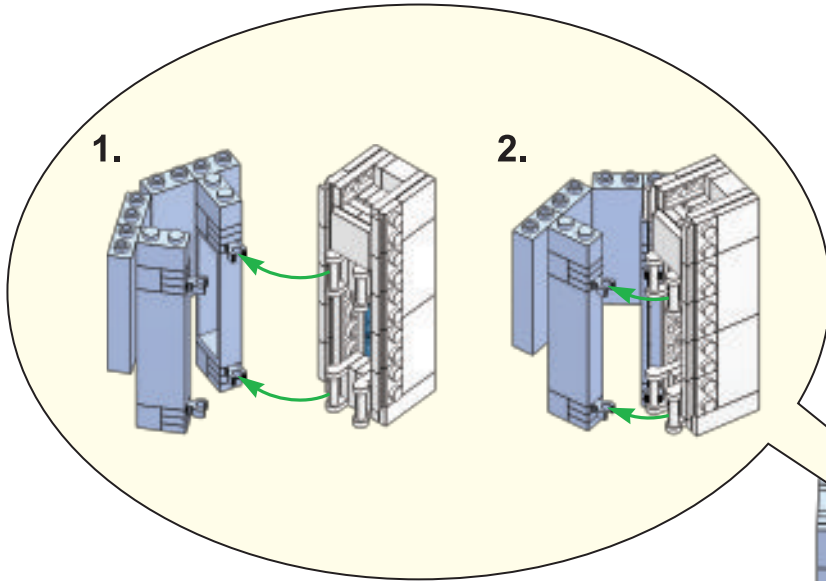

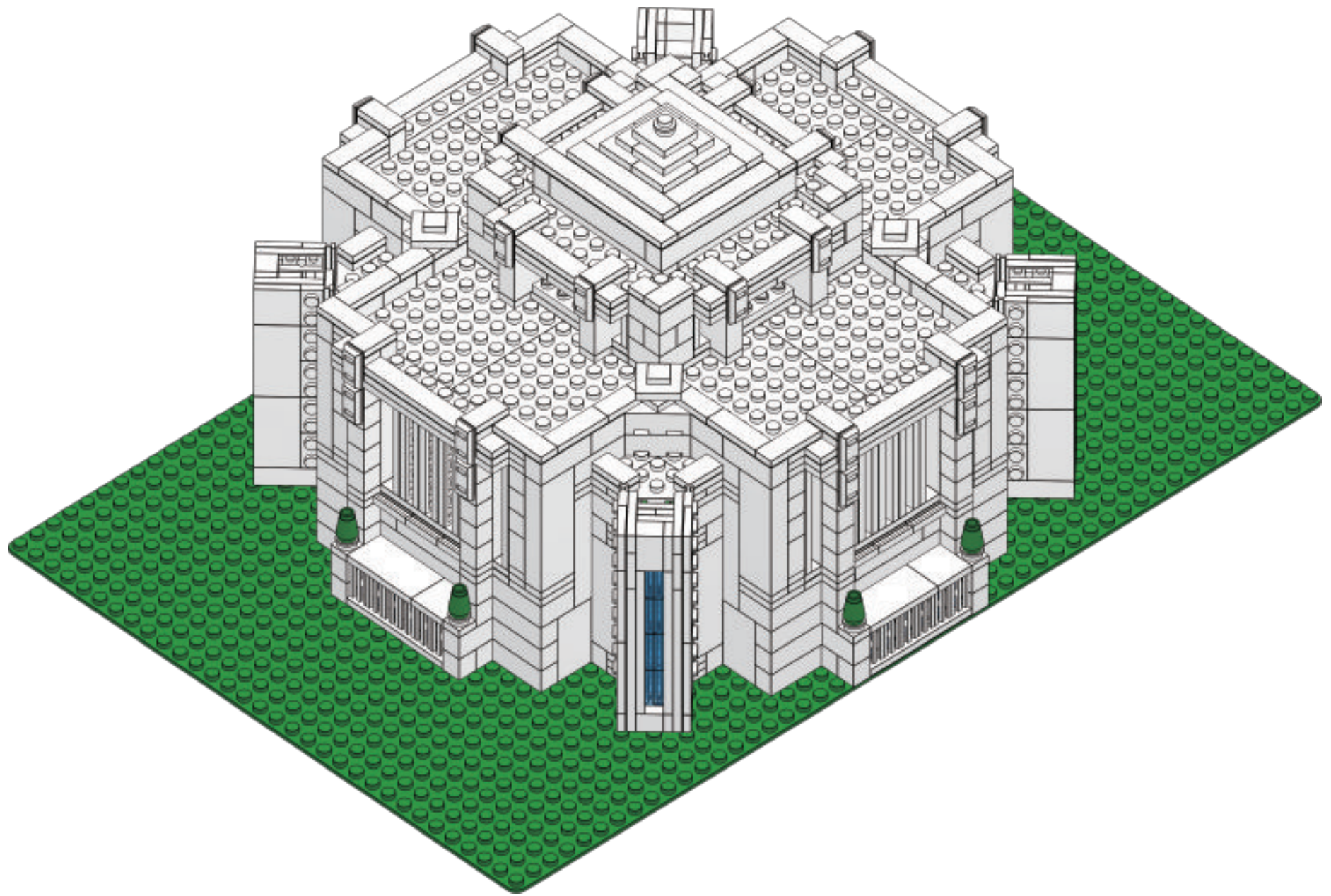

Send us a picture together with your completed temple set to info@brickemyoung.com and receive free Missionary figurines!

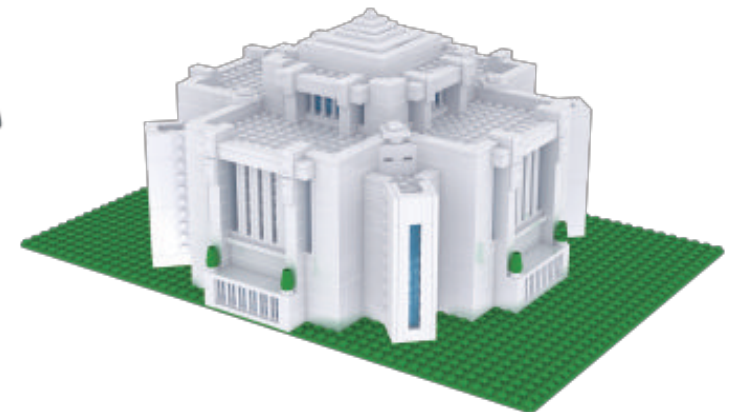

Warning! Choking hazard. Small parts.
Achtung! Erstickungsgefahr. Enthält Kleinteile.
Attention! Risque d'étouffement. Petites pièces.
Avvertenza! Pericolo di soffocamento. Contiene parti piccole.
Waarschuwing! Verstikkingsgevaar. Kleine deeltjes.
iAdvertencia! Riesgo de asfixia. Piezas pequeñas.
Advarsel! Kvælningssfare. Små dele.
Varoitus! Tukehtumisvaara. Pieniä osia.
Varning! Kvävningssrisk. Innehåller smådelar.
Atenção! Perigo de asfixia. Peças pequenas.
Προειδοποίηση! Κίνδυνος πνιγμού. Μικρά κομμάτια.
警告! 窒息の危険性。小さな部品が入っていますので、ご
注意ください。
警告! 小心窒息。当心小物件。
경고! 질식 위험. 작은 부품 포함.
Внимание! Риск удушения. Содержит мелкие детали.

Ostrzeżenie! Zagrożenie zadławienia. Małe elementy.
Upozornění! Nebezpečí udušení. Obsahuje malé součástky.
Upozornenie! Nebezpečenstvo udusenja. Obsahuje malé súčasti.
Figyelmeztetés! Fulladásveszély! Kis elemeket tartalmaz.
Обережно! Ризик задухи. Містить дрібні деталі.
Upozorenje! Opasnost od gušenja. Sitni dijelovi.
Упозорење! Опасност од гушења. Мали делови.
Opozorilo! Nevarnost zadušitve. Majhni delčki.
Avertisment! Pericol de sufocare. Piese mici.
Внимание! Опасност от задавяне. Малки части.
Brīdinājums! Pastāv nosmakšanas risks. Satur sīkas daļas.
Hoiatus! Lõbumisoht. Sisaldab väikseid osi.
İspējimas! Uzdusimo pavojus! Komplekte yra mažų detalių.
Dikkat! Boğulma tehlikesi. Küçük parçalar.

All copyrights, trademarks, intellectual property and other information contained belong to Brick'em Young.

No unauthorized usage or distribution of this material (including instruction booklet)

without the expressed written consent of Brick'em Young.

Brick'em Young is not owned or affiliated with The Church of Jesus Christ of Latter-day Saints.

Further questions can be directed to: service@brickemyoung.com.

This brick set contains many small bricks, Parental involvement is recommended!

www.brickemyoung.com

Product # 3:16



MADE IN CHINA