



1080P ROADCAM



BT58186

User Manual

**Important, retain for future reference:
Read carefully**

QUICK INSTALLATION GUIDE

Before you begin... Gather these items.

1



2



3



4



1. Mount the Roadcam

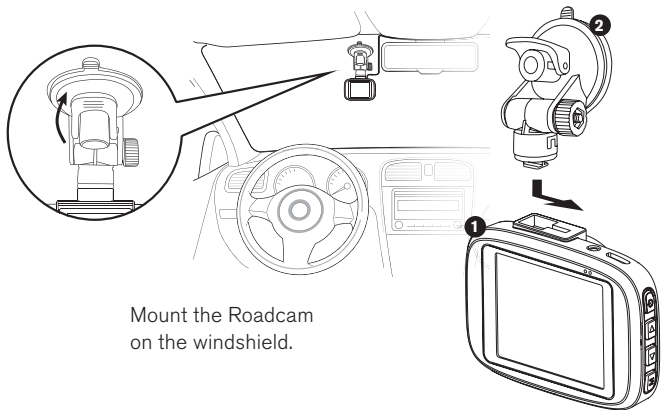

Mount the Roadcam
on the windshield.

2. Insert the MicroSD Card

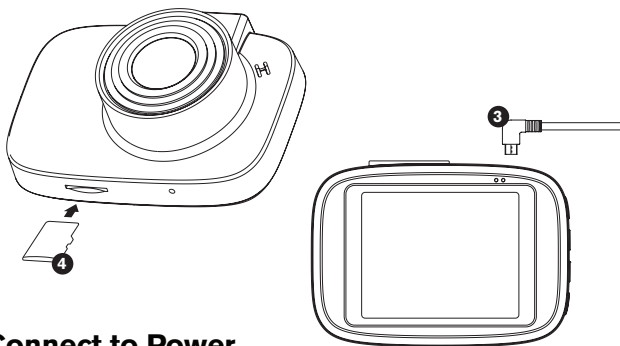

3. Connect to Power

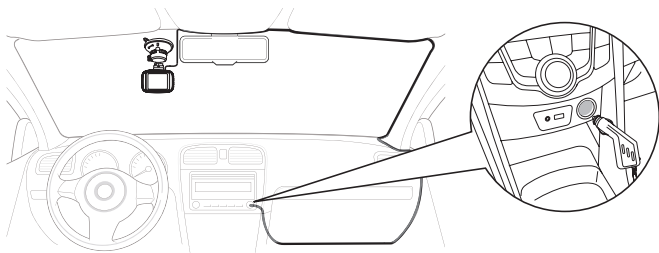

INTRODUCTION

Please read all of the installation instructions carefully before installing the product. Improper installation will void manufacturer's warranty. The installation instructions do not apply to all types of vehicles, and are written as guidelines to assist in installing the system.

Consult an experienced technician if you are not comfortable installing the product. You can also contact YADA at **1.866.294.9244** to speak to one of our installation specialists if you have any specific questions regarding the 1080P Roadcam.

BEFORE using the 1080P Roadcam, please read the safety information provided in this user manual. ALWAYS use the product as outlined in this user manual.

Please make sure to read and understand all local laws and regulations regarding cameras and their use in a vehicle. Laws vary by state.

PACKAGE CONTENTS

1. 1 x 1080P Roadcam
2. 1 x Windshield Mount
3. 1 x 12V/24V Power Adapter
4. 1 x 4GB MicroSD Card

1

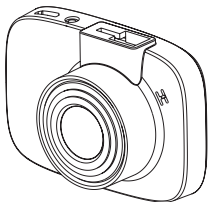

2

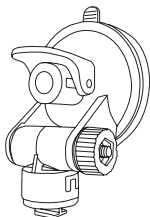

3

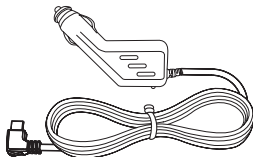

4

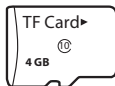

PRODUCT SPECIFICATIONS

Display:	2.2 inch display
Lens:	120 degrees diagonal
Video Resolution:	1080P / 30 FPS
Circular Video:	Seamless loop recording
Memory Card:	MicroSD (maximum support 32GB)
Microphone:	Supported
Built-in Audio:	Supported
Operating Temperature:	14°F ~ 140°F (-10°C ~ 60°C)
Operating Voltage:	Cigarette Charger - DC 12/24V / DC 5V (Micro USB)
Battery:	Built-in 180 mAh li-ion battery

CAMERA DIMENSIONS

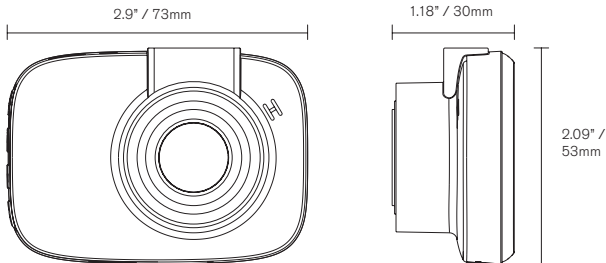

PRODUCT OVERVIEW

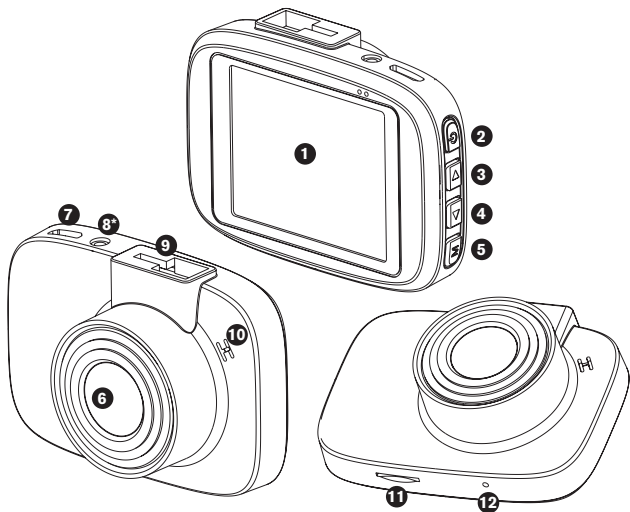

1. LCD Screen

2. Power / OK / Record Button

3. Up Navigation Button

4. Down Navigation Button

5. Menu / Back Button

6. Camera Lens

7. Micro USB Power Port

8. Rear View Camera Jack

(Rear View Camera not Included)

* Sold Separately

9. Mounting Socket

10. Speaker

11. MicroSD Card Slot

12. Power Reset Hole

INSTALLATION

1.

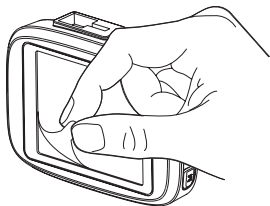

Peel off the protective sticker from the LCD screen and insert the MicroSD card.

2.

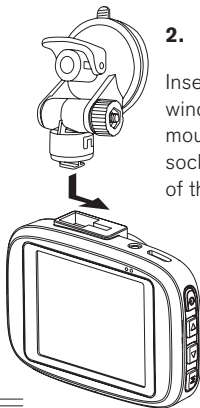

Insert the windshield mount to the socket on the top of the Roadcam.

3.

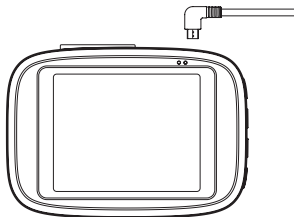

Plug the Micro USB power cable into the DC input port.

Note: Power on and test camera before mounting.

INSTALLATION

4.

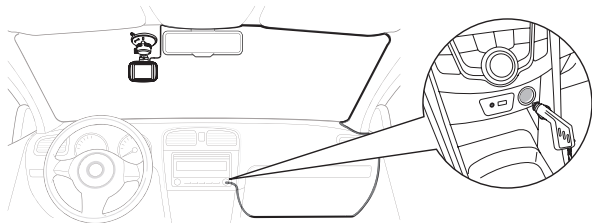

Route and hide the power cable in the headliner and pillars in your vehicle. Plug the cigarette charger cable into your vehicle's 12/24V DC outlet.

5.

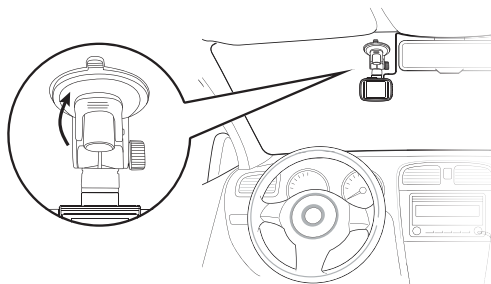

Mount the Roadcam on the windshield. You can turn on the Roadcam and check the live screen to determine the most suitable mounting position. Push the locking lever while pressing the windshield mount onto the glass to secure the camera on the windshield. You are all set!

CONFIGURATION & MENU SETTINGS



Initial Setup

Set the date & time before installing and using the Roadcam. This date & time is the time stamp for all recorded media files and digital clock.

Switching Modes

Press and hold the **M** button to cycle through the following modes: video mode > camera mode > playback mode. The Roadcam cannot switch between modes while it is recording. Press the  button to stop recording and press and hold the **M** button to switch between modes.

Video Mode





- This is the default recording setting. The Roadcam will start recording automatically once it is turned on.
- Files are looped or recorded over by the default of 1 minute.
The MicroSD card will hold 1 minute segments and record over them as space is needed.
- Stop loop video: press the  button once to pause or resume recording.
- Lock video: press the **M** button during recording to lock that recorded file.
- Press the  button during recording to turn the microphone on or off.

G-Sensor Setting: The Roadcam's integrated G-Sensor will automatically save and lock the recorded file if activated by an impact event or accident. Select to turn the G-Sensor on or off. The default setting is low.

Camera Mode

- Press the  button each time you want to take a picture.

Playback Mode

- Press the  and  button to cycle through all the media files.
- Press the  button to play video files and press it again to pause.
- Press the **M** button to delete the file, press  to confirm.

General Settings Page

Recording must be paused manually to access the general settings page. Next, press the **M** button on video mode or camera mode to open the general settings page. Press the ◀ and ▶ button to cycle through all the settings.

Video Resolution	FHD 1920 x 1080, HD 1280 x 720 or VGA 640 x 480.
Photo Resolution	12M, 10M, 8M, 5M, 3M, 2M or 1M.
Loop Record	5 minutes, 3 minutes, 2 minutes or 1 minute.
Motion Detection	ON or OFF.
White Balance	Auto, Daylight, Cloudy, Tungsten or Fluorescent.
Sharpness	High, Normal or Soft.
Exposure	+2, +1.7, +1.3, +1.0, +0.7, +0.3, +0, -0.3, -0.7, -1.0, -1.3, -1.7 or -2.0.
Screen Save	10 minutes, 5 minutes, 3 minutes or OFF. (Screen will dim to a digital clock interface after the specified time you select.)
Record Audio	ON or OFF.
Parking Monitor	ON or OFF.
G-Sensor	High, Medium, Low or OFF.
Date/Time	Set the date and time.
Language	Supports English only.
Date Stamp	ON or OFF.
Frequency	50Hz or 60Hz.
Format	Select to erase all data in the MicroSD card.
Default Setting	Reset settings to their defaults.
Version	Firmware version.

ADDITIONAL FEATURES

Automatic ON / OFF

When the Roadcam is connected to the vehicle's power, it will power on and start recording when the vehicle engine starts. When the engine is off, the Roadcam will stop recording and turn off automatically.

Gravity Induction Recording Protection System

In a vehicle collision, the Roadcam will lock the video of the accident and save it as a special image. At the same time, the icon of the lock will be displayed in the middle of the display screen. The locked image will not be overwritten by looped recordings.

Note: The G-Sensor supports sensitivity adjustment and it can be done in the general settings page according to actual needs.

Park & Record Mode

The Park & Record mode allows the Roadcam to record videos when an impact is detected while the vehicle's engine is off. The Roadcam will turn on automatically and record a 20 second video clip and then shutdown; when it detects another impact, it will record another 20 second video clip until memory card capacity is reached.

Note: The Roadcam will switch to Park & Record mode when the vehicle's engine is turned off. Alternatively, press the power button for more than 3 seconds.

Battery Indications:

Please refer to the diagram below for the battery indication.



Fully charged



Battery low



Battery is empty



Charging

Note: The Roadcam is designed to be powered on while the vehicle is running. The built-in battery is only designed for storing documents when the vehicle's engine is off. The battery capacity of the built-in battery is limited. Please connect the Roadcam to the vehicle's on-board power supply for daily use.

Camera Reset: If the camera is involved in an accident and requires reset, simply hold the power button for 5 secs to power off, and then press the power button to turn on the Roadcam.

Help / FAQs

- 1) Problem: The Roadcam is unable to take pictures and record videos.
Solution: Check if the MicroSD card has enough space and lock it.
- 2) Problem: The Roadcam stops automatically when it is recording a video.
Solution: Because HD video data takes a lot of space, please use a high-speed MicroSD card compatible with SDHC, high-speed MicroSD cards will have a C10 logo.
- 3) Problem: During the playback of pictures and videos, a "file error" message prompts.
Solution: When a MicroSD card storage error or incomplete file occurred, please use the camera's "format" function to reformat the MicroSD card.
- 4) Problem: The image looks foggy.
Solution: Please check whether there is dirt or fingerprints on the lens. Clean the lens using lens cleaner or lens wiper before using.
- 5) Problem: The image looks too dark.
Solution: If the Roadcam captures an image that is too dark, adjust the exposure level to your desired brightness.

SAFETY INFORMATION

IMPORTANT SAFETY INSTRUCTIONS

1. **SAVE THESE INSTRUCTIONS** – This manual contains important safety and operating instructions of the 12V/24V cigarette lighter adapter for Model BT58186.
2. Before using the product, read all instructions and cautionary markings.
3. Do not expose cigarette lighter adapter to rain, moisture, or snow.
4. Use of an attachment not recommended or sold by the product manufacturer may result in a risk of fire, electric shock, or injury to persons.
5. To reduce risk of damage to cigarette lighter connector and cord, pull by cigarette lighter connector rather than cord when disconnecting cigarette lighter adapter.
6. Make sure cord is carefully secured so that it will not be stepped on, tripped over, or otherwise subjected to damage or stress.
7. Do not operate cigarette lighter adapter with damaged cord or cigarette lighter connector – replace it immediately.
8. Do not operate cigarette lighter adapter if it has received a sharp blow, been dropped, or otherwise damaged in any way; take it to a qualified serviceworker.
9. Do not disassemble cigarette lighter adapter; take it to a qualified serviceworker when service or repair is required. Incorrect reassembly may result in a risk of electric shock or fire.
10. To reduce risk of electric shock, unplug cigarette lighter adapter before attempting any maintenance or cleaning. Turning off controls will not reduce this risk.

WARNING: A failure to read and follow these warnings and instructions may result in a serious accident, including damaged property or a serious injury, including loss of life.

- The 1080P Roadcam is designed as an aid to the driver in detecting large stationary objects to help avoid damaging the vehicle. However, you, the driver, must use it safely and properly. Use of the 1080P Roadcam is not a substitute for safe, proper and legal driving.
- Never depend on the 1080P Roadcam entirely when driving. The image on the screen is different from actual conditions. Objects viewed on the Roadcam Monitor differ from actual distance because a wide-angle lens is used.
- Always check behind and all around the vehicle visually with mirrors before proceeding.
- The area displayed by the 1080P Roadcam is limited. The 1080P Roadcam does not display objects that are out of the camera's field of view. The area displayed on the screen may vary according to vehicle orientation or road conditions.
- Be sure to check the camera's position and mounting angle before each use.
- Do not strike the 1080P Roadcam. It is a precision instrument. Otherwise, it may malfunction or cause damage resulting in a fire or an electric shock.
- This product will only provide images of items that are within the field of view of the 1080P Roadcam. Thus, it is imperative that the 1080P Roadcam should be kept clean and unobstructed.
- Adhere to all applicable traffic laws and motor vehicle regulations applicable to the device.
- Consult local laws and regulations for any restrictions on installation or use.
- Never allow children to play with the device. Small parts may be a choking hazard.

- There is a plastic cover over the 1080P Roadcam. Do not scratch the cover when cleaning dirt or snow from it.
- If the temperature changes rapidly, the system may not operate normally.
- When strong light directly enters a camera, objects may not be displayed clearly.
- The screen may flicker under fluorescent light.
- The colors of objects on the 1080P Roadcam may differ from those of the actual object.
- Do not use alcohol or thinner to clean the camera. This will cause discoloration. To clean the camera, wipe with a clean cloth dampened with mild cleaner diluted with water and then wipe with a dry cloth.

Safety Around and Behind Other Vehicles

Using a 1080P Roadcam is not enough to completely overcome a vehicle's blind spot. Many preventable injuries and deaths occur in driveways or parking lots when drivers do not see children, pets, or others near their vehicles. Here are a few safety tips that will help you to avoid an accident:

- Walk completely around your vehicle before getting in. Check for kids, toys, and pets before entering the vehicle and starting the engine.
- Know where children are. Have children stand in a place where they are in full view.
- Be aware of young children. Young children are small and hard to see.
- Parents, caregivers and all adults need to be vigilant in supervising children, especially when children are in the yard, driveway or parking lot playing near parked cars.

- Roll down your window so you will be able to hear what is happening outside your vehicle.
- Owners of SUVs, trucks, and vans need to take extra care to avoid hitting or running over a child.
- Teach children to move away from a vehicle whenever it is started.

MAINTENANCE & WARRANTY

Cleaning

- If dirt, rain or snow attaches to the camera, the Monitor may not clearly display objects. If water droplets, snow or mud adhere to the camera lens, rinse with water and wipe with a dry cloth.
- Do not use alcohol or thinner to clean the camera. This will cause discoloration. To clean the camera, wipe with a clean cloth dampened with mild cleaner diluted with water and then wipe with a dry cloth.

Warranty

YADA LIMITED WARRANTY

YADA warrants, to the original purchaser, that its products are free from defects in material and workmanship for 1 year from the date of original purchase. Where permitted by law, YADA's liability shall be limited to that set forth in this limited express warranty. This limited express warranty shall be the exclusive remedy of the purchaser and YADA makes no other warranty of any kind aside from the limited express warranty stated above.

Note: Warranty only applies for North American customers of purchases made in North America.

CONDITIONS OF WARRANTY

If during the 1 year warranty period your new product is found to be defective, YADA will repair such defect, or replace the product, without charge for parts or labor subject to the following conditions:

1. All repairs must be performed by YADA.
2. All warranty claims must be accompanied by a copy of the sales receipt or bill of sale.
3. The equipment must not have been altered or damaged through negligence, accident, improper operation, or failure to follow the product instructions for installation, use, or care.
4. The replacement of parts is excluded from the warranty when replacement is necessary due to normal wear and tear.
5. Repair or replacement parts supplied by YADA under this warranty are protected only for the unexpired portion of the original warranty.
6. This is a “repair or replace” warranty only, and does not cover the costs incurred for the installation, removal or reinstallation of the product, or damage to any mobile phone device or vehicle.

OWNER’S RESPONSIBILITIES:

YADA will make every effort to provide warranty service within a reasonable period of time. SHOULD YOU HAVE ANY QUESTIONS ABOUT SERVICE RECEIVED OR IF YOU WOULD LIKE ASSISTANCE IN OBTAINING SERVICE, PLEASE CALL TOLL FREE 1.866.294.9244 DURING REGULAR BUSINESS HOURS MONDAY THROUGH FRIDAY 8:00 AM TO 5:00PM.

Note: Toll Free # is for North America Customers ONLY. See Customer service section for customer contact numbers for other regions/offices.

For customer service and technical support, please call us at 1.866.294.9244. If at that time it is determined that a replacement unit is

needed, the support representative will issue a Return Authorization and instruct on how to get a new unit.

YADA makes no other warranty of any kind aside from the limited express warranty stated herein.

DISCLAIMER OF WARRANTIES, INCLUDING WARRANTY OF MERCHANTABILITY AND WARRANTY OF FITNESS FOR PARTICULAR PURPOSE: EXCEPT AS SPECIFICALLY SET FORTH HEREIN, NO WARRANTY OR REPRESENTATION, EXPRESS OR IMPLIED, IS MADE AS TO THE 1080P ROADCAM. EXCEPT AS EXPRESSLY SET FORTH HEREIN, YADA AND/OR ITS AFFILIATES EXPRESSLY DISCLAIMS, WITHOUT LIMITATION, ANY STATUTORY WARRANTIES AND ALL IMPLIED WARRANTIES, INCLUDING ANY IMPLIED WARRANTY OF MERCHANTABILITY OR FITNESS FOR A PARTICULAR PURPOSE.

YADA and/or its affiliates do not guarantee or promise that the user of 1080P Roadcam will not be in an accident or otherwise not collide with an object and/or person. Our 1080P Roadcam is not intended in any way to be a substitute for careful and cautious driving or for the consistent adherence to all applicable traffic laws and motor vehicle safety regulations.

The 1080P Roadcam is not intended to be a substitute for rearview mirrors or for any other motor vehicle equipment mandated by law. Even when properly installed, our 1080P Roadcam has a limited field of vision and does not provide a comprehensive view of the rear area of the vehicle.

YADA and/or its affiliates are not responsible for a user's intended or actual use of the 1080P Roadcam. In no event shall YADA and/or its affiliates have any liability for any losses (whether direct or indirect, in contract, tort or
20 otherwise) incurred in connection with the 1080P Roadcam, including but

not limited to damaged property, personal injury and/or loss of life. Neither shall YADA and/or its affiliates have any liability for any decision, action or inaction taken by any person in reliance on the 1080P Roadcam, or for any delays, inaccuracies and /or errors in connection with the 1080P Roadcam and its functioning.

YADA and/or its affiliates shall have no responsibility or liability for damage and/or injury resulting from accidents occurring with vehicles having the installed, and YADA and/or its affiliates, the manufacturer, distributor and seller shall not be liable for any injury, loss or damage, incidental or consequential, arising out of the use or intended use of the product.

GENERAL INFORMATION

Customer Service/Contact

IF YOU ARE EXPERIENCING ANY ISSUES WITH THE PRODUCT DURING OPERATION, DO NOT RETURN THE PRODUCT TO THE STORE. CONTACT YADA DIRECTLY FOR INSTRUCTIONS ON HOW TO RETURN/ EXCHANGE THE PRODUCT.

FCC Compliance Statement:

This device complies with Part 15 of the FCC rules. Operation is subject to the following two conditions: (1) This device may not cause harmful interference, and (2) this device must accept any interference received, including interference that may cause undesired operation.

Warning: Changes or modifications to this unit not expressly approved by the party responsible for compliance could void the user's authority to operate the equipment. The manufacturer is not responsible for any radio or TV interference caused by unauthorized modifications or change to this equipment. Such modifications or change could void the user's authority to operate the equipment.

Note: This equipment has been tested and found to comply with the limits for Class B digital device, pursuant to part 15 of the FCC Rules. These limits are designed to provide reasonable protection against harmful interference in a residential installation. This equipment generates, uses and can radiate radio frequency energy and, if not installed and used in accordance with the instructions, may cause harmful interference to radio or television reception, which can be determined by turning the equipment or and on, the user is encouraged to try to correct the interference by one or more of the following measures:

- Reorient or relocate the receiving antenna.
- Increase the separation between the equipment and the receiver.
- Connect the equipment into an outlet on a circuit different from that to which the receiver is connected.
- Consult the dealer or an experienced radio/TV technician for help.

⚠ WARNING: This product can expose you to chemicals including Di(2-ethylhexyl)phthalate (DEHP) and Diisononyl Phthalate (DINP), which are known to the State of California to cause cancer and birth defects or other reproductive harm. For more information go to www.P65Warnings.ca.gov.

1080P Roadcam

BT58186

Responsible Party:

YADA

2975 Red Hill Ave., Ste. 100, Costa Mesa, CA 92626

22 Tel: 1.866.294.9244



Product code / Code de produit / Código del producto : BT58186

Register this product within 30 days of purchase to receive one **(1) additional year** of warranty coverage (beyond the standard 1-year warranty), along with special product offers and announcements.

Enregistrez ce produit dans les 30 jours suivant l'achat pour recevoir une couverture **supplémentaire de 1 AN** (au-delà de la garantie standard d'un an), ainsi que des offres et des annonces spéciales.

Registre este producto dentro de los 30 días siguientes a la compra para recibir un **(1) año adicional** de cobertura de garantía (más allá de la garantía estándar de un año), junto con ofertas de productos y anuncios especiales.

www.letsyada.com/register



@letsyada



Please contact our customer service before returning this product to the store. Our friendly representatives are happy to help with any questions or concerns you have.

Veuillez communiquer avec notre service à la clientèle avant de retourner le produit au magasin. Nos représentants se feront un plaisir de vous assister pour toute question ou préoccupation.

Póngase en contacto con nuestro servicio a clientes antes de regresar este producto a la tienda. A nuestros amables representantes les dará mucho gusto ayudarlo con cualquier pregunta o inquietud que tenga.

Mon-Fri, 8am-5pm PST / Lundi au vendredi, 8h à 17h HNP / Lun-vie, 8 a. m. a 5 p. m. Hora del Pacífico
customer care@horizon-brands.com / 1.866.294.9244



CONNECT
WITH US



@letsyada

2975 Red Hill Ave., Ste. 100, Costa Mesa, CA 92626
1.866.294.9244 | customercare@horizon-brands.com

© 2021 ADC Solutions Auto, LLC.

www.letsyada.com

ML-58186_V1