



# ROADCAM DUAL

**Dual Lens Dashcam with App Control**



BT532968

## **User Manual**

**Important, retain for future reference:  
Read carefully**

# QUICK INSTALLATION GUIDE

Before you begin the installation, please gather these items.

1

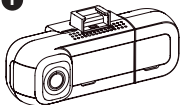

2



3



## 1. Mounting the Camera

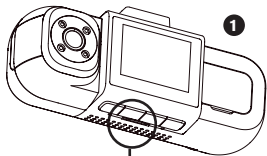

MicroSD Card  
(Factory-Installed)

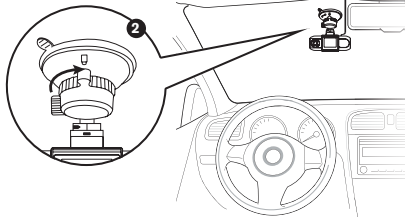

2

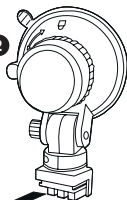

1

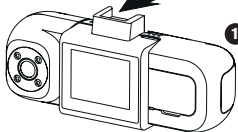

## 2. Connecting to Power

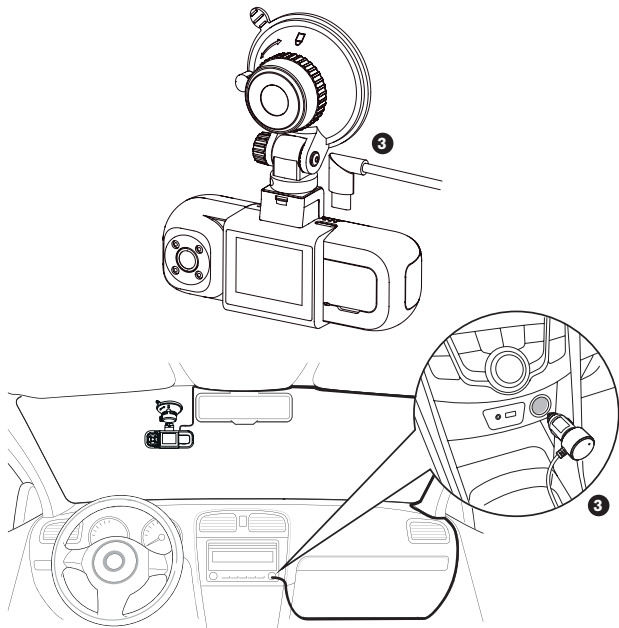

## INTRODUCTION

Please carefully review all installation instructions before installing the product. Improper installation may void the manufacturer's warranty. These instructions are not applicable to all vehicle types and are provided as guidelines to aid in product installation.

If you require assistance with camera installation, please feel free to either consult an experienced technician or reach out to YADA customer support at **1.866.294.9244**.

**BEFORE using the camera, please read the safety information in this manual, and always follow the guidelines outlined in it while using the product.**

Please make sure you've read and understood local laws and regulations regarding cameras in vehicles, as these laws can vary by state.

## PRODUCT SPECIFICATIONS

<b>Display:</b>	1.5"
<b>Lens (View Angle):</b>	Front View Camera - 135° Cabin View Camera - 115°
<b>Video Resolution:</b>	FHD 1080P (1920x1080) / 30 FPS
<b>Memory Card:</b>	MicroSD (up to 64GB)
<b>Audio Recording:</b>	Yes (can be turned on/off)
<b>Built-in Speaker:</b>	Yes
<b>Operating Temperature:</b>	14°F~ 140°F (-10°C~60°C)
<b>Operating Voltage:</b>	DC 12/24V / DC 5V (USB-C)
<b>Battery:</b>	Built-in 300 mAh Li-ion battery

# PACKAGE CONTENTS

1. 1 x Roadcam Dual
2. 1 x Windshield Mount
3. 1 x 16GB MicroSD Card (Factory-installed, replaceable)
4. 1 x 12/24V Power Adapter
5. 1 x Instruction Manual

**1**

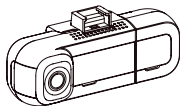

**2**



**3**



**4**

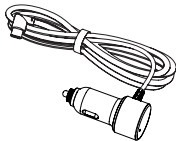

**5**

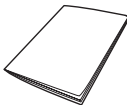

# PRODUCT OVERVIEW

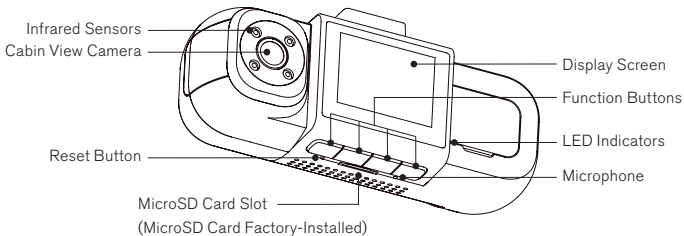
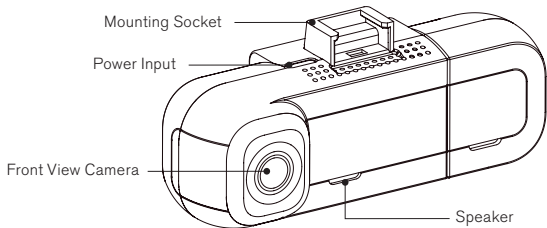

## CONTROLLING THE CAMERA

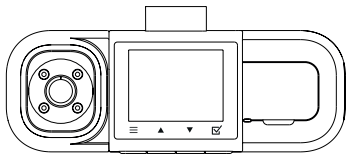

- ☰ Menu / Delete/Protect (press & hold)  
Mode / Lock / Return / (click once)
- ▲ Navigation UP / Switch View (click once)
- ▼ Navigation DOWN /  
Audio Recording ON/OFF (click once)
- ☑ Power ON/OFF (press & hold)  
OK / Record/Stop Recording /  
Snapshot / Play/Pause (click once)

## DIMENSIONS

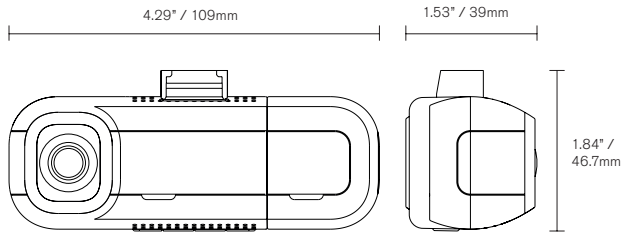

## INSTALLING THE CAMERA

1. Remove the protective film from the display screen.
2. Attach the windshield mount securely into the socket on the camera.

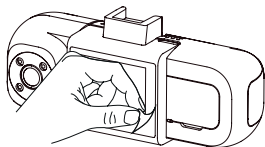

**NOTE:** To remove the windshield mount, push the lever inward and slide the mount out of the socket.

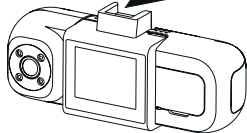
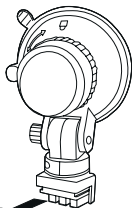

3.

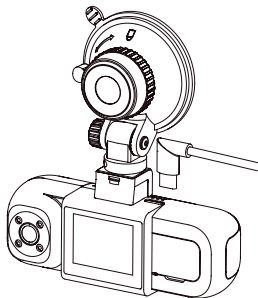

Connect the USB-C power cable to the input port on the camera.

**NOTE:** Please test the camera by connecting it to a power source before mounting.



4.

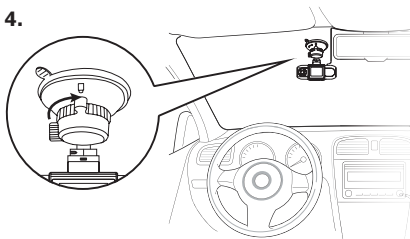

Mount the camera onto the windshield. You can power on the camera and view the live screen to find the optimal mounting position. Use the knobs on the mount to secure the suction cup firmly in place.

**WARNING:** Avoid installing the product in a position that may obstruct the driver's line of sight.

5. Adjust the Cabin View Camera's position to get the best interior view.

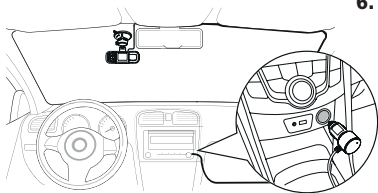
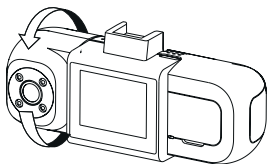

6. Route the power cable through the headliner and pillars inside your vehicle. Connect the power adapter to your vehicle's 12/24V DC outlet. To ensure it doesn't obstruct the driver while driving, we recommend passing it through the passenger side.

# CONFIGURING THE MENU SETTINGS





## Initial Setup

Set the date & time before using the camera. The date stamps that appear on all future recordings will follow this setting. You may also sync the date & time to your phone by connecting the camera to the YADA Drive APP.



## Switching Modes

Click  to switch between video mode, camera mode, and gallery mode. Please note that you'll need to stop recording first in order to switch modes.

## Video Mode

- This is the default recording setting; the camera will start recording automatically once it is powered on.
- By default, videos are recorded in 1-minute segments and saved onto the MicroSD card. When the memory reaches capacity, new videos will overwrite the old ones.
- Start/Stop Recording: click .
- Lock video: click  while the camera is recording to lock the current file.
- Click  to switch between front, cabin and picture-in-picture view.
- Click  to turn audio recording on/off.

## Camera Mode

- Click  to take a photo.
- Click  to switch between front, cabin and picture-in-picture view.

## Gallery Mode

- Utilize ▲ and ▼ to browse through individual video files or photos in full screen.
- Click  to select and play the video file.
- During video playback, click  to pause/resume the video.
- Press and hold ≡ to select file management options:

**Delete:** Delete the selected file.

**Protect:** Protect the file from getting deleted.

## Video Setting

Click  in video mode to stop recording, then press and hold ≡ to access the video setting page.

**Loop Record:** 1 Min, 3 Mins or 5 Mins.

**Exposure:** +2, +1, 0, -1 or -2.

**Motion Detection:** ON or OFF.

**Microphone:** ON or OFF.

**G-Sensor:** Low, Medium, High or OFF.

## Camera Setting

Press and hold  in camera mode to access the camera setting page.

**Resolution:** 12M (4032x3024) or 5M (2592x1944).

**Burst Photo:** ON or OFF.

**Exposure:** +2, +1, 0, -1 or -2.

## System Setting

Click  in video setting page or camera setting page to access the system setting page.

**Parking Monitor:** ON or OFF.

**Date/Time:** Set the date and time.

**Screen Save:** 1 Min, 3 Mins, 5 Mins or OFF.  
(Screen will dim to a digital clock interface after the specified time you select.)

**Beep Sound:** ON or OFF.

**Boot Sound:** ON or OFF.

**WiFi Control:** ON or OFF.

**Date Stamp:** ON or OFF.

**Plate Number:** Enter your vehicle license plate number here..

**Frequency:** 50Hz or 60Hz.

**Format:** Select to erase all data stored on the MicroSD card.

**Default Setting:** Reset settings to factory defaults.

**Version:** Show current firmware version.

**Regulatory Info:** Show regulation related information.

## DOWNLOADING THE APP



The auto-sync feature in the YADA Drive APP allows you to

- 1) Synchronize the camera's time with your phone's time,
- 2) Manage the camera's functions from your phone, and
- 3) View and download recorded videos.

To access this feature, scan the QR code below or search for "YADA Drive" on the APP Store or Google Play. Download and install the APP.



Compatible with iPhone, iPad, Mac and iPod touch running iOS 11 or higher.



Compatible with devices running Android™ 7.0 or higher.

# SETTING UP THE APP

## Auto-sync with the camera

1. Open the camera's menu and navigate to the system setting page.
2. Go to "WiFi Control" and turn it on.

**NOTE:** WiFi is ON by default.

## Android Device

3. Navigate to the WiFi setting page on your device.
4. Connect to "YADA\_DVR19\_1080P\_xxxxxx" with the default password "12345678".
5. Run the YADA Drive APP. Click "Allow" in the pop-up message when prompted to allow the APP to access your location.

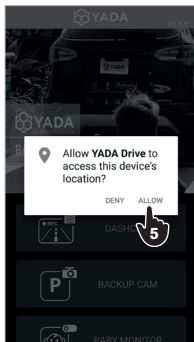
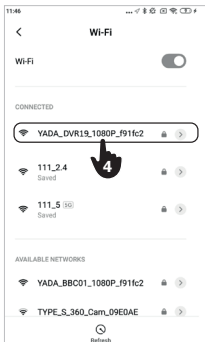
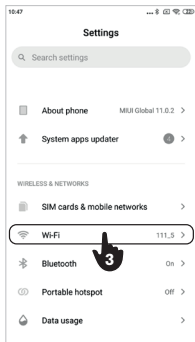

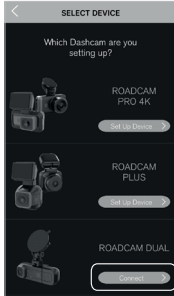
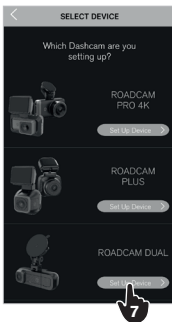

6. Select the “DASHCAM” category.
7. Select ROADCAM DUAL and click “Set Up Device”.
8. Once connected, you will be able to see the camera’s live view through the APP.

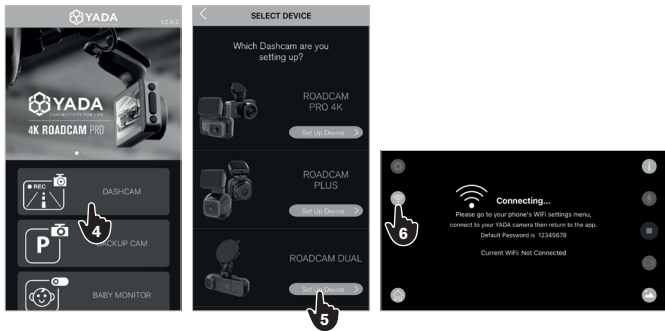

**NOTE:** After the initial sync, the APP remembers your camera’s network so that you can simply click “Connect” to rejoin next time.

## iOS Device (Follow Steps 1-2 from previous instructions)



3. Please make sure Bluetooth, Location Services and Local Network Access are enabled on your device.
4. Run the YADA Drive APP and select the "DASHCAM" category.
5. Select ROADCAM DUAL and click "Set Up Device".
6. Click  to go to APP permissions setting page.
7. Click "Settings" on the APP permissions setting page.

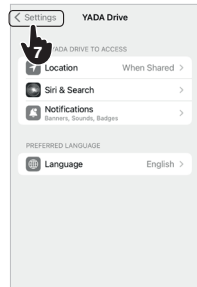



8. Scroll to the top and click to enter the WiFi setting page.
9. Connect to “YADA\_ DVR19\_1080P\_XXXXXX” with the default password “12345678”.
10. Click “YADA Drive” to return to the APP.
11. Once connected, you will be able to see the camera’s live view through the APP.

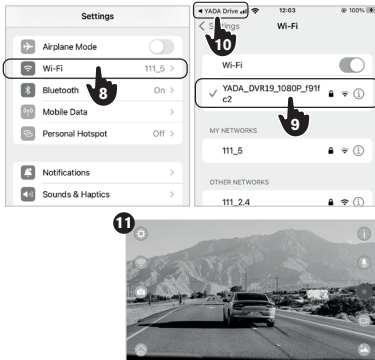

## ADDITIONAL FEATURES

### Automatic ON / OFF

When the camera is connected to the vehicle’s power, it will power on and start recording when the vehicle engine starts. When the engine is off, the camera will stop recording and power off automatically.

### Smart Incident Recording

When the G-Sensor detects a sudden impact such as collision, it’ll automatically lock and store the footage in the “Event” folder so that it doesn’t get overwritten by the loop record feature

**NOTE:** The G-Sensor sensitivity can be adjusted in the video setting page according to actual needs.

## Park & Record Mode

The Park & Record mode allows the camera to record videos when an impact is detected while the vehicle's engine is off. The camera will power on automatically and record a 20-second video clip then shut down.

**NOTE:** The camera will switch to Park & Record mode when the vehicle's engine is off.

## Night Vision

The Night Vision mode will apply automatically under low-light conditions, providing a brightened and black-and-white display for optimal visibility.

**NOTE:** Feature supported by Cabin View Camera only.

## BATTERY LEVEL INDICATIONS

Please refer to the diagram below for battery level indications.



Fully charged



Battery moderately low



Battery low



Please charge



Charging

**NOTE:** The camera is intended to be powered on when the vehicle is running. The built-in battery's primary purpose is to ensure the camera shuts down correctly when you turn off the vehicle, rather than running the camera extensively. For everyday use, ensure that the camera remains connected to your vehicle's power source continuously.

## FAQs

- 1) Problem: The camera is unable to take pictures or record videos.  
Solution: Please try formatting the MicroSD card (Menu – System Setting – Format).
- 2) Problem: The camera is showing that the memory card is full.  
Solution: Please 1) Switch the G-Sensor to “Medium” or “Low”, 2) Turn off the Motion Detection, and 3) Take the MicroSD card out and clear the “Event” folder manually via your computer.
- 3) Problem: Message showing “SD card error”.  
Solution: Please try formatting the MicroSD card (Menu – System Setting – Format).
- 4) Problem: The image or video looks foggy.  
Solution: Please 1) Make sure that you've removed the protective film cover on the camera lens, and 2) Try wiping the camera lens.
- 5) Problem: The image or video is too dark.  
Solution: Please try adjusting the exposure level (Menu – Video Setting / Camera Setting – Exposure).
- 6) Question: Can I buy and use my own MicroSD memory card?  
Answer: Yes, but please make sure that you purchase one that's U1 rated with the max capacity of 64GB.

# SAFETY INFORMATION

## IMPORTANT SAFETY INSTRUCTIONS

1. **SAVE THESE INSTRUCTIONS** – This manual contains important safety and operating instructions of the 12/24V cigarette lighter adapter for Model BT532968.
2. Before using the product, read all instructions and cautionary markings.
3. Do not expose cigarette lighter adapter to rain, moisture, or snow.
4. Use of an attachment not recommended or sold by the product manufacturer may result in a risk of fire, electric shock, or injury to persons.
5. To reduce risk of damage to cigarette lighter connector and cord, pull by cigarette lighter connector rather than cord when disconnecting cigarette lighter adapter.
6. Make sure cord is carefully secured so that it will not be stepped on, tripped over, or otherwise subjected to damage or stress.
7. Do not operate cigarette lighter adapter with damaged cord or cigarette lighter connector – replace it immediately.
8. Do not operate cigarette lighter adapter if it has received a sharp blow, been dropped, or otherwise damaged in any way; take it to a qualified serviceperson.
9. Do not disassemble cigarette lighter adapter; take it to a qualified serviceperson when service or repair is required. Incorrect reassembly may result in a risk of electric shock or fire.
10. To reduce risk of electric shock, unplug cigarette lighter adapter before attempting any maintenance or cleaning. Turning off controls will not reduce this risk.

**WARNING:** A failure to read and follow these warnings and instructions may result in a serious accident, including damaged property or a serious injury, including loss of life.

- The Roadcam Dual is designed as an aid to the driver in detecting large stationary objects to help avoid damaging the vehicle. However, you, the driver, must use it safely and properly. Use of the Roadcam Dual is not a substitute for safe, proper and legal driving.
- Never depend on the Roadcam Dual entirely when driving. The image on the screen is different from actual conditions. Objects viewed in the Roadcam Dual display screen differ from actual distance because a wide-angle lens is used.
- The Roadcam Dual "Night Vision" feature that is high performance brightness with colorful image is an aid to a driver but is limited. Always use your own eyes to confirm the vehicle's surroundings, as the displayed image may be faint or dark, distorted, or not entirely visible.
- Always check behind and all around the vehicle visually with mirrors before proceeding.
- The area displayed by the Roadcam Dual is limited. The Roadcam Dual does not display objects that are out of the camera's field of view. The area displayed on the screen may vary according to vehicle orientation or road conditions.
- Be sure to check the camera's position and mounting angle before each use.
- Do not strike the Roadcam Dual. It is a precision instrument. Otherwise, it may malfunction or cause damage resulting in a fire or an electric shock.
- This product will only provide images of items that are within the field of view of the Roadcam Dual. Thus, it is imperative that the Roadcam Dual should be kept clean and unobstructed.
- Adhere to all applicable traffic laws and motor vehicle regulations applicable to the device.

- Consult local laws and regulations for any restrictions on installation or use.
- Never allow children to play with the device. Small parts may be a choking hazard.
- There is a plastic cover over the Roadcam Dual. Do not scratch the cover when cleaning dirt or snow from it.
- If the temperature changes rapidly, the system may not operate normally.
- When strong light directly enters a camera, objects may not be displayed clearly.
- The screen may flicker under fluorescent light.
- The colors of objects on the Roadcam Dual may differ from those of the actual objects.
- Do not use alcohol or thinner to clean the camera. This will cause discoloration. To clean the camera, wipe with a clean cloth dampened with mild cleaner diluted with water and then wipe with a dry cloth.

## **Safety Around and Behind Other Vehicles**

Using a Roadcam Dual is not enough to completely overcome a vehicle's blind spot. Many preventable injuries and deaths occur in driveways or parking lots when drivers do not see children, pets, or others near their vehicles. Here are a few safety tips that will help you to avoid an accident:

- Walk completely around your vehicle before getting in. Check for kids, toys, and pets before entering the vehicle and starting the engine.
- Know where children are. Have children stand in a place where they are in full view.
- Be aware of young children. Young children are small and hard to see.
- Parents, caregivers and all adults need to be vigilant in supervising children, especially when children are in the yard, driveway or parking lot playing near parked cars.

- Roll down your window so you will be able to hear what is happening outside your vehicle.
- Owners of SUVs, trucks, and vans need to take extra care to avoid hitting or running over a child.
- Teach children to move away from a vehicle whenever it is started.

## **MAINTENANCE & WARRANTY**

### **Cleaning**

- If dirt, rain or snow attaches to the camera, the display screen may not clearly display objects. If water droplets, snow or mud adhere to the camera lens, rinse with water and wipe with a dry cloth.
- Do not use alcohol, benzene or thinner to clean the camera. This will cause discoloration. To clean the camera, wipe with a clean cloth dampened with mild cleaner diluted with water and then wipe with a dry cloth.

### **Warranty**

#### **YADA LIMITED WARRANTY**

YADA warrants, to the original purchaser, that its products are free from defects in material and workmanship for 1 year from the date of original purchase. Where permitted by law, YADA's liability shall be limited to that set forth in this limited express warranty. This limited express warranty shall be the exclusive remedy of the purchaser and YADA makes no other warranty of any kind aside from the limited express warranty stated above.

**NOTE:** Warranty only applies for North American customers of purchases made in North America.

## **CONDITIONS OF WARRANTY**

If during the 1 year warranty period your new product is found to be defective, YADA will repair such defect, or replace the product, without charge for parts or labor subject to the following conditions:

1. All repairs must be performed by YADA.
2. All warranty claims must be accompanied by a copy of the sales receipt or bill of sale.
3. The equipment must not have been altered or damaged through negligence, accident, improper operation, or failure to follow the product instructions for installation, use, or care.
4. The replacement of parts is excluded from the warranty when replacement is necessary due to normal wear and tear.
5. Repair or replacement parts supplied by YADA under this warranty are protected only for the unexpired portion of the original warranty.
6. This is a “repair or replace” warranty only, and does not cover the costs incurred for the installation, removal or reinstallation of the product, or damage to any mobile phone device or vehicle.

## **OWNER’S RESPONSIBILITIES:**

YADA will make every effort to provide warranty service within a reasonable period of time. SHOULD YOU HAVE ANY QUESTIONS ABOUT SERVICE RECEIVED OR IF YOU WOULD LIKE ASSISTANCE IN OBTAINING SERVICE, PLEASE CALL TOLL FREE 1.866.294.9244 DURING REGULAR BUSINESS HOURS MONDAY THROUGH FRIDAY 8:00 AM TO 5:00PM.

Note: Toll Free # is for North America Customers ONLY. See Customer service section for customer contact numbers for other regions/offices.

For customer service and technical support, please call us at  
24 1.866.294.9244. If at that time it is determined that a replacement unit is



needed, the support representative will issue a Return Authorization and instruct on how to get a new unit.

YADA makes no other warranty of any kind aside from the limited express warranty stated herein.

DISCLAIMER OF WARRANTIES, INCLUDING WARRANTY OF MERCHANTABILITY AND WARRANTY OF FITNESS FOR PARTICULAR PURPOSE: EXCEPT AS SPECIFICALLY SET FORTH HEREIN, NO WARRANTY OR REPRESENTATION, EXPRESS OR IMPLIED, IS MADE AS TO THE ROADCAM DUAL. EXCEPT AS EXPRESSLY SET FORTH HEREIN, YADA AND/OR ITS AFFILIATES EXPRESSLY DISCLAIMS, WITHOUT LIMITATION, ANY STATUTORY WARRANTIES AND ALL IMPLIED WARRANTIES, INCLUDING ANY IMPLIED WARRANTY OF MERCHANTABILITY OR FITNESS FOR A PARTICULAR PURPOSE.

YADA and/or its affiliates do not guarantee or promise that the user of Roadcam Dual will not be in an accident or otherwise not collide with an object and/or person. Our Roadcam Dual is not intended in any way to be a substitute for careful and cautious driving or for the consistent adherence to all applicable traffic laws and motor vehicle safety regulations.

The Roadcam Dual is not intended to be a substitute for rearview mirrors or for any other motor vehicle equipment mandated by law. Even when properly installed, our Roadcam Dual has a limited field of vision and does not provide a comprehensive view of the rear area of the vehicle.

YADA and/or its affiliates are not responsible for a user's intended or actual use of the Roadcam Dual. In no event shall YADA and/or its affiliates have any liability for any losses (whether direct or indirect, in contract, tort or otherwise) incurred in connection with the Roadcam Dual, including but

not limited to damaged property, personal injury and/or loss of life. Neither shall YADA and/or its affiliates have any liability for any decision, action or inaction taken by any person in reliance on the Roadcam Dual, or for any delays, inaccuracies and/or errors in connection with the Roadcam Dual and its functioning.

YADA and/or its affiliates shall have no responsibility or liability for damage and/or injury resulting from accidents occurring with vehicles having the installed, and YADA and/or its affiliates, the manufacturer, distributor and seller shall not be liable for any injury, loss or damage, incidental or consequential, arising out of the use or intended use of the product.

## **GENERAL INFORMATION**

### **Customer Service/Contact**

IF YOU ARE EXPERIENCING ANY ISSUES WITH THE PRODUCT DURING OPERATION, DO NOT RETURN THE PRODUCT TO THE STORE. CONTACT YADA DIRECTLY FOR INSTRUCTIONS ON HOW TO RETURN/ EXCHANGE THE PRODUCT.

FCC Compliance Statement:

This device complies with Part 15 of the FCC rules. Operation is subject to the following two conditions: (1) This device may not cause harmful interference, and (2) this device must accept any interference received, including interference that may cause undesired operation.

**WARNING:** Changes or modifications to this unit not expressly approved by the party responsible for compliance could void the user's authority to operate the equipment. The manufacturer is not responsible for any radio  
26 or TV interference caused by unauthorized modifications or change to this

equipment. Such modifications or change could void the user's authority to operate the equipment.

**NOTE:** This equipment has been tested and found to comply with the limits for a Class B digital device, pursuant to part 15 of the FCC Rules. These limits are designed to provide reasonable protection against harmful interference in a residential installation. This equipment generates, uses and can radiate radio frequency energy and, if not installed and used in accordance with the instructions, may cause harmful interference to radio communications. However, there is no guarantee that interference will not occur in a particular installation. If this equipment does cause harmful interference to radio or television reception, which can be determined by turning the equipment off and on, the user is encouraged to try to correct the interference by one or more of the following measures:

- Reorient or relocate the receiving antenna.
- Increase the separation between the equipment and the receiver.
- Connect the equipment into an outlet on a circuit different from that to which the receiver is connected.
- Consult the dealer or an experienced radio/TV technician for help.

This equipment complies with FCC RF radiation exposure limits set forth for an uncontrolled environment. In order to avoid the possibility of exceeding the FCC radio frequency exposure limits, human proximity to the antenna shall not be less than 20cm during normal operation.

 **WARNING:** This product can expose you to chemicals including Di(2-ethylhexyl)phthalate (DEHP) and Diisononyl Phthalate (DINP), which are known to the State of California to cause cancer and birth defects or other reproductive harm. For more information go to [www.P65Warnings.ca.gov](http://www.P65Warnings.ca.gov).

Android is a trademark of Google Inc.  
iPhone, iPad, Mac and iPod touch are trademarks of Apple Inc.

Roadcam Dual  
Dual Lens Dashcam with App Control  
BT532968

Responsible Party:

YADA

2975 Red Hill Ave., Ste. 100,  
Costa Mesa, CA 92626

Tel: 1.866.294.9244



**Product code / Code de produit / Código del producto : BT532968**

Register this product within 30 days of purchase to receive one **(1) additional year** of warranty coverage (beyond the standard 1-year warranty), along with special product offers and announcements.

Enregistrez ce produit dans les 30 jours suivant l'achat pour recevoir une couverture **supplémentaire de 1 AN** (au-delà de la garantie standard d'un an), ainsi que des offres et des annonces spéciales.

Registre este producto dentro de los 30 días siguientes a la compra para recibir un **(1) año adicional** de cobertura de garantía (más allá de la garantía estándar de un año), junto con ofertas de productos y anuncios especiales.

[www.letsyada.com/register](http://www.letsyada.com/register)



@letsyada



Please contact our customer service before returning this product to the store. Our friendly representatives are happy to help with any questions or concerns you have.

Veuillez communiquer avec notre service à la clientèle avant de retourner le produit au magasin. Nos représentants se feront un plaisir de vous assister pour toute question ou préoccupation.

Póngase en contacto con nuestro servicio a clientes antes de regresar este producto a la tienda. A nuestros amables representantes les dará mucho gusto ayudarlo con cualquier pregunta o inquietud que tenga.

**Mon-Fri, 8am-5pm PST / Lundi au vendredi, 8h à 17h HNP / Lun-vie, 8 a. m. a 5 p. m. Hora del Pacífico**  
[customer care@horizon-brands.com](mailto:customer care@horizon-brands.com) / 1.866.294.9244



**CONNECT  
WITH US**



**@letsyada**

2975 Red Hill Ave., Ste. 100, Costa Mesa, CA 92626  
1.866.294.9244 | [customercare@horizon-brands.com](mailto:customercare@horizon-brands.com)

© 2024 ADC Solutions Auto, LLC.

**[www.letsyada.com](http://www.letsyada.com)**

ML-532968E\_V1