

hang it
yourself™

Installation Instructions For Wood Stud Construction Only

Tools:

Included - 3/16" and 5/16" twist drill bits, #2 Square and #3 Phillips driver bits, and a 1/2" spade bit for the SnapToggles.

Needed – Protective eyewear, 3 ft. or longer level, measuring tape, hacksaw and a drill.

Recommended - Stud Finder

Caution: Protective eyewear should be worn when handling the aluminum rail and brackets. As with any manufactured metal product, there may be residual shavings from the fabrication process. The rail and brackets may have sharp edges as well; mechanics style gloves are recommended.

Hang-It-Yourself *Cabinet Hanging and Alignment System*

1 Finding the wall rail starting point.

1) a. On the wall(s) where the cabinets are to be installed, mark the cabinet layout endpoints with short vertical lines at eye level. Using a level, extend each layout endpoint line up the wall and mark a short vertical line that extends both a couple of inches above and below the height where you want the top of your cabinets to be located.

b. Within the cabinet layout space, find the high spot in the floor along the wall and mark the wall at this location. Then check the floor along a line located 2 feet out from the wall. If the high spot location changes, then use your level to transfer the new high spot over to the wall and mark the wall at the new location.

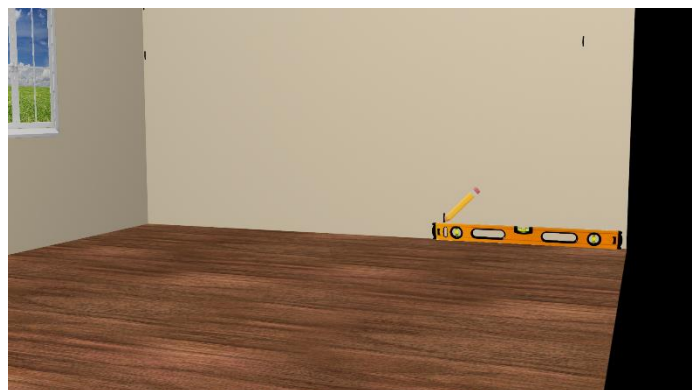

c. At the marked high spot just located, measure up the wall and make a short horizontal mark $13/16$ " above the height where you want the top of your wall cabinets to be located. This horizontal line marks the wall rail mounting hole height.

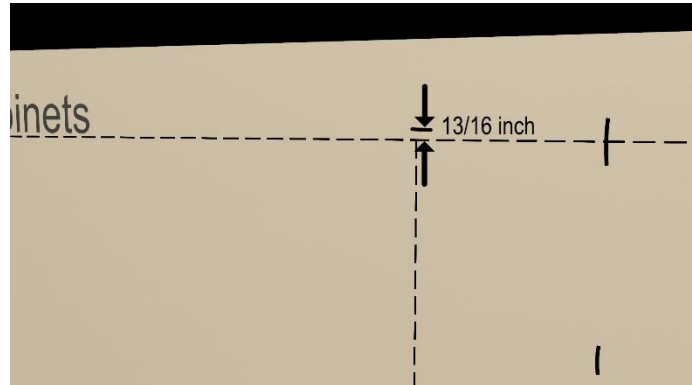

d. Using your level, extend this line over to where it intersects the closest one of the 2 cabinet layout endpoints.

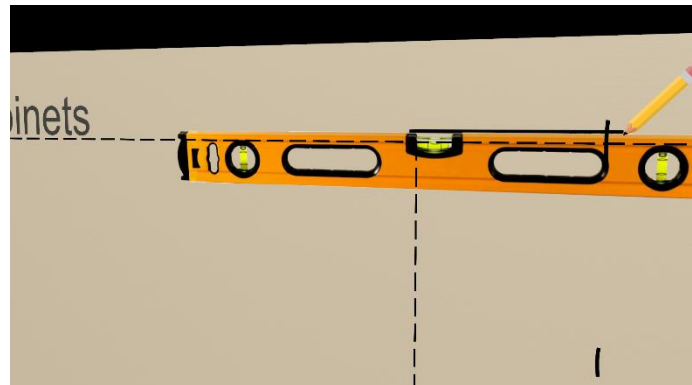

e. Along the horizontal line just made, locate the wall stud closest to the same cabinet layout endpoint and mark this stud's centerline.

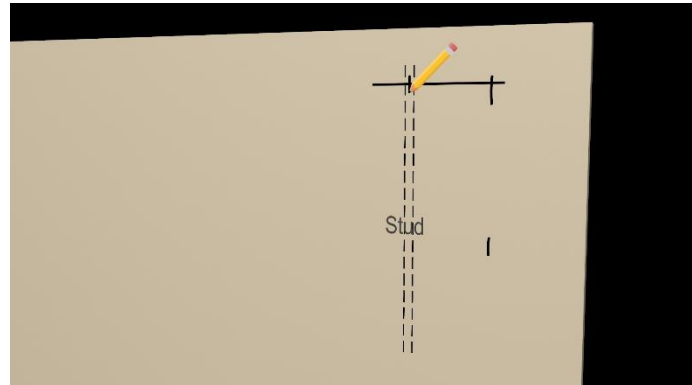

Caution: Protective eyewear should be worn when using any of the included drill/driver bits in a power tool.

2 Assembling and Installing the Wall Rail

2) a. Measure and cut the Hang-It-Yourself wall rail 2" shorter than the cabinet layout length. If you need to extend the rail by installing an additional rail that is less than 3 feet long to make up the total length of rail needed, it is recommended to trim the longer rail so that the added section is at least 3 feet long.

b. Set the rail on the wall within the cabinet layout space so that the rail mounting holes are centered over the mounting hole line. It would be helpful to install a nail or screw just below the rail near the center of the layout space to serve as a temporary rail support.

Adjust the rail so that the end that you are holding is located about 1" inward from the layout endpoint.

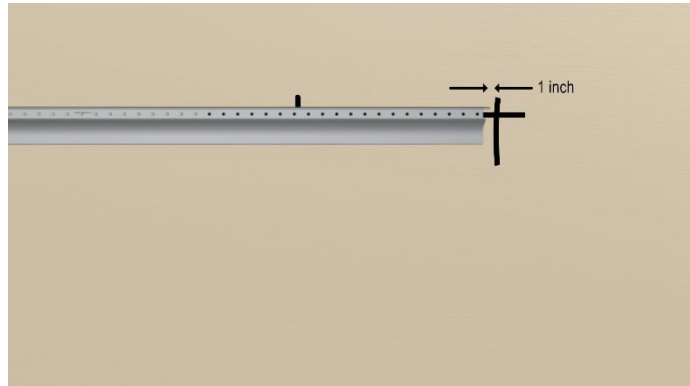

c. Install a black oxide 10 x 2" washer head screw through the wall rail hole into the wall stud whose centerline was just located. Tighten the screw so that the rail is snug but is able to pivot freely. Remove the nail or screw installed as a temporary support from the center of the layout space.

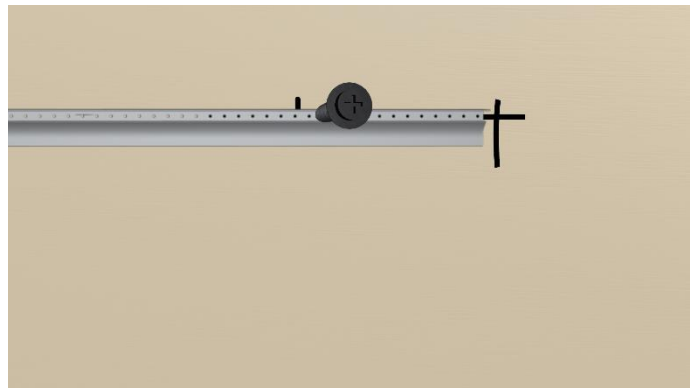

d. Place a level along the top of the wall rail. Adjust the rail until it is level and draw a line along the bottom edge of the rail.



e. Let the wall rail pivot downward to a resting point while locating the centers of the rest of the wall studs along the line just drawn.

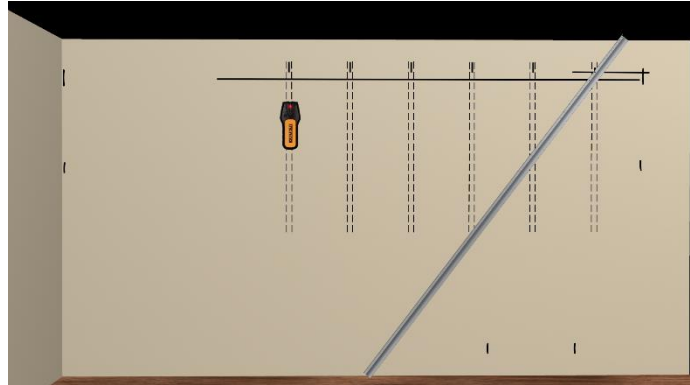

f. With the stud centers located, re-align the wall rail bottom edge on the level horizontal line just made and install another black oxide 10 x 2" washer head screw in a stud near the center of the rail and another screw in a stud near the end not yet attached, again making the screws snug but not tight.

If the layout includes an extension rail, butt the extension rail against the end of the rail already installed. Holding a level along the top of the installed rail and the extension rail, draw a line along the bottom of the extension rail and find the location of the studs along this line as you did for the main rail.

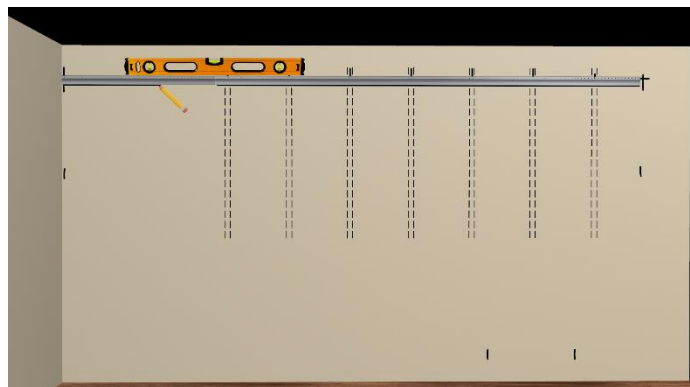

f. Before installing the rest of the black oxide 10 x 2" washer head screws, check the distance from the wall rail(s) ends to the closest wall stud at each end.

If the end of the wall rail extends more than 8" beyond the closest wall stud line, then mark the wall by tracing around the inside of the second to the last hole of the wall rails at the affected end of each wall rail section.

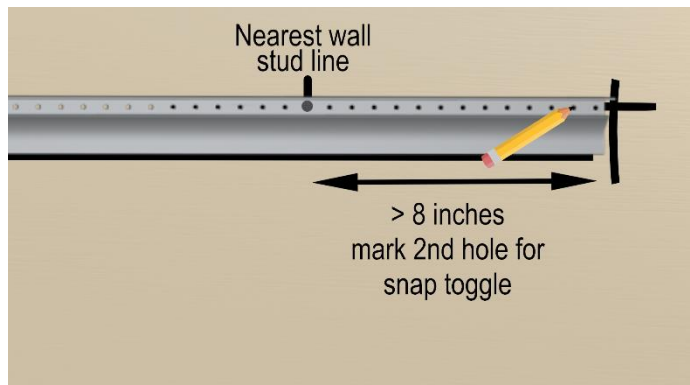

g. Remove all of the rail fasteners except for the first one installed and again let the wall rail pivot to a resting point while you install a Snaptoggle at the marked location(s). Snaptoggle installation instructions are provided separately in each installation kit and as a pdf file.

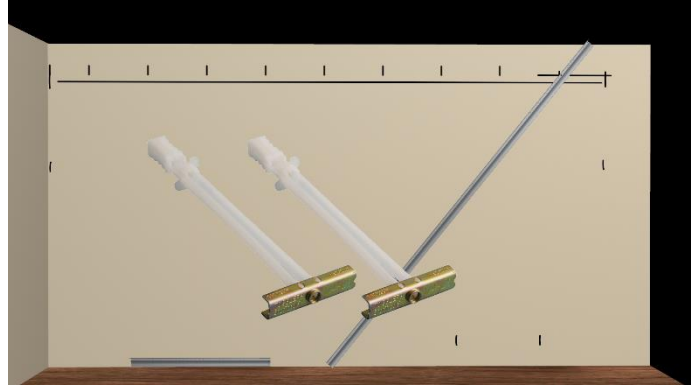

If the end of the wall rail extends 8" or less beyond the closest wall stud, then finish attaching the wall rail and the extension using the black oxide 10 x 2" washer head screws at each stud location, making the screws only snug for now.

3 Aligning the Wall Rail

Note: Before fully tightening the wall rail at each stud location, the Hang-It-Yourself wall rail needs to be checked for straightness along its length as noted below. A great advantage of using The HIY System is its ability to compensate for waviness in a wall by providing a straight and level hanging surface. This is especially critical when hanging frameless cabinets. Taking extra care in this step will further simplify the alignment of any type of cabinet.

3) a. Adjusting for low spots in the wall surface. Sight along the top of the wall rail from end to end, noting where there are low spots in the attachment points along the rail.

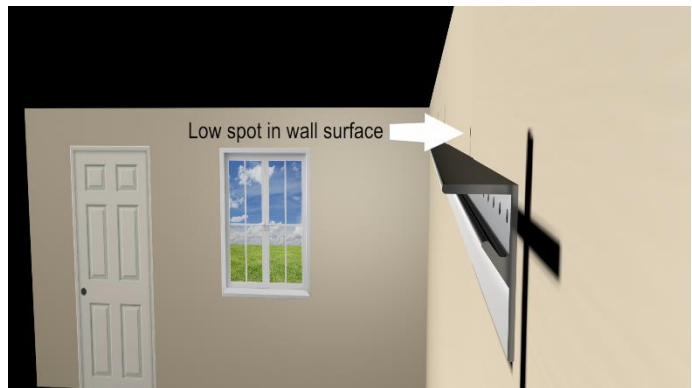

b. Loosen the rail attachment screws in these low areas and insert the provided plastic horseshoe style shims between the rail and the wall at the stud locations as needed to align the top of the rail in a straight manner. After shims have been added, all of the rail mounting screws should be tightened securely. Re-check the wall rail for straightness and levelness.



c. Adjusting for high spots in the wall. This is not done now but rather is accomplished when mounting the cabinet brackets. You simply note where on the wall that the high spot is located in the cabinet arrangement, identify the affected cabinet, and then adjust the location of the affected bracket, as needed, away from the high spot. If there is an extreme high spot it may be necessary to modify the wall at the high spot or separate the wall rail into two sections that stop short on each side of the high spot to enable the cabinets to be aligned.

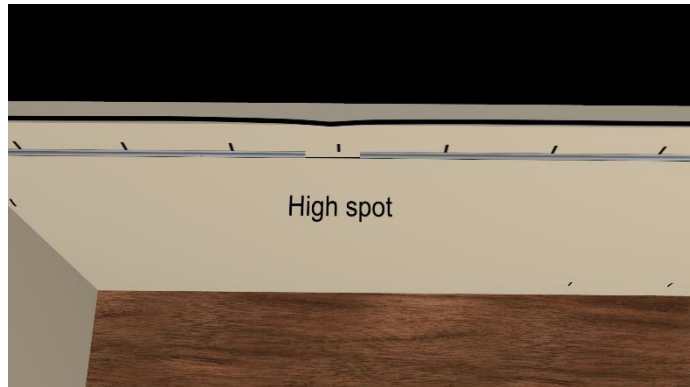

4 Attaching the Cabinet Brackets

Note: Most cabinet manufacturers recommend that their cabinets be fastened at a point slightly away from the inside vertical corners, **just below the top interior surface** of a cabinet and similarly at a point **just above the bottom interior surface** of a cabinet which typically corresponds with the center of the factory installed hanging reinforcement strips. These locations allow for a large surface area of strength at the top and bottom of a cabinet for holding purposes and reduce the chance of compromising the structural integrity of the cabinet. By design, the HIY cabinet bracket slot limits fastener placement to accommodate this factory hanging strip.

4) a. Take one of the cabinets that is part of a given wall layout, open the door and position a cabinet bracket on the front of the cabinet with the alignment leg resting on top as shown. Set a T- nut against the cabinet interior top finished surface alongside the bracket. Note the location closest to the top of the cabinet bracket that allows for the installation of the T-nut and mark the location of the T-nut center on the bracket at this point.



b. Take the bracket that you just marked and position it horizontally on the rear of a wall cabinet with the alignment leg resting on the side of the cabinet. Set the marked bracket about an inch down from the top of the cabinet and use the far edge of the bracket as a guide to draw a vertical line on the back of the cabinet. Repeat at the other end of the cabinet.

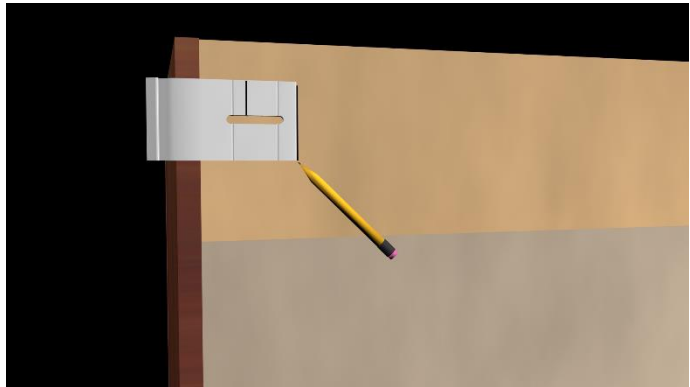

c. Now position the same bracket vertically with the alignment leg resting on the top of the cabinet and transfer the T-nut center mark onto the vertical line. Drill a 5/16" hole through the cabinet from the back. Repeat for the other cabinets.

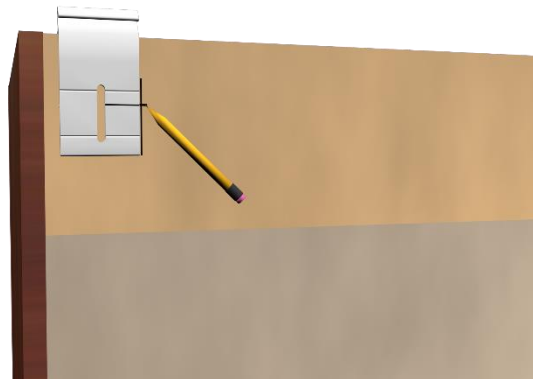

Note: If you have a corner cabinet that attaches to adjacent walls, mark for and install the brackets as shown at locations marked A on the cabinet.

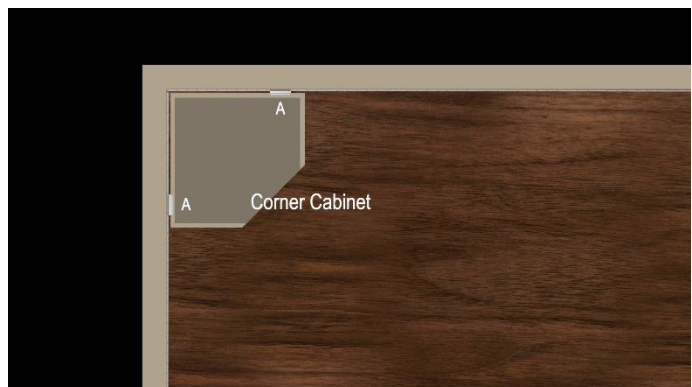

d. Open the cabinet door and press a T-nut into each of the drilled holes from the inside of the cabinet. Set a mounting bracket on top of the back of the cabinet with the alignment leg resting flat against the cabinet top. Insert the provided 1/4"-20 machine screw through the cabinet bracket, (employing an external tooth lockwasher on each side of the bracket to prevent slippage) and through the hole in the back of the cabinet until it engages the T-nut.



IMPORTANT: There are 3 different sizes of the 1/4"-20 screws. Be sure to use a length that enables complete or nearly complete engagement of the T-nut threads.

e. With the cabinet mounting bracket alignment leg resting **flat against the cabinet top**, tighten the screw so that the T-nut barbs engage the face of the cabinet interior rear surface. Repeat for the other cabinets. If you plan to use the decorative plastic T-nut covers, you can install them at this point.

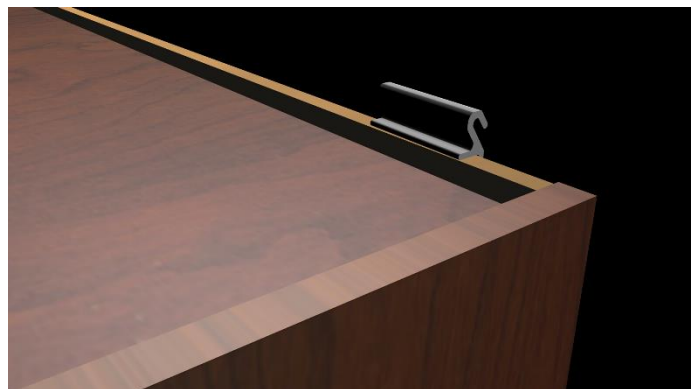

Note: Cabinets that are over 30 inches wide need additional equally spaced brackets. They should be installed so that there is no more than 24" between brackets on an individual cabinet. Typically, there are more than enough brackets included with each kit and additional individual brackets are available separately as well.

5 Mounting the Cabinets

If you are also installing base cabinets, it would be advantageous at this time to extend your wall stud locations down the wall and mark your wall around the 36" height off the floor.

Note: Framed style cabinets can be adjusted to work on out of square corners but frameless cabinets are less forgiving. Hang-It-Yourself can compensate for a slight out of squareness between adjacent walls but if they are too far out of square then additional alignment work may be needed to square adjacent walls.

5) a. Set a cabinet next to the wall near its pre-determined location. If you have a corner cabinet that attaches to adjacent walls, it should be installed first. Raise the cabinet to about chest height and then lean it against the wall allowing the brackets to contact the wall. With the bottom of the cabinet held slightly away from the wall, slide the cabinet up the wall.



b. The cabinet will move slightly away from the wall and then will quickly move toward the wall at which point you can stop the upward motion, allowing the brackets to engage the wall rail.



c. Make sure that the cabinet brackets have engaged the wall rail before releasing the cabinet.

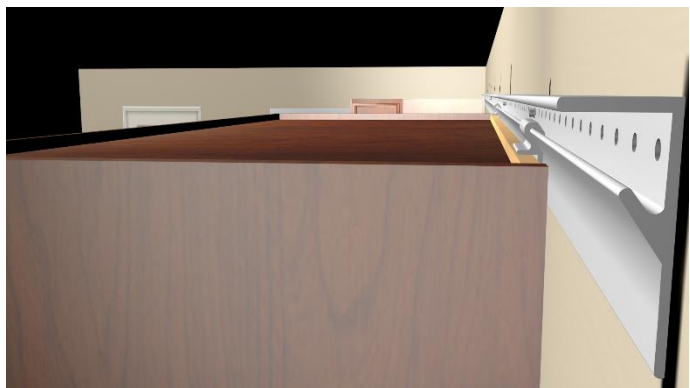

d. The location of the corner cabinet brackets at A will allow for the alignment of the adjacent cabinets on the walls in either direction. Once the corner cabinet is in place you can check the clearance between the cabinet and rail throughout the corner. If the walls are square, you can add other brackets at location B as in the diagram below. If the walls are out of square, you may only be able to attach brackets at the A locations or possibly at the A locations and only one B location.

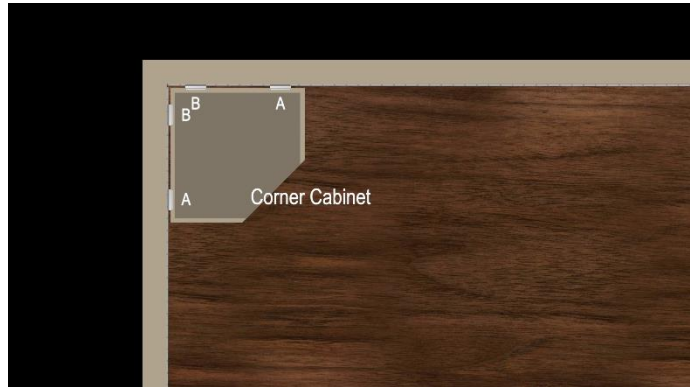

e. With the corner cabinet in place, now mount the rest of the cabinets. Once all of the cabinets are in place, they can be secured to one another either through the wooden face styles or just behind the faces through the cabinet sidewalls in accordance with the cabinet manufacturer's recommendation regarding adjacent cabinet attachment.

6 Installing Bottom Screws

6)a. Make sure that the stud location centers are again utilized for the bottom fastener attachment. Place a level on the front vertical face of the cabinets to determine how much the cabinets need to be shimmed away from the wall at the bottom rear wall of the cabinet to set the cabinet fronts plumb.



b. Drill 3/16" holes through the cabinet just above the bottom interior surface of the cabinet in alignment with the wall studs.



c. Again, using the provided horseshoe style shims for spacing, install 10 x 2 1/2" washer head screws through the cabinets' lower sections. The combed design allows them to slide up along and hold onto the bottom screws while adjustments are made.



Add your scribe and crown mouldings as desired to complete the project.

A detailed installation video is available at www.hiysystem.com

Questions? 833-EZY-HANG 833-399-4264