



la marzocco

strada ep guidebook

**an introduction to pressure profiling,
and a guide to the la marzocco strada ep**

rev. 1.1

Via La Torre 14/H
50038 Scarperia
Florence - ITALY

phone: +39 055 849 191
fax: +39 055 849 1990
www.lamarzocco.com

table of contents

This guide book is intended to be used in conjunction with the La Marzocco Profile Editor.

profileeditor.lamarzocco.com

| | | | |
|--|-----------|---|----|
| <i>introduction</i> | 3 | <i>grind</i> | 16 |
| <i>historic espresso technology</i> | 4 | <i>coffee dose & brew ratio</i> | 17 |
| <i>vertical boiler machines</i> | 5 | <i>temperature</i> | 18 |
| <i>piston lever machines</i> | 6 | <i>extraction time</i> | 19 |
| <i>rotary vane pump machines</i> | 7 | <i>pressure & flow</i> | 20 |
| <i>strada ep technology</i> | 8 | <i>initial stages of extraction</i> | 21 |
| <i>mechanical gear pump</i> | 9 | <i>the golden profile</i> | 22 |
| <i>membrane potentiometer</i> | 10 | <i>comparing coffee styles</i> | 23 |
| <i>electronic steam valve</i> | 11 | <i>high solubility/low density</i> | 24 |
| <i>brewing with the strada ep</i> | 12 | <i>medium solubility/medium density</i> | 25 |
| <i>our experience & research</i> | 13 | <i>classic espresso</i> | 26 |
| <i>clear objectives</i> | 14 | <i>in conclusion</i> | 27 |
| <i>identifying the variables</i> | 15 | | |

introduction

This guide is designed to serve as a foundation as you begin to use and explore the capabilities of the La Marzocco Strada EP, and pressure as a variable in espresso coffee brewing.

This guide is dedicated to the baristas for which the machine is named: The La Marzocco Street Team. The street team first assembled in April 2009. The initial meeting involved 20 passionate professionals gathered in a conference room during the Specialty Coffee Association of America's Expo in Atlanta, Georgia. After a few hours of discussing the features and capabilities of the ultimate espresso machine, the group had compiled a white board full of ideas that would serve as the foundation for the development of the Strada EP. The Street Team discussion continued in an online forum, and the membership continued to grow. By the time the project was completed, over 300 baristas from around the world had contributed input and feedback. The Strada is the physical embodiment of what the Street Team came together to create. It is an espresso machine designed **by baristas for baristas**.

Still, the Strada was designed to be a dynamic platform, flexible enough to enable a barista to apply variable pressure in order to draw out the intended flavor and texture of the coffee being prepared. To fully understand its capabilities and how it might most effectively be employed, one must understand how espresso technology started and how it has evolved over the last century. The Strada is an espresso machine for the baristas of today, but its story begins with the first espresso machines ever built.

historic espresso technology

vertical boiler machines

Vertical boiler machines were the first coffee machines made for espresso. These machines were typically comprised of one, vertical boiler, which was kept very hot (somewhere around 104c or 220f). The machine was heated using either gas flame or charcoal, making the baristas job even more difficult. The brewing temperature could also be manipulated by adding cold water through a manual inlet valve.

When making espresso, the water moved through the coffee at 1.2 bars of pressure. The dose of coffee depended on the manufacturer, and was anywhere from 20 to 40 grams of coffee. The grind of the coffee was coarser than we see today, and the extraction times averaged 60 seconds.

The resulting beverage was around 90 ml (3 oz.) in volume. The coffee was dark in color. The body was thin, and flavors were of ash or burn. There was no crema present on this coffee. The beverage was somewhere between brewed coffee and espresso as we know it today.

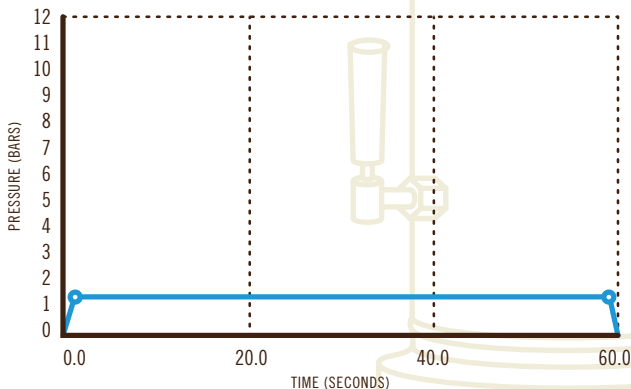

piston lever machines

The first lever machines were designed and created by Antonio Cremonese, who was also the first to patent this design. However, the rights to the technology were sold to Achille Gaggia in 1936 after Cremonese died.

Lever machines were the first espresso machines to produce crema. This was foreign to coffee drinkers at the time and it initially was referred to as foam or scum, which conjured something less than delicious. Gaggia, who was a good salesman, began calling it "crema," or custard, making it sound delicious and desirable.

Piston lever machines were introduced as single boiler espresso machines. A mercury pressure switch was used to control pressure of the boiler, giving some automation to how these machines were managed. The brew temperature was 95-98c (203-208f).

In 1936 the coffee market was very unstable. With coffee prices on the rise, these machines became popular because you could make espresso with less coffee. The dose used for an extraction was 12-14 grams of coffee for a double extraction. A double espresso was roughly 30 ml in volume.

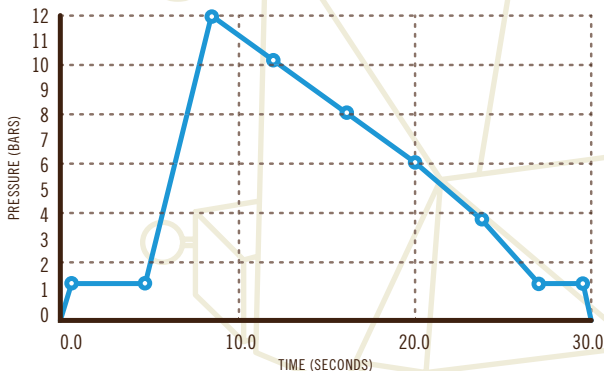

rotary vane pump machines

Most espresso machines being used today use a rotary vane pump to pressurize the extraction. Initially, this technology was introduced to simply make the barista's job easier and more efficient. A mishandled lever machine could be quite dangerous, as the lever could shoot back up if not engaged properly. This led to many serious barista injuries. Using a rotary vane pump, the barista could engage the extraction simply by pressing a switch.

The most common setting for espresso machines today is 9 bars of pressure. 9 bars has been chosen as the pressure, as 9 is roughly the mathematical average of the pressure used with a lever machine.

The first of these machines was the Faema E61, named after a total eclipse which occurred in Italy the same year (eclipse of 1961). Initial machine sales were not very successful, as the pump pressure dramatically changed the way the coffee tasted. It took roughly 10 years before coffee roasting was changed to catch up to the technology of rotary vane pump espresso machines. However, with time, this has become the most current way that we brew espresso coffee.

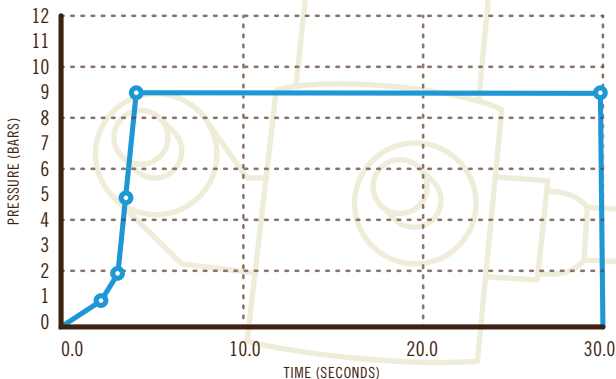

strada ep technology

The Strada introduces three advanced components,
never before seen on an espresso machine.

mechanical gear pump

Each group has its own mechanical gear pump, built into the espresso machine. These pumps are incredibly reliable. The technology is adopted from applications where reliability is essential, such as dialysis in medicine or for hydraulic helicopters.

It is the gear pump that allows the barista to have full control of the pressure being used to brew espresso.

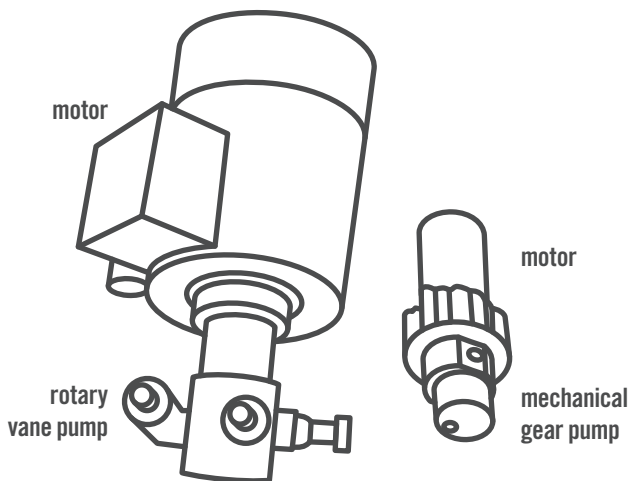

membrane potentiometer

Although each group head is controlled by a paddle, it is actually a membrane potentiometer which activates the brewing of the espresso. This form of electronic control is very similar to the click wheel of an early generation iPod. On the iPod, you use your finger to trace the click wheel, allowing you to navigate electronic menus. With the Strada, the paddle traces the potentiometer, allowing the barista to control the Strada. Each group head and steam wand have their own potentiometer for electronic operation. Potentiometers are designed to have a very long lifespan and are rated for 100 million use cycles. They also require no maintenance.

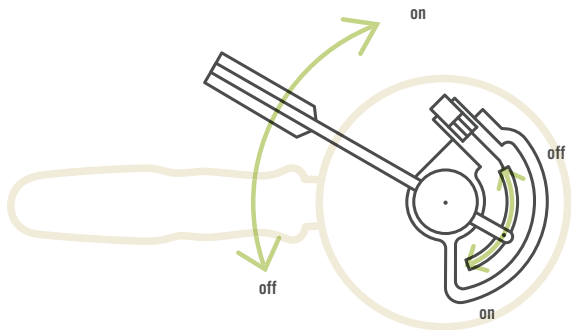

electronic steam valve

The steam valves featured on the Strada EP are electronic, and do not require any kind of rebuild. With proper maintenance and an annual cleaning of the valve, these valves will have an incredibly long lifespan. It is this electronic valve that gives the barista the ability to precise control of how much steam is released from the boiler to the steam wand.

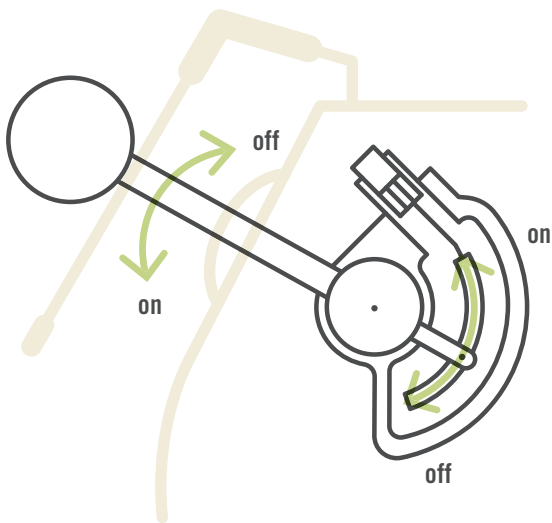

brewing with the strada ep

our experience & research

Creating the Strada EP was only the beginning. As we have seen throughout the history of espresso coffee, changes in machine technology can create other challenges in coffee brewing. As an espresso machine manufacturer, we want to make sure the people using our machines are able to easily make delicious espresso. For that reason, we wanted to learn as much as we could about using variable pressure in espresso, so that we could be a resource to Strada EP owners.

Our explorations started in February of 2011, when a group of two World Barista Champions, two industry thought leaders, and two La Marzocco after-sales managers gathered together in Italy. For three days, they dissected the various stages of extraction, observing how pressure affected each one. Their work laid a strong foundation for other team members around the world to continue to build how they would use the Strada EP.

For this book, we compiled many of those methods and techniques and have laid out a simple way for a new Strada EP user to be able to approach pressure profiling.

clear objectives

Unlike the espresso machines of the past, the Strada EP gives you total control over pressure. This is very exciting, but can be equally intimidating. Without an idea or objective in mind, it is easy to waste time and coffee without achieving the desired outcome.

Here, we provide you with a starting point and a framework for exploring the capabilities of variable pressure in espresso preparation.

Objective 1 - to brew espresso with flavor that reflects the experience of cupping the same coffee.

Objective 2 - to brew espresso that tastes delicious and balanced, whether the coffee has been roasted for espresso or not.

identifying the variables

It's important to consider all the parts of the espresso extraction process that we have control of. A great barista understands how to manipulate each of these variables to achieve optimum flavor of an espresso.

Grind

Coffee Dose & Brew Ratio

Temperature

Extraction Time

Pressure & Flow

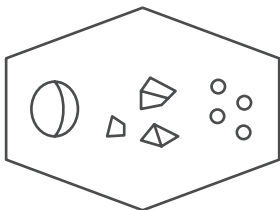

grind

What we simply call grinding coffee, engineers refer to as comminution. Comminution is essentially the reduction of a material into small particles or fragments. We grind coffee into smaller fragments in order to increase the amount of coffee bean surface that can interact with water and be extracted during the brewing process. Comminution facilitates the transfer of soluble and emulsify-able substances into the brew.

Grind, and grind adjustment, is one of the first variables we learn about in becoming baristas. When we adjust the grind, we change the size of the surface area that is available to make contact with water.

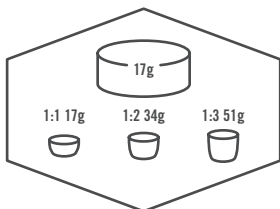

coffee dose & brew ratio

Brewing quality espresso requires using the right amount of coffee. The right amount of coffee can be determined by what basket is being used. La Marzocco makes portafilter baskets in 7, 14, 17, and 21 gram sizes. For the best extraction quality, we recommend using the listed dose, +/- 1.5 gram.

To get the most precise measure of finished espresso, it is recommended that you use a scale to measure the beverage weight of an espresso. This is easily done by placing a cup on a scale capable of measuring to .1 gram, and taring it to 0. Extract an espresso into the cup and return it to the scale to see your beverage weight.

Our brew ratio references the ratio of dry, ground coffee going into the portafilter to the beverage weight of our finished espresso. 17 grams of dry coffee packed into the portafilter brewed into an espresso that weighs 34 grams is a ratio of 1:2. This resembles a traditional style of espresso. Decreasing the ratio to a 1:1 (17 grams to 17 grams) is much closer to the classic idea of a ristretto espresso. Increasing the ratio to 1:3 (17grams to 51 grams) resembles a lungo espresso.

Of all the variables, choosing the brew ratio can have the greatest overall effect on the finished product. It greatly impacts all elements of the sensory experience of the beverage.

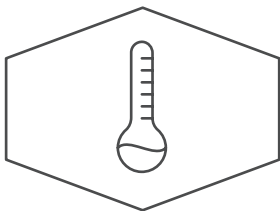

temperature

In the Strada EP, individual coffee boilers for each group head not only contribute to greater temperature stability, but they also enable the barista to set different temperatures for each group head. Each group head features an LCD screen that displays the temperature of water flowing from the group to and through the coffee.

Brew water temperature is important because it affects the efficiency with which the water can extract the coffee. Water with a higher temperature has more thermal energy, and therefore it creates a greater chemical reaction within the coffee. A simple degree of change in brew temperature can dramatically effect the flavor and body of an espresso.

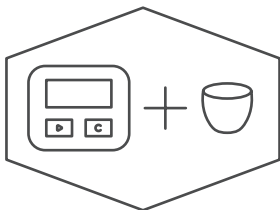

extraction time

Extraction time is the amount of time it takes to brew an espresso from the moment the pump is engaged. Extraction time affects how much of the coffee is being extracted. A faster extraction time means the water is passing through the coffee at a higher rate, pulling less from the coffee, and leaving desirable compounds behind. Slowing down the extraction increases the contact time of the water with the coffee, increasing the number of compounds being extracted from the coffee.

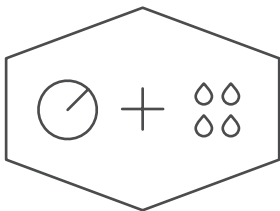

pressure & flow

One key to understanding how to use the Strada EP is how pressure and flow are connected. The data displayed on the Strada EP LCD screen refers to the pressure reading at the coffee bed. When the portafilter is removed and the pump is running, there is no resistance. Therefore, the display reads 0 bars. Any other espresso machine will show 9 bars on the pressure gauge, even without resistance. The difference is the place within the hydraulic system where the pressure is being measured.

With the Strada EP, pressure and flow are directly connected. As pressure increases, the flow of water in the group head increases so that pressure can build. The Strada EP is designed to run the same pressure curve time and time again.

What this means for you:

- If the dose or the grind of the coffee is changed, the resistance in the coffee bed is changed.
- If the resistance in the coffee is reduced, the Strada will increase flow to increase pressure, so the pressure curve is maintained.
- If the resistance in the coffee is increased, the Strada will decrease flow to decrease pressure.
- The change in flow to compensate for the change in resistance will increase or decrease the volume of espresso brewed by the pressure profile.

initial stages of extraction

In researching the effect of pressure on brewing espresso, we decided to put our initial focus on the first third of the extraction. This is the time when the water begins to pour from the group and begins to interact with the coffee. Water flowing from the group, but not at full pressure is called preinfusion. There are a number of espresso machines that allow the barista to control this.

Preinfusion, or a gradual increase of pressure and water applied to the coffee, can positively impact the flavor and quality of extraction. If you have ever cupped coffee, or brewed a French press or pour-over, you have probably seen the chemical reaction of coffee meeting hot water. The coffee swells up, so much so that some call this the blooming of the coffee. Preinfusion helps achieve a similar result.

Using the Strada EP, we consider preinfusion to be the initial part of a pressure curve where the pressure is below four bars. Longer preinfusion times can make delicious coffee. However, it is important to be aware that preinfusing the coffee for too long can make the coffee swell and bloom too much, and may lead to channeling (where water passes through the coffee without extracting).

Nonetheless, we found that using a gradual increase of pressure helps us to repeatably brew tasty coffee.

the golden profile

Taking note of how preinfusion positively affects the brewing of espresso, the pressure profile illustrated here shows a simple rise in pressure to a peak of 12 bars, then a gradual reduction in pressure over the second half of the extraction. Our early research in exploring pressure profiling using the Strada EP found this profile to consistently generate delicious coffee.

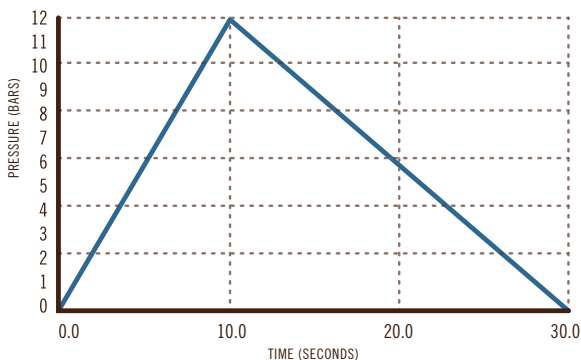



comparing coffee styles

As the “Golden Profile” was tested over time, it became apparent that what was initially considered the perfect profile, was not necessarily the best fit for every coffee.

Further testing proved that the profile was least compatible with coffees of medium and dark roast.

Comparing various roasts of coffee, you can see how light roasted coffee is very dense, where dark roasted coffee is not. One way to see this clearly is to weigh 10 grams of lightly roasted coffee and put it next 10 grams of dark roasted coffee. Though the weight is the same, the volume of dark roasted coffee will be much higher.

Not only is lightly roasted coffee more dense, but it is also less soluble. Solubility is defined as the property of a solute (coffee) to dissolve into a homogenous solution (espresso) with a solvent (water). In other words, less soluble coffee is more difficult to extract than more highly soluble coffee.

Roast level is not the only cause of different densities in coffee. Much of the variation can also come from where the coffee is grown, the variety involved, and even the processing. There are many variables within the coffee chain, and that is what makes coffee exciting and fun.

high solubility / low density

Recognizing the difference in various coffees, we decided to try cutting the peak of pressure to six bars. We have found that this profile is great for coffees with a higher solubility (dark-roasted or less-dense coffees). The lower pressure seems to be gentler on the coffee, extracting the flavors we want while minimizing the flavors that are less desirable.

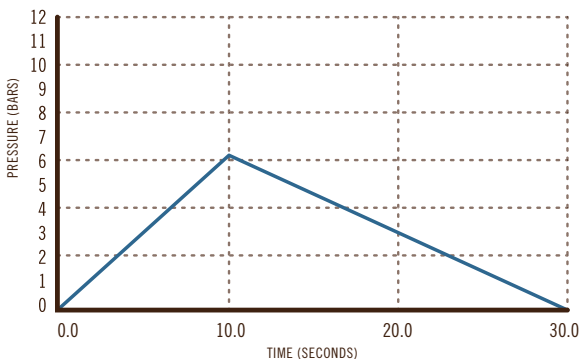

medium solubility / medium density

For coffees with medium characteristics, we find that peaking at 9 bars works very well.

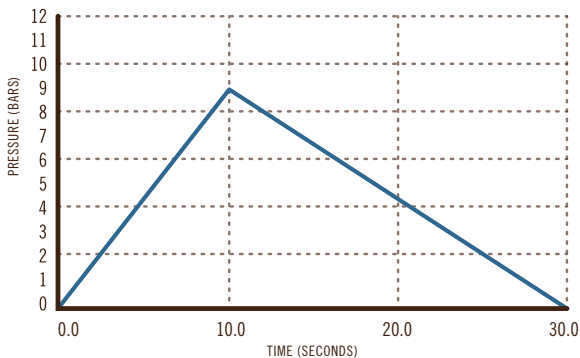

classic espresso

As mentioned before, we focused on the two goals of brewing single origin espresso that had flavor that reflected how a coffee cups. One might wonder then what to expect with coffees roasted for espresso. Almost every espresso is roasted and blended for traditional espresso machines. For these coffees, we believe the profile below is best. It is built to extract coffee in a way that is very similar to the La Marzocco Linea Classic.

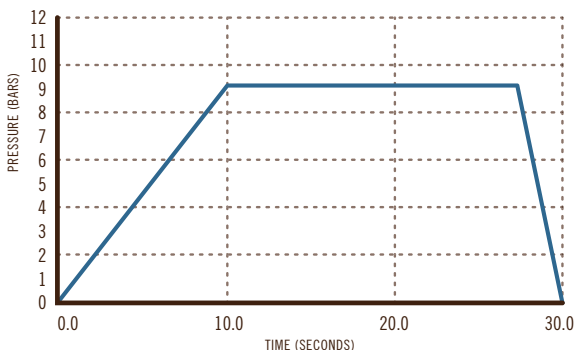

in conclusion

The end of this book is only the beginning. The profiles here are a place to start and a framework for you to begin experimenting with your coffee.

Once you have tried these profiles you can try variations such as moving the peak point of pressure around in the extraction time. Peaking at 15 seconds vs. 10 will alter the flavor. You might find this changes the taste balance and brings out more sweet, bitter, or acidic qualities of the coffee.

Another variation to try is holding a peak of pressure rather than hitting the peak and immediately ramping down. Holding at 6 bars for 5 seconds might pull out some more interesting cup characteristics.

We encourage you to try different things and find what works best for you and your coffee. Remember, the Strada EP is all about the barista. The machine is simply a tool for you to unlock all the magical flavors of your coffee.

Thank you for joining us on this new adventure of coffee brewing.

-La Marzocco