

# *Blueair*

## Installation and User's Manual

---

BLMI-500AD



# IMPORTANT!!

To ensure we provide the best product to our customers we have added a new feature to our Ice Machine product line. Blue Air has added check valves to our units that **MUST** be opened prior to operating your Ice Machine. Failure to follow these instructions will severely damage the product and void the warranty.

## Location of Valves (BLUI-150 model does not come with any valves)

### BLUI-250A(Undercounter)

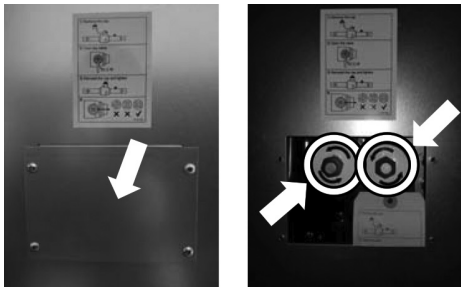

- Located on back panel of unit.
- Disassemble the cover to access the valves.

### BLMI-300A/500A/500AD/650A/900A (Modular)



- Located on the inside of the unit.
- Disassemble the front cover to access the valves.

## Guide to Opening Valves

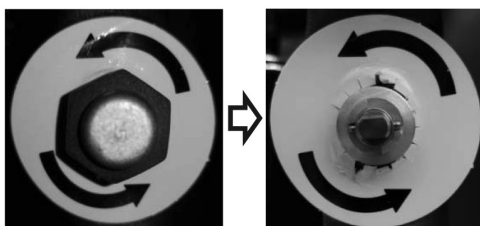

- Uncap the safety cap

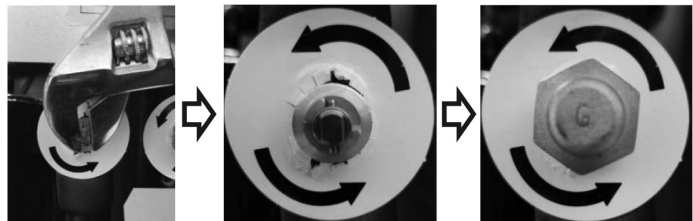

- Turn the valve counterclockwise until stop
- Put the safety caps back.

**After open the valves,  
Cover the valves**  
with the Insulation and ties provided.

www.blueairfse.com  
Contact / [info@blueairfse.com](mailto:info@blueairfse.com)  
Tel. 1-866-677-8500 / Customer Service

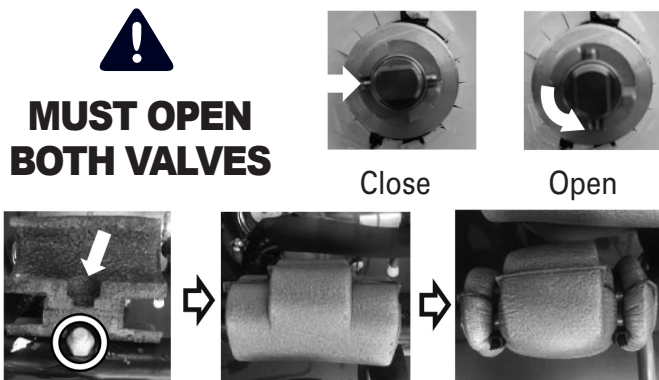

# Table of Contents

- **Freight Claim Procedure(Important)**
  - 1. Specifications ..... 5
    - 1.1 Technical Specification
    - 1.2 Cycle Specification
    - 1.3 Product Dimensions
  - 2. Installation & Operations Guide ..... 7
    - 2.1 Location Requirements
    - 2.2 Installation Requirements
    - 2.3 Electrical Requirements
    - 2.4 Environment Requirements
    - 2.5 Checklist before Installation
    - 2.6 How to Remove Machine Panel
    - 2.7 Bin Installation
    - 2.8 Bin S/W Installation
    - 2.9 Water supply & Drain Connections
    - 2.10 Wire
    - 2.11 Final Check
    - 2.12 Test Run
  - 3. Operation ..... 17
    - 3.1 Button
    - 3.2 Status Light
    - 3.3 7-Segments
    - 3.4 Operation Cycle
    - 3.5 Safety
  - 4. Maintenance & Cleaning ..... 20
    - 4.1 Maintenance Period
    - 4.2 Interior Cleaning & Sanitizing Procedure
  - 5. Troubleshooting ..... 23
    - 5.1 Checklist before Service

## **Freight Claim Procedure (Important)**

### **Inspect Immediately**

This product has been carefully inspected and packed in accordance with the carrier's packing specifications. Responsibility for safe delivery has been assumed by the carrier. If loss or damage occurs, you as the consignee must file a claim with the carrier and hold the container for carrier's inspection.

### **Visible Loss or Damage**

Any external evidence of loss or damage must be fully described and noted on your freight bill or express receipt and signed by the carrier's agent. The claim should be filed on a form available from the carrier.

### **Concealed Loss or Damage**

Concealed loss or damage should be reported to the carrier and vendor within 24 hours of delivery.

After 24 hours the seller is not responsible for any freight damage incurred.

Keep the product as well as all of the original packaging material in a receiving area for carrier's inspection.

### **Warning**

Connect to potable water supply only.

Adult supervision is required for safe use either by children under 8 years of age or the developmentally disabled.

The warranty does not apply to the followings.

- Repair or replacement of parts required due to misuse, improper care or storage, negligence, alteration, use of incompatible supplies or lack of specified maintenance.
- Regular maintenance items.
- Failures caused by improper or erratic voltages, adverse environmental or water conditions, improper drainage, interruption in electrical or water supply.
- Improper or unauthorized repair.
- Any ice machine that has been installed and/or maintained inconsistent with the instructions provided by Blue Air

# 1. Specifications

## 1.1 Technical Specification

MODEL NAME	Operating Amps	Maximum Fuse size	Condenser	Rated Voltage
BLMI-500AD	11.5 A	25 A	Air-Cooled	115V/60Hz/1Ph

## 1.2 Cycle Specification

	BLMI-500AD
Design Pressure	HI – 560 psig LO – 320 psig
Refrigerant	R-410A 15.8 OZ
Compressor	115V 57.0 LRA
Pump	115V 0.42 FLA 46.3 W
Fan	115V 0.68 FLA 75.2 W

# 1.3 Product Dimensions

● 500AD

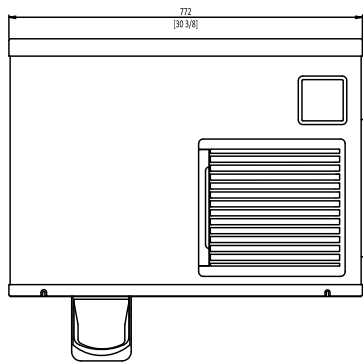

FRONT

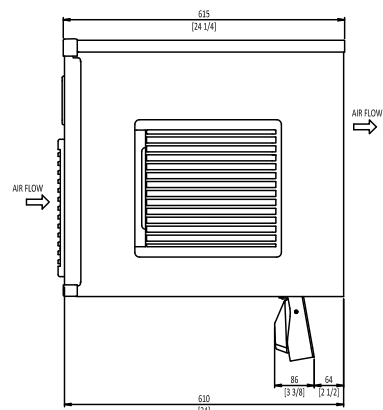

SIDE

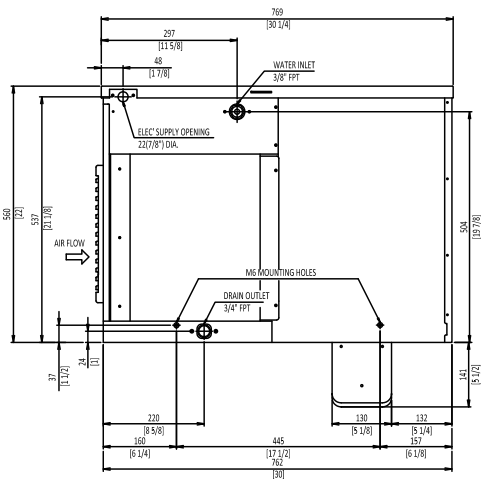

REAR

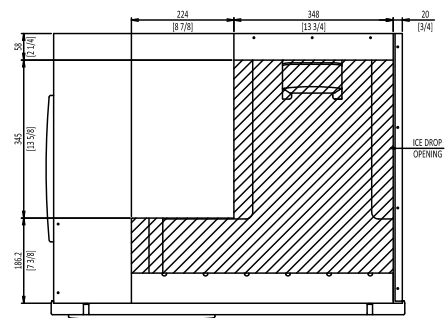

BOTTOM

## 2. Installation & Operation Guide

### **WARNING**

- The ice machine should be installed, following the local regulations of the country, state and region.
- Read the manual thoroughly before installation. Incorrect installation may cause malfunction, or bodily injury and death.
- Do not drop tools into the bin or the floor of the unit during installation. It may cause injure during routine operation of the machine.
- Do not operate unit with enclosure removed. This is marked by a sticker labelled "CAUTION or WARNING - Parts. Do Not Operate Unit With Enclosure Removed."  
(When disassembly for cleaning or similar servicing exposes moving parts.)

### 2.1 Location Requirements

The installation location of the ice machine should satisfy following conditions.

- If the location does not satisfy these conditions, do not install the machines in that location.
- The location should be in indoors and have good ventilation
- The location should not be near a heat source and should not be in direct sunlight
- The operating temperature at the location should be between 45°F- 100°F(7°C- 38°C).
- The location should have access to a water supply, drainage and an easily connected source of electricity
- The location should not have any obstacles, disturbing air circulation(heat exchange).
- The location should have enough clearance for wiring and plumbing on the rear.
- The location should have no food waste nor food contaminant.
- The location should support the full weight of the machine filled with ice.

### 2.2 Installation Requirements

- The head and bin should be level.
- The vent of the of ice machine and drain of the bin should be separated.
- The drain tip of the bin should have an air gap.
- The ice machine and bin should be completely cleaned after installation.
- The drain line should be easily separated from the ice machine.
- There must be minimum of (8 inches / 20 cm)of clearance, around, above and below the ice machine for enough air circulation and maintenance.
- Carefully align the ice machine with the bin to ensure a secure seal.

## 2.3 Electrical Requirements



### **WARNING**

- Electrical wiring and grounding of the unit should be done in accordance to the applicable local, state and federal laws and regulations.
- The ice machine must be grounded in accordance to the law and regulations of the country, state, and region.

Read the following warnings

- The Ice machine must be grounded.
- The Ice machine must be connected to an exchangeable fuse or circuit breaker.
- Decide the appropriate size of the wire based on the length, thickness, and position of the wires.
- Electrical wiring and ground must be done by a qualified electrician.

### 2.3.1 Voltage

- When operating the ice machine (with maximized electrical load) range of variation in maximum voltage allowed is  $\pm 10\%$  of the rated voltage.

### 2.3.2 Fuse / Circuit Breaker

- The ice machine must be wired to an exclusive fuse/circuit breaker. Circuit breaker must brake all electrodes and has 3/16" (3 mm) of contact separation.
- The circuit breaker must be HACR(Heating, Air Conditioning, and Refrigeration) type.

### 2.3.3 Power Connection

- Wire for power connection must over 12AWG.



## 2.4 Environment Requirements

### ● Installation condition

Condition		Minimum	Maximum
Ambient Temperature	°F	45	100
	°C	7	38
Water temperature	°F	45	90
	°C	7	32
Water pressure	psig	30	100
Voltage	V	104	127

-The ice machine and bin should be properly attached together.

## 2.5 Checklist before Installation

- After unpacking, check the product appearance. If there is damage to the product, contact your place of purchase.
- Remove packing box, tape and other packing components. If these things are not removed, the ice machine may not function properly.
- Two manual valves **MUST BE OPENED**. If not, serious damage will occur.
- Check the name plate for minimum electrical requirement for operating the machine. Ensure there is sufficient electricity to operate the machine.
- To avoid any damage during installation, remove all panels. Refer to "2.6 How to Remove Machine Panel".
- Remove all accessories, enclosed with the ice machine.
- Remove protective plastic film on the panel.
- Check whether a compressor is secure and the fan blade turns freely.
- The ice machine must be installed onto the bin. The available bins are as below.

- LB-500S : 30 inches (762 mm)

## 2.6 How to Remove Machine Panel

To avoid any damage during installation, remove all panels beforehand.  
Remove them in the following order by referring to Fig 1.

1. Unscrew the bottom screw of the front panel and store it securely.
2. Remove the front panel by firmly grasping the bottom edge and pulling it up and away from the unit.
3. Store the front panel securely.
4. Remove the top panel by firmly grasping the front edge and pushing back.
5. Store the top panel securely.
6. Unscrew the Side Panel (R), and store it away securely.
7. Grasp the front of the right panel and pull it forward.
8. Store the right panel securely.
9. The left and back panels cannot be removed.
10. Remove the insulation panel by pushing it up.
11. Unscrew the ice cover and remove the cover by pushing it up.

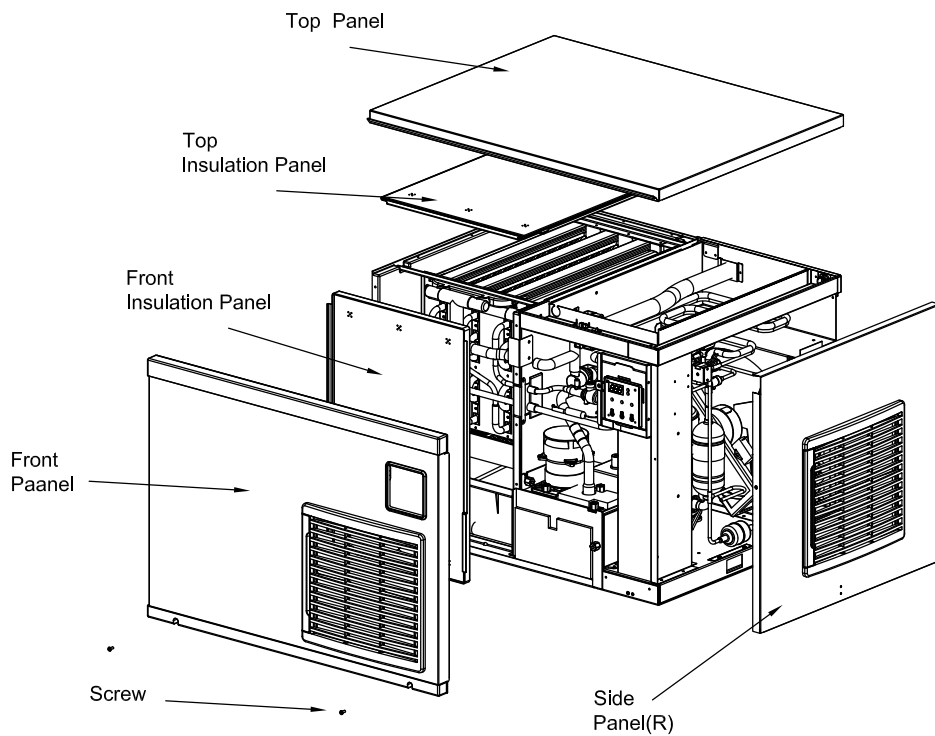

Fig 1

## 2.7 Bin Installation



### WARNING

- Check whether the ice machine and ice storage bin are compatible before installation. The ice machine and bin should be properly attached together.

### 2.7.1 REAR KIT Installation

Install rear kit referring to Fig 2 and below instructions.

1. Position the ice storage bin at the installation location.
2. Level the bin by using included legs.
3. Place 'INSURATOR REAR' at the bin.
4. Fix three points at the rear by using enclosed brackets.

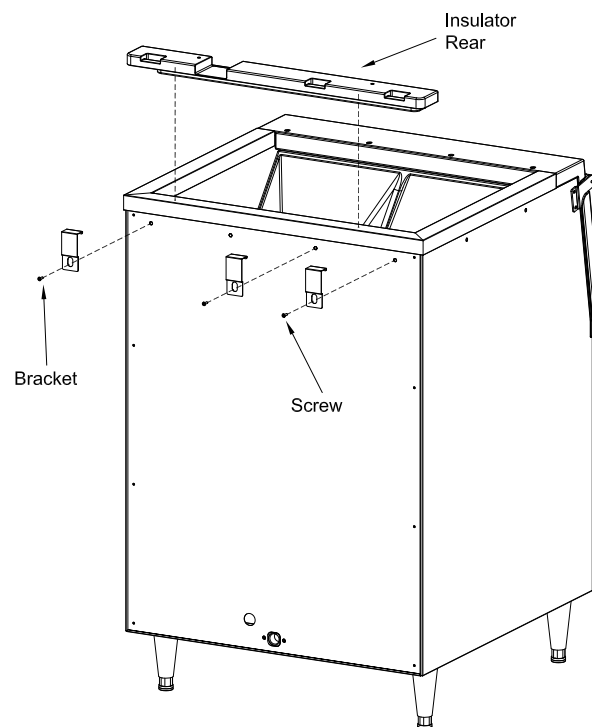

Fig 2

## 2.7.2 Modular Installation

Install modular ice machine referring to Fig 3 and below instructions.

1. Place the modular on the bin after installing rear kit.
2. Fix two points at the rear by using enclosed bracket and four screws.

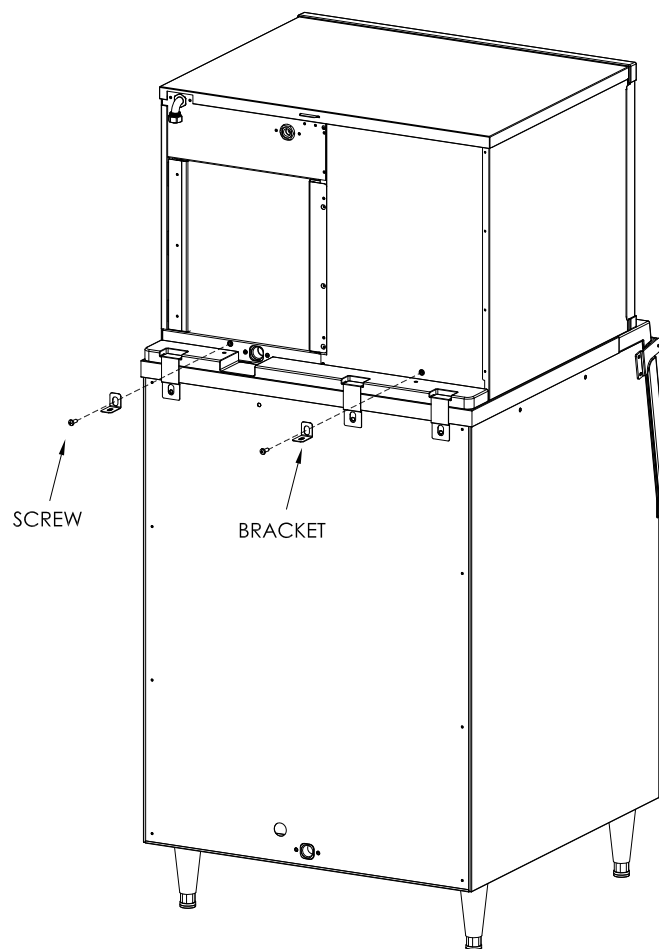

Fig 3

## 2.8 Bin S/W Installation

### **WARNING**

-The Bin switch must be installed before starting to run the ice machine.

#### Preparation of installation.

- Unscrew (1) and (2). Then, remove the front cover (A) by lifting as shown in Fig 1.
- Take out the Bin Switch (B) from the machine as shown in Fig 2.

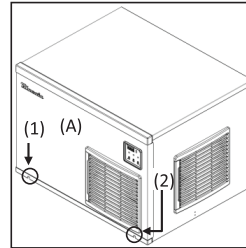

[Fig 1]

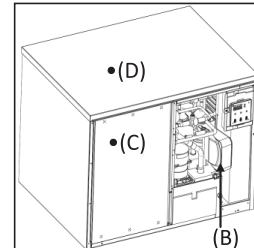

[Fig 2]

#### Procedure to install bin switch.

- Disassemble the Insulation Evaporator (C) while lifting the top cover (D) as shown in Fig 2.
- Unscrew the two thumb screws (3) and (4) to disassemble the front insulation (E) as shown in Fig 3 and 4.
- Unscrew the two thumb screws (5) and (6) as shown in Fig 4.
- Disconnect two tubes (7) and (8) as shown in Fig 5 and 6.
- Slowly pull out the water tank and ice guide (G) while lifting the water motor assembly (F) as shown in Fig 7 and 8.
- Secure the bin switch (B) to the back wall of the ice maker with two thumb screws (9) as shown in Fig 9.
- Put the wire harness of the bin switch (B) through the tube (10) as shown in Fig 9.
- Connect the wires (11) and (12) as shown in Fig 10.
- Reassemble all the parts that were disassembled in reverse order of disassembly.

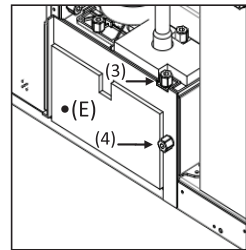

[Fig 3]

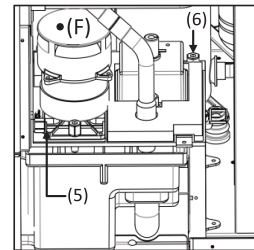

[Fig 4]

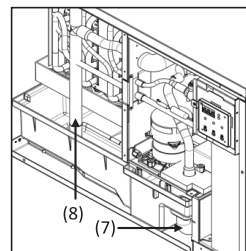

[Fig 5]

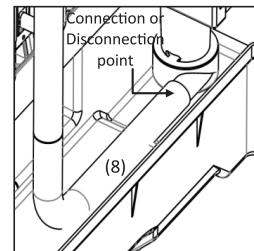

[Fig 6]

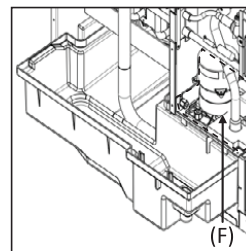

[Fig 7]

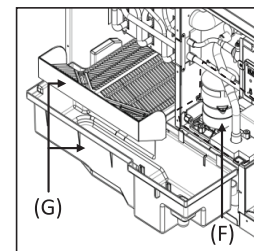

[Fig 8]

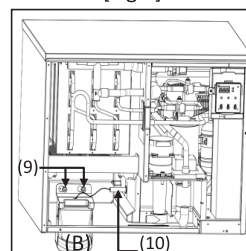

[Fig 9]

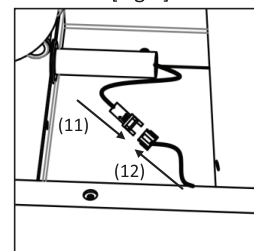

[Fig 10]



Make sure the connection of the water tube is secure.

## 2.9 Water supply & Drain Connections

### **WARNING**

- Installation of water supply and pipe system must be done in accordance to local, state and federal laws and regulations.
- The ice machine is to be installed with adequate backflow protection to comply with applicable local, state and federal laws and regulations.
- Water pipe work must be done by qualified service technicians.

- Modular and bin's drain line must be separated. Condensation drain line can be connected to the modular's drain line.
- 2 cm per 1 m (1/4' per 1 foot) of slope is recommended for proper drainage.
- Minimum of 2" (5 cm) vertical air gap is required between the end of each pipe and the drain.

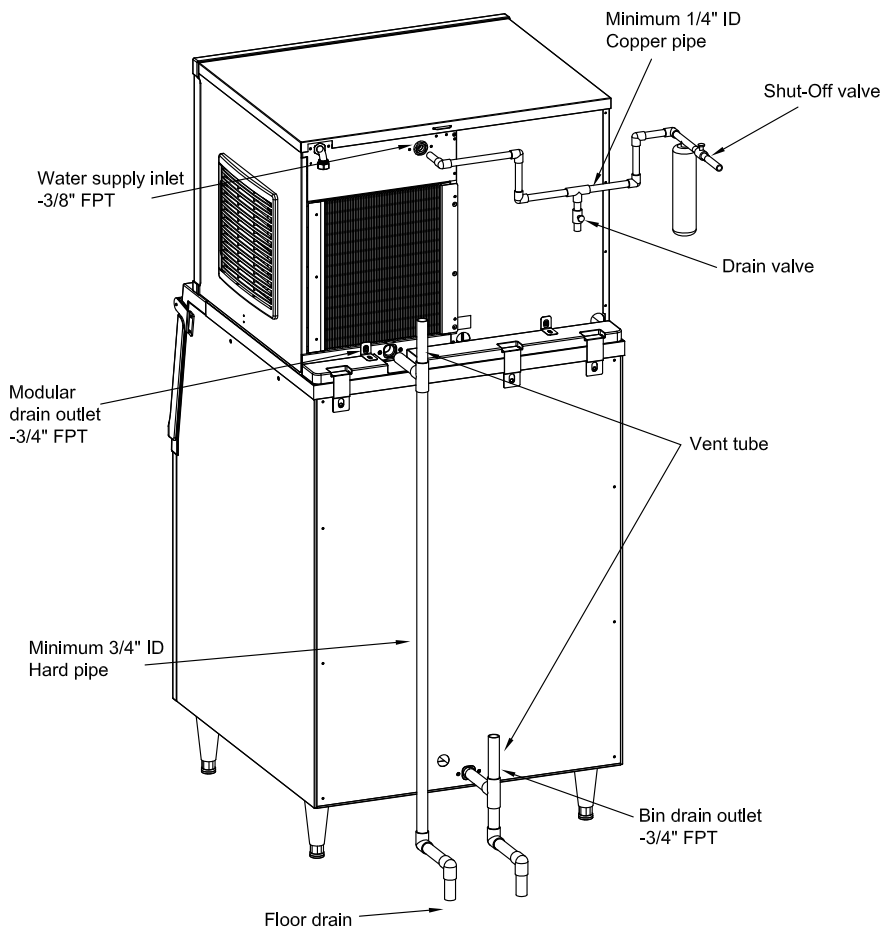

Fig 9

\* Leave a 2" (5 cm) vertical air gap between the end of each pipe and the drain.

## 2.10 Wire

### **WARNING**

- Wiring must meet the local, state and federal standards where the machine is installed. Improper wiring might cause electric shock, injury, fire or death.
- Wiring must be done by a licensed electrician

- The machine requires an independent power supply. Check the nameplate for proper voltage and breaker/ fuse size.
- Improper electrical supply may cause fuse cutout, damage to cords/wiring or parts, or fire.
- The machine should be properly grounded. Otherwise, there is the possibility to cause injury or death.
- Wiring must be done by a licensed electrician.
- Allowable voltage is +10% / -5% of the rated voltage.
- Size of power cord is 7/8" DIA and use conduit the same size with 1/2" screw.
- Wire for power connection must over 14AWG.
- Refer to Fig 10 when connect wires.

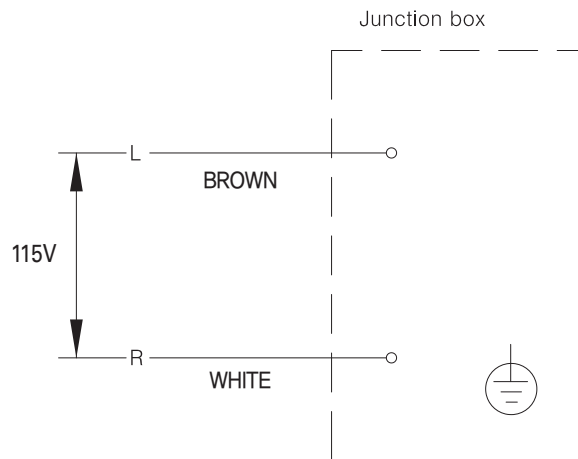

Fig 10

## 2.11 Final Check

1. Are two manual valves opened?
2. Have you clean and sanitize inside of bin?
3. Is ambient temperature of the installation area within the appropriate temperature range of 45-100°F(7-37°C)?
4. Is water temperature supplied to the installation area within the appropriate temperature range of 45-90°F (7-32°C)?
5. Are all the packing materials such as the packing box, inside tape, and other materials removed completely?
6. Is there enough clearance (min. 8 inches) above, below and around the ice machine for smooth air circulation?
7. Is the ice scoop placed in the right place?
8. Is the ice machine level on the floor?
9. Is the product located indoors?
10. Is the power supply to the ice machine installed properly?
11. Is the water supply pipe to the product properly connected?
12. Is drain system properly connected?
13. Is water pressure between 30 ~ 100 psig (206 ~ 689 kPa)?
14. Are there any leakages found in any pipes?
15. Are all the components, fixtures, and thumbscrews secure?
16. Have you informed customers about the product manual, how to operate the machine, and when to replace parts?
17. Have you informed the customer how to get service if the unit has a problem?

## 2.12 Test Run



### WARNING

The Ice machine is factory-adjusted. In general, no additional setting is required after installing the product. In cases of random modification, it may cause adverse influence on safety, function, component lifespan, and warranty period.

1. Open shut-off valve of water-supply line.
  2. Turn on the ice machine by pressing "Power" button and operate it for 10 minutes.
  3. Turn off the ice machine by pushing "Power" button and Press "Wash" button to drain all remaining water.
  4. Turn off the ice machine when "Add" is shown up on the display.
  5. Clean the bin inside by using neutral detergent.
  6. Turn on the ice machine and check bin switch operation for 5 minutes during the first freezing cycle.
  7. Push flap on the bin switch.
  8. The ice machine stops operation after 15 seconds.
- When turning off the unit during a test run, please do not attempt to re-operate until at least 3 minutes later to protect the compressor.
  - If there is no water in the water tank, do not push "Wash" button to protect water pump seal.
  - While operating, please check for water leaks on both the inside and outside pipe.



## 3. Operation

### 3.1 Button



#### (1) Power

Press the button for 2 seconds to turn on/off

#### (2) Wash

Use the button when cleaning the ice machine.

The instruction for Washing and Sanitation can be found in section 4.2 Interior Cleaning & Sanitizing Procedure and the label inside of the front panel.

#### (3) Check

Only for service persons to check the status of the machine.

### 3.2 Status Light

(1) **On/Off** : shows power status in green.

If storage container is full of ice, orange light will appear.

If water level is too low, red light will appear.









(2) **Clean** : Green light will appear during washing mode.

(3) **Err** : Red light will appear if any problems occur during the machine operation.

(4) **Freeze** : Green light will appear during freezing cycle.

(5) **Harvest** : Green light will appear during harvest.

### 3.3 7-segment

Display	Status
	Ready for cycle
	1 = Water Supply Period .00 = Elapsed time (x 10 sec)
	2 = Harvesting Period .00 = Elapsed time (min)
	3 = Freezing Period .00 = Elapsed time (min)
	Drainage cycle
	Wash mode Ice machine is either cleaning or sanitizing.
	Indicates when the bin is full of ice.
	Wash mode Indicates need to put detergent or sanitizer into the machine.
	Cleaning and saitzation completed (User has to press the button to remove this sign)

## 3.4 Operation Cycle

Ice machine is operated in accordance to the following process

### 1) Water supplying cycle

Once power is on, water supply valve opens to fill the water tank with water.

### 2) Harvesting Cycle

To remove ice made on the evaporator, water flow stops and it becomes hot. Then, ice is released from the evaporator to the storage container. Once temperature sensor detects a certain temperature, freezing cycle begins. Water continues to be supplied during the harvesting cycle.

### 3) Freezing Cycle

This is the process of making freezing ice. Water is supplied to the surface of evaporator and it becomes cold. As water keeps circulating, more and more ice is layered. This process is repeated until water level sensor reaches low. Once it reaches low level, the harvest cycle starts.

### 4) Drain Cycle

Residue or impurities will occur in the water tank during the repeating process of freezing and harvesting cycles. Using the ice machine for a long time without draining may cause damage. After a certain number of cycles, completely drain leftover water in the water tank by using water pump.

## 3.5 Safety

### 1) Maximum freezing time - 60min

To protect the ice machine, maximum freezing time is set to 60 minutes. When freezing cycle goes over 60 minutes, it switches to the harvesting cycle. During the second freezing cycle, if time goes over 60 minutes, machine stops and shows error code (E1) on the control panel with a beep sound.

### 2) Maximum Harvesting Time - 25min

The maximum harvesting time is 25 minutes. If time goes over 25 minutes, it automatically switches into the freezing cycle. During the second harvesting cycle, if time goes over 25 minutes, error code (E2) is shown on the control panel with a beep sound.

### 3) High Temperature safety

If temperature outside the evaporator during freezing cycles goes over 140°F (60°C), machine stops to protect the cycle and error code (E3) is shown on the control panel.

### 4) Low Water Safety

For protection of water pump, if water level is low after harvesting cycle, machine halts and error code (E5) is shown on the control panel.

## 4. Maintenance & Cleaning

Ice machine must be maintained and cleaned based on schedule in this manual and the cleaning label attached on each unit.

### 4.1 Maintenance Period

 <b>WARNING</b>	
Refer to the following table for guidance on Maintenance Period. It may be shorter depending on environment and hygiene regulations of the installation area.	

Period	Area	Details
Everyday	Scoop	Clean scoop with food safe cleaner; rinse with fresh water.
Every two weeks	Air Filter	Clean with compressed air, or warm water and allow to fully dry.
Every month	Water filter system	Check proper water pressure and replace filter if needed
	Ice machine exterior	Clean with spot free water and soft cloth.
	Bottom of ice machine & bin door	Wipe it with a soft fabric
Every six months	Ice machine & Ice storage bin	Wash and sanitize according to the manual. Please refer to '4.2 How to clean and sanitize'
	Water Supply Inlet	Close the ice machine water supply line shut-off valve and drain the water system. Clean the water supply inlet screen
	Condenser	Inspect. Clean if necessary by using a brush or vacuum cleaner. More frequent cleaning may be required depending on location.
	Water Hoses	Inspect the water hoses and clean/replace if necessary.

## 4.2. Interior Cleaning / Sanitizing Procedure

The ice machine should be cleaned and sanitized every six months. Depending on the installation condition, the machine may need more frequent cleaning and sanitizing.

### **WARNING**

- Use a detergent and sanitizer for ice machine, and follow the directions of those products.
- During cleaning and sanitizing, wear rubber gloves and protective eye glasses to protect eyes and skin.
- Keep detergent and sterilizer out of the reach of small children.
- Do not remove ices, made on evaporator, by force. It might cause damage to the surface of evaporator.
- Do not remove ices on evaporator with a sharp ice pick.

### 4.2.1 Cleaning procedure

- 1) Press "Power" to turn off ice machine. If machine is in freeze cycle, wait for harvest cycle to complete and turn off ice machine by holding the "Power" button for 2 seconds.
- 2) Remove all ice from the storage bin.
- 3) Press the "Wash" button. Then "drn" is shown up on the display.
- 4) "Add" is shown up on the display once the ice machine drains remaining water completely.
- 5) Remove front panel, and insulation Front. Add 16 oz. of Nu-Calgon ice machine cleaner into water tank.
- 6) Fresh water is supplied for 3 minutes and "Cln" is shown up on the display.
- 7) Water pump operates for 30 minutes and drains remaining water.
- 8) Fresh water is supplied again for 3 minutes after drainage and water pump operates for 5 minutes to rinse remaining detergent.
- 9) The ice machine drains water for 5 minutes.
- 10) The ice machine repeats step 8 to 9 for 30 minutes.
- 11) Turn off the machine once [ ] is shown up on the display..
- 12) Disassemble water level sensor, ice guide, water supply hose, spray tube, and spray guide referring to 2.6 How to Remove Machine Panel and 2.8 Bin S/W Installation.
- 13) Mix 5 oz. of Nu-Calgon ice machine cleaner per gallon of water and use with a soft towel/sponge/nylon brush to gently clean disassembled parts and surface of bin. (Detergent for dish washing also can be used.)
- 14) Rinse all disassembled parts with fresh water and dry them.  
\*\*WARNING- DO NOT CLEAN EXTERIOR OF MACHINE WITH CLEANING SOLUTION\*\*  
\*\*If cleaning and sanitizing machine- move on to 4.2.2. Sanitizing; if cleaning only, proceed to step 14.
- 15) Reassemble ice machine. Hold and Press "Power" button for 2 seconds to turn on ice machine and resume ice making cycle.

## 4.2.2 Sanitizing procedure

- 1) Press "Power" to turn off ice machine. If machine is in freeze cycle, wait for harvest cycle to complete and turn off ice machine by holding the "Power" button for 2 seconds.
- 2) Mix 2.5 oz. of Nu-Calgon ice machine sanitizer per gallon of water and sanitize the ice machine and bin by using spray.
- 3) Soak the disassembled parts from step 11 of cleaning instructions in prepared sanitizing solution for 5 minutes.
- 4) Dry the sanitized parts.
- 5) Reassemble all disassembled parts referring to 2.6 How to Remove Machine Panel and 2.8 Bin S/W Installation.
- 6) Press "Wash" button.
- 7) "drn" is shown up on the display and drains remaining water. If there is no remaining water, the ice machine automatically skip drain cycle and directly goes to step 8.
- 8) "Add" is shown up on the display once the ice machine drains remaining water completely.
- 9) Pour 32 oz of sanitizer into water tank.
- 10) After 1 minute, fresh water is supplied for 3 minutes and "Cln" is shown up on the display.
- 11) Water pump operates for 30 minutes and drains remaining water.
- 12) Fresh water is supplied again for 3 minutes after drainage and water pump operates for 5 minutes to rinse remaining sanitizer.
- 13) The ice machine repeats step 12 for 40 minutes.
- 14) Turn off the machine once  is shown up on the display.
- 15) Press "Power" button for two seconds to turn on the ice machine.

**\*\*WARNING- DO NOT PRESS ANY BUTTONS ON THE CONTROL BOARD DURING CLEANING OR SANITIZING CYCLE. THE ICE MACHINE STOPS CLEANING OR SANITIZING CYCLE WHEN ANY BUTTON IS PRESSED\*\***

**\*\*IF ANY BUTTON IS PRESSED DURING CLEANING OR SANITIZING CYCLE, RE-START FROM THE FIRST STEP\*\***

## 5 Troubleshooting

### 5.1 Checklist before Service

Below error codes are shown up when the machine has a problem.

Check below table first before calling for a service.

Code	Problem	Possible Cause
E1	Freezing error (freezing time exceeds 60 min)	Refrigerant leaked or pipe blocked
		Compressor not operating
		Fan motor not operating
		Ambient or water temperature too high
		Voltage too high or too low
E2	Harvesting error (harvesting time exceeds 25 min)	Refrigerant leaked or pipe blocked
		Compressor not operating
		Hot gas valve not operating
		Evaporator temperature sensing error
		Ambient or water temperature too low
		Voltage too high or too low
E3	Evaporator temp too high (temp > 140°F or 60°C)	Water temperature too high
		Sensor or connector defect
		PCB defect
E4	No drainage when the bin is full	Check water outlet hose
		Check pump motor
		Level Sensor not operating
E5	Water supply not enough (water supply time exceeds 4 min)	Float switch not operating
		Water valve not operating
		Water pressure too low
E6	Evaporator sensor error	Sensor short-circuit or disconnected
E7	PCB error	PCB program error
E8	Ambient temperature sensor error	Ambient temperature sensor is damaged
E9	Bin switch error	Bin switch sensor is damaged.
		Bin switch sensor is not properly connected.
HI	Ambient temperature is too high	Ambient temperature is higher than 45°C or 113°F.
LO	Ambient temperature is too low	Ambient temperature is lower than 45°C or 113°F.

***Blueair***

**BLUE AIR FSE, LLC.**

Gardena, CA 90248

Tel: 866.677.8500 / 310.808.0102

Fax: 310.808.0242 / 310.808.0262

Visit us our website at [www.blueairfse.com](http://www.blueairfse.com)