



Our Story

Zulay Kitchen is named after my extraordinary mother, Zulay. She was raised in poverty-stricken Venezuela and, against all odds, brought my brother and me to live in the US. As a single mother, she worked extra-long hours but still found time to cook healthy meals for us. At the time, I thought nothing of it. But now that I'm married with children of my own, I see how much of a super-hero mom she really was.

My wife and I created Zulay Kitchen to make shopping easier than ever in today's busy world. We believe that cooking should be fast and easy, so you have more time to enjoy with your loved ones.

Aaron Aaron Cordovez, Co-Founder of Zulay Kitchen

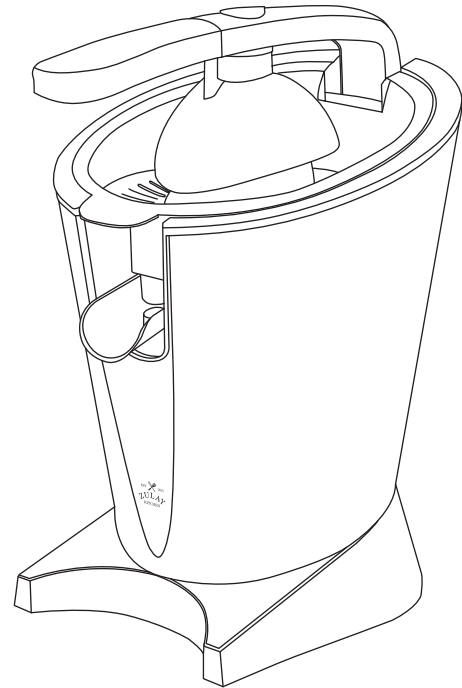

ELECTRIC CITRUS PRESS INSTRUCTION MANUAL



Thank You for Your Purchase

Thank you for choosing Zulay Kitchen's Electric Citrus Press. This user manual includes important information to help you operate the Electric Citrus Press and create your favorite juices.

Please read this manual prior to using the juicer. The simple maintenance actions are important to keep it operating.

If any issues ever come up, please feel free to reach out to our caring Kitchen Happiness customer service team.

We hope you enjoy using your new Electric Citrus Press and sharing delicious juice with your family and friends!



ONE YEAR LIMITED WARRANTY & SATISFACTION GUARANTEE

This product is warranted to the original purchaser for one year from the date of purchase, against manufacturer's defects under normal use. Additionally, our top-notch customer service team can help you with any questions or issues.

JUST A FEW STEPS AWAY:



Open the Camera App on your phone



Point to the code and focus your camera on the code



Click the notification that pops up*

*If you're having trouble, download a QR Code App

If you have any questions about the unit or its operation, please call or email customer service.

+1(727) 386-9117 ☎ Mon-Fri 9:00 AM - 5:00 PM (EST)

✉ support@zulay.net

TROUBLESHOOTING

Problem	Possible Cause	Solution
Unable to remove Fruit Dome.	The way you're holding or gripping the Fruit Dome might be causing difficulty in removing it.	Securely grip the edges of the Fruit Dome with your fingers and pull it straight out.

If your problem is not listed, then you can call us at **+1(727)386-9117**
Mon-Fri 9:00 AM-5:00 PM (EST), or you can contact us at
support@zulay.net

CONTENTS

SAFETY INFORMATION.....	01-02
TECHNICAL SPECIFICATIONS.....	02
PARTS OF THE ELECTRIC CITRUS PRESS.....	03
HOW TO ASSEMBLE THE ELECTRIC CITRUS PRESS.....	04-06
HOW TO USE THE ELECTRIC CITRUS PRESS.....	07-08
HOW TO DISASSEMBLE AND CLEAN THE ELECTRIC CITRUS PRESS.....	09
TROUBLESHOOTING.....	10-11
WARRANTY AND CONTACT INFORMATION.....	12

SAFETY INFORMATION

When using electrical appliances, basic safety precautions should always be followed:

- Before using the Electric Citrus Press, carefully read and understand the entire instruction manual to familiarize yourself with the product's features and safety guidelines.
- Ensure that the Citrus Press is plugged into a suitable power source with the correct voltage and current rating as specified in the manual.
- To protect against fire, electric shock, and injury to persons, do not immerse the cord, plugs, or the machine in water.
- Always unplug the Electric Citrus Press from the power source when it is not in use or during cleaning to prevent any accidental start-ups.
- Do not allow children or inexperienced users to operate the Citrus Press. Always ensure adult supervision when using the appliance.
- This unit is intended for indoor, personal household use only and is not for commercial use.
- Never touch the unit or its components with wet hands to reduce the risk of electrical shock.
- Use only the accessories and replacement parts recommended or provided by the manufacturer to ensure safe operation and optimal performance.
- Keep hands and fingers away from moving parts, especially the reamer, during operation.
- When not in use, store the unit in a safe and dry location, away from heat sources or damp environments.
- Do not use the Electric Citrus Press for any purpose other than juicing fruits, as it may lead to safety hazards or damage to the appliance.

TROUBLESHOOTING

Problem	Possible Cause	Solution
The juicer didn't squeeze all the juice out of the fruit.	<ol style="list-style-type: none">1. The fruit is not cut in half.2. The wrong size reamer is used, or the fruit dome is not attached.3. Not enough pressure was applied on the handle while juicing.4. There might be an oversized end on the fruit that requires trimming.	<ol style="list-style-type: none">1. Cut the fruit in half.2. Please use the larger reamer for larger fruits and ensure the fruit dome is attached to the lid.3. Ensure applying moderate pressure on the handle while juicing.4. Ensure you trim away any larger ends.
The juicer stopped working while in the process of juicing.	<ol style="list-style-type: none">1. You experienced a temporary power loss.2. The motor has become jammed.3. The motor is overheated.	<ol style="list-style-type: none">1. Ensure the juicer is properly plugged in.2. Unplug the juicer, disassemble and remove all stuck pulp in the spout and filter.3. Unplug the juicer and allow it to rest for 10 minutes. Then, plug it back in.

HOW TO DISASSEMBLE AND CLEAN THE ELECTRIC CITRUS PRESS

Always unplug the juicer before performing any cleaning.

For convenient cleaning, all accessories are safe to place on the top rack of a dishwasher, except for the Base and the lid, which should only be cleaned with a slightly damp cloth.

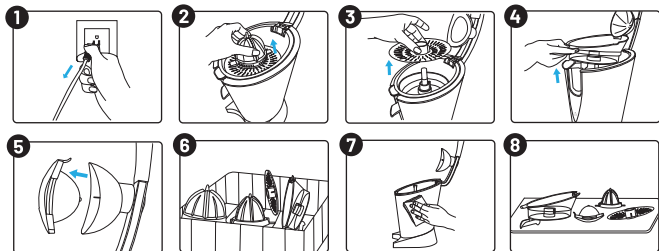

1. Disconnect the juicer from the power source.
 2. Remove the reamer/reamers.
 3. Remove the Pulp Filter.
 4. Remove the Juicing Bowl.
 5. Remove the Fruit Dome.
 6. Clean the accessories in warm, soapy water or place them on the top rack of a dishwasher.
 7. If necessary, wipe the juicer and the lid with a soft, slightly damp cloth.
- Important: Never immerse the Base of the juicer in water.**
8. Fully air dry all the parts before assembling.

SAFETY INFORMATION

- Keep the unit away from heat sources, such as heated stovetops, ovens, open flames, or any location that could cause damage from fire or heat.
- The detachable parts of the unit, such as the fruit dome or reamer, can be safely cleaned by detaching them and washing them in water. Always ensure that the base is disconnected from the power source before removing any detachable parts for cleaning.
- For your safety, please avoid touching the sharp edges of the spout.
- This appliance is not intended for use by persons (including children) with reduced physical, sensory or mental capabilities or lack of experience and knowledge, unless they have been given supervision or instruction concerning use of the appliance by a person responsible for their safety.
- If you plan on not using the machine for a prolonged period, ensure you clean the accessories and allow them to air dry before storing.

TECHNICAL SPECIFICATIONS

Model	D-8036A
Rated Power	160W
Rated Voltage	120V
Dimension	8.07*9.6*12.6 in
Juice Bowl Capacity	8oz

If you have any questions about the unit or its operation, please call or email customer service.

☎ +1(727)386-9117 ☎ Mon-Fri 9:00 AM - 5:00 PM (EST) ✉ support@zulay.net

PARTS OF THE ELECTRIC CITRUS PRESS

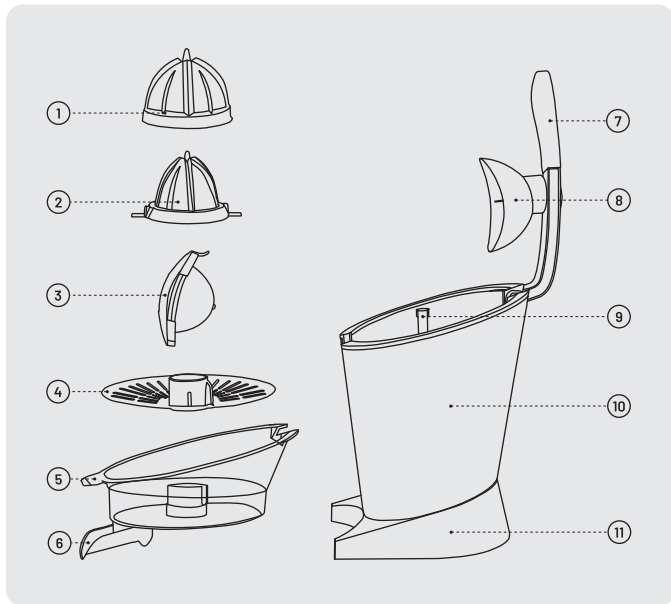

① Large Reamer

② Small Reamer

③ Fruit Dome

④ Pulp Filter

⑤ Juice Bowl

⑥ Locking Juice Spout

⑦ Handle

⑧ Lid

⑨ Motor Shaft

⑩ Stainless Steel Body

⑪ Non-slip Base

HOW TO USE THE ELECTRIC CITRUS PRESS



Position a glass beneath the spout. Apply moderate pressure to position your cut fruit at the center of the Reamer, then gently press it into place to ensure it fits securely onto the Reamer.



Lower the handle and apply moderate pressure to the fruit. This will set the juicer into motion.

Please be aware that you might need to exert additional pressure on the handle in order to extract the last bit of juice from the fruit.

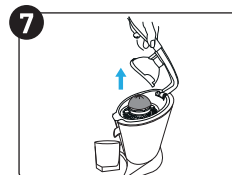

When you're ready to stop the juicing process, simply lift the handle to its original position.

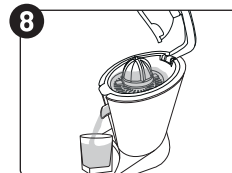

Unlock the Spout by gently pushing it downward to release the juice.

CAUTION: For your safety, please avoid touching the sharp edges of the spout.

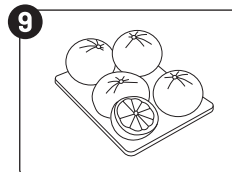

Repeat steps 4-8 on the remaining fruits.

HOW TO USE THE ELECTRIC CITRUS PRESS

Before using the citrus press, wash the Large Reamer, Small Reamer, Pulp Filter, Juice Bowl, and Fruit Dome in warm soapy water and dry them thoroughly.

Important: Do not immerse the base into water!

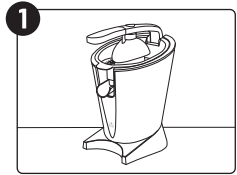

1 Place your Electric Citrus Press on a flat surface.

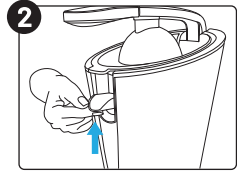

2 Lift the Juice Spout to lock it.
CAUTION: For your safety, please avoid touching the sharp edges of the spout.

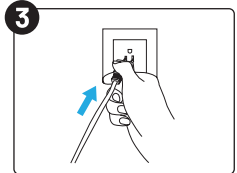

3 Plug the power cord into a suitable outlet.

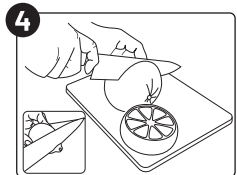

4 Prepare your chosen citrus fruit by cutting it into equal halves, following the example in the image. If the fruit has a larger end like lemons, be sure to remove it before proceeding with juicing.

HOW TO ASSEMBLE THE ELECTRIC CITRUS PRESS



Large Reamer

+



Small Reamer

+



Pulp Filter

+

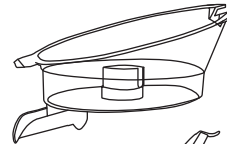

Juice Bowl

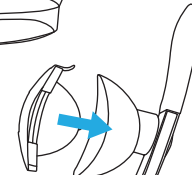

Fruit Dome + Lid

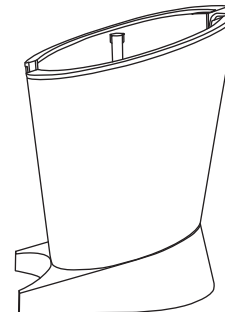

HOW TO ASSEMBLE THE ELECTRIC CITRUS PRESS

Before assembling the citrus press, wash the Large Reamer, Small Reamer, Pulp Filter, Juice Bowl, and Fruit Dome in warm soapy water and dry them thoroughly.

Important: Do not immerse the base into water!

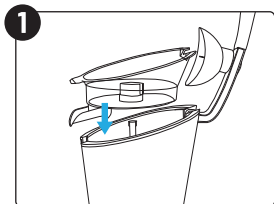

Position the Juice Bowl onto the Base, aligning the Motor Shaft on the Base with the hole in the Juice Bowl.

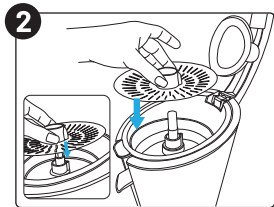

Place the Pulp Filter onto the Motor Shaft, ensuring that the groove on the Pulp Filter aligns perfectly with the groove on the Juicing Bowl, just as shown in the image.

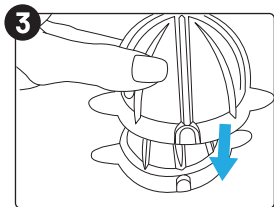

When juicing larger fruits such as oranges or grapefruits, connect the Large Reamer to the top of the Small Reamer by aligning the grooves on both sides.

Important: You can utilize the Small Reamer for smaller fruits like lemons and limes. However, please be aware that the Large Reamer will not attach to or function properly with the juicer unless the small one is attached to it first.

HOW TO ASSEMBLE THE ELECTRIC CITRUS PRESS

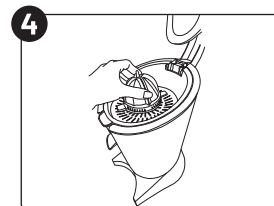

Position either the two connected reamers or just the Small Reamer (for juicing smaller fruits like lemons or limes) onto the Motor Shaft.

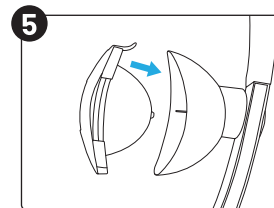

Attach the Fruit Dome to the Lid, ensuring it clicks into place. While we recommend using the Fruit Dome for smaller fruits like lemons, limes, and tangerines to apply additional pressure during juicing, it is not necessary to attach it to the Lid when dealing with larger fruits such as oranges or grapefruits.

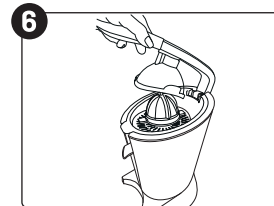

The juicer is now ready for use.