

# Sabrina Curved Sofa

／ SAB620

A collection of seating that exudes regal elegance, with fine profiles that balance lightly upon their tapered timber bases.



**zuster**

# Sabrina Curved Sofa

／ SAB620

## Materials —

Australian hardwood timber internal frame, dowelled joins and corner blocks. Seat cushions are wrapped with 85% feather and 15% down on a Superior high resilience foam core for structure, softness and comfort. Back cushions are channelled 70% feather and 30% down.

## Customisable —

This item is hand crafted and made to order. Custom sizes are available

## Finishes —

Full range of Zuster fabrics available for custom upholstery, alternative fabrics and leathers can be specified.

Designed and hand crafted at Zuster HQ in Melbourne, Australia.



Limed Oak



American Oak

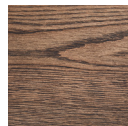

Hazelnut

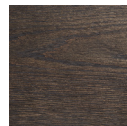

Coal

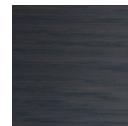

Slate

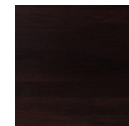

Saddle

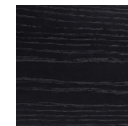

Mink

**zuster**

# Sabrina Sofa

／ SAB620

## Standard Dimensions —

SAB620A

2400 w x 1640 d x 780 h (mm)

Plain Fabric Required: 24 m

or

Combination Plain fabric 22m +

3m Ribbon Stitch

SAB620A

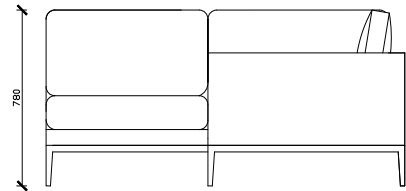
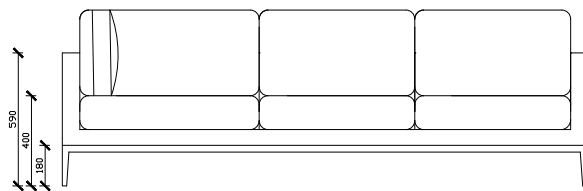
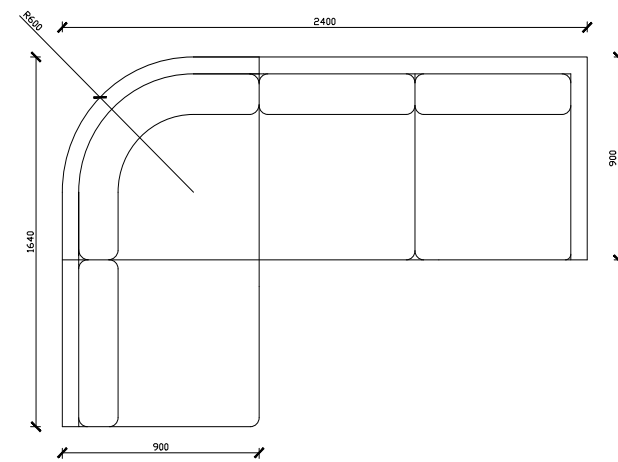

**zuster**

# Sabrina Sofa

／ SAB620

## Standard Dimensions —

SAB620B

2400 w x 2400 d x 780 h (mm)

Plain Fabric Required: 26 m

or

Combination Plain fabric 24m

+ 4m Ribbon Stitch

SAB620B

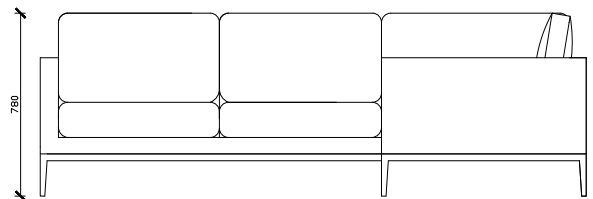
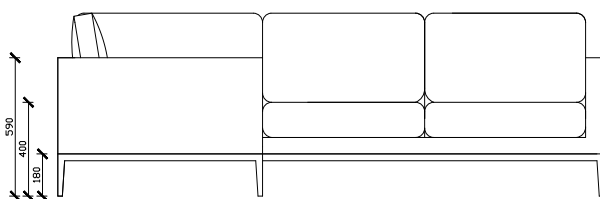
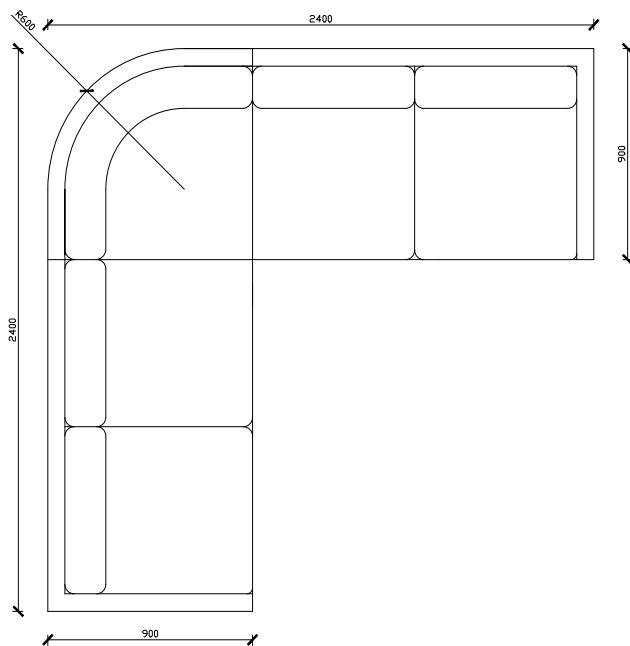

**zuster**

# Sabrina Sofa

／ SAB620

## Standard Dimensions —

SAB620C

2800 w x 2800 d x 780 h (mm)

Plain Fabric Required: 30 m

or

Combination Plain fabric 27m +

5m Ribbon Stitch

SAB620C

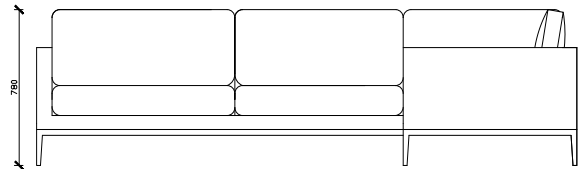
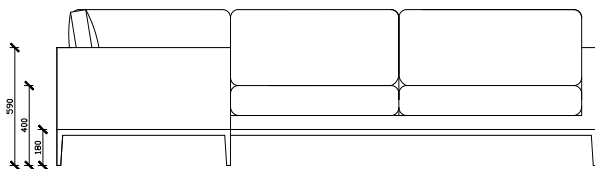
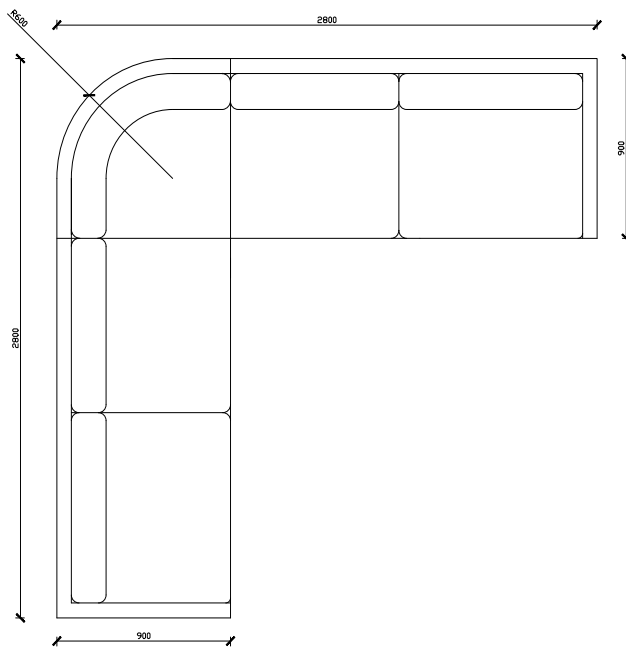

**zuster**

## Sustainability

### **Our commitment**

‘ Sustainability goes hand-in-hand with the integrity of our business and our beautiful, enduring products.’

Fleur Sibbel, Managing Director, Zuster.

Zuster is committed to designing pieces that are produced to the highest of environmental standards and built to last. In doing so we are compelled to respect our natural environment which is the very source of our beautiful and enduring designs.

As a company we endeavour to operate in the most innovative and efficient manner. Zuster’s recycling and waste management program sees us re-use and/or recycle 90% of our waste products. In 2020 Zuster has actively reduced our overall energy consumption by 20% across our three Australia-based factories. By 2021 our administrative process will be completely paperless.

### **Local manufacture**

Our company, like our furniture, is built upon five generations of design heritage. Each and every item we produce is designed with intention: an heirloom for future generations to cherish and enjoy. We achieve this by staying local.

As leaders in sustainable, locally produced furniture we are reducing our impact on the environment by producing local for locals. We are proud to use a majority of local suppliers and maintain our own manufacturing facilities within Australia. This allows us to support our local economy while also eliminating complex logistics and minimising transportation of products.

Our customers feel the positive impacts of this directly. Their investment in a Zuster piece is the beginning of a lifelong commitment, on our part, to restore and repair our pieces to their original glory. So your Zuster piece will last a lifetime, and beyond.

### **Mindful material use**

A Zuster design is not only timeless, it is durable, too. We use consciously sourced natural materials in the making of our products. We regularly review our use of raw materials to ensure continuous improvements in efficiencies of manufacture, as well as traceability.

Our timbers are selected for their low environmental impact. These are FSC-certified, PEFC-certified and chain of custody accredited. The mills from which we source meet stringent requirements in terms of forest regeneration, biodiversity and the protection of native fauna.

## Useful information

### **Care advice, maintenance and warranty:**

<https://zuster.com.au/pages/cleaning-care>

### **Showroom:**

33 Church Street, Hawthorn, Victoria, Australia 3122.  
Call +61 3 9852 8410 / Email [info@zuster.com.au](mailto:info@zuster.com.au)  
Visit [zuster.com.au](http://zuster.com.au)

