

Jade Wall Units

／ JAD310

Practical and beautiful, these slim-line wall mounted entertainment units can be made-to-order for any space. Opt for open shelving or drawers with doors that flip up or down.



zuster

Jade Wall Units

／ JAD310

Materials —

American Oak Veneer

Customisable —

This item is hand crafted and made to order

Also available in standard lengths of 2400mm & 3000mm. Custom sizes are available

Finishes —

Available in all Zuster timber finishes

Designed and hand crafted at Zuster HQ in Melbourne, Australia.

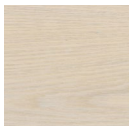

Limed Oak

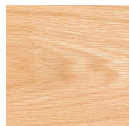

American Oak

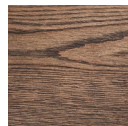

Hazelnut

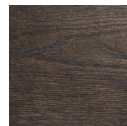

Coal



Slate

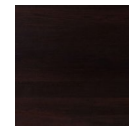

Saddle

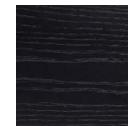

Mink

zuster

Jade Wall Units

／ JAD310

Standard Dimensions —

JAD310A

3 Open Shelves

2150 w x 380 d x 250 h (mm)

JAD310B

3 Flip up or Flip Down Doors

2150 w x 400 d x 250 h (mm)

JAD310C

2 Drawers + 1 Up or Down Flip Door

2150 w x 400 d x 250 h (mm)

JAD310D

3 Drawers

2150 w x 400 d x 250 h (mm)

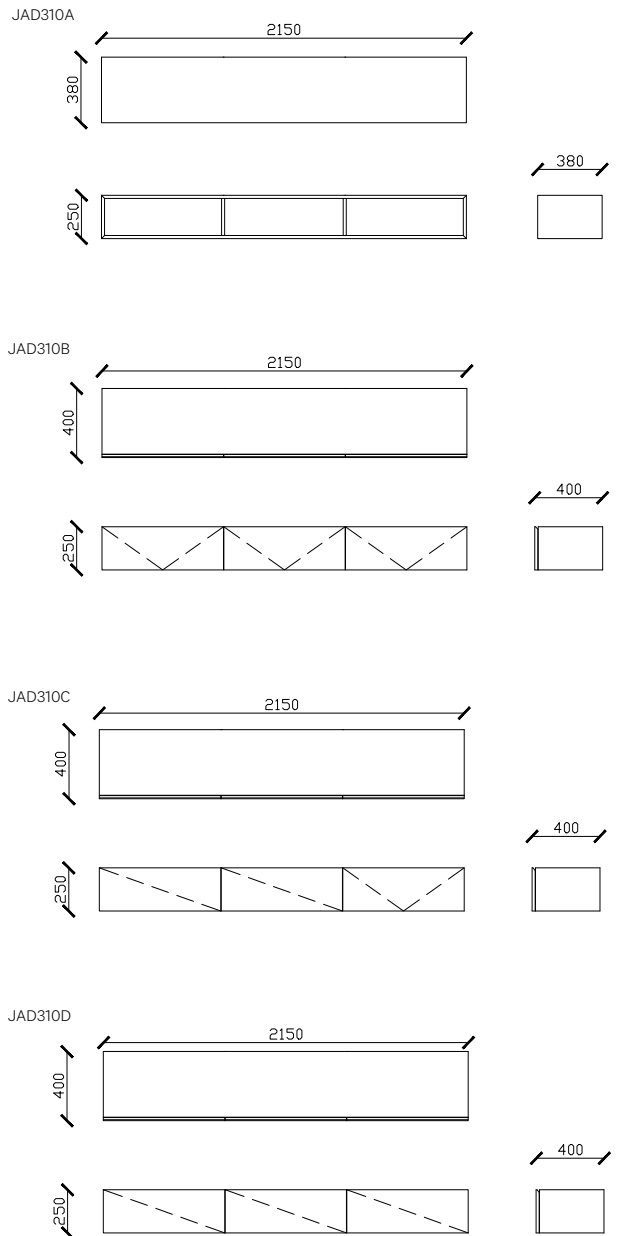

Sustainability

Our commitment

‘ Sustainability goes hand-in-hand with the integrity of our business and our beautiful, enduring products.’

Fleur Sibbel, Managing Director, Zuster.

Zuster is committed to designing pieces that are produced to the highest of environmental standards and built to last. In doing so we are compelled to respect our natural environment which is the very source of our beautiful and enduring designs.

As a company we endeavour to operate in the most innovative and efficient manner. Zuster’s recycling and waste management program sees us re-use and/or recycle 90% of our waste products. In 2020 Zuster has actively reduced our overall energy consumption by 20% across our three Australia-based factories. By 2021 our administrative process will be completely paperless.

Local manufacture

Our company, like our furniture, is built upon five generations of design heritage. Each and every item we produce is designed with intention: an heirloom for future generations to cherish and enjoy. We achieve this by staying local.

As leaders in sustainable, locally produced furniture we are reducing our impact on the environment by producing local for locals. We are proud to use a majority of local suppliers and maintain our own manufacturing facilities within Australia. This allows us to support our local economy while also eliminating complex logistics and minimising transportation of products.

Our customers feel the positive impacts of this directly. Their investment in a Zuster piece is the beginning of a lifelong commitment, on our part, to restore and repair our pieces to their original glory. So your Zuster piece will last a lifetime, and beyond.

Mindful material use

A Zuster design is not only timeless, it is durable, too. We use consciously sourced natural materials in the making of our products. We regularly review our use of raw materials to ensure continuous improvements in efficiencies of manufacture, as well as traceability.

Our timbers are selected for their low environmental impact. These are FSC-certified, PEFC-certified and chain of custody accredited. The mills from which we source meet stringent requirements in terms of forest regeneration, biodiversity and the protection of native fauna.

Useful information

Care advice, maintenance and warranty:

<https://zuster.com.au/pages/cleaning-care>

Showroom:

33 Church Street, Hawthorn, Victoria, Australia 3122.
Call +61 3 9852 8410 / Email info@zuster.com.au
Visit zuster.com.au



zuster