

Embellish Round Table

EMB200

Fashion meets furniture with luxurious embellishments of brass studs and marble to offset striking timber profiles.



zuster

Embellish Round Table

EMB200

Materials —

Solid American Oak table top sitting on an octagonal and round sectional pedestal base. Brass stud embellishments surround the table top and base round sections highlighting the design detail

Customisable —

This item is hand crafted and made to order
Custom sizes are available

Finishes —

Available in all Zuster timber finishes

Designed and hand crafted at Zuster HQ in Melbourne, Australia.



Limed Oak



American Oak

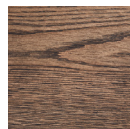

Hazelnut

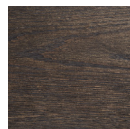

Coal

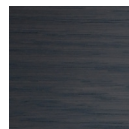

Slate

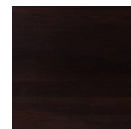

Saddle

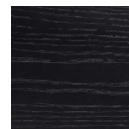

Mink



STU112



STU111



STU110



STU109



STU108



STU107



STU106



STU105



STU104



STU101

zuster

Embellish Round Table

EMB200

Standard Dimensions —

EMB200A

1000 dia x 730 h (mm)

EMB200B

1200 dia x 730 h (mm)

EMB200C

1600 dia x 730 h (mm)

EMB200D

1800 dia x 730 h (mm)

EMB200A

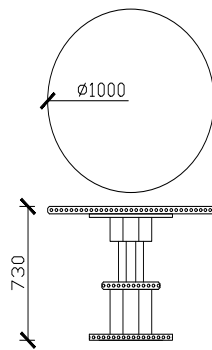

EMB200B

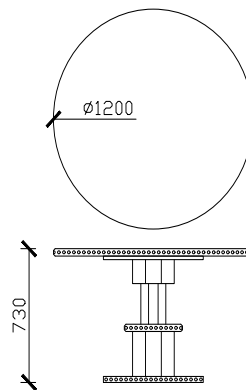

EMB200C

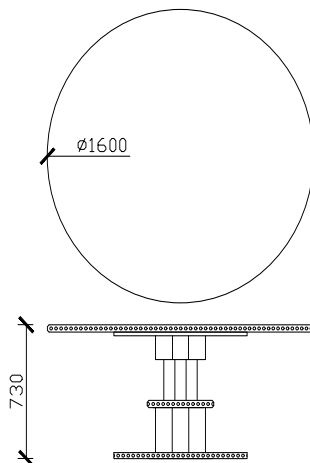

EMB200D

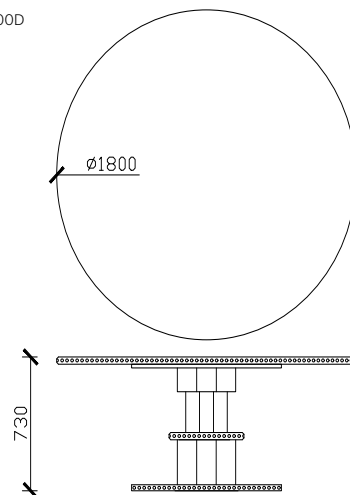

Seating Guide

To determine the number of chairs that can be placed comfortably around a table, consider not only the table's dimensions but also its leg style/placement overhang and the width of the chairs.

Our seating recommendations below are based on the Zuster Husk Dining Chair -520W x 520D x 765H

Round Meals Table Top Seating Guide

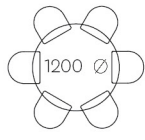

Seats 6

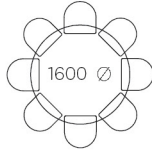

Seats 8

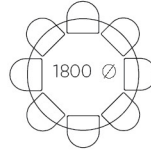

Seats 8

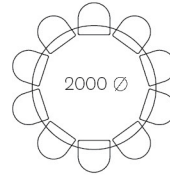

Seats 10

Oval Table Top Seating Guide

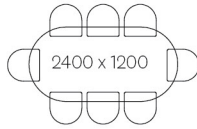

Seats 8-10

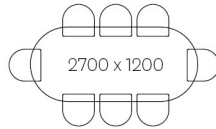

Seats 8-10

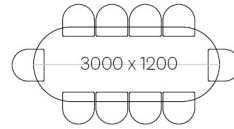

Seats 10-12

Rectang Table Top Seating Guide - April Inset Sleigh Legs

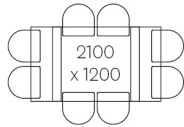

Seats 8

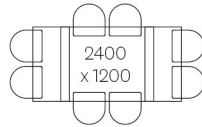

Seats 8

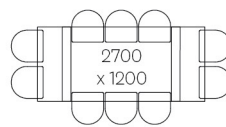

Seats 10

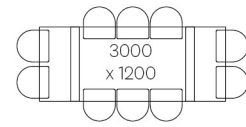

Seats 10

Rectangle Table Top Seating Guide - April Legs

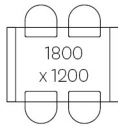

Seats 4-8

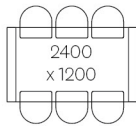

Seats 6-10

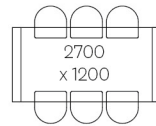

Seats 6-10

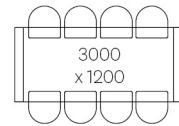

Seats 8-12

Rectangle Table Top Seating Guide - April Legs

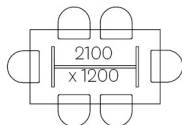

Seats 6

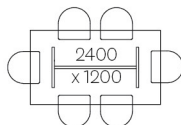

Seats 6

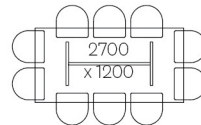

Seats 10

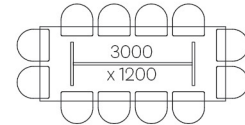

Seats 12

Cloud Table Top Seating Guide

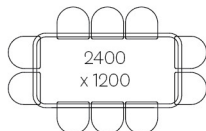

Seats 6-10

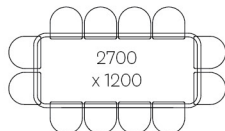

Seats 8-12

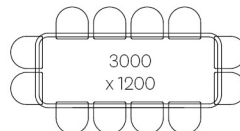

Seats 8-12

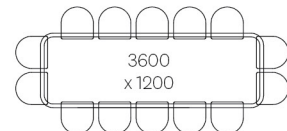

Seats 10-14

Rosette Table Top Seating Guide

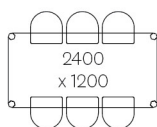

Seats 6-10

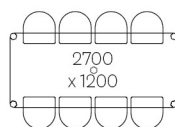

Seats 8-12

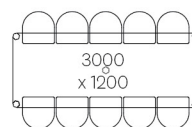

Seats 10-14

Sustainability

Our commitment

‘ Sustainability goes hand-in-hand with the integrity of our business and our beautiful, enduring products.’

Fleur Sibbel, Managing Director, Zuster.

Zuster is committed to designing pieces that are produced to the highest of environmental standards and built to last. In doing so we are compelled to respect our natural environment which is the very source of our beautiful and enduring designs.

As a company we endeavour to operate in the most innovative and efficient manner. Zuster’s recycling and waste management program sees us re-use and/or recycle 90% of our waste products. In 2020 Zuster has actively reduced our overall energy consumption by 20% across our three Australia-based factories. By 2021 our administrative process will be completely paperless.

Local manufacture

Our company, like our furniture, is built upon five generations of design heritage. Each and every item we produce is designed with intention: an heirloom for future generations to cherish and enjoy. We achieve this by staying local.

As leaders in sustainable, locally produced furniture we are reducing our impact on the environment by producing local for locals. We are proud to use a majority of local suppliers and maintain our own manufacturing facilities within Australia. This allows us to support our local economy while also eliminating complex logistics and minimising transportation of products.

Our customers feel the positive impacts of this directly. Their investment in a Zuster piece is the beginning of a lifelong commitment, on our part, to restore and repair our pieces to their original glory. So your Zuster piece will last a lifetime, and beyond.

Mindful material use

A Zuster design is not only timeless, it is durable, too. We use consciously sourced natural materials in the making of our products. We regularly review our use of raw materials to ensure continuous improvements in efficiencies of manufacture, as well as traceability.

Our timbers are selected for their low environmental impact. These are FSC-certified, PEFC-certified and chain of custody accredited. The mills from which we source meet stringent requirements in terms of forest regeneration, biodiversity and the protection of native fauna.

Useful information

Care advice, maintenance and warranty:

<https://zuster.com.au/pages/cleaning-care>

Showroom:

33 Church Street, Hawthorn, Victoria, Australia 3122.
Call +61 3 9852 8410 / Email info@zuster.com.au
Visit zuster.com.au



zuster