

Grundfos CUE

Frequency converters for pump control
50/60 Hz



be
think
innovate

GRUNDFOS 

1. Introduction	3	Surroundings	48
Grundfos CUE	3	Sound pressure level	48
Built-in E-pump functionality	3	Torques for terminals	48
Designed for Grundfos pumps	3	Cables	48
Further technical documentation	3	Inputs and outputs	49
		Fuses	50
2. Features and benefits	4	12. Accessories	53
User interface	4	Product numbers	53
Functions	4	Grundfos differential pressure sensor, DPI	59
Inputs and outputs	5	Temperature sensor, TTA	60
Standards	5	13. Grundfos Product Center	62
Accessories	5		
3. Identification	6		
Nameplate	6		
4. Applications	7		
Overview	7		
5. Product range	8		
Overview	8		
6. Functions	9		
Operating modes	9		
Control modes	9		
Setpoints	15		
PID controller	17		
Duty/standby, duty/assist and cascade	19		
Dry running	21		
Pump torque	22		
Start adjustments	24		
Pipe fill	25		
Operation	26		
Limit exceed	29		
Digital and Analog I/O	30		
7. Installation	32		
Mechanical installation	32		
Electrical installation	33		
RFI filters	34		
Output filters	35		
8. Operation/display	37		
Password protection	37		
9. Auto/manual restart after alarm	38		
10. CUE selection	39		
Selecting a CUE	39		
Special conditions	39		
Selection tables	41		
11. Technical data	46		
Main dimensions and weights, SI units	46		
Main dimensions and weights, US units	46		

1. Introduction

1.1 Grundfos CUE

CUE is a series of frequency converters designed for speed control of a wide range of Grundfos pumps.



TM11040039

Grundfos CUE solution

1.2 Built-in E-pump functionality

The CUE solution contains the same control functionality as Grundfos E-pumps and is thus a supplement to the E-pump range. See the table below.

Mains supply	Power size [kW (hp)]	
3 x 525-690 V	11 - 250 (15 - 350)	
3 x 525-600 V	0.75 - 90 (1 - 125)	
3 x 380-500 V	0.55 - 250 (0.75 - 350)	
3 x 380-480 V	1.5 - 22 (2 - 30)	
3 x 200-240 V	0.75 - 45 (1 - 60)	
1 x 200-240 V	0.37 - 1.1 (0.5 - 1.5)	1.1 - 7.5 (1.5 - 10)
	E-pumps	CUE

1.3 Designed for Grundfos pumps

CUE can be used in both new and existing installations, but the pump and motor must be suitable for use with frequency converters.

The table below shows the Grundfos pump types for which CUE is designed.

Pump type
AFG, SFG
AMG, SMG
BM
BMSHs, BMSHp
CM
CMV
CR, CRI, CRN, CRT
CRK
DP, EF
DPK, DWK
HS
KPL, KWM, KPG
LC, LF
MTH, MTR
MTB
MTS
NB, NK
NBG, NKG
S
SE, SEV, SL, SLV
SP,SP-G, SP-NE
SPK
SRG
TP series 100
TP series 200
TP series 300
VL
VLS

1.4 Further technical documentation

- The installation and operating instructions contain all information for putting CUE into operation.
- Technical documentation is available in Grundfos Product Center at www.grundfos.com. If you have any questions, contact the nearest Grundfos company or service workshop.

2. Features and benefits

2.1 User interface

The user interface offers these possibilities:

- Local operation via an operating panel with graphic display.
- Remote operation via external signals, for instance via digital inputs or GENIbus.
- Monitoring of operating status via indicator lights and signal relays.
- Display of alarms or warnings and logging.

2.2 Functions

Control modes for centrifugal pumps

CUE has a wide range of pump-specific functions:

- Open loop: The speed is kept at a set value in the range of the minimum and maximum speed.
- Proportional differential pressure: The differential pressure is reduced at a falling flow rate and increased at a rising flow rate.
- Constant differential pressure: The differential pressure is kept constant, independently of the flow rate.
- Constant pressure: The pressure is kept constant, independently of the flow rate.
- Constant level: The liquid level is kept constant, independently of the flow rate.
- Constant flow rate: The flow rate is kept constant, independently of the head.
- Constant temperature: The liquid temperature is kept constant, independently of the flow rate.
- Constant other value: Any other value is kept constant.

If the pump speed exceeds the rated speed, the pump will be overloaded.

Startup guide

CUE has a startup guide, which is started at the first startup. Here, a number of parameters are set automatically on the basis of the pump type. Other parameters are set manually on the basis of the data on the motor and pump nameplates. The startup guide can be repeated, if necessary. Thanks to the startup guide, the installer can quickly set central parameters and put CUE into operation.

Direction of rotation test

During the startup guide, CUE automatically tests and sets the correct direction of rotation without changing the cable connections if a pressure/flow sensor is connected. The direction of rotation test is performed manually if no sensor is connected.

Duty/standby

The duty/standby function is used to alternate between two pumps. Each pump is connected to a CUE unit. The primary task is to start the standby pump if the duty pump is stopped due to an alarm and to alternate the two pumps

at least every 24 hours. The duty/standby operation increases the security of supply and ensures that the standby pump does not get stuck.

Duty/assist

The duty/assist function is used to cascade additional pumps. Each pump is connected to a CUE unit. The cascade control ensures that the performance of the pumps is automatically adapted to consumption by switching on or off pumps and by changing the speed of the pumps in operation. The system runs as energy-efficiently as possible with a limited number of pumps. When more than one pump is running in steady state, the pumps run at the same speed and are controlled by the PI controller of the master pump. As standard, the pump with the lowest number is the master pump.

Dry-running protection

To protect the pump, select the dry-running function together with an external sensor so that lack of inlet pressure or water shortage can be detected.

Low-flow stop function

In constant pressure or constant level control mode, the stop function is used for changing between on/off operation at low flow rate and continuous operation at high flow rate. The low-flow stop function protects the pump and saves energy.

Monitoring of lubrication of motor bearings

When the bearing monitoring function is active, a warning will appear in the display when the motor bearings are to be relubricated or replaced.

2.3 Inputs and outputs

CUE is equipped with a number of inputs and outputs:

- 1 RS-485 GENibus connection
- 1 analog input, 0-10 V, 0/4-20 mA
 - external setpoint
- 1 analog input, 0-10 V, 0/4-20 mA
 - sensor input, feedback sensor
- 1 analog output, 0/4-20 mA (depends on the output signal)
- 6 digital inputs
 - 2 inputs can be changed to digital outputs
 - all digital inputs and outputs are programmable
- 2 signal relays (C/NO/NC)
 - programmable.

2.4 Standards

CUE is designed according to the following directives and standards:

EMC Directive 2004/108/EC

- EN 50011
- EN 61000-6-3
- EN 61800-3

Low Voltage Directive 2006/95/EC

- EN 50178
- EN 61800-5-1:2003/IEC 61800-5-1:2003
- EN 61800-3:2005/IEC 61800-3:2004/IEC 60034-11
- EN 6034-12/IEC 60034-12/IEC 60038/IEC 62114
- EN 50102
- EN ISO 2409
- EN ISO 3743-1
- EN ISO 4871
- EN ISO 11203
- DIN 44082.

CUE variants with safe torque off (STO) are also designed according to the following directives and standards:

Machine Directive 2006/42/EC

- EN ISO 13849-1
- EN IEC 62061
- EN IEC 61800-5-2

Safety of Machinery

- EN ISO 13849-1/IEC 62061/IEC 60204-1

Functional Safety

- IEC 61508-1 to -7/ IEC 61800-5-2

Safety function

- IEC 618-5-2 (safe torque off, STO)
- IEC 60204-1 (stop category 0).

2.5 Accessories

Grundfos offers a number of accessories for CUE.

MCB 114 sensor input module

MCB 114 is an option offering additional analog inputs for CUE:

- 1 analog input, 0/4-20 mA
- 2 inputs for Pt100/Pt1000 temperature sensors.

MCO 101 multipump module

MCO 101 is an option offering cascade of multiple CUEs.

- cascade of up to 6 CUEs.

Output filters

Output filters are used primarily for protecting the motor against overvoltage and increased operating temperature. However, output filters can also be used for reduction of acoustic motor noise.

Grundfos provides two types of output filter as accessories for CUE:

- dU/dt filters
- sine-wave filters.

Floor mounting option

CUE is installed on the wall by default. The enclosures D1h and D2h can also be installed on the floor on a pedestal designed for that purpose.

For information about enclosures, see the section about technical data.

IP21/NEMA1 option

An IP20 enclosure can be upgraded to IP21/NEMA1 by using the IP21/NEMA1 option. The power terminals (mains and motor) will be covered.

3. Identification

3.1 Nameplate

CUE can be identified by means of the nameplate. An example is shown below.



TM043272

Example of nameplate

Text	Description
T/C:	CUE (product name) 202P1M2... (internal code)
Prod. no:	Product number: 12345678
S/N:	Serial number: 123456G234 The last three digits indicate the production date: 23 is the week, and 4 is the year 2004.
1.5 kW (2 hp)	Typical shaft power of the motor
IN:	Supply voltage, frequency and maximum input current
OUT:	Motor voltage, frequency and maximum output current. The maximum output frequency usually depends on the pump type.
CHASSIS/IP20	Enclosure class
Tamb.	Maximum ambient temperature

4. Applications

4.1 Overview

CUE is a multi-purpose frequency converter suitable for a variety of applications demanding reliable and cost-efficient pump operation.

CUE is used in five main fields of application:

Water supply and pressure boosting

Besides general water supply in municipal and industrial waterworks, CUE is used for these specific applications:

- water supply
- pressure boosting
- washing.

The typical control modes are constant pressure or constant flow rate. Stop functions are used to stop the pump when the water flow is low.

Heating and air-conditioning

Liquid transfer:

- heating applications
- cooling and air-conditioning applications.

The typical control modes are proportional pressure or constant temperature.

Process and sanitary applications

Liquid transfer:

- breweries and dairies
- pure-water applications
- process applications
- purification applications.

CUE is typically controlled by an external controller. The typical control mode is open loop.

Groundwater

Typical applications:

- groundwater supply to waterworks
- irrigation in horticulture and agriculture
- dewatering.

The typical control modes are constant pressure, constant flow rate or constant level control.

Wastewater

Transfer of water:

- wastewater
- effluent
- drainage water
- process water.

The typical control mode is constant level function (emptying function).

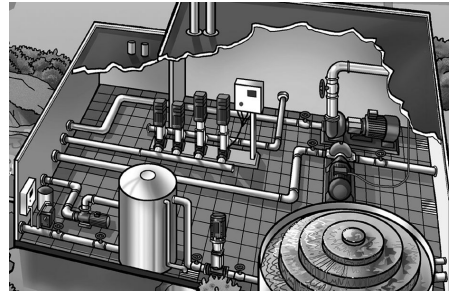

TM030146

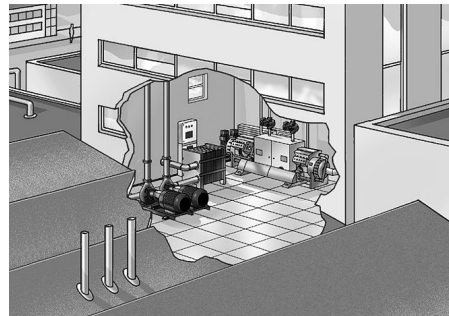

TM030147

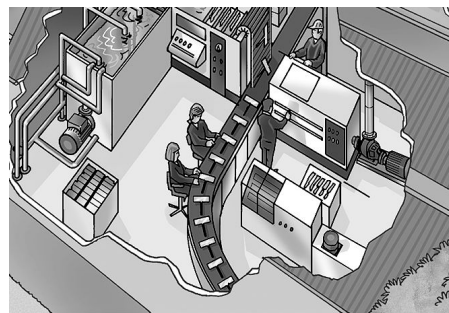

TM030148



TM030149

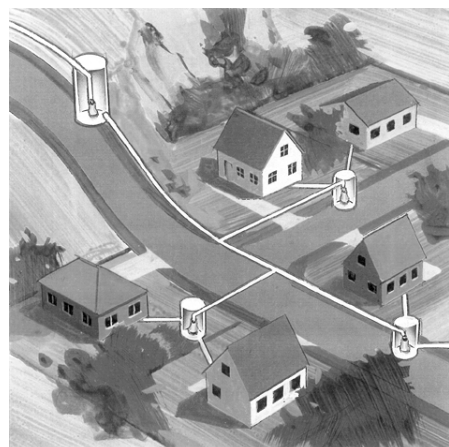

FIG57

5. Product range

5.1 Overview

The CUE cabinet sizes are characterised by their enclosures. The table shows the relation between power size (P2), mains supply (V) and enclosure class (IP). It shows the complete range of CUE.

Typical shaft power P2		Mains supply and enclosure class													
		1 x 200-240 V			3 x 200-240 V		3 x 380-500 V				3 x 525-600 V		3 x 525-690 V		
[kW]	[hp]	IP20	IP21	IP55	IP20	IP55	IP20	IP21	IP54	IP55	IP20	IP55	IP21	IP54	IP55
0.55	0.75						•			•					
0.75	1				•	•	•			•	•	•			
1.1	1.5	•		•	•	•	•			•	•	•			
1.5	2		•	•	•	•	•			•	•	•			
2.2	3		•	•	•	•	•			•	•	•			
3	4		•	•	•	•	•			•	•	•			
3.7	5		•	•	•	•									
4	5						•			•	•	•			
5.5	7.5		•	•	•	•	•			•	•	•			
7.5	10		•	•	•	•	•			•	•	•			
11	15				•	•	•			•	•	•	•		•
15	20				•	•	•			•	•	•	•		•
18.5	25				•	•	•			•	•	•	•		•
22	30				•	•	•			•	•	•	•		•
30	40				•	•	•			•	•	•	•		•
37	50				•	•	•			•	•	•	•		•
45	60				•	•	•			•	•	•	•		•
55	75						•			•	•	•	•		•
75	100						•			•	•	•	•		•
90	125						•			•	•	•	•		•
110	150							•	•				•	•	
132	200							•	•				•	•	
160	250							•	•				•	•	
200	300							•	•				•	•	
250	350							•	•				•	•	

For further information, see the section about selection tables.

Related information

10.3 Selection tables

6. Functions

6.1 Operating modes

These operating modes can be selected with CUE:

- Normal
- Stop
- Min. curve
- Max. curve
- User curve.

The operating modes are set on the operating panel using the [Favourites] menu. The operating modes can be set without changing the setpoint setting.

6.1.1 Normal

The pump operates in the control mode selected. The control modes are different ways of controlling the pump speed when the operating mode is set to "Normal".

6.1.2 Stop

The pump has been stopped by the user.

6.1.3 Min. curve

The pump is running at a set minimum speed value. See the figure about minimum and maximum curves.

For instance, this operating mode can be used during periods with a very small flow requirement.

6.1.4 Max. curve

The pump is running at a set maximum speed value.

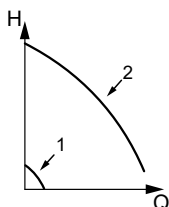

TM038813

Min. and max. curves

Pos.	Description
1	Min.
2	Max.

6.1.5 User curve

The pump is running at a user-defined speed.

6.2 Control modes

CUE has a built-in PID controller that provides closed-loop control of the value you want to control. CUE can also be set to open-loop control where the setpoint represents the desired pump speed. The control modes are set on the operating panel in the startup guide or changed using the [Favourites] menu.

Open loop is typically used without a sensor. All other control modes require a sensor.

6.2.1 Overview

Pump type	Open loop	Proportional differential pressure	Constant differential pressure	Constant pressure	Constant level	Constant flow rate	Constant temperature	Constant other value
AFG, SFG	•				•	•		•
AMG, SMG	•				•	•		•
BM	•			•	•	•		•
BMSHs, BMSHp	•			•	•	•		
CM, CMV	•			•	•	•		•
CR, CRI, CRN, CRT	•			•	•	•		•
CRK	•			•	•	•	•	•
DP, EF	•			•	•	•		•
DRK, DWK	•				•	•		•
HS	•		•	•		•	•	•
KPL, KWM, KPG	•				•	•		•
LC, LF	•		•	•		•	•	•
MTH, MTR	•			•	•	•	•	•
MTS	•			•		•		•
MTB	•			•	•	•	•	•
NB, NK	•		•	•	•	•	•	•
NBG, NKG	•		•	•	•	•	•	•
S	•			•	•	•		•
SE, SEV, SL, SLV	•			•	•			•
SMD	•				•	•		•
SP, SP-G, SP-NE	•			•	•	•	•	•
SPK	•			•	•	•		•
SRG	•					•	•	•
TP series 100	•	•	•	•	•	•	•	•
TP series 200	•	•	•		•	•	•	•
TP series 300	•	•	•		•	•	•	•
VL	•			•	•	•	•	•
VLS	•	•	•		•	•		•

Related information

- 6.2.2 Open loop, constant curve
- 6.2.3 Constant pressure
- 6.2.4 Constant pressure with stop function
- 6.2.5 Constant differential pressure, pump
- 6.2.6 Constant differential pressure, system
- 6.2.7 Differential pressure from two sensors
- 6.2.8 Proportional differential pressure
- 6.2.9 Hmax. update
- 6.2.10 Constant flow rate
- 6.2.11 Constant level
- 6.2.12 Constant level with stop function
- 6.2.13 Constant temperature
- 6.2.14 Constant other value

6.2.2 Open loop, constant curve

The speed is kept at a set value in the range between the minimum and maximum curves.

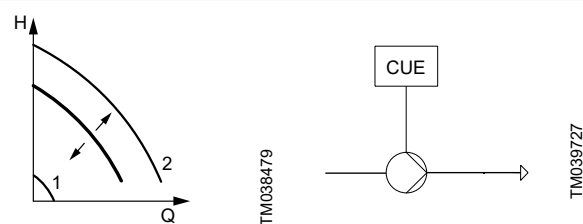

Open loop, constant curve

Pos.	Description
1	Min.
2	Max.

In "Open loop" control mode, the setpoint is set in percentage of the nominal speed. The setting range is between the minimum and maximum curves.

Operation on constant curve can for instance be used for pumps with no sensor connected.

This control mode is also typically used in connection with an overall control system such as Control MPC or another external controller.

6.2.3 Constant pressure

The outlet pressure is kept constant, independently of the flow rate.

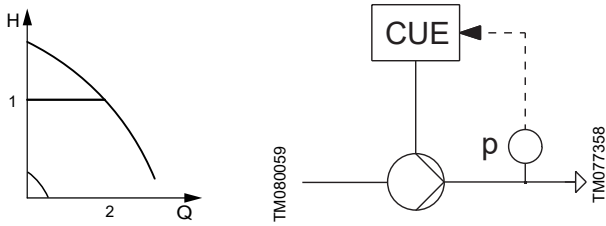

Pos.	Description
1	H_{set}
2	$Q_{max.}$

Constant pressure

The pump is controlled according to a constant pressure measured after the pump. This means that the pump offers a constant pressure in the Q-range of 0 to $Q_{max.}$, represented by the horizontal line in the QH diagram.

6.2.4 Constant pressure with stop function

The outlet pressure is kept constant at high flow rate ($Q > Q_{min.}$). On/off operation at low flow rate.

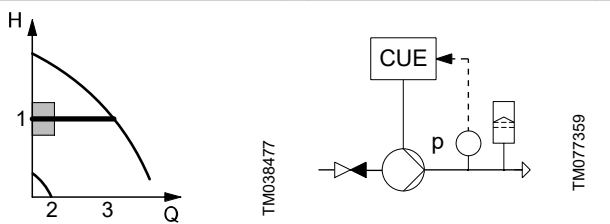

Constant pressure with stop function

Pos.	Description
1	H_{set}
2	$Q_{min.}$
3	$Q_{max.}$

The pump is controlled according to a constant pressure measured after the pump. This means that the pump offers a constant pressure in the Q-range of $Q_{min.}$ to $Q_{max.}$, represented by the horizontal line in the QH diagram.

The Stop function is activated by default for constant pressure, but can be deactivated in parameter 200-19 "Stop function".

The purpose of the stop function is to stop the pump when low or no flow is detected. When low flow is detected, the pump is in on/off operation. If there is flow, the pump continues to operate according to the setpoint.

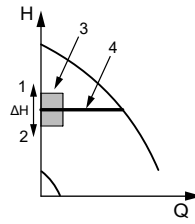

Constant pressure with stop function. Difference between start and stop pressures (ΔH)

Pos.	Description
1	Stop pressure
2	Start pressure
3	On/off operation
4	Continuous operation

Low flow can be detected in two different ways:

- with the built-in low-flow detection function
- with a flow switch connected to a digital input.

The low-flow detection function checks the flow regularly by reducing the speed for a short time. No or only a small change in pressure means that there is low flow.

When a flow switch detects low flow, the digital input is activated.

It is only possible to use the stop function if the system incorporates these components:

- a pressure sensor
- a non-return valve
- a diaphragm tank.

The non-return valve must always be installed before the pressure sensor.

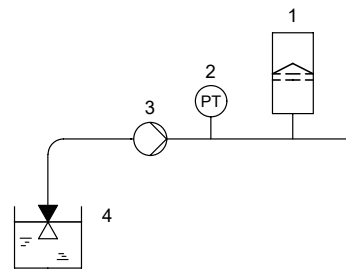

Position of the non-return valve and pressure sensor in a system with suction lift

Pos.	Description
1	Diaphragm tank
2	Pressure sensor
3	Pump
4	Non-return valve

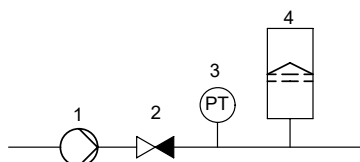

TM038583

Position of the non-return valve and pressure sensor in a system with positive inlet pressure

Pos.	Description
1	Pump
2	Non-return valve
3	Pressure sensor
4	Diaphragm tank

The stop function requires a diaphragm tank of a certain minimum size. The tank must be installed as close as possible after the pump, and the precharge pressure must be 0.7 x actual setpoint.

Recommended diaphragm tank sizes:

Rated flow rate of pump [m ³ /h (gpm)]	Typical diaphragm tank size [litres (gallons)]
0-6 (0-26)	8 (2)
7-24 (26-110)	18 (5)
25-40(110-180)	50 (13)
41-70 (180-310)	120 (32)
71-100 (310-440)	180 (48)

If a diaphragm tank of the above size is installed in the system, the factory setting of ΔH is the correct setting. If the tank installed is too small, the pump starts and stops too often.

The stop function is default activated in constant pressure applications. If not desired, it can be deactivated in parameter 200-19 "Stop function".

6.2.5 Constant differential pressure, pump

The differential pressure of the pump is kept constant, independently of the flow rate.

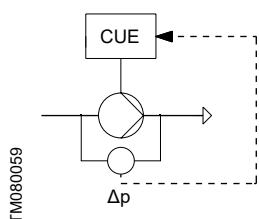
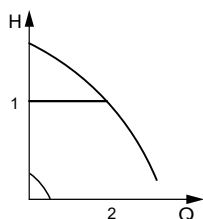

TM080059

TM077356

Pos.	Description
1	H_{set}
2	$Q_{max.}$

Constant differential pressure, pump

The pump is controlled according to a constant differential pressure measured across the pump. This means that the pump system offers constant differential pressure in the Q-range of 0 to $Q_{max.}$, represented by the horizontal line in the QH diagram.

6.2.6 Constant differential pressure, system

The differential pressure of the system is kept constant, independently of the flow rate.

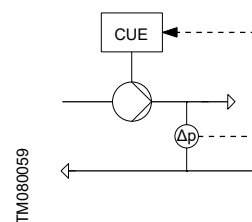
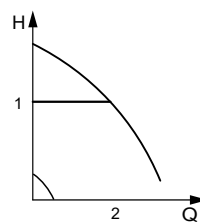

TM080059

TM038806

Pos.	Description
1	H_{set}
2	$Q_{max.}$

Constant differential pressure, system

The pump is controlled according to a constant differential pressure measured across the system. This means that the pump offers constant differential pressure of the system in the Q-range of 0 to $Q_{max.}$, represented by the horizontal line in the QH diagram.

6.2.7 Differential pressure from two sensors

The purpose of this function is to make differential pressure control possible by using measurements from two separate pressure sensors. It can be used in these control modes:

- proportional differential pressure
- constant differential pressure.

The function requires an MCB 114 sensor input module.

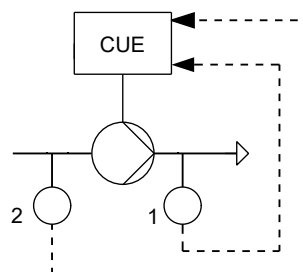

TM040622

Differential pressure from two sensors

Pos.	Description
1	Sensor 1
2	Sensor 2

Sensor 1 is connected to sensor input 1.

Sensor 2 is connected to sensor input 2 of an MCB 114 sensor input module.

6.2.8 Proportional differential pressure

The differential pressure of the pump is reduced at falling flow rate and increased at rising flow rate.

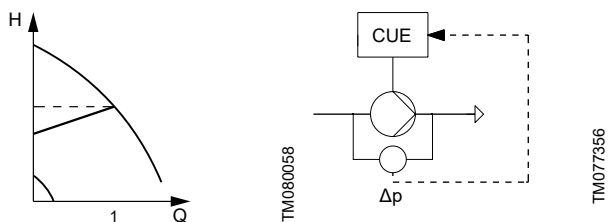

Pos.	Description
1	$Q_{max.}$

Proportional differential pressure

The pump is controlled according to a differential pressure measured across the pump. This means that the pump system offers a proportional differential pressure in the Q-range of 0 to $Q_{max.}$, represented by the sloping line in the QH diagram.

The proportional differential pressure can be selected with one of these flow dependencies:

- linear, default
- quadratic.

When the flow dependency is selected as quadratic, the differential pressure of the pump is reduced with a quadratic curve at falling flow rate and increased at rising flow rate.

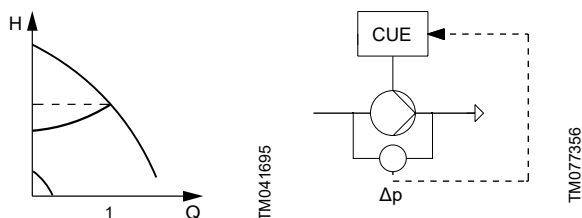

Pos.	Description
1	$Q_{max.}$

Proportional differential pressure, quadratic curve

The pump is controlled according to a differential pressure measured across the pump. This means that the pump system offers a flow-compensated differential pressure in the Q-range of 0 to $Q_{max.}$, represented by the quadratic curve in the QH diagram.

6.2.9 $H_{max.}$ update

This function can be used in connection with the control mode Proportional differential pressure. The purpose is to find the "true" value of the maximum head at no flow and nominal pump speed.

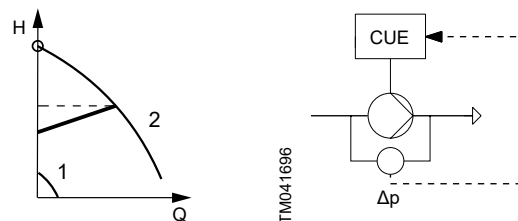

Pos.	Description
1	Min.
2	Max.

Proportional differential pressure, $H_{max.}$ update

The function consists of two steps:

1. Ramping up the speed to nominal speed.
2. Measuring $H_{max.}$ for 20 seconds at nominal speed.

Valves must be closed so that the pump is operating without flow.

6.2.10 Constant flow rate

The flow rate is kept constant, independently of the head.

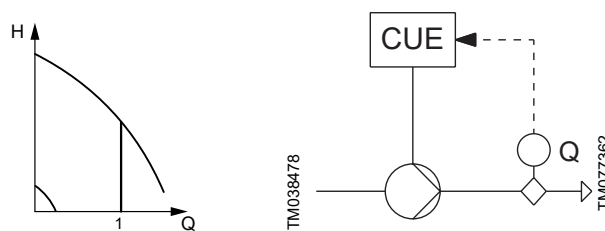

Pos.	Description
1	Q_{set}

Constant flow rate

The pump is controlled according to a constant flow rate, represented by the vertical line in the QH diagram.

6.2.11 Constant level

The liquid level is kept constant, independently of the flow rate.

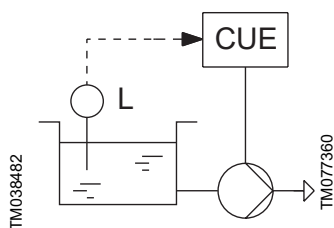
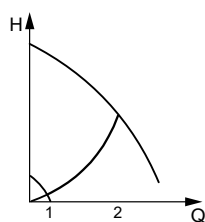

Pos.	Description
1	$Q_{min.}$
2	$Q_{max.}$

Constant level

The pump is controlled according to a constant liquid level. This means that the pump offers a constant level in the Q-range of $Q_{min.}$ to $Q_{max.}$, represented by the quadratic line in the QH diagram.

The function is an emptying function by default.

6.2.12 Constant level with stop function

The liquid level is kept constant at high flow rate. On/off operation is at low flow rate.

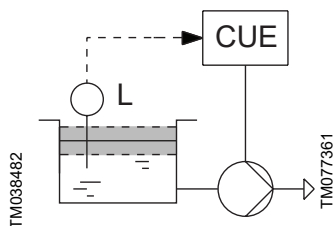
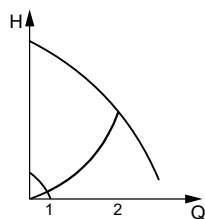

Pos.	Description
1	$Q_{min.}$
2	$Q_{max.}$

Constant level with stop function

The pump is controlled according to a constant liquid level. This means that the pump offers a constant level in the Q-range of $Q_{min.}$ to $Q_{max.}$, represented by the quadratic line in the QH diagram.

The function is an emptying function by default.

The purpose of the stop function is to stop the pump when low or no flow is detected. When low flow is detected, the pump is in on/off operation. If there is flow, the pump continues to operate according to the setpoint.

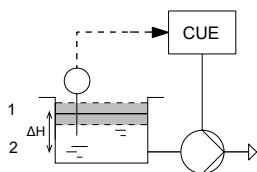

Constant level with stop function. Difference between start and stop levels (ΔH)

Pos.	Description
1	Start level
2	Stop level

Low flow can be detected in two different ways:

- with the built-in low-flow detection function
- with a flow switch connected to a digital input.

The low-flow detection function checks the flow regularly by measurement of speed and power.

When a flow switch detects low flow, the digital input is activated.

It is only possible to set constant level with stop function if the system incorporates a level sensor, and all valves can be closed.

The stop function is default activated in constant pressure applications. If not desired, it can be deactivated in parameter 200-19 "Stop function".

6.2.13 Constant temperature

The liquid temperature is kept constant, independently of the flow rate.

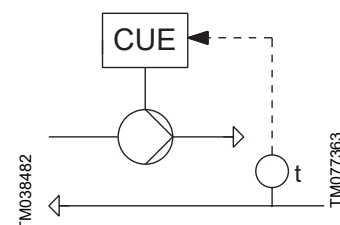
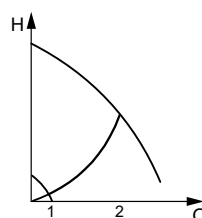

Pos.	Description
1	$Q_{min.}$
2	$Q_{max.}$

Constant temperature

The pump is controlled according to a constant temperature. This means that the pump offers a variable flow rate in the Q-range of $Q_{min.}$ to $Q_{max.}$, represented by the quadratic line in the QH diagram.

6.2.14 Constant other value

Any other value is kept constant. See the CUE installation and operation instructions for further information.

6.3 Setpoints

The setpoint is normally set in the startup guide and changed via the [Favourites] menu on the CUE operating panel. If needed, the setpoint can be influenced via the external setpoint input.

CUE offers these setpoint possibilities:

- External setpoint
- Predefined setpoints
- GENIbus setpoint.

The setpoint range depends on the selected control mode:

- In "Open loop" control mode, the setpoint is set in percentage corresponding to the required speed. The setting range is between the minimum and maximum curves in percentage of nominal frequency.
- In "Proportional differential pressure" control mode, the setting range is equal to 25 % to 90 % of maximum head.
- In all other control modes, the setting range is equal to the sensor measuring range.

6.3.1 External setpoint influence

The setpoint can be influenced by connecting an analog signal to the external setpoint input and is activated in the startup guide.

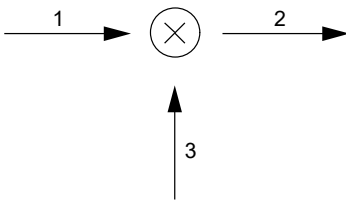

TM040373

Setpoint, CUE menu and external setpoint signal

Pos.	Description
1	Setpoint, CUE menu
2	Actual setpoint
3	External setpoint signal

The signal can influence the actual setpoint by these possibilities of the function:

- External setpoint, default
- Inverse external setpoint
- External setpoint with stop
- External setpoint based on a reference table.

The external setpoint signal is used for calculating the actual setpoint. The minimum signal is the minimum setpoint, and the maximum signal is the normal setpoint set via the CUE [Favourites] menu "202-0x".

6.3.1.1 External setpoint, default

The actual setpoint is a linear function of the external setpoint signal.

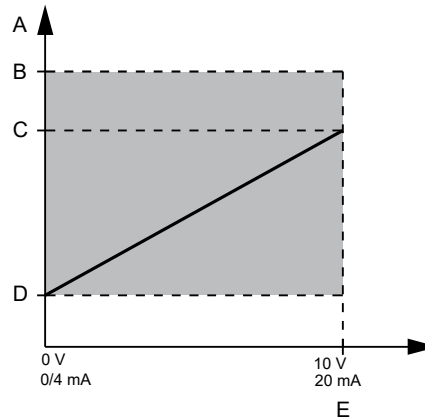

TM040626

External setpoint

Pos.	Description
A	Actual setpoint
B	Max.
C	Setpoint, CUE menu
D	Min.
E	External setpoint signal

The minimum and maximum values of the external setpoint signal are default within the full-scale from 0-10 V (0/4-20 mA), but can be set in the [Main] menu group 200-1x "Setpoint Handling".

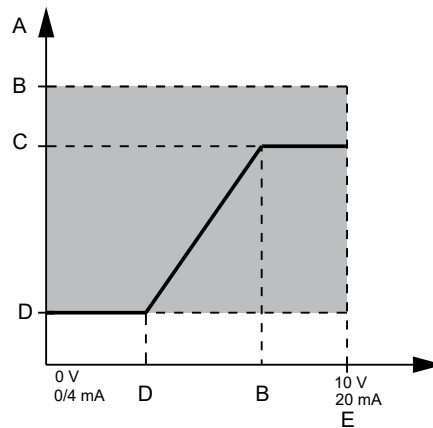

TM040363

Reduced external setpoint signal

Pos.	Description
A	Actual setpoint
B	Max.
C	Setpoint, CUE menu
D	Min.
E	External setpoint signal

6.3.1.2 Inverse external setpoint

The actual setpoint is an inverse linear function of the external setpoint signal and is activated in [Main] menu parameter 200-10 "External setpoint".

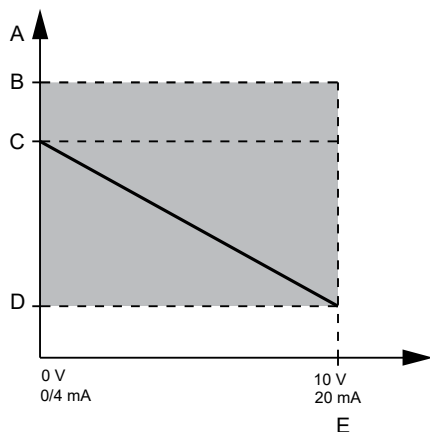

TM040627

Inverse external setpoint signal

Pos.	Description
A	Actual setpoint
B	Max.
C	Setpoint, CUE menu
D	Min.
E	External setpoint signal

The maximum and minimum values of the external setpoint signal are default within the full-scale from 0-10 V (0/4-20 mA), but can be set in the [Main] menu group 200-1x "Setpoint Handling".

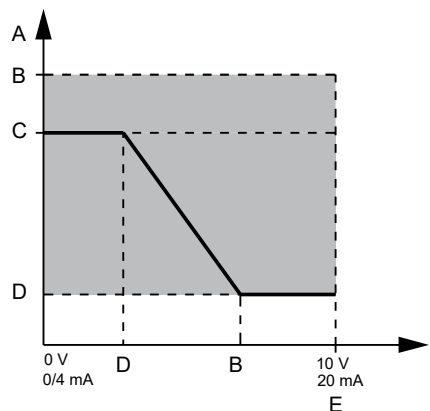

TM040365

Reduced inverse external setpoint signal

Pos.	Description
A	Actual setpoint
B	Max.
C	Setpoint, CUE menu
D	Min.
E	External setpoint signal

6.3.1.3 External setpoint with stop function

The actual setpoint with stop is a linear function of the external setpoint signal above 20 % signal and on/off operation below 20 % signal. Linear with stop is selected in [Main] menu parameter 200-10 "External setpoint".

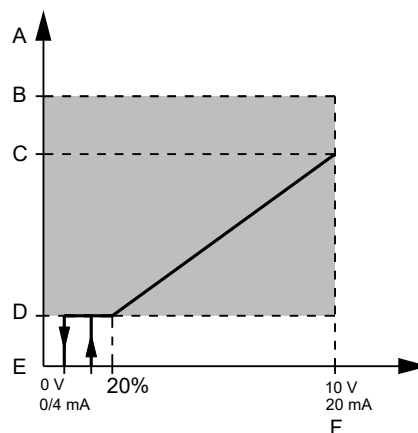

TM040364

External setpoint with stop function

Pos.	Description
A	Actual setpoint
B	Max.
C	Setpoint, CUE menu
D	Min.
E	Stop
F	External setpoint signal

When the external setpoint signal is below 10 %, the operating mode is "Stop".

When the external setpoint signal is above 15 %, the operating mode is "Normal".

6.3.1.4 External setpoint based on a reference table

The actual setpoint is a piecewise linear function of the external setpoint signal and is activated in [Main] menu parameter 200-10 "External setpoint".

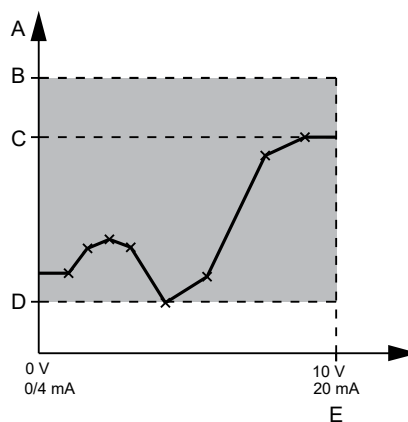

TM040366

External setpoint based on a reference table

Pos.	Description
A	Actual setpoint
B	Max.
C	Setpoint, CUE menu
D	Min.
E	External setpoint signal

The linear function is defined as an interpolation between the points in a table. The table has up to eight points that are adjustable in the [Main] menu group 200-1x "Setpoint Handling".

6.3.2 Predefined setpoints

This function makes it possible to select up to seven predefined setpoints using one to three digital inputs. The setpoints are selected as a binary coding of the digital inputs as shown in the table below. The predefined setpoints are adjustable in [Main] menu parameter 310 "Preset Reference".

Predefined setpoint	DI 2	DI 3	DI 4
15 %	x		
30 %		x	
45 %	x	x	
60 %			x
75 %	x		x
90 %		x	x
100 %	x	x	x

x = Closed contact

If none of the digital inputs are activated, the operating mode can be configured to "Stop" or to being controlled according to a setpoint set via the [Main] menu parameter 200-18 "Predefined Setpoint Zero Function".

If "Min.", "Max." or "Stop" is selected via the operating panel, the predefined setpoints are overruled.

Predefined setpoints cannot be influenced by the external setpoint input.

6.3.3 GENibus setpoint

If CUE is remote-controlled via the GENibus input, the setpoint is set via the bus.

The GENibus setpoint cannot be influenced by the external setpoint signal.

6.4 PID controller

CUE has a built-in PID controller for speed control of pumps. The factory setting of gain (K_p) and integral time (T_i) are automatically adjusted to suggested settings based on the control mode chosen. The values can easily be changed in the operating panel.

The controller can operate in both normal and inverse mode and is selected in parameter 20-81 "PID Normal/Inverse Control".

Normal mode

Normal mode is used in systems in which an increase in pump performance results in a rise in the value measured at the feedback sensor. This will typically be the case in most CUE applications.

Inverse mode

Inverse mode is used in systems in which an increase in pump performance will result in a drop in the value measured at the feedback sensor. This mode will typically be used for constant level operation (emptying tank) and for constant temperature operation in cooling systems.

Negative K_p value corresponds to inverse mode.

Description

The PID controller compares the required setpoint (p_{set}) with the actual value (p) measured by the transmitter (P).

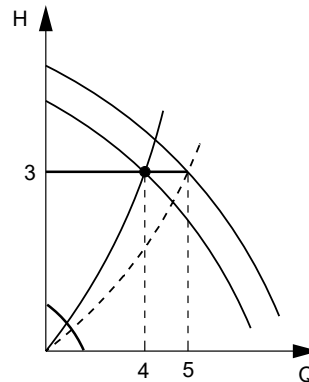
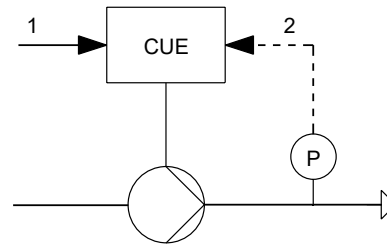

Constant pressure control

Pos.	Description
1	Setpoint p_{set}
2	Measured value p
3	P_{set}
4	Q
5	Q_{max}

TM040367

If the measured value is higher than the required setpoint, the PID controller will reduce the speed and the performance of the pump until the measured value is equal to the required setpoint.

Suggested controller settings

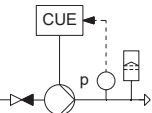
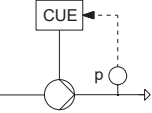
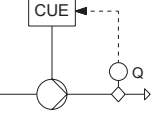
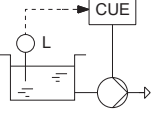
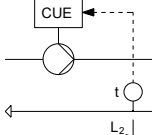
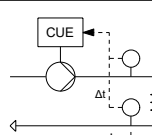
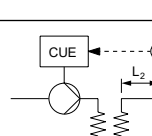
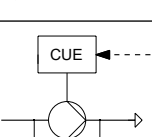
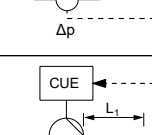
System/application	K_p		T_i
	Heating system 1)	Cooling system 2)	
	0.2		0.5
TM077359	SP, SP-G, SP-NE: 0.5		0.5
	0.2		0.5
TM077358	SP, SP-G, SP-NE: 0.5		0.5
	0.2		0.5
TM077362			0.5
	-2.5		100
TM077360			100
	0.5	-0.5	$10 + 5L_2$
TM039095			$10 + 5L_2$
	0.5		$10 + 5L_2$
TM039096			$10 + 5L_2$
	0.5	-0.5	$30 + 5L_2^*$
TM039097			$30 + 5L_2^*$
	0.5		0.5^*
TM077356			0.5^*
	0.5		$L_1 < 5 \text{ m (16 ft): } 0.5^*$ $L_1 > 5 \text{ m (16 ft): } 3^*$ $L_1 > 10 \text{ m (32 ft): } 5^*$
TM039098			$L_1 < 5 \text{ m (16 ft): } 0.5^*$ $L_1 > 5 \text{ m (16 ft): } 3^*$ $L_1 > 10 \text{ m (32 ft): } 5^*$

* $T_i = 100$ seconds (default).

Heating systems are systems in which an increase in pump performance will result in a rise in temperature at the sensor.

Cooling systems are systems in which an increase in pump performance will result in a drop in temperature at the sensor.

L_1 = Distance in [m (ft)] between pump and sensor.

L_2 = Distance in [m (ft)] between heat exchanger and sensor.

The setting of gain (K_p) and integral time (T_i) can be manually changed in the operating panel via the [Main] menu group 20-9x "PID Controller".

6.5 Duty/standby, duty/assist and cascade

Use the startup guide for setting the multipump system with the following options:

- No (used for CUE controlling single pumps)
- Variable and fixed speed
- Variable speed only.

6.5.1 Duty/standby

The built-in duty/standby function applies to variable speed only pumps connected in parallel to ensure reliability of supply.

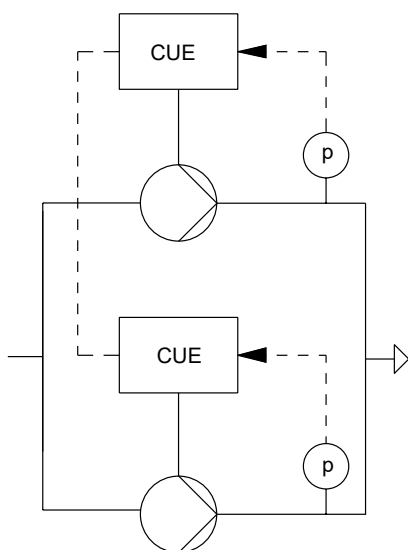

Two pumps connected in parallel and controlled via Modbus RTU

The duty/standby function is set by choosing "Variable speed only" in the startup guide, then followed by setting the desired function to "Alternation" or "Back-up".

These are the primary purposes of the function:

- To let one pump run at a time.
- To start the standby pump if the duty pump stops due to an alarm.
- To alternate the pumps at least every 24 hours, only if alternation function is selected.

The two pumps are electrically connected by means of the Modbus RTU protocol on the GENIbus port.

The two pumps running duty/standby in this way cannot use the GENIbus interface for remote communication. The two pumps use their own local operating mode. See the section about operating modes.

Both pumps must have the same control mode. See the section about control modes.

Related information

6.1 Operating modes

6.2 Control modes

6.5.2 Duty/assist and variable-speed cascade

The duty/assist and variable-speed cascade functions are used to cascade additional variable speed pumps. Each pump is connected to a CUE unit. See the figure about two pumps connected in parallel and controlled via Modbus RTU.

Related information

6.5.1 Duty/standby

6.5.2.1 Setting the duty pump

The duty/assist function is set by selecting "Variable speed only" in the startup guide, then followed by setting the desired function to "Cascade".

If there are more than two pumps in the system, the duty CUE must be fitted with an MCO 101 option. The variable speed cascade function is then set by choosing "Variable speed only" in the startup guide, then followed by setting the total number of pumps in the system.

6.5.2.2 Setting one or more assist pumps

Use the startup guide to set the control mode to open loop, then confirm that the pump is an assist pump in a variable speed cascade system.

These are the primary purposes of the duty/assist function:

- To let the duty pump run all the time (except if low flow stop is activated).
- To start the assist pumps if the duty pumps cannot maintain the pressure.
- To start the assist pumps if the duty pump stops due to an alarm.

The cascade control ensures that the performance of the pumps is automatically adapted to consumption by switching on or off pumps and by changing the speed of the pumps in operation. This makes the system run as energy-efficiently as possible with a limited number of pumps.

When more than one pump is running in steady state, the pumps run at the same speed and are controlled by the PI controller of the master pump. As standard, the pump with the lowest number is the duty pump.

The pumps running duty/assist in this way cannot use the GENIbus interface for remote communication.

TMD40368

6.5.3 Fixed-speed cascade

The fixed-speed cascade function is used to cascade additional fixed-speed pumps. Only one duty pump is connected to a CUE unit.

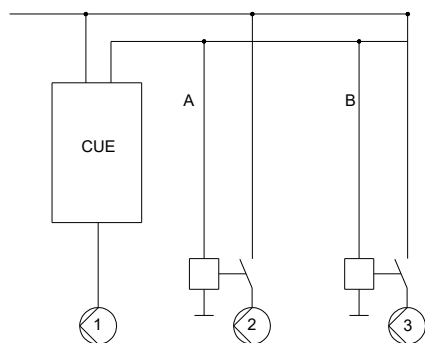

TM075451

One duty pump connected with two fixed-speed pumps controlled via relays

Pos.	Description
A	Relay 1
B	Relay 2

The fixed-speed cascade function is set by selecting "Variable and Fixed speed" in the startup guide, then followed by setting the total number of pumps in the system. When "Variable and Fixed speed" is selected, this pump runs as a duty pump in the fixed-speed cascade system. The following steps must be performed:

- For a two-pump setup: Relay 1 is automatically set to activate/deactivate one fixed-speed pump based on pressure demand
- For a three-pump setup: Relay 1 and Relay 2 are automatically set to activate/deactivate one additional fixed-speed pump at the same time based on pressure demand.

These are the primary purposes of the function:

- To let the duty pump run all the time (except if low flow stop is activated).
- To start the fixed-speed pumps if the system pressure decreases below 90 % of setpoint.
- To stop the fixed-speed pumps if the system pressure increases above 110 % of setpoint

The cascade control ensures that the performance of the pumps is automatically adapted to consumption by switching on or off pumps and by changing the speed of the duty pump in operation.

6.6 Dry running

This function protects the pump against dry running. When lack of inlet pressure or water shortage is detected, the pump is stopped before being damaged.

Lack of inlet pressure or water shortage can be detected in three ways:

- With a switch connected to a digital input configured to dry-running protection.
- CUE checks if the shaft power is below a dry-pump limit for a configurable time.
- CUE checks if the pressure cannot be reached at full speed for a configurable time.

Note that the dry-running function requires a sensor. This means that the function will not work in open loop. These conditions must be present to activate the dry-running alarm: The power consumption must be below a certain level (set by the parameters), and the pump must run at full speed (handled by the control mode and the sensor). CUE increases the speed to maximum if no water is present. Without a sensor, it will not work!

Setting the dry-running protection based on a switch connected to a digital input

The use of a digital input requires an accessory, such as these:

- a Grundfos LiqTec® dry-running switch
- a pressure switch installed on the suction side of the pump
- a float switch installed on the suction side of the pump.

See the section about accessories for more information on the required sensors. The pump cannot restart if the input is activated. Restart may be delayed by up to 30 minutes, depending on the pump family.

The digital inputs of CUE (terminals, 18, 19, 27, 29, 32, 33) can be set individually to different functions in [Main] menu parameter group 5-1x "Digital Inputs".

Select dry running to activate the detection based on a switch.

Setting the dry-running protection based on a shaft power

The use of shaft power requires an actual power reading at two frequencies.

Procedure without pump curve: After completing the startup guide follow the steps:

1. Close the valve. No flow is required during the test.
2. Press Hand on and set the speed to 50 % (30 Hz or equivalent RPM). CUE starts the pump.
3. Go to [Main] menu parameter 16-10 "Power [kW]" and read the input power. Make a note of the low limit value.
4. Press [Home] to return to the status screen.
5. Press Hand on and set the speed to 90 % (54 Hz or equivalent RPM). CUE starts the pump.
6. Go to [Main] menu parameter 16-10 "Power [kW]" and read the input power. Make a note of the high limit value.
7. Stop CUE and open the valve.

Procedure with pump curve:

Go to Grundfos Product Center and enter the part number for your pump:

1. Enter "Show advanced options".
2. Go to "Hydraulic layout" and set variable speed to "Yes".
3. Click on the pump curve to set the duty point as close to f_{min} . and enter Q to 0.1 as Operating point.
4. Read out power (P2) and speed (n) as low limit values.
5. Click on the pump curve to set the duty point as close to 90 % speed and enter Q to 0.1 as Operating point.
6. Read out power (P2) and speed (n) as high limit values.

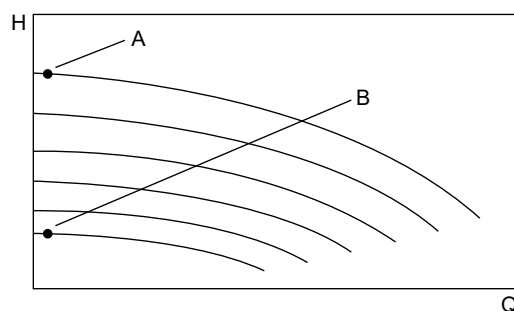

QH curve for variable speed pump for choosing low flow operating points

Pos.	Description
A	90 % of f_{max} .
B	f_{min} .

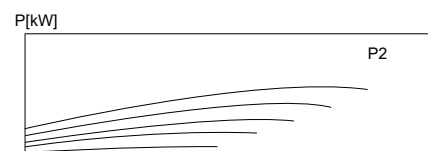

QP curve for variable speed pump for reading P2 at low flow

The data must be entered in [Main] menu parameter group 22-3x "No-flow Power Tuning" as follows:

- 22-32 "Low Speed [RPM]" or 22-33 "Low Speed [Hz]" = 30 Hz
- 22-34 "Low Speed Power [kW]" = the power readout at Low limit in previous procedure
- 22-36 "High Speed [RPM]" or 22-37 "High Speed [Hz]" = 54 Hz
- 22-38 "High Speed Power [kW]" = the power readout at High limit in previous procedure.

Activate the desired protection function, for example an alarm, in [Main] menu parameter 22-26 "Dry Pump Function".

The dry-running stop function has now been set correctly. The time setting is 10 seconds from no-flow delay (22-24) + 10 seconds from dry-running detection delay (22-27) = 20 seconds.

TM075610

Setting the dry-running protection based on an end of curve

CUE will by default issue an alarm at end of curve. This will also occur under the dry run conditions of water shortage and no flow.

In constant pressure control mode, the end of curve is detected if the pressure is below a 20 % tolerance of the sensor range of the setpoint and the pump is running at maximum speed for a 10-second delay. The pump cannot build up the setpoint pressure due to water shortage.

The end of curve tolerance, delay and protection function can be adjusted in [Main] menu parameter group 22-5x "End of Curve".

Example: A constant pressure system with 0-16 bar sensor and setpoint at 11.75 bar (120 m head) gives an end of curve alarm if the pressure is below $(11.75 \text{ bar} - 20\% \times 16 \text{ bar}) = 8.55 \text{ bar}$ and the pump is running at maximum speed.

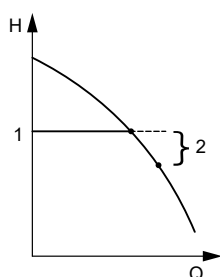

TM075611

Pos.	Description
1	H_{set}
2	H tolerance

Dry-running detection based on end of curve also gives an alarm, if there is actual water and the system head curve shifts to high flow range; this means that the function may need to be adjusted to work properly in the high flow area.

6.7 Pump torque

CUE can provide torque for different load characteristics, constant and variable torque, as well as an automatic energy optimising function.

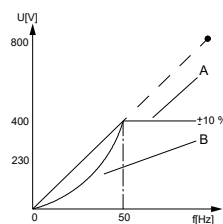

TM075471

U/f characteristic control (ideal)

Pos.	Description
A	Constant torque
B	Variable torque

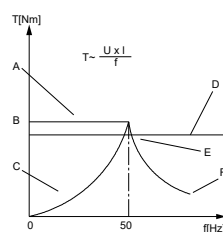

TM075472

T/n characteristic control (ideal)

Pos.	Description
A	Constant torque
B	T_{nominal}
C	Variable torque
D	T_{load}
E	The torque is inversely proportional to the frequency
F	T_{motor}

The torque characteristic is normally set to variable torque for centrifugal pumps, where it provides a voltage which is optimised for a squared torque load characteristic of the motor.

Whereas in the constant torque characteristics CUE provides a voltage which is optimised for constant torque pump applications:

- axial pumps
- positive displacement pumps.

When selecting the pump type in the CUE startup guide, the torque characteristic is automatically set according to the typical applications for the pump:

Pump type	Torque characteristic	Automatic derate
AFG, SFG	Constant	
AMG, SMG	Constant	
BM	Variable	•
BMShs, BMSHp	Variable	•
CM, CMV	Variable	•
CR, CRI, CRN, CRT	Variable	•
CRK	Variable	•
DP, EF	Constant	
DPK, DWK	Constant	
HS	Variable	•
KPL, KWM, KPG	Constant	
LC, LF	Variable	•
MTH, MTR	Variable	•
MTS	Constant	•
MTB	Variable	•
NB, NK	Variable	•
NBG, NKG	Variable	•
Other	Variable	•
S	Constant	
SE, SEV, SL, SLV	Constant	
SMD	Constant	
SP, SP-G, SP-NE	Variable	•
SPK	Variable	•
SRG	Constant	
TP Series 100	Variable	•
TP Series 200	Variable	•
TP Series 300	Variable	•
VL	Variable	•
VLS	Variable	•

CUE can be set for optimum energy-efficient speed control of centrifugal pumps, where it provides a voltage, which is optimised for the torque load characteristic of the motor, but in addition, the AEO feature adapts the voltage exactly to the current load situation, reducing energy consumption and audible noise from the motor.

To obtain optimal performance, set the motor power factor correctly. This value is set in [Main] menu parameter 14-43 "Motor Cosphi", but this is automatically adjusted with the automatic motor adaptation (AMA) function. See the CUE Installation and operating instructions.

The torque characteristic can be manually set in [Main] menu parameter 1-03 "Torque Characteristic".

6.7.1 Automatic derate output for not tripping at overload

In some pump systems, CUE has not been sized properly to yield the current needed in all points of the operational QH characteristic. At these points, the pump needs a current higher than the rated current of the frequency converter. CUE can normally yield 110 % of its rated current continuously for 60 seconds. If still overloaded, CUE normally gives an alarm.

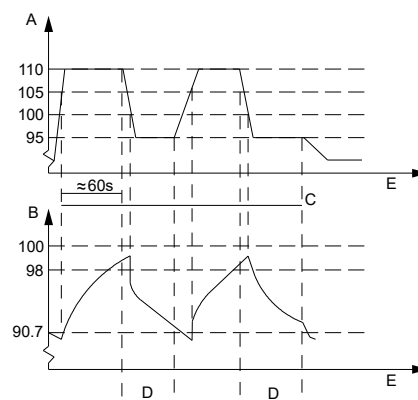

TM075473

Output current in overload condition

Pos.	Description
A	% of rated current
B	Inverter load counter
C	Desired current > 100 %
D	Warning
E	Time

CUE automatically reduces pump speed until the output current is below 100 % of the rated current.

CUE estimates the load on the power section with an inverter load counter, which causes a warning at 98 % and a reset of the warning at 90 %. At the value 100 %, CUE gives an alarm. Status for the counter can be read in [Main] menu parameter 16-35 "Inverter Thermal".

This can manually be disabled in [Main] menu parameter 14-61 "Function at Inverter Overload", and CUE trips instead.

6.7.2 High overload for waste water applications

In waste water and other high overload applications it can be required to have a higher starting torque, therefore it is recommended for these applications to install an oversize CUE and set the overload mode to "high overload". This allows CUE to yield 160 % of its high overload rated current continuously for 60 seconds.

This can be set in [Main] menu parameter 1-04 "Overload Mode"

6.8 Start adjustments

6.8.1 Start delay

The start delay after power-on is a delay between power being applied and the pump starting.

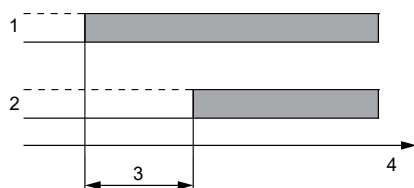

Start delay after power-on

Pos.	Description
1	Power-on
2	Start CUE
3	Start delay
4	Time

The purpose is to allow the remote-control equipment to start up before the pump.

The start delay is deactivated if a remote command is received via GENibus.

This can be set in [Main] menu parameter 1-71 "Start Delay".

6.8.2 Flying start

This function makes it possible to catch a motor that is spinning freely due to a mains drop-out. This prevents a high current draw from CUE by starting on a rotating motor.

When flying start is enabled, the start delay function is not active.

This can be set in [Main] menu parameter 1-73 "Flying Start".

6.8.3 Blocked pump

Some pumps are sensitive to operating at low speed due to insufficient cooling or lubrication.

If the pump does not reach the speed "Trip speed low (Hz)" within the "Pump Start Max. Time to trip", CUE gives an alarm.

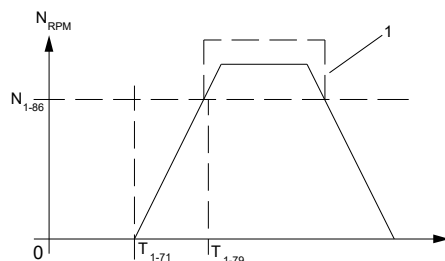

Advanced minimum speed monitoring

Designation	Description
T_{1-71}	Parameter 1-71 "Start Delay"
T_{1-79}	Parameter 1-79 "Pump Start Max. Time to Trip". This time includes the time in T_{1-71}
N_{1-86}	Parameter 1-86 "Trip Speed Low [RPM]". If the speed drops below this value during normal operation, the frequency converter drops.
1	Normal operation

Note that timers for parameter 1-71 "Start Delay" and parameter 1-79 "Pump Start Max. Time to Trip" start at the same time when the start command is issued. For instance, this means that if the start delay is more than or equal to pump start max. time, CUE never starts.

TM040621

TM075474

6.9 Pipe fill

This function is used for filling empty pipes with water in a controlled manner. If the function is not activated, pipes will be filled at maximum speed. In pressure-controlled systems where pipes are empty at startup, high speed will cause water hammer until the speed has been reduced to fit the actual demand.

Water hammer can be prevented by introducing a pipe fill sequence before the system is running normal operation. The pipe fill function can limit the speed of the pump when filling pipes, and thus reduce water hammer in filled pipes. A time limit or a pressure can be set to deactivate the pipe fill function and turn CUE into normal operation.

As the pressure in horizontal pipe systems does not climb as the system fills, filling horizontal pipe systems requires a user-specified speed and time to fill the pipes or until a user-specified pressure setpoint is reached.

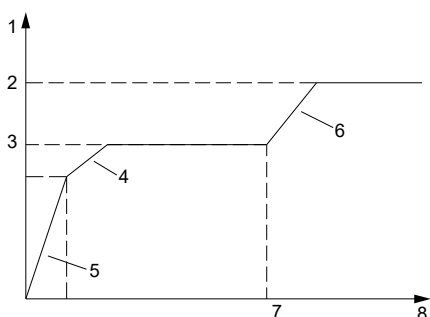

TM075475

Horizontal pipe system

Pos.	Description
1	Speed
2	Max. speed
3	Min. speed
4	Normal ramp
5	Initial ramp
6	Closed loop
7	Fill time or filled setpoint
8	Time

In a vertical pipe system it's recommended to use the PID function to ramp the pressure at a user-specified rate between the motor speed low limit and a user-specified pressure.

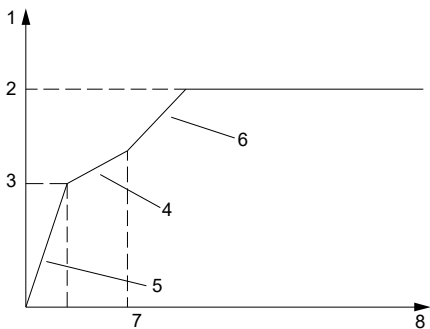

TM075476

Vertical pipe system

Pos.	Description
1	Speed
2	Max. speed
3	Min. speed
4	Fill rate unit/sec.
5	Initial ramp
6	Closed loop
7	Filled setpoint
8	Time

Activation or deactivation is done in parameter 29-00 "Pipe Fill Enable".

6.10 Operation

6.10.1 Ramps

The CUE startup guide incorporates adjustment of two types of ramp:

- ramp-up and ramp-down
- initial and final ramps.

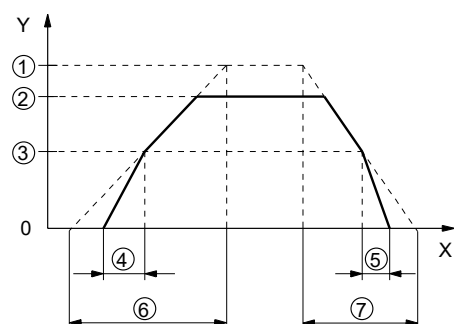

TM069798

Ramp-up and ramp-down of CUE

Pos.	Description
X	Time
Y	Speed
1	Nominal
2	Max.
3	Min.
4	Initial ramp
5	Final ramp
6	Ramp-up
7	Ramp-down

The ramp-up and ramp-down are used for protection against overload when starting and stopping CUE, and the time is defined as acceleration time from 0 min^{-1} to nominal motor speed and the deceleration time from nominal motor speed to 0 min^{-1} , respectively. The settings are manually set in parameter 3-41 "Ramp 1 Ramp Up Time" and 3-42 "Ramp 1 Ramp Down Time" of the operating panel.

The initial and final ramps prevent operation for a longer time than necessary at speeds below minimum speed.

The setting is done automatically based on the pump family selected in the startup guide.

6.10.2 Operating range

How to set the operating range:

- Set the minimum speed within the range from a pump-dependent minimum speed to the adjusted maximum speed. The factory setting depends on the pump family.
- Set the maximum speed within the range from the adjusted minimum speed to the pump-dependent maximum speed. The factory setting is equal to 100 %, meaning the speed stated on the pump nameplate.

The area between the minimum and maximum speed is the actual operating range of the pump.

The operating range can be changed by the user within the pump-dependent speed range.

For some pump families, oversynchronous operation (maximum speed above 100 %) will be possible. This requires an oversize motor to deliver the shaft power required by the pump during oversynchronous operation.

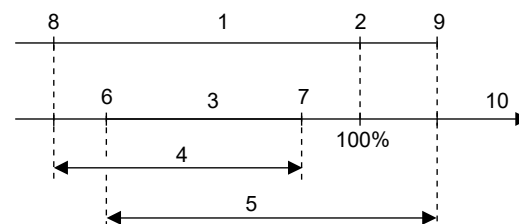

Setting of the minimum and maximum curves in percentage of maximum performance

Pos.	Description
1	Pump dependent speed range
2	Nominal speed
3	Actual speed range
4	Min. speed, adjusted
5	Max. speed, adjusted
6	Min.
7	Max.
8	Min. speed
9	Max. speed
10	Speed [%]

Minimum and maximum speed can manually be overwritten in parameter 4-11 "Motor Speed Low Limit" and 4-13 "Motor Speed High Limit", respectively. Note that the maximum speed cannot exceed the maximum output frequency set in parameter 4-19.

Running outside the pump-dependent minimum and maximum speeds may damage the pumps.

6.10.3 Skip bands

Some systems require that certain output frequencies or speeds are avoided due to resonance problems in the system.

- If CUE is in [RPM] mode, enter the lower limit of the speeds to be avoided in parameter 4-60[0] and the upper limit in parameter 4-62[0].
- If CUE is in [Hz] mode, enter the lower limit of the speeds to be avoided in parameter 4-61[0] and the upper limit in parameter 4-63[0].

A maximum of four frequency or speed ranges can be avoided in rare cases. To add more skip bands, use index 1, 2 or 3 for the above mentioned parameters.

6.10.4 Stop adjustments

Standstill heating preheats the motor during standstill to avoid condensation within the motor.

When the pump is stopped by a stop command, a current will be applied to the motor windings in order to keep the temperature within the motor above the dew point temperature. No external heater is needed.

The preheating of the motor is especially important when the motor is installed under these conditions:

- high humidity
- outdoor installation.

The consequences of condensed moisture within the motor are for example corrosion damage to electrical contacts and the bearings of the motor shaft.

This can be activated in parameter 1-80 "Function at Stop".

6.10.4.1 Deragging

The purpose of the deragging feature is to free the pump blade of debris in wastewater applications so that the pump operates normally.

A deragging event is defined as the time when CUE starts to derag until the deragging finishes. When a deragging is started, CUE first ramps to a stop and then an off delay expires before the first cycle begins.

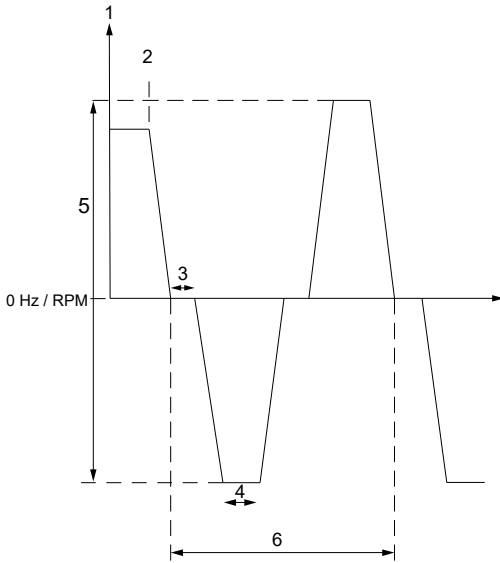

TM075554

Derag function

Pos.	Description
1	Speed
2	Derag function activated
3	Derag Off Delay (par. 29-15)
4	Deragging Run Time (par. 29-15)
5	+/- Derag Speed (par. 29-13, par. 29-14)
6	1 cycle Number of cycles (par. 29-10)

If a derag is triggered while CUE is at stop, the first off delay is skipped. The deragging event can be set to a number of cycles. One cycle consists of running in the reverse direction followed by running in the forward direction. Deragging is considered finished after the specified number of cycles have completed.

In between rotations, CUE coasts for an off-delay to let debris in the pump settle.

Do not enable deragging if the pump cannot operate in reverse direction.

Depending on the application and the purpose of using it, this feature can be used as a preventive or reactive measure and can be triggered by means of:

- every pump start, parameter 29-11 "Derag at Start/ Stop"
- every pump stop, parameter 29-11 "Derag at Start/ Stop"

- by digital input, parameter group 5-1* "Digital Inputs"
- on high power, parameter group 29-2* "Derag Power Tuning".

CUE calculates a derag power curve based on below inputs and activates the deragging event if the output power is exceeding the expected power.

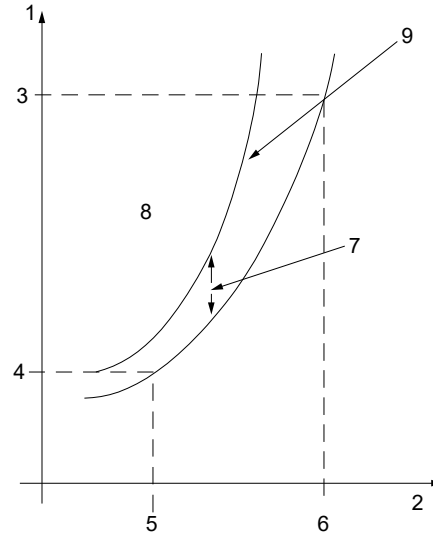

TM075555

Derag power tuning

Pos.	Description
1	Power [kW/hp]
2	Speed [Hz/RPM]
3	High speed power (par. 29-30, par. 29-31)
4	Low speed power.(par. 29-26, par. 29-27)
5	Low speed (par. 29-24,par.29-25)
6	High speed (par. 29-28, par. 29-29)
7	Derag power factor (par. 29-22)
8	Activate derag
9	The calculated power + the power factor (readout).(par. 29-20, par. 29-21)

6.10.4.2 Check valve ramps

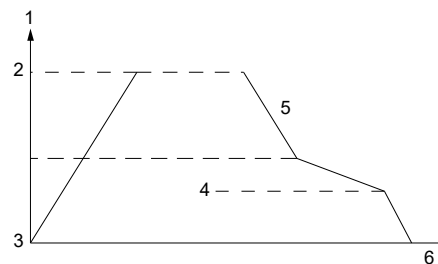

TM075556

Check valve ramp

Pos.	Description
1	Speed
2	Motor speed high
3	Motor speed low
4	Check valve End speed
5	Normal ramp
6	Time

To protect ball check valves in a stop situation, the check valve ramp time can be utilised as a temporary slower ramp rate. When parameter 3-85 "Check Valve Ramp Time" is different from 0 s, the check valve ramp time is effectuated between motor speed low and check valve end speed.

Set the check valve end speed where the check valve is expected to be closed and the check valve is no longer active.

6.10.4.3 Over-voltage control (OVC)

When deceleration is too fast in case of higher inertia, the braking energy can cause an over voltage in CUE. This can be overcome by enabling over-voltage control in [Main] menu parameter 2-17, and CUE automatically prolongs the deceleration times; normal ramps, final ramps, and check valve ramps to stop CUE without an alarm.

6.10.5 Pump motor protection

6.10.5.1 Motor temperature

The motor thermal protection can be activated in [Main] menu parameter 1-90 "Motor Thermal Protection" and can be implemented using a range of techniques:

- By a PTC sensor in the motor windings connected to one of the analog or digital inputs, parameter 1-93 "Thermistor Source".
- By calculation (ETR = Electronic Thermal Relay) of the thermal load based on the actual load and time. The calculated thermal load is compared with the rated motor current and the rated motor speed. If parameter 1-91 "Motor External Fan" is set to Yes, the motor must have forced cooling and the ETR does not take motor speed into consideration.
- By a mechanical thermal switch (Klixon type). Parameter 1-93 "Thermistor Source".

For the North American market: the ETR functions provide class 20 motor overload protection in accordance with NEC.

6.10.5.2 Motor bearing monitoring

This function is used to give an indication when it is time to relubricate or replace the motor bearings.

It shows these information:

- When to relubricate the motor bearings.
- When to replace the motor bearings.

The function is based on the running hours of the pump, and shows a notification on the display to lubricate the bearings after 5000 running hours and replace the bearings after 20000 running hours.

Monitoring of motor bearing temperature using an MCB 114 sensor input module and Pt100/Pt1000 sensors measuring the bearing temperature can also be used to issue a warning. An alarm is generated if the bearing temperature gets too high. Warnings and alarms are generated and reset using hysteresis.

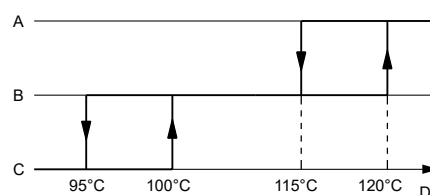

TM040371

Monitoring of bearing temperature with warning and alarm limits

Pos.	Description
A	Alarm limit
B	Warning limit
C	Normal
D	Temperature

6.11 Limit exceed

CUE has two independent limit exceed functions. These are monitoring functions offering information, warning, alarm, or change of operating mode when a low or high limit is exceeded.

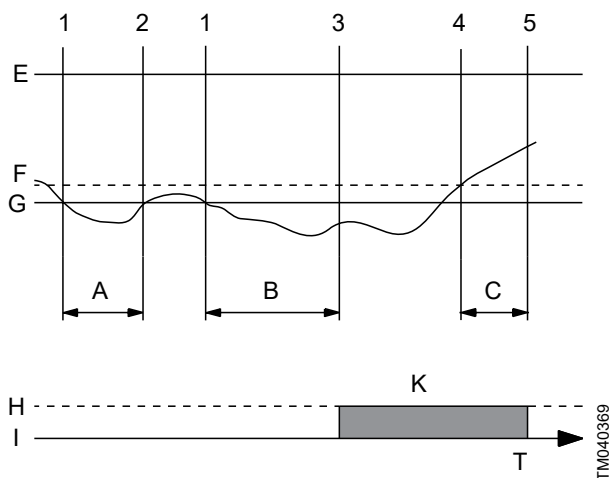

Example of low limit exceeded

Pos.	Description
E	High limit
F	Hysteresis
G	Low limit
H	On
I	Off
K	Limit exceeded
T	Temperature

The two limit exceed functions are set in [Main] menu parameter group 201-0x "Limit Exceed". Parameters are grouped so that Limit Exceed 1 are set in index 0 and Limit Exceed 2 are set in index 1.

The default setting of this function is "Not active" and is activated in parameter 201-00 by setting to Enabled or Enabled with event action.

The function has two timers: a detection delay timer and a reset delay timer, that are adjustable in parameters 201-06 and 201-07, respectively.

The limits can either be a high or a low limit adjusted in parameter 201-01, and the actual limit value must be entered in parameter 201-04.

The detection delay timer starts when a limit is exceeded (1). See the figure above.

- A: If the limit is no longer exceeded (2) when the detection time expires, the timer is reset.
- B: If the limit is still exceeded (3) when the detection time expires, the output of the detector will change to "Limit exceeded". The reset delay timer starts when the detector output is "Limit exceeded" and the limit is no longer exceeded, using hysteresis (4).
- C: When the delay time has expired (5), the detector output changes to "Limit not exceeded".

Input possibilities

It is possible to have two limit exceeded functions in parallel with these inputs set in parameter 201-02:

- all analog inputs
- all Pt100/Pt1000 inputs (this requires an MCB 114 sensor input module)
- internal measured values; Power consumption (P2), Motor speed, or Motor current.

Output possibilities

There are these output possibilities:

- signal relay 1 and 2 activated in parameters 5-40[0] and 5-40[1], respectively
- digital output activated in parameters 5-30 and 5-31 respectively
- analog output activated in parameter 6-50.

Event actions

Change of operating mode as event action is set in parameter 201-03.

- Warning only
- Stop
- Maximum speed
- Minimum speed
- User curve speed.

The default setting of this function is "Not active".

6.12 Digital and Analog I/O

CUE digital inputs can be configured to either PNP or NPN mode in [Main] menu parameter 5-00 "Digital I/O Mode":

- NPN - Active at 0 V
- PNP - Active at 24 V.

CUE has six terminals for digital input and output functions:

Terminal No.	Name	Parameter	Default	I/O mode
18	DI 1	5-10	Start	-
19	DI 2	5-11		-
27	DI/O 1	5-12 for input or 5-30 for output		5-01
29	DI/O 2	5-13 for input or 5-31 for output	No operation	5-02
32	DI 3	5-14		-
33	DI 4	5-15		-

6.12.1 Digital input functions

- **Reset:** Used to reset an alarm manually from external signal.
- **Coast:** Used to immediately stop the pump without ramping down. Pump will stop free-wheeling.
- **Start:** Used to start the pump manually in [Auto on] mode.
- **Reversing:** Used to reverse the motor speed. Do not use this function on a pump.
- **Jog:** Used to set the motor speed fixed to Jog Speed [Hz] of parameter 3-11.
- **Preset ref bit 0 through 2:** Used to set the pump setpoint fixed to values of parameter 3-10.
- **Freeze output:** Used to continue pump speed at current speed.
- **Hand/Auto start:** Selects hand or auto start. High signal selects auto on only, Low signal selects hand on only.
- **Hand start:** A signal applied to put CUE into hand-on mode as if [Hand On] has been pressed and a normal stop command is overridden.
- **Auto start:** A signal applied to put CUE into auto-on mode as if [Auto On] has been pressed and a normal stop command is overridden.
- **External fault:** If the input is activated for more than 5 seconds, an external fault will be indicated.

Note that if disconnecting the signal, the motor stops. To make any other start commands valid, assign another digital input to [54] Auto Start and apply a signal to this. [Hand On] and [Auto On] have no impact. [Off] overrides local start and auto start. Press either [Hand On] or [Auto On] to make local start and auto start active again. If there is no signal on neither [53] Hand start nor [54] Auto start, the motor stops regardless of any normal start command applied. If a signal is applied to both [53] Hand start and [54] Auto start, the function is auto start. If pressing [Off], the motor stops regardless of signals on [53] Hand start and [54] Auto start.

- **Min.:** Changes the operating mode to Min.
- **Max.:** Changes the operating mode to Max.
- **User curve:** Changes the operating mode to User curve.

Note that most functions are available with and without inverse. Choose with inverse if you want a specific function to be activated opposite than the PNP or NPN mode.

Related information

6.1 Operating modes

6.12.2 Digital and Relay output functions

- **Control ready:** The control board receives supply voltage.
- **Drive ready:** CUE is ready for operation and applies a supply signal on the control board.
- **Drive ready/remote control:** CUE is ready for operation and is in auto-on mode.
- **Standby/no warning:** CUE is ready for operation. No start or stop command has been given (start/disable). There are no warnings.
- **Running:** The pump is running.
- **Running/no warning:** The pump is running and there are no warnings.
- **Run on reference/no warning:** The motor runs at reference speed.
- **Alarm:** An alarm activates the output.
- **Alarm or warning:** An alarm or a warning activates the output.
- **At torque limit:** The torque limit set in parameter 4-16 "Torque Limit Motor Mode" has been exceeded.
- **Torque limit and stop:** Used in performing a coast stop and in torque limit condition. If the frequency converter has received a stop signal and is at the torque limit, the signal is logic 0.
- **Out of current range:** The motor current is outside the range set in parameter 4-18 "Current Limit".
- **Below current, low:** Motor current is lower than the setting in parameter 4-50 "Warning Current Low".
- **Above current, high:** Motor current is higher than the setting in parameter 4-51 "Warning Current High".
- **Out of speed range:** Output speed is outside the ranges set in parameter 4-52 "Warning Speed Low" and parameter 4-53 "Warning Speed High".
- **Below speed, low:** Output speed is lower than the setting in parameter 4-52 "Warning Speed Low".
- **Above speed, high:** Output speed is higher than the setting in parameter 4-53 "Warning Speed High".
- **Out of feedback range:** Feedback is outside the ranges set in parameter 4-56 "Warning Feedback Low" and parameter 4-57 "Warning Feedback High".
- **Below feedback low:** Feedback is below the limit set in parameter 4-56 "Warning Feedback Low".
- **Above feedback high:** Feedback is above the limit set in parameter 4-57 "Warning Feedback High".

- Thermal warning: The thermal warning turns on when the temperature exceeds the limit in the motor, the CUE, or the thermistor.
- Bus OK: Active communication (no timeout) via the serial communication port.
- Out of ref range: Reference is outside the ranges set in parameter 4-54 "Warning Reference Low" and parameter 4-55 "Warning Reference High".
- Below reference low: The reference is below the limit set in parameter 4-54 "Warning Reference Low".
- Above reference high: The reference is above the limit set in parameter 4-55 "Warning Reference High".
- Comparator 0 through 5: The signal outputs correspond to the logic output of [Main] menu parameter group 13-1x "Comparators".
- Logic Rule 0 through 5: The signal outputs correspond to the logic output of [Main] menu parameter group 13-4x "Logic Rules".
- Running reverse: CUE is running counterclockwise.
- Start command active: CUE has received an active start command, for example auto on, and a start command via digital input or bus is active or [Hand On]. It is not necessarily running.
- Drive in hand mode: CUE is in hand-on mode (as indicated by the indicator light above [Hand on]).
- Drive in auto mode: CUE is in auto-on mode (as indicated by the indicator light above [Auto on]).
- Preventive Maintenance: One or more of the preventive maintenance events has passed the time for the specified action.
- Deragging: Deragging procedure is active.
- AHF Capacitor Connect: Automatic control of AHF capacitor connect at low loads under 20 %.
- External Fan Control: External fan control is active.
- No-Flow: A no-flow situation or minimum speed situation has been detected.
- Dry Pump: A dry pump condition has been detected.
- End of Curve: An end of curve condition has been detected.
- Sleep Mode: CUE has entered sleep mode.
- Pipe Filling: Active when the pipe fill function is operating.

6.12.3 Analog outputs

The analog output (0-20 mA) can be set in [Main] menu parameter 6-50 to one of these indications:

- feedback value
- speed
- frequency
- motor current
- external setpoint input
- limit exceeded.

The analog output is set to not active by default.

- Feedback value: The output signal is a function of the actual feedback value.

- Speed: The output signal is a function of the actual pump speed.
- Frequency: The output signal is a function of the actual frequency.
- Motor current: The output signal is a function of the actual motor current.
- External setpoint input: The output signal is a function of the external setpoint input.
- Limit exceeded: The output signal is on/off when the limit is exceeded: Off = 0/4 mA and On = 20 mA.

6.12.4 MCB 114 sensor input module

The MCB 114 sensor input module offers three additional analog inputs for CUE:

- one analog 0/4-20 mA input for an additional sensor
- two analog Pt100/Pt1000 inputs for temperature sensors.

6.12.5 Sensor 2

The analog 0/4-20 mA input is used for these functions:

- Monitoring the measured value of sensor 2 (default setting).
- Measured value of sensor 2 used for control purpose. This makes differential pressure control possible by using measurements from sensor 1 and sensor 2 (setting by means of PC Tool).

6.12.6 Temperature sensors 1 and 2

The analog Pt100/Pt1000 inputs are used for monitoring these temperatures:

- drive-end motor bearing
- non-drive-end motor bearing
- other liquid 1
- other liquid 2
- motor windings
- pumped liquid
- ambient temperature.

Displays

MCB 114 input	Displays	
	Reading	Setting
Sensor 2	2.5	3.16
Temperature sensor 1	2.12	3.21
Temperature sensor 2	2.13	3.22

Further information

See also the CUE Installation and operating instructions.

7. Installation

7.1 Mechanical installation

The CUE cabinet sizes are characterised by their enclosure. CUE is available in four enclosure classes, IP20, IP21, IP54 and IP55. To see the relationship of enclosure class and enclosure type, see the section about selection tables.

The general installation requirements necessitate special considerations as to these aspects:

- Accessible, but only in a cabinet. Enclosure class IP20/21 must not be installed freely.
- Enclosure class IP54/55 must be installed freely accessible, but must not be installed outdoors without additional protection against water and sun.
- CUE contains a large number of mechanical and electronic components and must therefore not be installed in an environment where the air contains liquids, particles or gasses which may affect and damage the electronic components.
- In applications requiring Ex approval, CUE must be installed outside the hazardous area.
- Special care must be taken to ensure that the installation is covered by the correct Ex rating.

Related information

10.3 Selection tables

7.1.1 Space and air circulation

CUE units can be mounted side by side, but as sufficient air circulation is required for cooling, these requirements must be met:

- Sufficient free space above and below the CUE cabinet. See the table below.
- Hang the CUE cabinet directly on the wall, or fit it with a back plate to secure sufficient air flow for cooling.

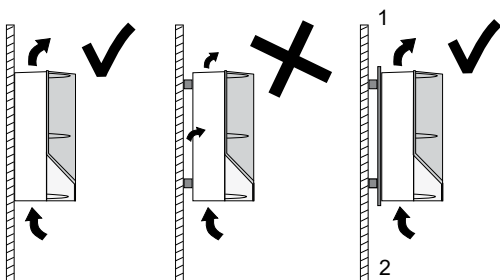

CUE hung directly on the wall or fitted with a back plate

Pos.	Description
1	Outlet temperature
2	Inlet temperature

Required free space above and below the CUE cabinet

Enclosure	Space [mm (in)]
A2, A3, A4, A5	100 (4)
B1, B2, B3, B4, C1, C3	200 (8)
C2, C4, D1h, D2h	225 (9)

Required free space in front of CUE

Furthermore, there must be sufficient space in front of CUE for opening the CUE door.

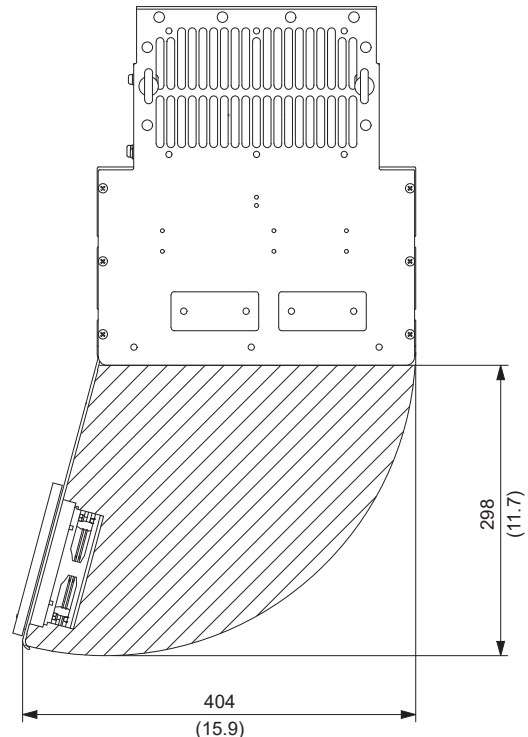

Free space in front of CUE enclosures D1h and D2h

7.1.2 Ventilation of built-in CUE

CUE can be mounted in a control cabinet if sufficient air circulation is ensured. The quantity of air flow required for cooling CUE can be calculated as follows:

$$q_v = \frac{\Sigma p \times 3.1}{\Delta T} \quad [\text{m}^3/\text{h (gpm)}]$$

Insert Σp in Watt and ΔT in K.

Σp is the power loss of all equipment integrated in the same cabinet. Calculate the power loss P of CUE by means of the typical shaft power P2 multiplied by the efficiency.

ΔT is the difference between the outlet temperature and the inlet temperature (ambient) of the cooling air. See the section about space and air circulation.

The inlet and outlet temperatures must not be higher than the values in the table below.

	Max. inlet temperature	Max. outlet temperature
CUE 0.55 - 90 kW	50 °C (122 °F)	55 °C (131 °F)
CUE 110 - 250 kW	45 °C (113 °F)	50 °C (122 °F)

The average inlet temperature over 24 hours must be 5 °C (41 °F) lower.

The outlet from the ventilation must be placed above the highest-mounted CUE. Allowance must be made for the pressure loss across the inlet filters of the cabinet and for the fact that the pressure will drop as the filters get choked.

Example

Calculate the required air flow for cooling of a built-in CUE when the ambient temperature is 27 °C (80 °F). CUE has a typical shaft power of 11.0 kW and an efficiency of 0.98.

Calculate the power loss of CUE:

$$P = P_2 \times \text{efficiency} = 11.0 \times (1 - 0.98) \times 1000 = 220 \text{ W.}$$

Calculate the required air flow for cooling CUE:

$$q_v = (P \times 3.1) / (\Delta T) = (220 \times 3.1) / (328 - 300) = 5 \text{ m}^3/\text{h.}$$

Related information

7.1.1 Space and air circulation

7.2 Electrical installation

Always observe national and local regulations as to cable cross-section, short-circuit protection and overcurrent when installing CUE.

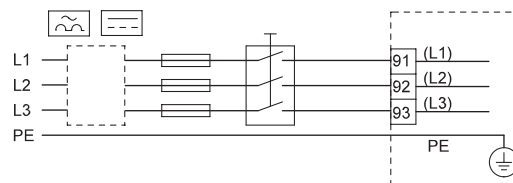

ELCB

Example of three-phase mains connection of CUE with mains disconnect, backup fuses and additional protection

7.2.1 Electrical protection

Protection against electric shock, indirect contact

Protective conductors must always have a yellow and green (PE) or yellow and green and blue (PEN) colour marking.

Instructions according to EN IEC 61800-5-1:

- CUE must be stationary, installed permanently and connected permanently to the mains supply.
- The earth connection must be carried out with duplicate protective conductors or with a single reinforced protective conductor with a cross-section of minimum 10 mm².

Protection against short circuit, fuses

CUE and the supply system must be protected against short circuit.

Grundfos demands that the fuses mentioned in the section about fuses are used for protection against short circuit of CUE.

Protection against short circuit on the motor output

CUE offers complete short-circuit protection in case of a short circuit on the motor output.

Additional protection

The leakage current to earth exceeds 3.5 mA.

If CUE is connected to an electrical installation where an earth leakage circuit breaker (ELCB) is used as additional protection, the circuit breaker must be of a type marked with the following symbols:

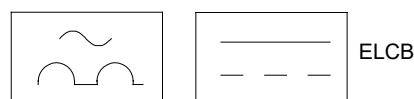

The circuit breaker is type B.

The total leakage current of all the electrical equipment in the installation must be taken into account.

For the leakage current of CUE in normal operation, see the section about inputs and outputs. During start and in asymmetrical supply systems, the leakage current can be higher than normal and may cause the ELCB to trip.

Motor protection

The motor requires no external motor protection. CUE protects the motor against thermal overloading and blocking.

TM079803

Protection against overcurrent

CUE has an internal overcurrent protection for overload protection on the motor output.

Protection against mains voltage transients

CUE is protected against mains voltage transients according to EN 61800-3, second environment.

Related information

11.7 Inputs and outputs

11.8 Fuses

7.2.2 Total harmonic distortion

A frequency converter takes up a non-sinusoidal current from the mains. A non-sinusoidal current results in increased heat losses in cables and transformers. The total harmonic distortion (THD) is defined as the sum of the higher-order current components compared to the fundamental current components (50 or 60 Hz).

CUE is equipped with intermediate coils to reduce the total harmonic distortion. The use of coils has a considerable effect on the THD. In addition, the installation site conditions are also an influencing factor on THD.

The typical THD value for CUE is in the range of 40 to 50 %. The following standards cover THD:

- IEC EN 61000-3-2, Class A, for three-phase balanced equipment (for professional equipment only up to 1 kW total power)
- IEC EN 61000-3-12, Equipment 16 A - 75 A, and professional equipment as from 1 kW up to 16 A per phase current.

CUE complies with the following standards:

- 0 - 0.75 kW: 3 x 200 V and 3 x 380-500 V comply with IEC EN 61000-3-2.
- 1.1 - 18 kW: 3 x 200 V complies with IEC/EN 61000-3-12.
- 1.1 - 90 kW: 3 x 380-500 V complies with IEC/EN 61000-3-12.
- 110-250 kW: 3 x 380-500 V complies with IEC/EN 61000-3-12. The standard originally covers only up to 75 A output current.

Other voltages and power ranges are not covered by standards.

7.3 RFI filters

To meet the EMC requirements in EN 61800-3, CUE comes with the following types of built-in radio frequency interference filters (RFI).

Voltage [V]	Typical shaft power P2 [kW (hp)]	RFI filter type
1 x 200-240	1.1 - 7.5 (1.5 - 10)	C1
3 x 200-240	0.75 - 45 (1 - 60)	C1
3 x 380-500	0.55 - 90 (0.75 - 125)	C1
	110 - 250 (150 - 350)	C3
3 x 525-600	0.75 - 90 (1 - 125)	C3
3 x 525-690	11 - 250 (15 - 350)	C3

RFI filter types are according to EN 61800-3.

C1 is a high-performance filter. C3 RFI filter types are typically for standard frequency converters.

7.3.1 Description of RFI filter types

C1: For use in domestic areas.

C3: For use in industrial areas with own low-voltage transformer.

Equipment of category C3

- This type of power drive system (PDS) is not intended to be used on a low-voltage public network which supplies domestic premises.
- Radio frequency interference is to be expected if used on such a network.

7.4 Output filters

Output filters are used for reducing the voltage stress on the motor windings and the stress on the motor insulation system as well as for decreasing acoustic noise from the frequency-converter-driven motor.

Grundfos offers two types of output filter as accessories for CUE:

- dU/dt filters
- sine-wave filters.

The enclosure class of the filters is IP20/NEMA1.

7.4.1 dU/dt filters

dU/dt filters reduce the voltage peaks and dU/dt of the pulses at the motor terminals. The voltage at the motor terminals is still pulse-shaped; the motor current has a sine-wave shape without commutation spikes.

7.4.2 Sine-wave filters

Sine-wave filters have a higher degree of filtering, resulting in higher reduction of motor insulation stress and elimination of switching acoustic noise from the motor.

The motor losses are reduced because the motor is fed with a sine-wave voltage. Moreover, the filter eliminates the pulse reflections in the motor cable and thus reduces the losses in the motor.

7.4.3 Recommended use of output filters

The table below explains in which cases an output filter is required or recommended. From the table it can be seen if a filter is needed, and which type to use.

The selection depends on the following:

- pump type
- motor cable length
- the required reduction of the acoustic noise from the motor.

Pump type	dU/dt filter	Sine-wave filter
SP, BM, BMB with motor voltage from 380 V and higher	NA	0-300 m (0-1000 ft)
Pumps with MG71 and MG80 up to 1.5 kW (2 hp)	NA	0-300 m (0-1000 ft)
Reduction of dU/dt, reduced noise emission (Low reduction)	0-150 m	NA
Reduction of dU/dt, Upeak and reduced noise emission (High reduction)	NA	0-300 m (0-1000 ft)
With motors rated 500 V or higher	NA	0-300 m (0-1000 ft)

The lengths stated apply to the motor cable.

7.4.4 Motor size 225 and larger

Grundfos recommends using insulated bearings in motor size 225 and larger.

7.4.5 Motor cable

The motor cable must always be a screened cable to comply with EN 61800-3 no matter if an output filter is installed or not. The mains cable needs not be a screened cable. See the figures below.



TM044289

Example of installation without filter

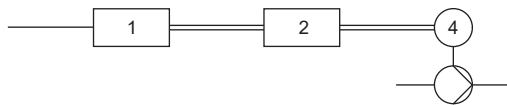

TM044290

Example of installation with filter. The cable between CUE and filter must be short.

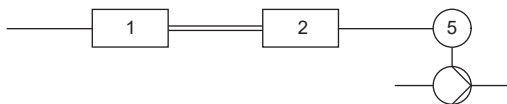

TM044291

Submersible pump without connection box. Frequency converter and filter installed close to the well.

Pos.	Description
1	CUE

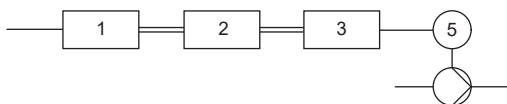

TM044292

Submersible pump with connection box and screened cable. Frequency converter and filter installed far away from the well.

Symbol	Designation
1	CUE
2	Filter
3	Connection box
4	Standard motor
5	Submersible motor
One line	Unscreened cable
Double line	Screened cable

8. Operation/display

CUE offers a wide range of data readouts representing the operating conditions of the CUE itself, the motor, the pump, and the system. All these data readouts are available by entering the [Main] menu parameter group 16-xx "Data Readouts":

- 16-1x "General Status"
- 16-2x "Motor Status"
- 16-3x "Drive Status"
- 16-5x "Setpoint and Feedback"
- 16-6x "Inputs and Outputs"
- 16-8x "Fieldbus and GENI port"
- 19-9x "Diagnostics readouts".

CUE [Status] screen shows up to 5 operational information. These can be adjusted in [Main] menu parameters 0-2x.

Pos.	Parameter	Default
21	0-20 Display line 1.1 Small	External setpoint
20	0-20 Display line 1.2 Small	Actual setpoint
1	0-20 Display line 1.3 Small	Speed [RPM]
19	0-23 Display Line 2 Large	Operating mode
2	0-23 Display Line 3 Large	Control mode

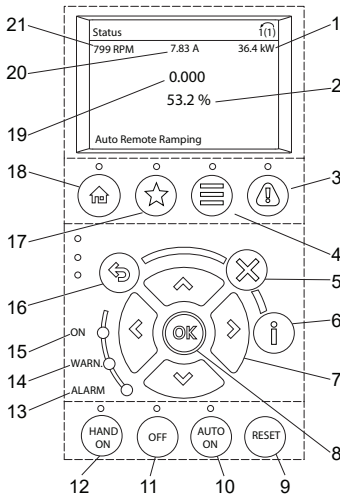

Operating panel

Pos.	Buttons	Description
1		Power [kW]
2		Reference [%]
3		[Alarm log]: shows a list of current warnings, the last 10 alarms and the maintenance log.
4		[Main menu]: allows access to all programming settings.
5		[Cancel]: cancels the last change or command as long as the display mode has not changed.
6		[Info]: press for a definition of the function being displayed.
7		[Up]/[Down]/[Left]/[Right]: use the four arrow buttons to navigate between items in the menu.

Pos.	Buttons	Description
8		OK : used to access parameter groups or to accept a selection.
9		RESET : resets the frequency converter manually after a fault has been cleared.
10		AUTO ON : puts the system in remote operating mode. • Responds to an external start command by control terminals or serial communication.
11		OFF : stops the motor, but does not remove power to the frequency converter.
12		HAND ON : starts the frequency converter in local control. • An external stop signal by control input or serial communication overrides the local HAND ON function.
13	ALARM Red	A fault condition causes the red alarm light to flash, and an alarm text is displayed.
14	WARN. Yellow	When warning conditions are met, the yellow warning light comes on and text appears in the display area identifying the problem.
15	ON Green	The ON light activates when the frequency converter receives power from the mains voltage, a DC bus terminal or an external 24 V supply.
16		[Back]: reverts to the previous step or list in the menu structure.
17		[Favourites]: allows access to programming parameters for initial setup instructions and many detailed application instructions.
18		[Status]: shows operating information.
19		Frequency
20		Motor current
21		Speed, RPM

8.1 Password protection

Password numbers can be used to protect the [Main] and [Favourites] menus as well as operating keys [Hand on], [Off], [Auto On] and [Reset].

Restricted access is set for [Main] menu in parameter 0-61 and for [Favourites] menu in parameter 0-66. Select Full access [0] to disable the password defined in parameter 0-60 and 0-65, respectively. Select Read only [1] to prevent unauthorised editing of parameters. Select No access [2] to prevent unauthorised viewing and editing of parameters.

Restricted use of operating keys [Hand on], [Off], [Auto On] and [Reset] is set in parameter group 0-4x. Select Disabled [0] to avoid accidental use of the key. Select Password [2] to avoid unauthorised use of the key.

TM074597

9. Auto/manual restart after alarm

In case of an alarm, CUE will stop the pump. Pump operation will be resumed when the cause of the alarm has been remedied and the alarm has been reset automatically or manually.

CUE can be configured to activate and deactivate automatic restart in [Main] menu parameter 14-20, and in case of automatic reset the delay between reset attempts is adjustable in [Main] menu parameter 14-21.

10. CUE selection

The rating of CUE is determined quickly and precisely based on the maximum motor current.

The power size, which is the typical shaft power P₂, is only an approximate value and cannot be used for selecting the nominal size of CUE.

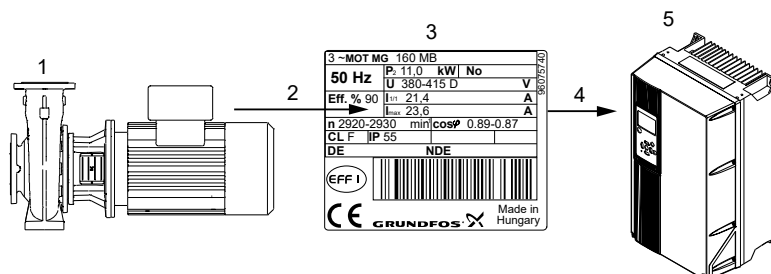

TM040375

Selection of CUE based on max. motor current

Pos.	Description
1	Pump
2	Max. motor current
3	Motor nameplate
4	Max. output current
5	CUE

10.1 Selecting a CUE

When you have selected the pump, follow these steps to select a CUE:

1. Select the voltage range of CUE. It must fit the motor voltage and the mains supply at the installation site.
2. Find the maximum motor current on the motor nameplate or in the data sheet of the selected motor. Select the first CUE that is able to deliver the maximum motor current.
3. Check that the output power rating (kW/hp) as a minimum corresponds to the value stated on the motor nameplate.
4. Select the enclosure class. Choose IP20/21 for panel mounting and IP54/55 for wall mounting.
Select standard gland holes for CUEs used outside the USA and Canada.
Select imperial gland holes for CUEs used in the USA and Canada.
5. Check if an output filter is required. Select the output filter according to the table in the section about output filters.
6. Select the accessories required for the application. It could be sensors or additional input modules.
Selecting the different accessories may require additional steps.
The actual motor current must always be less or equal to the motor current selected in the CUE operating panel.
If not, CUE reduces the maximum speed when the maximum limit is reached during operation.

- Voltage range is 3 x 400 V.
- Maximum motor current is 23.6 A.
- Enclosure class of the CUE cabinet must be IP20.

Select CUE according to the selection tables in the section about selection tables.

Data of the CUE selected:

Max. output current:	24.0 A
Typical shaft power:	11.0 kW (15 hp)
Product number (IP20):	99616716

Technical data can be found in the section about technical data.

Related information

- 7.4 Output filters
- 10. CUE selection
- 10.3 Selection tables

10.2 Special conditions

Derating must be taken into account when using CUE in these situations:

- low air pressure (heights)
- low speeds
- installations with long motor cables
- cables with a large cross-section
- high ambient temperature.

Example

Data:

10.2.1 Low air pressure

At low air pressure, the cooling capability of air is reduced. At altitudes above 1000 m (3280 ft), the maximum output current must be derated in accordance with the below diagram.

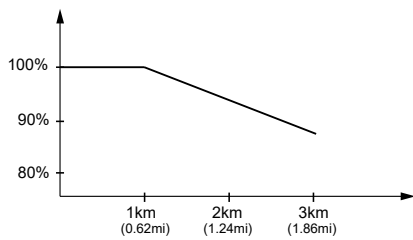

TMO40222

Derating of output current at low air pressure

At altitudes above 2000 m (6561 ft), the PELV requirements cannot be met.

PELV = Protective Extra Low Voltage.

An alternative is to lower the ambient temperature at high altitudes and thereby ensure 100 % output current at high altitudes.

Example

At an altitude of 2000 m (6561 ft), the output current 24.0 A of the selected CUE in example 1 must be derated to 92 % according to the above diagram. This is equal to 22.1 A and lower than the maximum motor current 23.6 A. The selection is not valid.

Data of the new selected CUE:

Max. output current:	32.0 A
Typical shaft power:	15.0 kW (20 hp)
Product number (IP20):	96754695

Calculation of derated current at an altitude of 2000 m (6561 ft):

Maximum output current = $32.0 \times 0.92 = 29.4$ A.

This is higher than the maximum motor current 23.6 A.

The new selection is valid.

10.2.2 High ambient temperature

If the output current is reduced to 80 % of the nominal output current of the CUE in question, the ambient temperature may be 5 °C (41 °F) higher.

The other possibility is to use a unit one size bigger. For higher temperature increases, bigger units are required. The efficiency of CUE will, however, be reduced at higher temperatures.

If CUE gets too hot, it will reduce the switching frequency. Note that the nominal temperature rating depends on the enclosure type.

The maximum ambient temperature of the different enclosures can be found in the section about technical data.

10.3 Selection tables

Mains supply 1 x 200-240 V (output 3 x 200-240 V)

Typical shaft power P2		Maximum output current [A]	Maximum input current [A]	Enclosure				Maximum conductor cross-section		Efficiency
[kW]	[hp]	3 x 200-240 V	1 x 200-240 V	IP20	IP21	IP54	IP55	[mm ²]	AWG	
1.1	1.5	6.6	12.5	A3	-	-	A5	4	10	0.96
1.5	2	7.5	15	-	-	-	-	10	7	0.96
2.2	3	10.6	20.5	-	-	-	-	10	7	0.96
3	4	12.5	24	-	B1	-	B1	10	7	0.96
3.7	5	16.7	32	-	-	-	-	10	7	0.96
5.5	7.5	24.2	46	-	B1	-	B1	10	7	0.98
7.5	10	30.8	59	-	B2	-	B2	35	2	0.98

CUEs with single-phase input always have three-phase output.

Standard/imperial gland holes, product numbers

Select standard/imperial gland holes for CUEs.

Typical shaft power P2		CUE			Output filter IP20	
[kW]	[hp]	IP20/21	IP55	IP55 (US)	dU/dt	Sine-wave
1.1	1.5	99616601	99616618	99616625	-	96754973
1.5	2	99616602	99616619	99616626	-	96754973
2.2	3	99616613	99616620	99616627	-	96754976
3	4	99616614	99616621	99616628	-	96754976
3.7	5	99616615	99616622	99616629	-	96754976
5.5	7.5	99616616	99616623	99616630	-	96754977
7.5	10	99616617	99616624	99616631	-	96754978

Mains supply 3 x 200-240 V

Typical shaft power P2		Maximum output current [A]	Maximum input current [A]	Enclosure				Maximum conductor cross-section		Efficiency
[kW]	[hp]	3 x 200-240 V	3 x 200-240 V	IP20	IP21	IP54	IP55	[mm ²]	AWG	
0.75	1	4.6	4.1	-	-	-	-	4	10	0.95
1.1	1.5	6.6	5.9	-	-	-	-	4	10	0.96
1.5	2	7.5	6.8	A2	-	-	A4	4	10	0.96
2.2	3	10.6	9.5	-	-	-	-	4	10	0.96
3	4	12.5	11.3	-	-	-	-	4	10	0.96
3.7	5	16.7	15	A3	-	-	A5	4	10	0.96
5.5	7.5	24.2	22	-	-	-	-	10	7	0.96
7.5	10	30.8	28	B3	-	-	B1	10	7	0.96
11	15	46.2	42	-	-	-	-	10	7	0.96
15	20	59.4	54	-	-	-	B2	35	2	0.96
18.5	25	74.8	68	B4	-	-	-	50	1/0	0.96
22	30	88	80	-	-	-	C1	50	1/0	0.97
30	40	115	104	C3	-	-	-	50	1/0	0.97
37	50	143	130	-	-	-	-	95	4/0	0.97
45	60	170	154	C4	-	-	C2	120	250 MCM	0.97

Standard/imperial gland holes, product numbers

Select standard/imperial gland holes for CUEs

Typical shaft power P2		CUE					Output filter IP20	
[kW]	[hp]	IP20	IP20 with STO	IP55	IP55 with STO/DC	IP55 (US)	dU/dt	Sine-wave
0.75	1	99616636	99616651	99616666	99616681	99660285	-	96754973
1.1	1.5	99616637	99616652	99616667	99616682	99660287	-	96754973
1.5	2	99616638	99616653	99616668	99616683	99660289	-	96754973
2.2	3	99616639	99616654	99616669	99616684	99660290	-	96754976
3	4	99616640	99616655	99616670	99616685	99616696	-	96754976
3.7	5	99616641	99616656	99616671	99616686	99616697	-	96754976
5.5	7.5	99616642	99616657	99616672	99616687	99616698	97669799	96754977
7.5	10	99616643	99616658	99616673	99616688	99616699	97669799	96754978
11	15	99616644	99616659	99616674	99616689	99616700	97669869	96755019
15	20	99616645	99616660	99616675	99616690	99616701	97669869	96755021
18.5	25	99616646	99616661	99616676	99616691	99616702	97669869	96755032
22	30	99616647	99616662	99616677	99616692	99616703	97669869	97774436
30	40	99616648	99616663	99616678	99616693	99616704	97669902	97774436
37	50	99616649	99616664	99616679	99616694	99616705	97669902	97775142
45	60	99616650	99616665	99616680	99616695	99616706	97669902	97775142

Mains supply 3 x 380-500 V

If you want higher overload protection, select a CUE with a higher kW size.

Typical shaft power P2		Maximum output current [A]		Maximum input current [A]		Enclosure				Maximum conductor cross-section		Efficiency
[kW]	[hp]	3 x 380-440 V	3 x 441-500 V	3 x 380-440 V	3 x 441-500 V	IP20	IP21	IP54	IP55	[mm ²]	AWG	
0.55	0.75	1.8	1.6	1.6	1.4	-	-	-	-	4	10	0.95
0.75	1	2.4	2.1	2.2	1.9	-	-	-	-	4	10	0.96
1.1	1.5	3	2.7	2.7	2.7	-	-	-	-	4	10	0.96
1.5	2	4.1	3.4	3.7	3.1	A2	-	-	A4	4	10	0.97
2.2	3	5.6	4.8	5	4.3	-	-	-	-	4	10	0.97
3	4	7.2	6.3	6.5	5.7	-	-	-	-	4	10	0.97
4	5	10	8.2	9	7.4	-	-	-	-	4	10	0.97
5.5	7.5	13	11	11.7	9.9	A3	-	-	A5	4	10	0.97
7.5	10	16	14.5	14.4	13	-	-	-	-	4	10	0.97
11	15	24	21	22	19	-	-	-	-	10	7	0.98
15	20	32	27	29	25	B3	-	-	B1	10	7	0.98
18.5	25	37.5	34	34	31	-	-	-	-	10	7	0.98
22	30	44	40	40	36	-	-	-	-	35	2	0.98
30	40	61	52	55	47	B4	-	-	B2	35	2	0.98
37	50	73	65	66	59	-	-	-	-	50	1/0	0.98
45	60	90	80	82	73	-	-	-	-	50	1/0	0.98
55	75	106	105	96	95	C3	-	-	C1	50	1/0	0.98
75	100	147	130	133	118	-	-	-	-	95	4/0	0.98
90	125	177	160	161	145	C4	-	-	C2	120	250 MCM	0.99
110	150	212	190	204	183	-	D1h	D1h	-	2 x 70	2 x 2/0	0.98
132	200	260	240	251	231	-	-	-	-	2 x 70	2 x 2/0	0.98
160	250	315	302	304	291	-	-	-	-	2 x 185	2 x 350 MCM	0.98
200	300	395	361	381	348	-	D2h	D2h	-	2 x 185	2 x 350 MCM	0.98
250	350	480	443	463	427	-	-	-	-	2 x 185	2 x 350 MCM	0.98

Standard/imperial gland holes, product numbers

Select standard/imperial gland holes for CUEs.

Typical shaft power P2		CUE					Output filter IP20	
[kW]	[hp]	IP20/IP21	IP20/IP21 with STO	IP54/IP55	IP54/IP55 with STO/DC	IP54/IP55 (US)	dU/dt	Sine-wave
0.55	0.75	99616707	99616731	99616756	99616781	99660291	-	96754941
0.75	1	99616708	99616733	99616757	99616782	99660292	-	96754941
1.1	1.5	99616709	99616734	99616758	99616783	99660293	-	96754972
1.5	2	99616710	99616735	99616759	99616784	99660294	-	96754972
2.2	3	99616711	99616736	99616760	99616785	99660295	-	96754973
3	4	99616712	99616737	99616761	99616786	99660296	-	96754973
4	5	99616713	99616738	99616762	99616787	99660297	-	96754974
5.5	7.5	99616714	99616739	99616763	99616788	99616805	-	96754976
7.5	10	99616715	99616740	99616764	99616789	99616806	-	96754976
11	15	99616716	99616741	99616765	99616790	99616807	97669799	96754977
15	20	99616717	99616742	99616766	99616791	99616808	97669799	96754978
18.5	25	99616718	99616743	99616767	99616792	99616809	97669799	96754978
22	30	99616719	99616744	99616769	99616793	99616810	97669799	96755019
30	40	99616720	99616745	99616770	99616794	99616811	97669869	96755021
37	50	99616721	99616746	99616771	99616795	99616812	97669869	96755032
45	60	99616722	99616747	99616772	99616796	99616813	97669869	97774436
55	75	99616723	99616748	99616773	99616797	99616814	97669896	97774436
75	100	99616724	99616749	99616774	99616798	99616815	97669902	97775142
90	125	99616725	99616750	99616775	99616799	99616816	97669902	97775142
110	150	99616726	99616751	99616776	99616800	99616817	97669905	97775146
132	200	99616727	99616752	99616777	99616801	99616818	97669905	97775146
160	250	99616728	99616753	99616778	99616802	99616819	97669905	97775148
200	300	99616729	99616754	99616779	99616803	99616820	97669906	97775148
250	350	99616730	99616755	99616780	99616804	99616821	97669906	97775149

Mains supply 3 x 525-600 V

Typical shaft power P2		Maximum output current [A]		Maximum input current [A]		Enclosure				Maximum conductor cross-section		Efficiency
[kW]	[hp]	3 x 525-550 V	3 x 550-600 V	3 x 525-600 V	IP20	IP21	IP54	IP55	[mm ²]	AWG		
0.75	1	1.8	1.7	1.7		-	-		4	10	0.97	
1.1	1.5	2.6	2.4	2.4		-	-		4	10	0.97	
1.5	2	2.9	2.7	2.7		-	-		4	10	0.97	
2.2	3	4.1	3.9	4.1		-	-		4	10	0.97	
3	4	5.2	4.9	5.2	A3	-	-	A5	4	10	0.97	
4	5	6.4	6.1	5.8		-	-		4	10	0.97	
5.5	7.5	9.5	9	8.6		-	-		4	10	0.97	
7.5	10	11.5	11	10.4		-	-		4	10	0.97	
11	15	19	18	17.2		-	-		10	1/0	0.97	
15	20	23	22	20.9	B3	-	-	B1	10	1/0	0.97	
18.5	25	28	27	25.4		-	-		10	1/0	0.97	
22	30	36	34	32.7		-	-		35	1/0	0.97	
30	40	43	41	39	B4	-	-	B2	35	1/0	0.97	
37	50	54	52	49		-	-		35	1/0	0.97	
45	60	65	62	59		-	-	C1	50	1/0	0.97	
55	75	87	83	79	C3	-	-		50	1/0	0.97	
75	100	105	100	95		-	-	C2	150	1/0	0.97	
90	125	137	131	124	C4	-	-		150	1/0	0.97	

Standard/imperial gland holes, product numbers

Select standard/imperial gland holes for CUEs.

Typical shaft power P2		CUE		Output filter IP20
[kW]	[hp]	IP20	IP55 (US)	Sine-wave
0.75	1	99616827	99616845	97775161
1.1	1.5	99616828	99616846	97775161
1.5	2	99616829	99616847	97775161
2.2	3	99616830	99616848	97775161
3	4	99616831	99616849	97775161
4	5	99616832	99616850	97775161
5.5	7.5	99616833	99616851	97775161
7.5	10	99616834	99616852	97775161
11	15	99616835	99616853	97775162
15	20	99616836	99616854	97775162
18.5	25	99616837	99616855	97775162
22	30	99616838	99616856	97775163
30	40	99616839	99616857	97775163
37	50	99616840	99616858	97775164
45	60	99616841	99616859	97775164
55	75	99616842	99616860	97775165
75	100	99616843	99616861	97775165
90	125	99616844	99616862	97775166

Mains supply 3 x 525-690 V

UL approval up to 600 VAC mains

Typical shaft power P2		Maximum output current [A]		Maximum input current [A]		Enclosure				Maximum conductor cross-section		Efficiency
[kW]	[hp]	3 x 550 V	3 x 575-690 V	3 x 550 V	3 x 575-690 V	IP20	IP21	IP54	IP55	[mm ²]	AWG	
11	15	14	13	15	15	-	-	-	-	35	1/0	0.98
15	20	19	18	19.5	19.5	-	-	-	-	35	1/0	0.98
18.5	25	23	22	24	24	-	B2	-	B2	35	1/0	0.98
22	30	28	27	29	29	-	-	-	-	35	1/0	0.98
30	40	36	34	36	36	-	-	-	-	35	1/0	0.98
37	50	43	41	49	49	-	-	-	-	95	1/0	0.98
45	60	54	52	59	59	-	-	-	-	95	1/0	0.98
55	75	65	62	71	71	-	C2	-	C2	95	1/0	0.98
75	100	87	83	87	87	-	-	-	-	95	1/0	0.98
90	125	105	100	99	99	-	-	-	-	95	1/0	0.98
110	150	137	131	130	124/128	-	-	-	-	2 x 70	2 x 2/0	0.98
132	200	162	155	158	151/155	-	D1h	D1h/D5h	-	2 x 70	2 x 2/0	0.98
160	250	201	192	198	189/197	-	-	-	-	2 x 70	2 x 2/0	0.98
200	300	253	242	245	224/240	-	-	-	-	2 x 185	2 x 350 MCM	0.98
250	350	303	290	299	286/296	-	D2h	D2h/D7h	-	2 x 185	2 x 350 MCM	0.98

Standard/imperial gland holes, product numbers

Select standard/imperial gland holes for CUEs.

Typical shaft power P2		CUE				Output filter IP20			
[kW]	[hp]	IP20/IP21	IP20/IP21 with STO	IP54/IP55	IP55 with STO/DC	IP55 (US)	dU/dt	Sine-wave	
11	15	99616863	99616878	99616893	99616909	99616924	97669799	97775162	
15	20	99616864	99616879	99616894	99616910	99616925	97669799	97775162	
18.5	25	99616865	99616880	99616895	99616911	99616926	97669799	97775162	
22	30	99616866	99616881	99616896	99616912	99616927	97669799	97775163	
30	40	99616867	99616882	99616897	99616913	99616928	97669869	97775163	

Typical shaft power P2		CUE					Output filter IP20	
[kW]	[hp]	IP20/IP21	IP20/IP21 with STO	IP54/IP55	IP55 with STO/DC	IP55 (US)	dU/dt	Sine-wave
37	50	99616868	99616883	99616899	99616914	99616929	97669869	97775164
45	60	99616869	99616884	99616900	99616915	99616930	97669869	97775164
55	75	99616870	99616885	99616901	99616916	99616931	97669896	97775165
75	100	99616871	99616886	99616902	99616917	99616932	97669896	97775165
90	125	99616872	99616887	99616903	99616918	99616933	97669902	97775166
110	150	99616873	99616888	99616904	99616919	99616919	97669905	97775166
132	200	99616874	99616889	99616905	99616920	99616920	97669905	97775167
160	250	99616875	99616890	99616906	99616921	99616921	97669906	97775167
200	300	99616876	99616891	99616907	99616922	99616921	97669906	97775168
250	350	99616877	99616892	99616908	99616923	99616921	97899248	97775168

11. Technical data

11.1 Main dimensions and weights, SI units

Enclosure	Height [mm]		Width [mm]		Depth [mm]		Screw holes [mm]			Weight [kg]	
	A	a	B	b	C	C ¹⁾	c	Ød	Øe		f
A2	268	257	90	70	205	219	8	11	5.5	9	4.9
A3	268	257	130	110	205	219	8	11	5.5	9	6.6
A4	420	398	200	171	178	178	7	12.6	6.5	9	9.2
A5	420	402	242	215	200	200	8.25	12	6.5	6.5	14.0
B1	480	454	242	210	260	260	12	19	9	9	23.0
B2	650	624	242	210	260	260	12	19	9	9	27.0
B3	399	380	165	140	248	262	8	12	6.8	7.9	12.0
B4	518	495	231	200	242	242	-	-	8.5	15	23.5
C1	685	648	308	272	311	311	12.5	19	9	9.8	45.0
C2	767	739	371	334	335	335	12.5	19	9	9.8	61.9
C3	550	521	308	270	334	334	-	-	8.5	17	35.0
C4	660	631	370	330	334	334	-	-	8.5	17	50.0
D1h	901	844	325	180	378	-	20	11	11	25	62.0
D2h	1107	1051	420	280	378	-	20	11	11	25	125.0

¹⁾ Depth with MCB 114 option.

Shipping dimensions of D1h and D2h: height x width x length = 650 x 570 x 1730 mm.

11.2 Main dimensions and weights, US units

Enclosure	Height [in]		Width [in]		Depth [in]		Screw holes [in]			Weight [lb]	
	A	a	B	b	C	C ¹⁾	c	Ød	Øe		f
A2	10.5	10.1	3.5	2.8	8.1	8.6	0.3	0.43	0.22	0.35	10.8
A3	10.5	10.1	5.1	4.3	8.1	8.6	0.3	0.43	0.22	0.35	14.5
A4	16.5	15.7	7.8	6.7	7.0	7.0	0.2	0.49	0.25	0.35	20.3
A5	16.5	15.8	9.5	8.7	7.8	7.8	0.32	0.47	0.25	0.25	30.8
B1	18.9	17.8	9.5	8.2	10.2	10.2	0.47	0.75	0.35	0.35	50.7
B2	25.6	24.5	9.5	8.2	10.2	10.2	0.47	0.75	0.35	0.35	59.5
B3	15.7	14.9	6.5	5.5	9.7	10.3	0.3	0.47	0.26	0.31	26.4
B4	20.3	19.5	9.1	7.8	9.5	9.5	-	-	0.33	0.59	51.8
C1	26.9	25.5	12.1	10.7	12.2	12.2	0.49	0.75	0.35	0.4	99.2
C2	30.2	29.0	14.6	13.1	13.2	13.2	0.49	0.75	0.35	0.4	136.5
C3	21.6	20.5	12.1	10.6	13.1	13.1	-	-	0.33	0.67	77.1
C4	25.9	24.8	14.5	12.9	13.1	13.1	-	-	0.33	0.67	110.2
D1h	35.4	33.2	12.7	7.1	14.8	-	0.78	0.43	0.43	0.9	136.6
D2h	43.6	41.3	16.5	11.0	14.8	-	0.78	0.43	0.43	0.9	275.6

¹⁾ Depth with MCB 114 option.

Shipping dimensions of D1h and D2h: height x width x length = 25.6 x 22.4 x 68 inches.

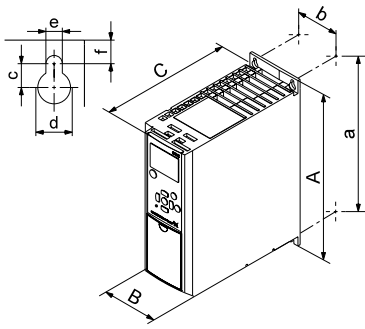

TM039000

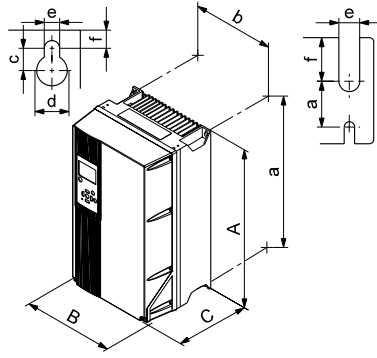

TM039002

Enclosures A2, A3 and B3

Enclosures A5, B1, B2, C1 and C2

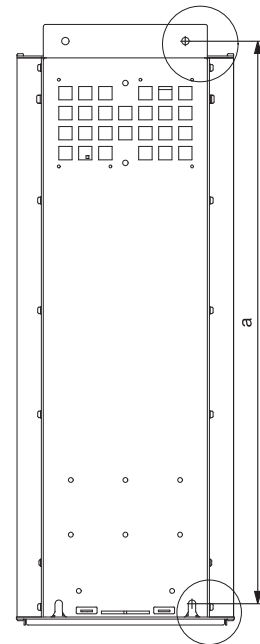
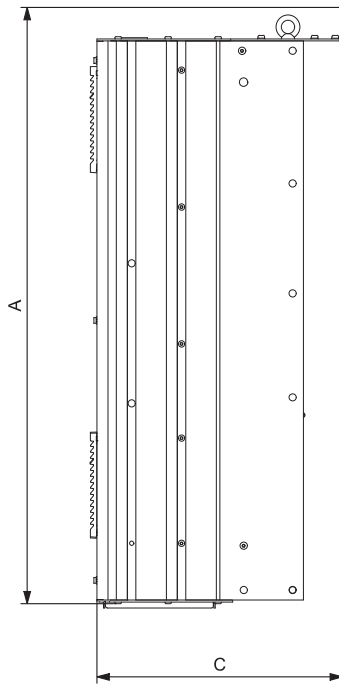
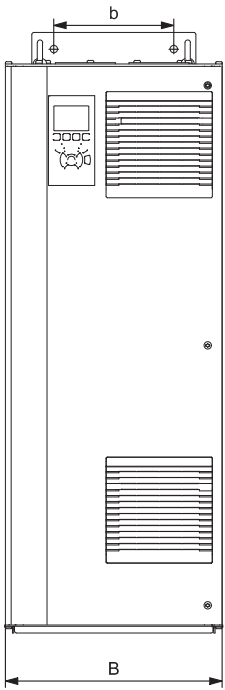

DETAIL A

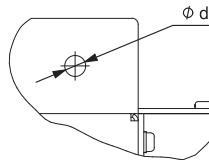

DETAIL B

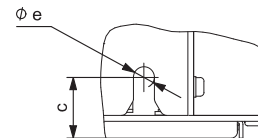

TM059331

Enclosures D1h and D2h

11.3 Surroundings

Relative humidity	5-95 % RH
Minimum ambient temperature at full operation	0 °C (32 °F)
Minimum ambient temperature at reduced operation	-10 °C (14 °F)
Temperature during storage and transportation	-25 to +65 °C (-13 to 149 °F)
Storage duration	Max. 6 months
Maximum altitude above sea level with full performance	1000 m (3280 ft)
Maximum altitude above sea level with reduced performance	3000 m (9840 ft)
CUE, 0.55 - 90 kW (0.75 - 125 hp)	
Ambient temperature	Max. 50 °C (122 °F)
Average ambient temperature over 24 hours	Max. 45 °C (113 °F)
CUE, 110-250 kW (150-350 hp)	
Ambient temperature	Max. 45 °C (113 °F)
Average ambient temperature over 24 hours	Max. 40 °C (104 °F)

CUE comes in packaging which is not suitable for outdoor storage.

11.4 Sound pressure level

Maximum sound pressure level measured at a distance of one metre from the unit:

Enclosure	Sound pressure level [dB(A)]
A2	60
A3	60
A4	55
A5	63
B1	67
B2	70
B3	63 ¹⁾
B4	63
C1	62
C2	65
C3	67
C4	-
D1h	76
D2h	74

¹⁾ The sound pressure level for B3 in the 3 x 525-600 V range is 70 dB(A).

The sound pressure level of a motor controlled by a frequency converter may be higher than that of a corresponding motor which is not controlled by a frequency converter.

11.5 Torques for terminals

Enclosure	Torque [Nm]			
	Mains	Motor	Earth	Relay
A2	1.8	1.8	3	0.6
A3	1.8	1.8	3	0.6
A4	1.8	1.8	3	0.6
A5	1.8	1.8	3	0.6
B1	1.8	1.8	3	0.6
B2	4.5	4.5	3	0.6
B3	1.8	1.8	3	0.6
B4	4.5	4.5	3	0.6
C1	10	10	3	0.6
C2	14 ¹⁾ /24 ²⁾	14 ¹⁾ /24 ²⁾	3	0.6
C3	10	10	3	0.6
C4	14 ¹⁾ /24 ²⁾	14 ¹⁾ /24 ²⁾	3	0.6
D1h	19	19	19	0.6
D2h	19	19	19	0.6

¹⁾ Conductor cross-section $\leq 95 \text{ mm}^2$ (4/0 AWG)

²⁾ Conductor cross-section $\geq 95 \text{ mm}^2$ (4/0 AWG).

11.6 Cables

Cable length

Maximum length, screened motor cable	150 m (500 ft)
Maximum length, unscreened motor cable	300 m (1000 ft)
Maximum length, signal cable	300 m (1000 ft)

Cable cross-section to signal terminals

Maximum cable cross-section to signal terminals, rigid conductor	1.5 mm ² (14 AWG)
Maximum cable cross-section to signal terminals, flexible conductor	1.0 mm ² (18 AWG)
Minimum cable cross-section to signal terminals	0.5 mm ² (20 AWG)

For cable cross-section to mains and motor, see the section about fuses.

Related information

11.8 Fuses

11.7 Inputs and outputs

Mains supply (L1, L2, L3)

Supply voltage	200-240 V ± 10 %
Supply voltage	380-500 V ± 10 %
Supply voltage	525-600 V ± 10 %
Supply voltage	525-690 V ± 10 %
Supply frequency	50/60 Hz
Maximum temporary imbalance between phases	3 % of rated value
Leakage current to earth	> 3.5 mA
Number of cut-ins, enclosure A	Max. 2 times/min.
Number of cut-ins, enclosures B and C	Max. 1 time/min.
Number of cut-ins, enclosure D	Max. 1 time/2 min.

Do not use the supply voltage for switching CUE on and off.

Motor output (U, V, W)

Output voltage	0-100 % ¹⁾
Output frequency	0-590 Hz ²⁾
Switching on output	Not recommended

¹⁾ Output voltage in % of supply voltage.

²⁾ Depending on the pump family selected.

RS-485 GENiBus connection

Terminal number	68 (A), 69 (B), 61 GND (Y)
-----------------	----------------------------

The RS-485 circuit is functionally separated from other central circuits and galvanically separated from the supply voltage (PELV).

Digital inputs

Terminal number	18, 19, 27, 29, 32, 33
Voltage level	0-24 VDC
Voltage level, open contact	> 19 VDC
Voltage level, closed contact	< 14 VDC
Maximum voltage on input	28 VDC
Input resistance, R _i	Approx. 4 kΩ

All digital inputs are galvanically separated from the supply voltage (PELV) and other high-voltage terminals.

Signal relays

Relay 01, terminal number	1 (C), 2 (NO), 3 (NC)
Relay 02, terminal number	4 (C), 5 (NO), 6 (NC)
Maximum terminal load (AC-1) ¹⁾	240 VAC, 2 A
Maximum terminal load (AC-15) ¹⁾	240 VAC, 0.2 A
Maximum terminal load (DC-1) ¹⁾	50 VDC, 1 A
Minimum terminal load	24 VDC, 10 mA 24 VAC, 20 mA

¹⁾ IEC 60947, parts 4 and 5.

C: Common

NO: Normally open

NC: Normally closed

The relay contacts are galvanically separated from other circuits by reinforced insulation (PELV).

Analog inputs

Analog input 1, terminal number (external set-point)	53
Voltage signal	A53 = "U" ¹⁾
Voltage range	0-10 V
Input resistance	Approx. 10 kΩ
Maximum voltage	± 20 V
Current signal	A53 = "I" ¹⁾
Current range	0-20, 4-20 mA
Input resistance	Approx. 200 Ω
Maximum current	30 mA
Maximum fault, terminals 53, 54	0.5 % of full scale

Analog input 2, terminal number (sensor 1)	54
Current signal	A54 = "I" ¹⁾
Current range	0-20, 4-20 mA
Input resistance, R _i	Approx. 200 Ω
Maximum current	30 mA
Maximum fault, terminals 53, 54	0.5 % of full scale

¹⁾ The factory setting is voltage signal "U".

All analog inputs are galvanically separated from the supply voltage (PELV) and other high-voltage terminals.

Analog output

Analog output 1, terminal number (sensor 2)	42
Current range	0-20 mA
Maximum load to frame	500 Ω
Maximum fault	0.8 % of full scale

The analog output is galvanically separated from the supply voltage (PELV) and other high-voltage terminals.

MCB 114 sensor input module

Analog input 3, terminal number	2
Current range	0/4-20 mA
Input resistance	< 200 Ω
Analog input 4, terminal number	4, 5
Analog input 5, terminal number	7, 8
Signal type, 2- or 3-wire	Pt100/Pt1000

When using Pt100 with 3-wire cable, the resistance must not exceed 30 Ω.

11.8 Fuses

Non-UL fuses and conductor cross-section to mains and motor

Typical shaft power P2	Maximum fuse size	Fuse type	Maximum conductor cross-section ¹⁾
[kW]	[A]		[mm ²]
1 x 200-240 V			
1.1	20	gG	4
1.5	30	gG	10
2.2	40	gG	10
3	40	gG	10
3.7	60	gG	10
5.5	80	gG	10
7.5	100	gG	35
3 x 200-240 V			
0.75	10	gG	4
1.1	20	gG	4
1.5	20	gG	4
2.2	20	gG	4
3	32	gG	4
3.7	32	gG	4
5.5	63	gG	10
7.5	63	gG	10
11	63	gG	10
15	80	gG	35
18.5	125	gG	50
22	125	gG	50
30	160	gG	50
37	200	aR	95
45	250	aR	120
3 x 380-500 V			
0.55	10	gG	4
0.75	10	gG	4
1.1	10	gG	4
1.5	10	gG	4
2.2	20	gG	4
3	20	gG	4
4	20	gG	4
5.5	32	gG	4
7.5	32	gG	4
11	63	gG	10
15	63	gG	10
18.5	63	gG	10
22	63	gG	35
30	80	gG	35
37	100	gG	50
45	125	gG	50
55	160	gG	50
75	250	aR	95
90	250	aR	120
110	300	gG	2 x 70
132	350	gG	2 x 70
160	400	gG	2 x 185
200	500	gG	2 x 185
250	600	gR	2 x 185

Typical shaft power P2	Maximum fuse size	Fuse type	Maximum conductor cross-section ¹⁾
[kW]	[A]		[mm ²]
3 x 525-600 V			
0.75	10	gG	4
1.1	10	gG	4
1.5	10	gG	4
2.2	20	gG	4
3	20	gG	4
4	20	gG	4
5.5	32	gG	4
7.5	32	gG	4
3 x 525-690 V			
11	63	gG	35
15	63	gG	35
18.5	63	gG	35
22	63	gG	35
30	63	gG	35
37	80	gG	95
45	100	gG	95
55	125	gG	95
75	160	gG	95
90	160	gG	95
110	225	-	2 x 70
132	250	-	2 x 70
160	350	-	2 x 70
200	400	-	2 x 185
250	500	-	2 x 185

¹⁾ Screened motor cable, unshielded supply cable.

UL fuses and conductor cross-section to mains and motor

Typical shaft power P ₂		Fuse type							Maximum conductor cross-section ¹⁾
[kW]	[hp]	Bussmann J	Bussmann T	SIBA RK1	Littel Fuse RK1	Ferraz-Shawmut CC	Ferraz-Shawmut RK1	Bussmann E1958 JFHR2	[AWG] ²⁾
1 x 200-240 V									
1.1	1.5	KTN-R20	-	-	-	-	-	-	10
1.5	2	KTN-R30	-	-	-	-	-	-	7
2.2	3	KTN-R40	-	-	-	-	-	-	7
3	4	KTN-R40	-	-	-	-	-	-	7
3.7	5	KTN-R60	-	-	-	-	-	-	7
5.5	7.5	-	-	-	-	-	-	-	7
7.5	10	-	-	-	-	-	-	-	2
3 x 200-240 V									
0.75	1	KTN-R10	JKS-10	JJN-10	5017906-010	KTN-R10	ATM-R10	A2K-10R	10
1.1	1.5	KTN-R20	JKS-20	JJN-20	5017906-020	KTN-R20	ATM-R20	A2K-20R	10
1.5	2	KTN-R20	JKS-20	JJN-20	5017906-020	KTN-R20	ATM-R20	A2K-20R	10
2.2	3	KTN-R20	JKS-20	JJN-20	5017906-020	KTN-R20	ATM-R20	A2K-20R	10
3	4	KTN-R30	JKS-30	JJN-30	5012406-032	KTN-R30	ATM-R30	A2K-30R	10
3.7	5	KTN-R30	JKS-30	JJN-30	5012406-032	KTN-R30	ATM-R30	A2K-30R	10
5.5	7.5	KTN-R50	JKS-50	JJN-50	5012406-050	KLN-R50	-	A2K-50R	7
7.5	10	KTN-R50	JKS-60	JJN-60	5012406-050	KLN-R60	-	A2K-50R	7
11	15	KTN-R60	JKS-60	JJN-60	5014006-063	KLN-R60	A2K-60R	A2K-60R	7
15	20	KTN-R80	JKS-80	JJN-80	5014006-080	KLN-R80	A2K-80R	A2K-80R	2
18.5	25	KTN-R125	JKS-150	JJN-125	2028220-125	KLN-R125	A2K-125R	A2K-125R	1/0
22	30	KTN-R125	JKS-150	JJN-125	2028220-125	KLN-R125	A2K-125R	A2K-125R	1/0
30	40	FWX-150	-	-	2028220-150	L25S-150	A25X-150	A25X-150	1/0
37	50	FWX-200	-	-	2028220-200	L25S-200	A25X-200	A25X-200	4/0
45	60	FWX-250	-	-	2028220-250	L25S-250	A25X-250	A25X-250	250 MCM
3 x 380-500 V									
0.55	0.75	KTS-R10	JKS-10	JJS-10	5017906-010	KTN-R10	ATM-R10	A2K-10R	10
0.75	1	KTS-R10	JKS-10	JJS-10	5017906-010	KTN-R10	ATM-R10	A2K-10R	10
1.1	1.5	KTS-R10	JKS-10	JJS-10	5017906-010	KTN-R10	ATM-R10	A2K-10R	10
1.5	2	KTS-R10	JKS-10	JJS-10	5017906-010	KTN-R10	ATM-R10	A2K-10R	10
2.2	3	KTS-R20	JKS-20	JJS-20	5017906-020	KTN-R20	ATM-R20	A2K-20R	10
3	4	KTS-R20	JKS-20	JJS-20	5017906-020	KTN-R20	ATM-R20	A2K-20R	10
4	5	KTS-R20	JKS-20	JJS-20	5017906-020	KTN-R20	ATM-R20	A2K-20R	10
5.5	7.5	KTS-R30	JKS-30	JJS-30	5012406-032	KTN-R30	ATM-R30	A2K-30R	10
7.5	10	KTS-R30	JKS-30	JJS-30	5012406-032	KTN-R30	ATM-R30	A2K-30R	10
11	15	KTS-R40	JKS-40	JJS-40	5014006-040	KLS-R40	-	A6K-40R	7
15	20	KTS-R40	JKS-40	JJS-40	5014006-040	KLS-R40	-	A6K-40R	7
18.5	25	KTS-R50	JKS-50	JJS-50	5014006-050	KLS-R50	-	A6K-50R	7
22	30	KTS-R60	JKS-60	JJS-60	5014006-063	KLS-R60	-	A6K-60R	2
30	40	KTS-R80	JKS-80	JJS-80	2028220-100	KLS-R80	-	A6K-80R	2
37	50	KTS-R100	JKS-100	JJS-100	2028220-125	KLS-R100	-	A6K-100R	1/0
45	60	KTS-R125	JKS-150	JJS-150	2028220-125	KLS-R125	-	A6K-125R	1/0
55	75	KTS-R150	JKS-150	JJS-150	2028220-160	KLS-R150	-	A6K-150R	1/0
75	100	FWH-220	-	-	2028220-200	L50S-225	-	A50-P225	4/0
90	125	FWH-250	-	-	2028220-250	L50S-250	-	A50-P250	250 MCM
110	150	FWH-300	JJS-300	NOS-300	170M3017	2028220-315	L50S-300	A50-P300	2 x 2/0
132	200	FWH-350	JJS-350	NOS-350	170M3018	2028220-315	L50S-350	A50-P350	2 x 2/0
160	250	FWH-400	JJS-400	NOS-400	170M4012	206xx32-400	L50S-400	A50-P400	2 x 350 MCM
200	300	FWH-500	JJS-500	NOS-500	170M4014	206xx32-500	L50S-500	A50-P500	2 x 350 MCM
250	350	FWH-600	JJS-600	NOS-600	170M4016	206xx32-600	L50S-600	A50-P600	2 x 350 MCM

Typical shaft power P2		Fuse type							Maximum conductor cross-section ¹⁾
[kW]	[hp]	Bussmann J	Bussmann T	SIBA RK1	Littel Fuse RK1	Ferraz-Shawmut CC	Ferraz-Shawmut RK1	Bussmann E1958 JFHR2	[AWG] ²⁾
-	-	-	-	-	Bussmann E125085 JFHR2	SIBA E180276 JFHR2	-	Ferraz-Shawmut E76491 JFHR2	-
3 x 525-600 V									
0.75	1	KTS-R10	JKS-10	JJS-10	5017906-010	KTN-R10	ATM-R10	A2K-10R	10
1.1	1.5	KTS-R10	JKS-10	JJS-10	5017906-010	KTN-R10	ATM-R10	A2K-10R	10
1.5	2	KTS-R10	JKS-10	JJS-10	5017906-010	KTN-R10	ATM-R10	A2K-10R	10
2.2	3	KTS-R20	JKS-20	JJS-20	5017906-020	KTN-R20	ATM-R20	A2K-20R	10
3	4	KTS-R20	JKS-20	JJS-20	5017906-020	KTN-R20	ATM-R20	A2K-20R	10
4	5	KTS-R20	JKS-20	JJS-20	5017906-020	KTN-R20	ATM-R20	A2K-20R	10
5.5	7.5	KTS-R30	JKS-30	JJS-30	5012406-032	KTN-R30	ATM-R30	A2K-30R	10
7.5	10	KTS-R30	JKS-30	JJS-30	5012406-032	KTN-R30	ATM-R30	A2K-30R	10
3 x 525-690 V									
11	15	KTS-R-25	JKS-25	JJS-25	5017906-025	KLSR025	HST25	A6K-25R	1/0
15	20	KTS-R-30	JKS-30	JJS-30	5017906-030	KLSR030	HST30	A6K-30R	1/0
18.5	25	KTS-R-45	JKS-45	JJS-45	5014006-050	KLSR045	HST45	A6K-45R	1/0
22	30	KTS-R-45	JKS-45	JJS-45	5014006-050	KLSR045	HST45	A6K-45R	1/0
30	40	KTS-R-60	JKS-60	JJS-60	5014006-063	KLSR060	HST60	A6K-60R	1/0
37	50	KTS-R-80	JKS-80	JJS-80	5014006-080	KLSR075	HST80	A6K-80R	1/0
45	60	KTS-R-90	JKS-90	JJS-90	5014006-100	KLSR090	HST90	A6K-90R	1/0
55	75	KTS-R-100	JKS-100	JJS-100	5014006-100	KLSR100	HST100	A6K-100R	1/0
75	100	KTS-R125	JKS-125	JJS-125	2028220-125	KLS-125	HST125	A6K-125R	1/0
90	125	KTS-R150	JKS-150	JJS-150	2028220-150	KLS-150	HST150	A6K-150R	1/0
110	150	-	-	-	170M3017	2061032.315	-	6.6URD30D08A 0315	2 x 2/0
132	200	-	-	-	170M3018	2061032.350	-	6.6URD30D08A 0350	2 x 2/0
160	250	-	-	-	170M4011	2061032.350	-	6.6URD30D08A 0350	2 x 2/0
200	300	-	-	-	170M4012	2061032.400	-	6.6URD30D08A 0400	2 x 350 MCM
250	350	-	-	-	170M4014	2061032.500	-	6.6URD30D08A 0500	2 x 350 MCM

1) Screened motor cable, unscreened supply cable.

2) American Wire Gauge.

12. Accessories

12.1 Product numbers

12.1.1 CUE accessories

Connectors	Type	Product number
Connectors for CUE (spare parts)	All types	97641449
Add-on module		
Sensor input module	MCB 114	96760901
Multipump module	MCO 101	99753103
Grundfos Local Control Panel	GLCP	99591437
Remote-mounting option for GLCP, with 3 m cable	GLCP remote mounting	96801229
Floor mounting option		
Enclosures D1 and D2 option, including pedestal parts and instructions	Floor mounting	96801230
Enclosure D1h option, including pedestal parts	Floor mounting	98606900
Enclosure D2h option, including pedestal parts	Floor mounting	98606903
IP21/NEMA1 option		
Enclosure A2	IP21/NEMA1 A2	96801223
Enclosure A3	IP21/NEMA1 A3	96801224
Enclosure B3	IP21/NEMA1 B3	96801225
Enclosure B4	IP21/NEMA1 B4	96801226
Enclosure C3	IP21/NEMA1 C3	96801227
Enclosure C4	IP21/NEMA1 C4	96801228
Output filters, see the section about output filters		
Sine-wave filters ¹⁾		
dU/dt filters ¹⁾		

¹⁾ For product numbers of sine-wave filters and dU/dt filters, see the section about selection tables.

Related information

10.3 Selection tables

12.1.3 Output filters

12.1.2 Communication modules

Communication interface	Type	Product number
LonWorks gateway	CIU 100	96753735
PROFIBUS gateway	CIU 150	96753081
Modbus gateway	CIU 200	96753082
GSM modem	CIU 250	96787106
BACnet communication interface	CIU 300	96893769
Grundfos Remote Management (GRM)	CIU 271	96898819
CIU 900	Empty CIU unit. For all CIM modules.	99448387
CIU 901	Empty CIU unit with built-in IO board (IO 270). For CIM 200, CIM 260 and CIM 500.	99448389
CIM 040 GENI TTL	For CU 354 DDD.	98415941
CIM 050 GENIbus		96824631
CIM 060 GlowPan	Requires 98778357 antenna kit for CIM 060.	98778356
CIM 100 LON	LON for pumps.	96824797
CIM 110	LON for boosters and twin pumps. Install CIM in master head in twin pumps and Multi-E.	96824798
CIM 150 PROFIBUS DP		96824793
CIM 200 Modbus RTU		96824796

Communication interface	Type	Product number
CIM 260-EU 3G/4G cellular	For European frequency bands. Requires 99518079 antenna kit. 3G/4G SIM card.	99439302
CIM 260-US 3G/4G cellular	For North American frequency bands. Requires 99518079 antenna kit. 3G/4G SIM card.	99439306
CIM 280-EU Grundfos iSolutions Cloud/GRM 3G/4G*	For European frequency bands. Requires 99518079 antenna kit. The 3G/4G SIM card must have the additional international PDU SMS roaming activated.	99439724
CIM 280-US Grundfos iSolutions Cloud/GRM 3G/4G*	For North American frequency bands. Requires 99518079 antenna kit. The 3G/4G SIM card must have the additional international PDU SMS roaming activated.	99439725
CIM 300 BACnet MS/TP		96893770
CIM 500 Ethernet*	For Industrial Ethernet protocols PROFINET, Modbus TCP, BACnet IP, EtherNet/IP and for GRM IP.	98301408

* Additional GRM contract needed for data hosting in Grundfos iSolutions Cloud/GRM.

Sensors, SI units

Danfoss pressure sensor, cable not included	Type	Measuring range [bar]	Product number
	MBS 3000	0 - 2.5	96478188
	MBS 3000	0-4	91072075
Pressure connection: G 1/2" A (DIN 16288 - B6kt)	MBS 3000	0-6	91072076
Electrical connection: Plug (DIN 43650)	MBS 3000	0-10	91072077
	MBS 3000	0-16	91072078
	MBS 3000	0-25	91072079
Danfoss pressure sensor option, 2 m screened cable			
	MBS 3000	0-4	96428014
Pressure connection: G 1/2" A (DIN 16288 - B6kt)	MBS 3000	0-6	96428015
5 cable clips (black)	MBS 3000	0-10	96428016
Instruction manual PT (00 40 02 12)	MBS 3000	0-16	96428017
	MBS 3000	0-25	96428018
	MBS 3000	0 - 2.5	405159
Pressure connection: G 1/4" A (DIN 16288 - B6kt)	MBS 3000	0-4	405160
5 cable clips (black)	MBS 3000	0-6	405161
Instruction manual PT (00 40 02 12)	MBS 3000	0-10	405162
	MBS 3000	0-16	405163
Grundfos differential pressure sensor option, 0.9 m screened cable			
	DPI	0 - 0.6	96611522
Pressure connection: 7/16"	DPI	0-1	96611523
Including fittings for pressure connection (1/4" - 7/16")	DPI	0 - 1.6	96611524
Brackets for wall and motor mounting	DPI	0 - 2.5	96611525
3 capillary tubes (short/long) and 5 cable clips (black)	DPI	0-4	96611526
Installation and operating instructions	DPI	0-6	96611527
Service kit instructions	DPI	0-10	96611550
Carlo Gavazzi temperature sensor			
		[°C]	
	TTA (0) 25	0-25	96432591
Temperature sensors	TTA (-25) 25	-25 to +25	96430194
	TTA (50) 100	50-100	96432592
	TTA (0) 150	0-150	96430195
Sensor pocket for TTA, with G 1/2" connection	∅9 x 50	-	96430201
	∅9 x 100	-	96430202
Cutting ring bush for TTA, with G 1/2" connection	-	-	96430203
Siemens flowmeter		[m ³ /h]	

Danfoss pressure sensor, cable not included	Type	Measuring range [bar]	Product number
Siemens flowmeter, MAGFLO	MAG 3100/5000	1-5 (DN 25)	00ID8285
	MAG 3100/5000	3-10 (DN 40)	00ID8286
	MAG 3100/5000	6-30 (DN 65)	00ID8287
	MAG 3100/5000	20-75 (DN 100)	00ID8288
Siemens analog level sensor		[bar]	
Analog level sensor with cable hanger	-	0.5	96377410
Ultrasonic transmitter for level	-	0.5	96693767
Jumo level sensor			
With 10 m cable	4390	0 - 0.1	99488569
With 20 m cable	4390	0 - 0.1	99488553
With 30 m cable	4390	0-1	99488550
With 75 m cable	4390	0-1	99488564
With 120 m cable	4390	0-1	99488566
With 30 m cable	4390	0 - 2.5	99488565
With 65 m cable	4390	0-6	99488567
With 105 m cable	4390	0-10	99488578

All sensors have a 4-20 mA output.

Sensors, US units

Danfoss pressure sensor, cable not included	Type	Measuring range [psi]	Product number
Pressure connection: 1/4"-18 NPT Electrical connection: DIN 43650 (plug not included)	MBS 3000	0-58	91136013
	MBS 3000	0-87	91136014
	MBS 3000	0-145	91136015
	MBS 3000	0-232	91136016
	MBS 3000	0-362	91136017
	MBS 3000	0-580	91136018
	MBS 3000	0-870	91136019
Danfoss pressure sensor, 2 m screened cable			
Pressure connection: 1/2"-14 NPT	MBS 3000	0-120	96437852
Grundfos differential pressure sensor, 0.9 m screened cable			
Pressure connection: 7/16" flare	DPI	0-20	96624396
	DPI	0-33	96624397
	DPI	0-54	96624398
	DPI	0-84	96624399
	DPI	0-200	96624441
	DPI	0-334	96624442

All sensors have a 4-20 mA output.

Pt100 temperature sensors

Pt100 temperature sensor	Type	Measuring range	Product number
With 20 m (65 ft) cable	-	-	96408957
With 40 m (131 ft) cable	-	-	96408684
With 60 m (197 ft) cable	-	-	96408958
With 80 m (262 ft) cable	-	-	96408959
With 100 m (328 ft) cable	-	-	96408960
With 20 m (65 ft) cable	-	-	96437784
With 40 m (131 ft) cable	-	-	96437785
With 60 m (197 ft) cable	-	-	96437786
With 80 m (262 ft) cable	-	-	96437787
With 100 m (328 ft) cable	-	-	96437788

Pt100 temperature sensor	Type	Measuring range	Product number
Pt100 temperature sensor and cable extension			
Pt100	-	-	95043173
Cable extension ¹⁾	-	-	00RM5271
Cable extension, disassembled option ¹⁾	-	-	96571480
Cable extension, assembled option ¹⁾	-	-	96763223

¹⁾ State number of metres when ordering.

Other accessories

Dry-running protection ¹⁾	Type	Product number
Module, sensor, 5 m (16 ft) cable, 200-240 V ²⁾	LiqTec	96556429
Module, sensor, 5 m (16 ft) cable, 80-130 V ²⁾	LiqTec	99556430
Extension cable, 15 m (49 ft)		96443676

¹⁾ Main pump types CR, CRI, CRN, MTR, SPK, CRK and CHI.

²⁾ Sensor connection: 1/2".

12.1.3 Output filters

Dimensions and weights of output filters

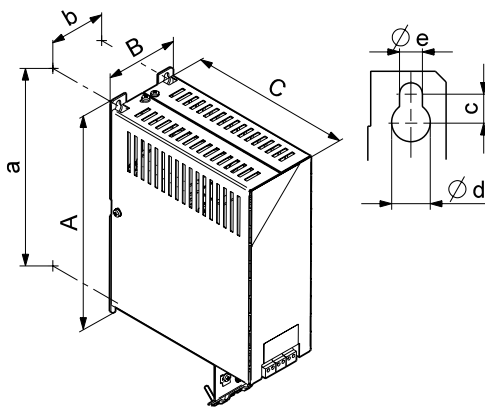

TM040625

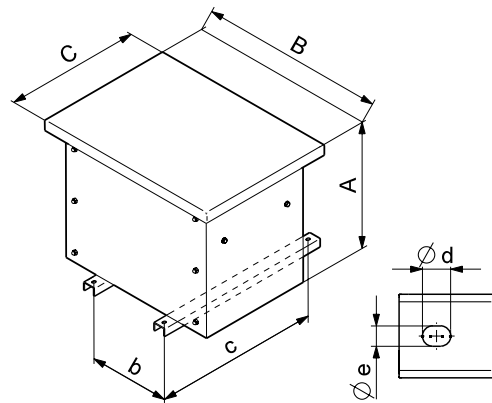

TM040624

Wall mounting

Floor mounting

Product number	Mounting	IP rating	Height [mm]		Width [mm]		Depth [mm]		Screw holes [mm]			Weight[kg]
			A	a	B	b	C	c	Ød	Øe	f	
Sine-wave filters												
96754941	Wall	IP20	200	190	75	60	205	-	8	4.5	7	3.3
96754941	Wall	IP20	200	190	75	60	205	-	8	4.5	7	4.2
96754972	Wall	IP20	268	257	90	70	206	-	11	6.5	8	5.8
96754973	Wall	IP20	268	257	90	70	205	-	11	6.5	8	7.1
96754974	Wall	IP20	268	257	130	90	205	-	11	6.5	8	9.1
96754976	Wall	IP20	330	312	150	120	260	-	19	9	12	16.9
96754977	Wall	IP20	430	412	150	120	260	-	19	9	12	19.9
96754978	Wall	IP20	530	500	170	125	260	-	19	9	12	39
96755019	Wall	IP20	610	580	170	125	260	-	19	9	12	41
96755021	Wall	IP20	200	190	75	60	205	-	8	4.5	7	41
97774436	Floor	IP23	918	-	940	779	792	660	11	22	-	205.0
97775142	Floor	IP23	918	-	940	779	792	660	11	22	-	237.0
97775146	Floor	IP23	918	-	940	779	792	660	11	22	-	307.0
97775148	Floor	IP23	918	-	940	779	792	660	11	22	-	370.0
97775149	Floor	IP23	1161	-	1260	1099	991	860	11	22	-	425.0
97775161	Wall	IP20	465	420	118	85	243	-	13	6.2	-	21.0
97775162	Wall	IP20	505	460	158	125	310	-	13	6.2	-	31.0
97775163	Wall	IP20	625	580	158	125	310	-	13	6.2	-	49.0
97775164	Floor	IP23	715	-	798	676	620	502	11	22	-	142.0
97775165	Floor	IP23	715	-	798	676	620	502	11	22	-	160.0
97775166	Floor	IP23	918	-	940	779	792	660	11	22	-	270.0
97775167	Floor	IP23	1161	-	1260	1099	991	860	11	22	-	475.0
97775168	Floor	IP23	1161	-	1260	1099	991	860	11	22	-	673.0
dU/dt filters												
97669869	Wall	IP20	475	379	157	125	248	11.5	13	6.2	6	16.2
97669869	Wall	IP20	475	379	157	125	248	11.5	13	6.2	6	16.2
97669896	Wall	IP20	475	379	158	125	248	11.5	13	6.2	6	25.5
97669902	Wall	IP20	525	429	188	155	335	11.5	13	6.2	6	30
97669905	Floor	IP23	620	-	425	325	700	660	-	13	17	64.5
97669906	Floor	IP23	620	-	425	325	700	660	-	13	17	67.5
97689248	Floor	IP23	620	-	425	325	700	660	-	13	17	78.5

Common mode filters

Product number	Description
99455084	Common mode filter, D frame
99455091	Common mode filter, C2, C3 and C4 frame
99455094	Common mode filter, A and B frame
99846117	Common mode filter, C1 frame

12.2 Grundfos differential pressure sensor, DPI

Product description

A cable (pos. 1) goes through an M12 x 1.5 Pg connection. See the figure below.

The sensor housing and parts in contact with the medium are made of Inox DIN W.-Nr. 1.4305 (pos. 3) with composite PA top (pos. 2). The pressure connections (pos. 4) are DIN W.-Nr. 1.4305, 7/16" UNF, and gaskets are FKM.

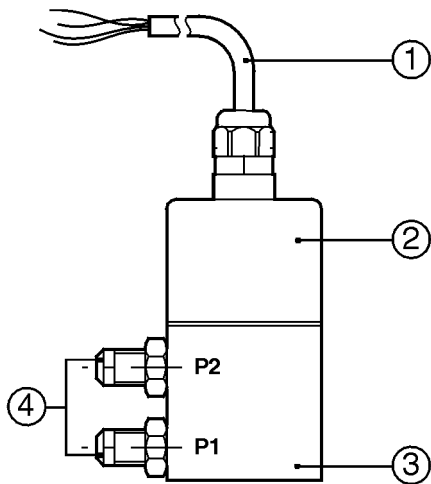

DPI position numbers

The sensor is supplied with angular bracket for mounting on motor or bracket for wall mounting. See the figure below with the wiring diagram.

Options with other cable lengths and various fitting connectors are available.

Dimensions

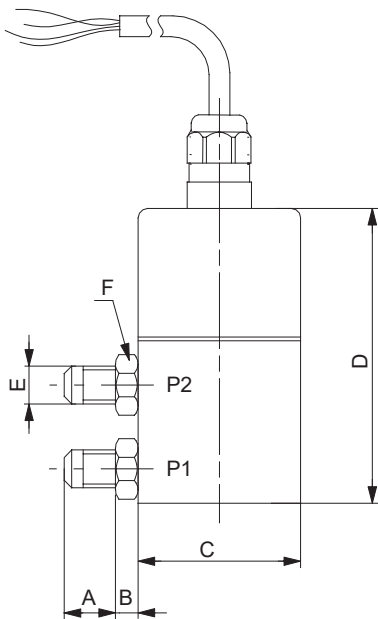

Dimensions, DPI

Pos.	Dimensions [mm]
A	14
B	6
C	45
D	77
E	7/16"-20 UNF
F	SW 14
P1	Pump 1
P2	Pump 2

Wiring diagram

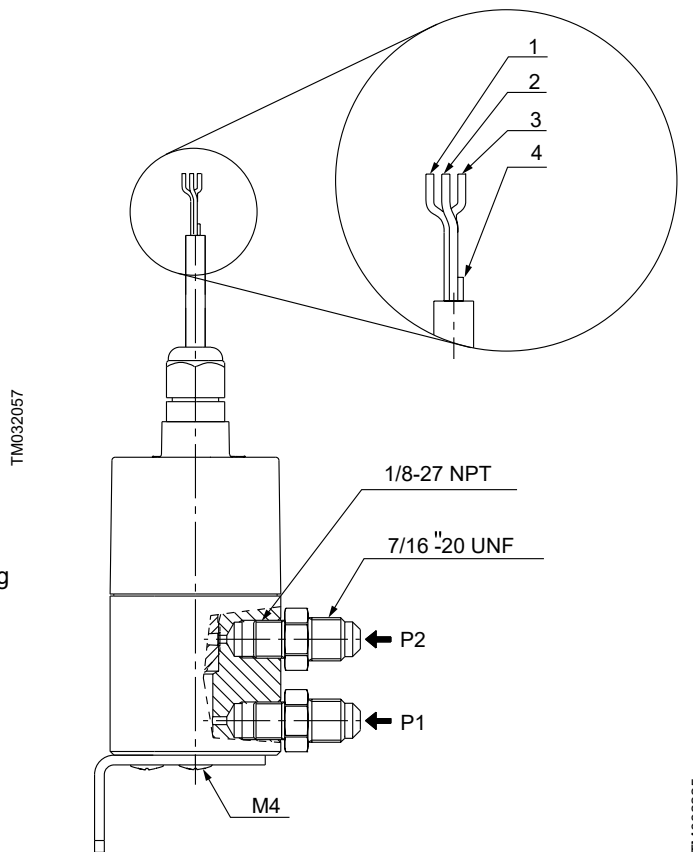

Wiring diagram, DPI

Pos.	Colour	Function
1	Brown	Supply voltage, 12-30 V
2	Yellow	GND
3	Green	Control signal
4	White	Test signal. Must not be connected to supply voltage (conductor may be cut off)

TM075436

TM032057

TM032225

Technical data

Supply voltage	12-30 VDC
Output signal	4-20 mA
Load [Ω]	24 V: max. 500 [Ω] 16 V: max. 200 [Ω] 12 V: max. 100 [Ω]
Max. system pressure, P1 and P2 simultaneously	16 bar
Rupture pressure [bar (psi)]	1.5 (21.7) x system pressure
Measuring accuracy	2.5 % BFSL
Response time	< 0.5 sec
Liquid temperature range	-10 to +70 °C (14-158 °F)
Storage temperature range	-40 to +80 °C (-40 to +176 °F)
Electrical connection	3-wire 0.13 mm ² (26 AWG) 0.9 m (2 ft) cable M12 x 1.5 in sensor top
Short-circuit proof	Yes
Protected against reverse polarity	Yes
Over supply voltage	Yes
Materials in contact with medium	DIN W.-Nr. 1.4305 FKM and PPS
Enclosure class	IP55
Weight	550 g (1.2 lb)
EMC (electromagnetic compatibility)	According to EN 61326-1
Emission/immunity	According to EN 61326-1
Connections	7/16"-UNF
Sealing material	FKM

12.3 Temperature sensor, TTA**Product description**

Temperature sensor with Pt100 resistance element mounted in a $\varnothing 6 \times 100$ mm (4 inches) measuring tube made of stainless steel, DIN W.-Nr. 1.4571, and a 4-20 mA sensor built into a type B head, DIN 43.729.

The connecting head is made of painted pressure die-cast aluminium with Pg 16 screwed connection, stainless screws and neoprene rubber gasket.

The sensor is built into the system by means of a cutting ring bush or by means of one of the two matching sensor pockets $\varnothing 9 \times 100$ mm (4 inches) or $\varnothing 9 \times 50$ mm (2 inches).

The sensor pocket is made of stainless steel SINOX SSH 2 for $\varnothing 6$ mm (0.2 inch) measuring tube and has a G 1/2" process connection.

The cutting ring bush for $\varnothing 6$ mm (0.2 inch) measuring tube has a G 1/2" process connection.

The cutting ring bush or the sensor pocket must be ordered separately.

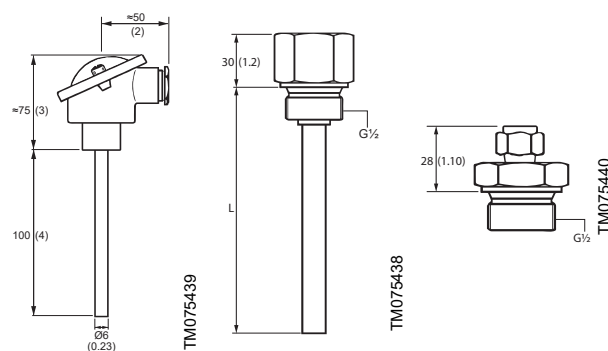
Dimensions

Sensor pocket

Type	L [mm (in)]	Cutting ring bush
$\varnothing 9 \times 50$	$\varnothing 9 \times 100$	
49 (2)	99 (4)	

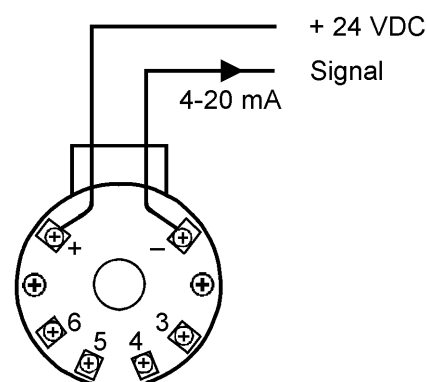
Dimensions, TTA**Wiring diagram**

Wiring diagram, TTA

Technical data

Type	TTA	
Measuring accuracy	According to IEC 751, class B, 0.3 °C at 0 °C (32.5 °F at 32 °F)	
Response time	Without sensor pocket:	28 seconds
	With oil-filled sensor pocket:	75 seconds
Enclosure class	IP55	
Output signal	4-20 mA	
Supply voltage	8.0 - 35.0 VDC	
EMC (electromagnetic compatibility)	Emission:	According to EN 61326
	Immunity:	According to EN 61326

All sensors have a 4-20 mA output.

13. Grundfos Product Center

Online search and sizing tool to help you make the right choice.

From the international view, you can select your specific country to view the product range available to you.

International view: <https://product-selection.grundfos.com>

All the information you need in one place

Performance curves, technical specifications, pictures, dimensional drawings, motor curves, wiring diagrams, spare parts, service kits, 3D drawings, documents, system parts. The Product Center displays any recent and saved items - including complete projects - right on the main page.

Downloads

On the product pages, you can download installation and operating instructions, data booklets, service instructions, etc., in PDF format.



When you select your country, you will see the menus below. Note that some menus may not be available depending on the country.

Example: <https://product-selection.grundfos.com/uk>

Pos. Description

- | Pos. | Description |
|------|---|
| 1 | Products & services enables you to find products and documents by typing a product number or name into the search field. |
| 2 | Applications enables you to choose an application to see how Grundfos can help you design and optimise your system. |
| 3 | Products A-Z enables you to look through a list of all the Grundfos products. |
| 4 | Categories enables you to look for a product category. |
| 5 | Liquids enables you to find pumps designed for aggressive, flammable or other special liquids. |
| 6 | Product replacement enables you to find a suitable replacement. |
| 7 | WWW enables you to select the country, which changes the language, the available product range and the structure of the website. |
| 8 | Sizing enables you to size a product based on your application and operating conditions. |

