

Delta 9
CANNABIS

**JOINT
ROLLING
MASTER
GUIDE**



“I used to smoke marijuana. But I’ll tell you something: I would only smoke it in the late evening. Oh, occasionally the early evening, but usually the late evening—or the mid-evening. Just the early evening, mid-evening and late evening. Occasionally, early afternoon, early mid-afternoon, or perhaps the late-mid-afternoon. Oh, sometimes the early-mid-late-early morning... But never at dusk.”

– Steve Martin

Contents



02

About Delta 9

03

Tools of the Trade

The Joints

08

Pinner

10

Blunt

12

Secret Agent

15

Cigar

18

Cross-Roads

21

Squid

23

Tulip

26

Diamond

29

Windmill

32

The Delta

ABOUT DELTA 9



Manitoba's Cannabis Company

From humble beginnings, Delta 9 was launched in 2013 by the father and son team of Bill and John Arbuthnot. All they had were a few types of cannabis seeds, a handful of cannabis clones, a small nursery, and a couple of grow rooms in a large, sparse warehouse at an industrial site in Winnipeg.

Since then, the company has developed an 80,000 square foot, state-of-the-art production facility, a network of retail cannabis stores in Manitoba and Alberta, a B2B division devoted to creating Micro-Cultivator partnerships, and now has more than 250 employees. Delta 9 Cannabis has matured into one of Western Canada's most established and successful cannabis brands.

The Quality You Expect, The Value You Deserve!

As one of the original Licensed Producers in Canada, Delta 9 has evolved its cannabis production over the past six years. Now growing in proprietary, turn-key, retrofitted shipping containers called Grow Pods, Delta 9 produces small-batch, hand-trimmed, craft-quality cannabis. And the variety of our cultivars is as unique as the Grow Pods themselves.

With approximately 20 different cannabis varieties in our current production cycle, and unique genetics for over 70 different cultivars, Delta 9 offers something for every cannabis enthusiast. From high potency THC cannabis to high-CBD, low-THC options, and everything in between, Delta 9 is quickly becoming the top choice for Canadian cannabis consumers looking for great value and uncompromising quality.

TOOLS OF THE TRADE

Creating a beautiful joint is an art, and any artist needs the right tools. Here's what you'll need to get rolling:

1. Papers

There are lots of different rolling papers to choose from. Check out page 4 for ideas.

2. Tips or Filter Paper

To roll some of these joints, you'll need stiff card paper or filter paper to create a holder. Filter paper can also be used to create a tip or mouthpiece for your joint. For a smooth smoke, grab a bag of pre-made filters.

3. Poker/Packer

You'll need this tool to create a tightly packed joint that burns evenly.

4. Grinder

We recommend an aluminum grinder. Flip to page 5 to find out why.

5. Rolling Tray

Trays come with nifty features to make the joint rolling process easier. They also reduce waste by collecting any loose herb.

6. Scissors, Knife and Needle

A small, sharp knife or pair of craft scissors will do the trick. You'll also need a sewing needle to roll the Cross-Roads.

7. DIY Rolling Glue

If you think cutting glue strips off rolling papers is wasteful, try this rolling glue recipe. Combine 1½ teaspoons of pectin with 1 ounce of water and apply it with a fine-tip artist's paint brush.

8. Lighter

9. Thread and Tape

Use basic sewing thread to hold the components of your joint in place as you work. A roll of scotch or masking tape will also come in handy.

With these essentials in your toolkit, you're well on your way to aficionado status.

Papers

Remember the old days when your friends sent you to the store for rolling papers and told you to come back with the blue ones? Those days are long gone. There's a whole new world of rolling papers out there now to take your cannabis enjoyment to a new level.

Tried and True

You can't go wrong with Delta 9's own 100 percent natural, unbleached *hemp rolling papers*. These faithful standbys will do the trick for most of the joints featured in this handbook.

The Cannasseur's Choice

RAW rolling papers are plant-based and contain no added chalk or dye. Delta 9 staff call RAW "the cannasseur's rolling paper," as people who love to roll joints inevitably love RAW papers.

Get Wired

Need a little help creating the perfect joint? *Randy's Wired Rolling Papers* give you a guide wire to work with, and when you get down to the roach, you can hold on to it with the wire.

Go Bananas

You can't get more natural than *Million Bananas Wraps*, which are created from real organic banana leaves. These wraps burn slow and steady with a delicious, unique taste.

Free of Everything

High Hemp Organic Wraps are certified organic, tobacco-free, GMO-free and gluten-free. They combine the smooth taste of hemp rolling papers with the slow, even burn of a tobacco wrap.

Smoking Gold

For those special occasions, why not smoke gold? *Shine 24k Gold Wraps* are handcrafted wraps made from the finest 24k edible gold and tobacco. Add a touch of luxury to your smoking experience.

Grinders

Grinders are a good investment. The quality and ease of use of these economical little workhorses makes the process of preparing your cannabis clean and simple. No more sticky fingers!

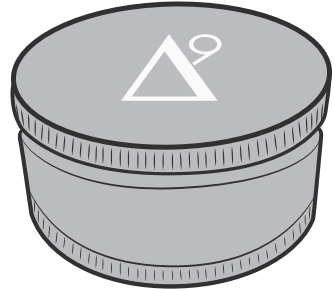

While you can break your cannabis apart with your hands and scissors at home, you can lose a lot of the trichomes that give your cannabis its unique characteristics. You also won't get the consistency of ground cannabis flower you would from a grinder. Having fine, easy-to-pack flower is key to rolling a smooth, evenly-packed joint.

When choosing a grinder, aim for medical- or aircraft-grade anodized aluminum. It's lightweight, easy to clean and won't chip or flake over time.

Many of our Delta 9 customers use three-chamber grinders to prepare their cannabis for use. When the buds are ground up, the cannabis is collected from on top of the screen in the second chamber, but there are thousands of trichomes that fall through the screen into the bottom chamber. The resulting extracted powder is known as kief, a powerful and almost pure collection of trichomes and an ingredient in the Cannabis Cigar (see page 15).

Getting the Job Done

You can't go wrong with a *Delta 9 Sharpstone 2.35" grinder*. These entry-level grinders have always exceeded buyer expectations, and they come in nine different colours so you can find your favourite.

Innovation and Quality

Delta 9 staff like the *LIFT Grinder* for its effortless operation that allows you to enjoy your ritual one turn at a time. The three piece variation is perfect for keeping the pollen in your herb or taking it on the go.

Storage

If you store your cannabis properly, it will maintain its fragrance, resin and cannabinoids. It will also burn nice and slow – just the way you like it. Follow these tips, and your cannabis could stay fresh, potent and aromatic for up to a year (and sometimes longer).

1. Store in airtight glass jars or specially designed cannabis storage units

Airtight glass jars are perfect for keeping your cannabis fresh. Glass won't affect the taste, and it will prevent the odour from drifting throughout your home. Dark or coloured glass is best because trichomes (the tiny crystals on the buds that contain cannabinoids and terpenes) degrade under bright light. Specially designed cannabis storage units are excellent alternatives and make it even easier to maintain ideal humidity levels.

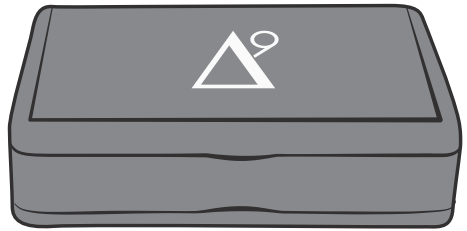

2. Do not use plastic for long-term storage

Plastic containers can expose your stash to degradation by light, air and temperature fluctuations. Avoid plastic baggies too. They can ruin the taste and won't protect your cannabis from getting crushed (and losing its potent trichomes).

3. Store in a cool dark place

Cannabis should be stored in a cool, dark place with a temperature ranging from 40-72° F (4.4-22° C). Think a cupboard, closet or drawer that is in an area with a stable temperature. Don't hide your stash in the fridge or freezer like your parents used to do. Freezing cannabis will make it brittle and trichomes will break off, reducing potency. Temperature and humidity can also fluctuate in your fridge, which can lead to the growth of mould and mildew.

4. Store at proper humidity

The ideal humidity range for storing cannabis is between 59-63%, which maintains freshness and resin integrity. Too much moisture can cause mould to form, and too little moisture can dry out the cannabis. *Humidity control packs* can regulate the moisture in your storage container. They'll either release or absorb moisture to maintain a relative humidity of 62%.

Don't use a tobacco humididor, as they are often made from cedarwood. The oil from the wood can absorb into cannabis, reducing and changing its flavour profile.

5. Store different strains separately

Each cannabis strain has its own set of characteristics and should be stored in its own container to maintain its uniqueness. Cannabis strains should not be mixed with each other.

6. Store buds intact without excess handling

Overhandling can cause the loss of trichomes and decrease the potency of your cannabis. Minimize handling to preserve trichomes, cannabis and terseness.

7. Do not store with accessories

The smell of burned cannabis from partially smoked joints, pipes and bongos will have a negative effect on the odours you enjoy from fresh cannabis.

8. Consider specially designed cannabis storage units

Delta 9 carries a number of specially designed cannabis storage units that can be used in conjunction with humidity control packs. If you're a cannasseur, a beautifully designed storage unit is definitely worth considering. Check out the *CVault with Boveda*, *STASHLOGIX Silverton*, *RYOT Glass Top Screen* and *Slim Shaker* boxes.

PINNER

When you only want to burn a small amount of weed, roll yourself a pinner or two. Style points for perfectly smooth, symmetrical cylinders.

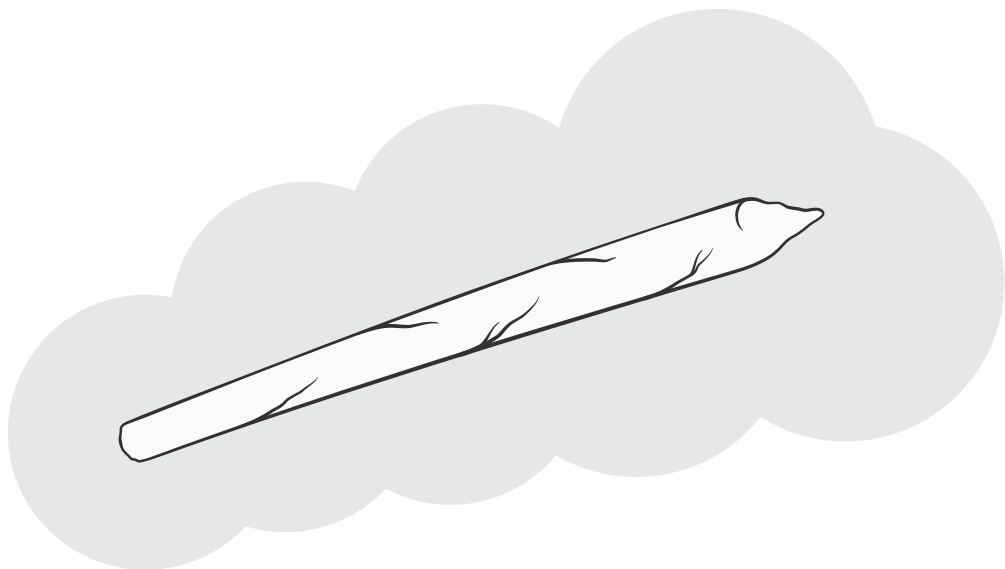

What's Needed

Filter or tip

Cannabis rolling paper

- 1 Stick two papers together vertically using a glue strip so they function as one long paper.

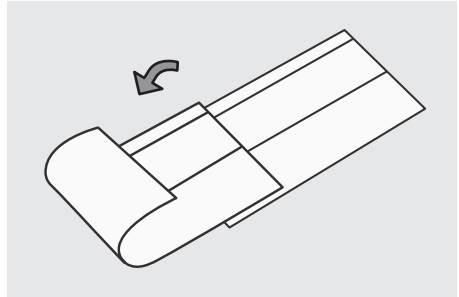

- 2 Place your filter and ground flower on the paper.

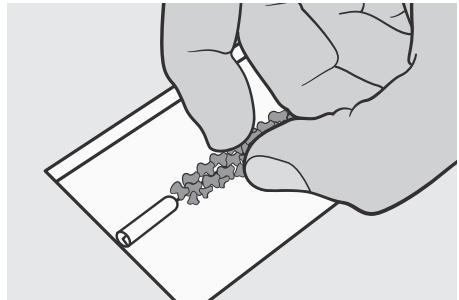

- 3 Roll the joint, seal the edge, and twist the end so you have something to light.

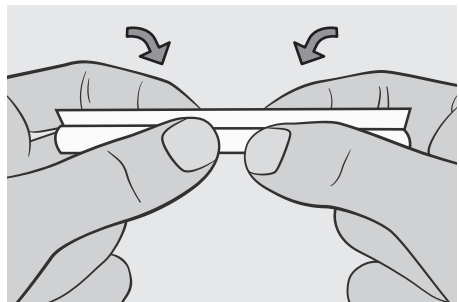

BLUNT

Roll your cannabis in tobacco paper for a long, slow burn.

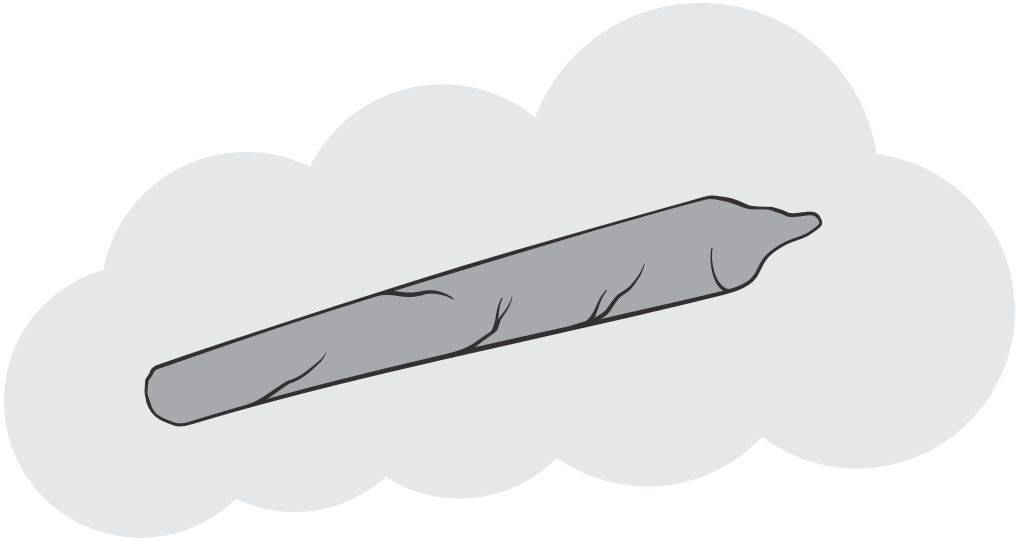

What's Needed



Filter or tip

Tobacco wrap

1

Lightly moisten the empty tobacco wrap to make it easier to work with.

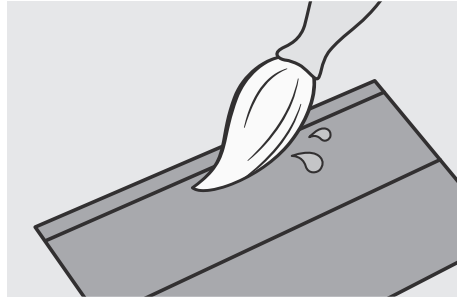

2

Place your filter and ground flower on the tobacco paper.

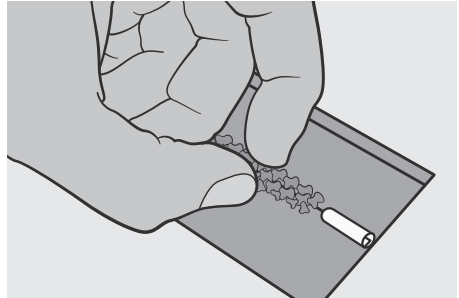

3

Once you've packed and shaped your blunt, tuck the wrap under itself and wet the inside of the exposed edge from end to end. Use your fingers to smooth out any wrinkles.

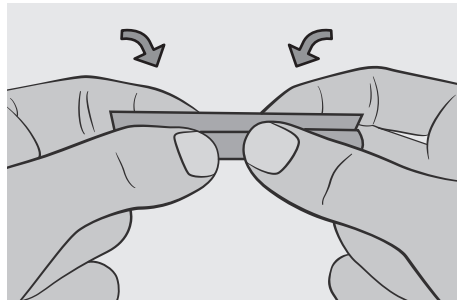

4

“Bake” your blunt by running a lighter lengthwise under the seam and around the outside. Then light and enjoy!

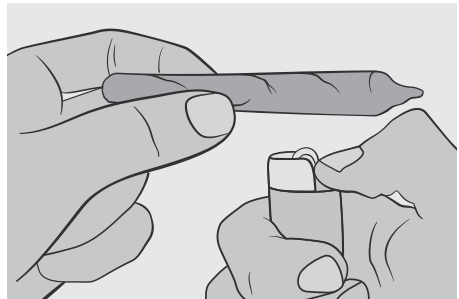

SECRET AGENT

If you're in the need for a clandestine toke, roll yourself a Secret Agent. This joint resembles a cigarette, though these days, you're more likely to get a glare for smoking a dart than you are for smoking a joint.

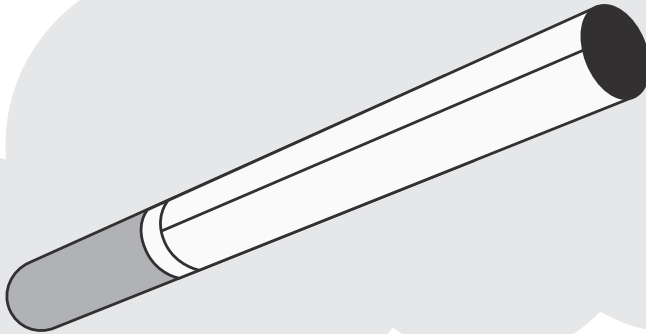

What's Needed

- Filter paper
- Cigarette with filter (tobacco removed)
- Glue strip
- Cannabis rolling papers

- 1 Stick two papers together to make a square with a glue strip along one side.

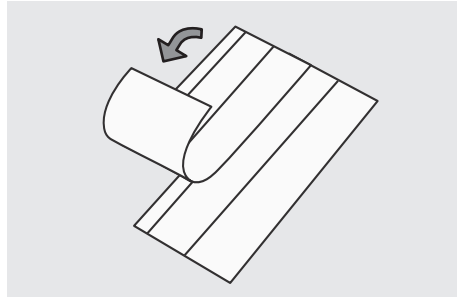

- 2 Take a cigarette and remove the filter by squeezing at its base and rotating between the finger and thumb. Eventually enough of the filter will show for you to pull it out.

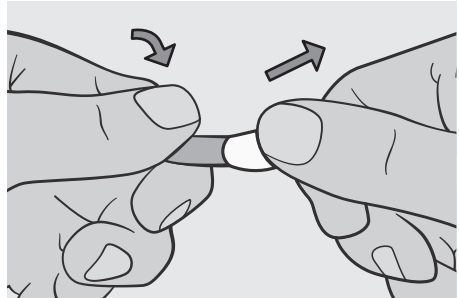

- 3 Replace the cigarette filter with a paper tip of the same size and shape.

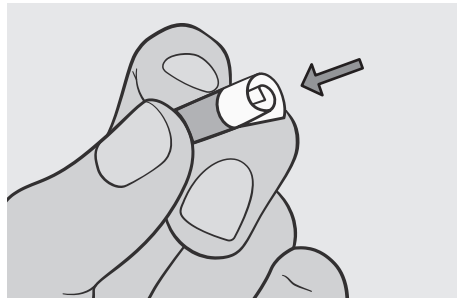

- 4 Cut the cigarette in two as cleanly as possible, about 1 cm from the paper tip.

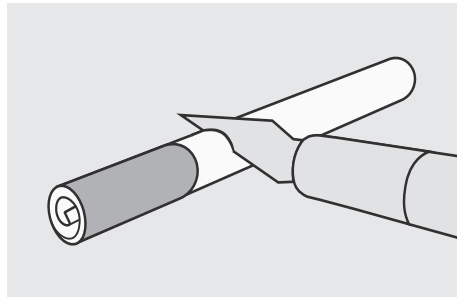

- 5 Make up enough mix to replace the tobacco that was cut away and add this to the papers.

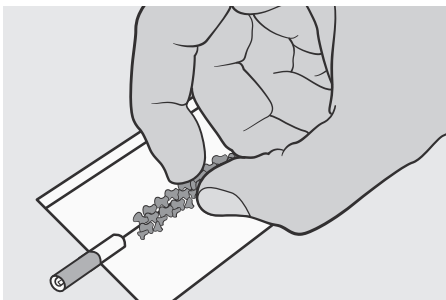

- 6 Roll the joint with the faux cigarette filter protruding from the end.

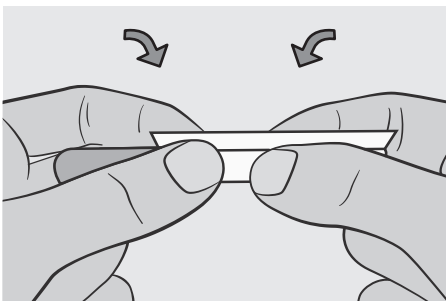

- 7 You may need to secure the bogus filter with a glue strip. Then light and enjoy!

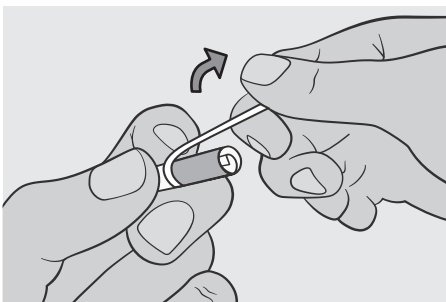

CIGAR

Looking for something more exotic than a joint? With a few hard-to-find ingredients and enough curing time, you can smoke a cannabis cigar like the rich and famous.

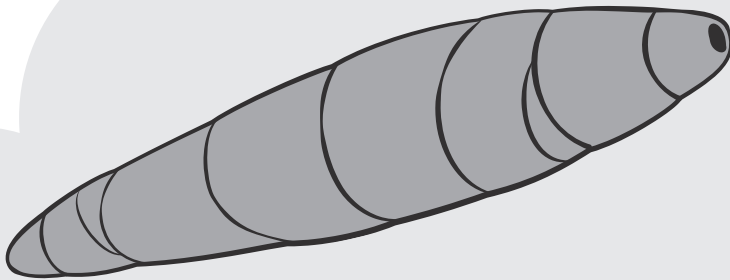

What's Needed

Bamboo stick
Uncured tobacco or
cannabis leaves
Resin

- 1** First, find or make yourself a Thai stick (bud densely tied around a bamboo stick and cured). To create one, coat a stick with cannabis resin oil and apply ground cannabis all around. Then, take a piece of string and tightly tie it around the cannabis, thereby keeping the cannabis compact. Cure for one week.

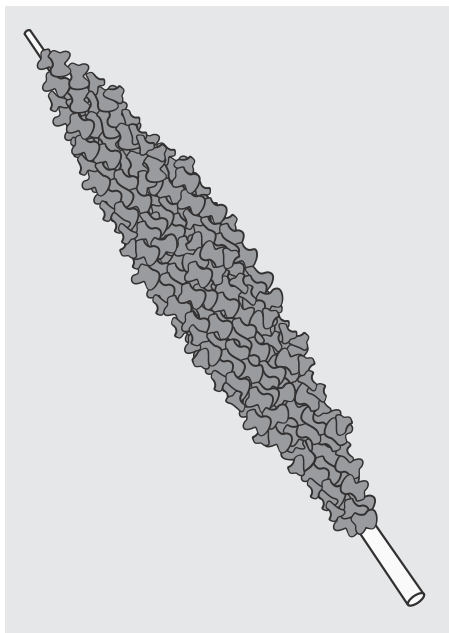

- 2** Wrap the coated stick with small uncured 'top' leaves, taking care to remove any stems.

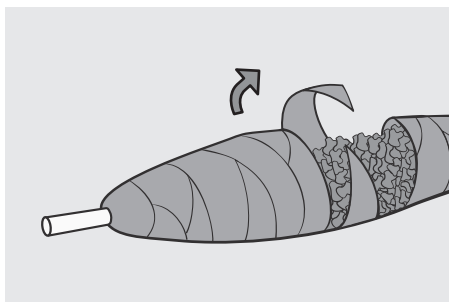

- 3** Secure the leaves with thread and coat with more liquid resin. Leave it to dry in a dark, dry, and warm place for a day or so.

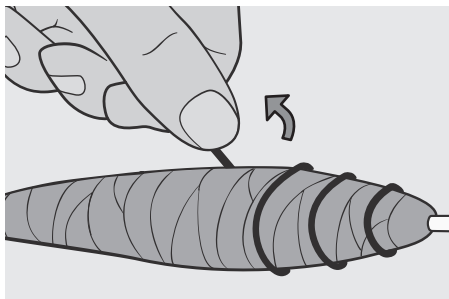

4

Remove the thread and repeat the entire process. Use progressively larger leaves and until the cigar is suitably fat.

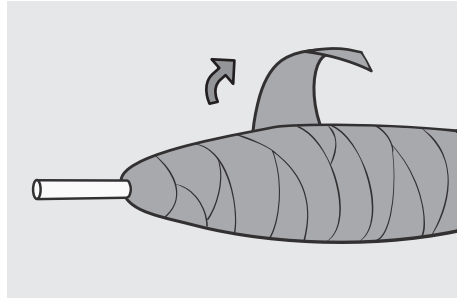

5

Use large leaves to seal the cigar, and secure with more thread.

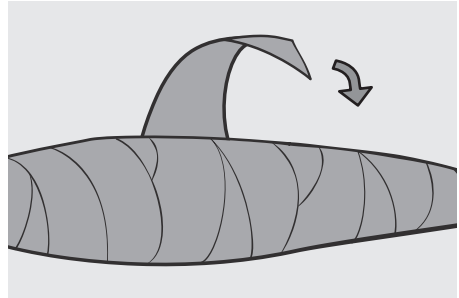

6

Leave the cigar to dry in a dark, dry, temperate place. In two to three weeks, it should be ready to smoke.

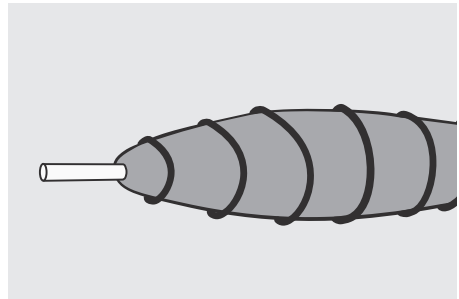

7

When drying is complete, remove the thread and carefully remove the bamboo stick from inside the cigar to create a smoking tube. Store your cigar in a dry, airtight container until you're ready to smoke it.

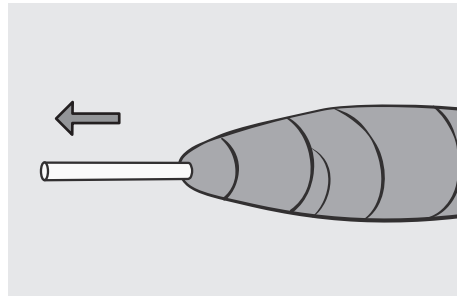

CROSS-ROADS

Three-way heaven for gourmands!
Two joints intersect to create the
trifecta of smoking experiences.

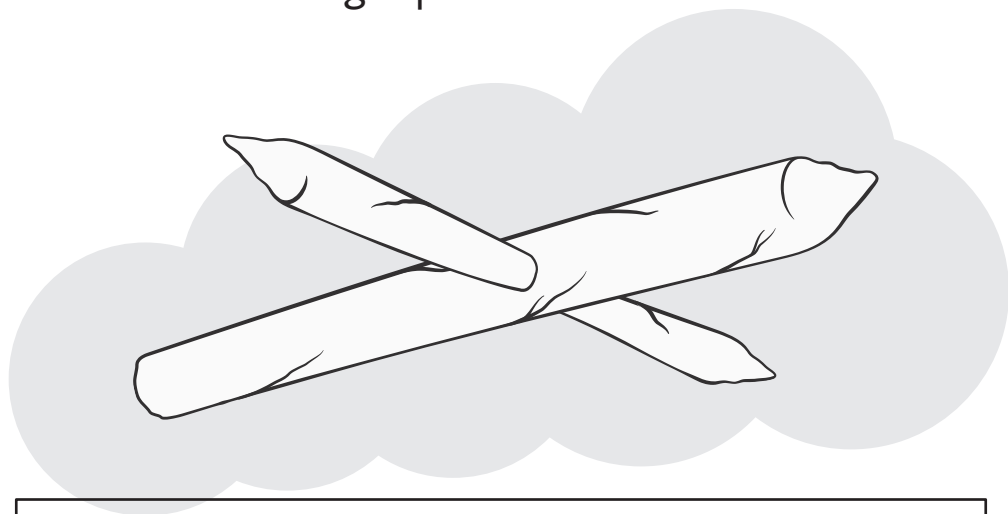

What's Needed

- Filter paper
- King-size and standard-size cannabis rolling papers
- Glue strips

- 1 Start by rolling two joints: one fat joint (about the diameter of a Sharpie) with a tip, and one thin joint (like a Pinner) without a tip.

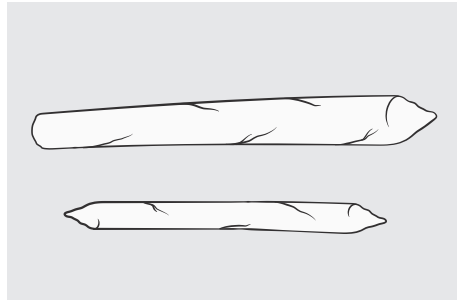

- 2 Use a sewing needle to poke a hole through the fat joint, about 3 cm from its end. Swirl the needle to gently widen the hole until it's nearly large enough to accommodate the thin joint.

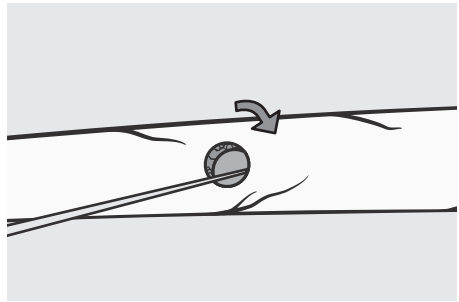

- 3 Carefully start to insert the thin joint through the hole in the fat joint.

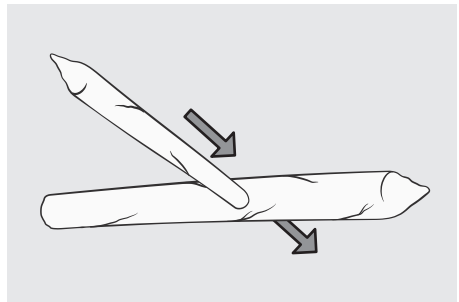

4

When your thin joint is about $\frac{1}{3}$ of the way through, use the sewing needle to poke a hole through it. Once the two joints are aligned, this second hole will allow you to draw air from the butt end of the fat joint. Keep the hole small (about twice the diameter of the needle). Then, finish inserting the thin joint into the thick joint.

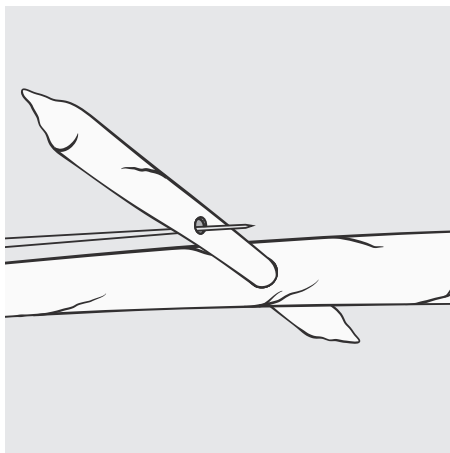

5

The two joints should fit snugly together. Seal the intersection with glue strips. To use the Cross-Roads, light the ends and enjoy a three-way smoke.

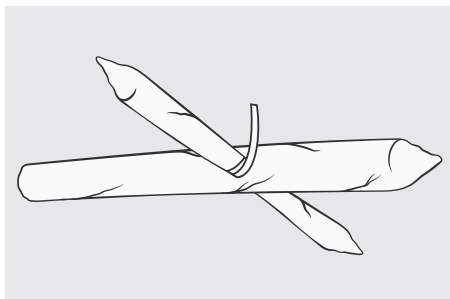

SQUID

Put your braiding skills to work and roll yourself a Squid for ceremonial occasions. L'Chaim!

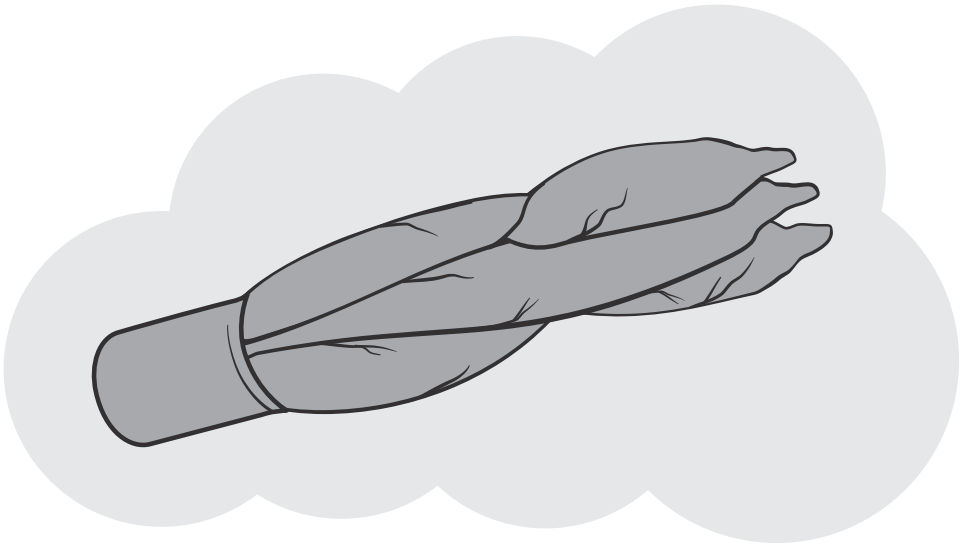

What's Needed

Filter paper
King-size cannabis rolling papers
Glue strips

- 1 Roll three joints. Use filter paper or rolling papers to create a filter long enough to wrap around all three joints.

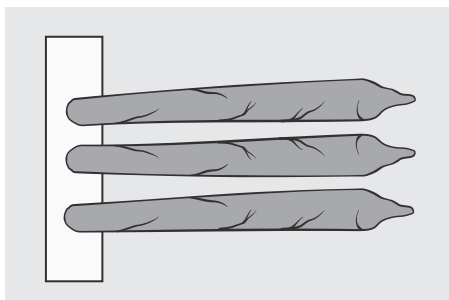

- 2 Wrap the filter around all three joints, and use the glue strips to hold it together.

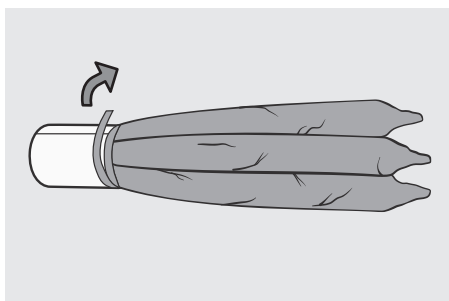

- 3 Gently braid the joints around each other, pinching them together with your fingers.

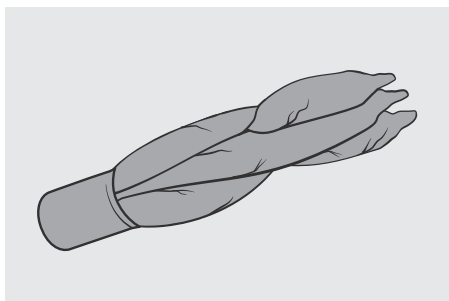

- 4 Wrap one glue strip around the ends of all three joints to hold them together. You can also wrap a glue strip around the middle of the braid to hold the joints together as they burn.

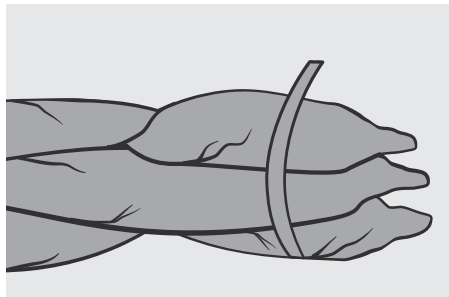

TULIP

An Amsterdam specialty, the Tulip is often found in the hands of unconscious tourists. A good tulip is deceptively smooth to smoke and easier to roll than it looks.

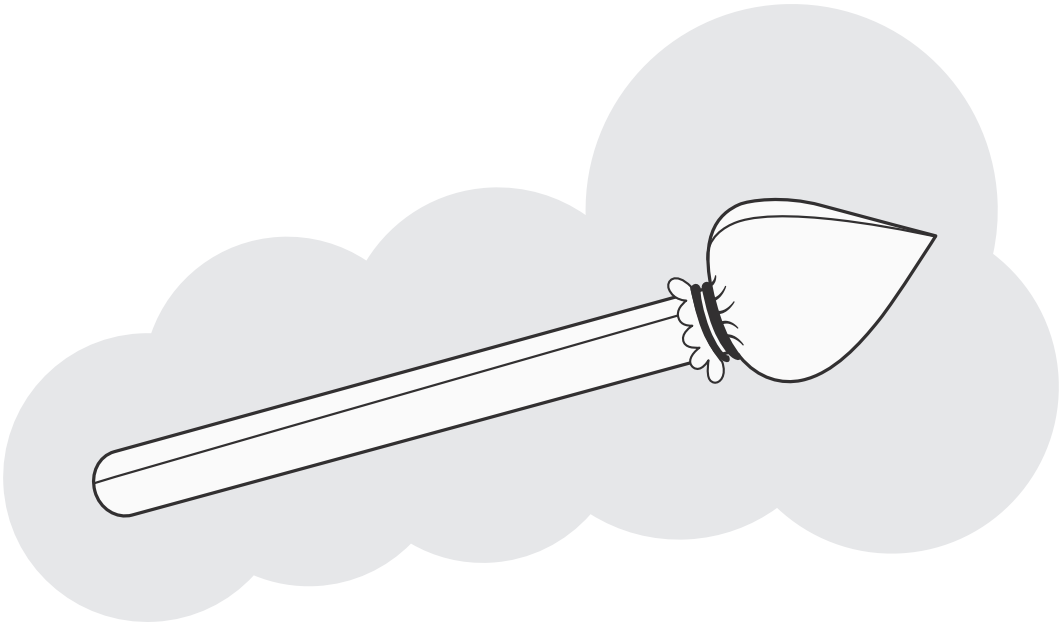

What's Needed

Filter paper
King-size cannabis
rolling papers

- 1 Make a holder by rolling filter paper to create a tube that is the length and diameter of a thick pencil. Seal it with glue strips or tape.

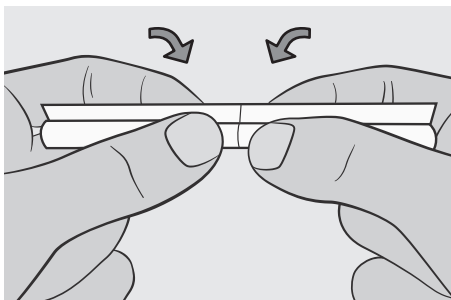

- 2 Take two more large papers and stick them together to form a square with a glue strip running along one side.

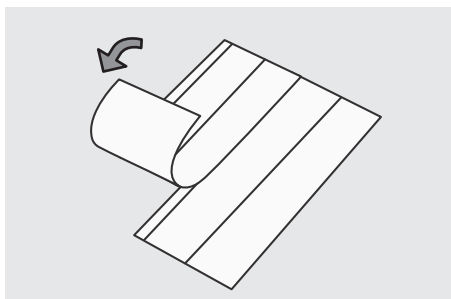

- 3 Fold corner A over to corner B to form a triangle, leave the glue strip uncovered.

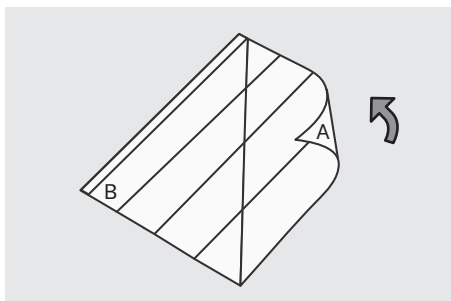

- 4 Wet the strip and fold it over to seal the triangle. You should have something resembling a flattened a paper cone.

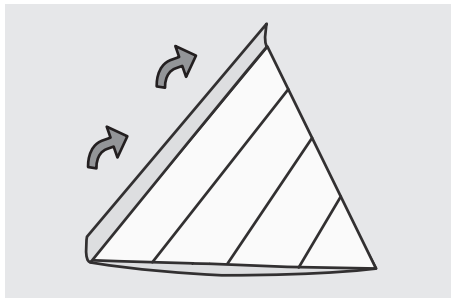

- 5** Open up the cone and tightly pack it with mix.



- 6** Crimp together the paper at the open end of the cone, and then place the filter paper holder in the centre of the cone.

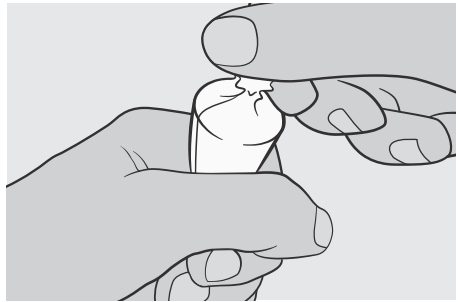

- 7** Secure the holder by wrapping a thread around the crimped-paper end of the cone and tying it as tight as possible. Then light and enjoy!

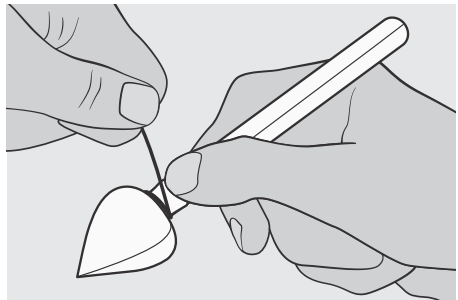

DIAMOND

Once mastered, the joining technique opens up a realm of possibilities for weird and fantastic creations. The Diamond is a good place to start and smokes surprisingly well.

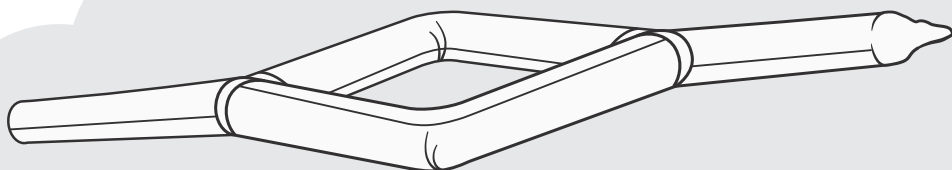

What's Needed

Filter paper
King-size cannabis
rolling papers
Glue strips

- 1 Roll a thick, straight, sturdy joint with a filter or tip, and cut it in two.

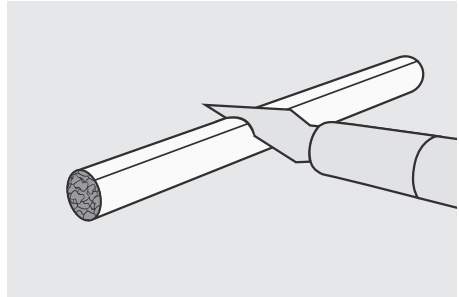

- 2 Roll two joints without tips, and make them slightly thinner than the first. Use a little less mix in the centres so they're easier to bend.

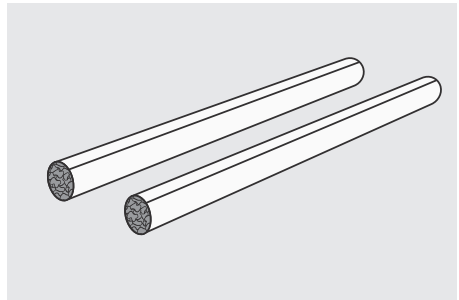

- 3 Trim away excess paper to leave a flat edge that is flush with the mix.

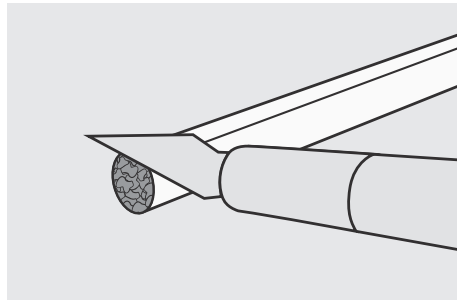

- 4 Join the two identical joints to the segment of the first joint containing the filter or tip. Bandage it up using some of the glue strips – it should be stiff and secure.

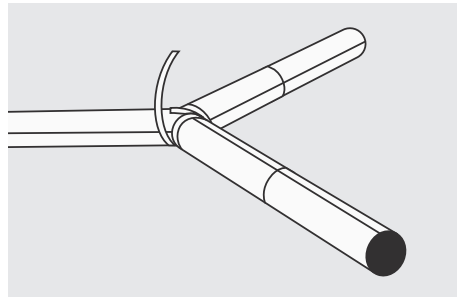

5

Bend the two smaller joints at the centre until they meet to form a diamond shape.

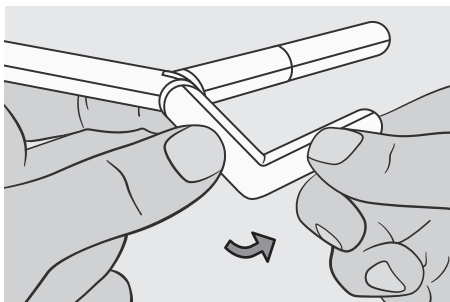

6

Bandage the remaining segment of the thicker joint to the end of the diamond using the glue strips like before. Then light and enjoy!

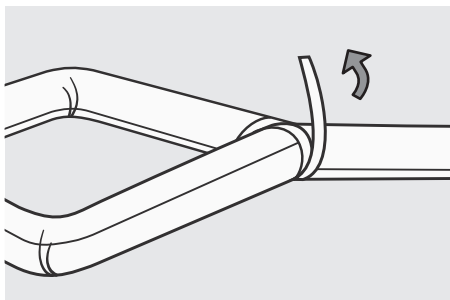

WINDMILL

With a smoke-cooling chamber and multiple joint holder, the windmill is designed to get you spinning. Although difficult to make, the holder looks good and can be used again and again.

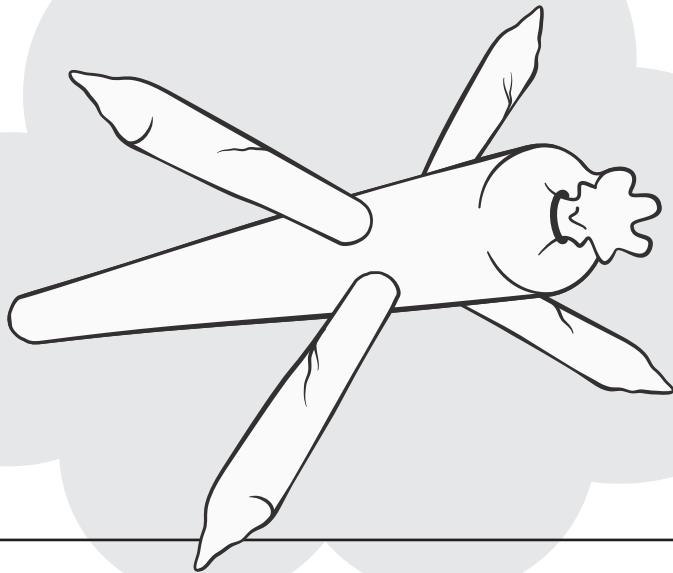

What's Needed

10 x 10 cm piece
of cardboard

Filter paper

King-size cannabis
rolling papers

- 1** Roll a cone from a 10 x 10 cm piece of cardboard. Secure it with tape and trim the end to form a perfect cone.

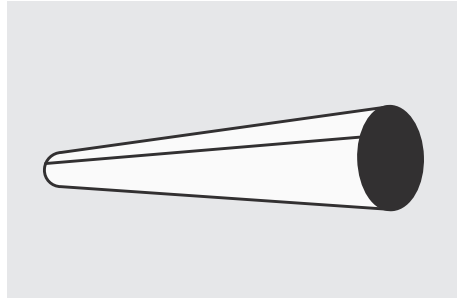

- 2** Seal the cone with large papers. Leave 3 cm of excess paper on the end.

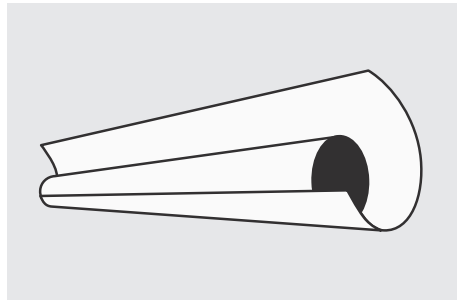

- 3** Make four crosscuts around the end of the cone.

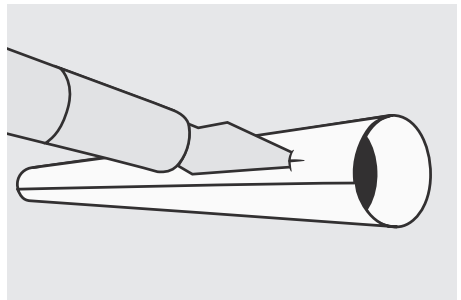

- 4 Pinch together the excess paper at the end of the Windmill and seal it with thread or tape.

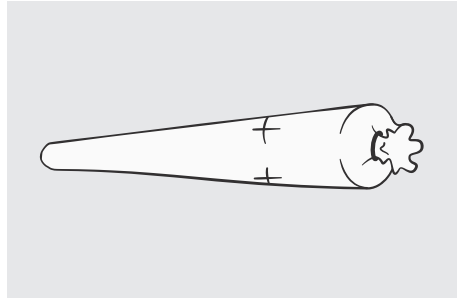

- 5 Roll four joints with tips and insert them into the crosscuts. Enjoy a four-way smoke of quixotic proportions. Don't burn the cone holder – you'll want to use it again.

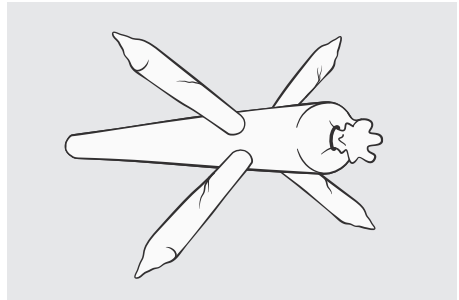

THE DELTA

Welcome to Level 10. We've reserved the best for last so you can roll with the Aficionados of joint cannasseurs. Enjoy!

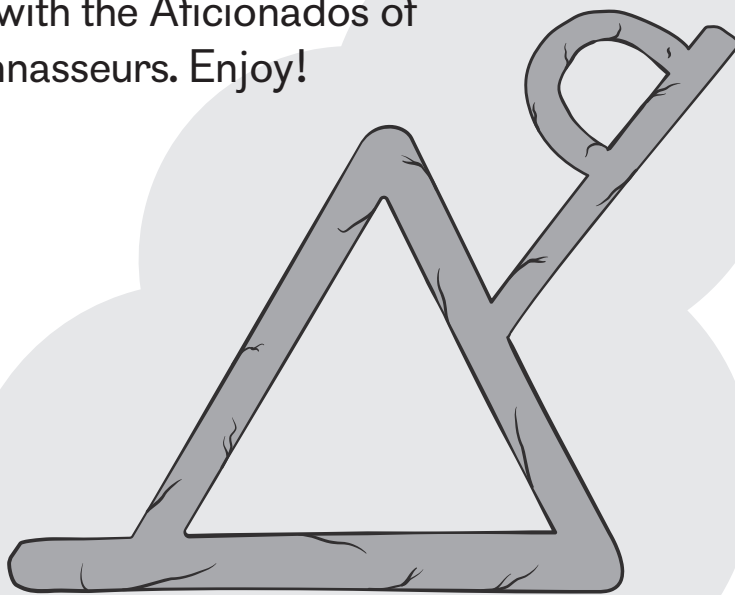

What's Needed

High-quality cannabis rolling papers

Glue strips, or DIY Rolling
Glue and rolling papers

Filter paper

- 1 Roll three joints to form the Delta 9 triangle and two smaller ones to form the Delta 9.

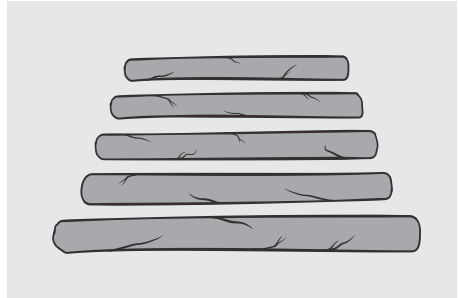

- 2 Carefully bend the smallest joint to help shape the nine.

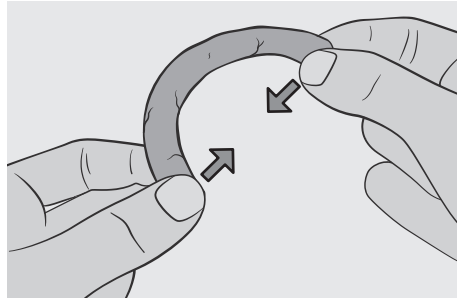

- 3 Cut the connecting points on all 6 locations shown so that the points are flush.

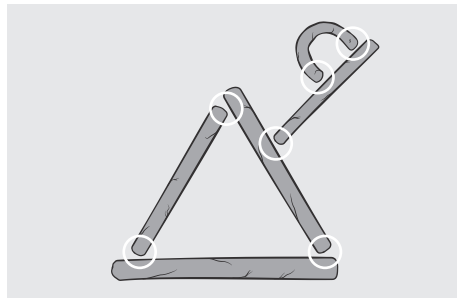

- 4 Cut 13 strips off your papers for patching strips, or you can use DIY Rolling Glue to help bond larger strips of paper.

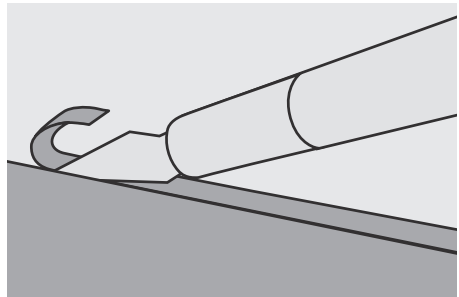

- 5 Connect all the pieces together with additional strips of glue. It is very important to make sure there are no air leaks, which will affect The Delta's smokability.

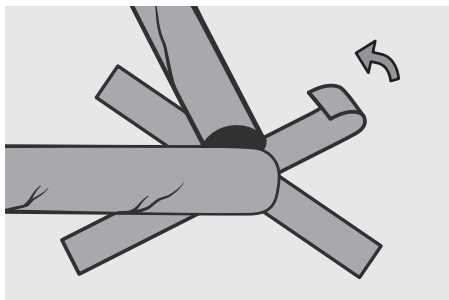

- 6 Attach a tip to the bottom left corner using the cut-up glue paper.

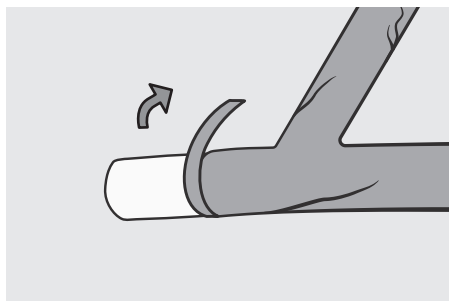



You wouldn't walk into a bar for the first drink of your life and order five tequila shots, would you? Not likely. You'd be on the floor in no time. The same goes for cannabis. You have to "Start Low and Go Slow," especially if it's your first time.

While the effects of cannabis can be quite different than those experienced with alcohol, overconsumption can still make you feel uncomfortable. You want your first cannabis experience to be an enjoyable one, and there's an excellent chance it will be!

The best advice is to try a small amount and wait to see how you feel. Learn more about consuming cannabis and setting limits at [KnowMyLimits.ca](https://www.knowmylimits.ca).

Delta 9 Store Locations

Get everything you need to roll these 10 joints at one of our store locations, or shop online and check store inventory anytime at Delta9.ca

Brandon

1570 18th Street
Brandon, Manitoba R7A 5C5
Sunday-Thursday: 10AM-10PM
Friday-Saturday: 10AM-11PM
delta9.ca/brandon
204-717-0784

Winnipeg (St. Vital)

Unit 1-827 Dakota Street
Winnipeg, Manitoba R2M 5M2
Sunday-Thursday: 10AM-10PM
Friday-Saturday: 10AM-11PM
delta9.ca/stvital
204-224-7390

Winnipeg (Osborne Village)

478 River Avenue
Winnipeg, Manitoba R3L 0B3
Sunday-Thursday: 10AM-10PM
Friday-Saturday: 10AM-11PM
delta9.ca/osborne
204-224-7391

Thompson

City Centre Mall
300 Mystery Lake Road
Thompson, Manitoba R8N 0M2
Everyday: 10AM-10PM
delta9.ca/thompson
204-677-5127

Coming Soon

Winnipeg (South)

Unit 2-1589 Kenaston Blvd.
Winnipeg, Manitoba R3P 2M4
204-224-7394

Calgary

Unit 210-777 8th Ave.
Calgary, Alberta T2P 3R5

Grande Prairie

Unit 106-10126 120th Ave.
Grande Prairie, Alberta T8V 8H9