



Skyra

Clear Ice Maker



INSTRUCTION MANUAL

Introduction

Thank you for choosing our Skyra clear ice maker! This brand-new product is designed to bulk produce clear ice in standard shapes, perfect for bars, hotels and other businesses serving cold drinks. Compared with regular non-clear ice makers and traditional clear ice-producing processes, the Skyra ice maker has the following advantages:

- Produce clear ice that is denser and melts more slowly than cloudy ice.
- Directly form clear ice in standard shapes without cutting.
- One-button automatic production of clear ice for simple operation.
- Solve long-term needs for clear ice and reduce cost.

Our clear ice maker is built with a stylish look and stunning performance, having passed rigorous safety and performance testing. Please feel free to use it and enjoy your clear ice!

Contents

Important Safety Instructions	3
Product Structure	8
Specifications	10
Product Features.....	11
Operation Instructions	13
Before using.....	13
How to make clear ice.....	15
How to use Freeze mode.....	20
Care and Maintenance.....	22
Troubleshooting.....	23

Important Safety Instructions

- Only the power supply specified on the machine nameplate can be used with this machine.
- Outlet for this machine must meet the national laws and regulations and must be reliably grounded with leakage protection.
- Wear gloves when performing maintenance on the motor and the cooling system inside the machine.
- Do not insert a screwdriver or other device into the protective grilles, where there are heat exchange vents, evaporators, etc.
- Do not touch live parts with wet hands or bare feet.
- Do not block the heat exchange vents of the compressor or evaporator to ensure the normal operation of the machine.
- When opening or closing the lid, always hold the lid to avoid getting your hands caught.
- Do not place non-food items in the machine except the accessories that come with the machine.
- Only trained operators are allowed to use this machine.
- The installation, repair or maintenance of this machine must be carried out by professional and qualified personnel.
- The machine is not intended for use by children, persons with reduced physical, sensory or mental capabilities or lack of experience and knowledge.
- The machine should be properly managed to ensure that children will not play with or around it.
- If the power supply device of the machine fails, contact professional personnel certified by the manufacturer to replace it to avoid safety accidents.
- It is prohibited to modify or remove the provided safety devices (protective

grilles, hazard labels, etc.) and the manufacturer is not responsible for the consequences of violating this instruction.

- In the event of a fire, use a carbon dioxide fire extinguisher instead of water, and cool the motor room as soon as possible.
- Do not use mechanical devices or other means to accelerate the defrosting process, other than those recommended by the manufacturer.
- Do not damage the refrigerant circuit.
- Do not use other electrical appliances in the machine, unless they are recommended by the manufacturer.
- Refrigerants and blowing agents are flammable and should only be disposed of by qualified personnel and institutions.
- If the power cord is damaged, it must be replaced by the manufacturer, service agent, or qualified personnel.
- Do not store explosive substances such as aerosol cans with a flammable propellant in this machine.
- Keep clear of obstructions to all ventilation openings of the machine.
- Before performing any operation, unplug the power cord and ensure that the operator can check from any direction that the power cord is disconnected.
- The A-weighted emission sound pressure level is below 70 dB(A).
- The climatic class numbers marked on the machine nameplate indicate:
 - Maximum ambient temperature for appliances with climatic class 0, 1, 2, 3, 4, 6, or 8 in the test room: $89.6^{\circ}\text{F} \pm 0.6^{\circ}\text{F}$.
 - Maximum ambient temperature for appliances with climatic class 5 or 7 in the test room: $109.4^{\circ}\text{F} \pm 0.6^{\circ}\text{F}$.



Warning: risk of fire / flammable materials

Package and Transportation

- Packed in wood crates, the machine should be transported with appropriate equipment, do not move it with bare hands.
- When using a lifting system, such as forklifts or pallets, pay special attention to balance and prevent tipping.
- Normally, the machine should be fixed on wooden pallets to ensure safety during transportation and storage.
- Warning signs should be printed on the package to remind users to follow the instructions and ensure the machine will not be damaged during loading, unloading, and transportation.



Fragile



Upward



Do not flip



Keep dry

Stacking limit

- When storing or moving the machine, the maximum stack is two units, unless otherwise specified on the label.
- Since the center of gravity of the machine does not coincide with the geometric center, be careful not to tilt the machine during handling.

Unpacking

- Please use tools for unpacking the wood crate. After the unpacking, if any damage is found, please inform the carrier immediately.

Installation

- Install and place the machine securely on a stable and level surface.

- When handling, do not push or pull the machine to avoid tipping over or damaging the parts.
- Do not place any objects on the machine, as it is open from the top.
- The machine should be placed in a well-ventilated place, and away from heat and ignition sources.
- The minimum clearance $\geq 100\text{mm}/3.9''$ should be kept between the surrounding of the machine and the wall or objects to ensure good operation performance, ventilation and maintainability.
- Before connecting to the power supply, make sure that the voltage and frequency are consistent with the machine nameplate. A variation of +/-10% of the normal voltage is allowed, and the machine should be connected to an effective ground connection.

Storage

- Turn off the power and unplug the machine
- Empty the compartment and clean it
- Keep the lid slightly open to ensure ventilation and avoid mildew or odors

Disposal

- Temporary storage of special wastes may be permitted before disposal or final disposal.
- In all cases, the applicable environmental laws of the user's country must be complied with.

	Correct disposal of this product
--	----------------------------------



This marking indicates that this product should not be disposed of with other household wastes throughout the EU. To prevent possible harm to the environment or human health from uncontrolled waste disposal, recycle it responsibly to promote the sustainable reuse of material resources. To return your used device, please use the return and collection systems or contact the retailer where the product was purchased. They can take this product for environmentally safe recycling.

Product Structure

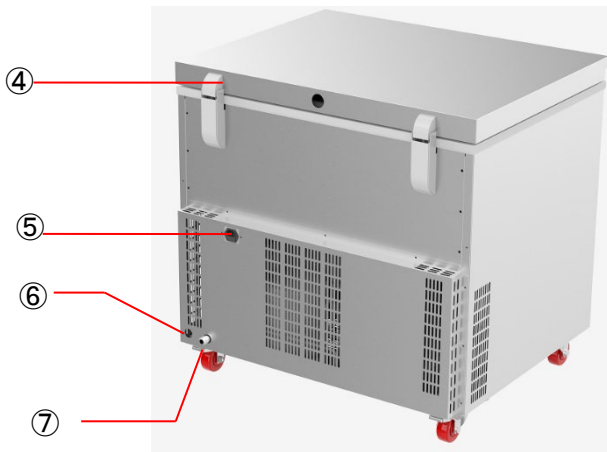
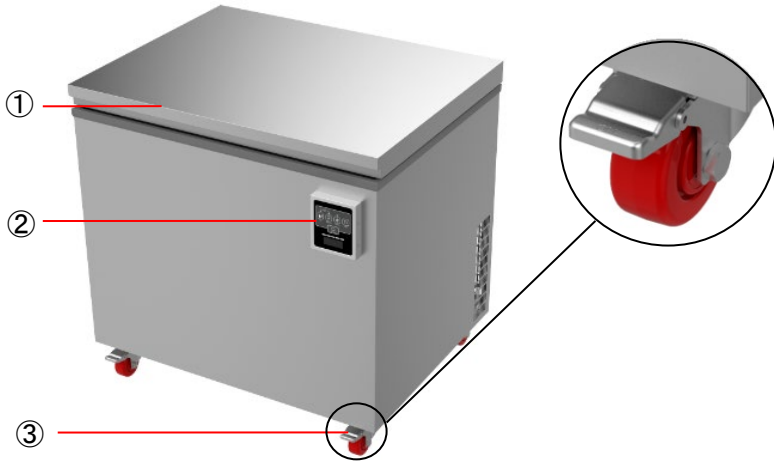

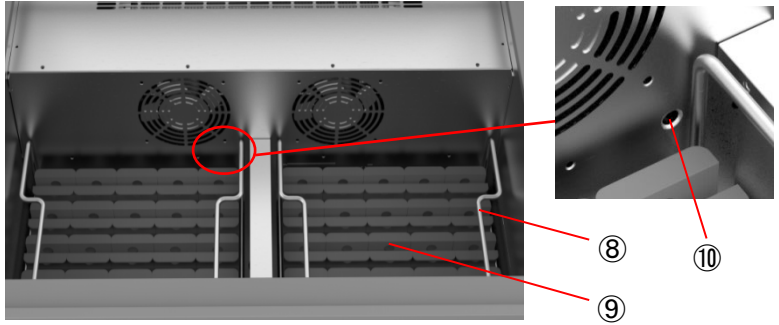

⑦+⑧:

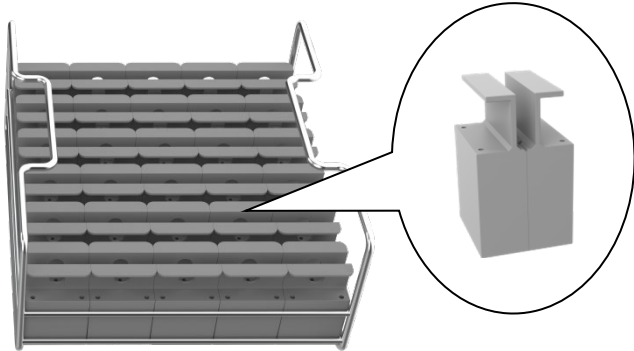

- ①Lid ②Control panel ③Universal wheels ④Hinge ⑤Power port
 ⑥Drain pipe ⑦Inlet pipe ⑧Ice mold tray ⑨Ice mold ⑩Overflow hole

Specifications

Model	Skyra (Double tray)	
Power supply	220-240V~50Hz	110-120V~60Hz
Ice-making power	480 W	500 W
Ice-detaching power	2700 W	2800 W
Exterior material	Stainless steel SUS201 with brushed finishes	
Interior material	Stainless steel SUS304	
Exterior dimensions	34.3" × 29.7" × 33.7" (870 × 755 × 856 mm)	
Interior dimensions	29.5" × 15.0" × 17.8" (750 × 382 × 452 mm)	
Ice-making time	24~28 h (Ambient temperature, water temperature ≤ 77°F)	
Tray number	2	
Tray material	Stainless steel SUS304	
Ice mold material	Food-grade silicone	
Ice-making capacity (Ice molds are customizable)	2 trays of ice cubes: 30+30	
	2 trays of ice spheres: 16+16	
	2 trays of ice bars: 24+24	
	2 trays of ice diamonds: 30+30	
Ice size	Ice cube: 2.2 x 2.2 x 2.2 in (55 × 55 × 55 mm)	
	Ice sphere: Φ 3 in (Φ 75 mm)	
	Ice bar: 1.5 x 1.5 x 4 in (38 × 38 × 102 mm)	
	Ice diamond: Φ 2.4 x 2.2 in (Φ 60 × 55 mm)	
Weight	242.5 lb / 110 kg (cube molds included)	
	253.5 lb / 115 kg (sphere molds included)	
	246.9 lb / 112 kg (bar molds included)	
	257.9 lb / 117 kg (diamond mold included)	
Temperature display unit	°F / °C	
Ice storage mode temperature	30.2°F (-1°C)	
Freeze mode temperature	5°F (-15°C)	
Working conditions	Temp: 41-90°F (5-32°C), humidity: ≤85%	

Product Features

Control panel:

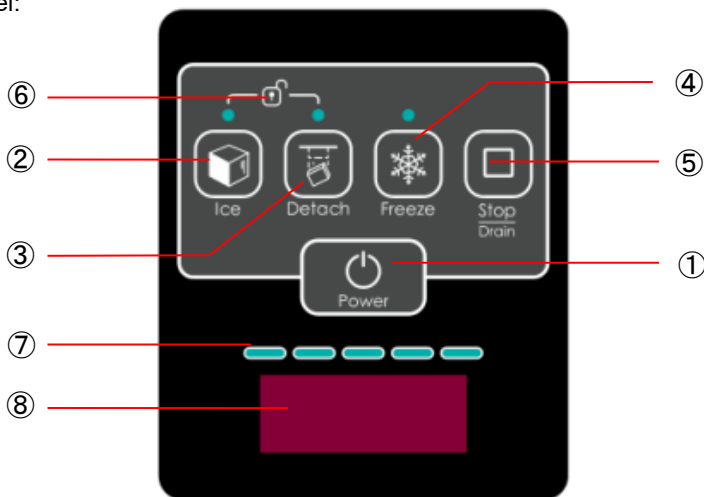

No.	Part	Description
1	Power	<p>--- Connect to the power supply, and the display will show "OFF". Press the "Power" button, and the machine will enter standby mode, showing "ON".</p> <p>--- In standby mode or during operation, pressing the power button can return to power saving mode.</p>
2	Ice	<p>--- In standby mode, press the "Ice" button, and the indicator will light up, and the ice-making process will start:</p> <ol style="list-style-type: none"> 1) Water filling: display shows ICE1, and the first indicator light of the progress bar flashes; 2) Water heating: display shows ICE2, and the second indicator light of the progress bar flashes; 3) Ice making: display shows ICE3 and ice-making time alternately, and the third indicator light of the progress bar flashes; 4) Ice making: display shows ICE4, and the indicator of "Detach" lights up and the fourth indicator light of the progress bar flashes; 5) Completion: display shows the compartment temperature, and the progress bar fully lights up.

		<p>--- In standby mode, long press the "Ice" button for about 3 seconds until the indicator lights up, the water filling process will be skipped. If the initial water temperature is above 20°C, the water heating process will be skipped, and directly enter ice making process.</p>
3	Detach	<p>--- During ice-making and in the unlocked state, pressing "Detach" button can enter ice-detaching mode in advance.</p> <p>--- In ice-storage status, press "Detach", the machine will enter ice-detaching mode, and the indicator will turn on. When the ice-detaching is completed, the indicator will turn off and the display will show the temperature in the compartment.</p>
4	Freeze	<p>--- In standby mode, press the "Freeze" button, the indicator will turn on and the machine will enter freeze mode, with the display showing the compartment temperature.</p> <p>--- In standby mode, long press the button for about 3 seconds, then all lights of the progress bar will light up, and can re-enter ice storage status, in which the display will show the compartment temperature.</p>
5	Stop/Drain	<p>--- During all working processes, pressing "Stop/Drain" will stop the task.</p> <p>--- In standby mode, press and hold the "Stop/Drain" button for about 3 seconds to start the drainage process. The digital display will show "dr." Once the water has been completely drained, press the "Stop/Drain" button again to stop the drainage.</p>
6	Lock	<p>After entering the Ice making process, the operation interface will be locked. If you need to perform other operations (such as ice-detaching or stopping the machine), you need to long press the "Ice" and "Detach" buttons for a few seconds to unlock. After unlocking, the machine will beep and the display will show "Unlo".</p>
7	Ice-making progress bar	<p>Shows the ice-making progress. After ice-detaching, the whole progress bar will light up.</p>
8	Display	<p>Shows ice-making stages, ice-making time, and compartment temperatures.</p>

Operation Instructions

Before using

1. Place the machine on a flat and stable surface, and allow a distance of $\geq 100\text{mm}/3.9''$ between the machine and the walls or objects to ensure good ventilation.

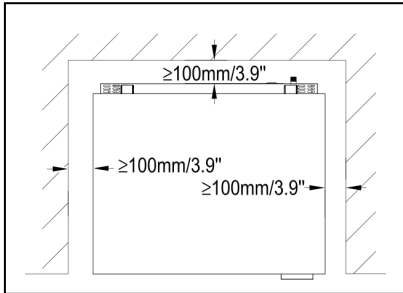

2. Connect the inlet pipe of the machine to the water supply and the drain pipe to the drainage system. (To clean the machine and drain the water, press and hold the "Stop" button for about 3 seconds, and make sure that the machine inlet pipe is connected to the tap and the tap is on).

Note:

- ① The water pressure must be between 0.02 MPa (0.2 bar) and 0.8 MPa (8 bar). If the water pressure exceeds 0.78MPa(8bar), an appropriate pressure relief valve should be used. After connecting the water supply, keep the tap on.
- ② It is not recommended to use distilled water as the water source because it can affect the transparency of the ice. It is recommended to use mineral water or filtered tap water.

3. Identify the water inlet pipe

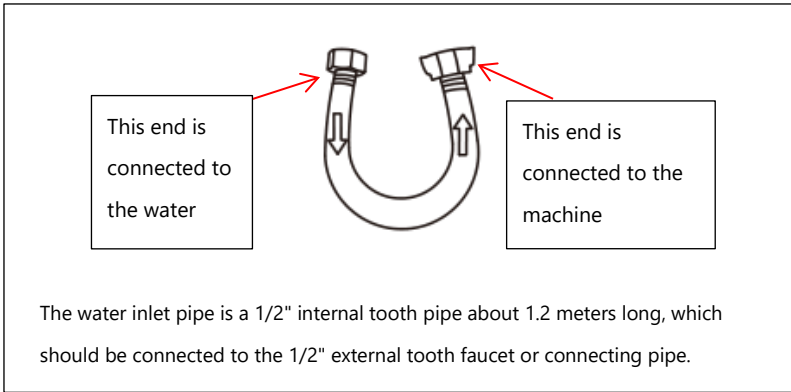

4. Install the inlet pipe

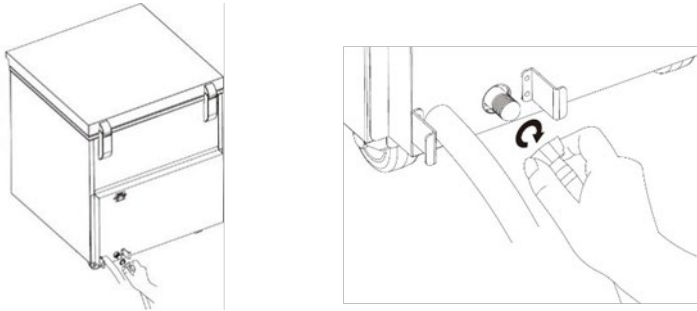

5. Schematic diagram after installation

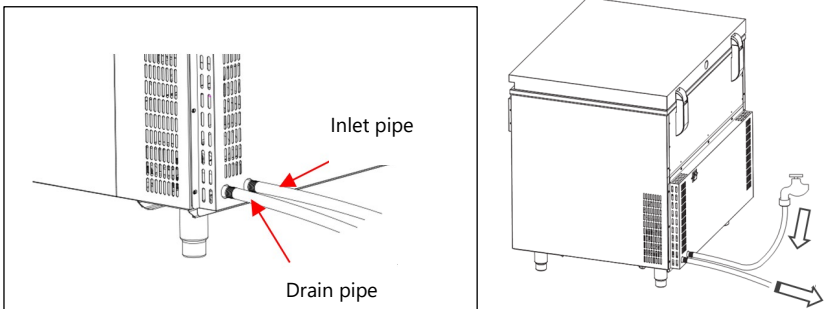

Note: The drain pipe is a corrugated hose about 1 meter long and should be placed into the drainage system. The drain pipe should not be placed higher than the water outlet.

How to make clear ice

1. Fit the two halves of the molds together with the tongue and groove, and place them correctly in the tray. The ice mold color should be the same with the tray color tag, and the molds should be placed in the correct direction.

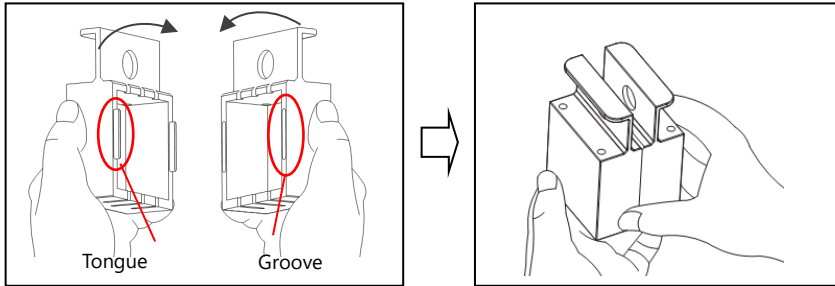

Note: When placing the ice molds, please choose the tray with color tag that have the same color as the ice molds.

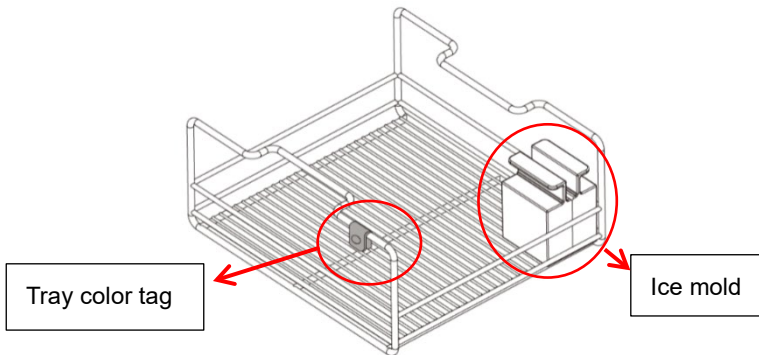

Ice cube: The ice cube molds and the tray color tag are gray. Each tray can hold 30 molds and the placement direction is shown as follows:

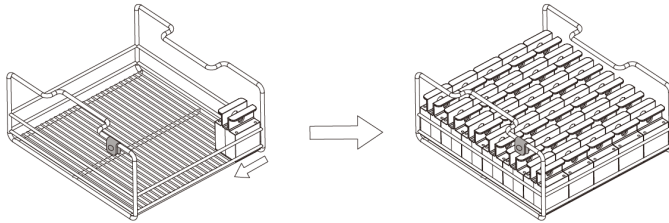

Ice sphere: The ice sphere molds and the tray color tag are green. Each tray can hold 16 molds and the placement direction is shown as follows:

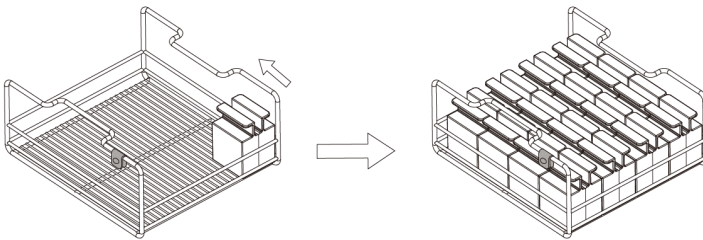

Ice bar: The ice bar molds and the tray color tag are black. Each tray can hold 24 molds and the placement direction is shown as follows:

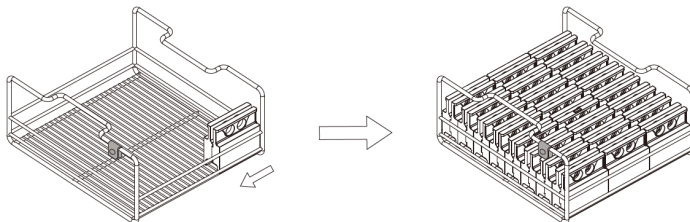

Ice diamond: The ice diamond molds and the tray color tag are purple. Each tray can hold 30 molds and the placement direction is shown as follows:

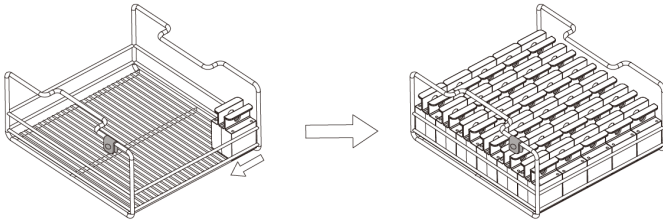

2. Place the tray with the molds on the support blocks in the machine.

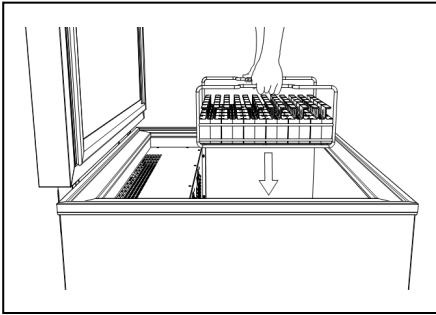

3. Close the lid.

Note: When opening or closing the lid, always hold it with your hand to avoid injury.

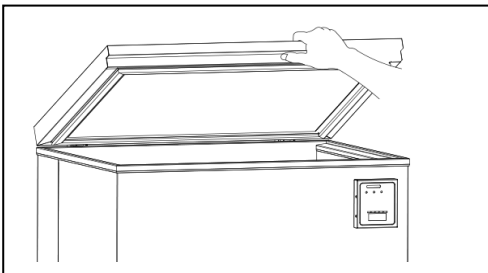

4. Connect to the power supply, and the display will show "OFF". Press the "Power"

button, and the machine will enter standby mode.

5. Press the "Ice" button, the indicator light will turn on, and the machine will start to work:
 - ① The machine is first filled with water, the display shows "ICE1", and the first indicator light of the progress bar flashes;
 - ② When the water-filling is complete, the first indicator light of the progress bar will keep on, and the machine will start heating the water (to about 68°F/20°C). The display will show "ICE2", and the second light will flash. If the initial water temperature is above 68°F/20°C, the machine will skip the heating process;
 - ③ When the water-heating is complete, the second light of the progress bar will keep on, and the machine will start making ice. The display will show "ICE3" and ice-making time alternately. Meanwhile, the third light of the progress bar will flash;
 - ④ When the ice-making is complete, the third light of the progress bar will keep on, and the machine will start detaching ice. The indicator of "Detach" will light up, the display will show "ICE4", and the fourth light of the progress bar will flash;
 - ⑤ When the ice-detaching is complete, the "Ice" and the "Detach" indicators will be off, and the fourth and fifth lights of the progress bar will keep on. (All the lights of the progress bar will be on when the entire ice making process is complete.)

Note: ① **If for some reason, the machine cannot automatically fill with water, you can manually add water to the MAX line, and do not exceed the entire overflow hole. It is not recommended to use pure water. Filtered water or mineral water is recommended.**

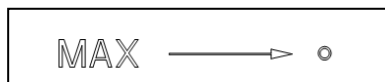

② **If you want to detach the ice in advance during ice-making process, first unlock the machine by pressing the "Ice" and "Detach" buttons simultaneously for several seconds. Then press "Detach" and the machine will start detaching ice.**

6. When the whole process is complete, all lights on the progress bar will be on, and the machine will make three beeps. The indicators of "Ice" and "Detach" will be off, the display will show the compartment temperature, and the machine will enter ice storage mode.

Note:

- ① After entering ice storage mode, if the machine stops (possibly caused by accidentally pressing "Stop/Drain" or "Power"), press and hold the "Freeze" button for about 3 seconds, and the machine will re-enter the ice storage mode.
- ② In ice storage mode, the last digit on the display indicates the temperature unit. "C" represents Celsius, and "F" represents Fahrenheit. To switch the temperature unit, please follow these steps: First, press the "Stop/Drain" button to return to standby mode. Next, press and hold both the "Freeze" and "Stop/Drain" buttons for about 3 seconds to complete the unit switch. Lastly, press and hold the "Freeze" button for about 3 seconds to re-enter the ice storage mode.

7. To remove the ice immediately after ice detaching, there are two ways. When there is enough operating space, we recommend Method 1. If not, use Method 2.

Method 1: Remove the tray, put it aside for 15 minutes. Insert a spade between the molds to separate them from each other, and then you can take them out one by one.

Method 2: Remove the ice molds from the tray in the compartment. Insert a spade into between the molds to separate them from each other, and then you can take them out one by one.

8. If the machine has been in the ice storage mode for more than 4 hours, you can directly pull out the ice molds without using the spade.

Method 1:

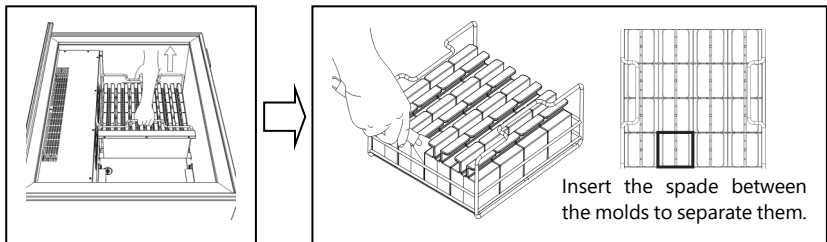

Method 2:

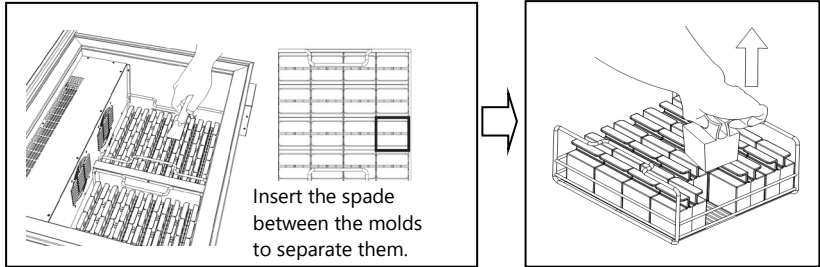

Note: It is recommended to use the ice cubes within 12 hours after completing the ice-making process. Keeping the ice cubes in the storage for more than 12 hours may cause changes in their transparency or melting.

9. Open the ice mold and remove the ice.

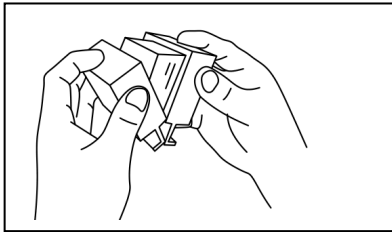

Note: If you are having difficulty opening the silicone ice molds, you can quickly place them in clean water for 1-2 seconds and then remove them.

How to use Freeze mode

The machine comes with the Freeze mode for storing food at a temperature of around 5°F (-15°C). When using this mode, do not place the ice molds in the compartment, but can leave the trays.

1. Connect to the power supply, and the display will show "OFF". Press the "Power" button, and the machine will enter standby mode.

2. Press the "Freeze" button to start the freeze mode. The display will show the real-time internal temperature, which will be controlled at about 5°F (-15°C).
3. Place items in the compartment and close the lid.

Care and Maintenance

1. Unplug the machine before cleaning and maintenance.
2. Regularly clean the machine surface with a damp cloth to remove dust and dirt.
3. Regularly clean and disinfect the molds. It can be washed in a dishwasher and disinfected in a sterilizer cabinet. It is recommended to clean them every 15 days or according to your using situation.
4. Regularly clean the compartment and the trays with water. It is recommended to clean them every 15 days or according to your frequency of use.
5. Non-professionals should not disassemble or maintain the machine.
6. Do not tilt the machine when moving or transporting, otherwise it may be damaged.
7. The company will not be responsible for any damage or quality problems caused to the machine by users who do not operate the machine in accordance with this manual.

Troubleshooting

Cannot start

- Make sure the power cord is plugged into the power outlet.
- Check whether the power cord is damaged. If so, do not use the machine.
- If not for the above reasons, please contact professionals for maintenance. (The problem may be: the control panel is damaged, the wire connector is loose, etc.)

Cannot fill with water

- Check whether the button has been pressed and whether the dash-line on the display is moving up and down.
- Make sure the connected water source is turned on.
- If the water inlet valve is faulty, or there is no power supply, please contact professionals for maintenance.

Cannot drain water

- Try pressing and holding the "Stop/Drain" button for about three seconds in standby mode to drain the water.
- Check whether the drain pipe is blocked.
- If the drain valve or the pump malfunctions, please contact professionals for maintenance.

Cannot make ice or refrigerate

- When filling water, the overflow hole may be blocked by bubbles or other things. The water cannot overflow and the ice-making program cannot be started. Please clear the hole to make water overflow smoothly.
- The water level switch may be damaged, so the water level cannot be sensed and the machine cannot start working. Please check to make sure the water level has reached the overflow hole level, then try to press and hold the "Ice" button for about 3 seconds to skip the water filling and go to the next step.
- The control panel and power panel may be damaged, or the wire connector may be

loose, which requires professional maintenance.

Cannot detach ice

- Try pressing and holding the "Detach" button for about 3 seconds in standby mode to start the ice-detaching process again.
- The control panel and power panel may be damaged, or the wire connector may be loose, which requires professional maintenance.
- Water heating and circulation may damage or loosen the power terminals or others, which requires professional maintenance.

Time or temperature inaccurate

- The control panel, power panel, and temperature sensor may be damaged, or the wire connector may be loose, which requires professional maintenance.

Diagnostic Trouble Codes

Code	Problem	Solution
H2O	Water filling exceeds 3 hours, and the water level switch is not triggered.	<ol style="list-style-type: none">1. The water pressure may be too high so the water inlet valve cannot be opened; or the water pressure is too low and the water level in the compartment cannot reach the overflow hole within 3 hours. Please try to manually add water to the MAX line to see if the machine can operate.2. May be caused by the water inlet valve or water level switch failure, which requires professional maintenance.
CF	If the water temperature does not decrease by at least 0.5°C within the first hour of ice making, "CF" will be displayed, indicating refrigeration failure.	May be caused by the compressor failure, which requires professional maintenance.

HF	When heating water after water-filling or during ice-detaching process, the temperature does not rise by at least 0.5°C within one hour, "HF" will be displayed, indicating heating failure.	May be caused by the heating pipe failure, which requires professional maintenance.
OE	During heating, if the temperature of the heating tube rises to more than 60°C, "OE" will be displayed, indicating overheating.	May be caused by the water pump failure, which requires professional maintenance.
PC_E	The terminal of the temperature probe in the compartment is loose.	Requires professional maintenance.
PA_E	The water temperature probe terminal is loose.	Requires professional maintenance.
PH_E	The terminal of the heat pipe temperature probe is loose.	Requires professional maintenance.
LP	During the ice-making process, there is a sudden power failure. When the machine is powered on again, it will continue the original work and display "LP". During other processed such as water filling, ice detaching, and ice storage, if the machine is powered off and then on, it will continue the work and "LP" will not be displayed.	<ol style="list-style-type: none"> 1. If the power is off for less than half an hour, the machine can automatically continue the original work after reconnection. You can press the "Ice" button to exit the "LP" display. 2. If the power is off for more than half an hour, it is recommended to re-make the ice: long press "Ice" and "Detach" buttons for several seconds to unlock, then press "Stop/Drain" to stop the current work, and finally press "ICE" to re-make.