



OPTONICA

**LED MALL**  
**Catalogo**  
**2024**



604 23 94 75



office@ledmall.es

# OPTONICA LED

**Who we are:**

OPTONICA is a dynamically evolving trade mark, registered in 2011 on the Bulgarian market and a leader in the technologies of the future: LED LIGHTING! We are a team of highly qualified specialists, always perfecting our knowledge and exploring the world of the rapidly developing LED technologies.

**Mission:**

Our main goal is to serve and cater for the needs of our potential clients and partners with a large variety and quantity of LED products.. We are sure of the quality of our products and guarantee that our services do not have an alternative, thus making us an indicator and an absolute priority in the precision and execution of our work.

**Scope of work:**

Our company is a main importer and provider of the richest and most versatile range of LED products. We work with established manufacturers, leaders in the field of the industrial LED revolution.

**What we offer:**

- New generation of LED lighting with a wide range of application: homes, offices, stores, restaurants, hotels, public and administrative buildings, hospitals, schools, gas stations, trade and industrial building, parks, sport halls and stadiums, lawns, garages and parking lots, billboards and commercial constructions.
- Uncompromising quality and up to 5 year warranty.
- Ecological products and 100% recycling.
- Wide range of products and optimum stock.
- Attractive and reliable terms for partners and distributors.
- Professional attitude and responsibility towards every engagement.



	Solar Systems	06-29
	LED Spots and Bulbs	30-68
	Fixtures for Spotlights	68-95
	LED Tubes T5, T8	96-105
	LED Fixtures & Batten Lights	106-113
	LED Emergency Lights	114-119
	LED Surface Panels	120-127





LED Ceiling & Pendants

128-159



LED Panels & Mini Panels

160-191



LED Downlights

192-201



LED Strips  
LED Flex Neon  
SMD Modules

202-241



LED Power Supplies

242-255



LED Controllers & Accessories

256-279

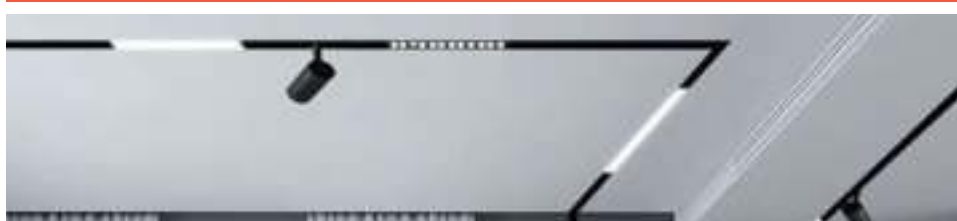

LED Linear & Track Lights

280-309



LED Floodlights

310-343



LED Industrial & Street Lights

344-369



LED Wall & Step Lights

370-389



LED Outdoor & Garden lights

390-421



LED Motion Sensors

422-433



LED Displays & Stage Effects

434-483



OPTONICA Comfort Products

484-499

E27	E27 Socket Base	<b>8W</b>	Wattage in W	45°	Tilt angle	IK08	Impact Protection	RGB	RGB Colors	UV	UV Protection
E14	E14 Socket Base	<b>810</b>	Total luminous flux Lumens	PIR	Motion sensor Sensor	3 PVC	Recyclable plastic	CRI 90+	Higher CRI		Fast charging
GU10	GU10 Socket Base	<b>HIGH</b>	High luminous flux Lumens	Switch	ON/OFF switch	With FAN	Fan included	alexa	Voice assistant		Power surges protection
GU5.3	MR16 Socket Base	<b>160</b>	Flux per Wattage Lumen/W	DC:12V/24V	DC Current Output	EMC Driver	Improved Driver		Voice assistant		Plug type
G4	G4 Socket Base		Dimmable	GU10 Holder	GU10 Holder included	Slim Line	E27 Socket Base	tuya	APP control		USB included
G9	G9 Socket Base		Non-dimmable	E27 Holder	E27 Holder included	Magnetic	Magnetic attachment		Certificate passed		Wireless charger
B22	B22 Socket Base	IP20	Nonwaterproof	Solar Power	Solar Panel included	1m	Open cable, in length		German standard		Operating current
B15	B15 Socket Base	IP65	Waterproof	Battery	Battery included	Linkable	Linkable products	90 Minutes	Fire-resistance rating		Flame Machine
G5.3	G5.3 Socket Base	3 PCS PACK	Pcs per box/set	Rechargeable	Rechargeable battery	Flicker Free LED	Eye care LED		Emergency light		Confetti Machine
GX53	GX53 Socket Base	180°	Beam angle in degrees	5m-Roll	Roll length in m.	Music	Music control	300W LED Power	MAX operating power	CO2-FOG	Fog Machine
5 Years	Warranty Period	150x150mm	Cutout size	120 pcs	SMD diodes per m.	M35 TRACK	Track Base width	>1500 Cycles	Rechargeable cycles	HAZE	Haze Machine





## OPTONICA

### SOLAR POWER SYSTEM

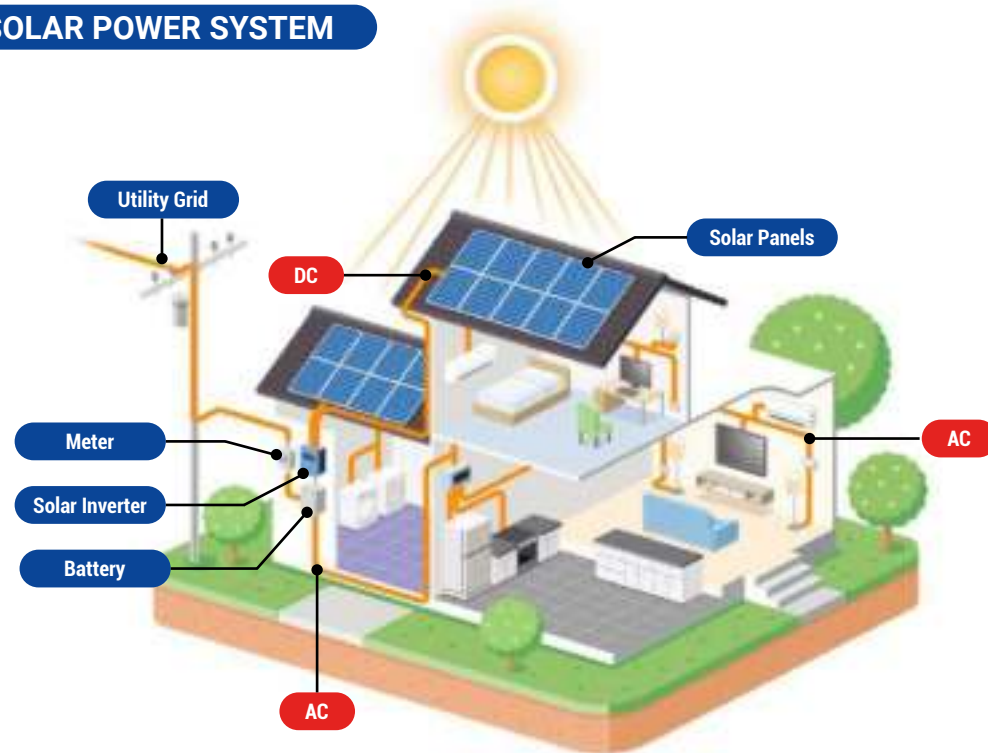

#### What components make up a solar panel system?

Solar panel installations are very straightforward systems. There are only four main components to any solar panel system, and no moving parts, making them very efficient to install and maintain. The four components of a solar panel system are:

**Solar photovoltaic panels**—to convert solar energy into electricity

**Battery**—to store DC electricity

**Inverters**—to convert DC electricity into AC electricity

**Racking and mounting systems**—to affix your solar panels to your roof (or to the ground, depending upon your installation type)

**Performance monitoring systems**—to track and monitor the output and health of your solar panels and inverters

## OPTONICA

### SOLAR POWER PRODUCTS



#### How does solar power work?

Solar power works by converting energy from the sun into power. There are two forms of energy generated from the sun for our use – electricity and heat.

Both are generated through the use of solar panels, which range in size from residential rooftops to 'solar farms' stretching over acres of rural land.

#### Is solar power a clean energy source?

Yes, solar power is a renewable and infinite energy source that creates no harmful greenhouse gas emissions – as long as the sun continues to shine, energy will be released.

The carbon footprint of solar panels is already quite small, as they last for 25 years plus with no loss in efficiency. And the materials used in the panels are increasingly recycled, so the carbon footprint will continue to shrink.

#### When was solar power discovered?

Solar energy was used by humans as early as the 7th century B.C., when humans used sunlight to light fires by reflecting the sun's rays onto shiny objects. Later, in 3rd century B.C., the Greeks and Romans harnessed solar power with mirrors to light torches for religious ceremonies.

In 1839 and at the age of just 19, French physicist Edmond Becquerel discovered the photovoltaic (PV) effect while experimenting with a cell made of metal electrodes in a conducting solution. He noted that the cell produced more electricity when it was exposed to light – it was a photovoltaic cell.

In 1954 PV technology was born when Daryl Chapin, Calvin Fuller and Gerald Pearson developed the silicon PV cell at Bell Labs in 1954 – the first solar cell capable of absorbing and converting enough of the sun's energy into power to run everyday electrical equipment.

Today satellites, spacecraft orbiting Earth, are powered by solar energy.

#### How exactly is electricity from solar energy produced?

Solar panels are usually made from silicon installed in a metal panel frame with a glass casing. When photons, or particles of light, hit the thin layer of silicon on the top of a solar panel, they knock electrons off the silicon atoms.

This PV charge creates an electric current (specifically, direct current or DC), which is captured by the wiring in solar panels. This DC electricity is then converted to alternating current (AC) by an inverter. AC is the type of electrical current used when you plug appliances into normal wall sockets.



## PORTABLE POWER STATION

PURE SINE WAVE AC OUTPUT

IDEAL FOR OUTDOOR & RECREATION



### 400W

Cell Capacity: 400W/320Wh  
 DC Input: 12V-24V/0-10A (120W Max)  
 AC Output: 230Vac 400W  
 DC Output: 12V/0-10A  
 Cigar Socket Output: 13.3V/10A  
 USB-A Output: 5V/2.4A  
 USB-C Output: 20V/3A max  
 LED Flashlight: 3W

**SKU: 9418**

### 600W

Cell Capacity: 600W/512Wh  
 DC Input: 12V-24V/0-10A (120W Max)  
 AC Output: 230Vac 600W  
 DC Output: 12V/0-10A  
 Cigar Socket Output: 13.3V/10A  
 USB-A Output: 5V/2.4A  
 USB-C Output: 20V/5A max  
 LED Flashlight: 3W

**SKU: 9419**

### 1000W

Cell Capacity: 1000W/1036.8Wh  
 DC Input: 12V-24V/0-10A (200W Max)  
 AC Output: 230Vac 1000W  
 DC Output: 12V/0-10A  
 Cigar Socket Output: 13.3V/10A  
 USB-A Output: 5V/2.4A  
 USB-C Output: 20V/5A max  
 LED Flashlight: 3W

**SKU: 9420**

### 2000W

Cell Capacity: 2000W/2096Wh  
 DC Input: 12V-65V/0-10A (650W Max)  
 AC Output: 230Vac 2000W  
 DC Output: 12V-65V/0-10A  
 Cigar Socket Output: 13V/10A  
 USB-A Output: 5V/2.4A  
 USB-C Output: 20V/5A max  
 LED Flashlight: 3W  
 Wireless Charge: (20W Max)

**SKU: 9421**

#### Bags for Portable Starion

For 400W - SKU: 9429  
 For 600W - SKU: 9428  
 For 1000W - SKU: 9422  
 For 2000W - SKU: 9423



### MONOCRYSTALLINE PORTABLE SOLAR PANEL 120W

Convert Efficiency: up to 21%  
 ETFE high Light Transmittance Film  
 Output: 1. MC4 18V/6.6A Max  
 2. USB-A QC 3.0 24W Max  
 3. Type-C: PD45W Max  
 Material: PET Monocrystalline solar panel  
 Intelligent charging chip

**SKU: 9400**



### MONOCRYSTALLINE PORTABLE SOLAR PANEL 200W

Convert Efficiency: up to 21%  
 ETFE high Light Transmittance Film  
 Output: 1. MC4 18V/11.1A Max  
 2. USB-A QC 3.0 24W Max  
 3. Type-C: PD45W Max  
 Material: PET Monocrystalline solar panel  
 Intelligent charging chip

**SKU: 9401**



### MONOCRYSTALLINE PORTABLE SOLAR PANEL 400W

Convert Efficiency: up to 21%  
 ETFE high Light Transmittance Film  
 Output: MC4 36V/6.6A Max  
 Material: PET Monocrystalline solar panel  
 Intelligent charging chip

**SKU: 9402**



**PV SOLAR PANELS**
**OPTONICA**  
**SOLAR**

**PV SOLAR PANELS**
**OPTONICA**  
**SOLAR**

**MONOCRYSTALLINE  
SOLAR PV MODULE**
**410W**

PV Model	FV410-A1	<b>SKU:9404</b>
Rated Maximum Power (Pmax)		410W
Power Sorting		0~+5W
Voltage at Pmax (Vmp)		31.40V
Current at Pmx (IMP)		13.06A
Open-Circuit Current (Voc)		37.30V
Short-Circuit Current (Isc)		13.93A
Pv Module Classification		CLASS II
Maximum System Voltage		1500V
Maximum Series Fuse Rating		25A
Operating Temperature		-40~85° C
Dimensions (mm)		1722x1134x30mm
Pmax /Voc / Isc Tolerance		± 3%

Tested at STC:1000W/m ; AM1.5; Cell temperature 25C°

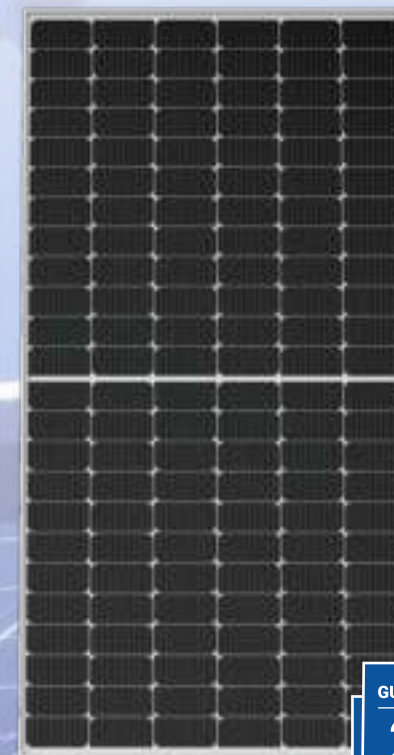
**MONOCRYSTALLINE  
SOLAR PV MODULE**
**450W**

PV Model	FV450-A1	<b>SKU:9403</b>
Rated Maximum Power (Pmax)		450W
Power Sorting		0~+5W
Voltage at Pmax (Vmp)		42.10V
Current at Pmx (IMP)		10.69A
Open-Circuit Current (Voc)		49.84V
Short-Circuit Current (Isc)		11.20A
Pv Module Classification		CLASS II
Maximum System Voltage		1500V
Maximum Series Fuse Rating		15A
Operating Temperature		-40~85° C
Dimensions (mm)		2094x1038x35mm
Pmax /Voc / Isc Tolerance		± 3%

Tested at STC:1000W/m ; AM1.5; Cell temperature 25C°

**Micro Inverter**

1. Input: 2\*MC4 / PV 2\*210-400W
2. Output: 230Vac 600W
3. MPPT 25-55V 2\*13A
4. Unit: 212\*230\*40mm 3.15kg
5. IP67

**SKU: 9431**
**SKU: 9424**

**SKU: 9425**

**SKU: 9426**

**SKU: 9427**



## PV SOLAR PANELS



### MONOCRYSTALLINE SOLAR PV MODULE

### 410W

PV Model	FV410-A1	<b>SKU:9406</b>
Rated Maximum Power (Pmax)		410W
Power Sorting		0~+5W
Voltage at Pmax (Vmp)		34.89V
Current at Pmx (IMP)		11.76A
Open-Circuit Current (Voc)		41.90V
Short-Circuit Current (Isc)		12.47A
Pv Module Clasification		CLASS II
Maximum System Voltage		1500V
Maximum Series Fuse Rating		20A
Operating Temperature		-40~85° C
Dimensions (mm)		1754x1096x30mm
Pmax /Voc / Isc Tolerance		± 3%

Tested at STC:1000W/m ; AM1.5; Cell temperature 25C°



SKU: 9451,9453



4 mm<sup>2</sup> ; 6 mm<sup>2</sup>

SKU: 9452,9454



4 mm<sup>2</sup> ; 6 mm<sup>2</sup>

SKU: 9457



SKU: 9458



## PV SOLAR PANELS



### MONOCRYSTALLINE SOLAR PV MODULE

### 450W

PV Model	FV450-A1	<b>SKU:9407</b>
Rated Maximum Power (Pmax)		450W
Power Sorting		0~+5W
Voltage at Pmax (Vmp)		41.30V
Current at Pmx (IMP)		10.90A
Open-Circuit Current (Voc)		49.70V
Short-Circuit Current (Isc)		11.50A
Pv Module Clasification		CLASS II
Maximum System Voltage		1500V
Maximum Series Fuse Rating		20A
Operating Temperature		-40~85° C
Dimensions (mm)		2108x1048x35mm
Pmax /Voc / Isc Tolerance		± 3%

Tested at STC:1000W/m ; AM1.5; Cell temperature 25C°



SKU: 9455 ; 9456



SKU: 9434



### PV POWER OPTIMIZER



SKU: 9464



## PV SOLAR PANELS



## PV SOLAR PANELS



### MONOCRYSTALLINE SOLAR PV MODULE

### 445W

PV Model	FV445-A1	<b>SKU:9408</b>
Rated Maximum Power (Pmax)		445W
Power Sorting		0~+5W
Voltage at Pmax (Vmp)		45.09V
Current at Pmx (IMP)		12.57A
Open-Circuit Current (Voc)		37.54V
Short-Circuit Current (Isc)		11.86A
Pv Module Clasification		CLASS I
Maximum System Voltage		1500V
Maximum Series Fuse Rating		20A
Operating Temperature		-40~85° C
Dimensions (mm)		1894x1096x30mm
Pmax /Voc / Isc Tolerance		± 3%

Tested at STC:1000W/m ; AM1.5; Cell temperature 25C°



### MONOCRYSTALLINE SOLAR PV MODULE

### 550W

PV Model	FV550-A1	<b>SKU:9405</b>
Rated Maximum Power (Pmax)		550W
Power Sorting		0~+5W
Voltage at Pmax (Vmp)		42.20V
Current at Pmx (IMP)		13.04A
Open-Circuit Current (Voc)		49.80V
Short-Circuit Current (Isc)		13.94A
Pv Module Clasification		CLASS II
Maximum System Voltage		1500V
Maximum Series Fuse Rating		25A
Operating Temperature		-40~85° C
Dimensions (mm)		2279x1134x35mm
Pmax /Voc / Isc Tolerance		± 3%

Tested at STC:1000W/m ; AM1.5; Cell temperature 25C°





**PV SOLAR PANELS**

**MONO HALF-CUT MODULE  
BLACK FRAME**
**405W**
**UL-405-108HV**
**MBB 182mm Cell**

PV Model	<b>SKU:9411</b>
Rated Maximum Power (Pmax)	405W
Power Sorting	0~+5W
Voltage at Pmax (Vmp)	31.3V
Current at Pmx (IMP)	12.94A
Open-Circuit Current (Voc)	37.3V
Short-Circuit Current (Isc)	13.69A
Module Efficiency STC	20.74
Maximum System Voltage	1500V
Maximum Series Fuse Rating	25A
Operating Temperature	-40~85° C
Dimensions (mm)	2279/1134/35mm
Pmax /Voc / Isc Tolerance	± 3%

Tested at STC:1000W/m ; AM1.5; Cell temperature 25C°

**Lower LCOE**  
 Lower shading and resistive loss  
 Lower temperature coefficient

**Anti-PID (potential induced degradation)**  
 Passed anti-PID test under 85% damp heat,  
 85% relative humidity for 96 hours

**PV SOLAR PANELS**

**MONO HALF-CUT MODULE  
SILVER FRAME**
**455W**
**UL-455M-144HV**
**MBB 166mm Cell**

PV Model	<b>SKU:9410</b>
Rated Maximum Power (Pmax)	455W
Power Sorting	0~+5W
Voltage at Pmax (Vmp)	41.1V
Current at Pmx (IMP)	11.07A
Open-Circuit Current (Voc)	49.9V
Short-Circuit Current (Isc)	11.64A
Module Efficiency STC	20.93
Maximum System Voltage	1500V
Maximum Series Fuse Rating	20A
Operating Temperature	-40~85° C
Dimensions (mm)	2094x1038x35mm
Pmax /Voc / Isc Tolerance	± 3%

Tested at STC:1000W/m ; AM1.5; Cell temperature 25C°

**Lower LCOE**  
 Lower shading and resistive loss  
 Lower temperature coefficient

**Anti-PID (potential induced degradation)**  
 Passed anti-PID test under 85% damp heat,  
 85% relative humidity for 96 hours



## PV SOLAR PANELS



## PV SOLAR PANELS



### BIFACIAL MONO PERC MODULE

### 550W

UL-550M-144HV

MBB 182mm Cell

PV Model	<b>SKU:9412</b>
Rated Maximum Power (Pmax)	550W
Power Sorting	0~+5W
Voltage at Pmax (Vmp)	41.9V
Current at Pmx (IMP)	13.13A
Open-Circuit Current (Voc)	50V
Short-Circuit Current (Isc)	13.75A
Module Efficiency STC	21.28
Maximum System Voltage	1500V
Maximum Series Fuse Rating	30A
Operating Temperature	-40~85° C
Dimensions (mm)	2279/1134/35mm
Pmax /Voc / Isc Tolerance	± 3%

Tested at STC:1000W/m ; AM1.5; Cell temperature 25C°



**Lower LCOE**  
 Lower shading and resistive loss  
 Lower temperature coefficient



**Anti-PID (potential induced degradation)**  
 Passed anti-PID test under 85% damp heat,  
 85% relative humidity for 96 hours



### DOUBLE-GLASS BIFACIAL MODULE

### N-TYPE 570 TOPCON

UL-570M-144DG

MBB 182mm Cell

PV Model	<b>SKU:9413</b>
Rated Maximum Power (Pmax)	570W
Power Sorting	0~+5W
Voltage at Pmax (Vmp)	42.2/
Current at Pmx (IMP)	13.51
Open-Circuit Current (Voc)	50.7
Short-Circuit Current (Isc)	14.23
Module Efficiency STC	22.07%
Maximum System Voltage	1500V
Maximum Series Fuse Rating	30A
Operating Temperature	-40~85° C
Dimensions (mm)	2278/1134/35mm
Pmax /Voc / Isc Tolerance	± 3%

Tested at STC:1000W/m ; AM1.5; Cell temperature 25C°



**Lower LCOE**  
 Lower shading and resistive loss  
 Lower temperature coefficient



**Anti-PID (potential induced degradation)**  
 Passed anti-PID test under 85% damp heat,  
 85% relative humidity for 96 hours





**OPTONICA**  
**SOLAR**
**Double Headed Electric Photovoltaic Brush**  
**5.5M Glass Fiber Handle AC220 or 110V AC**

Applicable Voltage	110-240V	Material	Alu/Carbon fiber
Utilization Voltage	24V	Wall thickness	1-1.2mm
Power	52.8W*2	Diameter	43mm
Speed	128rpm	Length	5.5m
Torsion	1.2 N.m	Brush Size	280mm

**Accessories**

- Battery\*1
- Adapter\*1
- Water pipe and accessories\*1
- Backpack\*1
- Push button switch spring wire\*1
- Telescopic rod\*1
- Brush head assembly\*1 set  
(including 1 pcs brush discs)

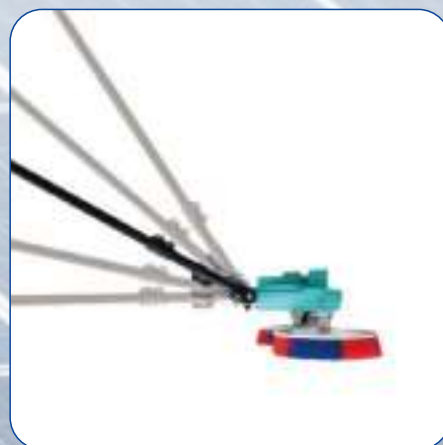
**SKU: 9656**

**OPTONICA**  
**SOLAR**
**Solar Panel Cleaning Robot - Watering**

Solar panel cleaning robot



Solar panel cleaning robot



Solar panel cleaning robot



Solar panel cleaning robot

**SINGLE SOLAR PANEL CLEANING ROBOT**  
**2384mm 150W 24V10Ah**
**SKU: 9658**

PV Module Range	2384mm Single PV Panel
Traveling Speed	15-20 m/min
Generator Power	150W
Water Used Per Hour	330L/H
Solar Panel(W)	27W
Battery Capacity(Ah)	24V/10Ah
Cleaning Mode	Dry/Watering Cleaning
Other Functions	Speed Adjust/Direction Adjust

**DOUBLE SOLAR PANEL CLEANING ROBOT**  
**2384mm 200W 24V20Ah**
**SKU: 9659**

PV Module Range	2384mm Double PV Panel
Traveling Speed	15-20 m/min
Generator Power	200W
Water Used Per Hour	330L/H
Solar Panel(W)	27W
Battery Capacity(Ah)	24V/10Ah
Cleaning Mode	Dry/Watering Cleaning
Other Functions	Speed Adjust/Direction Adjust



## RECHARGEABLE LITHIUM BATTERY SYSTEM



### BATTERY LiFePo4

**10.94kWh**
**10.24kWh**
**5.12kWh**

Model	SKU:9471	SKU:9472	SKU:9473
Nominal Capacity	228Ah	200Ah	100Ah
Nominal Energy	10.94kWh	10.24kWh	5.12kWh
Nominal Voltage	48Vdc	51.2Vdc	51.2Vdc
Discharge Current	150A	150A	100A
Cell	BYD	EVE	EVE
Ingress Protection	IP65	IP65	IP65
Weight	90kg	90kg	42.2kg

## MULTI-FUNCTION ELECTRICAL ENERGY METERS



### Single-phase Multi-Function electrical energy meter

230V/100A/RS485/MID Certification  
**SKU: 9461**

### Three-phase Multi-Function electrical energy meter

3x230V/100A/RS485/MID certification  
**SKU: 9462**

### CT Three-phase Multi-Function electrical energy meter

3x230V/1A or 5A/RS485/MID certification  
**SKU: 9463**



## ONE-PHASE HYBRID INVERTERS

5kW

6kW



Model	SKU: 9437	SKU:9438
<b>Battery Input Data</b>		
Battery Type	Lead-acid or Li-Ion	
Battery Voltage Range (V)	40~60	
Max. Charging Current (A)	120	135
Max. Discharging Current (A)	120	135
External Temperature Sensor	Yes	
Charging Curve	3 Stages / Equalization	
Charging Strategy for Li-Ion Battery	Self-adaption to BMS	
<b>PV String Input Data</b>		
Max. DC Input Power (W)	6500	7800
Rated PV Input Voltage (V)	370 (125~500)	
Start-up Voltage (V)	125	
MPPT Voltage Range (V)	150-425	
Full Load DC Voltage Range (V)	300-425	
PV Input Current (A)	13+13	
Max. PV I <sub>sc</sub> (A)	17+17	
No. of MPP Trackers	2	
No. of Strings per MPP Tracker	1	
<b>AC Output Data</b>		
Rated AC Output and UPS Power (W)	5000	6000
Max. AC Output Power (W)	5500	6600
AC Output Rated Current (A)	22.7/217	27.3/261
Max. AC Current (A)	25/239	30/287
Max. Continuous AC Passthrough (A)	40	
Peak Power (off grid)	2 time of rated power, 10S	
Power Factor	0.8 leading to 0.8 lagging	
Output Frequency and Voltage	50/60Hz; L/N/PE 220/230Vac (single phase)	
Grid Type	Single Phase	
Total Harmonic Distortion (THD)	<3% (of nominal power)	
DC current injection	<0.5% I <sub>n</sub>	

## THREE-PHASE HYBRID INVERTERS

8kW

10kW



Model	SKU: 9436	SKU:9435
<b>Battery Input Data</b>		
Battery Type	Lead-acid or Li-Ion	
Battery Voltage Range (V)	40~60	
Max. Charging Current (A)	190	210
Max. Discharging Current (A)	190	210
External Temperature Sensor	Yes	
Charging Curve	3 Stages / Equalization	
Charging Strategy for Li-Ion Battery	Self-adaption to BMS	
<b>PV String Input Data</b>		
Max. DC Input Power (W)	10400	13000
Rated PV Input Voltage (V)	550 (160~800)	
Start-up Voltage (V)	160	
MPPT Voltage Range (V)	200-650	
Full Load DC Voltage Range (V)	350-650	
PV Input Current (A)	13+13	26+13
Max. PV I <sub>sc</sub> (A)	17+17	34+17
No. of MPP Trackers	2	
No. of Strings per MPP Tracker	1	2+1
<b>AC Output Data</b>		
Rated AC Output and UPS Power (W)	8000	10000
Max. AC Output Power (W)	8800	11000
AC Output Rated Current (A)	12.1/111.6	15.2/14.5
Max. AC Current (A)	18.2/17.4	22.7/21.7
Max. Continuous AC Passthrough (A)	45	
Peak Power (off grid)	2 time of rated power, 10 S	
Power Factor	0.8 leading to 0.8 lagging	
Output Frequency and Voltage	50/60Hz; 3L/N/PE 220/380, 230/400Vac	
Grid Type	Three Phase	
Total Harmonic Distortion (THD)	<3% (of nominal power)	
DC current injection	<0.5% I <sub>n</sub>	



## Three Phase On-Grid Solar Inverter



MODEL	SKU:9481	SKU:9482	SKU:9483	SKU:9484	SKU:9485
<b>Input(DC)</b>	Max 12.8KW	Max 16KW	Max 48KW	Max 80KW	Max 150kW
Max. DC Voltage	1100V	1100V	1100V	1100V	1100V
Nominal Voltage	600V	600V	600V	600V	620V
Start Voltage	160V	160V	250V	250V	250V
MPPT Voltage Range	180V~1000V	180V~1000V	200V~1000V	200V~1000V	180V~1000V
Number of MPPT Tracker	2	2	3	4	9
Strings Per MPPT Tracker	1	1	2	3/2/3/2	2
Max. Input Current Per MPPT	14A/14A	14A/14A	26A	39A/26A/39A/26A	26A
Max. Short-circuit Current Per MPPT	18A/18A	18A/18A	32A	48A/32A/48A/32A	40A
<b>Output(AC)</b>					
Nominal AC Output Power	8kW	10kW	30kW	50kW	100kW
Maximum AC Output Power	8.8kVA	11kVA	33kVA	55kVA	110kVa
Nominal AC Voltage	400Vac 3L/N/PE	400Vac 3L/N/PE	400Vac 3L/N/PE	230Vac/400Vac	400Vac 3L/N/PE
AC Grid Frequency Range	50/60Hz	50/60Hz	50/60Hz	50/60Hz	50/60Hz
Maximum Output Current	12.8A	15.9A	48.3A	79.7A	158.8A
Power Factor(Φ)	0.8leading-0.8lagging	0.8leading-0.8lagging	0.8leading-0.8lagging	0.8leading-0.8lagging	0.8leading-0.8lagging
THDi	<3%	<3%	<3%	<3%	<3%
<b>Efficiency</b>					
Max. Efficiency	98.7%	98.7%	98.6%	98.7%	98.7%
<b>General Specifications</b>					
Dimensions W x H x D	481x395x195mm	481x395x195mm	600x430x230mm	650x450x260mm	1050x660x330mm
Operating Temperature Range	-30°C~+60°C	-25°C~+60°C	-25°C~+60°C	-25°C~+60°C	-25°C~+60°C
Cooling Type	Natural cooling	Natural cooling	Smart Cooling	Smart Cooling	Smart Cooling
IP Class	IP66	IP66	IP66	IP66	IP66

## Three Phase On-Grid Solar Inverter



MODEL	SKU:9491	SKU:9492	SKU:9493	SKU:9494
<b>Input(DC)</b>	10KW	30KW	40KW	120KW
Max. DC Voltage	1100V	1100V	1100V	1100V
Nominal Voltage	620V	600V	600V	620V
Start Voltage	180V	180V	180V	250V
MPPT Voltage Range	140V~1000V	200V~1000V	200V~1000V	200V~1000V
Number of MPPT Tracker	2	3	2	10
Strings Per MPPT Tracker	1	2	1	2
Max. Input Current Per MPPT	15A	30A	30A	30A
Max. Short-circuit Current Per MPPT	20A	50A	50A	50A
<b>Output(AC)</b>				
Nominal AC Output Power	10000W	30000W	40000W	120kW
Maximum AC Output Power	11000Va	33000Va	44000Va	121kVa
Nominal AC Voltage	400V 3L+N	400V 3L+N	400V 3L+N	480V 3W+PE
AC Grid Frequency Range	50/60Hz	50/60Hz	50/60Hz	50/60Hz
Maximum Output Current	16.0A	47.7A	63.6A	174.6A
Power Factor(Φ)	0.8leading-0.8lagging	0.8leading-0.8lagging	0.8leading-0.8lagging	0.8leading-0.8lagging
THDi	<3%	<3%	<3%	<3%
<b>Efficiency</b>				
Max. Efficiency	98.6%	98.7%	98.7%	98.7%
<b>General Specifications</b>				
Dimensions W x H x D	380x483x161mm	380x483x227mm	380x483x227mm	1055x700x336mm
Operating Temperature Range	-25°C~+60°C	-25°C~+60°C	-25°C~+60°C	-25°C~+60°C
Cooling Type	Natural cooling	Fan cooling	Fan cooling	Fan cooling
IP Class	IP66	IP66	IP66	IP66



# Deye



## RECHARGEABLE LITHIUM BATTERY SYSTEM



### BATTERY LiFePo4 6.14kWh

Model	<b>SKU:9439</b>
Nominal Capacity	120Ah
Nominal Energy	6.14kWh
Nominal Voltage	51.2Vdc
Operating Voltage Range	43.2~57.6Vdc
Nominal Charge/Discharge Current	60A
Ingress Protection	IP65
Operating Temperature(Charge)	0~+55 C°
Operating Temperature(Discharge)	-20~+55 C°
Storage Temperature	-20~+35 C°
DimmensionS	475x720x145mm
Weight Approximate	58 Kg

SKU: 9603 END CLAMP



SKU: 9604 MIDDLE CLAMP



SKU: 9609 L Foot Group



SKU: 9606 T-Fixture Bolt



SKU: 9607 Self-Tapping Screw



SKU: 9608 Self-Tapping Screw for Wood



SKU: 9605 Tile Hook



SKU: 9611 Hanger Bolt with L Foot



SKU: 9615 Grounding Plate



SKU: 9601-2.2m Rail



SKU: 9602-1.2m Rail



SKU: 9610-Rail Joiner 200mm



SKU: 9616 Tilt Mount-Adjustable



SKU: 9613-9614 Rear Leg



SKU: 9612 Front Leg







## LED BULBS GOLDEN GLASS

Innovative line of half-glass covered bulbs combine the classic retro appearance with modern power-saving technology and creating a cosy ambience in both homes, villa or restaurants and bars.

**Features:**

- Up to 80% power saving impact
- 2500K warm white light
- Half silver or half golden cover
- E27 socket
- Stylish retro look
- Standard bulb head – A60 or G95

**Application:**

- Home use on standard sockets
- Outdoor use in enclosed fixtures
- Discrete or additional lighting





## LED Bulbs PS160 Filament

**8W E27**

GOLDEN GLASS

Watts	8W	CRI	Ra>80
Input Voltage	AC : 175-265V	IP Rating	IP20
Flux	810lm	Dimension	ø160x315 mm
Beam Angle	270°	Body Type	PS160

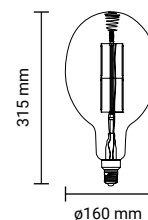
 SKU: 1790  
 1800K

## LED Bulbs Filament

**4W E27**

HALF GOLDEN GLASS

Watts	4W	CRI	Ra>80
Input Voltage	AC : 175-265V	IP Rating	IP20
Flux	400lm	Dimension	ø95x135 mm
Beam Angle	180°	Body Type	G95
Socket	E27	Dimmable	NO

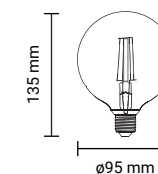
 SKU: 1889  
 1800K

## LED Bulbs BD200 Filament

**8W E27**

GOLDEN GLASS

Watts	8W	CRI	Ra>80
Input Voltage	AC : 175-265V	IP Rating	IP20
Flux	810lm	Dimension	ø200x410 mm
Beam Angle	270°	Body Type	BD200
Socket	E27	Dimmable	YES

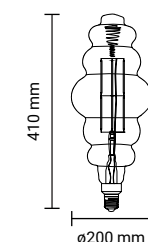
 SKU: 1791  
 1800K

## LED Bulbs Filament

**4W E27**

HALF SILVER GLASS

Watts	4W	CRI	Ra>80
Input Voltage	AC : 175-265V	IP Rating	IP20
Flux	400lm	Dimension	ø95x135 mm
Beam Angle	180°	Body Type	G95
Socket	E27	Dimmable	NO

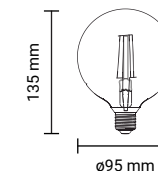
 SKU: 1887  
 1800K

## LED Bulbs G200 Filament

**8W E27**

GOLDEN GLASS

Watts	8W	CRI	Ra>80
Input Voltage	AC : 175-265V	IP Rating	IP20
Flux	810lm	Dimension	ø200x300 mm
Beam Angle	270°	Body Type	G200
Socket	E27	Dimmable	YES

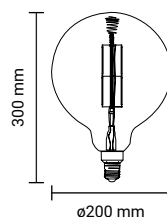
 SKU: 1792  
 1800K

## LED Bulbs Filament

**7W E27**

HALF GOLDEN GLASS

Watts	7W	CRI	Ra>80
Input Voltage	AC : 175-265V	IP Rating	IP20
Flux	800lm	Dimension	ø95x135 mm
Beam Angle	180°	Body Type	G95
Socket	E27	Dimmable	NO

SKU: 1890 Warm White 2700K 3800156618909

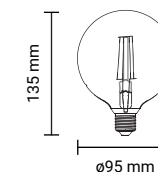

## LED Bulbs MS200 Filament

**8W E27**

GOLDEN GLASS

Watts	8W	CRI	Ra>80
Input Voltage	AC : 175-265V	IP Rating	IP20
Flux	810lm	Dimension	ø200x210 mm
Beam Angle	270°	Body Type	MS200
Socket	E27	Dimmable	YES

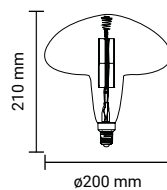
 SKU: 1793  
 1800K

## LED Bulbs Filament

**7W E27**

HALF SILVER GLASS

Watts	7W	CRI	Ra>80
Input Voltage	AC : 175-265V	IP Rating	IP20
Flux	800lm	Dimension	ø95x135 mm
Beam Angle	180°	Body Type	G95
Socket	E27	Dimmable	NO

 SKU: 1888  
 1800K

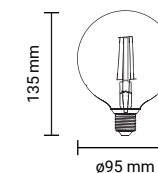
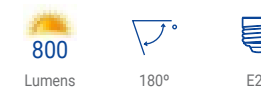
 SKU: 1890  
 1800K





LED Bulbs Filament

**4W E27**

HALF GOLDEN GLASS

Watts 4W  
Input Voltage AC : 175-265V  
Flux 400lm  
Beam Angle 180°  
Socket E27

SKU: 1893  
■ 2700K

CRI Ra>80  
IP Rating IP20  
Dimension ø60x105 mm  
Body Type A60  
Dimmable NO

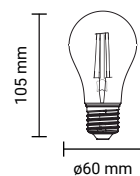

LED ST64 Bulbs Filament

**4W E27**

GOLDEN GLASS

Watts 4W  
Input Voltage AC : 220-240V  
Flux 400lm  
Beam Angle 270°  
Socket E27

SKU: 1795  
■ 2500K

CRI Ra>80  
IP Rating IP20  
Dimension ø64x140 mm  
Body Type ST64  
Dimmable NO

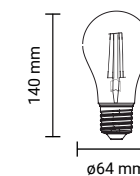
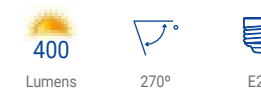

LED Bulbs Filament

**4W E27**

HALF SILVER GLASS

Watts 4W  
Input Voltage AC : 175-265V  
Flux 400lm  
Beam Angle 180°  
Socket E27

SKU: 1879  
■ 2700K

CRI Ra>80  
IP Rating IP20  
Dimension ø60x105 mm  
Body Type A60  
Dimmable NO

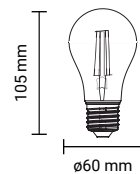

LED ST64 Bulbs Filament

**6W E27**

GOLDEN GLASS

Watts 6W  
Input Voltage AC : 220-240V  
Flux 540lm  
Beam Angle 270°  
Socket E27

SKU: 1306  
■ 2500K

CRI Ra>80  
IP Rating IP20  
Dimension ø64x140 mm  
Body Type ST64  
Dimmable NO

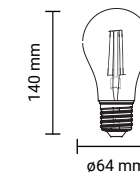

LED Bulbs Filament

**7W E27**

HALF GOLDEN GLASS

Watts 7W  
Input Voltage AC : 175-265V  
Flux 800lm  
Beam Angle 180°  
Socket E27

SKU: 1896  
■ 2700K

CRI Ra>80  
IP Rating IP20  
Dimension ø60x105 mm  
Body Type A60  
Dimmable NO

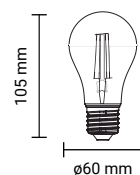

LED ST64 Bulbs Filament

**8W E27**

GOLDEN GLASS

Watts 8W  
Input Voltage AC : 220-240V  
Flux 700lm  
Beam Angle 270°  
Socket E27

SKU: 1305  
■ 2500K

CRI Ra>80  
IP Rating IP20  
Dimension ø64x140 mm  
Body Type ST64  
Dimmable NO

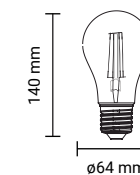

LED Bulbs Filament

**7W E27**

HALF SILVER GLASS

Watts 7W  
Input Voltage AC : 175-265V  
Flux 800lm  
Beam Angle 180°  
Socket E27

SKU: 1880  
■ 2700K

CRI Ra>80  
IP Rating IP20  
Dimension ø60x105 mm  
Body Type A60  
Dimmable NO

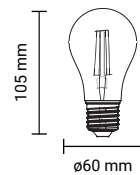

LED ST64 Bulbs Filament

**8W E27**

GOLDEN GLASS

Watts 8W  
Input Voltage AC : 220-240V  
Flux 700lm  
Beam Angle 270°  
Socket E27

SKU: 1322  
■ 2500K

CRI Ra>80  
IP Rating IP20  
Dimension ø64x140 mm  
Body Type ST64  
Dimmable YES

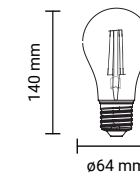





## LED A60 Bulbs Filament

**4W E27**

Watts	4W
Input Voltage	AC : 175-265V
Flux	470lm
Beam Angle	300°
Socket	E27

SKU: 1857	SKU: 1858	SKU: 1859
6000K	4500K	2700K

CRI	Ra>80
IP Rating	IP20
Dimension	ø60x100 mm
Body Type	A60
Dimmable	NO

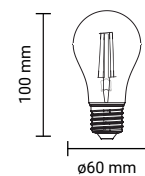

## LED A60 Bulbs Filament

**8W E27**

Watts	8W
Input Voltage	AC : 220-240V
Flux	810lm
Beam Angle	300°
Socket	E27

SKU: 1310	SKU: 1311	SKU: 1312
6000K	4500K	2700K

CRI	Ra>80
IP Rating	IP20
Dimension	ø60x110 mm
Body Type	A60
Dimmable	NO

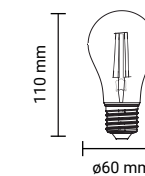

## LED A60 Bulbs Filament

**4W E27**

Watts	4W
Input Voltage	AC : 175-265V
Flux	400lm
Beam Angle	300°
Socket	E27

SKU: 1899
2700K

CRI	Ra>80
IP Rating	IP20
Dimension	ø60x106 mm
Body Type	A60
Dimmable	YES

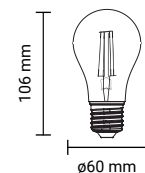

## LED A60 Bulbs Filament

**8W E27**

Watts	8W
Input Voltage	AC : 220-240V
Flux	810lm
Beam Angle	300°
Socket	E27

SKU: 1323
2700K

CRI	Ra>80
IP Rating	IP20
Dimension	ø60x110 mm
Body Type	A60
Dimmable	YES

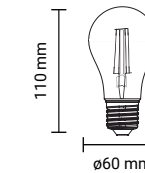

## LED A60 Bulbs Filament

**5W E27**

Watts	5W
Input Voltage	AC : 175-265V
Flux	600lm
Beam Angle	300°
Socket	E27

SKU: 1854	SKU: 1855	SKU: 1856
6000K	4500K	2700K

CRI	Ra>80
IP Rating	IP20
Dimension	ø60x106 mm
Body Type	A60
Dimmable	NO

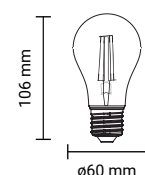

## LED A60 Bulbs Filament

**8W E27****GOLDEN GLASS**

Watts	8W
Input Voltage	AC : 220-240V
Flux	700lm
Beam Angle	300°
Socket	E27

SKU: 1796
2700K

CRI	Ra>80
IP Rating	IP20
Dimension	ø60x105 mm
Body Type	A60
Dimmable	NO

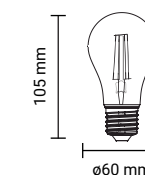

## LED A60 Bulbs Filament

**6W E27**

Watts	6W
Input Voltage	AC : 220-240V
Flux	630lm
Beam Angle	300°
Socket	E27

SKU: 1308	SKU: 1309
4000K	2700K

CRI	Ra>80
IP Rating	IP20
Dimension	ø60x105 mm
Body Type	A60
Dimmable	NO

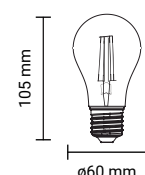

## LED A60 Bulbs Filament

**8W E27****GOLDEN GLASS**

Watts	8W
Input Voltage	AC : 220-240V
Flux	720lm
Beam Angle	300°
Socket	E27

SKU: 1324
2700K

CRI	Ra>80
IP Rating	IP20
Dimension	ø60x105 mm
Body Type	A60
Dimmable	YES

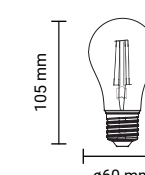



**LED A60 Bulbs Filament**  
**10W E27**

Watts	10W	CRI	Ra>80
Input Voltage	AC : 220-240V	IP Rating	IP20
Flux	1350lm	Dimension	ø60x110 mm
Beam Angle	300°	Body Type	A60
Socket	E27	Dimmable	NO

SKU: 1313   SKU: 1314   SKU: 1315  
 6000K   4500K   2700K

**LED A65 Bulbs Filament**  
**12W E27**

Watts	12W	CRI	Ra>80
Input Voltage	AC : 220-240V	IP Rating	IP20
Flux	1500lm	Dimension	ø65x126 mm
Beam Angle	300°	Body Type	A60
Socket	E27	Dimmable	NO

SKU: 1316   SKU: 1317   SKU: 1318  
 6000K   4500K   2700K

**LED A65 Bulbs Filament**  
**14W E27**

Watts	14W	CRI	Ra>80
Input Voltage	AC : 220-240V	IP Rating	IP20
Flux	2000lm	Dimension	ø65x126 mm
Beam Angle	300°	Body Type	A60
Socket	E27	Dimmable	NO

SKU: 1319   SKU: 1320   SKU: 1321  
 6000K   4500K   2700K

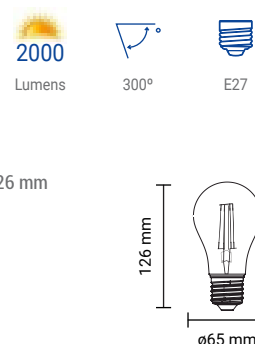
**LED G45 Bulbs Filament**  
**2W E27**

Watts	2W	CRI	Ra>80
Input Voltage	AC : 175-265V	IP Rating	IP20
Flux	200lm	Dimension	ø45x78 mm
Beam Angle	300°	Body Type	G45
Socket	E27	Dimmable	NO

SKU: 1864   SKU: 1865   SKU: 1866  
 6000K   4500K   2700K

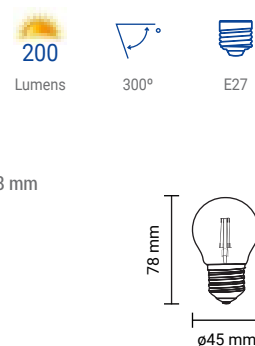
**LED G45 Bulbs Filament**  
**4W E27**

Watts	4W	CRI	Ra>80
Input Voltage	AC : 175-265V	IP Rating	IP20
Flux	400lm	Dimension	ø45x78 mm
Beam Angle	300°	Body Type	G45
Socket	E27	Dimmable	NO

SKU: 1867   SKU: 1868   SKU: 1869  
 6000K   4500K   2700K

**LED G45 Bulbs Filament**  
**4W E27**

Watts	4W	CRI	Ra>80
Input Voltage	AC : 175-265V	IP Rating	IP20
Flux	400lm	Dimension	ø45x78 mm
Beam Angle	300°	Body Type	G45
Socket	E27	Dimmable	NO

SKU: 1325  
 2700K

**LED G45 Bulbs Filament**  
**4W E27**  
**GOLDEN GLASS**

Watts	4W	CRI	Ra>80
Input Voltage	AC : 175-265V	IP Rating	IP20
Flux	320lm	Dimension	ø45x78 mm
Beam Angle	300°	Body Type	G45
Socket	E27	Dimmable	YES

SKU: 1326  
 2700K

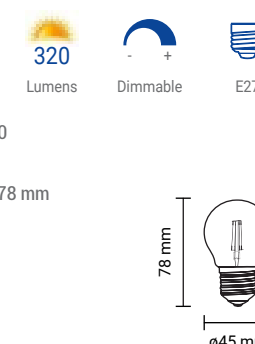
**LED G125 Bulbs Filament**  
**4W E27**  
**GOLDEN GLASS**

Watts	4W	CRI	Ra>80
Input Voltage	AC : 220-240V	IP Rating	IP20
Flux	400lm	Dimension	ø95x135 mm
Beam Angle	270°	Body Type	G95
Socket	E27	Dimmable	NO

SKU: 1794  
 2700K







**LED G125 Bulbs Filament  
4W E27**

Watts 4W  
Input Voltage AC : 175-265V  
Flux 400lm  
Beam Angle 300°  
Socket E27

SKU: 1863    SKU: 1862  
■ 4500K    ■ 2700K

CRI Ra>80  
IP Rating IP20  
Dimension ø125x165 mm  
Body Type G125  
Dimmable NO

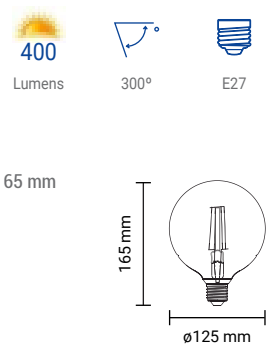

**LED G45 Bulbs Filament  
4W E14**

Watts 4W  
Input Voltage AC : 175-265V  
Flux 400lm  
Beam Angle 300°  
Socket E14

SKU: 1417  
■ 2700K

CRI Ra>80  
IP Rating IP20  
Dimension ø45x78 mm  
Body Type G45  
Dimmable YES

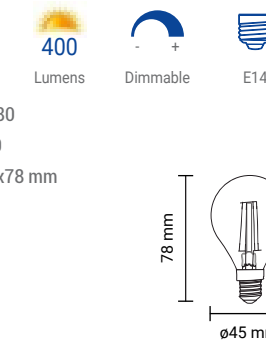

**LED G125 Bulbs Filament  
6.5W E27**

Watts 6.5W  
Input Voltage AC : 175-265V  
Flux 810lm  
Beam Angle 300°  
Socket E27

SKU: 1861    SKU: 1860  
■ 4500K    ■ 2700K

CRI Ra>80  
IP Rating IP20  
Dimension ø125x165 mm  
Body Type G125  
Dimmable NO

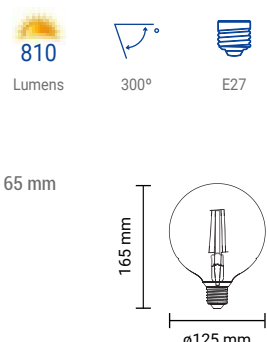

**LED G45 Bulbs Filament  
4W E14  
GOLDEN GLASS**

Watts 4W  
Input Voltage AC : 175-265V  
Flux 400lm  
Beam Angle 300°  
Socket E14

SKU: 1492  
■ 2500K

CRI Ra>80  
IP Rating IP20  
Dimension ø45x78 mm  
Body Type G45  
Dimmable NO



**LED G45 Bulbs Filament  
2W E14**

Watts 2W  
Input Voltage AC : 175-265V  
Flux 200lm  
Beam Angle 300°  
Socket E14

SKU: 1474    SKU: 1475    SKU: 1476  
■ 6000K    ■ 4500K    ■ 2700K

CRI Ra>80  
IP Rating IP20  
Dimension ø45x78 mm  
Body Type G45  
Dimmable NO

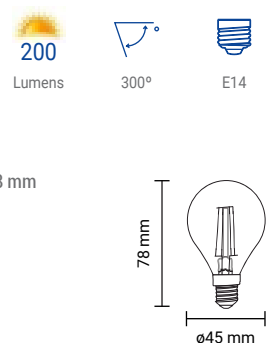

**LED G45 Bulbs Filament  
4W E14  
GOLDEN GLASS**

Watts 4W  
Input Voltage AC : 175-265V  
Flux 350lm  
Beam Angle 300°  
Socket E14

SKU: 1418  
■ 2500K

CRI Ra>80  
IP Rating IP20  
Dimension ø45x78 mm  
Body Type G45  
Dimmable YES



**LED G45 Bulbs Filament  
4W E14**

Watts 4W  
Input Voltage AC : 175-265V  
Flux 400lm  
Beam Angle 300°  
Socket E14

SKU: 1477    SKU: 1478    SKU: 1479  
■ 6000K    ■ 4500K    ■ 2700K

CRI Ra>80  
IP Rating IP20  
Dimension ø45x78 mm  
Body Type G45  
Dimmable NO

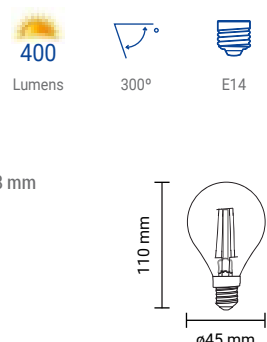

**LED R50 Bulbs Filament  
5W E14**

Watts 5W  
Input Voltage AC : 175-265V  
Flux 600lm  
Beam Angle 70°  
Socket E14

SKU: 1872  
■ 2700K

CRI Ra>80  
IP Rating IP20  
Dimension ø50x86 mm  
Body Type R50  
Dimmable NO







**LED C35 Candle Filament  
4W E14**

Watts	4W	CRI	Ra>80
Input Voltage	AC : 175-265V	IP Rating	IP20
Flux	400lm	Dimension	ø35x98 mm
Beam Angle	300°	Body Type	C35
Socket	E14	Dimmable	NO

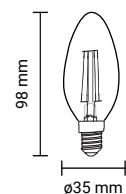
SKU: 1470   SKU: 1471   SKU: 1472  
 6000K   4500K   2700K

**LED C35 Candle Filament  
4W E14**

Watts	4W	CRI	Ra>80
Input Voltage	AC : 175-265V	IP Rating	IP20
Flux	400lm	Dimension	ø35x98 mm
Beam Angle	300°	Body Type	C35
Socket	E14	Dimmable	YES

SKU: 1469   SKU: 1473  
 4500K   2700K

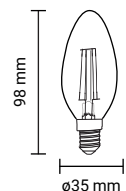
**LED C35 Candle Filament  
4W E14  
GOLDEN GLASS**

Watts	4W	CRI	Ra>80
Input Voltage	AC : 175-265V	IP Rating	IP20
Flux	400lm	Dimension	ø35x98 mm
Beam Angle	300°	Body Type	C35
Socket	E14	Dimmable	NO

SKU: 1490  
 2500K

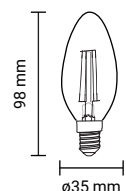
**LED C35 Twist Candle Filament  
4W E14**

Watts	4W	CRI	Ra>80
Input Voltage	AC : 175-265V	IP Rating	IP20
Flux	400lm	Dimension	ø35x98 mm
Beam Angle	300°	Body Type	C35 Twist
Socket	E14	Dimmable	NO

SKU: 1413  
 2700K

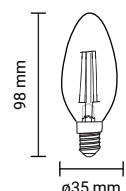
**LED C35 Tip Candle Filament  
4W E14**

Watts	4W	CRI	Ra>80
Input Voltage	AC : 175-265V	IP Rating	IP20
Flux	400lm	Dimension	ø35x115 mm
Beam Angle	300°	Body Type	C35 Tip
Socket	E14	Dimmable	NO

SKU: 1480   SKU: 1481   SKU: 1482  
 6000K   4500K   2700K

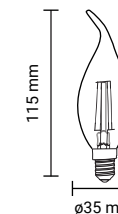
**LED C35 Tip Candle Filament  
4W E14**

Watts	4W	CRI	Ra>80
Input Voltage	AC : 175-265V	IP Rating	IP20
Flux	400lm	Dimension	ø35x115 mm
Beam Angle	300°	Body Type	C35 Tip
Socket	E14	Dimmable	YES

SKU: 1415  
 2700K

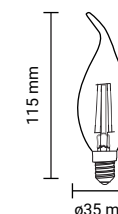
**LED C35 Tip Candle Filament  
4W E14  
GOLDEN GLASS**

Watts	4W	CRI	Ra>80
Input Voltage	AC : 175-265V	IP Rating	IP20
Flux	400lm	Dimension	ø35x120 mm
Beam Angle	300°	Body Type	C35 Tip
Socket	E14	Dimmable	YES

SKU: 1416  
 2500K

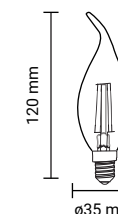
**LED C35 Tip Candle Filament  
4W E14  
GOLDEN GLASS**

Watts	4W	CRI	Ra>80
Input Voltage	AC : 175-265V	IP Rating	IP20
Flux	400lm	Dimension	ø35x120 mm
Beam Angle	300°	Body Type	C35 Tip
Socket	E14	Dimmable	NO

SKU: 1491  
 2500K

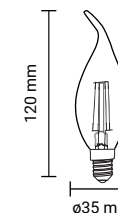





LED C35 Candle Twist Bulbs Filament

**4W E14**

Watts	4W	CRI	Ra>80
Input Voltage	AC : 175-265V	IP Rating	IP20
Flux	400lm	Dimension	ø35x115 mm
Beam Angle	300°	Body Type	C35T Twist
Socket	E14	Dimmable	NO

SKU: 1414  
■ 2700K

**400**  
Lumens
 300°
 E14

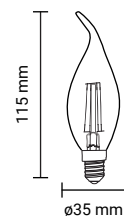

LED C35 Candle Filament

**6W E14**

Watts	6W	CRI	Ra>80
Input Voltage	AC : 175-265V	IP Rating	IP20
Flux	730lm	Dimension	ø35x98 mm
Beam Angle	300°	Body Type	C35
Socket	E14	Dimmable	NO

SKU: 1410 ■ 6000K    SKU: 1411 ■ 4500K    SKU: 1412 ■ 2700K

**730**  
Lumens
 300°
 E14

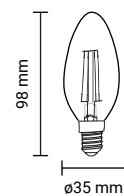

LED Bulb A60 Motion Sensor

**7W E27**

Watts	7W	CRI	Ra>80
Input Voltage	AC : 220-240V	IP Rating	IP20
Flux	560lm	Dimension	ø60x123 mm
Beam Angle	270°	Body Type	A60
Socket	E27	Dimmable	NO

SKU: 1710 ■ 6000K    SKU: 1711 ■ 4500K

**560**  
Lumens
 270°
 E27

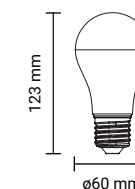

LED Bulb A60

**8.5W E27**

Watts	8.5W	CRI	Ra>80
Input Voltage	AC : 220-240V	IP Rating	IP20
Flux	806lm	Dimension	ø60x108 mm
Beam Angle	270°	Body Type	A60
Socket	E27	Dimmable	NO

SKU: 1351 ■ 6000K    SKU: 1352 ■ 4500K    SKU: 1353 ■ 2700K

**806**  
Lumens
 270°
 E27

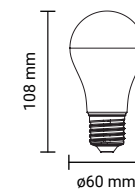



**LED Bulb A60**  
**8.5W E27**

Watts 8.5W  
 Input Voltage AC : 220-240V  
 Flux 806lm  
 Beam Angle 270°  
 Socket E27

CRI Ra>80  
 IP Rating IP20  
 Dimension ø60x108 mm  
 Body Type A60  
 Dimmable NO

SKU: 1341 6000K  
 SKU: 1342 4500K  
 SKU: 1343 2700K

806  
Lumens

270°

E27

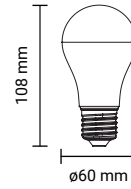

3 PCS  
PACK

**LED Bulb A60**  
**11W E27**

Watts 11W  
 Input Voltage AC : 220-240V  
 Flux 1055lm  
 Beam Angle 270°  
 Socket E27

CRI Ra>80  
 IP Rating IP20  
 Dimension ø60x110mm  
 Body Type A60  
 Dimmable YES

SKU: 1704 6000K  
 SKU: 1705 4500K  
 SKU: 1706 2700K

HIGH  
1055  
Lumens

1055  
Lumens

270°

E27

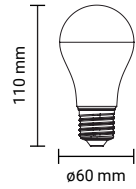

Dimmable

**LED Bulb A60**  
**9W E27**

Watts 9W  
 Input Voltage AC : 220-240V  
 Flux 806lm  
 Beam Angle 270°  
 Socket E27

CRI Ra>80  
 IP Rating IP20  
 Dimension ø60x108 mm  
 Body Type A60  
 Dimmable YES

SKU: 1701 6000K  
 SKU: 1702 4500K  
 SKU: 1703 2700K

806  
Lumens

270°

E27

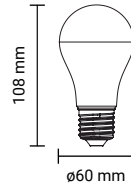

Dimmable

**LED Bulb A60**  
**12W E27**

Watts 12W  
 Input Voltage AC : 175-265V  
 Flux 1055lm  
 Beam Angle 270°  
 Socket E27

CRI Ra>80  
 IP Rating IP20  
 Dimension ø60x120 mm  
 Body Type A60  
 Dimmable YES

SKU: 1851  
6000K

1055  
Lumens

Dimmable

E27

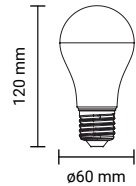
**LED Bulb A60**  
**10W E27**

Watts 10W  
 Input Voltage AC : 220-240V  
 Flux 806lm  
 Beam Angle 270°  
 Socket E27

CRI Ra>80  
 IP Rating IP20  
 Dimension ø60x110 mm  
 Body Type A60  
 Dimmable YES

SKU: 1849  
6000K

806  
Lumens

Dimmable

E27

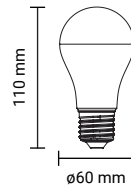
**LED Bulb A60**  
**14W E27**

Watts 14W  
 Input Voltage AC : 220-240V  
 Flux 1380lm  
 Beam Angle 270°  
 Socket E27

CRI Ra>80  
 IP Rating IP20  
 Dimension ø60x108 mm  
 Body Type A60  
 Dimmable NO

SKU: 1357 6000K  
 SKU: 1358 4500K  
 SKU: 1359 2700K

1380  
Lumens

270°

E27

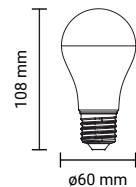
**LED Bulb A60**  
**10.5W E27**

Watts 10.5W  
 Input Voltage AC : 220-240V  
 Flux 1055lm  
 Beam Angle 270°  
 Socket E27

CRI Ra>80  
 IP Rating IP20  
 Dimension ø60x108 mm  
 Body Type A60  
 Dimmable NO

SKU: 1354 6000K  
 SKU: 1355 4500K  
 SKU: 1356 2700K

1055  
Lumens

270°

E27

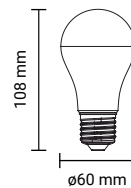
**LED Bulb A65**  
**17W E27**

Watts 17W  
 Input Voltage AC : 220-240V  
 Flux 1710lm  
 Beam Angle 270°  
 Socket E27

CRI Ra>80  
 IP Rating IP20  
 Dimension ø65x134 mm  
 Body Type A65  
 Dimmable NO

SKU: 1360 6000K  
 SKU: 1361 4500K  
 SKU: 1362 2700K

1710  
Lumens

270°

E27

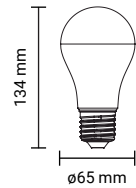





**LED Bulb A65**  
**19W E27**

Watts	19W	CRI	Ra>80
Input Voltage	AC : 220-240V	IP Rating	IP20
Flux	1950lm	Dimension	ø65x138 mm
Beam Angle	270°	Body Type	A65
Socket	E27	Dimmable	NO

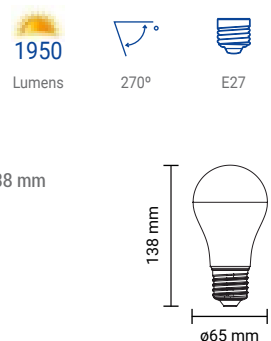
SKU: 1363   SKU: 1364   SKU: 1365  
 ■ 6000K   ■ 4500K   ■ 2700K

**LED Bulb G45**  
**3.5W E27**

Watts	3.5W	CRI	Ra>80
Input Voltage	AC : 175-265V	IP Rating	IP20
Flux	300lm	Dimension	ø45x75 mm
Beam Angle	180°	Body Type	G45
Socket	E27	Dimmable	NO

SKU: 1344   SKU: 1345   SKU: 1346  
 ■ 6000K   ■ 4500K   ■ 2700K

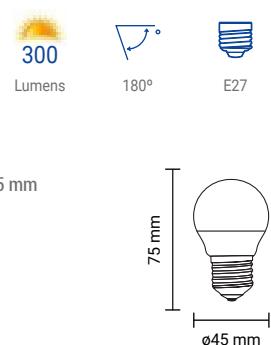
**LED Bulb G45**  
**4W E27**

Watts	4W	CRI	Ra>80
Input Voltage	AC : 175-265V	IP Rating	IP20
Flux	320lm	Dimension	ø45x75 mm
Beam Angle	180°	Body Type	G45
Socket	E27	Dimmable	NO

SKU: 1838   SKU: 1839   SKU: 1840  
 ■ 6000K   ■ 4500K   ■ 2700K

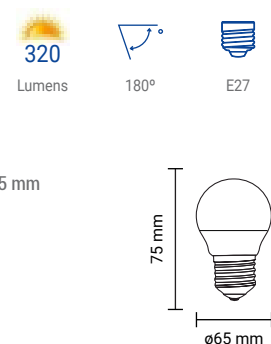
**LED Bulb G45**  
**5.5W E27**

Watts	5.5W	CRI	Ra>80
Input Voltage	AC : 175-265V	IP Rating	IP20
Flux	450lm	Dimension	ø45x75 mm
Beam Angle	180°	Body Type	G45
Socket	E27	Dimmable	NO

SKU: 1327   SKU: 1328   SKU: 1329  
 ■ 6000K   ■ 4500K   ■ 2700K

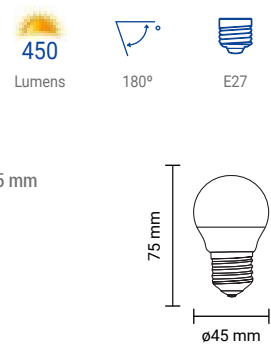
**LED Bulb G45**  
**8W E27**

Watts	8W	CRI	Ra>80
Input Voltage	AC : 175-265V	IP Rating	IP20
Flux	710lm	Dimension	ø45x75 mm
Beam Angle	180°	Body Type	G45
Socket	E27	Dimmable	NO

SKU: 1336   SKU: 1337   SKU: 1338  
 ■ 6000K   ■ 4500K   ■ 2700K

**LED Bulb G95**  
**12W E27**

Watts	12W	CRI	Ra>80
Input Voltage	AC : 175-265V	IP Rating	IP20
Flux	1155lm	Dimension	ø95x138 mm
Beam Angle	270°	Body Type	A60
Socket	E27	Dimmable	NO

SKU: 1841   SKU: 1842   SKU: 1843  
 ■ 6000K   ■ 4500K   ■ 2700K

**LED Bulb G120**  
**15W E27**

Watts	15W	CRI	Ra>80
Input Voltage	AC : 175-265V	IP Rating	IP20
Flux	1500lm	Dimension	ø120x155 mm
Beam Angle	270°	Body Type	G120
Socket	E27	Dimmable	NO

SKU: 1845   SKU: 1846   SKU: 1847  
 ■ 6000K   ■ 4500K   ■ 2700K

**LED Bulb G120**  
**18W E27**

Watts	18W	CRI	Ra>80
Input Voltage	AC : 175-265V	IP Rating	IP20
Flux	1820lm	Dimension	ø125x172 mm
Beam Angle	270°	Body Type	120
Socket	E27	Dimmable	NO

SKU: 1884   SKU: 1885   SKU: 1886  
 ■ 6000K   ■ 4500K   ■ 2700K







**LED Bulb G63**  
**6W E27**

Watts	6W	CRI	Ra>80
Input Voltage	AC : 220-240V	IP Rating	IP20
Flux	480lm	Dimension	ø63x100 mm
Beam Angle	200°	Body Type	A60
Socket	E27	Dimmable	NO

SKU: 1876   SKU: 1877   SKU: 1878  
 ■ 6000K   ■ 4500K   ■ 2700K

480 Lumens   200°   E27

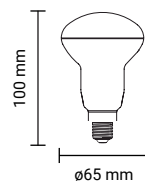

**LED Candle C37**  
**3.5W E14**

Watts	3.5W	CRI	Ra>80
Input Voltage	AC : 175-265V	IP Rating	IP20
Flux	300lm	Dimension	ø37x100 mm
Beam Angle	180°	Body Type	C37
Socket	E14	Dimmable	NO

SKU: 1407   SKU: 1408   SKU: 1409  
 ■ 6000K   ■ 4500K   ■ 2700K

300 Lumens   180°   E14

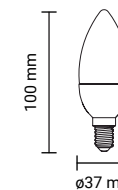

**LED Candle C37**  
**3.7W E14**

Watts	3.7W	CRI	Ra>80
Input Voltage	AC : 175-265V	IP Rating	IP20
Flux	320lm	Dimension	ø37x100 mm
Beam Angle	180°	Body Type	C37
Socket	E14	Dimmable	NO

SKU: 1422   SKU: 1423   SKU: 1424  
 ■ 6000K   ■ 4500K   ■ 2700K

320 Lumens   180°   E14

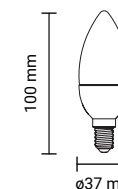

**LED Candle C37**  
**5.5W E14**

Watts	5.5W	CRI	Ra>80
Input Voltage	AC : 175-265V	IP Rating	IP20
Flux	450lm	Dimension	ø37x100 mm
Beam Angle	180°	Body Type	C37
Socket	E14	Dimmable	NO

SKU: 1425   SKU: 1426   SKU: 1427  
 ■ 6000K   ■ 4500K   ■ 2700K

450 Lumens   180°   E14

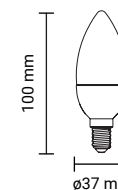

**LED Candle C37**  
**6W E14**

Watts	6W	CRI	Ra>80
Input Voltage	AC : 175-265V	IP Rating	IP20
Flux	480lm	Dimension	ø37x100 mm
Beam Angle	180°	Body Type	C37
Socket	E14	Dimmable	YES

SKU: 1464   SKU: 1465   SKU: 1463  
 ■ 6000K   ■ 4500K   ■ 2700K

480 Lumens   180°   E14

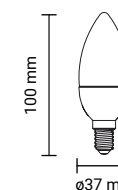

**LED Spot PAR30**  
**30W E27**

Watts	30W	CRI	Ra>80
Input Voltage	AC : 220-240V	IP Rating	IP20
Flux	2400lm	Dimension	ø95x130 mm
Beam Angle	30°	Body Type	PAR30
Socket	E27	Dimmable	NO

SKU: 1528   SKU: 1529   SKU: 1530  
 ■ 6000K   ■ 4500K   ■ 2700K

2400 Lumens   30°   E27

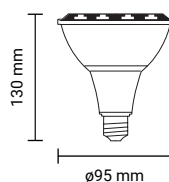

**LED Bulb Mosquito Zapper**  
**8W+2W E27**

Watts	8W+2W Zapper	CRI	Ra>80
Input Voltage	AC : 100-265V	IP Rating	IP20
Flux	640lm	Dimension	ø95x172 mm
Beam Angle	180°	Body Type	G95
Socket	E27	Dimmable	NO

SKU: 1819  
 ■ 4500K

640 Lumens   270°   E27

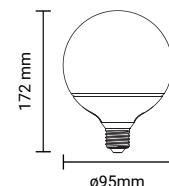





**LED Candle C37  
8W E14**

Watts	8W	CRI	Ra>80
Input Voltage	AC : 175-265V	IP Rating	IP20
Flux	710lm	Dimension	ø37x112 mm
Beam Angle	180°	Body Type	C37
Socket	E14	Dimmable	NO

SKU: 1428   SKU: 1429   SKU: 1430  
■ 6000K   ■ 4500K   ■ 2700K

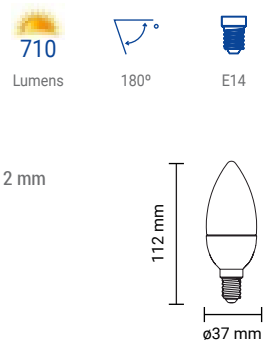

**LED Candle C37  
5.5W E14**

Watts	5.5W	CRI	Ra>80
Input Voltage	AC : 175-265V	IP Rating	IP20
Flux	450lm	Dimension	ø37x125 mm
Beam Angle	180°	Body Type	C37
Socket	E14	Dimmable	NO

SKU: 1435   SKU: 1436   SKU: 1437  
■ 6000K   ■ 4500K   ■ 2700K

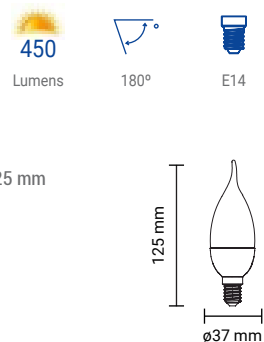

**LED Bulb P45  
5.5W E14**

Watts	5.5W	CRI	Ra>80
Input Voltage	AC : 220-240V	IP Rating	IP20
Flux	450lm	Dimension	ø45x78 mm
Beam Angle	240°	Body Type	P45
Socket	E14	Dimmable	NO

SKU: 1401   SKU: 1402   SKU: 1403  
■ 6000K   ■ 4500K   ■ 2700K

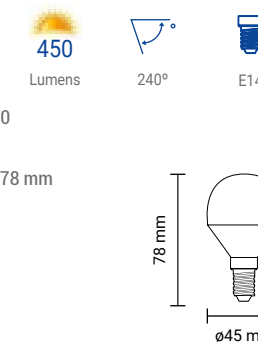

**LED Bulb P45  
8W E14**

Watts	8W	CRI	Ra>80
Input Voltage	AC : 220-240V	IP Rating	IP20
Flux	710lm	Dimension	ø45x78 mm
Beam Angle	240°	Body Type	P45
Socket	E14	Dimmable	NO

SKU: 1404   SKU: 1405   SKU: 1406  
■ 6000K   ■ 4500K   ■ 2700K

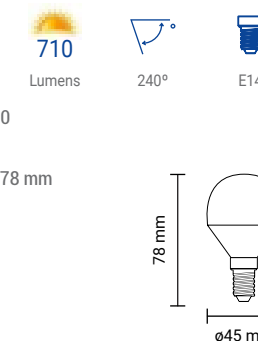

**LED Bulb P45  
8.5W E14**

Watts	8.5W	CRI	Ra>80
Input Voltage	AC : 175-265V	IP Rating	IP20
Flux	800lm	Dimension	ø45x78 mm
Beam Angle	240°	Body Type	P45
Socket	E14	Dimmable	NO

SKU: 1493   SKU: 1494   SKU: 1495  
■ 6000K   ■ 4500K   ■ 2700K

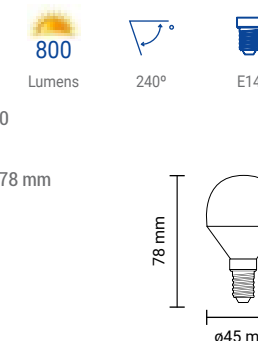

**LED Bulb R50  
6W E14**

Watts	6W	CRI	Ra>80
Input Voltage	AC : 175-265V	IP Rating	IP20
Flux	450lm	Dimension	ø50x85 mm
Beam Angle	200°	Body Type	R50
Socket	E14	Dimmable	NO

SKU: 1438   SKU: 1439   SKU: 1440  
■ 6000K   ■ 4500K   ■ 2700K

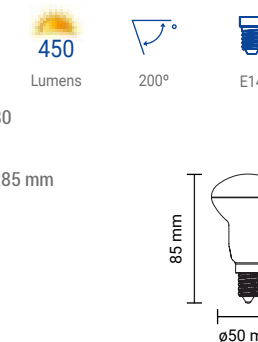





**LED Bulb A60 High Lumen  
9W B22**

Watts 9W  
Input Voltage AC : 220-240V  
Flux 820lm  
Beam Angle 270°  
Socket B22

SKU: 1918 6000K  
SKU: 1919 4500K  
SKU: 1920 2700K

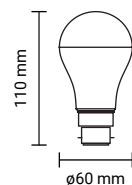
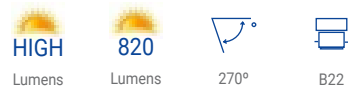
CRI Ra>80  
IP Rating IP20  
Dimension ø60x110 mm  
Body Type A60  
Dimmable NO

**LED Bulb A60  
10W B22**

Watts 10W  
Input Voltage AC : 220-240V  
Flux 800lm  
Beam Angle 270°  
Socket B22

SKU: 1910  
2700K

CRI Ra>80  
IP Rating IP20  
Dimension ø60x110 mm  
Body Type A60  
Dimmable YES

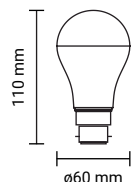
**LED Bulb A60 High Lumen  
11W B22**

Watts 11W  
Input Voltage AC : 220-240V  
Flux 1055lm  
Beam Angle 270°  
Socket B22

SKU: 1921 6000K  
SKU: 1922 4500K  
SKU: 1923 2700K

CRI Ra>80  
IP Rating IP20  
Dimension ø60x110 mm  
Body Type A60  
Dimmable NO

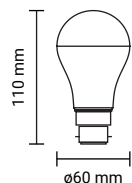
**LED Bulb A65  
12W B22**

Watts 12W  
Input Voltage AC : 220-240V  
Flux 960lm  
Beam Angle 270°  
Socket B22

SKU: 1914  
2700K

CRI Ra>80  
IP Rating IP20  
Dimension ø65x110 mm  
Body Type A65  
Dimmable YES

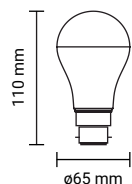
**LED Bulb A65  
15W B22**

Watts 15W  
Input Voltage AC : 220-240V  
Flux 1200lm  
Beam Angle 270°  
Socket B22

SKU: 1915 6000K  
SKU: 1916 4500K  
SKU: 1917 2700K

CRI Ra>80  
IP Rating IP20  
Dimension ø65x110 mm  
Body Type A65  
Dimmable NO

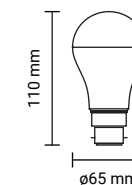
**LED Candle C37  
6W B22**

Watts 6W  
Input Voltage AC : 220-240V  
Flux 480lm  
Beam Angle 180°  
Socket B22

SKU: 1950 6000K  
SKU: 1951 4500K  
SKU: 1952 2700K

CRI Ra>80  
IP Rating IP20  
Dimension ø37x90 mm  
Body Type C37  
Dimmable NO

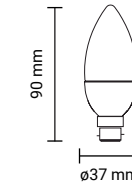
**LED Candle C37  
6W B22**

Watts 6W  
Input Voltage AC : 220-240V  
Flux 480lm  
Beam Angle 180°  
Socket B22

SKU: 1953  
2700K

CRI Ra>80  
IP Rating IP20  
Dimension ø37x90 mm  
Body Type C37  
Dimmable YES

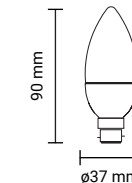
**LED Candle C37  
6W B15**

Watts 6W  
Input Voltage AC : 220-240V  
Flux 480lm  
Beam Angle 180°  
Socket B15

SKU: 1954 6000K  
SKU: 1955 4500K  
SKU: 1956 2700K

CRI Ra>80  
IP Rating IP20  
Dimension ø37x90 mm  
Body Type C37  
Dimmable NO

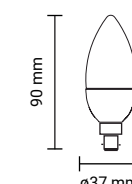
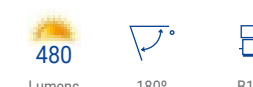



**LED Spotlight G4  
2W SMD**

Watts 2W  
Input Voltage AC;DC 12V  
Flux 170lm  
Beam Angle 360°  
Socket G4

SKU: 1615 6000K  
SKU: 1616 4500K  
SKU: 1617 2700K

CRI Ra>80  
IP Rating IP20  
Dimension ø10x30 mm  
Material Plastic  
Dimmable NO

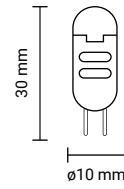

**LED Spotlight G4/MR11  
3W SMD**

Watts 3W  
Input Voltage AC;DC 12V  
Flux 210lm  
Beam Angle 38°  
Socket G4

SKU: 1066 6000K  
SKU: 1067 4500K  
SKU: 1068 2700K

CRI Ra>80  
IP Rating IP20  
Dimension ø35x45 mm  
Material Plastic  
Dimmable NO

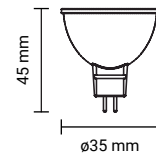

**LED Spotlight G9  
3W SMD**

Watts 3W  
Input Voltage AC:170-265V  
Flux 220lm  
Beam Angle 360°  
Socket G9

SKU: 1638 6000K  
SKU: 1639 4500K  
SKU: 1640 2700K

CRI Ra>80  
IP Rating IP20  
Dimension ø16x48 mm  
Material Plastic  
Dimmable NO

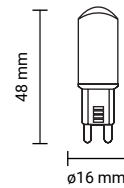

**LED Spotlight G9  
6W SMD**

Watts 6W  
Input Voltage AC:170-265V  
Flux 550lm  
Beam Angle 360°  
Socket G9

SKU: 1644 6000K  
SKU: 1645 4500K  
SKU: 1646 2700K

CRI Ra>80  
IP Rating IP20  
Dimension ø18x64 mm  
Material Plastic  
Dimmable YES

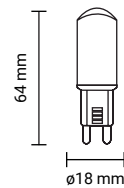

**LED Spotlight G9  
3.5W SMD**

Watts 3.5W  
Input Voltage AC:220-240V  
Flux 400lm  
Beam Angle 360°  
Socket G9

SKU: 1651 6000K  
SKU: 1652 4500K  
SKU: 1653 2700K

CRI Ra>80  
IP Rating IP20  
Dimension ø16x50 mm  
Material Ceramic  
Dimmable NO

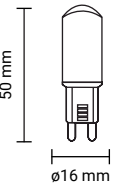

**LED Spotlight G9  
4W SMD**

Watts 4W  
Input Voltage AC:220-240V  
Flux 400lm  
Beam Angle 360°  
Socket G9

SKU: 1654 6000K  
SKU: 1655 4500K  
SKU: 1656 2700K

CRI Ra>80  
IP Rating IP20  
Dimension ø16x50 mm  
Material Ceramic  
Dimmable YES

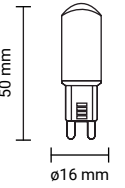

**LED Spotlight G5.3  
15W AR11**

Watts 15W  
Input Voltage AC ; DC 12V  
Flux 1050lm  
Beam Angle 30°  
Socket G5.3

SKU: 1517 4500K  
SKU: 1516 2700K

CRI Ra>80  
IP Rating IP20  
Dimension ø111x58 mm  
Material Plastic  
Dimmable NO

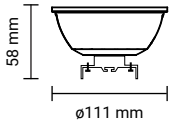

**LED Spotlight G5.3  
15W AR11**

Watts 15W  
Input Voltage AC ; DC 12V  
Flux 1050lm  
Beam Angle 120°  
Socket G5.3

SKU: 1519 4500K  
SKU: 1518 2700K

CRI Ra>80  
IP Rating IP20  
Dimension ø111x58 mm  
Material Plastic  
Dimmable NO

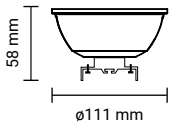





**LED Spotlight GU10  
9W AR111**

Watts	9W
Input Voltage	AC: 170-265V
Flux	820lm
Beam Angle	120°
Socket	GU10

SKU: 1531    SKU: 1532  
 4500K    2700K

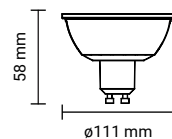
CRI	Ra>80
IP Rating	IP20
Dimension	ø111x58 mm
Material	Plastic
Dimmable	NO

**LED Spotlight GU10  
15W AR111**

Watts	15W
Input Voltage	AC: 170-265V
Flux	1200lm
Beam Angle	30°
Socket	GU10

SKU: 1533    SKU: 1534  
 4500K    2700K

CRI	Ra>80
IP Rating	IP20
Dimension	ø111x58 mm
Material	Aluminium
Dimmable	NO

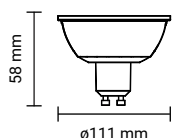
**LED Spotlight GU10  
15W AR111**

Watts	15W
Input Voltage	AC: 170-265V
Flux	1100lm
Beam Angle	30°
Socket	GU10

SKU: 1535    SKU: 1536  
 4500K    2700K

CRI	Ra>80
IP Rating	IP20
Dimension	ø111x58 mm
Material	Aluminium
Dimmable	YES

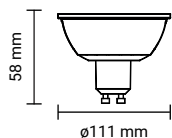
**LED Spotlight GX53  
7W Recessed**

Watts	7W
Input Voltage	AC:220-240V
Flux	560lm
Beam Angle	180°
Socket	GX53

SKU: 1541    SKU:1542    SKU: 1543  
 6000K    4500K    2700K

CRI	Ra>80
IP Rating	IP20
Dimension	ø74x25 mm
Material	Plastic
Dimmable	NO

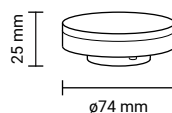
**LED Spotlight GU5.3/MR16  
5W SMD**

Watts	5W
Input Voltage	DC : 12V
Flux	400lm
Beam Angle	110°
Socket	GU5.3

SKU: 1191    SKU:1192    SKU: 1193  
 6000K    4500K    2700K

CRI	Ra>80
IP Rating	IP20
Dimension	ø50x47 mm
Material	Plastic
Dimmable	NO

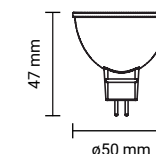
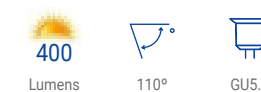
**LED Spotlight GU5.3/MR16  
7W SMD**

Watts	7W
Input Voltage	DC : 12V
Flux	600lm
Beam Angle	110°
Socket	GU5.3

SKU: 1194    SKU:1195    SKU: 1196  
 6000K    4500K    2700K

CRI	Ra>80
IP Rating	IP20
Dimension	ø50x47 mm
Material	Plastic
Dimmable	NO

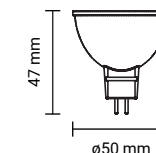
**LED Spotlight GU5.3/MR16  
4W COB**

Watts	4W
Input Voltage	AC;DC 12V
Flux	320lm
Beam Angle	50°
Socket	GU5.3

SKU: 1163    SKU:1167    SKU: 1164  
 6000K    4500K    2700K

CRI	Ra>80
IP Rating	IP20
Dimension	ø50x55 mm
Material	Plastic
Dimmable	NO

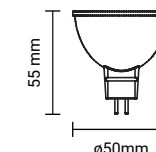
**LED Spotlight GU5.3/MR16  
6W COB**

Watts	6W
Input Voltage	AC;DC 12V
Flux	400lm
Beam Angle	50°
Socket	GU5.3

SKU: 1168    SKU:1169    SKU: 1170  
 6000K    4500K    2700K

CRI	Ra>80
IP Rating	IP20
Dimension	ø50x55 mm
Material	Plastic
Dimmable	NO

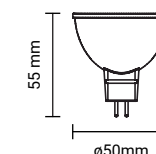
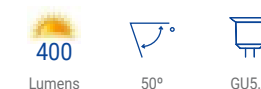



**LED Spotlight GU10  
4W COB**

Watts	4W	CRI	Ra>80
Input Voltage	AC : 220-240V	IP Rating	IP20
Flux	320lm	Dimension	ø50x55 mm
Beam Angle	50°	Body Color	White
Socket	GU10	Dimmable	NO

SKU: 1957   SKU:1958   SKU: 1959  
■ 6000K   ■ 4500K   ■ 2700K

**320**  
Lumens

50°

GU10

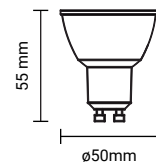

**LED Spotlight GU10  
6W COB**

Watts	6W	CRI	Ra>80
Input Voltage	AC : 220-240V	IP Rating	IP20
Flux	480lm	Dimension	ø50x55 mm
Beam Angle	50°	Body Color	White
Socket	GU10	Dimmable	NO

SKU: 1960   SKU:1961   SKU: 1962  
■ 6000K   ■ 4500K   ■ 2700K

**480**  
Lumens

50°

GU10

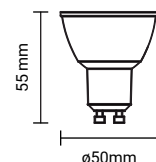

**LED Spotlight GU10  
6W COB**

Watts	6W	CRI	Ra>80
Input Voltage	AC : 220-240V	IP Rating	IP20
Flux	480lm	Dimension	ø50x55 mm
Beam Angle	50°	Body Color	White
Socket	GU10	Dimmable	YES

SKU: 1963   SKU:1964   SKU: 1965  
■ 6000K   ■ 4500K   ■ 2700K

**480**  
Lumens

Dimmable

GU10

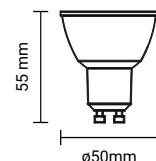

**LED Spotlight GU10  
4W COB**

Watts	4W	CRI	Ra>80
Input Voltage	AC : 220-240V	IP Rating	IP20
Flux	320lm	Dimension	ø50x60 mm
Beam Angle	50°	Body Color	Gray
Socket	GU10	Dimmable	NO

SKU: 1263   SKU:1264   SKU: 1265  
■ 6000K   ■ 4500K   ■ 2700K

**320**  
Lumens

50°

GU10

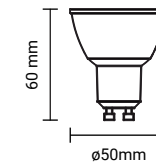

**LED Spotlight GU10  
4W COB**

Watts	4W	CRI	Ra>80
Input Voltage	AC : 220-240V	IP Rating	IP20
Flux	320lm	Dimension	ø50x60 mm
Beam Angle	50°	Body Color	Gray
Socket	GU10	Dimmable	YES

SKU: 1266   SKU:1267   SKU: 1268  
■ 6000K   ■ 4500K   ■ 2700K

**320**  
Lumens

Dimmable

GU10

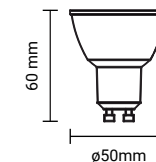

**LED Spotlight GU10  
6W COB**

Watts	6W	CRI	Ra>80
Input Voltage	AC : 220-240V	IP Rating	IP20
Flux	480lm	Dimension	ø50x60 mm
Beam Angle	50°	Body Color	Gray
Socket	GU10	Dimmable	NO

SKU: 1269   SKU:1270   SKU: 1271  
■ 6000K   ■ 4500K   ■ 2700K

**480**  
Lumens

50°

GU10

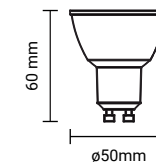

**LED Spotlight GU10  
6W COB**

Watts	6W	CRI	Ra>80
Input Voltage	AC : 220-240V	IP Rating	IP20
Flux	480lm	Dimension	ø50x60 mm
Beam Angle	50°	Body Color	Gray
Socket	GU10	Dimmable	YES

SKU: 1272   SKU:1273   SKU: 1274  
■ 6000K   ■ 4500K   ■ 2700K

**480**  
Lumens

Dimmable

GU10

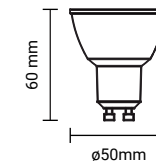



**LED Spotlight GU10  
4.5W SMD**

Watts	4.5W
Input Voltage	AC : 220-240V
Flux	320lm
Beam Angle	110°
Socket	GU10

SKU: 1901	SKU:1902	SKU: 1903
6000K	4500K	2700K

CRI	Ra>80
IP Rating	IP20
Dimension	ø50x57 mm
Material	Plastic
Dimmable	NO

  
320  
Lumens

  
110°

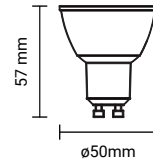
  
GU10

ø50mm

**LED Spotlight GU10  
5W SMD**

Watts	5W
Input Voltage	AC : 220-240V
Flux	400lm
Beam Angle	110°
Socket	GU10

SKU: 1929	SKU:1930	SKU: 1931
6000K	4500K	2700K

CRI	Ra>80
IP Rating	IP20
Dimension	ø50x57 mm
Material	Plastic
Dimmable	NO

  
400  
Lumens

  
110°

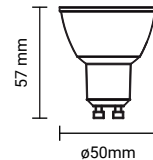
  
GU10

ø50mm

**LED Spotlight GU10  
5W SMD**

Watts	5W
Input Voltage	AC : 175-265V
Flux	400lm
Beam Angle	38°
Socket	GU10

SKU: 1935	SKU:1936	SKU: 1937
6000K	4500K	2700K

CRI	Ra>80
IP Rating	IP20
Dimension	ø50x57 mm
Material	Plastic
Dimmable	NO

  
400  
Lumens

  
38°

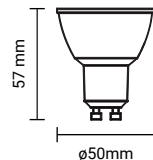
  
GU10

ø50mm

**LED Spotlight GU10  
6.5W SMD**

Watts	6.5W
Input Voltage	AC : 220-240V
Flux	550lm
Beam Angle	110°
Socket	GU10

SKU: 1904	SKU:1905	SKU: 1906
6000K	4500K	2700K

CRI	Ra>80
IP Rating	IP20
Dimension	ø50x57 mm
Material	Plastic
Dimmable	NO

  
550  
Lumens

  
110°

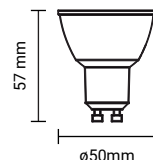
  
GU10

ø50mm

**LED Spotlight GU10  
7W SMD**

Watts	7W
Input Voltage	AC : 175-265V
Flux	600lm
Beam Angle	110°
Socket	GU10

SKU: 1932	SKU:1933	SKU: 1934
6000K	4500K	2700K

CRI	Ra>80
IP Rating	IP20
Dimension	ø50x57 mm
Material	Plastic
Dimmable	NO

  
600  
Lumens

  
110°

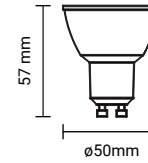
  
GU10

ø50mm

**LED Spotlight GU10  
7W SMD**

Watts	7W
Input Voltage	AC : 175-265V
Flux	560lm
Beam Angle	38°
Socket	GU10

SKU: 1938	SKU:1939	SKU: 1940
6000K	4500K	2700K

CRI	Ra>80
IP Rating	IP20
Dimension	ø50x57 mm
Material	Plastic
Dimmable	NO

  
560  
Lumens

  
38°

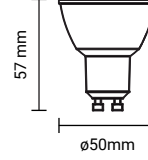
  
GU10

ø50mm

**LED Spotlight GU10  
7W SMD**

Watts	7W
Input Voltage	AC : 175-265V
Flux	560lm
Beam Angle	38°
Socket	GU10

SKU:1943
4500K

CRI	Ra>80
IP Rating	IP20
Dimension	ø50x57 mm
Material	Plastic
Dimmable	YES

  
Dimmable

  
560  
Lumens

  
38°

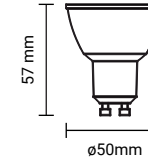
  
GU10

ø50mm





**LED Spotlight GU10**  
**7W SMD**

Watts 7W  
Input Voltage AC : 175-265V  
Flux 500lm  
Beam Angle 110°  
Socket GU10

SKU: 1945 6000K  
SKU: 1946 4500K  
SKU: 1947 2700K

CRI Ra>80  
IP Rating IP20  
Dimension ø50x57 mm  
Material Plastic  
Dimmable YES

Dimmable 500 Lumens 110° GU10

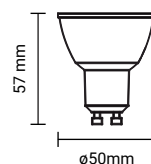

**LED Spotlight GU10**  
**9.5W SMD**

Watts 9.5W  
Input Voltage AC : 220-240V  
Flux 880lm  
Beam Angle 110°  
Socket GU10

SKU: 1907 6000K  
SKU: 1908 4500K  
SKU: 1909 2700K

CRI Ra>80  
IP Rating IP20  
Dimension ø50x57 mm  
Material Plastic  
Dimmable NO

880 Lumens 110° GU10

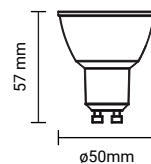

**LED Spotlight GU10**  
**10W SMD**

Watts 10W  
Input Voltage AC : 175-265V  
Flux 880lm  
Beam Angle 110°  
Socket GU10

SKU: 1970 6000K  
SKU: 1971 4500K  
SKU: 1972 2700K

CRI Ra>80  
IP Rating IP20  
Dimension ø50x57 mm  
Material Plastic  
Dimmable NO

880 Lumens 110° GU10

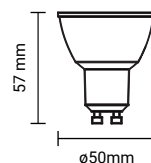

**PORTABLE LED SOLAR BULB**  
**Solar Panel Power: 6V 2.3W**

Voltage 6V  
Flux 650lm  
Beam Angle 360°  
Battery 3.2V 10Ah

CRI Ra>80  
IP Rating IP20  
Body Color White  
Dimension ø110x195 mm

SKU: 229  
6000K

650 Lumens IP20

Battery Solar Power





LED Bulbs Premium Line

5 Years

Warranty



5 Years

Warranty

**LED Bulb G95  
12W E27**

1055  
Lumens

270°

E27

Watts 12W  
Input Voltage AC : 175-265V  
Flux 1055lm  
Beam Angle 270°  
Socket E27

CRI Ra>80  
IP Rating IP20  
Dimension ø95x127 mm  
Body Type G95  
Dimmable NO

SKU: 1742   SKU:1743   SKU: 1744  
6000K   4500K   2700K

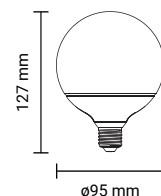

5 Years

Warranty

**LED Bulb G120  
15W E27**

1320  
Lumens

270°

E27

Watts 15W  
Input Voltage AC : 175-265V  
Flux 1320lm  
Beam Angle 270°  
Socket E27

CRI Ra>80  
IP Rating IP20  
Dimension ø120x155 mm  
Body Type G120  
Dimmable NO

SKU: 1745   SKU:1746   SKU: 1747  
6000K   4500K   2700K

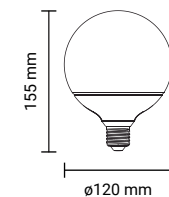

**LED Bulb A60  
10W E27**

950  
Lumens

5 Years

E27

Watts 10W  
Input Voltage AC : 175-265V  
Flux 950lm  
Beam Angle 270°  
Socket E27

CRI Ra>80  
IP Rating IP20  
Dimension ø60x109 mm  
Body Type A60  
Dimmable NO

SKU: 1718   SKU:1719   SKU: 1720  
6000K   4500K   2700K

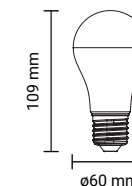

**LED Bulb A60  
12W E27**

1155  
Lumens

5 Years

E27

Watts 12W  
Input Voltage AC : 175-265V  
Flux 1155lm  
Beam Angle 270°  
Socket E27

CRI Ra>80  
IP Rating IP20  
Dimension ø60x112 mm  
Body Type A60  
Dimmable NO

SKU: 1721   SKU:1722   SKU: 1723  
6000K   4500K   2700K

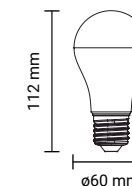

**LED Bulb A60  
15W E27**

1500  
Lumens

5 Years

E27

Watts 15W  
Input Voltage AC : 175-265V  
Flux 1500lm  
Beam Angle 270°  
Socket E27

CRI Ra>80  
IP Rating IP20  
Dimension ø60x127 mm  
Body Type A60  
Dimmable NO

SKU: 1724   SKU:1725   SKU: 1726  
6000K   4500K   2700K

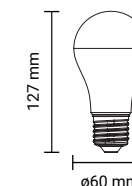

**LED Bulb A70  
18W E27**

1880  
Lumens

5 Years

E27

Watts 18W  
Input Voltage AC : 175-265V  
Flux 1880lm  
Beam Angle 270°  
Socket E27

CRI Ra>80  
IP Rating IP20  
Dimension ø70x145 mm  
Body Type A70  
Dimmable NO

SKU: 1748   SKU:1749   SKU: 1750  
6000K   4500K   2700K

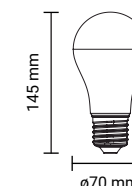



**5**  
Years  
Warranty

LED Spotlight GU5.3/MR16  
**5W SMD**

Watts 5W  
Input Voltage DC : 12V  
Flux 320lm  
Beam Angle 110°  
Socket GU5.3

CRI Ra>80  
IP Rating IP20  
Dimension ø50x47 mm  
Material Plastic  
Dimmable NO

SKU: 1761 6000K  
SKU: 1762 4500K  
SKU: 1763 2700K

**320**  
Lumens  
 110°  
 GU5.3

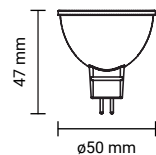

**5**  
Years  
Warranty

LED Spotlight GU5.3/MR16  
**7W SMD**

Watts 7W  
Input Voltage DC : 12V  
Flux 500lm  
Beam Angle 110°  
Socket GU5.3

CRI Ra>80  
IP Rating IP20  
Dimension ø50x47 mm  
Material Plastic  
Dimmable NO

SKU: 1764 6000K  
SKU: 1765 4500K  
SKU: 1766 2700K

**500**  
Lumens  
 110°  
 GU5.3

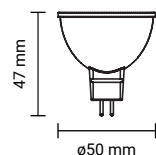

**5**  
Years  
Warranty

LED Spotlight GU10  
**5W SMD**

Watts 5W  
Input Voltage AC : 175-265V  
Flux 320lm  
Beam Angle 110°  
Socket GU10

CRI Ra>80  
IP Rating IP20  
Dimension ø50x57 mm  
Material Plastic  
Dimmable NO

SKU: 1767 6000K  
SKU: 1768 4500K  
SKU: 1769 2700K

**320**  
Lumens  
 110°  
 GU10

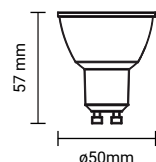

**5**  
Years  
Warranty

LED Spotlight GU10  
**7W SMD**

Watts 7W  
Input Voltage AC : 175-265V  
Flux 600lm  
Beam Angle 110°  
Socket GU10

CRI Ra>80  
IP Rating IP20  
Dimension ø50x57 mm  
Material Plastic  
Dimmable NO

SKU: 1772 6000K  
SKU: 1770 4500K  
SKU: 1773 2700K

**600**  
Lumens  
 110°  
 GU10

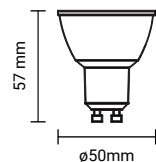

SKU: 5081 WHITE BODY  
Dimension 180x180x42 mm



SKU: 5083 WHITE BODY  
Dimension 330x180x42 mm

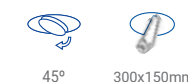

SKU: 5085 WHITE BODY  
Dimension 480x180x42 mm

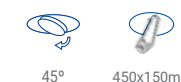

Accessories  
**AR111 Fitting Adjustable**

**2 PCS**  
BOX



SKU: 5082 SILVER BODY  
Dimension 180x180x42 mm



SKU: 5084 SILVER BODY  
Dimension 330x180x42 mm



SKU: 5086 SILVER BODY  
Dimension 480x180x42 mm

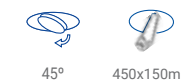

Accessories  
**AR111 Fitting Adjustable**

**2 PCS**  
BOX





SKU: 5070 WHITE BODY  
Dimension ø82x30 mm

SKU: 5071 INOX BODY  
Dimension ø82x30 mm

SKU: 5072 CHROME BODY  
Dimension ø82x30 mm

Accessories  
**GU10,MR16 Fitting**

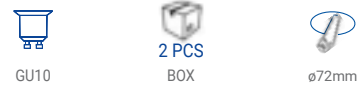

SKU: 5170 WHITE BODY Aluminium  
Dimension ø83x29 mm

SKU: 5171 INOX BODY Aluminium  
Dimension ø83x29 mm

SKU: 5172 CHROME BODY Aluminium  
Dimension ø83x29 mm

SKU: 5097 WHITE BODY  
Dimension ø83x29 mm

SKU: 5098 INOX BODY  
Dimension ø83x29 mm

SKU: 5099 CHROME BODY  
Dimension ø83x29 mm

Accessories  
**GU10,MR16 Fitting Adjustable**



SKU: 5073 WHITE BODY  
Dimension 83x83x30 mm

SKU: 5074 INOX BODY  
Dimension 83x83x30 mm

SKU: 5075 CHROME BODY  
Dimension 83x83x30 mm

Accessories  
**GU10,MR16 Fitting**



SKU: 5076 WHITE BODY  
Dimension ø83x29 mm

SKU: 5077 INOX BODY  
Dimension ø83x29 mm

SKU: 5078 CHROME BODY  
Dimension ø83x29 mm

Accessories  
**GU10,MR16 Fitting Adjustable**

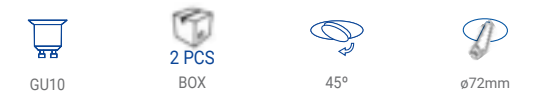

**Spotlight Fixture - Waterproof  
GU10 Fitting**

Product code	OT1-A2	IP Rating	IP65
Socket	GU10	Dimension	Φ80x54 ; 83x83x54 mm
Input Voltage	AC : 220-240V	Body Colors	White ; Satin Nickel
Material	Aluminium	Max Power	35W

**SKU: 2009** White Body - Round

**SKU: 2011** White Body - Square

**Spotlight Fixture - Aluminium  
GU10 Fitting**

Product code	OT1-A2	IP Rating	IP20
Socket	GU10	Dimension	φ79x32 mm
Input Voltage	AC : 220-240V	Body Colors	White
Material	Aluminium+PC	Max Power	35W

**SKU: 2048** Black Reflector

**SKU: 2047** White Reflector

**SKU: 2049** Rose Gold Reflector

**Spotlight Fixture - Waterproof  
GU10 Fitting**

Product code	OT1-A2	IP Rating	IP65
Socket	GU10	Dimension	Φ80x54 ; 83x83x54 mm
Input Voltage	AC : 220-240V	Body Colors	White ; Satin Nickel
Material	Aluminium	Max Power	35W

**SKU: 2010** Satin Nickel - Round

**SKU: 2012** Satin Nickel - Square

**Spotlight Fixture - Plastic  
GU10 Fitting**

Product code	OT1-A2	IP Rating	IP20
Socket	GU10	Dimension	102x102x42 mm
Input Voltage	AC : 220-240V	Body Colors	White,Black,White-Black
Material	Plastic	Max Power	35W

**SKU: 2050** White Body

**SKU: 2051** Black Body

**SKU: 2052** White-Black Body



**Spotlight Fixture - Aluminium**  
**2xGU10 Fitting Adjustable**

Product code	OT1-A2	IP Rating	IP20
Socket	2xGU10	Dimension	80x160x85
Input Voltage	AC : 220-240V	Body Colors	White-Black
Material	Aluminium	Max Power	35W

SKU: 2080 White- 2xGU10

SKU: 2081 Black- 2XGu10

**Spotlight Fixture - Aluminium**  
**GU10 Fitting Adjustable**

Product code	OT1-A2	IP Rating	IP20
Socket	GU10	Dimension	ø100x38 mm ;100x100x38mm
Input Voltage	AC : 220-240V	Body Colors	White-Black
Material	Aluminium	Max Power	35W

SKU: 2013 White/Black- Round

SKU: 2014 White/Black- Square

**Spotlight Fixture - Aluminium**  
**GU10 Fitting**

Product code	OT1-A2	IP Rating	IP20
Socket	GU10	Dimension	φ120x80mm;120x120x80mm
Input Voltage	AC : 220-240V	Body Colors	Black
Material	Aluminium	Max Power	35W

SKU: 2082 Black-Round

SKU: 2083 Black-Sqyare

**Spotlight Fixture - Aluminium**  
**GU10 Fitting Adjustable**

Product code	OT1-A2	IP Rating	IP20
Socket	GU10	Dimension	185x100x38mm , 270x100x38 mm
Input Voltage	AC : 220-240V	Body Colors	White-Black
Material	Aluminium	Max Power	35W

SKU: 2015 2xGU10 Holder

SKU: 2016 3xGU10 Holder

**Spotlight Fixture - Round  
GU10 Fitting**

Product code	OT1-A2	IP Rating	IP20
Socket	GU10	Dimension	φ80x42 mm
Input Voltage	AC : 220-240V	Body Colors	White ; Black
Material	Aluminium+PC	Max Power	35W

SKU: 2031 White  
SKU: 2032 Black

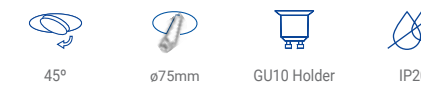
**Spotlight Fixture - Round  
GU10 Fitting**

Product code	OT1-A2	IP Rating	IP20
Socket	GU10	Dimension	φ80x42 mm
Input Voltage	AC : 220-240V	Body Colors	White ; Black
Material	Aluminium+PC	Max Power	35W

SKU: 2035 Round  
SKU: 2036 Black

**Spotlight Fixture - Round  
GU10 Fitting**

Product code	OT1-A2	IP Rating	IP20
Socket	GU10	Dimension	φ80x42 mm
Input Voltage	AC : 220-240V	Body Colors	White ; Black
Material	Aluminium+PC	Max Power	35W

SKU: 2033 White  
SKU: 2034 Black

**Spotlight Fixture - Round  
GU10 Fitting**

Product code	OT1-A2	IP Rating	IP20
Socket	GU10	Dimension	φ80x42 mm
Input Voltage	AC : 220-240V	Body Colors	White ; Black
Material	Aluminium+PC	Max Power	35W

SKU: 2037 White  
SKU: 2038 Black





Spotlight Fixture  
**GU10 Fitting**



Product code	OT1-A2	IP Rating	IP20
Socket	GU10	Dimension	75x75x140 mm
Input Voltage	AC : 220-240V	Body Colors	White
Material	Aluminium	Max Power	35W

- SKU: 2039 Black Reflector
- SKU: 2040 White Reflector
- SKU: 2041 Rose Gold Reflector



Spotlight Fixture -Plastic  
**GU10 Fitting Adjustable**



Product code	OT1-A2	IP Rating	IP20
Socket	GU10	Dimension	Φ80x125 mm
Input Voltage	AC : 220-240V	Body Colors	White ; Black
Material	Plastic	Max Power	10W

- SKU: 2001 White Body
- SKU: 2002 Black Body
- SKU: 2005 White Body
- SKU: 2006 Black Body



Spotlight Fixture  
**GU10 Fitting**



Product code	OT1-A2	IP Rating	IP20
Socket	GU10	Dimension	Φ80x140 mm
Input Voltage	AC : 220-240V	Body Colors	White
Material	Aluminium	Max Power	35W

- SKU: 2042 Black Reflector
- SKU: 2043 White Reflector
- SKU: 2044 Rose Gold Reflector



Spotlight Fixture -Plastic  
**GU10 Fitting Adjustable**



Product code	OT1-A2	IP Rating	IP20
Socket	GU10	Dimension	85x85x130 mm
Input Voltage	AC : 220-240V	Body Colors	White ; Black
Material	Plastic	Max Power	10W

- SKU: 2003 White Body
- SKU: 2004 Black Body
- SKU: 2007 White Body
- SKU: 2008 Black Body



Spotlight Fixture - Aluminium  
**GU10 Fitting Adjustable**



Product code	OT1-A2	IP Rating	IP20
Socket	GU10	Dimension	φ80x42 mm
Input Voltage	AC : 220-240V	Body Colors	White ; Black
Material	Aluminium+PC	Max Power	35W

SKU: 2027 White Body  
 SKU: 2028 Black Body



Tracklight Fixture -Aluminium  
**GU10 Fitting Adjustable  
 For 3-Phase Track**



Product code	OT1-A2	IP Rating	IP20
Socket	GU10	Dimension	φ55x82 mm
Input Voltage	AC : 220-240V	Body Colors	White ; Black
Material	Aluminium	Max Power	35W

SKU: 2017 White Body  
 SKU: 2018 Black Body



Spotlight Fixture - Aluminium  
**GU10 Fitting**



Product code	OT1-A2	IP Rating	IP20
Socket	GU10	Dimension	φ60x100 mm
Input Voltage	AC : 220-240V	Body Colors	White ; Black
Material	Aluminium+PC	Max Power	35W

SKU: 2029 White Body  
 SKU: 2030 Black Body



Tracklight Fixture -Plastic  
**GU10 Fitting Adjustable  
 For Single-Phase Track**



Product code	OT1-A2	IP Rating	IP20
Socket	GU10	Dimension	φ59x94x114 mm
Input Voltage	AC : 220-240V	Body Colors	White ; Black
Material	Plastic	Max Power	10W

SKU: 2019 White Body  
 SKU: 2020 Black Body



**Spotlight Fixture - Plastic  
GU10 Fitting**

90°



GU10 Holder



IP20

Product code	OT1-A2	IP Rating	IP20
Socket	GU10	Dimension	φ120x145 mm
Input Voltage	AC : 220-240V	Body Colors	White ; Black
Material	Plastic	Max Power	10W

SKU: 2021 White  
SKU: 2022 Black

**Spotlight Fixture - Plastic  
GU10 Fitting**

90°



GU10 Holder



IP20

Product code	OT1-A2	IP Rating	IP20
Socket	GU10	Dimension	φ120x145 mm
Input Voltage	AC : 220-240V	Body Colors	White ; Black
Material	Plastic	Max Power	10W Each

SKU: 2025 White  
SKU: 2026 Black



75x75mm



φ85mm

**Spotlight Fixture - Plastic  
GU10 Fitting**

90°



GU10 Holder



IP20

Product code	OT1-A2	IP Rating	IP20
Socket	GU10	Dimension	φ120x145 mm
Input Voltage	AC : 220-240V	Body Colors	White ; Black
Material	Plastic	Max Power	10W Each

SKU: 2023 Round  
SKU: 2024 Square

**Spotlight Fixture - Recessed  
GU10 Fitting**



GU10 Holder



IP20

Product code	OT1-A2	IP Rating	IP20
Socket	GU10	Dimension	75x75x55mm ; φ85x50mm
Input Voltage	AC : 220-240V	Body Colors	White - Black Reflektor
Material	Aluminium+PC	Max Power	35W

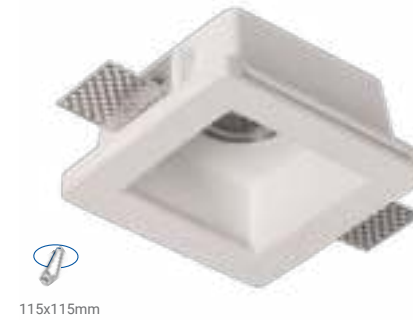
SKU: 2045 Square  
SKU: 2046 Round



## Ceiling Fixture Trimless Recessed

**GU10 Fitting**  
**Gypsum + ALU**

Product code	OT1-A2	IP Rating	IP20
Socket	GU10	Dimension	φ100x27mm ; 100x100x27mm
Input Voltage	AC : 220-240V	Body Colors	White
Material	Gypsum+Alu	Max Power	35W

SKU: 2060 Round  
 SKU: 2061 Square

## Ceiling Fixture Trimless Recessed

**GU10 Fitting**  
**Gypsum + ALU**

Product code	OT1-A2	IP Rating	IP20
Socket	GU10	Dimension	120x120x60mm ; 215x118x58mm
Input Voltage	AC : 220-240V	Body Colors	White
Material	Gypsum+Alu	Max Power	35W

SKU: 2064 Square  
 SKU: 2065 Rectangle



## Ceiling Fixture Trimless Recessed

**GU10 Fitting**  
**Gypsum + ALU**

Product code	OT1-A2	IP Rating	IP20
Socket	GU10	Dimension	φ130x50mm ; 120x120x60mm
Input Voltage	AC : 220-240V	Body Colors	White
Material	Gypsum+Alu	Max Power	35W

SKU: 2062 Round  
 SKU: 2063 Square

## Ceiling Fixture Trimless Recessed

**GU10 Fitting**  
**Gypsum + ALU**

Product code	OT1-A2	IP Rating	IP20
Socket	GU10	Dimension	120x120x60mm ; 215x118x58mm
Input Voltage	AC : 220-240V	Body Colors	White
Material	Gypsum+Alu	Max Power	35W

SKU: 2066 Round  
 SKU: 2067 Square





ø125mm Frosted Glass



ø125mm

Ceiling Fixture Trimless Recessed

**GU10 Fitting**  
**Gypsum + ALU**

Product code	OT1-A2	IP Rating	IP20
Socket	GU10	Dimension	φ120x65mm
Input Voltage	AC : 220-240V	Body Colors	White
Material	Gypsum+Alu	Max Power	35W



GU10 Holder IP20

SKU: 2068 Round-Frosted  
 SKU: 2069 Round



Ceiling Fixture Surface Mounted

**GU10 Fitting**  
**Gypsum + ALU**

Product code	OT1-A2	IP Rating	IP20
Socket	GU10	Dimension	70x70x70mm ; 70x70x170mm
Input Voltage	AC : 220-240V	Body Colors	White
Material	Gypsum+Alu	Max Power	35W



GU10 Holder IP20

SKU: 2072 Square H70  
 SKU: 2073 Square H170



Ceiling Fixture Surface Mounted

**GU10 Fitting**  
**Gypsum + ALU**

Product code	OT1-A2	IP Rating	IP20
Socket	GU10	Dimension	φ70x70 mm ; φ70x170 mm
Input Voltage	AC : 220-240V	Body Colors	White
Material	Gypsum+Alu	Max Power	35W



GU10 Holder IP20

SKU: 2070 Round H70mm  
 SKU: 2071 Round H170mm



Ceiling Fixture Surface Mounted

**GU10 Fitting**  
**Gypsum + ALU**

Product code	OT1-A2	IP Rating	IP20
Socket	GU10	Dimension	φ110x140mm ; 110x110x140mm
Input Voltage	AC : 220-240V	Body Colors	White
Material	Gypsum+Alu	Max Power	35W



GU10 Holder IP20

SKU: 2074 Round  
 SKU: 2075 Square



**Spotlight Fixture - Single Head**  
**GU10 Fitting**

90°



GU10 Holder



IP20

Product code	OT1-A6	IP Rating	IP20
Socket	GU10	Dimension	60x108 mm
Input Voltage	AC : 220-240V	Body Colors	Black ; White
Material	Aluminium	Max Power	35W

SKU: 9072 Black  
 SKU: 9076 White

**Spotlight Fixture - Three Heads**  
**GU10 Fitting**

90°



GU10 Holder



IP20

Product code	OT1-A6	IP Rating	IP20
Socket	GU10x3	Dimension	540x60x180 mm
Input Voltage	AC : 220-240V	Body Colors	Black ; White
Material	Aluminium	Max Power	35W Each

SKU: 9074 Black GU10x3  
 SKU: 9078 White GU10x3

**Spotlight Fixture - Two Heads**  
**GU10 Fitting**

90°



GU10 Holder



IP20

Product code	OT1-A6	IP Rating	IP20
Socket	GU10x2	Dimension	300x60x180mm
Input Voltage	AC : 220-240V	Body Colors	Black ; White
Material	Aluminium	Max Power	35W Each

SKU: 9073 Black GU10x2  
 SKU: 9077 White GU10x2

**Spotlight Fixture - Four Heads**  
**GU10 Fitting**

90°



GU10 Holder



IP20

Product code	OT1-A6	IP Rating	IP20
Socket	GU10x4	Dimension	720x60x180 mm
Input Voltage	AC : 220-240V	Body Colors	Black ; White
Material	Aluminium	Max Power	35W Each

SKU: 9075 Black GU10x4  
 SKU: 9079 White GU10x4





Hanging Fixture - H300mm  
**GU10 Fitting**



GU10 Holder

IP20

Product code	OT1-A6	IP Rating	IP20
Socket	GU10	Dimension	60x300 mm
Input Voltage	AC : 220-240V	Body Colors	Black ; White
Material	Aluminium	Max Power	35W

SKU: 9050	Black - Inner range: Gold
SKU: 9051	Black - Inner range: Black
SKU: 9054	White - Inner range: Gold
SKU: 9055	White - Inner range: Black



Hanging Fixture - H500mm  
**GU10 Fitting**



GU10 Holder

IP20

Product code	OT1-A6	IP Rating	IP20
Socket	GU10	Dimension	60x500 mm
Input Voltage	AC : 220-240V	Body Colors	Black ; White
Material	Aluminium	Max Power	35W

SKU: 9058	Black Body
SKU: 9059	White Body



Hanging Fixture - H500mm  
**GU10 Fitting**



GU10 Holder

IP20

Product code	OT1-A6	IP Rating	IP20
Socket	GU10	Dimension	60x500 mm
Input Voltage	AC : 220-240V	Body Colors	Black ; White
Material	Aluminium	Max Power	35W

SKU: 9052	Black - Inner range: Gold
SKU: 9053	Black - Inner range: Black
SKU: 9056	White - Inner range: Gold
SKU: 9057	White - Inner range: Black



Hanging Fixture - H200mm  
**GU10 Fitting**



GU10 Holder

IP20

Product code	OT1-A6	IP Rating	IP20
Socket	GU10	Dimension	60x200 mm
Input Voltage	AC : 220-240V	Body Colors	Black ; White
Material	Aluminium	Max Power	35W

SKU: 9060	Black Body
SKU: 9061	White Body



Hanging Fixture - H300mm  
**GU10 Fitting**



Product code	OT1-A6	IP Rating	IP20
Socket	GU10	Dimension	55x300 mm
Input Voltage	AC : 220-240V	Body Colors	B/W/G/CG/C
Material	Aluminium	Max Power	35W

- SKU: 9062 Black Body
- SKU: 9063 White Body
- SKU: 9064 Gold Body
- SKU: 9065 Coffee Gold Body
- SKU: 9066 Chrome Body

Hanging Fixture - H300mm  
**GU10 Fitting**



Product code	OT1-A6	IP Rating	IP20
Socket	GU10	Dimension	55x300 mm
Input Voltage	AC : 220-240V	Body Colors	B/W/G/CG/C
Material	Aluminium	Max Power	35W

- SKU: 9067 Black Body
- SKU: 9068 White Body
- SKU: 9069 Gold Body
- SKU: 9070 Coffee Gold Body
- SKU: 9071 Chrome Body





Hanging Fixture - H400mm  
**GU10 Fitting**



Product code	OT1-A6	IP Rating	IP20
Socket	GU10	Dimension	60x400 mm
Input Voltage	AC : 220-240V	Body Colors	B/W/S/GR
Material	Aluminium	Max Power	35W

SKU: 9082	Black Body
SKU: 9083	White Body
SKU: 9080	Silver Body
SKU: 9081	Grape Red Body

Hanging Fixture - H400mm  
**E27 Fitting**

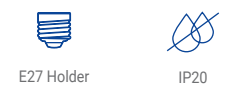

Product code	OT1-A6	IP Rating	IP20
Socket	E27	Dimension	40x400 mm
Input Voltage	AC : 220-240V	Body Colors	B/W/CG/RG
Material	Aluminium	Max Power	35W

SKU: 9084	Black Body
SKU: 9085	White Body
SKU: 9086	Coffee Gold Body
SKU: 9087	Rose Gold Body



LED tubes are the perfect replacement for old fluorescent tubes. With variety of sizes, powers and colour temperatures they are suitable for every need – from home use to office or warehouses.

**Features:**

- Up to 80% power saving
- Standard sizes, fits already built lighting solutions
- Variety of colour temperatures
- Single or two side power
- Build-in starters
- Variety of covers – from nano-plastic to glass

**Application:**

- Indoor use – home, offices, shops
- Main lighting
- Suitable for tube fixtures

## LED TUBES AND BATTEN LIGHTS







Switch



LED TUBE T5 - Plastic  
**Matt With Switch**



120°



IP20

**3.4W**



Watts	3.4W	Beam Angle	120°
Input Voltage	AC : 220-240V	CRI	Ra>80
Flux	300lm	IP Rating	IP20

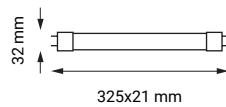

SKU: 5588	SKU:5589	SKU: 5590
6000K	4000K	3000K

**6.5W**



Watts	6.5W	Beam Angle	120°
Input Voltage	AC : 220-240V	CRI	Ra>80
Flux	600lm	IP Rating	IP20

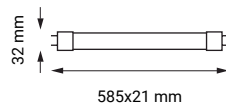

SKU: 5591	SKU:5592	SKU: 5593
6000K	4000K	3000K

**9.6W**



Watts	9.6W	Beam Angle	120°
Input Voltage	AC : 220-240V	CRI	Ra>80
Flux	900lm	IP Rating	IP20

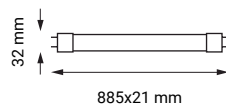

SKU: 5594	SKU:5595	SKU: 5596
6000K	4000K	3000K

**13W**



Watts	13W	Beam Angle	120°
Input Voltage	AC : 220-240V	CRI	Ra>80
Flux	1200lm	IP Rating	IP20

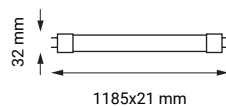

SKU: 5597	SKU:5598	SKU: 5599
6000K	4000K	3000K



T5 DOUBLE INPUT CABLE

Not Included

Length: 30cm / 50cm / 100cm



LED TUBE T5 - Plastic  
**Matt**



120°



IP20

**3.4W**



Watts	3.4W	Beam Angle	120°
Input Voltage	AC : 220-240V	CRI	Ra>80
Flux	300lm	IP Rating	IP20

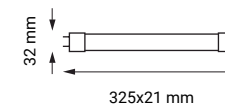

SKU: 5501	SKU:5502	SKU: 5503
6000K	4000K	3000K

**6.5W**



Watts	6.5W	Beam Angle	120°
Input Voltage	AC : 220-240V	CRI	Ra>80
Flux	600lm	IP Rating	IP20

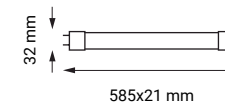

SKU: 5504	SKU:5505	SKU: 5506
6000K	4000K	3000K

**9.6W**



Watts	9.6W	Beam Angle	120°
Input Voltage	AC : 220-240V	CRI	Ra>80
Flux	900lm	IP Rating	IP20

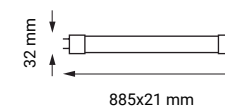

SKU: 5507	SKU:5508	SKU: 5509
6000K	4000K	3000K

**13W**



Watts	13W	Beam Angle	120°
Input Voltage	AC : 220-240V	CRI	Ra>80
Flux	1200lm	IP Rating	IP20



SKU: 5538	SKU:5539	SKU: 5540
6000K	4000K	3000K

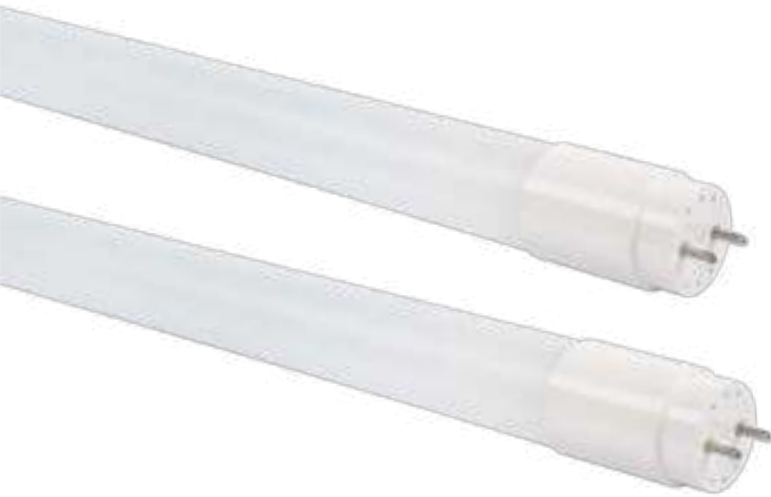

With Starter



Rotatable

LED TUBE T8 **PF>0.9****High Lumen****Nano Plastic - One Side Power**

 5  
 Years  
 Warranty

 160  
 Lumen/W



 HIGH  
 Lumens

270°

IP20

**7W**1140  
Lumens

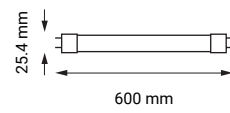
Product code	TU7-A3	Beam Angle	270°
Watts	7W	CRI	Ra>80
Input Voltage	AC : 175-250V	IP Rating	IP20
Flux	1140lm	Instant Start	<0.5s

 SKU: 5541   SKU: 5542   SKU: 5543  
 6000K   4500K   2800K

With Starter



Rotatable

LED TUBE T8 **PF>0.9****Nano Plastic - One Side Power**

 5  
 Years  
 Warranty



 HIGH  
 Lumens

270°

IP20

**9W**900  
Lumens

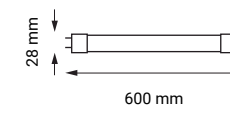
Product code	TU9-A3	Beam Angle	270°
Watts	9W	CRI	Ra>80
Input Voltage	AC : 175-250V	IP Rating	IP20
Flux	900lm	Instant Start	<0.5s

 SKU: 5511   SKU: 5512   SKU: 5513  
 6000K   4500K   2800K
**12W**1920  
Lumens

Product code	TU12-A3	Beam Angle	270°
Watts	12W	CRI	Ra>80
Input Voltage	AC : 175-250V	IP Rating	IP20
Flux	1920lm	Instant Start	<0.5s

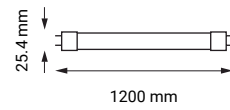
 SKU: 5544   SKU: 5545   SKU: 5546  
 6000K   4500K   2800K
**18W**1800  
Lumens

Product code	TU18-A3	Beam Angle	270°
Watts	18W	CRI	Ra>80
Input Voltage	AC : 175-240V	IP Rating	IP20
Flux	1800lm	Instant Start	<0.5s

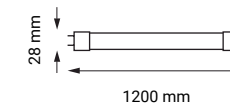
 SKU: 5514   SKU: 5515   SKU: 5516  
 6000K   4500K   2800K
**16W**2560  
Lumens

Product code	TU16-A3	Beam Angle	270°
Watts	16W	CRI	Ra>80
Input Voltage	AC : 175-250V	IP Rating	IP20
Flux	2560lm	Instant Start	<0.5s

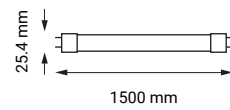
 SKU: 5547   SKU: 5548   SKU: 5549  
 6000K   4500K   2800K
**22W**2400  
Lumens

Product code	TU22-A3	Beam Angle	270°
Watts	22W	CRI	Ra>80
Input Voltage	AC : 175-250V	IP Rating	IP20
Flux	2400lm	Instant Start	<0.5s

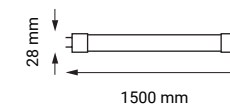
 SKU: 5517   SKU: 5518   SKU: 5519  
 6000K   4500K   2800K



LED TUBE T8 **PF>0.9****PRO - Line****Glass - One Side Power****9W**1000  
Lumens

Product code	TU9-A4	Beam Angle	270°
Watts	9W	CRI	Ra>80
Input Voltage	AC : 175-265V	IP Rating	IP20
Flux	1000lm	Instant Start	<0.5s

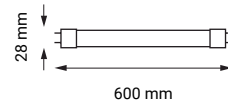
 SKU: 5614    SKU:5615  
 6000K    4500K
LED TUBE T8 **PF>0.9****City Line****Glass - One Side Power****9W**900  
Lumens

Product code	TU9-A2	Beam Angle	270°
Watts	9W	CRI	Ra>80
Input Voltage	AC : 175-265V	IP Rating	IP20
Flux	800lm	Instant Start	<0.5s

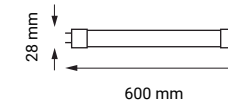
 SKU: 5601    SKU:5602    SKU: 5603  
 6000K    4500K    2800K
**18W**2100  
Lumens

Product code	TU18-A4	Beam Angle	270°
Watts	18W	CRI	Ra>80
Input Voltage	AC : 175-265V	IP Rating	IP20
Flux	2100lm	Instant Start	<0.5s

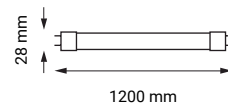
 SKU: 5617    SKU:5618  
 6000K    4500K
**18W**1800  
Lumens

Product code	TU18-A2	Beam Angle	270°
Watts	18W	CRI	Ra>80
Input Voltage	AC : 175-265V	IP Rating	IP20
Flux	1600lm	Instant Start	<0.5s

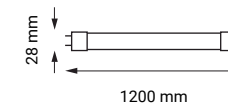
 SKU: 5604    SKU:5605    SKU: 5606  
 6000K    4500K    2800K
**24W**2800  
Lumens

Product code	TU24-A1	Beam Angle	270°
Watts	24W	CRI	Ra>80
Input Voltage	AC : 175-265V	IP Rating	IP20
Flux	3000lm	Instant Start	<0.5s

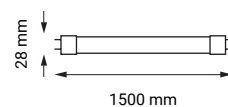
 SKU: 5610    SKU:5611  
 6000K    4500K
**22W**2200  
Lumens

Product code	TU22-A2	Beam Angle	270°
Watts	22W	CRI	Ra>80
Input Voltage	AC : 175-265V	IP Rating	IP20
Flux	2560lm	Instant Start	<0.5s

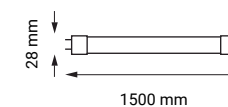
 SKU: 5607    SKU:5608    SKU: 5609  
 6000K    4500K    2800K



With Starter

**LED TUBE T8 PF>0.9**  
**Professional edition**  
**Aluminium-One Side Power**

**9W**  
**810**  
 Lumens

Product code	TU9-A1	Beam Angle	140°
Watts	9W	CRI	Ra>80
Input Voltage	AC : 175-265V	IP Rating	IP20
Flux	810lm	Instant Start	<0.5s

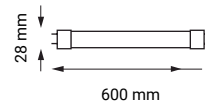
 SKU: 5611-M 6000K  
 SKU: 5613-M 4500K  
 SKU: 5612-M 2800K

**18W**  
**1440**  
 Lumens

Product code	TU18-A1	Beam Angle	140°
Watts	18W	CRI	Ra>80
Input Voltage	AC : 175-265V	IP Rating	IP20
Flux	1440lm	Instant Start	<0.5s

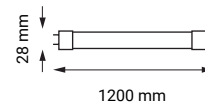
 SKU: 5623-M 6000K  
 SKU: 5624-M 2800K

**22W**  
**1700**  
 Lumens

Product code	TU22-A1	Beam Angle	140°
Watts	22W	CRI	Ra>80
Input Voltage	AC : 175-265V	IP Rating	IP20
Flux	1700lm	Instant Start	<0.5s

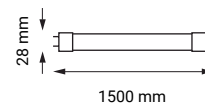
 SKU: 5643-M  
 2800K

**LED TUBE T8**  
**Home edition**  
**Glass - One Side Power**

**9W**  
**720**  
 Lumens

Product code	TU9-A2	Beam Angle	270°
Watts	9W	CRI	Ra>80
Input Voltage	AC : 175-265V	IP Rating	IP20
Flux	720lm	Instant Start	<0.5s

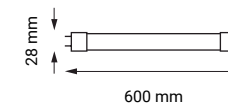
 SKU: 5626 6000K  
 SKU: 5627 4000K

**18W**  
**1440**  
 Lumens

Product code	TU18-A2	Beam Angle	270°
Watts	18W	CRI	Ra>80
Input Voltage	AC : 175-265V	IP Rating	IP20
Flux	1440lm	Instant Start	<0.5s

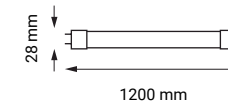
 SKU: 5629 6000K  
 SKU: 5630 4000K





M12 cable gland



LED FIXTURES WITH T8 TUBES

**Single City Line - Glass PF>0.9**  
**One Side Power**



<b>9W</b>	Product code	OT1-A9	Beam Angle	180°
<b>800</b> Lumens	Watts	9W	CRI	Ra>80
	Input Voltage	AC : 220-240V	IP Rating	IP65
	Flux	800lm	Instant Start	<0.5s

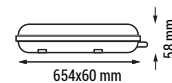

SKU: 6731 6000K  
SKU: 6732 4500K

<b>18W</b>	Product code	OT1-A9	Beam Angle	180°
<b>1600</b> Lumens	Watts	18W	CRI	Ra>80
	Input Voltage	AC : 220-240V	IP Rating	IP65
	Flux	1600lm	Instant Start	<0.5s



SKU: 6735 6000K  
SKU: 6736 4500K

<b>22W</b>	Product code	OT1-A9	Beam Angle	180°
<b>2000</b> Lumens	Watts	22W	CRI	Ra>80
	Input Voltage	AC : 220-240V	IP Rating	IP65
	Flux	2000lm	Instant Start	<0.5s



SKU: 6739 6000K  
SKU: 6740 4500K

Single T8 Tube Fixture - Without Tubes  
**For One Side Power**

SKU: 6650 For Single LED Tube 9W-60cm

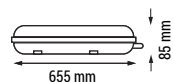

SKU: 6652 For Single LED Tube 18W-120cm

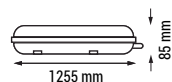

SKU: 6654 For Single LED Tube 22W-150cm

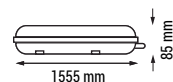

LED FIXTURES WITH T8 TUBES

**Double City Line - Glass PF>0.9**  
**One Side Power**



<b>2*9W</b>	Product code	OT1-B1	Beam Angle	180°
<b>1600</b> Lumens	Watts	2*9W	CRI	Ra>80
	Input Voltage	AC : 220-240V	IP Rating	IP65
	Flux	1600lm	Instant Start	<0.5s

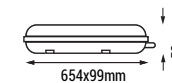

SKU: 6733 6000K  
SKU: 6734 4500K

<b>2*18W</b>	Product code	OT1-B1	Beam Angle	180°
<b>3200</b> Lumens	Watts	2*18W	CRI	Ra>80
	Input Voltage	AC : 220-240V	IP Rating	IP65
	Flux	3200lm	Instant Start	<0.5s



SKU: 6737 6000K  
SKU: 6738 4500K

<b>2*22W</b>	Product code	OT1-B1	Beam Angle	180°
<b>4000</b> Lumens	Watts	2*22W	CRI	Ra>80
	Input Voltage	AC : 220-240V	IP Rating	IP65
	Flux	4000lm	Instant Start	<0.5s

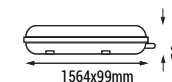

SKU: 6741 6000K  
SKU: 6742 4500K

Double T8 Tube Fixture - Without Tubes  
**For One Side Power**

SKU: 6651 For Two LED Tube 9W-60cm

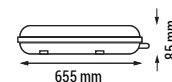

SKU: 6653 For Two LED Tube 18W-120cm

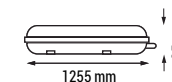

SKU: 6655 For Two LED Tube 22W-150cm

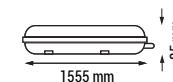



M12 cable gland



Stainless steel clips

**40W LED**  
IP65 Fixture Type  
**Stainless steel clips**

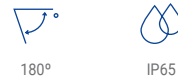
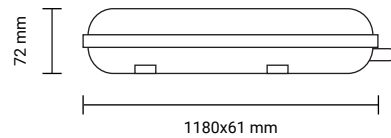

<b>40W</b> <b>4000</b> Lumens	Product code	OT40-A1	Beam Angle	180°
	Watts	40W	CRI	Ra>80
	Input Voltage	AC : 220-240V	IP Rating	IP65
	Flux	4000lm	Instant Start	<0.5s

SKU: 6701    SKU:6702  
6000K    4500K



M12 cable gland



Stainless steel clips

**55W LED**  
IP65 Fixture Type  
**Stainless steel clips**

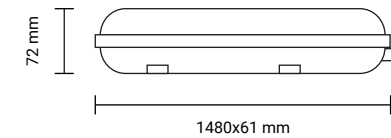

<b>55W</b> <b>6000</b> Lumens	Product code	OT55-A1	Beam Angle	180°
	Watts	55W	CRI	Ra>80
	Input Voltage	AC : 220-240V	IP Rating	IP65
	Flux	6000lm	Instant Start	<0.5s

SKU: 6703    SKU:6704  
6000K    4500K

<b>40W</b> <b>4000</b> Lumens	Product code	OT40-A1	Beam Angle	180°
	Watts	40W	CRI	Ra>80
	Input Voltage	AC : 220-240V	IP Rating	IP65
	Flux	4000lm	Instant Start	<0.5s



SKU: 6705    SKU:6706  
6000K    4500K

<b>55W</b> <b>6000</b> Lumens	Product code	OT55-A1	Beam Angle	180°
	Watts	55W	CRI	Ra>80
	Input Voltage	AC : 220-240V	IP Rating	IP65
	Flux	6000lm	Instant Start	<0.5s



SKU: 6707    SKU:6708  
6000K    4500K

<b>40W</b> <b>4000</b> Lumens	Product code	TU40-A1	Beam Angle	180°
	Watts	40W	CRI	Ra>80
	Input Voltage	AC : 220-240V	IP Rating	IP65
	Flux	4000lm	Instant Start	<0.5s



SKU: 6709    SKU:6710  
6000K    4500K

<b>55W</b> <b>6000</b> Lumens	Product code	OT55-A1	Beam Angle	180°
	Watts	55W	CRI	Ra>80
	Input Voltage	AC : 220-240V	IP Rating	IP65
	Flux	6000lm	Instant Start	<0.5s



SKU: 6711    SKU:6712  
6000K    4500K



**Single T8 Fixture  
for LED One Side Power Tube**

Product code	OT1-A7	IP Rating	IP20
Socket	T8	Dimension	606x33mm;1250x33mm
Input Voltage	AC : 220-240V	Body Colors	White
Material	Metal+PC	Max Power	100W

SKU: 6745 1xT8-60cm Tube  
SKU: 6746 1xT8-120cm Tube

**Double T8 Fixture  
for LED One Side Power Tube**



Product code	OT1-A7	IP Rating	IP20
Socket	2xT8	Dimension	606x73mm;1250x73mm
Input Voltage	AC : 220-240V	Body Colors	White
Material	Metal+PC	Max Power	100W

SKU: 6747 2xT8-60cm Tube  
SKU: 6748 2xT8-120cm Tube

**LED Batten Light PF>0.9  
Stainless steel clips**

**10W**  
1150  
Lumens

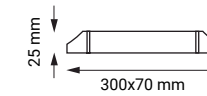
Product code	OT10-A2	Beam Angle	120°
Watts	10W	CRI	Ra>80
Input Voltage	AC : 220-240V	IP Rating	IP20
Flux	1150lm	Instant Start	<0.5s



SKU: 6671 6000K  
SKU: 6672 4000K  
SKU: 6673 2800K

**20W**  
2300  
Lumens

Product code	OT20-A1	Beam Angle	120°
Watts	20W	CRI	Ra>80
Input Voltage	AC : 220-240V	IP Rating	IP20
Flux	2300lm	Instant Start	<0.5s

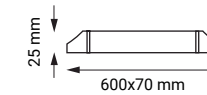

SKU: 6674 6000K  
SKU: 6675 4000K  
SKU: 6676 2800K

**40W**  
3320  
Lumens

Product code	OT40-A4	Beam Angle	120°
Watts	40W	CRI	Ra>80
Input Voltage	AC : 220-240V	IP Rating	IP20
Flux	3320lm	Instant Start	<0.5s

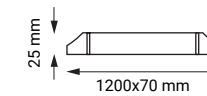

SKU: 6677 6000K  
SKU: 6678 4000K  
SKU: 6679 2800K

**50W**  
4150  
Lumens

Product code	OT50-A1	Beam Angle	120°
Watts	50W	CRI	Ra>80
Input Voltage	AC : 220-240V	IP Rating	IP20
Flux	4150lm	Instant Start	<0.5s

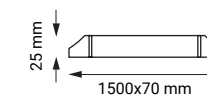

SKU: 6680 6000K  
SKU: 6681 4000K

LED Batten Lights **PF>0.9****Waterproof IP65**

120°



IP65

**20W****1600**

Lumens

Product code	OT20-A2	Beam Angle	120°
Watts	20W	CRI	Ra>80
Input Voltage	AC : 220-240V	IP Rating	IP65
Flux	1600lm	Instant Start	<0.5s

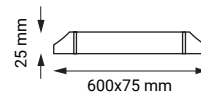
 SKU: 6691  
 6000K
 SKU:6692  
4000K
**40W****3200**

Lumens

Product code	OT40-A5	Beam Angle	120°
Watts	40W	CRI	Ra>80
Input Voltage	AC : 220-240V	IP Rating	IP65
Flux	3200lm	Instant Start	<0.5s

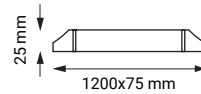
 SKU: 6694  
 6000K
 SKU:6695  
4000K
**50W****4150**

Lumens

Product code	OT50-A2	Beam Angle	120°
Watts	50W	CRI	Ra>80
Input Voltage	AC : 220-240V	IP Rating	IP65
Flux	4150lm	Instant Start	<0.5s

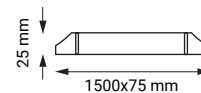
 SKU: 6697  
 6000K
 SKU:6698  
4000K

M12 cable gland

LED Light Fitting **PF>0.9****Stainless steel clips****With fast M12 cable gland**Flicker Free  
LED

180°



IP65

**18W****1800**

Lumens

Product code	OT18-A1	Beam Angle	180°
Watts	18W	CRI	Ra>80
Input Voltage	AC : 220-240V	IP Rating	IP65
Flux	1800lm	Instant Start	<0.5s

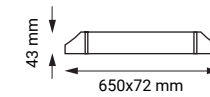
 SKU: 6721  
 6000K
 SKU:6722  
4000K
**36W****3600**

Lumens

Product code	OT36-A1	Beam Angle	180°
Watts	36W	CRI	Ra>80
Input Voltage	AC : 175-250V	IP Rating	IP65
Flux	3600lm	Instant Start	<0.5s

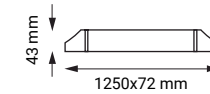
 SKU: 6723  
 6000K
 SKU:6724  
4000K
**45W****4500**

Lumens

Product code	OT45-A1	Beam Angle	180°
Watts	45W	CRI	Ra>80
Input Voltage	AC : 220-240V	IP Rating	IP65
Flux	4500lm	Instant Start	<0.5s

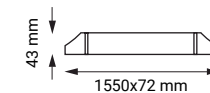
 SKU: 6725  
 6000K
 SKU:6726  
4000K



Industry-wide requirement throughout the entire world now, a prerequisite for all residential and business sites, OPTONICA LED covers all major subcategories.

Features:

- Up to 80% power saving
- Self-test mode with battery state indicator
- Various directions pictograms included
- 3 hours emergency operation
- Highly reliable with instant automatic on.

Application:

- Suitable for residential, industrial and commercial projects

LED EMERGENCY LIGHTS



## EMERGENCY LED EXIT SIGN

An emergency light is a battery-backed lighting device that switches on automatically when a building experiences a power outage.

All bulkhead and exit signs include 4 pictograms:



Battery

### ● Left Arrow



### ● Right Arrow



### ● UP Arrow



### ● EXIT



### EMERGENCY LED EXIT SIGN

#### Wall / Surface Mount

Product code	WW1-A1
Watts	3W
Input Voltage	AC : 220-240V
IP Rating	IP20
Battery	3.6V 900mAh Ni-Cd battery
Emergency Duration	> 3 Hours

 SKU: 7203 White Light ■ 6000K

Battery



### EMERGENCY LED EXIT SIGN

#### Wall / Surface Mount

Product code	WW1-A1
Watts	3W
Input Voltage	AC : 220-240V
IP Rating	IP20
Battery	3.6V 900mAh Ni-Cd battery
Emergency Duration	> 3 Hours

 SKU: 7204 White Light ■ 6000K

Battery



### EMERGENCY LED EXIT SIGN

#### Recessed Fixed

Product code	WW1-A1
Watts	3W
Input Voltage	AC : 220-240V
IP Rating	IP20
Battery	3.6V 900mAh Ni-Cd battery
Emergency Duration	> 3 Hours

 SKU: 7206 White Light ■ 6000K

Battery



### EMERGENCY LED EXIT SIGN

#### Recessed Hanging

Product code	WW1-A1
Watts	3W
Input Voltage	AC : 220-240V
IP Rating	IP20
Battery	3.6V 900mAh Ni-Cd battery
Emergency Duration	> 3 Hours

 SKU: 7205 White Light ■ 6000K

Battery



## EMERGENCY LED EXIT SIGN

**Bulkhead**

Product code	WW1-A1	Battery
Watts	4W	
Input Voltage	AC : 220-240V	
IP Rating	IP65	
Battery	3.6V 1500mAh Ni-Cd battery	
Emergency Duration	> 3 Hours	

SKU: 7201 White Light ■ 6000K

SKU: 7202 Recessed kit for SKU: 7201



## EMERGENCY LED EXIT SIGN

**Wall Mounted**

Product code	WW1-A1	Battery
Watts	3W	
Input Voltage	AC : 220-240V	
IP Rating	IP20	
Battery	3.6V 1200mAh Ni-Cd battery	
Emergency Duration	> 3 Hours	

SKU: 7207 White Light ■ 6000K

## EMERGENCY LED TWINSPOTS 3W

**Wall Mount - Self Test**

Product code	WW1-A2	280 Lumens
Watts	2x3 pcs 0.5W	
Input Voltage	AC : 220-240V	
IP Rating	IP20	
Battery	3.6V 1800mAh	
Emergency Duration	> 3 Hours	

SKU: 7208 White Light ■ 6000K

## EMERGENCY LED TWINSPOTS 6W

**Wall Mount - Self Test**

Product code	WW1-A2	450 Lumens
Watts	2x6 pcs 0.5W	
Input Voltage	AC : 220-240V	
IP Rating	IP20	
Battery	3.6V 3000mAh	
Emergency Duration	> 3 Hours	

SKU: 7209 White Light ■ 6000K

## EMERGENCY LED LIGHT

**Downlight**

Product code	WW1-A3	250 Lumens
Watts	3W	
Input Voltage	AC : 220-240V	
IP Rating	IP20	
Battery	3.6V 1800mAh	
Emergency Duration	> 3 Hours	

SKU: 7210 White Light ■ 6000KOSRAM  
Chips

## EMERGENCY LED LIGHT

**Downlight - Osram chip**

Product code	WW1-A3	460 Lumens
Watts	3W	
Input Voltage	AC : 220-240V	
IP Rating	IP20	
Battery	3.6V 1800mAh	
Emergency Duration	> 3 Hours	

SKU: 7211 White Light ■ 6000K

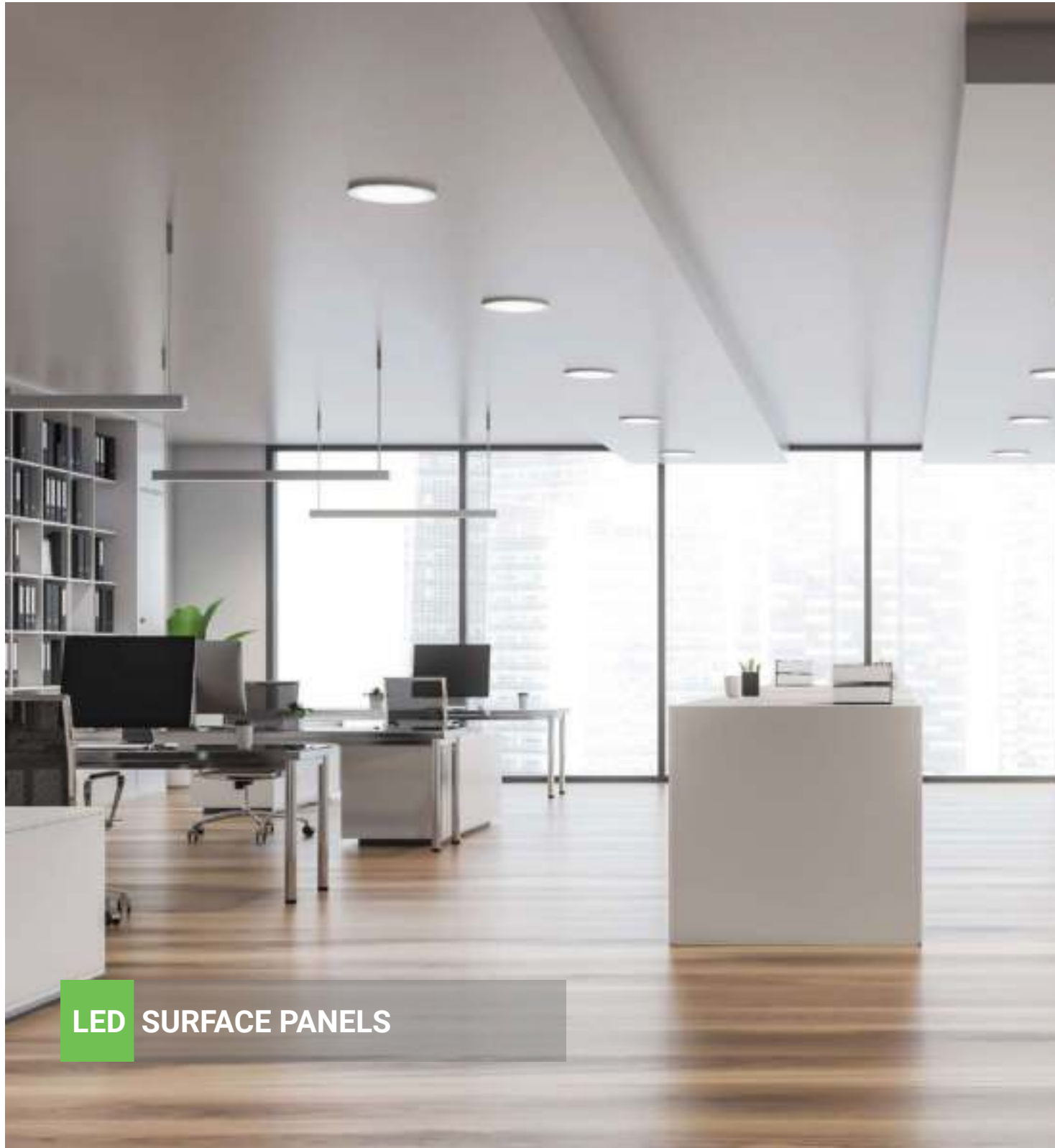

Allowing full flexibility of installation on every hard surface so there are no more design restraints.

Features:

- Up to 80% power saving
- Variety of colour temperatures
- Glossy or matt finishing
- Standard sizes
- Variety of powers

Application:

- Extremely wide indoor application use – home, office, retail, hospitals, restaurants, indoor parking lots, manufacturing spaces







**3** Years  
Warranty

100°

IP44



Color Changing knob

## CCT - SURFACE LED PANELS

**ROUND Build-in Driver****6W**

450

Lumens

Product code DL6-A3

Watts 6W

Input Voltage AC : 165-265V

Flux 450lm

Beam Angle 100°

CRI Ra>80

IP Rating IP44 Front

Dimension ø115x32mm

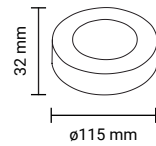

SKU: 2535

CCT - Steps

**12W**

950

Lumens

Product code DL12-A3

Watts 12W

Input Voltage AC : 165-265V

Flux 950lm

Beam Angle 100°

CRI Ra>80

IP Rating IP44 Front

Dimension ø170x32mm

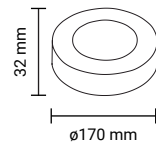

SKU: 2536

CCT - Steps

**18W**

1450

Lumens

Product code DL18-A3

Watts 18W

Input Voltage AC : 165-265V

Flux 1450lm

Beam Angle 100°

CRI Ra>80

IP Rating IP44 Front

Dimension ø220x32mm

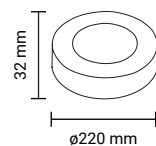

SKU: 2537

CCT - Steps

**24W**

2565

Lumens

Product code DL24-A3

Watts 24W

Input Voltage AC : 165-265V

Flux 2565lm

Beam Angle 100°

CRI Ra>80

IP Rating IP44 Front

Dimension ø240x32mm

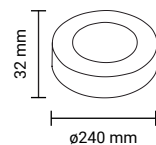

SKU: 2538

CCT - Steps



**3** Years  
Warranty

100°

IP44



Color Changing Knob

## CCT - SURFACE LED PANELS

**SQUARE Build-in Driver****6W**

450

Lumens

Product code DL6-A3

Watts 6W

Input Voltage AC : 165-265V

Flux 450lm

Beam Angle 100°

CRI Ra>80

IP Rating IP44 Front

Dimension 122x122x35mm

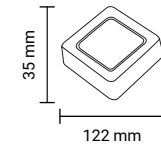

SKU: 2539

CCT - Steps

**12W**

950

Lumens

Product code DL12-A3

Watts 12W

Input Voltage AC : 165-265V

Flux 950lm

Beam Angle 100°

CRI Ra>80

IP Rating IP44 Front

Dimension 172x172x35mm

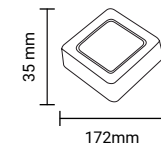

SKU: 2540

CCT - Steps

**18W**

1450

Lumens

Product code DL18-A3

Watts 18W

Input Voltage AC : 165-265V

Flux 1450lm

Beam Angle 100°

CRI Ra>80

IP Rating IP44 Front

Dimension 227x227x35mm

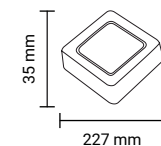

SKU: 2541

CCT - Steps

**24W**

2150

Lumens

Product code DL24-A3

Watts 24W

Input Voltage AC : 165-265V

Flux 2150lm

Beam Angle 100°

CRI Ra>80

IP Rating IP44 Front

Dimension 227x227x35mm

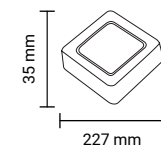

SKU: 2542

CCT - Steps



## LED SURFACE PANELS

**ROUND - HOME EDITION**

120°



IP20

**6W****480**

Lumens

Product code DL6-B1  
 Watts 6W  
 Input Voltage AC : 180-260V  
 Flux 480lm

Beam Angle 120°  
 CRI Ra>80  
 IP Rating IP20  
 Dimension ø117x28mm

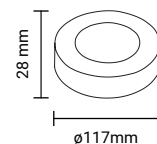

SKU: 2401 6000K  
 SKU: 2402 4000K  
 SKU: 2403 2800K

**12W****960**

Lumens

Product code DL12-B1  
 Watts 12W  
 Input Voltage AC : 180-260V  
 Flux 960lm

Beam Angle 120°  
 CRI Ra>80  
 IP Rating IP20  
 Dimension ø160x28mm

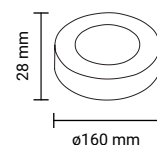

SKU: 2404 6000K  
 SKU: 2405 4000K  
 SKU: 2406 2800K

**18W****1440**

Lumens

Product code DL18-B1  
 Watts 18W  
 Input Voltage AC : 180-260V  
 Flux 1440lm

Beam Angle 120°  
 CRI Ra>80  
 IP Rating IP20  
 Dimension ø205x28mm

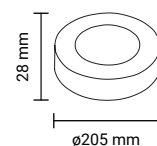

SKU: 2407 6000K  
 SKU: 2408 4000K  
 SKU: 2409 2800K

**24W****1920**

Lumens

Product code DL24-B1  
 Watts 24W  
 Input Voltage AC : 180-260V  
 Flux 1920lm

Beam Angle 120°  
 CRI Ra>80  
 IP Rating IP20  
 Dimension ø285x28mm

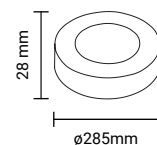

SKU: 2410 6000K  
 SKU: 2411 4000K  
 SKU: 2412 2800K



## LED SURFACE PANELS

**SQUARE - HOME EDITION**

120°



IP20

**6W****480**

Lumens

Product code DL6-B1  
 Watts 6W  
 Input Voltage AC : 180-260V  
 Flux 480lm

Beam Angle 120°  
 CRI Ra>80  
 IP Rating IP20  
 Dimension 118x118x28mm

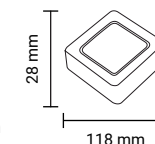

SKU: 2413 6000K  
 SKU: 2414 4000K  
 SKU: 2415 2800K

**12W****960**

Lumens

Product code DL12-B1  
 Watts 12W  
 Input Voltage AC : 180-260V  
 Flux 960lm

Beam Angle 120°  
 CRI Ra>80  
 IP Rating IP20  
 Dimension 160x160x28mm

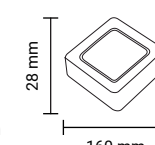

SKU: 2416 6000K  
 SKU: 2417 4000K  
 SKU: 2418 2800K

**18W****1440**

Lumens

Product code DL18-B1  
 Watts 18W  
 Input Voltage AC : 180-260V  
 Flux 1440lm

Beam Angle 120°  
 CRI Ra>80  
 IP Rating IP20  
 Dimension 208x208x28mm

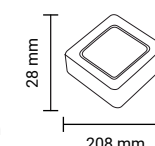

SKU: 2419 6000K  
 SKU: 2420 4000K  
 SKU: 2421 2800K

**24W****1920**

Lumens

Product code DL24-B1  
 Watts 24W  
 Input Voltage AC : 180-260V  
 Flux 1920lm

Beam Angle 120°  
 CRI Ra>80  
 IP Rating IP20  
 Dimension 288x288x28mm

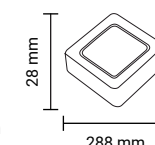

SKU: 2422 6000K  
 SKU: 2423 4000K  
 SKU: 2424 2800K

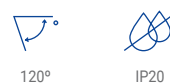

**LED SURFACE PANELS  
ROUND**

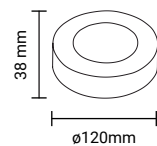
<b>6W</b>	Product code	DL6-A1	Beam Angle	120°
<b>480</b>	Watts	6W	CRI	Ra>80
Lumens	Input Voltage	AC : 85-260V	IP Rating	IP20
	Flux	480lm	Dimension	ø120x38mm

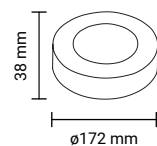

SKU: 2231   SKU:2243   SKU: 2232

<b>12W</b>	Product code	DL12-A1	Beam Angle	120°
<b>960</b>	Watts	12W	CRI	Ra>80
Lumens	Input Voltage	AC : 85-260V	IP Rating	IP20
	Flux	960lm	Dimension	ø172x38mm



SKU: 2244   SKU:2245   SKU: 2246

<b>18W</b>	Product code	DL18-A1	Beam Angle	120°
<b>1440</b>	Watts	18W	CRI	Ra>80
Lumens	Input Voltage	AC : 85-260V	IP Rating	IP20
	Flux	1440lm	Dimension	ø225x38mm

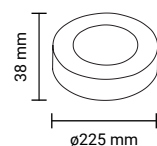

SKU: 2235   SKU:2247   SKU: 2236

<b>24W</b>	Product code	DL24-A1	Beam Angle	120°
<b>1920</b>	Watts	24W	CRI	Ra>80
Lumens	Input Voltage	AC : 85-260V	IP Rating	IP20
	Flux	1920lm	Dimension	ø300x38mm

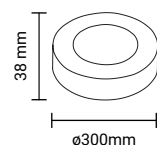

SKU: 2248   SKU:2249   SKU: 2250

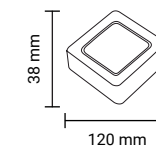

**LED SURFACE PANELS  
SQUARE**

<b>6W</b>	Product code	DL6-A1	Beam Angle	120°
<b>480</b>	Watts	6W	CRI	Ra>80
Lumens	Input Voltage	AC : 85-260V	IP Rating	IP20
	Flux	480lm	Dimension	120x120x38mm

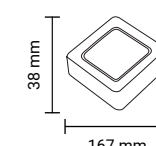

SKU: 2237   SKU:2251   SKU: 2238

<b>12W</b>	Product code	DL12-A1	Beam Angle	120°
<b>960</b>	Watts	12W	CRI	Ra>80
Lumens	Input Voltage	AC :85-260V	IP Rating	IP20
	Flux	960lm	Dimension	167x167x38mm



SKU: 2252   SKU:2253   SKU: 2254

<b>18W</b>	Product code	DL18-A1	Beam Angle	120°
<b>1440</b>	Watts	18W	CRI	Ra>80
Lumens	Input Voltage	AC : 85-260V	IP Rating	IP20
	Flux	1440lm	Dimension	220x220x32mm

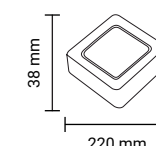

SKU: 2241   SKU:2255   SKU: 2242

<b>24W</b>	Product code	DL24-A1	Beam Angle	120°
<b>1920</b>	Watts	24W	CRI	Ra>80
Lumens	Input Voltage	AC : 85-260V	IP Rating	IP20
	Flux	1920lm	Dimension	295x295x32mm

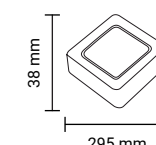

SKU: 2256   SKU:2257   SKU: 2258





LED ceiling lights are increasingly popular and are available in all shapes and sizes, with high-quality fittings available for any type of room. Whether you have a stately home or a terraced house, you can use these lamps to good effect.

**Features:**

- Up to 80% power saving
- Variety of colour temperatures
- Glossy or matt finishing
- Standard sizes
- Variety of powers

**Application:**

- Suspended ceilings
- Indoor use – home or office
- Large spaces

**LED CEILING LIGHT**





LED CEILING LIGHTS

**Black Round - CCT + RGB**



**18W**

1440  
Lumens

Watts	18W	Beam Angle	120°
Input Voltage	AC : 220-240V	CRI	Ra>80
Flux	1440lm	IP Rating	IP20

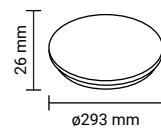

SKU: 2941  
RGB + CCT  
6000K 4500K 3000K

**24W**

1920  
Lumens

Watts	24W	Beam Angle	120°
Input Voltage	AC : 220-240V	CRI	Ra>80
Flux	1920lm	IP Rating	IP20

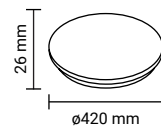

SKU: 2942  
RGB + CCT  
6000K 4500K 3000K

**32W**

2560  
Lumens

Watts	32W	Beam Angle	120°
Input Voltage	AC : 220-240V	CRI	Ra>80
Flux	2560lm	IP Rating	IP20

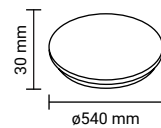

SKU: 2943  
RGB + CCT  
6000K 4500K 3000K



LED CEILING LIGHTS

**White Round - CCT + RGB**



**18W**

1440  
Lumens

Watts	18W	Beam Angle	120°
Input Voltage	AC : 220-240V	CRI	Ra>80
Flux	1440lm	IP Rating	IP20

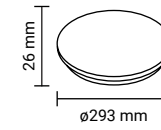

SKU: 2944  
RGB + CCT  
6000K 4500K 3000K

**24W**

1920  
Lumens

Watts	24W	Beam Angle	120°
Input Voltage	AC : 220-240V	CRI	Ra>80
Flux	1920lm	IP Rating	IP20

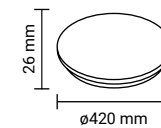

SKU: 2945  
RGB + CCT  
6000K 4500K 3000K

**32W**

2560  
Lumens

Watts	32W	Beam Angle	120°
Input Voltage	AC : 220-240V	CRI	Ra>80
Flux	2560lm	IP Rating	IP20

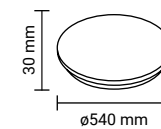

SKU: 2946  
RGB + CCT  
6000K 4500K 3000K



LED CEILING LIGHTS

**Round - CCT Switch**



LED CEILING LIGHTS

**Square - CCT Switch**



**18W**  
1880  
Lumens

Watts	18W	Beam Angle	120°
Input Voltage	AC : 220-240V	CRI	Ra>80
Flux	1880lm	IP Rating	IP54

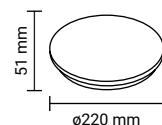

SKU: 2501  
CCT  
6000K 4500K 3000K

**18W**  
1880  
Lumens

Watts	18W	Beam Angle	120°
Input Voltage	AC : 220-240V	CRI	Ra>80
Flux	1880lm	IP Rating	IP54

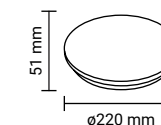

SKU: 2503  
CCT  
6000K 4500K 3000K

**24W**  
2565  
Lumens

Watts	24W	Beam Angle	120°
Input Voltage	AC : 220-240V	CRI	Ra>80
Flux	2565lm	IP Rating	IP54

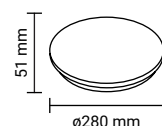

SKU: 2502  
CCT  
6000K 4500K 3000K

**24W**  
2565  
Lumens

Watts	24W	Beam Angle	120°
Input Voltage	AC : 220-240V	CRI	Ra>80
Flux	2565lm	IP Rating	IP54

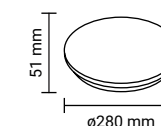

SKU: 2504  
CCT  
6000K 4500K 3000K

**18W**  
1880  
Lumens



Watts	18W	Beam Angle	120°
Input Voltage	AC : 220-240V	CRI	Ra>80
Flux	1880lm	IP Rating	IP54

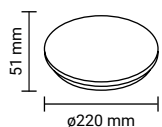

SKU: 2505  
CCT  
6000K 4500K 3000K

**18W**  
1880  
Lumens



Watts	18W	Beam Angle	120°
Input Voltage	AC : 220-240V	CRI	Ra>80
Flux	1880lm	IP Rating	IP54

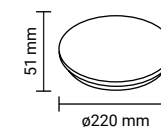

SKU: 2506  
CCT  
6000K 4500K 3000K





LED CEILING LIGHTS

**Black Body - Round**



<b>18W</b>	Product code	PD18-A2	Beam Angle	120°
<b>1350</b>	Watts	18W	CRI	Ra>80
Lumens	Input Voltage	AC : 175-260V	IP Rating	IP20
	Flux	1350lm	Body Color	Black

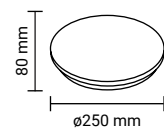

SKU:2901 4500K  
SKU: 2902 3000K

LED CEILING LIGHTS

**White Body - Round**



<b>18W</b>	Product code	PD18-A2	Beam Angle	120°
<b>1350</b>	Watts	18W	CRI	Ra>80
Lumens	Input Voltage	AC : 175-260V	IP Rating	IP20
	Flux	1350lm	Body Color	White

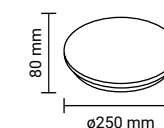

SKU:2903 4500K  
SKU: 2904 3000K

<b>30W</b>	Product code	PD30-A2	Beam Angle	120°
<b>2250</b>	Watts	30W	CRI	Ra>80
Lumens	Input Voltage	AC : 175-260V	IP Rating	IP20
	Flux	2250lm	Body Color	Black

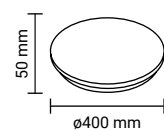

SKU:2905 4500K  
SKU: 2906 3000K

<b>30W</b>	Product code	PD30-A2	Beam Angle	120°
<b>2250</b>	Watts	30W	CRI	Ra>80
Lumens	Input Voltage	AC : 175-260V	IP Rating	IP20
	Flux	2250lm	Body Color	White

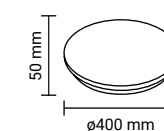

SKU:2907 4500K  
SKU: 2908 3000K

<b>54W</b>	Product code	PD54-A2	Beam Angle	120°
<b>4050</b>	Watts	54W	CRI	Ra>80
Lumens	Input Voltage	AC : 175-260V	IP Rating	IP20
	Flux	4050lm	Body Color	Black

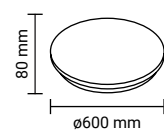

SKU:2909 4500K  
SKU: 2910 3000K

<b>54W</b>	Product code	PD54-A2	Beam Angle	120°
<b>4050</b>	Watts	54W	CRI	Ra>80
Lumens	Input Voltage	AC : 175-260V	IP Rating	IP20
	Flux	4050lm	Body Color	White

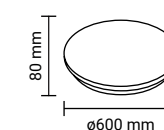

SKU:2911 4500K  
SKU: 2912 3000K

## LED CEILING LIGHTS

**36W - Black**

Product code DL36-A2  
 Watts 36W  
 Input Voltage AC : 175-260V  
 Flux 2700lm  
 Beam Angle 120°  
 Shape Round

SKU:2913    SKU: 2914  
 ■ 4500K    ■ 3000K

CRI Ra>80  
 IP Rating IP20  
 Dimension ø500x80 mm  
 Body Color Black  
 Dimmable NO

2700  
 Lumens    120°   

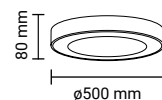

## LED CEILING LIGHTS

**36W - White**

Product code DL36-A2  
 Watts 36W  
 Input Voltage AC : 175-260V  
 Flux 2700lm  
 Beam Angle 120°  
 Shape Round

SKU:2915    SKU: 2916  
 ■ 4500K    ■ 3000K

CRI Ra>80  
 IP Rating IP20  
 Dimension ø500x80 mm  
 Body Color White  
 Dimmable NO

2700  
 Lumens    120°   

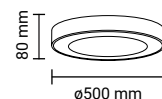

## LED CEILING LIGHTS

**64W - Black**

Product code DL64-A2  
 Watts 64W  
 Input Voltage AC : 175-260V  
 Flux 4800lm  
 Beam Angle 120°  
 Shape Round

SKU:2917    SKU: 2918  
 ■ 4500K    ■ 3000K

CRI Ra>80  
 IP Rating IP20  
 Dimension ø800x80 mm  
 Body Color Black  
 Dimmable NO

4800  
 Lumens    120°   

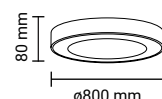

## LED CEILING LIGHTS

**64W - White**

Product code DL64-A2  
 Watts 64W  
 Input Voltage AC : 175-260V  
 Flux 4800lm  
 Beam Angle 120°  
 Shape Round

SKU:2919    SKU: 2920  
 ■ 4500K    ■ 3000K

CRI Ra>80  
 IP Rating IP20  
 Dimension ø800x80 mm  
 Body Color White  
 Dimmable NO

4800  
 Lumens    120°   

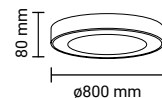

## LED CEILING LIGHTS

**30W - Black**

Product code DL36-A2  
 Watts 36W  
 Input Voltage AC : 175-260V  
 Flux 2250lm  
 Beam Angle 120°  
 Shape Square

SKU:2919    SKU: 2920  
 ■ 4500K    ■ 3000K

CRI Ra>80  
 IP Rating IP20  
 Dimension 380x380 mm  
 Body Color Black  
 Dimmable NO

2250  
 Lumens    120°   

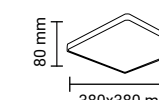

## LED CEILING LIGHTS

**30W - White**

Product code DL36-A2  
 Watts 36W  
 Input Voltage AC : 175-260V  
 Flux 2250lm  
 Beam Angle 120°  
 Shape Square

SKU:2923    SKU: 2924  
 ■ 4500K    ■ 3000K

CRI Ra>80  
 IP Rating IP20  
 Dimension 380x380 mm  
 Body Color White  
 Dimmable NO

2250  
 Lumens    120°   

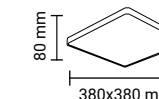

## LED CEILING LIGHTS

**64W - Black**

Product code DL64-A2  
 Watts 64W  
 Input Voltage AC : 175-260V  
 Flux 4800lm  
 Beam Angle 120°  
 Shape Square

SKU:2925    SKU: 2926  
 ■ 4500K    ■ 3000K

CRI Ra>80  
 IP Rating IP20  
 Dimension 600x600 mm  
 Body Color Black  
 Dimmable NO

4800  
 Lumens    120°   

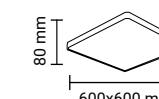

## LED CEILING LIGHTS

**64W - White**

Product code DL64-A2  
 Watts 64W  
 Input Voltage AC : 175-260V  
 Flux 4800lm  
 Beam Angle 120°  
 Shape Square

SKU:2927    SKU: 2928  
 ■ 4500K    ■ 3000K

CRI Ra>80  
 IP Rating IP20  
 Dimension 600x600 mm  
 Body Color White  
 Dimmable NO

4800  
 Lumens    120°   

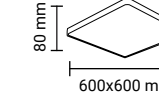

LED CEILING LIGHTS

**Sandy White - Round**



Product code	DL72-A1	CRI	Ra>80
Watts	36x2W	IP Rating	IP20
Input Voltage	AC : 180-260V	Dimension	ø500x50 mm
Flux	5400lm	Body Color	White
Beam Angle	120°	Dimmable	NO
Shape	Round		

SKU: 2931 ← CCT →  
■ 6000K ■ 4500K ■ 3000K



Remote Control

LED CEILING LIGHTS

**Sandy White - Round**



Product code	DL96-A1	CRI	Ra>80
Watts	48x2W	IP Rating	IP20
Input Voltage	AC : 180-260V	Dimension	ø500x50 mm
Flux	7200lm	Body Color	White
Beam Angle	120°	Dimmable	NO
Shape	Round		

SKU: 2930 ← CCT →  
■ 6000K ■ 4500K ■ 3000K



Remote Control

LED CEILING LIGHTS

**Sandy White - Square**



Product code	DL120-A1	CRI	Ra>80
Watts	60x2W	IP Rating	IP20
Input Voltage	AC : 180-260V	Dimension	500x500x50 mm
Flux	9000lm	Body Color	White
Beam Angle	120°	Dimmable	NO
Shape	Square		

SKU: 2929 ← CCT → 3800156629295  
■ 6000K ■ 4500K ■ 3000K



Remote Control

Ceiling plate for pendant lamps  
**Does not contain pendant lamps**

HANGING ACCESSORIES

**Black** SKU: 5181



HANGING ACCESSORIES

**White** SKU: 5180







600 Lumens  
120°  
IP54

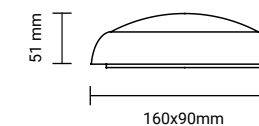

LED SURFACE CEILING

**Bulkhead-Thermoplastic**

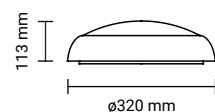
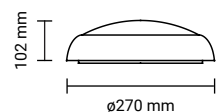

120°  
IP65

**8W**

640 Lumens

Product code DL8-A3  
Watts 8W  
Input Voltage AC : 220-240V  
Flux 640lm  
Beam Angle 120°  
CRI Ra>80  
IP Rating IP65  
Instant Start <0.5s

SKU:2807 4500K  
SKU:2808 2700K

**13W**

1050 Lumens

Product code DL13-A1  
Watts 13W  
Input Voltage AC : 220-240V  
Flux 1050lm  
Beam Angle 120°  
CRI Ra>80  
IP Rating IP65  
Instant Start <0.5s

SKU:2813 4500K  
SKU:2814 2700K

**8W**

640 Lumens

Product code DL8-A4  
Watts 8W  
Input Voltage AC : 220-240V  
Flux 640lm  
Beam Angle 120°  
CRI Ra>80  
IP Rating IP65  
Instant Start <0.5s



SKU:2809 4500K  
SKU:2810 2700K

MW Sensor

**13W**

1050 Lumens

Product code DL13-A3  
Watts 13W  
Input Voltage AC : 220-240V  
Flux 1050lm  
Beam Angle 120°  
CRI Ra>80  
IP Rating IP65  
Instant Start <0.5s



SKU:2815 4500K  
SKU:2816 2700K

MW Sensor

**8W**

640 Lumens

Product code DL8-A5  
Watts 8W  
Input Voltage AC : 220-240V  
Flux 640lm  
Beam Angle 120°  
CRI Ra>80  
IP Rating IP65  
Instant Start <0.5s



Emergency

SKU:2811 4500K  
SKU:2812 2700K

**13W**

1050 Lumens

Product code DL13-A4  
Watts 13W  
Input Voltage AC : 220-240V  
Flux 1050lm  
Beam Angle 120°  
CRI Ra>80  
IP Rating IP65  
Instant Start <0.5s



Emergency

SKU:2817 4500K  
SKU:2818 2700K

LED SURFACE CEILING 8W

**Bulkhead-Thermoplastic**

SKU: 2801 6000K  
SKU: 2802 4000K  
SKU: 2803 2700K

Watts 8W  
Input Voltage AC : 220-240V  
Flux 600lm  
Beam Angle 120°  
Shape Bulkhead  
CRI Ra>80  
IP Rating IP54  
Dimension 160x90x51 mm  
Body Color White  
Dimmable NO



PIR Sensor  
1260 Lumens  
120°  
IP20

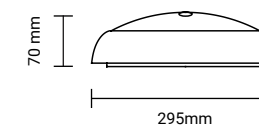

LED SURFACE CEILING 18W

**Thermoplastic - PIR**

SKU: 2804 6000K  
SKU: 2805 4000K  
SKU: 2806 2700K

Watts 18W  
Input Voltage AC : 220-240V  
Flux 1260lm  
Beam Angle 120°  
Shape Round  
CRI Ra>80  
IP Rating IP20  
Dimension 295x70 mm  
Body Color White  
Dimmable NO



## LED CEILING LIGHTS

**HOME EDITION - Matt White**

120°



IP20

**12W****880**

Lumens

Product code	DL12-B1	Beam Angle	120°
Watts	12W	CRI	Ra>80
Input Voltage	AC : 175-265V	IP Rating	IP20
Flux	880lm	Body Color	White

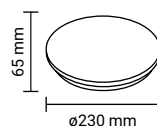
 SKU: 2870   SKU:2871   SKU: 2872  
 6000K   4500K   3000K

## LED CEILING LIGHTS

**HOME EDITION - Dotty Sparkle**

120°



IP20

**12W****880**

Lumens

Product code	DL12-B1	Beam Angle	120°
Watts	12W	CRI	Ra>80
Input Voltage	AC : 175-265V	IP Rating	IP20
Flux	880lm	Body Color	White

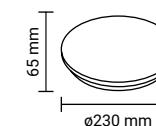
 SKU: 2879   SKU:2880   SKU: 2881  
 6000K   4500K   3000K
**18W****1550**

Lumens

Product code	DL18-B1	Beam Angle	120°
Watts	18W	CRI	Ra>80
Input Voltage	AC : 175-265V	IP Rating	IP20
Flux	1550lm	Body Color	White

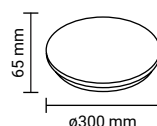
 SKU: 2873   SKU:2874   SKU: 2875  
 6000K   4500K   3000K
**18W****1550**

Lumens

Product code	DL18-B1	Beam Angle	120°
Watts	18W	CRI	Ra>80
Input Voltage	AC : 175-265V	IP Rating	IP20
Flux	1550lm	Body Color	White

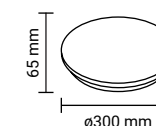
 SKU: 2882   SKU:2883   SKU: 2884  
 6000K   4500K   3000K
**24W****1900**

Lumens

Product code	DL24-B1	Beam Angle	120°
Watts	24W	CRI	Ra>80
Input Voltage	AC : 175-265V	IP Rating	IP20
Flux	1900lm	Body Color	White

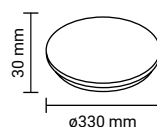
 SKU: 2876   SKU:2877   SKU: 2878  
 6000K   4500K   3000K
**24W****1900**

Lumens

Product code	DL24-B1	Beam Angle	120°
Watts	24W	CRI	Ra>80
Input Voltage	AC : 175-265V	IP Rating	IP20
Flux	1900lm	Body Color	White

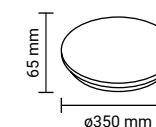
 SKU: 2885   SKU:2886   SKU: 2887  
 6000K   4500K   3000K



LED CEILING LIGHTS

**CITY LINE - Matt White**



<b>12W</b>	Product code	DL12-B1	Beam Angle	120°
<b>880</b>	Watts	12W	CRI	Ra>80
Lumens	Input Voltage	AC : 175-265V	IP Rating	IP20
	Flux	880lm	Body Color	White

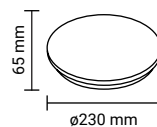

SKU: 2840	SKU:2841	SKU: 2842
6000K	4500K	3000K

LED CEILING LIGHTS

**CITY LINE - Dotty Sparkle**

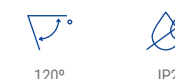

<b>12W</b>	Product code	DL12-B1	Beam Angle	120°
<b>840</b>	Watts	12W	CRI	Ra>80
Lumens	Input Voltage	AC : 175-265V	IP Rating	IP20
	Flux	840lm	Body Color	White

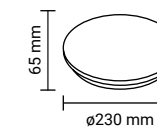

SKU: 2849	SKU:2850	SKU: 2851
6000K	4500K	3000K

<b>18W</b>	Product code	DL18-B1	Beam Angle	120°
<b>1550</b>	Watts	18W	CRI	Ra>80
Lumens	Input Voltage	AC : 175-265V	IP Rating	IP20
	Flux	1550lm	Body Color	White

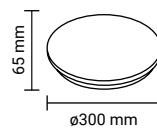

SKU: 2843	SKU:2844	SKU: 2845
6000K	4500K	3000K

<b>18W</b>	Product code	DL18-B1	Beam Angle	120°
<b>1260</b>	Watts	18W	CRI	Ra>80
Lumens	Input Voltage	AC : 175-265V	IP Rating	IP20
	Flux	1260lm	Body Color	White

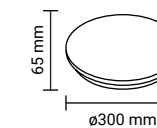

SKU: 2852	SKU:2853	SKU: 2854
6000K	4500K	3000K

<b>24W</b>	Product code	DL24-B1	Beam Angle	120°
<b>1900</b>	Watts	24W	CRI	Ra>80
Lumens	Input Voltage	AC : 175-265V	IP Rating	IP20
	Flux	1900lm	Body Color	White

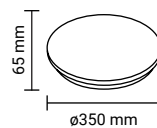

SKU: 2846	SKU:2847	SKU: 2848
6000K	4500K	3000K

<b>24W</b>	Product code	DL24-B1	Beam Angle	120°
<b>1900</b>	Watts	24W	CRI	Ra>80
Lumens	Input Voltage	AC : 175-265V	IP Rating	IP20
	Flux	1900lm	Body Color	White

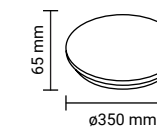

SKU: 2855	SKU:2856	SKU: 2857
6000K	4500K	3000K





Remote Control included



Color changing LED 3000 to 6000K

**LED Ceiling Light 36W PF>0.9**  
**Matt White**



2500  
Lumens

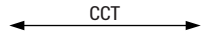

SKU: 2858 3800156628588

6000K 4500K 3000K

Product code	DL36-A4	Remote	No
Watts	36W	CRI	Ra>80
Input Voltage	AC : 185-265V	IP Rating	IP20
Flux	2500lm	Dimension	ø460x70 mm
Beam Angle	120°	Body Color	Matt White
Shape	Round	Dimmable	Yes



Remote Control included



Color changing LED 3000 to 6000K

**LED Ceiling Light 36W PF>0.9**  
**Matt White+Dotty Sparkle**



2500  
Lumens

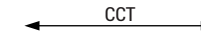

SKU: 2860 3800156628601

6000K 4500K 3000K

Product code	DL36-A5	Remote	Yes
Watts	36W	CRI	Ra>80
Input Voltage	AC : 185-265V	IP Rating	IP20
Flux	2500lm	Dimension	430x430x70 mm
Beam Angle	120°	Body Color	Matt White
Shape	Square	Dimmable	Yes



Remote Control included



Color changing LED 3000 to 6000K

**LED Ceiling Light 60W PF>0.9**  
**Matt White**



3600  
Lumens



SKU: 2859 3800156628595

6000K 4500K 3000K

Product code	DL60-A4	Remote	No
Watts	60W	CRI	Ra>80
Input Voltage	AC : 185-265V	IP Rating	IP20
Flux	3600lm	Dimension	ø560x70 mm
Beam Angle	120°	Body Color	Matt White
Shape	Round	Dimmable	Yes



Remote Control included



Color changing LED 3000 to 6000K

**LED Ceiling Light 60W PF>0.9**  
**Matt White+Dotty Sparkle**



3600  
Lumens

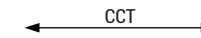

SKU: 2861 3800156628618

6000K 4500K 3000K

Product code	DL60-A5	Remote	Yes
Watts	60W	CRI	Ra>80
Input Voltage	AC : 185-265V	IP Rating	IP20
Flux	3600lm	Dimension	530x530x70 mm
Beam Angle	120°	Body Color	Matt White
Shape	Square	Dimmable	Yes



Remote Control included



Color changing LED 3000 to 6000K

LED Ceiling Light 36W  
**HOME EDITION - Allstar**

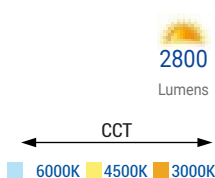

SKU: 2888

Product code	DL36-A6	Remote	Yes
Watts	36W	CRI	Ra>80
Input Voltage	AC : 185-240V	IP Rating	IP20
Flux	2800lm	Dimension	ø380x110 mm
Beam Angle	120°	Body Color	Matt White
Shape	Round	Dimmable	Yes



Remote Control included



Color changing LED 3000 to 6000K

LED Ceiling Light 60W  
**HOME EDITION - Allstar**

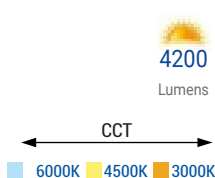

SKU: 2889

Product code	DL60-A6	Remote	Yes
Watts	60W	CRI	Ra>80
Input Voltage	AC : 185-240V	IP Rating	IP20
Flux	4200lm	Dimension	φ485x115 mm
Beam Angle	120°	Body Color	Matt White
Shape	Round	Dimmable	Yes

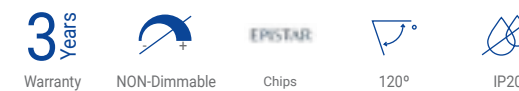

LED Ceiling Light 38W **PF>0.95**  
**Sandy White - Square**



SKU: 2297 Warm White 3000K

Product code	DL38-A1	CRI	Ra>80
Watts	38W	IP Rating	IP20
Input Voltage	AC : 175-240V	Dimension	450x450x100 mm
Flux	1900lm	Body Color	Sandy White
Beam Angle	120°	Dimmable	NO
Shape	Square		

LED Suspended Lighting  
**Round Sandy White**

- 3**  
Years  
Warranty
- NON-Dimmable
- EPSTAR  
Chips
- 120°
- IP20



LED Suspended Lighting  
**Square Sandy White**

- 3**  
Years  
Warranty
- NON-Dimmable
- EPSTAR  
Chips
- 120°
- IP20



LED Suspended Lighting  
**38W PF>0.95**

**2660**  
Lumens

Watts	38W	CRI	Ra>80
Input Voltage	AC : 175-240V	IP Rating	IP20
Flux	2660lm	Dimension	ø450x1200 mm
Beam Angle	120°	Body Color	Sandy White
Shape	Round	Dimmable	NO

SKU: 9036 Warm White ■ 3000K

LED Suspended Lighting  
**38W PF>0.95**

**2660**  
Lumens

Watts	38W	CRI	Ra>80
Input Voltage	AC : 175-240V	IP Rating	IP20
Flux	2660lm	Dimension	450x450x1200 mm
Beam Angle	120°	Body Color	Sandy White
Shape	Square	Dimmable	NO

SKU: 9038 Warm White ■ 3000K

LED Suspended Lighting  
**50W PF>0.95**

**3500**  
Lumens

Watts	50W	CRI	Ra>80
Input Voltage	AC : 175-240V	IP Rating	IP20
Flux	3500lm	Dimension	ø600x1200 mm
Beam Angle	120°	Body Color	Sandy White
Shape	Round	Dimmable	NO

SKU: 9037 Warm White ■ 3000K

LED Suspended Lighting  
**50W PF>0.95**

**3500**  
Lumens

Watts	50W	CRI	Ra>80
Input Voltage	AC : 175-240V	IP Rating	IP20
Flux	3500lm	Dimension	600x600x1200 mm
Beam Angle	120°	Body Color	Sandy White
Shape	Square	Dimmable	NO

SKU: 9039 Warm White ■ 3000K



VINTAGE PENDANTS E27



SKU: 9029 - Pearl Black



SKU: 9046 - Pearl Black



SKU: 9047 - Bronze



SKU: 9049 - Antique gold



SKU: 9028 - Rose Gold



SKU: 9048 - Rose Gold



3D Glass Barel Pendant D200  
**Chrome Rhombus**

SKU:	<b>9014</b>
Product Code	PD1-A1
E27 holder	Max 40W
Material	3D Glass
IP Rating	IP20
Dimension	ø200x213mm
EAN:	3800156690141



3D Glass Barel Pendant D200  
**Chrome Squares**

SKU:	<b>9015</b>
Product Code	PD1-A1
E27 holder	Max 40W
Material	3D Glass
IP Rating	IP20
Dimension	ø200x213mm
EAN:	3800156690158



3D Glass Pendant D200  
**Chrome Square**

SKU:	<b>9004</b>
Product Code	PD1-A1
E27 holder	Max 40W
Material	3D Glass
IP Rating	IP20
Dimension	ø200x175mm
EAN:	3800156690042



3D Glass Pendant D200  
**Copper Squares**

SKU:	<b>9005</b>
Product Code	PD1-A1
E27 holder	Max 40W
Material	3D Glass
IP Rating	IP20
Dimension	ø200x175mm
EAN:	3800156690059





3D Glass Pendant D220

**Chrome Circles**

SKU: **9008**  
 Product Code PD1-A1  
 E27 holder Max 40W  
 Material 3D Glass  
 IP Rating IP20  
 Dimension ø220x275mm  
 EAN: 3800156690080



E27 Holder



IP20



3D Glass Pendant D200

**Chrome Circles**

SKU: **9019**  
 Product Code PD1-A1  
 E27 holder Max 40W  
 Material 3D Glass  
 IP Rating IP20  
 Dimension ø200x165mm  
 EAN: 3800156690196



E27 Holder



IP20



3D Glass Pendant D220

**Copper Seagull**

SKU: **9009**  
 Product Code PD1-A1  
 E27 holder Max 40W  
 Material 3D Glass  
 IP Rating IP20  
 Dimension ø220x275mm  
 EAN: 3800156690097



E27 Holder



IP20



3D Glass Pendant D200

**Chrome Seagull**

SKU: **9020**  
 Product Code PD1-A1  
 E27 holder Max 40W  
 Material 3D Glass  
 IP Rating IP20  
 Dimension ø200x165mm  
 EAN: 3800156690202



E27 Holder



IP20



3D Glass Pendant D220

**Chrome Seagull**

SKU: **9011**  
 Product Code PD1-A1  
 E27 holder Max 40W  
 Material 3D Glass  
 IP Rating IP20  
 Dimension ø220x275mm  
 EAN: 3800156690110



E27 Holder



IP20



3D Glass Pendant D200

**Copper Circles**

SKU: **9021**  
 Product Code PD1-A1  
 E27 holder Max 40W  
 Material 3D Glass  
 IP Rating IP20  
 Dimension ø200x165mm  
 EAN: 3800156690219



E27 Holder



IP20



**3D Glass Umbrella Pendant D400  
Copper Seagull**

SKU: **9017**  
Product Code PD1-A1  
E27 holder Max 40W  
Material 3D Glass  
IP Rating IP20  
Dimension ø400x200mm  
EAN: 3800156690172



**3D Glass Pendant D290  
Copper Circles**

SKU: **9022**  
Product Code PD1-A1  
E27 holder Max 40W  
Material 3D Glass  
IP Rating IP20  
Dimension ø290x250mm  
EAN: 3800156690226



**3D Glass Umbrella Pendant D400  
Chrome Circles**

SKU: **9018**  
Product Code PD1-A1  
E27 holder Max 40W  
Material 3D Glass  
IP Rating IP20  
Dimension ø400x200mm  
EAN: 3800156690189



**3D Glass Pendant D290  
Chrome Seagull**

SKU: **9024**  
Product Code PD1-A1  
E27 holder Max 40W  
Material 3D Glass  
IP Rating IP20  
Dimension ø290x250mm  
EAN: 3800156690240



**Vintage Rope Pendant  
Length 1.5m**

SKU: **9027**  
Product Code PD1-A2  
E27 holder Max 60W  
IP Rating IP20  
Dimension ø90x1500mm  
EAN: 3800156660596



**3D Glass Pendant D400  
Copper Fireworks**

SKU: **9026**  
Product Code PD1-A1  
E27 holder Max 40W  
Material 3D Glass  
IP Rating IP20  
Dimension ø400x345mm  
EAN: 3800156690264







**LED Flame Bulb**  
**5W SMD E27**



Product code	OT5-A1	CRI	Ra>80
Watts	5W	IP Rating	IP20
Input Voltage	AC : 220-240V	Dimension	ø47x125 mm
Flux	250lm	Socket	E27
Beam Angle	360°		

SKU: 222  
■ 1300K



**LED Flame Lamp Wall Mounted**  
**5W SMD**



Product code	PD5-A1	CRI	Ra>80
Watts	5W	IP Rating	IP20
Input Voltage	AC : 220-240V	Dimension	220xH285 mm
Flux	250lm	LED Flame Bulb Included	
Beam Angle	360°		

SKU: 9044  
■ 1300K



**LED Flame Lamp**  
**5W SMD**



Product code	PD5-A1	CRI	Ra>80
Watts	5W	IP Rating	IP20
Input Voltage	AC : 220-240V	Dimension	ø180xH285 mm
Flux	250lm	LED Flame Bulb Included	
Beam Angle	360°	E27 holder	

SKU: 9041  
■ 1300K



**LED Flame Lamp Wall Mounted**  
**5W SMD**



Product code	PD5-A1	CRI	Ra>80
Watts	5W	IP Rating	IP20
Input Voltage	AC : 220-240V	Dimension	180xH260 mm
Flux	250lm	LED Flame Bulb Included	
Beam Angle	360°	E27 holder	

SKU: 9045  
■ 1300K



**LED Flame Lamp With Battery**  
**5W SMD**



Product code	PD5-A1	CRI	Ra>80
Watts	5W	IP Rating	IP20
Input Voltage	AC : 220-240V	Dimension	ø180xH285 mm
Flux	250lm	LED Flame Bulb Included	
Beam Angle	360°	E27 holder	

SKU: 9042  
■ 1300K

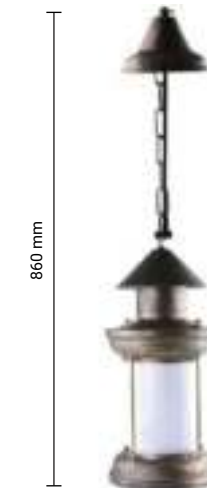

860 mm

**LED Flame Lamp Hanging**  
**5W SMD**



Product code	PD5-A1	CRI	Ra>80
Watts	5W	IP Rating	IP20
Input Voltage	AC : 220-240V	Dimension	ø150xH330 mm
Flux	250lm	LED Flame Bulb Included	
Beam Angle	360°	E27 holder	

SKU: 9043  
■ 1300K



**LED PANELS**



LED panels offers a broad application it different lighting solutions. With variety of standard sizes they can be placed in suspended ceilings or used as hanging lights.

**Features:**

- Up to 80% power saving
- Build-in or hanging installations
- Variety of colour temperatures
- Glossy or matt finishing
- Standard sizes
- Variety of powers

**Application:**

- Suspended ceilings
- Indoor use – home or office
- Large spaces



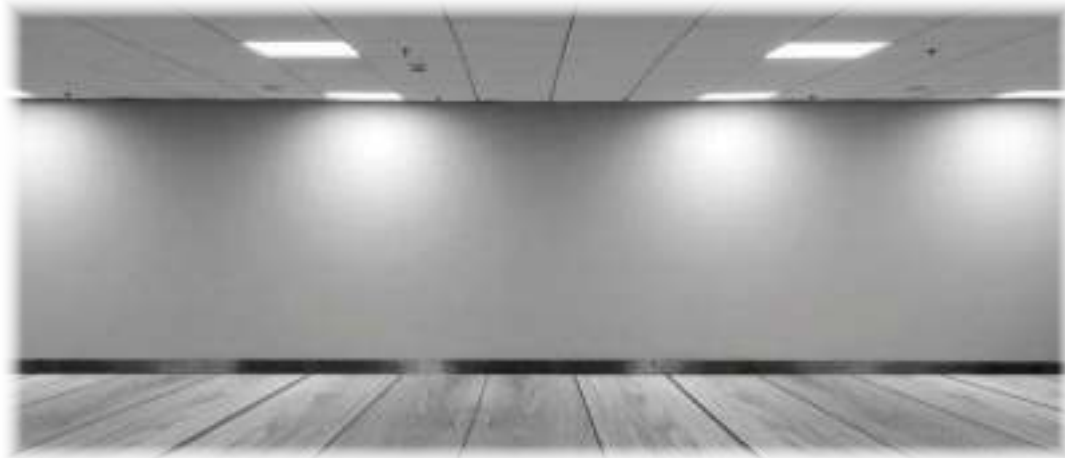

  
125  
Lumens/W

  
6 PCS  
BOX

**LED PANEL PF>0.9**  
**29W With Driver 60x60cm**

Product code	DL29-A1	Beam Angle	120°
Watts	29W	CRI	Ra>80
Input Voltage	AC : 175-265V	IP Rating	IP20
Flux	3600lm	BOX Qty	6 PCS

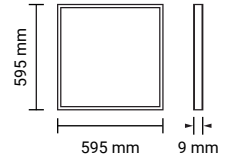
 SKU: 2382    SKU: 2383    SKU: 2384  
 ■ 6000K    ■ 4500K    ■ 2700K

  
**HIGH**  
Lumens    

**LED PANEL PF>0.95**  
**25W With Driver 60x60cm**
  
3000  
Lumens    

Product code	DL25-A2	Beam Angle	120°
Watts	25W	CRI	Ra>80
Input Voltage	AC : 175-265V	IP Rating	IP20
Flux	3000lm	BOX Qty	1 PCS

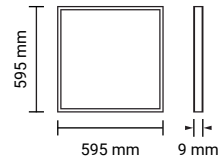

**TP(b)RATED**  
 Polycarbonate Diffuser

 SKU: 2740    SKU: 2741  
 ■ 6000K    ■ 4500K

**3**  
Years  
Warranty

**LED BACKLIT PANEL PF>0.9**  
**30W With Driver 60x60cm**
  
120    
  
Lumens/W    **HIGH**

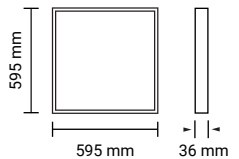
Product code	DL30-A3	Beam Angle	120°
Watts	30W	CRI	Ra>80
Input Voltage	AC : 220-240V	IP Rating	IP20
Flux	3600lm	BOX Qty	6 PCS

**TP(a)RATED**  
 Polycarbonate Diffuser

 SKU: 2776    SKU: 2777  
 ■ 6000K    ■ 4500K

  
6 PCS  
BOX

**LED BACKLIT PANEL PF>0.9**  
**25W With Driver 60x60cm**
  
**HIGH**  
Lumens    

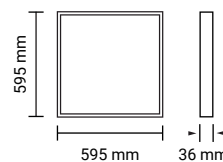
Product code	DL25-A3	Beam Angle	120°
Watts	25W	CRI	Ra>80
Input Voltage	AC : 185-265V	IP Rating	IP20
Flux	4000lm	BOX Qty	10 PCS

 SKU: 2770    SKU: 2771  
 ■ 6000K    ■ 4500K

  
160  
Lumens/W

  
10 PCS  
BOX

**LED PANEL**  
**36W With Driver 60x60cm**
  
3200  
Lumens    

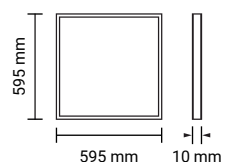
Product code	DL36-A1	Beam Angle	120°
Watts	36W	CRI	Ra>80
Input Voltage	AC : 220-240V	IP Rating	IP20
Flux	3200lm	BOX Qty	6 PCS

 SKU: 2350    SKU: 2363    SKU: 2351  
 ■ 6000K    ■ 4500K    ■ 2700K

  
6 PCS  
BOX



**LED PANEL Single Pack PF>0.9**  
**36W With Driver 62x62cm**
**3600**  
 Lumens
 
 IP20

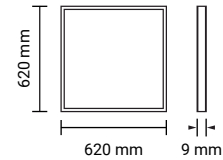

Product code	DL36-A4	Beam Angle	120°
Watts	36W	CRI	Ra>80
Input Voltage	AC : 220-240V	IP Rating	IP20
Flux	3600lm	BOX Qty	1 PCS

 SKU: 2701    SKU:2702    SKU: 2703  
 6000K    4500K    2700K

**3600**  
 Lumens
 
 IP20

**LED PANEL PF>0.9**  
**36W With Driver 60x60cm**

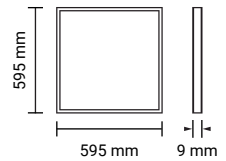
Product code	DL36-A1	Beam Angle	120°
Watts	36W	CRI	Ra>80
Input Voltage	AC : 220-240V	IP Rating	IP20
Flux	3600lm	BOX Qty	6 PCS

 SKU: 2711    SKU:2712    SKU: 2713  
 6000K    4500K    2700K

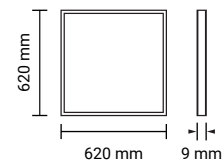

 6 PCS  
 BOX

**LED PANEL Single Pack PF>0.9**  
**36W With Driver 62x62cm**
**3600**  
 Lumens
 
 IP20

Product code	DL36-A4	Beam Angle	120°
Watts	36W	CRI	Ra>80
Input Voltage	AC : 220-240V	IP Rating	IP20
Flux	3600lm	BOX Qty	1 PCS

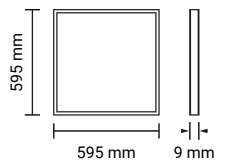

 SKU: 2704    SKU:2705    SKU: 2706  
 6000K    4500K    2700K

**LED PANEL PF>0.9**  
**36W With Driver 60x60cm**
**3600**  
 Lumens
 
 IP20

Product code	DL36-A1	Beam Angle	120°
Watts	36W	CRI	Ra>80
Input Voltage	AC : 220-240V	IP Rating	IP20
Flux	3600lm	BOX Qty	6 PCS

 SKU: 2717    SKU:2718  
 6000K    4500K

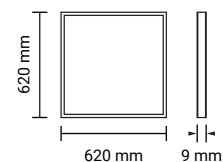
 6 PCS  
 BOX

**LED PANEL Single Pack PF>0.9**  
**36W With Driver 62x62cm**
**3600**  
 Lumens
 
 IP20



Product code	DL36-A4	Beam Angle	120°
Watts	36W	CRI	Ra>80
Input Voltage	AC : 220-240V	IP Rating	IP20
Flux	3600lm	BOX Qty	1 PCS

 SKU: 2707    SKU:2708  
 6000K    4500K

**LED PANEL PF>0.95**  
**36W With Driver 60x60cm**
**3500**  
 Lumens
 
 IP20

Product code	DL36-A2	Beam Angle	120°
Watts	36W	CRI	Ra>80
Input Voltage	AC : 175-265V	IP Rating	IP20
Flux	3500lm	BOX Qty	1 PCS

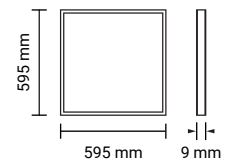
**TP(b)RATED**  
 Polycarbonate Diffuser

 SKU: 2744    SKU:2745  
 6000K    4500K

 3 Years  
 Warranty

**LED PANEL PF>0.9**  
**36W With Driver 62x62cm**
**3600**  
 Lumens
 
 IP20

Product code	DL36-A3	Beam Angle	120°
Watts	36W	CRI	Ra>80
Input Voltage	AC : 175-265V	IP Rating	IP20
Flux	3600lm	BOX Qty	1 PCS

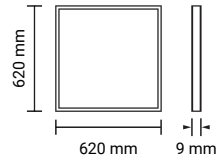

 SKU: 2734   SKU:2735   SKU: 2736  
 6000K   4500K   2700K

**LED BACKLIT PANEL PF>0.9**  
**40W With Driver 60x60cm**

IP20

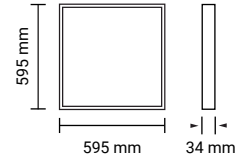

Product code	DL40-A3	Beam Angle	120°
Watts	40W	CRI	Ra>80
Input Voltage	AC : 220-240V	IP Rating	IP20
Flux	3400lm	BOX Qty	10 PCS

 10 PCS  
 BOX

 SKU: 2772   SKU:2773  
 6000K   4500K

**LED PANEL PF>0.9**  
**36W With Driver 62x62cm**
**3060**  
 Lumens
 
 IP20

Product code	DL36-A3	Beam Angle	120°
Watts	36W	CRI	Ra>80
Input Voltage	AC : 175-265V	IP Rating	IP20
Flux	3060lm	BOX Qty	6 PCS

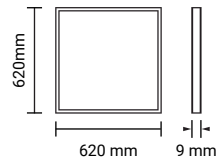
 6 PCS  
 BOX

 SKU: 2737   SKU:2738   SKU: 2739  
 6000K   4500K   2700K

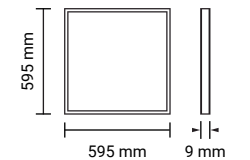
**LED PANEL PF>0.9**  
**45W With Driver 60x60cm**
**3600**  
 Lumens
 
 IP20

Product code	DL45-A5	Beam Angle	120°
Watts	45W	CRI	Ra>80
Input Voltage	AC : 175-265V	IP Rating	IP20
Flux	3600lm	BOX Qty	1 PCS

 SKU: 2391   SKU:2392  
 6000K   4500K

**120**  
 Lumens/W

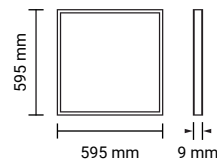
**LED PANEL PF>0.9**  
**40W With Driver 60x60cm**
**4800**  
 Lumens
 
 IP20

Product code	DL40-A1	Beam Angle	120°
Watts	40W	CRI	Ra>80
Input Voltage	AC : 175-265V	IP Rating	IP20
Flux	4800lm	BOX Qty	1 PCS

 SKU: 2726   SKU:2727   SKU: 2728  
 6000K   4500K   2700K

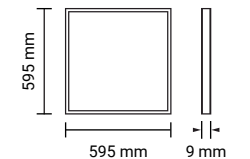
**LED PANEL PF>0.9**  
**45W With Driver 60x60cm**
**4500**  
 Lumens
 
 IP20

Product code	DL45-A1	Beam Angle	120°
Watts	45W	CRI	Ra>80
Input Voltage	AC : 175-265V	IP Rating	IP20
Flux	4500lm	BOX Qty	6 PCS

 SKU: 2372   SKU:2373   SKU: 2374  
 6000K   4500K   2700K

**5**  
 Years  
 Warranty

**LED PANEL PF>0.9**  
**45W With Driver 60x60cm**

Product code	DL45-A5	Beam Angle	120°
Watts	45W	CRI	Ra>80
Input Voltage	AC : 175-265V	IP Rating	IP20
Flux	3600lm	BOX Qty	6 PCS

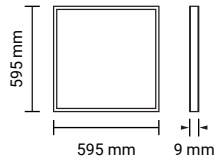
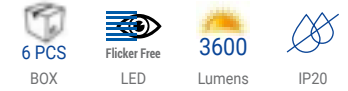

SKU: 2394    SKU:2395    SKU: 2396  
 6000K    4500K    2700K

**LED PANEL PF>0.9**  
**45W With Driver 62x62cm**

Product code	DL45-A5	Beam Angle	120°
Watts	45W	CRI	Ra>95
Input Voltage	AC : 175-265V	IP Rating	IP20
Flux	3600lm	BOX Qty	6 PCS

SKU: 2797    SKU:2798    SKU: 2799  
 6000K    4500K    2700K

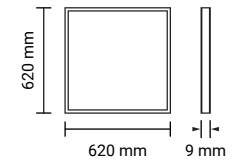
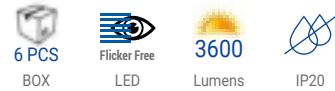
**LED PANEL PF>0.9**  
**45W With Driver 60x60cm**

Product code	DL45-A5	Beam Angle	120°
Watts	45W	CRI	Ra>95
Input Voltage	AC : 175-265V	IP Rating	IP20
Flux	3600lm	BOX Qty	6 PCS

SKU: 2397    SKU:2398    SKU: 2399  
 6000K    4500K    2700K

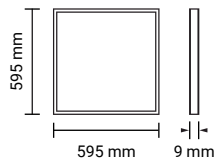
**LED PANEL Single Pack PF>0.9**  
**45W With Driver 62x62cm**

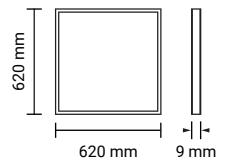

Product code	DL45-A4	Beam Angle	120°
Watts	45W	CRI	Ra>80
Input Voltage	AC : 220-240V	IP Rating	IP20
Flux	3600lm	BOX Qty	1 PCS

SKU: 2791    SKU:2792    SKU: 2793  
 6000K    4500K    2700K

**LED PANEL Single Pack PF>0.9**  
**45W With Driver 62x62cm**

Product code	DL45-A5	Beam Angle	120°
Watts	45W	CRI	Ra>80
Input Voltage	AC : 175-265V	IP Rating	IP20
Flux	3600lm	BOX Qty	1 PCS

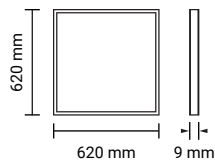
SKU: 2788    SKU:2789    SKU: 2790  
 6000K    4500K    2700K

**LED PANEL PF>0.9**  
**45W With Driver 62x62cm**



Product code	DL45-A4	Beam Angle	120°
Watts	45W	CRI	Ra>80
Input Voltage	AC : 175-265V	IP Rating	IP20
Flux	3600lm	BOX Qty	6 PCS

SKU: 2794    SKU:2795    SKU: 2796  
 6000K    4500K    2700K

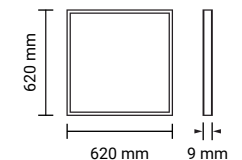





**LED FRAME PANEL PF>0.9**  
**36W With Driver 60x60cm**

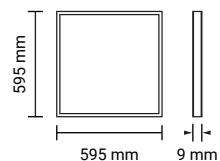

Product code	DL36-A4	Beam Angle	120°
Watts	36W	CRI	Ra>80
Input Voltage	AC : 220-240V	IP Rating	IP20
Flux	3600lm	BOX Qty	2 PCS

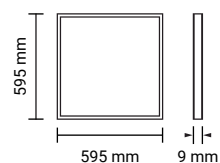
 SKU: 2746  
 ■ 6000K

**LED FRAME PANEL PF>0.9**  
**45W With Driver 60x60cm**

Product code	DL45-A2	Beam Angle	120°
Watts	45W	CRI	Ra>80
Input Voltage	AC : 220-240V	IP Rating	IP20
Flux	3600lm	BOX Qty	2 PCS

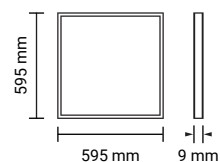
 SKU: 2781    SKU: 2782  
 ■ 6000K    ■ 4500K

**LED PANEL CLOUD OPTIC**  
**45W With Driver 60x60cm**

Product code	DL45-A3	Beam Angle	120°
Watts	45W	CRI	Ra>80
Input Voltage	AC : 220-240V	IP Rating	IP20
Flux	3600lm	BOX Qty	4 PCS

 SKU: 2780  
 ■ 6000K

LED Panels are flat, their extremely thin profile is only made possible through the use of compact LEDs. The main advantage here is that the lamp itself – both modern and minimalist – takes a back seat, creating a tidier interior aesthetic. Because the light takes up very little space, it helps to make the room appear larger. As a result, LED panels work well even in the smallest of rooms.



6 PCS  
BOX

**LED PANEL PF>0.9**  
**36W With Driver 120x30cm**

3600 Lumens IP20

Product code	DL36-A1	Beam Angle	120°
Watts	36W	CRI	Ra>80
Input Voltage	AC : 220-240V	IP Rating	IP20
Flux	3600lm	BOX Qty	6 PCS

SKU: 2714 6000K  
SKU: 2715 4500K  
SKU: 2716 2700K

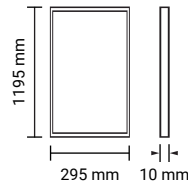

**DRIVERS FOR LED PANELS**  
**Dimmable**

Dimmable IP20

SKU: 6031	600mA	30-42V	25W
SKU: 6032	900mA	30-42V	36W
SKU: 6028	1000mA	30-45V	45W

Watts	25W	36W	45W
Input Voltage	AC: 180-265V	AC: 180-265V	AC: 180-265V
Output Voltage	DC: 30-42V	DC: 30-42V	DC: 30-45V
Material	Plastic	Plastic	Plastic
IP Rating	IP20	IP20	IP20
Product code	AC1-A7	AC1-A8	AC1-A6

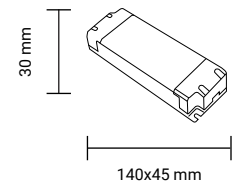

**LED SLIM PANEL Single Pack PF>0.9**  
**36W With Driver 120x30cm**

3600 Lumens IP20

Product code	DL36-A1	Beam Angle	120°
Watts	36W	CRI	Ra>80
Input Voltage	AC : 220-240V	IP Rating	IP20
Flux	3600lm	BOX Qty	1 PCS

SKU: 2731 6000K  
SKU: 2732 4500K  
SKU: 2733 2700K

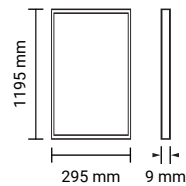

**EMERGENCY BATTERY PACK**  
**FOR LED PANELS**

Battery IP20



Product code	AC1-A9
Battery	3.6V / 4.5Ah
Material	Plastic
Dimension	213x95x40mm
Emergency duration	3 Hours
Dimensional	213x95x45mm

SKU: 6029 Battery Pack

**LED DALI DRIVER - Adjustable**  
**FOR LED PANELS**

IP20



Watts	20-40W
Input Voltage	AC: 220-240V
Output Current	550mA-1050mA
Output Voltage	25V-42V
Material	Plastic
Dimensional	106x70x45mm

Emergency duration 3 Hours

SKU: 6030 20W-40W



**LED PANEL PF>0.9**  
**45W With Driver 120x30cm**

4500 Lumens IP20

Product code	DL45-A1	Beam Angle	120°
Watts	45W	CRI	Ra>80
Input Voltage	AC : 220-240V	IP Rating	IP20
Flux	4500lm	BOX Qty	1 and 6 PCS

1 PCS BOX  
SKU: 2385 6000K  
SKU: 2386 4500K  
SKU: 2387 2700K

6 PCS BOX  
SKU: 2375 6000K  
SKU: 2376 4500K  
SKU: 2377 2700K

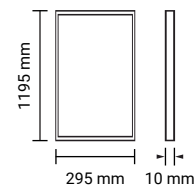



## DRIVERS FOR LED PANELS

**Plastic Case**

SKU: 6019	900mA	36W
SKU: 6021	950mA	45W
SKU: 6022	750mA	48W

Watts	36W	45W	48W
Input Voltage	AC: 175-240V	AC: 175-240V	AC: 175-240V
Output Current	900mA	950mA	750mA
Material	Plastic	Plastic	Plastic
IP Rating	IP20	IP20	IP20

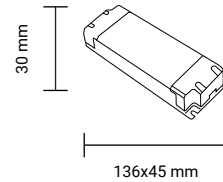

## Accessories for Hanging

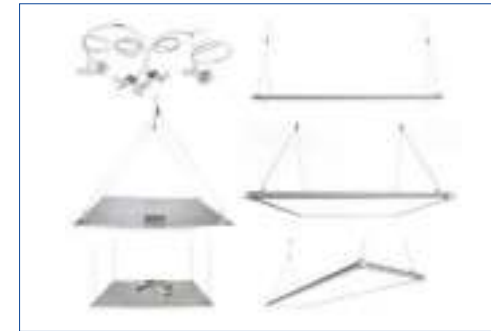
**Stainless Steel Rope**

SKU: 5182

**Clips for LED Panels**

SKU: 5188



## DRIVERS FOR LED DOWNLIGHTS

**Plastic Case**

SKU: 6035	3-12V	3W
SKU: 6036	15-24V	6W
SKU: 6037	20-40V	12W
SKU: 6038	40-60V	18W
SKU: 6039	60-80V	24W

Watts	3W	6W	12W	18W	24W
Input Voltage	AC: 85-265V	AC: 85-265V	AC: 85-265V	AC: 85-265V	AC: 85-265V
Output Voltage	DC: 3-12V	DC: 15-24V	DC: 20-40V	DC: 40-60V	DC: 60-80V
Material	Plastic	Plastic	Plastic	Plastic	Plastic
IP Rating	IP20	IP20	IP20	IP20	IP20

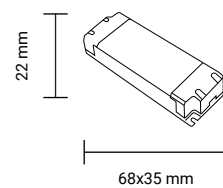

## FRAMES FOR LED PANELS

SKU: 5198	Dimension	600x600mm
SKU: 5197	Dimension	300x1200mm







These LED mini panel lights are suitable for recessed installation in offices, hospitals, schools. Easy and quick mounting, there is no need of maintenance, offering long lifetime up of 25 000h

**Features:**

- Up to 80% power saving
- Different sizes to fit old installations or new lighting projects
- Build-in

**Application:**

- Home or office use
- Accent lights for shops or stores

**LED RECESSED PANELS**



**LED RECESSED PANELS**

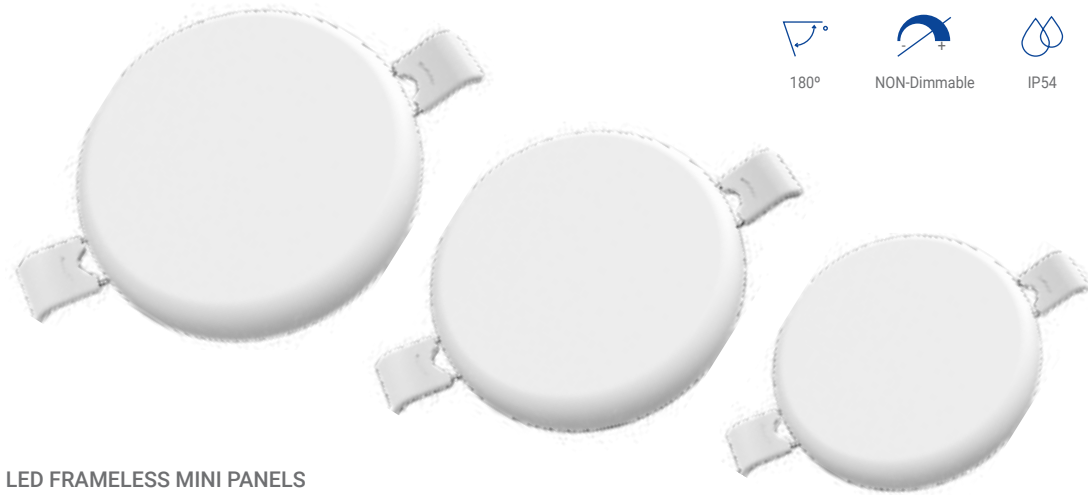

LED FRAMELESS MINI PANELS  
**ROUND**

 <b>9W</b> 760 Lumens	Product code	DL9-B2	Beam Angle	180°
	Watts	9W	CRI	Ra>80
	Input Voltage	AC : 85-265V	IP Rating	IP54
	Flux	760lm	Cutting Size	ø75mm

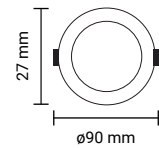

SKU: 2666  
6000K

 <b>18W</b> 1500 Lumens	Product code	DL18-B2	Beam Angle	180°
	Watts	18W	CRI	Ra>80
	Input Voltage	AC : 85-265V	IP Rating	IP54
	Flux	1500lm	Cutting Size	ø108mm

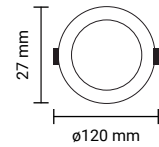

SKU: 2669 6000K    SKU: 2670 4500K    SKU: 2671 2700K

 <b>24W</b> 2010 Lumens	Product code	DL24-B2	Beam Angle	180°
	Watts	24W	CRI	Ra>80
	Input Voltage	AC : 85-265V	IP Rating	IP54
	Flux	2010lm	Cutting Size	ø155mm

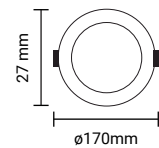

SKU: 2672 6000K    SKU: 2673 4500K    SKU: 2674 2700K

 <b>36W</b> 3020 Lumens	Product code	DL36-B3	Beam Angle	180°
	Watts	36W	CRI	Ra>80
	Input Voltage	AC : 85-265V	IP Rating	IP54
	Flux	3020lm	Cutting Size	ø206mm

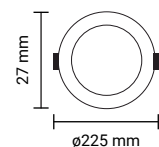

SKU: 2675 6000K    SKU: 2676 4500K    SKU: 2677 2700K

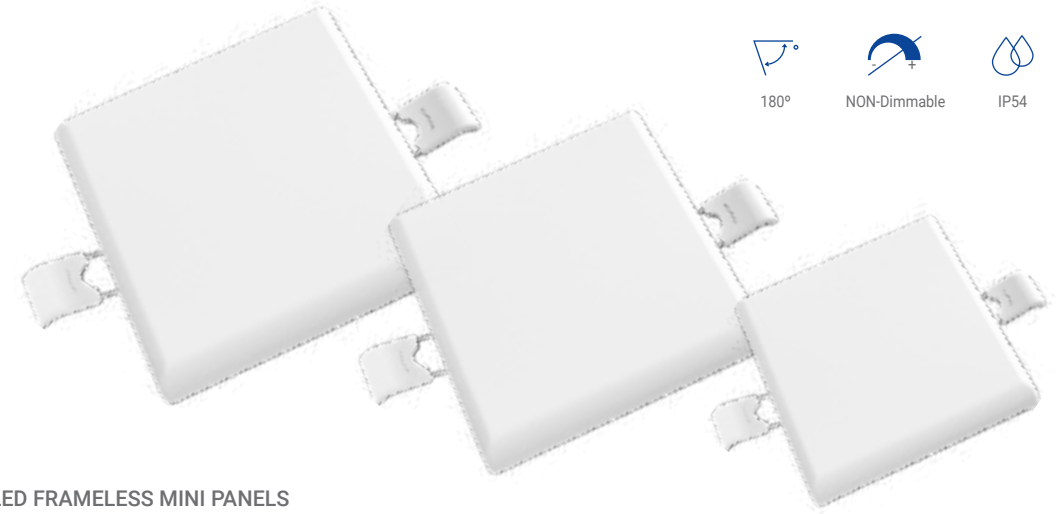

LED FRAMELESS MINI PANELS  
**SQUARE**

 <b>9W</b> 760 Lumens	Product code	DL9-B2	Beam Angle	180°
	Watts	9W	CRI	Ra>80
	Input Voltage	AC : 85-265V	IP Rating	IP54
	Flux	760lm	Cutting Size	75x75mm

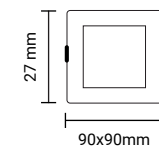

SKU: 2678 6000K    SKU: 2680 2700K

 <b>18W</b> 1500 Lumens	Product code	DL18-B2	Beam Angle	180°
	Watts	18W	CRI	Ra>80
	Input Voltage	AC : 85-265V	IP Rating	IP54
	Flux	1500lm	Cutting Size	108x108mm

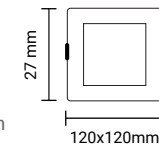

SKU: 2681 6000K    SKU: 2682 4500K    SKU: 2683 2700K

 <b>24W</b> 2010 Lumens	Product code	DL24-B2	Beam Angle	180°
	Watts	24W	CRI	Ra>80
	Input Voltage	AC : 85-265V	IP Rating	IP54
	Flux	2010lm	Cutting Size	155x155mm

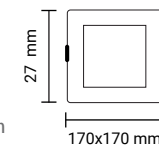

SKU: 2684 6000K    SKU: 2686 2700K

 <b>36W</b> 3020 Lumens	Product code	DL36-B3	Beam Angle	180°
	Watts	36W	CRI	Ra>80
	Input Voltage	AC : 85-265V	IP Rating	IP54
	Flux	3020lm	Cutting Size	206x206mm

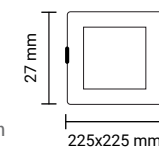

SKU: 2687 6000K    SKU: 2688 4500K    SKU: 2689 2700K



## LED MINI PANELS

**ROUND - Pro Line****TRUE COLOURS SERIES****6W****440**

Lumens

Product code	DL6-B3	Beam Angle	120°
Watts	6W	CRI	Ra>95
Input Voltage	AC : 85-265V	IP Rating	IP20
Flux	440lm	Cutting Size	ø100mm

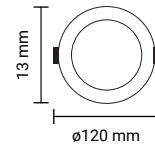

SKU: 2601	SKU: 2602	SKU: 2603
6000K	4500K	2700K

**12W****1000**

Lumens

Product code	DL12-B3	Beam Angle	120°
Watts	12W	CRI	Ra>95
Input Voltage	AC : 85-265V	IP Rating	IP20
Flux	1000lm	Cutting Size	ø150mm

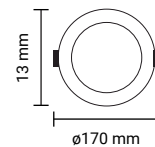

SKU: 2604	SKU: 2605	SKU: 2606
6000K	4500K	2700K

**18W****1500**

Lumens

Product code	DL18-B3	Beam Angle	120°
Watts	18W	CRI	Ra>95
Input Voltage	AC : 85-265V	IP Rating	IP20
Flux	1500lm	Cutting Size	ø200mm

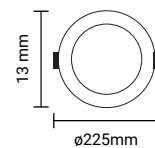

SKU: 2608	SKU: 2609	SKU: 2610
6000K	4500K	2700K

**24W****2010**

Lumens

Product code	DL24-B3	Beam Angle	120°
Watts	24W	CRI	Ra>95
Input Voltage	AC : 85-265V	IP Rating	IP20
Flux	2010lm	Cutting Size	ø270mm

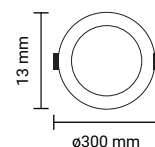

SKU: 2611	SKU: 2612	SKU: 2613
6000K	4500K	2700K



## LED MINI PANELS

**SQUARE - Pro Line****TRUE COLOURS SERIES****6W****440**

Lumens

Product code	DL6-B3	Beam Angle	120°
Watts	6W	CRI	Ra>95
Input Voltage	AC : 85-265V	IP Rating	IP20
Flux	440lm	Cutting Size	95x95mm

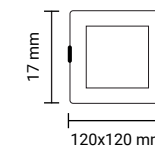

SKU: 2614	SKU: 2615	SKU: 2616
6000K	4500K	2700K

**12W****1000**

Lumens

Product code	DL12-B3	Beam Angle	120°
Watts	12W	CRI	Ra>95
Input Voltage	AC : 85-265V	IP Rating	IP20
Flux	1000lm	Cutting Size	150x150mm

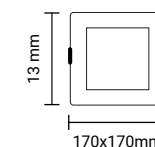

SKU: 2617	SKU: 2618	SKU: 2619
6000K	4500K	2700K

**18W****1500**

Lumens

Product code	DL18-B3	Beam Angle	120°
Watts	18W	CRI	Ra>95
Input Voltage	AC : 85-265V	IP Rating	IP20
Flux	1500lm	Cutting Size	200x200mm

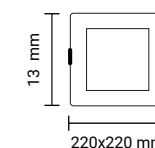

SKU: 2630	SKU: 2631	SKU: 2632
6000K	4500K	2700K

**24W****2010**

Lumens

Product code	DL24-B3	Beam Angle	120°
Watts	24W	CRI	Ra>95
Input Voltage	AC : 85-265V	IP Rating	IP20
Flux	2010lm	Cutting Size	270x270mm

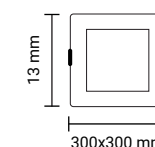

SKU: 2642	SKU: 2643	SKU: 2644
6000K	4500K	2700K





## LED MINI PANELS

**ROUND - Home Edition**

<b>3W</b>	Product code	DL3-B1	Beam Angle	120°
<b>150</b>	Watts	3W	CRI	Ra>80
Lumens	Input Voltage	AC : 85-260V	IP Rating	IP20
	Flux	150lm	Cutting Size	ø62mm

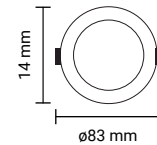

SKU: 2470	SKU: 2471	SKU: 2472
6000K	4500K	2800K

<b>6W</b>	Product code	DL6-B1	Beam Angle	120°
<b>360</b>	Watts	6W	CRI	Ra>80
Lumens	Input Voltage	AC : 85-260V	IP Rating	IP20
	Flux	360lm	Cutting Size	ø99mm

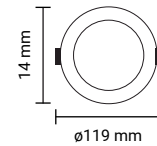

SKU: 2473	SKU: 2474	SKU: 2475
6000K	4500K	2800K

<b>12W</b>	Product code	DL12-B1	Beam Angle	120°
<b>840</b>	Watts	12W	CRI	Ra>80
Lumens	Input Voltage	AC : 85-260V	IP Rating	IP20
	Flux	840lm	Cutting Size	ø146mm

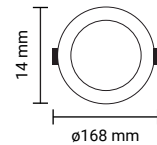

SKU: 2476	SKU: 2477	SKU: 2478
6000K	4500K	2800K

<b>18W</b>	Product code	DL18-B1	Beam Angle	120°
<b>1350</b>	Watts	18W	CRI	Ra>80
Lumens	Input Voltage	AC : 85-260V	IP Rating	IP20
	Flux	1350lm	Cutting Size	ø196mm

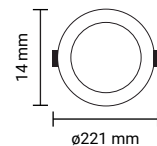

SKU: 2479	SKU: 2480	SKU: 2481
6000K	4500K	2800K

<b>24W</b>	Product code	DL24-B1	Beam Angle	120°
<b>1700</b>	Watts	24W	CRI	Ra>80
Lumens	Input Voltage	AC : 85-260V	IP Rating	IP20
	Flux	1700lm	Cutting Size	ø276mm

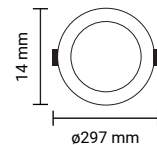

SKU: 2482	SKU: 2483	SKU: 2484
6000K	4500K	2800K



## LED MINI PANELS

**SQUARE - Home Edition**

<b>3W</b>	Product code	DL3-B1	Beam Angle	120°
<b>150</b>	Watts	3W	CRI	Ra>80
Lumens	Input Voltage	AC : 85-260V	IP Rating	IP20
	Flux	150lm	Cutting Size	67x67mm

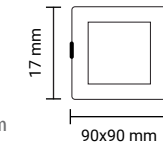

SKU: 2485	SKU: 2486	SKU: 2487
6000K	4500K	2800K

<b>6W</b>	Product code	DL6-B1	Beam Angle	120°
<b>360</b>	Watts	6W	CRI	Ra>80
Lumens	Input Voltage	AC : 85-260V	IP Rating	IP20
	Flux	360lm	Cutting Size	98x98mm

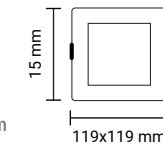

SKU: 2488	SKU: 2489	SKU: 2490
6000K	4500K	2800K

<b>12W</b>	Product code	DL12-B1	Beam Angle	120°
<b>840</b>	Watts	12W	CRI	Ra>80
Lumens	Input Voltage	AC : 85-260V	IP Rating	IP20
	Flux	840lm	Cutting Size	148x148mm

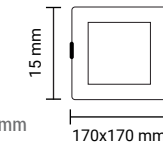

SKU: 2491	SKU: 2492	SKU: 2493
6000K	4500K	2800K

<b>18W</b>	Product code	DL18-B1	Beam Angle	120°
<b>1350</b>	Watts	18W	CRI	Ra>80
Lumens	Input Voltage	AC : 85-260V	IP Rating	IP20
	Flux	1350lm	Cutting Size	198x198mm

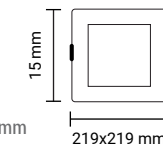

SKU: 2494	SKU: 2496	SKU: 2495
6000K	4500K	2800K

<b>24W</b>	Product code	DL24-B1	Beam Angle	120°
<b>1700</b>	Watts	24W	CRI	Ra>80
Lumens	Input Voltage	AC : 85-260V	IP Rating	IP20
	Flux	1700lm	Cutting Size	270x270mm

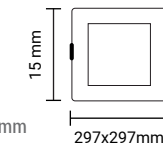

SKU: 2497	SKU: 2498	SKU: 2499
6000K	4500K	2800K



**3**  
Years  
Warranty

100°

IP44



Color Changing Knob

**CCT - LED MINI PANELS**  
**ROUND Build-in Driver**
**6W****450**

Lumens

Product code	DL6-A6	Beam Angle	100°
Watts	6W	CRI	Ra>80
Input Voltage	AC : 165-265V	IP Rating	IP44 Front
Flux	450lm	Cutting Size	ø105mm

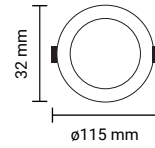

SKU: 2590

CCT Steps

6000K 4500K 3000K



**3**  
Years  
Warranty

120°

IP44



Color Changing Knob

**CCT - LED MINI PANELS**  
**SQUARE Build-in Driver**
**6W****450**

Lumens

Product code	DL6-A6	Beam Angle	100°
Watts	6W	CRI	Ra>80
Input Voltage	AC : 165-265V	IP Rating	IP44 Front
Flux	450lm	Cutting Size	105x105mm

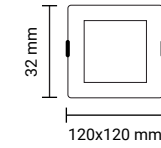

SKU: 2594

CCT Steps

6000K 4500K 3000K

**12W****950**

Lumens

Product code	DL12-A6	Beam Angle	100°
Watts	12W	CRI	Ra>80
Input Voltage	AC : 165-265V	IP Rating	IP44 Front
Flux	950lm	Cutting Size	ø155mm

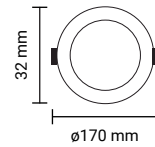

SKU: 2591

CCT Steps

6000K 4500K 3000K

**12W****950**

Lumens

Product code	DL12-A6	Beam Angle	100°
Watts	12W	CRI	Ra>80
Input Voltage	AC : 165-265V	IP Rating	IP44 Front
Flux	950lm	Cutting Size	155x155mm

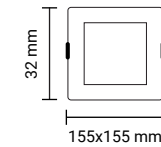

SKU: 2595

CCT Steps

6000K 4500K 3000K

**18W****1880**

Lumens

Product code	DL18-A6	Beam Angle	100°
Watts	18W	CRI	Ra>80
Input Voltage	AC : 165-265V	IP Rating	IP44 Front
Flux	1880lm	Cutting Size	ø205mm

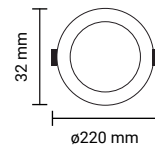

SKU: 2592

CCT Steps

6000K 4500K 3000K

**18W****1450**

Lumens

Product code	DL18-A6	Beam Angle	100°
Watts	18W	CRI	Ra>80
Input Voltage	AC : 165-265V	IP Rating	IP44 Front
Flux	1450lm	Cutting Size	205x205mm

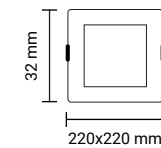

SKU: 2596

CCT Steps

6000K 4500K 3000K

**24W****2150**

Lumens

Product code	DL24-A6	Beam Angle	100°
Watts	24W	CRI	Ra>80
Input Voltage	AC : 165-265V	IP Rating	IP44 Front
Flux	2150lm	Cutting Size	ø225mm

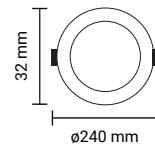

SKU: 2593

CCT Steps

6000K 4500K 3000K

**24W****2150**

Lumens

Product code	DL24-A6	Beam Angle	100°
Watts	24W	CRI	Ra>80
Input Voltage	AC : 165-265V	IP Rating	IP44 Front
Flux	2150lm	Cutting Size	205x205mm

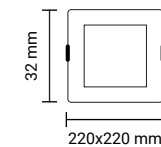

SKU: 2597

CCT Steps

6000K 4500K 3000K



LED MINI PANELS

**ROUND**

<b>3W</b>  150 Lumens	Product code	DL3-A4	Beam Angle	120°
	Watts	3W	CRI	Ra>80
	Input Voltage	AC : 85-260V	IP Rating	IP20
	Flux	150lm	Cutting Size	ø80mm

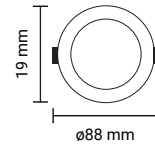

SKU: 2431 6000K  
SKU: 2432 4500K  
SKU: 2433 2700K

<b>6W</b>  360 Lumens	Product code	DL6-A4	Beam Angle	120°
	Watts	6W	CRI	Ra>80
	Input Voltage	AC : 85-260V	IP Rating	IP20
	Flux	360lm	Cutting Size	ø110mm

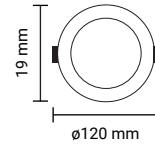

SKU: 2434 6000K  
SKU: 2435 4500K  
SKU: 2436 2700K

<b>12W</b>  840 Lumens	Product code	DL12-A4	Beam Angle	120°
	Watts	12W	CRI	Ra>80
	Input Voltage	AC : 85-260V	IP Rating	IP20
	Flux	840lm	Cutting Size	ø155mm

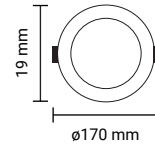

SKU: 2437 6000K  
SKU: 2438 4500K  
SKU: 2439 2700K

<b>18W</b>  1350 Lumens	Product code	DL18-A4	Beam Angle	120°
	Watts	18W	CRI	Ra>80
	Input Voltage	AC : 85-260V	IP Rating	IP20
	Flux	1350lm	Cutting Size	ø205mm

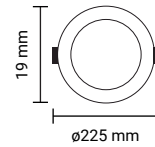

SKU: 2335 6000K  
SKU: 2440 4500K  
SKU: 2336 2700K

<b>24W</b>  1700 Lumens	Product code	DL24-A4	Beam Angle	120°
	Watts	24W	CRI	Ra>80
	Input Voltage	AC : 85-260V	IP Rating	IP20
	Flux	1700lm	Cutting Size	ø285mm

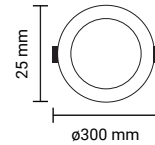

SKU: 2441 6000K  
SKU: 2442 4500K  
SKU: 2443 2700K



LED MINI PANELS

**SQUARE**

<b>3W</b>  150 Lumens	Product code	DL3-A4	Beam Angle	120°
	Watts	3W	CRI	Ra>80
	Input Voltage	AC : 85-260V	IP Rating	IP20
	Flux	150lm	Cutting Size	75x75mm

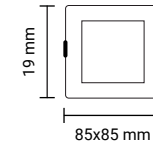

SKU: 2444 6000K  
SKU: 2445 4500K  
SKU: 2446 2700K

<b>6W</b>  360 Lumens	Product code	DL6-A4	Beam Angle	120°
	Watts	6W	CRI	Ra>80
	Input Voltage	AC : 85-260V	IP Rating	IP20
	Flux	360lm	Cutting Size	110x110mm

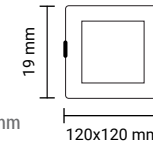

SKU: 2447 6000K  
SKU: 2448 4500K  
SKU: 2449 2700K

<b>12W</b>  840 Lumens	Product code	DL12-A4	Beam Angle	120°
	Watts	12W	CRI	Ra>80
	Input Voltage	AC : 85-260V	IP Rating	IP20
	Flux	840lm	Cutting Size	155x155mm

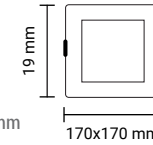

SKU: 2450 6000K  
SKU: 2451 4500K  
SKU: 2452 2700K

<b>18W</b>  1350 Lumens	Product code	DL18-A4	Beam Angle	120°
	Watts	18W	CRI	Ra>80
	Input Voltage	AC : 85-260V	IP Rating	IP20
	Flux	1350lm	Cutting Size	205x205mm

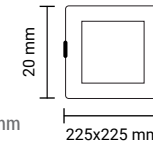

SKU: 2348 6000K  
SKU: 2453 4500K  
SKU: 2349 2700K

<b>24W</b>  1700 Lumens	Product code	DL24-A4	Beam Angle	120°
	Watts	24W	CRI	Ra>80
	Input Voltage	AC : 85-260V	IP Rating	IP20
	Flux	1700lm	Cutting Size	282x282mm

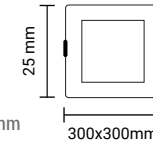

SKU: 2454 6000K  
SKU: 2455 4500K  
SKU: 2456 2700K



**3**  
Years  
Warranty

120°

Dimmable

IP44



Color Changing Knob



CCT - LED MINI PANELS

**ROUND Build-in Driver - Dimmable**

**6W**



**450**

Lumens

Product code	DL6-A7	Beam Angle	100°
Watts	6W	CRI	Ra>80
Input Voltage	AC : 220-240V	IP Rating	IP44 Front
Flux	450lm	Cutting Size	ø105mm

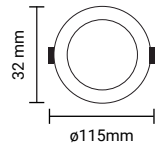

SKU: 2581

CCT Steps

6000K 4500K 3000K

**9W**



**650**

Lumens

Product code	DL9-A7	Beam Angle	100°
Watts	9W	CRI	Ra>80
Input Voltage	AC : 220-240V	IP Rating	IP44 Front
Flux	650lm	Cutting Size	ø105mm

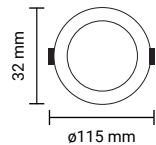

SKU: 2582

CCT Steps

6000K 4500K 3000K

**12W**



**900**

Lumens

Product code	DL16-A7	Beam Angle	100°
Watts	12W	CRI	Ra>80
Input Voltage	AC : 220-240V	IP Rating	IP44 Front
Flux	900lm	Cutting Size	ø155mm

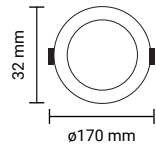

SKU: 2583

CCT Steps

6000K 4500K 3000K

**20W**



**1600**

Lumens

Product code	DL20-A7	Beam Angle	100°
Watts	20W	CRI	Ra>80
Input Voltage	AC : 220-240V	IP Rating	IP44 Front
Flux	1600lm	Cutting Size	ø205mm

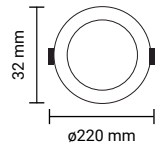

SKU: 2584

CCT Steps

6000K 4500K 3000K

**24W**



**2100**

Lumens

Product code	DL24-A7	Beam Angle	100°
Watts	24W	CRI	Ra>80
Input Voltage	AC : 220-240V	IP Rating	IP44 Front
Flux	2100lm	Cutting Size	ø225mm

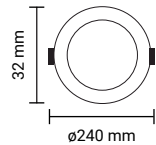

SKU: 2585

CCT Steps

6000K 4500K 3000K



Downlight Adapter

**ROUND Build-in Driver - Dimmable**

SKU: 5003

Surface 3'D105 from 6-9W  
Compatible with SKU: 2581, 2582

SKU: 5004

Surface 3'D105 from 12-16W  
Compatible with SKU: 2583

SKU: 5005

Surface 7'D205 from 18-20W  
Compatible with SKU: 2584

SKU: 5006

Surface 8'D225 from 22-24W  
Compatible with SKU: 2585



Mini Panels Dimmable Drivers



Dimmable



IP20



SKU: 6025

Dimmable Driver 220V 5-9\*1W 300mA

SKU: 6026

Dimmable Driver 220V 10-18\*1W 300mA

SKU: 6027

Dimmable Driver 220V 20-30\*1W 300mA



Slidable spring



Color Changing Knob

LED SLIM 5 in 1 BUILD-IN/SURFACE  
CCT LED 3000 to 6000K

**3** Years  
Warranty

100°

IP20

**18W**

**1600**  
Lumens

Product code DL18-A7  
Watts 18W  
Input Voltage AC : 175-265V  
Flux 1600lm

Beam Angle 100°  
CRI Ra>80  
IP Rating IP20  
Cutting Size ø65-210mm

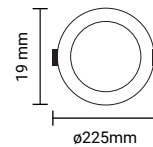

SKU: 2586

CCT Steps

6000K 4500K 3000K

**30W**

**3000**  
Lumens

Product code DL30-A7  
Watts 30W  
Input Voltage AC : 175-265V  
Flux 3000lm

Beam Angle 100°  
CRI Ra>80  
IP Rating IP20  
Cutting Size ø65-310mm

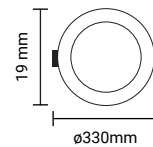

SKU: 2587

CCT Steps

6000K 4500K 3000K

NEW PRODUCT



LED CABINET LIGHT  
**1W Round - Black Body**

**60**  
Lumens

IP20

Watts 1W  
Input Voltage AC : 220-240V  
Flux 60lm

Beam Angle 28°  
CRI Ra>80  
IP Rating IP20

SKU: 3296  
3000K

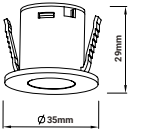

NEW PRODUCT



LED CABINET LIGHT  
**1W Round - White Body**

**60**  
Lumens

IP20

Watts 1W  
Input Voltage AC : 220-240V  
Flux 60lm

Beam Angle 28°  
CRI Ra>80  
IP Rating IP20

SKU: 3297  
3000K

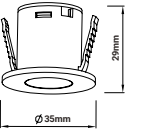

NEW PRODUCT



LED CABINET LIGHT  
**1W Square - Black Body**

**60**  
Lumens

IP20

Watts 1W  
Input Voltage AC : 220-240V  
Flux 60lm

Beam Angle 28°  
CRI Ra>80  
IP Rating IP20

SKU: 3298  
3000K

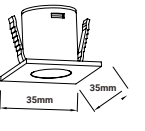

NEW PRODUCT



LED CABINET LIGHT  
**1W Square - White Body**

**60**  
Lumens

IP20

Watts 1W  
Input Voltage AC : 220-240V  
Flux 60lm

Beam Angle 28°  
CRI Ra>80  
IP Rating IP20

SKU: 3299  
3000K

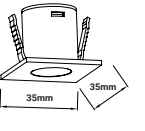



LED downlights offer a wide variety of applications, from home use as additional lights, to main or accent lighting. Applicable in homes, offices and stores.

Features:

- Up to 80% power saving
- Different sizes to fit old installations or new lighting projects
- Variety of IP ratings
- Fixed or rotatable
- Fire-rated models
- Build-in or surface installation

Application:

- Home or office use
- Accent lights for shops or stores
- Suitable for suspended ceilings

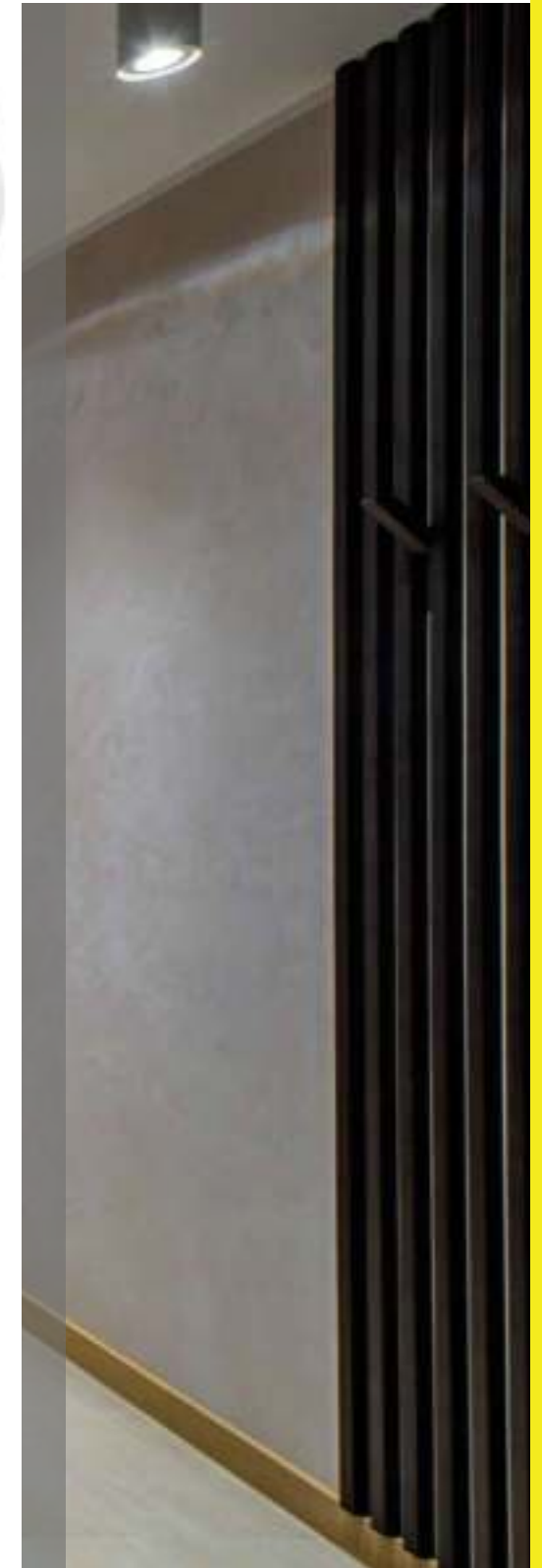

LED DOWNLIGHTS

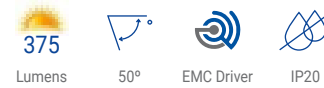

**LED COB Downlight**  
**5W Adjustable**

Product code	CB5-A1	CRI	Ra>80
Watts	5W	IP Rating	IP20
Input Voltage	AC : 100-240V	Cutting Size	ø80
Flux	375lm	Body Color	White
Beam Angle	50°	Dimmable	NO

SKU: 3264    SKU:3265    SKU: 3266  
 ■ 6000K    ■ 4500K    ■ 2700K

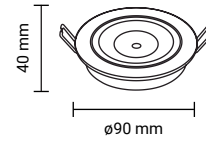
**LED COB Downlight**  
**5W Adjustable**

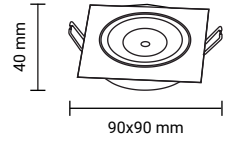

Product code	CB5-A1	CRI	Ra>80
Watts	5W	IP Rating	IP20
Input Voltage	AC : 100-240V	Cutting Size	ø80
Flux	375lm	Body Color	White
Beam Angle	50°	Dimmable	NO

SKU: 3267    SKU:3268    SKU: 3269  
 ■ 6000K    ■ 4500K    ■ 2700K

**LED COB Downlight**  
**7W Adjustable**

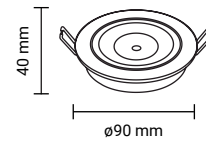

Product code	CB7-A1	CRI	Ra>80
Watts	7W	IP Rating	IP20
Input Voltage	AC : 100-240V	Cutting Size	ø80
Flux	525lm	Body Color	White
Beam Angle	50°	Dimmable	NO

SKU: 3284    SKU:3285    SKU: 3286  
 ■ 6000K    ■ 4500K    ■ 2700K

**LED COB Downlight**  
**7W Adjustable**

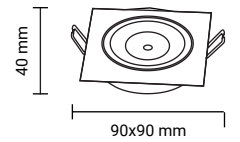
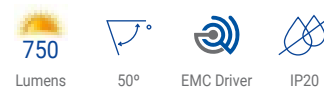

Product code	CB7-A1	CRI	Ra>80
Watts	7W	IP Rating	IP20
Input Voltage	AC : 100-240V	Cutting Size	ø80
Flux	525lm	Body Color	White
Beam Angle	50°	Dimmable	NO

SKU: 3287    SKU:3288    SKU: 3289  
 ■ 6000K    ■ 4500K    ■ 2700K

**LED COB Downlight**  
**10W Adjustable**

Product code	CB10-A1	CRI	Ra>80
Watts	10W	IP Rating	IP20
Input Voltage	AC : 100-240V	Cutting Size	ø105
Flux	750lm	Body Color	White
Beam Angle	50°	Dimmable	NO

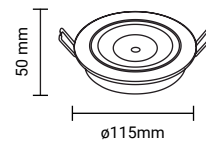
SKU: 3290    SKU:3291    SKU: 3292  
 ■ 6000K    ■ 4500K    ■ 2700K

**LED COB Downlight**  
**10W Adjustable**

Product code	CB10-A1	CRI	Ra>80
Watts	10W	IP Rating	IP20
Input Voltage	AC : 100-240V	Cutting Size	ø105
Flux	750lm	Body Color	White
Beam Angle	50°	Dimmable	NO

SKU: 3293    SKU:3294    SKU: 3295  
 ■ 6000K    ■ 4500K    ■ 2700K

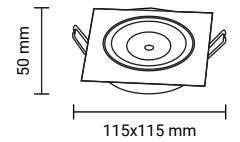

**LED COB Downlight  
8W Adjustable**

Product code	CB8-A1	CRI	Ra>80
Watts	8W	IP Rating	IP20
Input Voltage	AC : 220-265V	Cutting Size	ø80
Flux	560lm	Body Color	White
Beam Angle	60°	Dimmable	NO

SKU: 3201   SKU:3206   SKU: 3202  
 ■ 6000K   ■ 4500K   ■ 2700K

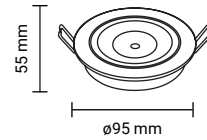
**LED COB Downlight  
12W Adjustable**

Product code	CB12-A1	CRI	Ra>80
Watts	12W	IP Rating	IP20
Input Voltage	AC : 200-265V	Cutting Size	ø105
Flux	960lm	Body Color	White
Beam Angle	60°	Dimmable	NO

SKU: 3251  
 ■ 6000K

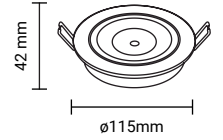
**LED COB Downlight  
8W Adjustable**

Product code	CB8-A1	CRI	Ra>80
Watts	8W	IP Rating	IP20
Input Voltage	AC : 220-265V	Cutting Size	ø80
Flux	560lm	Body Color	Inox
Beam Angle	60°	Dimmable	NO

SKU: 3203   SKU:3205   SKU: 3204  
 ■ 6000K   ■ 4500K   ■ 2700K

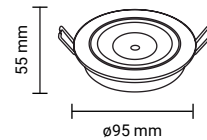
**LED COB Downlight  
12W Adjustable**

Product code	CB12-A1	CRI	Ra>80
Watts	12W	IP Rating	IP20
Input Voltage	AC : 220-265V	Cutting Size	ø105
Flux	960lm	Body Color	Inox
Beam Angle	60°	Dimmable	NO

SKU: 3254  
 ■ 6000K

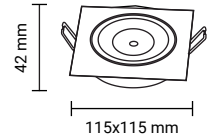
**LED COB Downlight  
8W Adjustable**

Product code	CB8-A1	CRI	Ra>80
Watts	8W	IP Rating	IP20
Input Voltage	AC : 220-265V	Cutting Size	ø80
Flux	560lm	Body Color	White
Beam Angle	60°	Dimmable	NO

SKU: 3207   SKU:3222   SKU: 3212  
 ■ 6000K   ■ 4500K   ■ 2700K

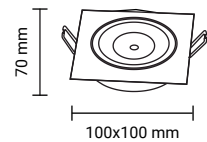
**LED COB Downlight  
25W Adjustable**

Product code	CB25-A1	CRI	Ra>80
Watts	25W	IP Rating	IP20
Input Voltage	AC : 220-240V	Cutting Size	ø160
Flux	2200lm	Body Color	White
Beam Angle	60°	Dimmable	NO

SKU: 3241   SKU:3242  
 ■ 6000K   ■ 4500K

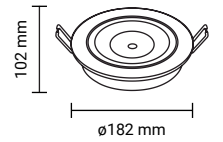
**LED COB Downlight  
8W Adjustable**

Product code	CB8-A1	CRI	Ra>80
Watts	8W	IP Rating	IP20
Input Voltage	AC : 220-265V	Cutting Size	ø80
Flux	560lm	Body Color	Inox
Beam Angle	60°	Dimmable	NO

SKU: 3223   SKU:3224   SKU: 3225  
 ■ 6000K   ■ 4500K   ■ 2700K

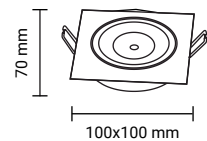
**LED COB Downlight  
35W Adjustable**

Product code	CB35-A1	CRI	Ra>80
Watts	35W	IP Rating	IP20
Input Voltage	AC : 220-240V	Cutting Size	ø210
Flux	3000lm	Body Color	Inox
Beam Angle	60°	Dimmable	NO

SKU: 3243  
 ■ 6000K

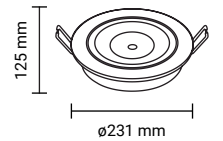

**LED COB Downlight**  
**15W - TÜV**

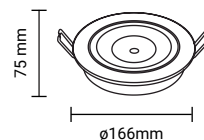

Product code	CB15-A2	CRI	Ra>80
Watts	15W	IP Rating	IP20
Input Voltage	AC : 220-240V	Cutting Size	ø155
Flux	1200lm	Body Color	White
Beam Angle	145°	Dimmable	NO

SKU: 3270   SKU:3271   SKU: 3272  
 ■ 6000K   ■ 4500K   ■ 2700K

**LED COB Downlight**  
**20W - TÜV**

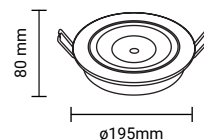

Product code	CB20-A2	CRI	Ra>80
Watts	20W	IP Rating	IP20
Input Voltage	AC : 220-240V	Cutting Size	ø165
Flux	1600lm	Body Color	White
Beam Angle	145°	Dimmable	NO

SKU: 3273   SKU:3274   SKU: 3275  
 ■ 6000K   ■ 4500K   ■ 2700K

**LED COB Downlight**  
**30W - TÜV**

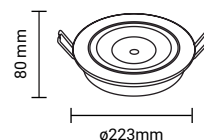

Product code	CB30-A2	CRI	Ra>80
Watts	30W	IP Rating	IP20
Input Voltage	AC : 220-240V	Cutting Size	ø195
Flux	2500lm	Body Color	White
Beam Angle	145°	Dimmable	NO

SKU: 3276   SKU:3277   SKU: 3278  
 ■ 6000K   ■ 4500K   ■ 2700K

**LED COB Downlight**  
**40W - TÜV**

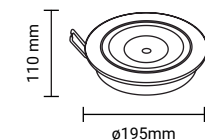

Product code	CB40-A2	CRI	Ra>80
Watts	40W	IP Rating	IP20
Input Voltage	AC : 100-240V	Cutting Size	ø175
Flux	4000lm	Body Color	White
Beam Angle	60°	Dimmable	NO

SKU: 3260   SKU:3261  
 ■ 6000K   ■ 4500K

**LED COB Downlight**  
**60W - TÜV**

Product code	CB60-A1	CRI	Ra>80
Watts	60W	IP Rating	IP20
Input Voltage	AC : 100-240V	Cutting Size	ø205
Flux	5600lm	Body Color	White
Beam Angle	60°	Dimmable	NO

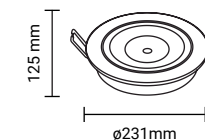
SKU: 3262   SKU:3263  
 ■ 6000K   ■ 4500K







**LED SMD FIRE-RATED PF>0.9**  
**10W - CCT 3000K to 6000K**

Product code	OT10-A1	CRI	Ra>80
Watts	10W	IP Rating	IP65
Input Voltage	AC : 200-240V	Cutting Size	ø60
Flux	750lm	Dimension	ø84x67mm
Beam Angle	40°	Dimmable	YES

SKU: 5044  
CCT Steps  
← 6000K 4500K 3000K →

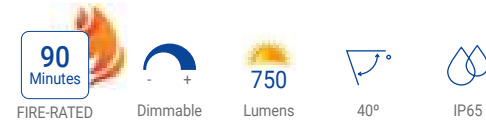
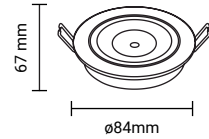

CCT Knob



**LED SMD FIRE-RATED PF>0.9**  
**6W - Replaceable covers**

Product code	OT6-A2	CRI	Ra>80
Watts	6W	IP Rating	IP65
Input Voltage	AC : 200-265V	Cutting Size	ø60
Flux	540lm	Dimension	ø84x67mm
Beam Angle	40°	Dimmable	YES

SKU: 5042    SKU: 5041  
4500K    3000K

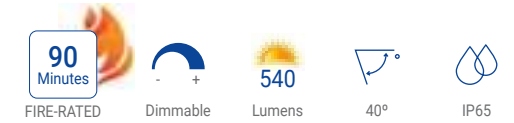

Magnetic replaceable covers



MAGNETIC CHROME BEZEL FOR 5044

**BEZELS FOR LED FIRE-RATED DOWNLIGHT**  
**Magnetic Bazels**

SKU: 5045	CHROME BEZEL
SKU: 5046	BRUSHED BEZEL

MAGNETIC BRUSHED BEZEL FOR 5044



SKU: 5045



SKU: 5046



CCT Knob

**LED SMD FIRE-RATED PF>0.9**  
**8W - CCT 3000K to 6000K**

Product code	OT8-A1	CRI	Ra>80
Watts	8W	IP Rating	IP65
Input Voltage	AC : 175-265V	Cutting Size	ø65
Flux	570-630lm	Dimension	ø80x80mm
Beam Angle	40°	Dimmable	YES

SKU: 5043    CCT    3800156650435  
← 6000K 4500K 3000K →



Magnetic replaceable covers

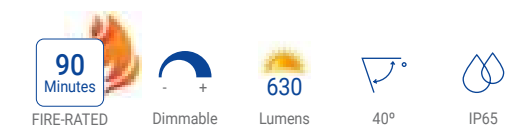



LED Strips are a flexible solution for wide variety of lighting applications, both for indoor and outdoor projects, allowing for variable shapes and abstract forms. Functioning as a core or supplementary lighting, LED strips become a common choice of lighting professionals.

**Features:**

- Up to 80% power saving
- Flexible and reliable
- Wide choice of colour – single colour light to RGB
- Variety of IP ratings
- Options for dimming and control

**Application:**

- Indoor and outdoor lighting projects
- Applicable for abstract forms and shapes
- Hidden or ambient light

**LED STRIPS AND ACCESSORIES**

**LED Strip 12V 2835 60 LEDs**  
**4.8W/m - Non Waterproof**

5m-Roll

IP20



Product code	ST2835-A1	LED Qty	60 SMD/m
Type LED	SMD 2835	Material	Flex PCB
Power/Meter	4.8W/m	Beam Angle	120°
Voltage	DC: 12V	IP Rating	IP20
Flux/Meter	300lm/m	Width	8mm

 SKU: 4702   SKU:4700   SKU: 4703  
 ■ 6000K   ■ 4500K   ■ 2700K

**LED Strip 12V 2835 60 LEDs**  
**4.8W/m - Non Waterproof**

5m-Roll

IP20



Product code	ST2835-A1	LED Qty	60 SMD/m
Type LED	SMD 2835	Material	Flex PCB
Power/Meter	4.8W/m	Beam Angle	120°
Voltage	DC: 12V	IP Rating	IP20
Flux/Meter	300lm/m	Width	8mm

 SKU: 4704   SKU:4706  
 ■ RED   ■ BLUE

**LED Strip 12V 2835 120 LEDs**  
**9.6W/m - Non Waterproof**

5m-Roll

IP20



Product code	ST2835-A1	LED Qty	120 SMD/m
Type LED	SMD 2835	Material	Flex PCB
Power/Meter	9.6W/m	Beam Angle	120°
Voltage	DC: 12V	IP Rating	IP20
Flux/Meter	600lm/m	Width	8mm

 SKU: 4710   SKU:4740   SKU: 4711  
 ■ 6000K   ■ 4500K   ■ 2700K

**LED Strip 12V 2835 204 LEDs**  
**16.5W/m - Non Waterproof**

5m-Roll

IP20



Product code	ST2835-A1	LED Qty	204 SMD/m
Type LED	SMD 2835	Material	Flex PCB
Power/Meter	16.5W/m	Beam Angle	120°
Voltage	DC: 12V	IP Rating	IP20
Flux/Meter	1700lm/m	Width	10mm

 SKU: 4761   SKU:4762   SKU: 4763  
 ■ 6000K   ■ 4500K   ■ 2700K

**LED Strip 12V 5050 60 LEDs**  
**14.4W/m - Non Waterproof**

RGB

5m-Roll

IP20



Product code	ST5050-A1	LED Qty	60 SMD/m
Type LED	SMD 5050	Material	Flex PCB
Power/Meter	14.4W/m	Beam Angle	120°
Voltage	DC: 12V	IP Rating	IP20
Flux/Meter	1000lm/m	Width	12mm

 SKU: 4313  
 ■ + ■ RGB+6000K

**LED Strip 12V 5050 60 LEDs**  
**14.4W/m - Non Waterproof**

RGB

5m-Roll

IP20



Product code	ST5050-A1	LED Qty	60 SMD/m
Type LED	SMD 5050	Material	Flex PCB
Power/Meter	14.4W/m	Beam Angle	120°
Voltage	DC: 12V	IP Rating	IP20
Flux/Meter	1000lm/m	Width	12mm

 SKU: 4314  
 ■ + ■ RGB+3000K



**LED Strip 12V 2835 60 LEDs**  
**4.8W/m - Waterproof**

5m-Roll

IP54

Product code	ST2835-A2	LED Qty	60 SMD/m
Type LED	SMD 2835	Material	Flex PCB
Power/Meter	4.8W/m	Beam Angle	120°
Voltage	DC: 12V	IP Rating	IP54
Flux/Meter	300lm/m	Width	8mm

 SKU: 4732    SKU:4731    SKU: 4733  
 6000K    4500K    2700K

**LED Strip 12V 5050 30 LEDs**  
**7.2W/m - Non Waterproof**

5m-Roll

IP20

Product code	ST5050-A1	LED Qty	30 SMD/m
Type LED	SMD 5050	Material	Flex PCB
Power/Meter	7.2W/m	Beam Angle	120°
Voltage	DC: 12V	IP Rating	IP20
Flux/Meter	500lm/m	Width	10mm

 SKU: 4801    SKU:4800    SKU: 4802  
 6000K    4500K    2700K

**LED Strip 12V 2835 60 LEDs**  
**4.8W/m - Waterproof**

5m-Roll

IP54

Product code	ST2835-A2	LED Qty	60 SMD/m
Type LED	SMD 2835	Material	Flex PCB
Power/Meter	4.8W/m	Beam Angle	120°
Voltage	DC: 12V	IP Rating	IP54
Flux/Meter	300lm/m	Width	8mm

 SKU: 4734    SKU:4735    SKU: 4736  
 RED    GREEN    BLUE

**LED Strip 12V 5050 60 LEDs**  
**14.4W/m - Non Waterproof**

5m-Roll

IP20

Product code	ST5050-A1	LED Qty	60 SMD/m
Type LED	SMD 5050	Material	Flex PCB
Power/Meter	14.4W/m	Beam Angle	120°
Voltage	DC: 12V	IP Rating	IP20
Flux/Meter	1000lm/m	Width	10mm

 SKU: 4807    SKU:4827    SKU: 4808  
 6000K    4500K    2700K

**LED Strip 12V 2835 120 LEDs**  
**9.6W/m - Waterproof**

5m-Roll

IP54

Product code	ST2835-A2	LED Qty	120 SMD/m
Type LED	SMD 2835	Material	Flex PCB
Power/Meter	9.6W/m	Beam Angle	120°
Voltage	DC: 12V	IP Rating	IP54
Flux/Meter	600lm/m	Width	8mm

 SKU: 4720    SKU:4721  
 6000K    2700K

**LED Strip 12V 5050 60 LEDs**  
**14.4W/m - Non Waterproof**

5m-Roll

IP20

Product code	ST5050-A1	LED Qty	60 SMD/m
Type LED	SMD 5050	Material	Flex PCB
Power/Meter	14.4W/m	Beam Angle	120°
Voltage	DC: 12V	IP Rating	IP20
Flux/Meter	1000lm/m	Width	10mm

 SKU: 4823    SKU:4825  
 RED    BLUE



LED Strip 12V 5050 30 LEDs  
**7.2W/m - Waterproof**



Product code	ST5050-A2	LED Qty	30 SMD/m
Type LED	SMD 5050	Material	Flex PCB
Power/Meter	7.2W/m	Beam Angle	120°
Voltage	DC: 12V	IP Rating	IP54
Flux/Meter	500lm/m	Width	10mm

SKU: 4809   SKU:4811   SKU: 4810  
 6000K   4500K   2700K



LED Strip 12V 5050 30 LEDs  
**7.2W/m**



Product code	ST5050-A1	LED Qty	30 SMD/m
Type LED	SMD 5050	Material	Flex PCB
Power/Meter	7.2W/m	Beam Angle	120°
Voltage	DC: 12V	IP Rating	IP20 ; IP54
Flux/Meter	500lm/m	Width	10mm

SKU: 4311 RGB   IP20  
 SKU: 4315 RGB   IP54



LED Strip 12V 5050 60 LEDs  
**14.4W/m - Waterproof**



Product code	ST5050-A2	LED Qty	60 SMD/m
Type LED	SMD 5050	Material	Flex PCB
Power/Meter	14.4W/m	Beam Angle	120°
Voltage	DC: 12V	IP Rating	IP54
Flux/Meter	1000lm/m	Width	10mm

SKU: 4839   SKU:4841   SKU: 4840  
 6000K   4500K   2700K



LED Strip 12V 5050 60 LEDs  
**14.4W/m**



Product code	ST5050-A1	LED Qty	60 SMD/m
Type LED	SMD 5050	Material	Flex PCB
Power/Meter	14.4W/m	Beam Angle	120°
Voltage	DC: 12V	IP Rating	IP20 ; IP54
Flux/Meter	1000lm/m	Width	10mm

SKU: 4312 RGB   IP20  
 SKU: 4316 RGB   IP54



LED Strip 12V 5050 60 LEDs  
**14.4W/m - Waterproof**



Product code	ST5050-A2	LED Qty	60 SMD/m
Type LED	SMD 5050	Material	Flex PCB
Power/Meter	14.4W/m	Beam Angle	120°
Voltage	DC: 12V	IP Rating	IP54
Flux/Meter	1000lm/m	Width	10mm

SKU: 4842   SKU:4843  
 RED   BLUE



LED Strip 24V 5050 60 LEDs  
**14.4W/m**



Product code	ST5050-A1	LED Qty	60 SMD/m
Type LED	SMD 5050	Material	Flex PCB
Power/Meter	14.4W/m	Beam Angle	120°
Voltage	DC: 24V	IP Rating	IP20 ; IP54
Flux/Meter	1000lm/m	Width	10mm

SKU: 4861 RGB   3800156648616   IP20  
 SKU: 4862 RGB   3800156648623   IP54



**LED Strip 12V 4040 60 LEDs**  
**8.5W/m - Non Waterproof**

Product code	ST4040-A1	LED Qty	60 SMD/m
Type LED	SMD 4040	Material	Flex PCB
Power/Meter	8.5W/m	Beam Angle	120°
Voltage	DC: 12V	IP Rating	IP20
Flux/Meter	500lm/m	Width	10mm

SKU: 4921   SKU:4922   SKU: 4923  
 6000K   4500K   2700K

**LED Strip 24V 2835 120 LEDs**  
**9.6W/m - Non Waterproof**

Product code	ST2835-A3	LED Qty	120 SMD/m
Type LED	SMD 2835	Material	Flex PCB
Power/Meter	9.6W/m	Beam Angle	120°
Voltage	DC: 24V	IP Rating	IP20
Flux/Meter	1200lm/m	Width	10mm

SKU: 4856   SKU:4857   SKU: 4858  
 6000K   4500K   2700K

**LED Strip 12V 4014 120 LEDs**  
**12W/m - Non Waterproof**

Product code	ST4014-A1	LED Qty	120 SMD/m
Type LED	SMD 4014	Material	Flex PCB
Power/Meter	12W/m	Beam Angle	120°
Voltage	DC: 12V	IP Rating	IP20
Flux/Meter	1000lm/m	Width	8mm

SKU: 4904   SKU:4905   SKU: 4906  
 6000K   4500K   2700K

**LED Strip 24V 5050 60 LEDs**  
**14.4W/m - Non Waterproof**

Product code	ST5050-A3	LED Qty	60 SMD/m
Type LED	SMD 5050	Material	Flex PCB
Power/Meter	14.4W/m	Beam Angle	120°
Voltage	DC: 24V	IP Rating	IP20
Flux/Meter	600lm/m	Width	10mm

SKU: 4851   SKU:4850   SKU: 4852  
 6000K   4500K   2700K

**LED Strip 12V 5630 60 LEDs**  
**12W/m - Non Waterproof**

Product code	ST5630-A1	LED Qty	60 SMD/m
Type LED	SMD 5630	Material	Flex PCB
Power/Meter	12W/m	Beam Angle	120°
Voltage	DC: 12V	IP Rating	IP20
Flux/Meter	1000lm/m	Width	10mm

SKU: 4911   SKU:4913   SKU: 4912  
 6000K   4500K   2700K

**LED Strip 24V 5050 60 LEDs**  
**14.4W/m - Waterproof**

Product code	ST5050-A4	LED Qty	60 SMD/m
Type LED	SMD 5050	Material	Flex PCB
Power/Meter	14.4W/m	Beam Angle	120°
Voltage	DC: 24V	IP Rating	IP54
Flux/Meter	600lm/m	Width	10mm

SKU: 4853   SKU:4854   SKU: 4855  
 6000K   4500K   2700K





**LED Strip 24V COB 320 LEDs**  
**10W/m - Non Waterproof**

Product code	ST320-A1	LED Qty	320 SMD/m
Type LED	COB	Material	Flex PCB
Power/Meter	10W/m	Beam Angle	120°
Voltage	DC: 24V	IP Rating	IP20
Flux/Meter	900lm/m	Width	10mm

SKU: 4941   SKU: 4942   SKU: 4943  
 6000K   4000K   3000K

**LED Strip 24V COB 512 LEDs**  
**12W/m - Non Waterproof**

Product code	ST512-A1	LED Qty	512 SMD/m
Type LED	COB	Material	Flex PCB
Power/Meter	10W/m	Beam Angle	120°
Voltage	DC: 24V	IP Rating	IP20
Flux/Meter	1100lm/m	Width	10mm

SKU: 4944   SKU: 4945   SKU: 4946  
 6000K   4000K   3000K

**Middel connector**

SKU: 6622

**One end connector with wire**

SKU: 6623

**Two end connector**

SKU: 6624

**LED Strip 24V 2835 196 LEDs**  
**20W/m - Non Waterproof**

Product code	ST2835-A4	LED Qty	196 SMD/m
Type LED	SMD 2835	Material	Flex PCB
Power/Meter	20W/m	Beam Angle	120°
Voltage	DC: 24V	IP Rating	IP20
Flux/Meter	2100lm/m	Width	12mm

SKU: 4421   SKU: 4422   SKU: 4423  
 6000K   4500K   2700K

**LED Strip 24V 2835 196 LEDs**  
**20W/m - Waterproof**

Product code	ST2835-A5	LED Qty	196 SMD/m
Type LED	SMD 2835	Material	Flex PCB
Power/Meter	20W/m	Beam Angle	120°
Voltage	DC: 24V	IP Rating	IP65
Flux/Meter	2100lm/m	Width	12mm

SKU: 4451   SKU: 4452   SKU: 4453  
 6000K   4500K   2700K

**LED Strip 24V 5054 60 LEDs**  
**16W/m - Non Waterproof**

Product code	ST5054-A1	LED Qty	60 SMD/m
Type LED	SMD 5054	Material	Flex PCB
Power/Meter	16W/m	Beam Angle	120°
Voltage	DC: 24V	IP Rating	IP20
Flux/Meter	1100lm/m	Width	12mm

SKU: 4431   SKU: 4432   SKU: 4433  
 6000K   4500K   2700K



**LED Strip 24V COB 320 LEDs D Shape  
20W/m - Waterproof**

Product code	ST320-A2	LED Qty	320 SMD/m
Type LED	COB	Material	Flex PCB
Power/Meter	10W/m	Beam Angle	120°
Voltage	DC: 24V	IP Rating	IP65
Flux/Meter	900lm/m	Width	10x4mm

SKU: 4947   SKU: 4948   SKU: 4949  
 6000K   4500K   3000K

**LED Strip 24V COB 320 LEDs  
10W/m - Non Waterproof**

Product code	ST320-A2	LED Qty	320 SMD/m
Type LED	COB	Material	Flex PC
Power/Meter	10W/m	Beam Angle	120°
Voltage	DC: 24V	IP Rating	IP20
Flux/Meter	1000lm/m	Dimension	5x5000 mm

SKU: 4931   SKU: 4932   SKU: 4933  
 6000K   4500K   3000K

**LED Strip 24V COB 640 LEDs  
12W/m - Non Waterproof**

Product code	ST640-A1	LED Qty	640 SMD/m
Type LED	COB	Material	Flex PCB
Power/Meter	12W/m	Beam Angle	120°
Voltage	DC: 24V	IP Rating	IP20
Flux/Meter	500lm/m	Width	12x2.5mm

SKU: 4950  
 RGB+6000K

**LED Strip 48V COB 504 LEDs  
6W/m - Non Waterproof**

Product code	ST320-A2	LED Qty	504 SMD/m
Type LED	COB	Material	Flex PC
Power/Meter	6W/m	Beam Angle	120°
Voltage	DC: 48V	IP Rating	IP20
Flux/Meter	630lm/m	Dimension	10x25000 mm

SKU: 4934   SKU: 4935   SKU: 4936  
 6000K   4500K   3000K

**LED Strip 24V COB 504 LEDs -Milky  
6W/m - Waterproof**

Product code	ST504-A2	LED Qty	504 SMD/m
Type LED	COB	Material	Flex PC
Power/Meter	6W/m	Beam Angle	120°
Voltage	DC: 24V	IP Rating	IP67
Flux/Meter	500lm/m	Dimension	10x20000 mm

SKU: 4937   SKU: 4938   SKU: 4939  
 6000K   4500K   3000K



**LED Strip 24V 2835 120 LEDs**  
**9W/m - Non Waterproof**

Product code	ST2835-A3	LED Qty	120 SMD/m
Type LED	SMD 2835	Material	Flex PCB
Power/Meter	9W/m	Beam Angle	120°
Voltage	DC: 24V	IP Rating	IP20
Flux/Meter	1000lm/m	Width	8x2.5mm

SKU: 4865    SKU: 4866    SKU: 4867  
 6000K    4500K    3000K

**LED Strip 24V 2835 120 LEDs**  
**10W/m - Non Waterproof**  
**Runnig Water Effect**

Product code	ST120-A1	LED Qty	120 SMD/m
Type LED	SMD 2835	Material	Flex PCB
Power/Meter	10W/m	Beam Angle	120°
Voltage	DC: 24V	IP Rating	IP20
Flux/Meter	950lm/m	Width	8x2.5mm

SKU: 4940  
 4500K

**RF Controller For Running Water Effect**

Input: DC12-24V  
 Output: 1 group SPI signal  
 Mode: 28 kinds  
 Central IC point: 2048 point  
 Support IC: WS2811, WS2812, 16703, UCS1903  
 SIZE: 40x12x5mm

SKU: 6541

**Amplifier**

Voltage: DC5-24V  
 Output: 2x4=8 group SPI singnal  
 Function: Multiple separate controllers by connect in parallel  
 Remark: 8 pcs light can change at same step with connection in parallel

SKU: 6542



2 PIN connector for 8MM COB  
 SKU: 6549



2 PIN fasten connector 8MM SMD  
 SKU: 6552



3 PIN connector 10mm 3PIN SMD  
 SKU: 6555



5 PIN DUAL connector 10mm 5 IN SMD RGBW  
 SKU: 6558



SMD 10mm PCB single color 2 pin  
 SKU: 6561



SMD 10mm PCB 3 pin (CCT, magic RGB) 15cm  
 SKU: 6564



PIN connector for 8MM SMD  
 SKU: 6550



2 PIN fasten DUAL connector 8MM COB  
 SKU: 6553



3 PIN connector with wirep 10mm 3PIN SMD  
 SKU: 6556



6 PIN connectro 12mm 6 PIN SMD  
 SKU: 6559



DUAL SMD 10mm PCB single color 2 pin  
 SKU: 6562



SMD 10mm PCB 4 pin (RGB)  
 SKU: 6565



2 PIN fasten connector 8MM COB  
 SKU: 6551



2 PIN fasten DUAL connector 8MM SMD  
 SKU: 6554



5 PIN connector 10mm 5PIN SMD RGBW  
 SKU: 6557



6 PIN DUAL connector 12mm 6 PIN SMD  
 SKU: 6560

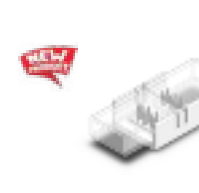

SMD 10mm PCB 3 pin (CCT, magic RGB)  
 SKU: 6563



SMD 10mm PCB 5 pin (RGBW)  
 SKU: 6566



**LED Strip 24V 5054 60 LEDs**  
**16W/m - Waterproof**
**3**  
 Years  
 Warranty

  
 5m-Roll

  
 IP65

Product code	ST5054-A2	LED Qty	60 SMD/m
Type LED	SMD 5054	Material	Flex PCB
Power/Meter	16W/m	Beam Angle	120°
Voltage	DC: 24V	IP Rating	IP65
Flux/Meter	1100lm/m	Width	10mm

 SKU: 4461    SKU: 4462    SKU: 4463  
       

**LED Strip 12V 2835 196 LEDs**  
**20W/m - Non Waterproof**
**3**  
 Years  
 Warranty

  
 5m-Roll

  
 IP20

Product code	ST2835-A5	LED Qty	196 SMD/m
Type LED	SMD 2835	Material	Flex PCB
Power/Meter	20W/m	Beam Angle	120°
Voltage	DC: 12V	IP Rating	IP20
Flux/Meter	2100lm/m	Width	12mm

 SKU: 4424    SKU: 4425    SKU: 4426  
       

**LED Strip 24V 5025 60 LEDs**  
**16W/m - CCT Adjustable**  
**Non Waterproof**
**3**  
 Years  
 Warranty

  
 5m-Roll

  
 IP20

Product code	ST5025-A1	LED Qty	60 SMD/m
Type LED	SMD 5025	Material	Flex PCB
Power/Meter	16W/m	Beam Angle	120°
Voltage	DC: 24V	IP Rating	IP20
Flux/Meter	800lm/m	Width	10mm

 SKU: 4441  
 CCT  
       

**LED Strip 12V 2835 196 LEDs**  
**20W/m - Waterproof**
**3**  
 Years  
 Warranty

  
 5m-Roll

  
 IP65

Product code	ST2835-A6	LED Qty	196 SMD/m
Type LED	SMD 2835	Material	Flex PCB
Power/Meter	20W/m	Beam Angle	120°
Voltage	DC: 12V	IP Rating	IP65
Flux/Meter	2100lm/m	Width	12mm

 SKU: 4454    SKU: 4455    SKU: 4456  
       

**LED Strip 24V 5025 60 LEDs**  
**16W/m - CCT Adjustable**  
**Waterproof**
**3**  
 Years  
 Warranty

  
 5m-Roll

  
 IP65

Product code	ST5025-A2	LED Qty	60 SMD/m
Type LED	SMD 5025	Material	Flex PCB
Power/Meter	16W/m	Beam Angle	120°
Voltage	DC: 24V	IP Rating	IP65
Flux/Meter	800lm/m	Width	10mm

 SKU: 4471  
 CCT  
       

**LED Strip 12V 5050 60 LEDs**  
**16W/m - Non Waterproof**
  
 RGB

  
 5m-Roll

  
 IP20

Product code	ST5050-A7	LED Qty	60 SMD/m
Type LED	SMD 5050	Material	Flex PCB
Power/Meter	16W/m	Beam Angle	120°
Voltage	DC: 12V	IP Rating	IP20
Flux/Meter	1600lm/m	Width	12mm

SKU: 4485    RGB+White Light       3800156644854

SKU: 4486    RGB+Warm White       3800156644861

**3**  
 Years  
 Warranty



LED Strip 12V 5050 60 LEDs  
**16W/m - Waterproof**



Product code	ST5050-A8	LED Qty	60 SMD/m
Type LED	SMD 5050	Material	Flex PCB
Power/Meter	16W/m	Beam Angle	120°
Voltage	DC: 12V	IP Rating	IP65
Flux/Meter	1600lm/m	Width	12mm

**3**  
Years  
Warranty

SKU: 4487 RGB+White Light 3800156644878

SKU: 4488 RGB+Warm White 3800156644885



LED Strip 24V 5050 60 LEDs  
**16W/m Waterproof**



Product code	ST5050-A6	LED Qty	60 SMD/m
Type LED	SMD 5050	Material	Flex PCB
Power/Meter	16W/m	Beam Angle	120°
Voltage	DC: 24V	IP Rating	IP65
Flux/Meter	1600lm/m	Width	10mm

**3**  
Years  
Warranty

SKU: 4483 RGB+6000K

SKU: 4484 RGB+3000K



LED Strip 24V 5050 60 LEDs  
**9.5W/m - Non Waterproof**



Product code	ST5050-A9	LED Qty	60 SMD/m
Type LED	SMD 5050	Material	Flex PCB
Power/Meter	9.5W/m	Beam Angle	120°
Voltage	DC: 24V	IP Rating	IP20
Flux/Meter	950lm/m	Width	10mm

**3**  
Years  
Warranty

SKU: 4480 + 6000K  
 4000K  
 3000K CCT



LED Strip 24V 5050 60 LEDs  
**16W/m - Non Waterproof**



Product code	ST5050-A5	LED Qty	60 SMD/m
Type LED	SMD 5050	Material	Flex PCB
Power/Meter	16W/m	Beam Angle	120°
Voltage	DC: 24V	IP Rating	IP20
Flux/Meter	1600lm/m	Width	10mm

**3**  
Years  
Warranty

SKU: 4481 RGB+6000K

SKU: 4482 RGB+3000K



CONNECTOR FOR STRIP 3528  
SKU: 5151

CONNECTOR FOR STRIP 5050  
SKU: 5152

CONNECTOR FOR STRIP RGB  
SKU: 6608

ANGLE CONNECTOR FOR STRIP 3528 8mm  
SKU: 6619

ANGLE CONNECTOR FOR STRIP 5050 10mm  
SKU: 6620

ANGLE CONNECTOR FOR STRIP RGB 10mm  
SKU: 6621

CONNECTOR FOR STRIP DC MALE  
SKU: 6610

CONNECTOR FOR STRIP DC FEMALE  
SKU: 6611

FLEXIBLE FOR STRIP 3528 DC FEMALE  
SKU: 6612

FLEXIBLE FOR STRIP 5050 DC FEMALE  
SKU: 6613

FLEXIBLE CONNECTOR FOR LED STRIP RGB  
SKU: 6614

FLEXIBLE CONNECTOR FOR LED STRIP 5050  
SKU: 6615

FLEXIBLE CONNECTOR FOR LED STRIP 5050  
SKU: 6616

FLEXIBLE CONNECTOR FOR STRIP RGB+WH  
SKU: 6618

FLEXIBLE FOR RGB LED STRIP WITH PIN  
SKU: 6617



SMD 2216

SMD 2110

**LED Strip 24V HIGH POWER**  
**SMD2216 ; SMD2110**

1900

Lumens



240 pcs

Product code	ST2216-A1
Type LED	SMD 2216
Power/Meter	22W/m
Voltage	DC: 24V
Flux/Meter	1900lm/m

LED Qty	240 SMD/m
Material	Flex PCB
Beam Angle	120°
IP Rating	IP20
Width	10mm

3 Years  
Warranty

5m-Roll



IP20

SKU: 4403 ■ 3000K

2200

Lumens



300 pcs

Product code	ST2216-A1
Type LED	SMD 2216
Power/Meter	24W/m
Voltage	DC: 24V
Flux/Meter	2200lm/m

LED Qty	300 SMD/m
Material	Flex PCB
Beam Angle	120°
IP Rating	IP20
Width	10mm

3 Years  
Warranty

5m-Roll



IP20

SKU: 4404 ■ 3000K

2500

Lumens



560 pcs

Product code	ST2110-A1
Type LED	SMD 2110
Power/Meter	32W/m
Voltage	DC: 24V
Flux/Meter	2500lm/m

LED Qty	560 SMD/m
Material	Flex PCB
Beam Angle	120°
IP Rating	IP20
Width	12mm

3 Years  
Warranty

5m-Roll



IP20

SKU: 4405 ■ 3000K

3400

Lumens



700 pcs

Product code	ST2110-A1
Type LED	SMD 2110
Power/Meter	38W/m
Voltage	DC: 24V
Flux/Meter	3400lm/m

LED Qty	700 SMD/m
Material	Flex PCB
Beam Angle	120°
IP Rating	IP20
Width	12mm

3 Years  
Warranty

5m-Roll



IP20

SKU: 4406 ■ 3000K



RGB

3 Years  
Warranty

5m-Roll



IP20

**LED Digital Strip**  
**Addressable**

Product code	ST10-A1
Type LED	WS2811 10 Pixels
Power/Meter	7W/m
Voltage	DC: 12V
Flux/Meter	550lm/m
LED Qty	30 SMD/m
Material	Flex PCB
Beam Angle	120°
IP Rating	IP20
Width	10mm
EAN Code	3800156644908

SKU: 4490

SKU: 4491

SKU: 4492

Product code	ST30-A1
Type LED	WS2812b 30 Pixels
Power/Meter	8W/m
Voltage	DC: 5V
Flux/Meter	600lm/m
LED Qty	30 SMD/m
Material	Flex PCB
Beam Angle	120°
IP Rating	IP20
Width	10mm
EAN Code	3800156644915

Product code	ST60-A1
Type LED	WS2812b 30 Pixels
Power/Meter	16W/m
Voltage	DC: 5V
Flux/Meter	1200lm/m
LED Qty	60 SMD/m
Material	Flex PCB
Beam Angle	120°
IP Rating	IP20
Width	10mm
EAN Code	3800156644922

RGB



Addressable

**Digital LED Strip Controller**  
**DC5-24V SD-CARD**

Voltage	5V-24V
IP Rating	IP20
Dimension	80x55x20mm
SKU: 6331	

**Digital LED Strip Controller**  
**DC5-24V**

Voltage	5V-24V
IP Rating	IP20
Dimension	80x55x20mm
SKU: 6332	



**LED Strip 12V 5050 30 LEDs - SET**  
**Adapter + ir Controller + Remote**

Product code	ST5050-B1	LED Qty	30 SMD/m
Type LED	SMD 5050	Material	Flex PCB
Power/Meter	4W/m	Beam Angle	120°
Voltage	DC: 12V	IP Rating	IP20
Flux/Meter	240lm/m	Width	10mm

SKU: 4321 RGB IP20

**LED Strip 12V 5050 30 LEDs - SET**  
**Adapter + Bluetooth Music + Remote**

Product code	ST5050-B1	LED Qty	30 SMD/m
Type LED	SMD 5050	Material	Flex PCB
Power/Meter	4W/m	Beam Angle	120°
Voltage	DC: 12V	IP Rating	IP20
Flux/Meter	240lm/m	Width	10mm

SKU: 4328 RGB IP20



Music

**LED Strip 12V 5050 60 LEDs - SET**  
**Adapter + ir Controller + Remote**

Product code	ST5050-B1	LED Qty	60 SMD/m
Type LED	SMD 5050	Material	Flex PCB
Power/Meter	8W/m	Beam Angle	120°
Voltage	DC: 12V	IP Rating	IP20
Flux/Meter	480lm/m	Width	10mm

SKU: 4322 RGB IP20



Music

**LED Strip 12V 5050 60 LEDs - SET**  
**Adapter + Bluetooth Music + Remote**

Product code	ST5050-B1	LED Qty	60 SMD/m
Type LED	SMD 5050	Material	Flex PCB
Power/Meter	8W/m	Beam Angle	120°
Voltage	DC: 12V	IP Rating	IP20
Flux/Meter	480lm/m	Width	10mm

SKU: 4329 RGB IP20

**LED Strip 12V 5050 60 LEDs - SET**  
**Adapter + ir Controller + Remote**  
**Waterproof**

Product code	ST5050-B1	LED Qty	60 SMD/m
Type LED	SMD 5050	Material	Flex PCB
Power/Meter	8W/m	Beam Angle	120°
Voltage	DC: 12V	IP Rating	IP54
Flux/Meter	480lm/m	Width	10mm

SKU: 4323 RGB IP54

**LED Strip 12V 5050 60 LEDs - SET**  
**Adapter + Bluetooth Music + Remote**  
**Waterproof**

Product code	ST5050-B1	LED Qty	60 SMD/m
Type LED	SMD 5050	Material	Flex PCB
Power/Meter	8W/m	Beam Angle	120°
Voltage	DC: 12V	IP Rating	IP54
Flux/Meter	480lm/m	Width	10mm

SKU: 4330 RGB IP54



Music

**Smart LED Strip 12V 5050+2835 - SET  
 Adapter + Wifi Controller**

Product code	ST5050-B1	LED Qty	60 SMD/m
Type LED	SMD 5050+2835	Material	Flex PCB
Power/Meter	4W/m	Beam Angle	120°
Voltage	DC: 12V	IP Rating	IP20
Flux/Meter	240lm/m	Width	10mm

SKU: 4324 RGB+W IP20

SKU: 4325 RGB+WW IP20

**Smart LED Strip 12V CCT 5050+2835 -SET  
 Adapter + Wifi Controller**



Product code	ST5050-B1	LED Qty	90 SMD/m
Type LED	SMD 5050+2835	Material	Flex PCB
Power/Meter	6W/m	Beam Angle	120°
Voltage	DC: 12V	IP Rating	IP54
Flux/Meter	360lm/m	Width	12mm

SKU: 4326 RGB+CCT IP20

**TV LED Strip 5V 5050+2835 60LEDs - SET  
 Wifi Controller + Remote**

Product code	ST5050-B1	LED Qty	60 SMD/m
Type LED	SMD 5050+2835	Material	Flex PCB
Power/Meter	4W/m	Beam Angle	120°
Voltage	DC: 5V	IP Rating	IP20
Flux/Meter	240lm/m	Width	10mm

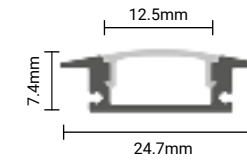
SKU: 4327 RGB+WW IP20



SKU: 5104 Black Body- White Cover (L=2m)

SKU: 5105 Black Body- Black Cover (L=2m)

SKU: 5106 White Body- White Cover (L=2m)

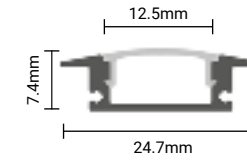

SKU: 5193 Silver Body- White Cover (L=1m)

SKU: 5192 Silver Body- White Cover (L=2m)

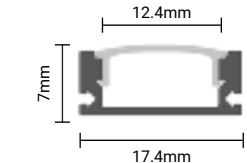

SKU: 5190 Silver Body- White Cover (L=1m)

SKU: 5191 Silver Body- White Cover (L=2m)

SKU: 5184 White Body- White Cover (L=2m)

SKU: 5185 Black Body- White Cover (L=2m)

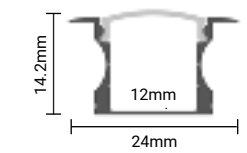

SKU: 5108 Silver Body- White Cover (L=2m)

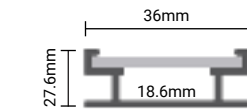

SKU: 5113 Silver Body- White Cover (L=2m)

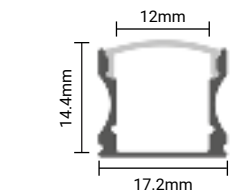

SKU: 5175 Silver Body- White Cover (L=2m)

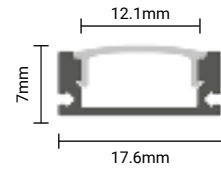

SKU: 5107 Black Body- Black Cover (L=2m) ■■

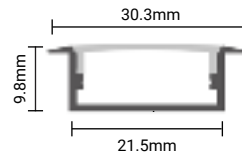

SKU: 5109 Silver Body- White Cover (L=2m) ■□

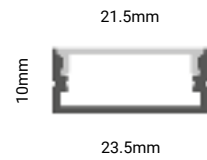

SKU: 5183 Silver Body- White Cover (L=2m) ■□

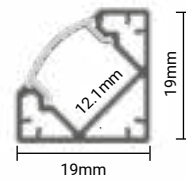

SKU: 5101 Black Body- Black Cover (L=2m) ■□

SKU: 5102 White Body- White Cover (L=2m) □□

SKU: 5103 Silver Body- White Cover (L=2m) ■□

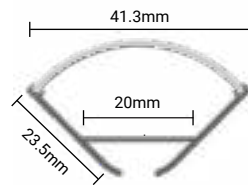

SKU: 5110 Silver Body- White Cover (L=2m) ■□

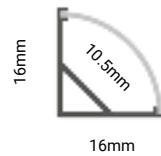

SKU: 5150 Silver Body- White Cover (L=2m) ■□

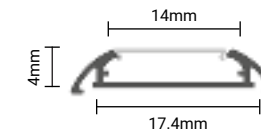

SKU: 5002 Bendable -Silver body (L=1m) ■

SKU: 5001 Bendable -Silver body (L=2m) ■

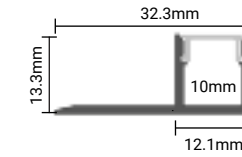

SKU: 5111 Silver Body- White Cover (L=2m) ■□

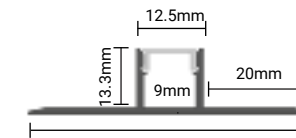
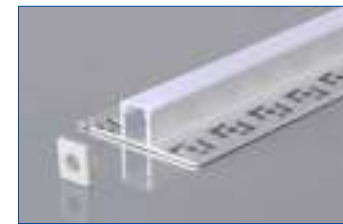

SKU: 5112 Silver Body- White Cover (L=2m) ■□

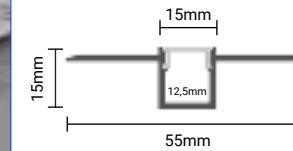

SKU: 5162 Silver Body- White Cover (L=2m) ■□

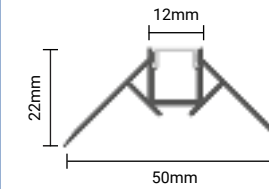

SKU: 5165 Silver Body- White Cover (L=2m) ■□

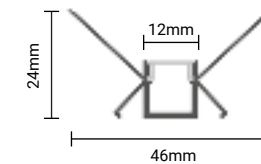

SKU: 5166 Silver Body- White Cover (L=2m) ■□



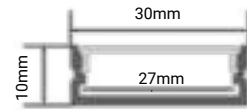

SKU: 5114 Black Body- Black Cover (L=2m) ■■

SKU: 5115 Silver Body- White Cover (L=2m) □

SKU: 5116 Black Body- White Cover (L=2m) ■□

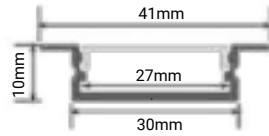

SKU: 5117 Black Body- Black Cover (L=2m) ■■

SKU: 5118 Silver Body- White Cover (L=2m) □

SKU: 5119 Black Body- White Cover (L=2m) ■□

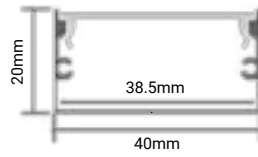

SKU: 5120 Black Body- Black Cover (L=2m) ■■

SKU: 5121 Silver Body- White Cover (L=2m) □

SKU: 5122 Black Body- White Cover (L=2m) ■□

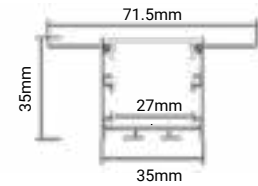

SKU: 5123 Black Body- Black Cover (L=2m) ■■

SKU: 5124 Silver Body- White Cover (L=2m) □

SKU: 5125 Black Body- White Cover (L=2m) ■□

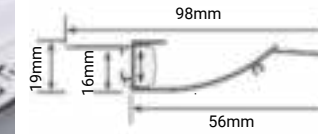

SKU: 5128 Silver Body- White Cover (L=2m) □

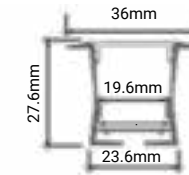

SKU: 5130 Silver Body- White Cover (L=2m) □

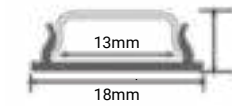

SKU: 5132 Silver Body- White Cover (L=2m) □

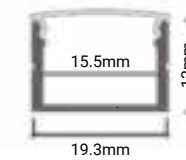

SKU: 5133 Silver Body- White Cover (L=2m) □

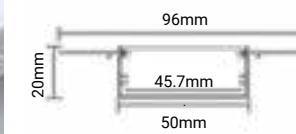

SKU: 5134 Silver Body- White Cover (L=2m) □





The new range of silicone encapsulated Neon by OPTONICA LED comprises of highly durable and flexible linear LED Solutions - suitable for both indoor and outdoor architectural applications. Designed using high-grade silicone, the neon is:

- Able to withstand wide temperature amplitudes
- Resistant to the build-up of dirt and dust, making it the first to come with a self-cleaning property
- Waterproof and impact resistant
- UV, flame and solvent resistant

## LED STRIPS 220V AND FLEX NEON



LED Strip S-Type 12V 2835 60 LEDs  
**7.2W/m - Non Waterproof**

Product code	M02835-A2	LED Qty	60 SMD/m
Type LED	SMD 2835	Material	Flex PCB
Power/Meter	7.2W/m	Beam Angle	120°
Voltage	DC: 12V	IP Rating	IP20
Flux/Meter	720lm/m	Width	6mm

**3**  
Years  
Warranty



5m-Roll



IP20

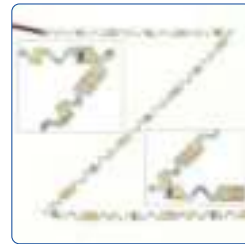

Free Angle Bending

SKU: 4541    SKU: 4546    SKU: 4542  
 6000K    4000K    3000K



LED Strip S-Type 12V 2835 60 LEDs  
**7.2W/m - Waterproof**

Product code	M02835-A2	LED Qty	60 SMD/m
Type LED	SMD 2835	Material	Flex PCB
Power/Meter	7.2W/m	Beam Angle	120°
Voltage	DC: 12V	IP Rating	IP65
Flux/Meter	720lm/m	Width	6mm

**3**  
Years  
Warranty



5m-Roll



IP65



Free Angle Bending

SKU: 4551    SKU: 4552  
 6000K    2700K



LED Strip S-Type 12V 2835 60 LEDs  
**7.2W/m - Non Waterproof**

Product code	M02835-A2	LED Qty	60 SMD/m
Type LED	SMD 2835	Material	Flex PCB
Power/Meter	7.2W/m	Beam Angle	120°
Voltage	DC: 12V	IP Rating	IP20
Flux/Meter	720lm/m	Width	6mm

**3**  
Years  
Warranty



5m-Roll



IP20

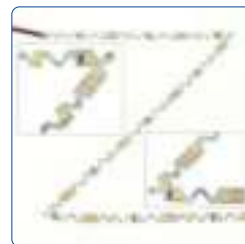

Free Angle Bending

SKU: 4543    SKU: 4545    SKU: 4544  
 RED    GREEN    BLUE



LED Strip S-Type 12V 2835 60 LEDs  
**7.2W/m - Waterproof**

Product code	M02835-A2	LED Qty	60 SMD/m
Type LED	SMD 2835	Material	Flex PCB
Power/Meter	7.2W/m	Beam Angle	120°
Voltage	DC: 12V	IP Rating	IP65
Flux/Meter	720lm/m	Width	6mm

**3**  
Years  
Warranty



5m-Roll



IP65

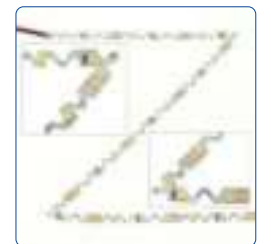

Free Angle Bending

SKU: 4553    SKU: 4555    SKU: 4554  
 RED    GREEN    BLUE





/m  
120 pcs

-Roll  
50m-Roll

IP65



/m  
120 pcs

-Roll  
50m-Roll

IP65



**LED FLEX NEON 12V -50m Roll**  
**2835 120 SMD/m**

Product code	ST12-A2	LED Qty	120 SMD/m
Type LED	SMD 2835	Material	Flex PC
Power/Meter	6W/m	Beam Angle	120°
Voltage	DC: 12V	IP Rating	IP65
Flux/Meter	300lm/m	Dimension	16x8 mm

SKU: 4590	6000K	
SKU: 4591	4000K	
SKU: 4592	2800K	
SKU: 4593	Blue	
SKU: 4594	Red	
SKU: 4595	Green	
SKU: 4596	Ice Blue	
SKU: 4597	Lemon	
SKU: 4598	Golden	
SKU: 4599	PURPLE	

**LED FLEX NEON 220V -50m Roll**  
**2835 120 SMD/m**

Product code	ST220-A2	LED Qty	120 SMD/m
Type LED	SMD 2835	Material	Flex PC
Power/Meter	8.5W/m	Beam Angle	120°
Voltage	AC: 220V	IP Rating	IP65
Flux/Meter	300lm/m	Dimension	Single 16x10 mm RGB 25x13 mm

SKU: 4581	6000K	
SKU: 4580	4000K	
SKU: 4582	2800K	
SKU: 4584	RED	
SKU: 4585	GREEN	
SKU: 4583	BLUE	
SKU: 4587	YELLOW	
SKU: 4586	AMBER	
SKU: 4588	PINK	
SKU: 4589	RGB	

PLUG IN + CONNECTOR PIN



SKU: 6602

MOUNTING BRACKET

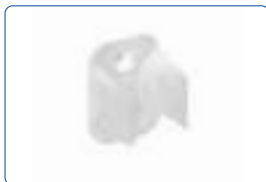

SKU: 6603

ALUMINIUM CLIPS



SKU: 6601

END CAP FOR



SKU: 6605

INPUT CABLE + CONNECTOR + PLUG



SKU: 6635

MIDDLE CONNECTOR



SKU: 6634

ALUMINIUM CHANNEL WITH 2 SCREWS



SKU: 6636

END CAP FOR SINGLE COLOUR



SKU: 6637

CONNECTOR PLUG



SKU: 6604



POWER CABLE+RGB CONTROLLER



SKU: 6638

ALUMINIUM CHANNEL , 5CM RGB



SKU: 6639

END CAP FOR RGB



SKU: 6640



**LED Strips 220V -50m Roll**  
**2835 120 SMD/m**

/m  
120 pcs

IP65

Product code	ST220-A3	LED Qty	120 SMD/m
Type LED	SMD 2835	Material	Flex PC
Power/Meter	9W/m	Beam Angle	120°
Voltage	AC: 220V	IP Rating	IP65
Flux/Meter	900lm/m	Dimension	10x4.3 mm

SKU: 4951    SKU: 4952    SKU: 4953  
 6000K    4500K    3000K

50m-Roll



INPUT CABLE + CONNECTOR  
SKU: 6543



FIX CLIP  
SKU: 6544



END CAP FOR 2835  
SKU: 6545



/m  
120 pcs

50m-Roll

IP65



**LED Strips 220V -50m Roll**  
**5730 120 SMD/m**

Product code	ST220-A1	LED Qty	120 SMD/m
Type LED	SMD 5730	Material	Flex PC
Power/Meter	10W/m	Beam Angle	120°
Voltage	AC: 220V	IP Rating	IP65
Flux/Meter	500lm/m	Dimension	13x5 mm

SKU: 4611    SKU: 4613    SKU: 4612  
 6000K    4000K    2800K



2835/5730 INPUT CABLE + CONNECTOR  
SKU: 6631



2835/5730 MIDDLE CONNECTOR  
SKU: 6633



2835/5730 FIXING  
SKU: 6632



END CAP FOR 220V  
SKU: 6627

**LED Strips COB 220V -50m Roll**  
**COB Waterproof**

/m  
288 pcs

IP65

Product code	ST228-A1	LED Qty	288 SMD/m
Type LED	COB	Material	Flex PC
Power/Meter	10W/m	Beam Angle	120°
Voltage	AC: 220V	IP Rating	IP65
Flux/Meter	700lm/m	Dimension	12x5 mm

SKU: 4954    SKU: 4955    SKU: 4956  
 6000K    4500K    3000K

50m-Roll



INPUT CABLE + CONNECTOR  
SKU: 6546



FIX CLIP  
SKU: 6547



END CAP FOR COB  
SKU: 6548



**LENS LED Module 1.6W - 220V**  
**3x2835 SMD - Waterproof**

 100  
 Lumens

IP67

Product code	M0220-A1	LED Qty	3 pcs
Type LED	SMD 2835	Material	PC
Power/Module	1.2W	Beam Angle	160°
Voltage	AC: 220-265V	IP Rating	IP67
Flux/Watt	84lm/W	Dimension	88x22x11mm

SKU: 4564 White Light 6500K

 3  
 Years  
 Warranty

**LED Module 2.4W**  
**4x2835 SMD - Waterproof**

 85  
 Lumens

IP65

Product code	M02835-A1	LED Qty	4 pcs
Type LED	SMD 2835	Material	PC
Power/Module	2.4W	Beam Angle	160°
Voltage	DC: 12V	IP Rating	IP65
Flux/Watt	35lm/W	Dimension	43x38x6.5mm

SKU: 4561 White Light 6500K 3800156645615

SKU: 4562 Warm White 3000K 3800156645622

 3  
 Years  
 Warranty

**LENS LED Module 0.72W**  
**3x2835 SMD - Waterproof**

 80  
 Lumens

IP65

Product code	M02835-A1	LED Qty	3 pcs
Type LED	SMD 2835	Material	PC
Power/Module	0.72W	Beam Angle	160°
Voltage	DC: 12V	IP Rating	IP65
Flux/Watt	110lm/W	Dimension	58x12mm

 SKU: 4512 White Light 10000K  
 SKU: 4511 White Light 6500K  
 SKU: 4513 Warm White 3000K  
 SKU: 4514 RED   
 SKU: 4516 GREEN   
 SKU: 4515 BLUE 

 3  
 Years  
 Warranty

**LENS LED Module 0.72W**  
**3x5050 SMD - Waterproof**

 85  
 Lumens

IP65

Product code	M05050-A1	LED Qty	3 pcs
Type LED	SMD 5050	Material	PC
Power/Module	0.72W	Beam Angle	120°
Voltage	DC: 12V	IP Rating	IP65
Flux/Watt	118lm/W	Dimension	70x16x8mm

SKU: 4563 RGB

 3  
 Years  
 Warranty

**LENS LED Module 1.5W**  
**3x2835 SMD - Waterproof**

 120  
 Lumens

IP65

Product code	M02835-A1	LED Qty	3 pcs
Type LED	SMD 2835	Material	PC
Power/Module	1.5W	Beam Angle	160°
Voltage	DC: 12V	IP Rating	IP65
Flux/Watt	80lm/W	Dimension	75x15mm

 SKU: 4522 White Light 10000K  
 SKU: 4521 White Light 6500K  
 SKU: 4523 Warm White 3000K  
 SKU: 4524 RED   
 SKU: 4526 GREEN   
 SKU: 4525 BLUE 

 3  
 Years  
 Warranty

**LED Module 0.36W**  
**3x3014 SMD - Waterproof**

 30  
 Lumens

IP65

Product code	M03014-A1	LED Qty	3 pcs
Type LED	SMD 3014	Material	PC
Power/Module	0.36W	Beam Angle	120°
Voltage	DC: 12V	IP Rating	IP65
Flux/Watt	85lm/W	Dimension	18x8x2.9mm

 SKU: 4531 White Light 6500K  
 SKU: 4532 Warm White 3000K  
 SKU: 4533 RED   
 SKU: 4535 GREEN   
 SKU: 4534 BLUE 

 3  
 Years  
 Warranty





## LED POWER SUPPLIES



Our portfolio covers best-performing all world-wide LVD power standards including narrow-body for installation ease in tricky spaces. Cost-efficient on your utility bills and your maintenance budget.

#### Features:

- 5V, 12V and 24V units come in a choice of sizes and shapes
- Specialized dimmable products for panels and downlights
- Waterproof options available with various degree of ingress-protection ratings
- Extended life cycle through forced heat dissipation, making them utmost reliable

#### Application:

- The natural choice for each LED strip design and installation
- A vital part of any lighting application



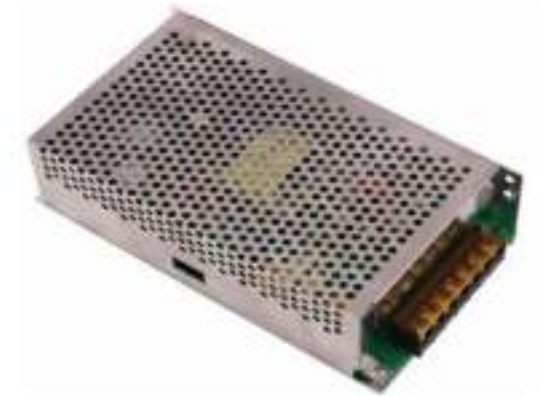

TRIAC Dimmable Power Supplies  
**Metal 12V Output**

**3**  
Years  
Warranty



SKU: 6271 75W - 12V  
SKU: 6272 100W - 12V  
SKU: 6273 150W - 12V

	<b>75W</b>	<b>100W</b>	<b>150W</b>
Watts	75W	100W	150W
Input Voltage	220-240V	220-240V	220-240V
Output Voltage	DC: 12V	DC: 12V	DC: 12V
Current	6.25A	8.33A	12.5A
Material	Metal	Metal	Metal
IP Rating	IP20	IP20	IP20
Dimension	190x50x31mm	206x67x37mm	206x67x37mm

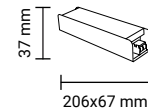
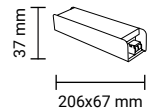
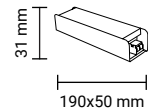

Power Supplies for Track Light  
**Metal 48V Output**



SKU: 6284 120W - 48V  
SKU: 6285 250W - 48V

	<b>120W</b>	<b>250W</b>
Watts	120W	250W
Input Voltage	220V	220V
Output Voltage	DC: 48V	DC: 48V
Current	2.5A	5.2A
Material	Metal	Metal
IP Rating	IP20	IP20
Dimension	190x90x30mm	220x120x30mm

TRIAC Dimmable Power Supplies  
**Metal 24V Output**

**3**  
Years  
Warranty



SKU: 6281 75W - 24V  
SKU: 6282 100W - 24V  
SKU: 6283 150W - 24V

	<b>75W</b>	<b>100W</b>	<b>150W</b>
Watts	75W	100W	150W
Input Voltage	220-240V	220-240V	220-240V
Output Voltage	DC: 24V	DC: 24V	DC: 24V
Current	3.1A	4.17A	6.25A
Material	Metal	Metal	Metal
IP Rating	IP20	IP20	IP20
Dimension	119x52x32mm	206x67x37mm	206x67x37mm

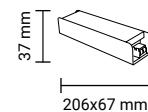
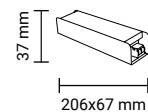
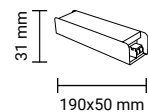





**Strip Power Supplies Premium**  
**Plastic 12V Output**
**3**  
 Years  
 Warranty

  
 DC:12V

  
 IP20

 SKU: 6201 36W - 12V  
 SKU: 6202 60W - 12V  
 SKU: 6203 72W - 12V

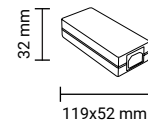
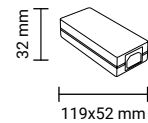
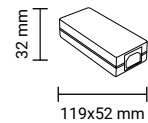
Watts	36W	60W	72W
Input Voltage	100-240V	100-240V	100-240V
Output Voltage	DC: 12V	DC: 12V	DC: 12V
Current	3A	5A	6A
Material	Plastic	Plastic	Plastic
IP Rating	IP20	IP20	IP20
Dimension	119x52x32mm	119x52x32mm	119x52x32mm



**Strip Power Supplies Premium**  
**SLIM - Metal 12V Output**
**3**  
 Years  
 Warranty

  
 DC:12V

  
 IP20

 SKU: 6211 60W - 12V  
 SKU: 6212 100W - 12V  
 SKU: 6213 150W - 12V  
 SKU: 6214 200W - 12V

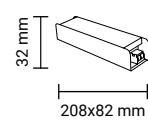
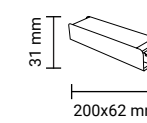
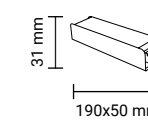
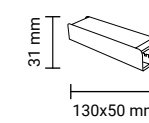
Watts	60W	100W	150W	200W
Input Voltage	100-240V	100-240V	176-265V	176-265V
Output Voltage	DC: 12V	DC: 12V	DC: 12V	DC: 12V
Current	5A	8.4A	12.5A	16.7A
Material	Metal	Metal	Metal	Metal
IP Rating	IP20	IP20	IP20	IP20
Dimension	130x50x31mm	190x50x31mm	200x62x31mm	208x82x32mm



**Strip Power Supplies Premium**  
**Plastic 24V Output**
**3**  
 Years  
 Warranty

  
 DC:24V

  
 IP20

 SKU: 6206 36W - 24V  
 SKU: 6207 60W - 24V  
 SKU: 6208 72W - 24V

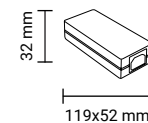
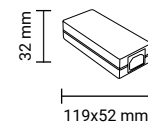
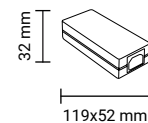
Watts	36W	60W	72W
Input Voltage	100-240V	100-240V	100-240V
Output Voltage	DC: 24V	DC: 24V	DC: 24V
Current	1.5A	2.5A	3A
Material	Plastic	Plastic	Plastic
IP Rating	IP20	IP20	IP20
Dimension	119x52x32mm	119x52x32mm	119x52x32mm



**Strip Power Supplies Premium**  
**SLIM - Metal 24V Output**
**3**  
 Years  
 Warranty

  
 DC:24V

  
 IP20

 SKU: 6221 60W - 24V  
 SKU: 6222 100W - 24V  
 SKU: 6223 150W - 24V  
 SKU: 6224 200W - 24V

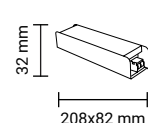
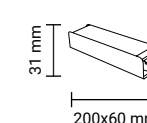
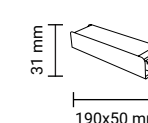
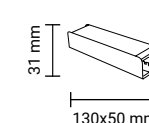
Watts	60W	100W	150W	200W
Input Voltage	100-240V	100-240V	176-265V	176-265V
Output Voltage	DC: 24V	DC: 24V	DC: 24V	DC: 24V
Current	2.5A	4.2A	6.25A	8.35A
Material	Metal	Metal	Metal	Metal
IP Rating	IP20	IP20	IP20	IP20
Dimension	130x50x31mm	190x50x31mm	200x60x31mm	208x82x32mm







Strip Power Supplies Premium  
**Plastic Case 12V Output**

**3** Years  
Warranty

DC:12V

IP20

SKU: 6231 24W - 12V  
SKU: 6232 36W - 12V  
SKU: 6233 60W - 12V

Watts	24W	36W	60W
Input Voltage	100-240V	100-240V	100-240V
Output Voltage	DC: 12V	DC: 12V	DC: 12V
Current	2A	3A	5A
Material	Plastic	Plastic	Plastic
IP Rating	IP20	IP20	IP20
Dimension	120x42x28mm	140x48x30mm	155x53x30mm

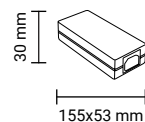
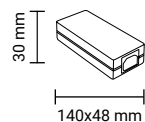
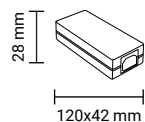

Strip Power Supplies Premium  
**Waterproof 12V Output**

**3** Years  
Warranty

DC:12V

IP67

SKU: 6251 60W - 12V  
SKU: 6252 100W - 12V  
SKU: 6253 150W - 12V  
SKU: 6254 200W - 12V

Watts	60W	100W	150W	200W
Input Voltage	100-240V	100-240V	176-265V	176-265V
Output Voltage	DC: 12V	DC: 12V	DC: 12V	DC: 12V
Current	5A	8.4A	12.5A	16.7A
Material	Metal	Metal	Metal	Metal
IP Rating	IP67	IP67	IP67	IP67
Dimension	158x52x32mm	220x52x32mm	233x65x32mm	244x80x32mm

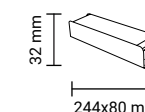
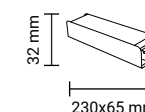
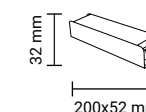
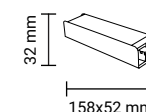

Strip Power Supplies Premium  
**Plastic Case 24V Output**

**3** Years  
Warranty

DC:24V

IP20

SKU: 6241 24W - 24V  
SKU: 6242 36W - 24V  
SKU: 6243 60W - 24V

Watts	24W	36W	60W
Input Voltage	100-240V	100-240V	100-240V
Output Voltage	DC: 24V	DC: 24V	DC: 24V
Current	1A	1.5A	2.5A
Material	Plastic	Plastic	Plastic
IP Rating	IP20	IP20	IP20
Dimension	120x42x28mm	140x48x30mm	155x53x30mm

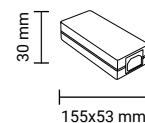
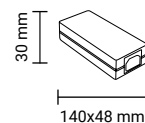
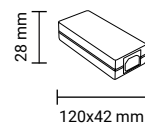

Strip Power Supplies Premium  
**Waterproof 24V Output**

**3** Years  
Warranty

DC:24V

IP67

SKU: 6261 60W - 24V  
SKU: 6262 100W - 24V  
SKU: 6263 150W - 24V  
SKU: 6264 200W - 24V

Watts	60W	100W	150W	200W
Input Voltage	100-240V	100-240V	176-265V	176-265V
Output Voltage	DC: 24V	DC: 24V	DC: 24V	DC: 24V
Current	2.5A	4.2A	6.25A	8.35A
Material	Metal	Metal	Metal	Metal
IP Rating	IP67	IP67	IP67	IP67
Dimension	158x52x32mm	220x52x32mm	230x65x32mm	244x80x32mm

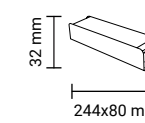
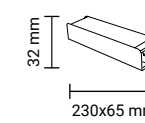
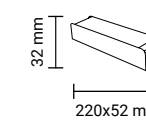
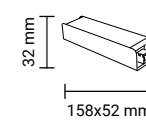

 Strip Power Supplies  
**Plastic 12V Output**

DC:12V



IP20

SKU: 6120	18W - 12V
SKU: 6101	24W - 12V
SKU: 6102	36W - 12V
SKU: 6103	60W - 12V
SKU: 6119	80W - 12V

**18W**

Product Code	AC18-A1	Current	1,5A
Watts	18W	Material	Plastic
Input Voltage	220-240V	IP Rating	IP20
Output Voltage	DC: 12V	Dimension	85x50x34mm

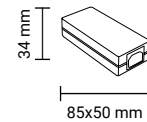
**24W**

Product Code	AC24-A1	Current	2A
Watts	24W	Material	Plastic
Input Voltage	220-240V	IP Rating	IP20
Output Voltage	DC: 12V	Dimension	90x50x31mm

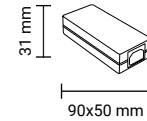
**36W**

Product Code	AC36-A1	Current	3A
Watts	36W	Material	Plastic
Input Voltage	220-240V	IP Rating	IP20
Output Voltage	DC: 12V	Dimension	124x58x32mm

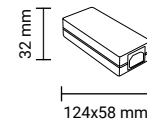
**60W**

Product Code	AC60-A1	Current	5A
Watts	60W	Material	Plastic
Input Voltage	220-240V	IP Rating	IP20
Output Voltage	DC: 12V	Dimension	124x58x32mm

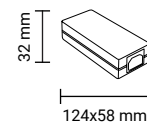
**80W**

Product Code	AC80-A1	Current	6.5A
Watts	80W	Material	Plastic
Input Voltage	220-240V	IP Rating	IP20
Output Voltage	DC:12V	Dimension	136x64x40mm

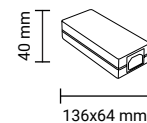

## Strip Power Supplies

**Waterproof Metal 12V Output**

DC:12V



IP67

SKU: 6110	30W - 12V
SKU: 6111	60W - 12V
SKU: 6112	150W - 12V

**30W**

Product Code	AC30-A7	Current	2.5A
Watts	30W	Material	Aluminium
Input Voltage	220V	IP Rating	IP67
Output Voltage	DC: 12V	Dimension	221x30x34mm

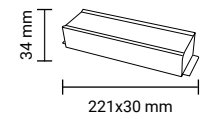
**60W**

Product Code	AC60-A7	Current	5A
Watts	60W	Material	Aluminium
Input Voltage	220V	IP Rating	IP67
Output Voltage	DC: 12V	Dimension	174x67x43mm

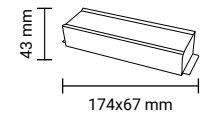
**100W**

Product Code	AC100-A7	Current	8.5A
Watts	100W	Material	Aluminium
Input Voltage	220V	IP Rating	IP67
Output Voltage	DC: 12V	Dimension	237x70x43mm

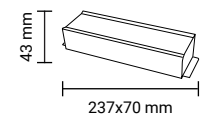
**150W**

Product Code	AC150-A7	Current	12.5A
Watts	150W	Material	Aluminium
Input Voltage	220V	IP Rating	IP67
Output Voltage	DC:12V	Dimension	235x50x85mm

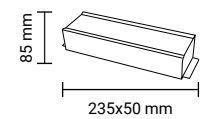



Strip Power Supplies  
**Metal 12V Output**



- SKU: 6104 24W - 12V
- SKU: 6121 36W - 12V
- SKU: 6105 60W - 12V
- SKU: 6109 100W - 12V
- SKU: 6106 120W - 12V

Watts	24W	36W	60W	100W	120W
Input Voltage	220V	220V	220V	220V	220V
Output Voltage	DC: 12V	DC: 12V	DC: 12V	DC: 12V	DC: 12V
Current	2A	3A	5A	8.3A	10A
Material	Metal	Metal	Metal	Metal	Metal
IP Rating	IP20	IP20	IP20	IP20	IP20
Dimension	85x57x34mm	85x57x34mm	115x80x50mm	165x105x50mm	165x105x65mm

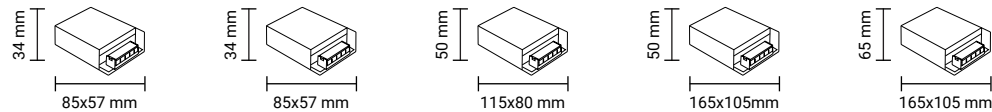

Strip Power Supplies  
**Metal 12V Output**



- SKU: 6114 150W - 12V
- SKU: 6117 250W - 12V
- SKU: 6108 360W - 12V
- SKU: 6124 500W - 12V

Watts	150W	250W	360W	500W
Input Voltage	220V	220V	220V	220V
Output Voltage	DC: 12V	DC: 12V	DC: 12V	DC: 12V
Current	12.5A	20A	30A	41.5A
Material	Metal	Metal	Metal	Metal
IP Rating	IP20	IP20	IP20	IP20
Dimension	205x100x50mm	200x115x55mm	220x115x55mm	220x115x55mm

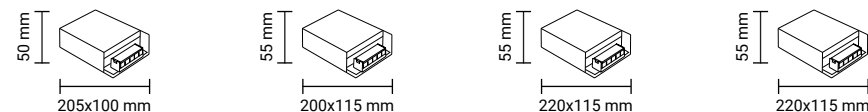

Strip Power Supplies  
**Metal 24V Output**



- SKU: 6154 60W - 24V
- SKU: 6151 100W - 24V
- SKU: 6155 150W - 24V
- SKU: 6152 250W - 24V
- SKU: 6153 360W - 24V

**60W**

Product Code	AC60-A4	Current	2.5A
Watts	60W	Material	Metal
Input Voltage	220V	IP Rating	IP20
Output Voltage	DC: 24V	Dimension	165x100x45mm

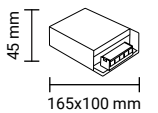

**100W**

Product Code	AC100-A4	Current	4.2A
Watts	100W	Material	Metal
Input Voltage	220V	IP Rating	IP20
Output Voltage	DC: 24V	Dimension	210x100x45mm

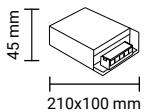

**150W**

Product Code	AC150-A4	Current	6.25A
Watts	150W	Material	Metal
Input Voltage	220V	IP Rating	IP20
Output Voltage	DC: 24V	Dimension	205x105x50mm

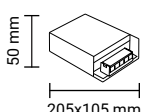

**250W**

Product Code	AC250-A4	Current	10.5A
Watts	250W	Material	Metal
Input Voltage	220V	IP Rating	IP20
Output Voltage	DC: 24V	Dimension	200x110x50mm

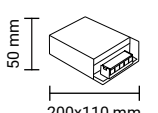

**360W**

Product Code	AC360-A4	Current	15A
Watts	360W	Material	Metal
Input Voltage	220V	IP Rating	IP20
Output Voltage	DC: 24V	Dimension	220x115x55mm

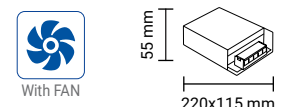





## Strip Power Supplies

**SLIM - Metal 12V Output**

Slim Line



DC12V



IP20

SKU: 6131	60W - 12V
SKU: 6132	100W - 12V
SKU: 6133	150W - 12V
SKU: 6134	250W - 12V
SKU: 6135	360W - 12V

**60W**

Product Code	AC60-A3	Current	5A
Watts	60W	Material	Metal
Input Voltage	220V	IP Rating	IP20
Output Voltage	DC: 12V	Dimension	170x45x38mm

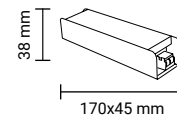
**100W**

Product Code	AC100-A3	Current	8.5A
Watts	100W	Material	Metal
Input Voltage	220V	IP Rating	IP20
Output Voltage	DC: 12V	Dimension	190x48x38mm

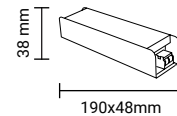
**150W**

Product Code	AC150-A3	Current	12.5A
Watts	150W	Material	Metal
Input Voltage	220V	IP Rating	IP20
Output Voltage	DC: 12V	Dimension	207x63x49mm

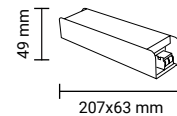
**250W**

Product Code	AC250-A3	Current	20A
Watts	250W	Material	Metal
Input Voltage	220V	IP Rating	IP20
Output Voltage	DC: 12V	Dimension	230x75x45mm

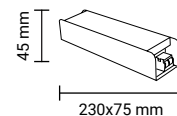

With FAN

**360W**

Product Code	AC360-A3	Current	30A
Watts	360W	Material	Metal
Input Voltage	220V	IP Rating	IP20
Output Voltage	DC: 12V	Dimension	230x75x45mm



With FAN

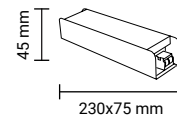

## Strip Power Supplies

**SLIM - Metal 24V Output**

Slim Line



DC:24V



IP20

SKU: 6161	60W - 24V
SKU: 6162	100W - 24V
SKU: 6163	150W - 24V
SKU: 6164	250W - 24V
SKU: 6165	360W - 24V

**60W**

Product Code	AC60-A4	Current	2.5A
Watts	60W	Material	Metal
Input Voltage	220V	IP Rating	IP20
Output Voltage	DC: 24V	Dimension	170x45x40mm

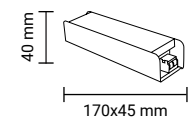
**100W**

Product Code	AC100-A4	Current	4.2A
Watts	100W	Material	Metal
Input Voltage	220V	IP Rating	IP20
Output Voltage	DC: 24V	Dimension	195x40x40mm

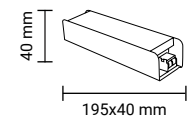
**150W**

Product Code	AC150-A4	Current	6.25A
Watts	150W	Material	Metal
Input Voltage	220V	IP Rating	IP20
Output Voltage	DC: 24V	Dimension	205x65x45mm

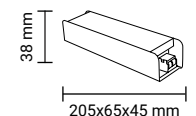
**250W**

Product Code	AC250-A4	Current	10.5A
Watts	250W	Material	Metal
Input Voltage	220V	IP Rating	IP20
Output Voltage	DC: 24V	Dimension	230x75x45mm

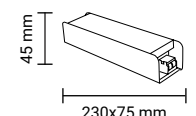

With FAN

**360W**

Product Code	AC360-A4	Current	15A
Watts	360W	Material	Metal
Input Voltage	220V	IP Rating	IP20
Output Voltage	DC: 24V	Dimension	230x75x45mm



With FAN

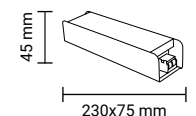

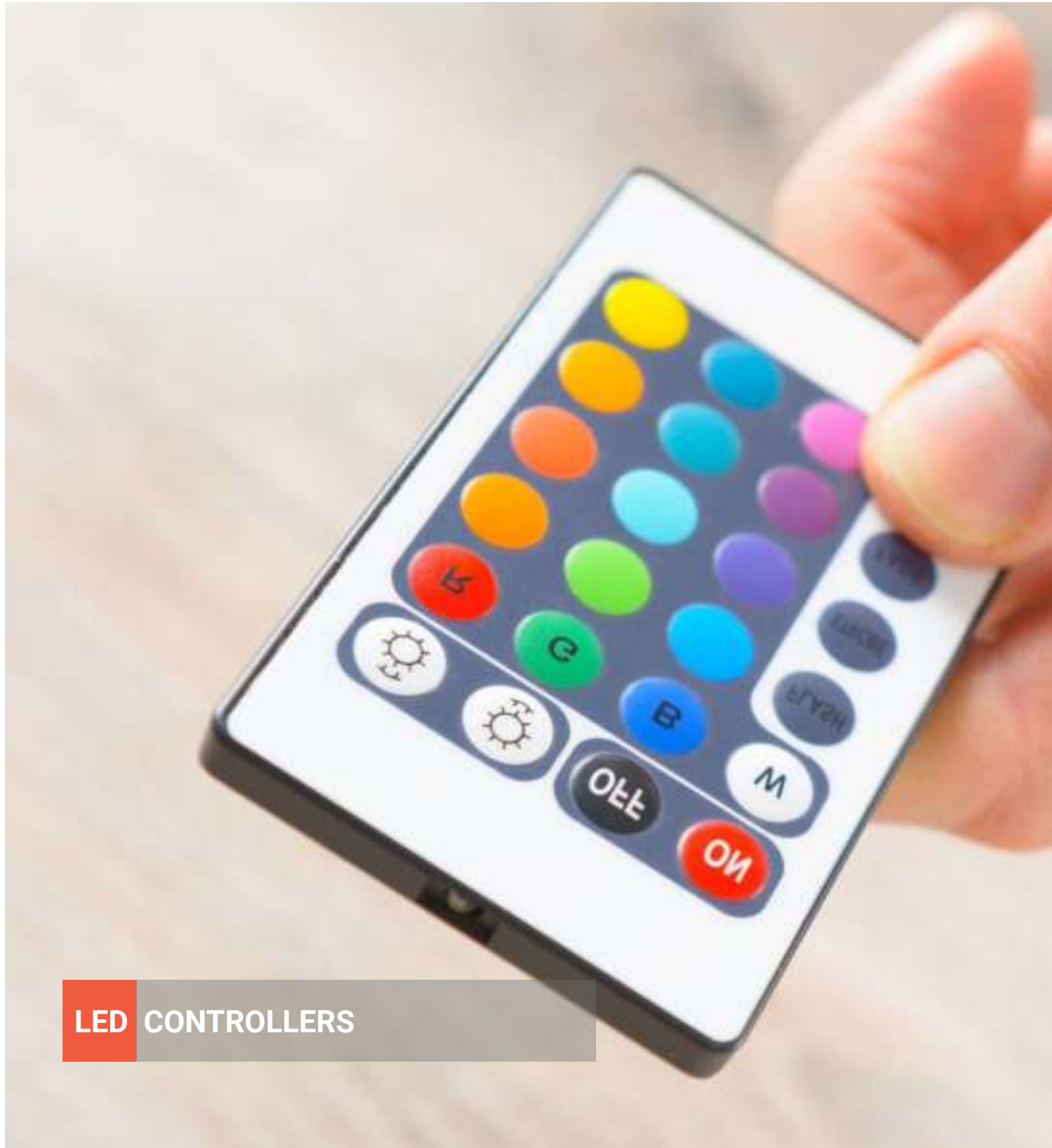

LED strips with all its power and might cannot be fully deployed without the appropriate diverse controllers. Touch sensors, Wi-Fi, smart home or any other popular type are available to diversify modern design and layout.

**Features:**

- Discreet and contemporary patterns.
- Small giants, an absolute must for any sophisticated lighting architecture
- Plug and play concept

**Application:**

- Probably the most widely used category with infinite applications

**LED CONTROLLERS**

**Dimmer LED Strip  
With Remote Control 8A**

SKU:	<b>6302</b>
Product Code	AC2-A2
Power	96W-192W
Voltage	12V / 24V
IP Rating	IP20
Dimension	80x55x30mm

**WiFi Controller  
RGB / Single Color 3x4A**

SKU:	<b>6310</b>	<b>6311</b>
Product Code	AC2-A2	AC2-A2
Power	90W-288W	90W-288W
Voltage	7.5V-24V	7.5V-24V
Strip Type	RGB	Single Color
Dimension	80x55x30mm	80x55x30mm

**Remote Control LED Strip  
RGB - 4 Buttons 3x4A**

SKU:	<b>6304</b>
Product Code	AC2-A2
Power	144W-288W
Voltage	12V / 24V
IP Rating	IP20
Dimension	105x65x20mm

**Amplifier for LED Strip  
RGB - Iron Shell 3x8A**

SKU:	<b>6326</b>
Product Code	AC2-A2
Power	288W-576W
Voltage	12V-24V
IP Rating	IP20
Dimension	80x70x30mm

**Remote Control LED Strip  
RGB - 16 Buttons 3x2A**

SKU:	<b>6303</b>
Product Code	AC2-A2
Power	72W
Voltage	12V
IP Rating	IP20
Dimension	50x35x20mm

**Amplifier for LED Strip  
RGB+White 4x6A**

SKU:	<b>6328</b>
Product Code	AC2-A2
Power	288W-576W
Voltage	12V-24V
IP Rating	IP20
Dimension	65x55x20mm

**Remote Control LED Strip  
RGB - 44 Buttons**

SKU:	<b>6306</b>	<b>6307</b>
Product Code	AC2-A2	AC2-A2
Power	72W	144W
Voltage	12V	12V
IP Rating	IP20	IP20
Dimension	50x35x20mm	50x35x20mm

**Amplifier for LED Strip  
RGB 3x4A**

SKU:	<b>6305</b>
Product Code	AC2-A2
Power	144W-288W
Voltage	12V-24V
IP Rating	IP20
Dimension	80x55x20mm





**Remote Control LED Strip  
RGB Touch White/Black 3x6A**

 DC:12V/24V  
 IP20

SKU:	<b>6314</b>	<b>6315</b>
Product Code	AC2-A2	AC2-A2
Power	216W-432W	216W-432W
Voltage	12V / 24V	12V / 24V
Body Color	White	Black
Dimension	95x50x30mm	95x50x30mm

**Sensor Dimmer  
Wall Mounted 10A**

IP20

SKU:	<b>6318</b>
Product Code	AC2-A2
Power	120W-240W
Voltage	12V / 24V
Body Color	Black
Dimension	85x85x40mm

**Remote Control LED Strip  
RGBW Touch 4x6A**

 DC:12V/24V  
 IP20

SKU:	<b>6329</b>
Product Code	AC2-A2
Power	288W-576W
Voltage	12V / 24V
IP Rating	IP20
Dimension	80x45x15mm

**Sensor Dimmer  
Wall Mounted 10A**

IP20

SKU:	<b>6320</b>
Product Code	AC2-A2
Power	120W-240W
Voltage	12V / 24V
Body Color	White
Dimension	85x85x40mm

**Music LED Controller  
With Remote Control 3x4A**

 DC:12V/24V  
 IP20

SKU:	<b>6312</b>
Product Code	AC2-A2
Power	144W-288W
Voltage	12V-24V
IP Rating	IP20
Dimension	170x85x23mm

**Sensor Dimmer  
Wall Mounted RGB 3x4A**

IP20

SKU:	<b>6317</b>
Product Code	AC2-A2
Power	144W-288W
Voltage	12V-24V
IP Rating	IP20
Dimension	85x85x40mm

**DMX512 Decoder  
3x4A**

 DC:12V/24V  
 IP20

SKU:	<b>6308</b>
Product Code	AC2-A2
Power	144W-288W
Voltage	12V-24V
IP Rating	IP20
Dimension	160x60x42mm

**Sensor Dimmer  
Wall Mounted RGB 3x4A**

IP20

SKU:	<b>6319</b>
Product Code	AC2-A2
Power	144W-288W
Voltage	12V-24V
IP Rating	IP20
Dimension	85x85x40mm

**LED Remote Control Set  
Single Color RF 2.4G 3CH 3x4A V3**
**LED Remote**

Output signal	RF 2.4GHz
Working voltage	3VDC(CR2032)
Standby time	12 months
Remote distance	30m
Dimension	107x58.5x9mm

SKU: 6348 *Professional series***LED Receiver**

Input voltage	12/24VDC
Output power	144W/288W
Output current	3CH,4A/CH
IP Rating	IP20
Dimension	97x33x18mm

**LED Single Color Remote Control  
Touch - 1 Zone RF 2.4GHZ**

- \* Match with OPTONICA Professional LED Controllers.
- \* Ultra sensitive color adjustment touch slide.
- \* Each remote can match one or more receivers.
- \* Operate with LED indicator light.
- \* Magnet on the back which can be easily stuck on any metal surfaces
- \* CR2032 battery powered.

SKU: 6359 *Professional series*

IP20



Dimmable



Battery

**LED Remote Control Set  
RGB - RF 2.4G 3CH 3x4A V3**
**LED Remote**

Output signal	RF 2.4GHz
Working voltage	3VDC(CR2032)
Standby time	12 months
Remote distance	30m
Dimension	107x58.5x9mm

SKU: 6349 *Professional series***LED Receiver**

Input voltage	12/24VDC
Output power	144W/288W
Output current	3CH,4A/CH
IP Rating	IP20
Dimension	97x33x18mm

**LED RGB Remote Control  
Touch - 1 Zone RF 2.4GHZ**

- \* Match with OPTONICA Professional LED Controllers.
- \* Ultra sensitive color adjustment touch slide.
- \* Each remote can match one or more receivers.
- \* Operate with LED indicator light.
- \* Magnet on the back which can be easily stuck on any metal surfaces
- \* CR2032 battery powered.

SKU: 6360 *Professional series*

IP20



Dimmable



Battery

**RGB+CCT LED Strip Controller Kit  
5 channels constant voltage/Step-less dimming**

IP20

- 5 Channels constant voltage output for RGB+ CCT light
- Ultra sensitive color adjustment touch wheel
- Smooth dimming and switch without any flickering
- Built in 10 dynamic mode, include jump or gradual change style
- Independent dimming function of each R, G, B channel to achieve millions of colors
- Auto-transmitting function: Controller automatically transmit signal to another controller with 30m control distance
- Synchronize on multiple number of controllers
- Light on/off fade time 3s selectable

SKU: 6387 *Professional series*
**LED RGB + CCT Remote Control  
Touch - 4 Zone RF 2.4GHZ**

- \* Match with OPTONICA Professional LED Controllers.
- \* Ultra sensitive color adjustment touch wheel.
- \* Each remote can match one or more receivers.
- \* Operate with LED indicator light.
- \* AAAX2 battery powered.
- \* Dimension 122x53x17.5mm

SKU: 6368 *Professional series*

IP20



Dimmable



Battery

**Bluetooth & RF 2CH LED Controller  
2 Channels/Push-Dim/Wireless control**

IP20

- Remote control or connected with external push switch to achieve on/off and dimming function
- Ultra sensitive brightness adjustment touch slide
- Smooth dimming and switch without any flickering
- Auto-transmitting function: Controller automatically transmit signal to another controller with 30m control distance
- Synchronize on multiple number of controllers
- Light on/off fade time 3s selectable
- Magnet on the back which can be easily stuck on back holder or any metal surfaces

SKU: 6386 *Professional series*
**LED CCT Remote Control  
Touch - 4 Zone RF 2.4GHZ**

- \* Match with OPTONICA Professional LED Controllers.
- \* Ultra sensitive color adjustment touch wheel.
- \* Each remote can match one or more receivers.
- \* Operate with LED indicator light.
- \* AAAX2 battery powered.
- \* Dimension 122x53x17.5mm

SKU: 6350 *Professional series*

IP20



Dimmable



Battery

**Wall Mounted Touch Panel**  
**4 Zone/Color wheel/AC input/DMX 512 signal**

Input Voltage	12-36VDC	Output Current	2CH,5A/CH
Input Current	10.5A	Output Power	2x(60-180)W
Output Voltage	2X(12-36)VDC	Output Type	Constant Voltage

- Used for control single color or color temperature LED strip.
- Tuya APP cloud control, support on/off, color temperature and brightness adjust, delay turn on/off light,
- Each controller can also work as Bluetooth-RF converter, then use Tuya APP to control one or more RF LED controller or RF LED dimming driver synchronously.

 SKU: 6376 Professional series

**Wall Mounted Touch Panel**  
**4 Zone/Color wheel/AC input/DMX 512 signal**

Input Voltage	12-24VDC	Output Power	2x(60-180)W
Input Current	10.5A	Output Type	Constant Voltage
Output Voltage	2X(12-36)VDC		

- Used for control single color or color temperature LED strip.
- Tuya APP cloud control, support on/off, color temperature and brightness adjust, delay turn on/off light,
- Each controller can also work as Bluetooth-RF converter, then use Tuya APP to control one or more RF LED controller or RF LED dimming driver synchronously.

 SKU: 6377 Professional series

**LED Remote Control**  
**Single Color Touch - 2.4GHZ**

- \* Touch panel 4 zone 1 color RF remote.
- \* Each zone can remote control multiple receivers, LED controller, dimming driver or smart lamp.
- \* Ultra sensitive high strength glass touch panel with touch color slide in the middle.
- \* Smooth and accurate adjustment by touching the slide.
- \* Touch keys with chord tones and LED indicator.
- \* Free installation, no wiring, removable.
- \* AAA x 2 battery powered.

 SKU: 6375 Professional series

**LED Remote Control**  
**RGB/RGBW Touch - 2.4GHZ**

- \* Touch panel 4 zone 1 color RF remote.
- \* Each zone can remote control multiple receivers, LED controller, dimming driver or smart lamp.
- \* Ultra sensitive high strength glass touch panel with touch color slide in the middle.
- \* Smooth and accurate adjustment by touching the slide.
- \* Touch keys with chord tones and LED indicator.
- \* Free installation, no wiring, removable.
- \* AAA x 2 battery powered.

 SKU: 6374 Professional series

**Ultra thin Touch Wheel RF Remote Controller**  
**4 zone RGB+CCT/Touch color wheel**

- Apply to RGB+CCT LED controller.
- Ultra sensitive color adjustment touch wheel.
- Each remote can match one or more receiver.
- CR2032 battery powered.
- Operate with LED indicator light.

 SKU: 6381 Professional series

**Desk Mount RF Remote Controller**  
**Rotary dimming/CR2032 battery**

Output signal	RF(2.4GHz)	Standby current	<10μA
Working voltage	3VDC(CR2032)	Standby time	1 year
Working current	<5mA	Remote distance	30m

- Apply to RGB LED controller.
- Rotate knob to change RGB color, color temperature or brightness, support long press or twice click operation.
- Each remote can match one or more receiver.
- CR2032 battery powered.
- Desk mount, removable anywhere easily.

 SKU: 6379 Professional series

**RF Signal Repeater**  
**AC or DC input /Wall junction box mounting**

Input Voltage	12-36VDC ; 100-240VAC
Input/Output	RF 2.4GHz
RF Control Distance	30m

- Apply for wireless signal extension, greatly ensures RF communication stability and wide controlling area.
- Powered by AC100-240V or DC12-24V.
- Compatibility with RF 2.4G remote control.
- Easy to be placed in standard wall junction box.

 SKU: 6382 Professional series

**WiFi & RF AC Triac Dimmer**  
**Voice control/RF dimming/Push Dim**

Input Voltage	AC100-240V	Output Current	MAX 1.5A
Output Voltage	AC100-240V	Output Power	150-360W

- WiFi + RF + Push AC phase-cut dimmer, 1 channel output.
- Voice control, support amazon ECHO and TmallGenie smart speaker.
- 256 levels 0-100% dimming smoothly without any flash.
- Compatibility with RF 2.4G single zone or multiple zone dimming remote control.
- Easy to be placed in standard wall junction box behind a push switch.
- Over-heat / Over-load protection, recover automatically.

 SKU: 6388 Professional series



**Bluetooth & RF 2CH LED Controller**  
**2 Channels/Push-Dim/Wireless control**

Input Voltage	12-36VDC	Output Current	2CH,5A/CH
Input Current	10.5A	Output Power	2x(60-180)W
Output Voltage	2X(12-36)VDC	Output Type	Constant Voltage

- Used for control single color or color temperature LED strip.
- Tuya APP cloud control, support on/off, color temperature and brightness adjust, delay turn on/off light.
- Each controller can also work as Bluetooth-RF converter, then use Tuya APP to control one or more RF LED controller or RF LED dimming driver synchronously.

SKU: 6384 Professional series
**WiFi & RF 5 in1 LED Controller**  
**Tuya APP cloud control/Voice control/5 Channels**

Input Voltage	12-24VDC	Output Current	5CH,3A/CH
Input Current	15.5A	Output Power	5x(36-72)W
Output Voltage	5X(12-24)VDC	Output Type	Constant Voltage

- 5 in 1 function, used for control RGB, RGBW, RGB+CCT, color temperature or single color LED strip.
- Voice control, support amazon ECHO and TmallGenie smart speaker.
- Match with RF 2.4G remote control optional.
- Light on/off fade time 3s selectable.

SKU: 6383 Professional series
**Constant Voltage LED Waterproof Controller**  
**4 Channels/Wireless remote control/Synchronize**

Input Voltage	12-36VDC	Output Current	4CH,5A/CH
Input Current	20.5A	Output Power	4x(60-180)W
Output Voltage	4X(12-36)VDC	Output Type	Constant Voltage

- When using with RGB/RGBW light, built in 10 dynamic mode, include jump or gradual change style.
- Auto-transmitting function: Controller automatically transmit signal to another controller with 30m control distance.
- Synchronize on multiple number of controllers.
- Fade in and out effect selectable.

SKU: 6380 Professional series
**Constant Voltage Waterproof Power Repeater**  
**4 Channel/PWM signal input**

Input Voltage	12-36VDC	Output Current	4CH,5A/CH
Input Current	20.5A	Output Power	4x(60-180)W
Output Voltage	4X(12-36)VDC	Output Type	Constant Voltage

- Waterproof 12-36V constant voltage power repeater with IP67 rating, suitable for outdoor and damp environment.
- 4 channel, 5A per channel.
- To receive PWM signal control.
- Power repeater in series or in parallel to expand output unlimitedly.
- Apply to single color, dual color, RGB or RGBW constant voltage LED strip or module.

SKU: 6395 Professional series
**6 Channel DMX Sliding Fader Console**  
**6 Sliding Faders / Real DMX Value LED Screen**

Ideal Cost Efficient 6 Channel Mini DMX Fader Console

- Easy Usage
- Suitable for permanent installations by using available brackets
- Ideal for Sample Testing and Trouble-Shooting on-site or workshops
- Powered by 3 x AAA Batteries or external 5-12V Power-Supply
- 3 Digit LED Screen 0-100% or DMX000-DMX255 (Settings by internal DIP-Switch)
- 6 Channel Mode or 5 Channel & Master Mode (Settings by internal DIP-Switch)

SKU: 6392 Professional series
**Constant Voltage DMX512 & RDM Decoder**  
**Linear or logarithmic dimming/Numeric display**

Comply with the DMX512 standard protocols.

- Digital numeric display, set DMX decode start address by buttons.
- RDM function can realize intercommunication between DMX decoder address can be set by DMX master console.
- 1/2/4 DMX channel output selectable.
- 16bit (65536 levels) /8bit (256 levels) grey level selectable.
- Stand-alone RGB/RGBW mode and 4 channel dimmer mode selectable, which be controlled by buttons with built-in programs, instead of DMX signal.

SKU: 6390 Professional series
**4 Ways DMX Signal Splitter**  
**DMX512-A compatible**

- One DMX512 signal input, repeat four DMX512 signal output, each allowing for 32 DMX devices to be connected.
- Dedicated to amplify, distribute and insulate the signal that comes from the lighting system equipment when it is connected to the bus of DMX512(or RS-485).
- Input isolated from outputs to 500VAC, 1000VDC.
- Outputs are isolated from each other to 500VAC, 1000VDC.
- Input and outputs are ture RS-485 rated, and no microprocessors are used for maximum reliability.

SKU: 6391 Professional series
**Constant Voltage Power Repeater**  
**5 Channel/PWM signal input/Constant voltage**

- 12-24V constant voltage power repeater.
- 5 channel, 5A per channel.
- To receive PWM signal control.
- Power repeater in series or in parallel to expand output unlimitedly.
- Apply to RGB+CCT constant voltage LED strip or module.

SKU: 6396 Professional series

**Constant Voltage Power Repeater**  
**1 Channel/PWM signal input**

IP20

Input Voltage	12-24VDC	Output Current	15A
Input Current	15.5A	Output Power	180-360W
Output Voltage	12-36VDC	Output Type	Constant Voltage

- 12-24V constant voltage power repeater.
- one channel, 15A.
- To receive PWM signal control.
- Power repeater in series or in parallel to expand output unlimitedly.
- Apply to single color constant voltage LED strip or module.

SKU: 6393

Professional series

**PIR Sensor Stair Light Controller**  
**PIR sensor/Daylight Sensor/Max 32 step**

IP20

Input Voltage	5-24VDC	Output Current	32CH,1A/CH
Output Voltage	32 x (5-24)VDC	Output Power	32 x (5-24)W
Output Type	Constant Voltage+SPI(TTL)		

- Multiple function PIR sensor stair light controller with daylight sensor.
- 32 channels constant voltage output drive low voltage LED strip, Max. 1A
- Built-in multiple color mode, speed and brightness 1-8 grade adjustable.
- Push switch can also be as induction signal input.
- With fast self-testing function.
- Any damaged LED channel in 32 channels can be set disable.

SKU: 6385

Professional series

**12-60V Constant Voltage Power Repeater**  
**4 Channel/12-60V/PWM signal input**

IP20

Input Voltage	12-60VDC	Output Current	4CH,5A/CH
Input Current	20A	Output Power	4x(60-300)W
Output Voltage	4X(12-60)VDC	Output Type	Constant Voltage

- 12-60V constant voltage power repeater.
- 3/4 channel, 5A max. per channel.
- To receive PWM signal control.
- Power repeater in series or in parallel to expand output unlimitedly.
- Apply to single color, dual color, RGB or RGBW constant voltage LED strip or module.

SKU: 6394

Professional series

**RGB LED Mini Controller without remote**  
**3 channel constant voltage/Max 4.5A output**

IP20

Input Voltage	12-24VDC	Output Current	3CH,1.5A/CH
Output Voltage	12-24VDC	Output Type	Constant Voltage

- 3 channel constant voltage RGB LED mini controller.
- 3 key operation with on/off, mode and color adjustment.
- 1.5A per channel, output connect with 5 meters RGB LED strip.
- 256 levels 0-100% dimming smoothly without any flash.
- Built in 10 dynamic mode, include jump or gradual change style.

SKU: 6378

Professional series

**Dimming High Voltage LED Strip Controller**  
**3 Channels/Step-less dimming/Wireless control**

IP20

Input Voltage	110-240VAC	Output Current	3CH,1A/CH
Input Current	3.2A	Output Power	3x(110-240)W
Output Voltage	3X(110-240)VDC		

- 3 channel high voltage LED strip RF 2.4G controller
- Match with RF 2.4G single zone or multiple zone single color, dual color and RGB/RGBW remote control.
- One RF controller accept up to 10 remote control.
- When using with RGB light, built in 10 dynamic mode, include jump or gradual change style.

SKU: 6397

Professional series

**DMX512 /0-10V to Triac Dimmer**  
**RDM/Stand-alone function/Numeric display/**

IP20

Input Voltage	100-240VAC	Output Current	1CH,6A/CH
Output Voltage	100-240VAC	Output Power	600-1440)W

- AC phase-cut mosfet dimmer with DMX512 function, one channel output.
- Comply with the DMX512 standard protocols.
- Digital numeric display, set DMX decode start address by buttons.
- Reverse-phase dimming or forward-phase dimming selectable.
- Minimum brightness set from 1% to 40%.
- Stand-alone dynamic mode and dimmer mode selectable, which be controlled by buttons with built-in programs, instead of DMX signal.

SKU: 6389

Professional series



Wall mounted holder for 6345

SKU: 6347



## LED RGB/RGBW Remote Control

**4 Zone RF 2.4GHZ***Professional series*

- \* Match with OPTONICA Professional LED Controllers.
- \* Ultra sensitive color adjustment touch wheel.
- \* Each remote can match one or more receivers.
- \* Operate with LED indicator light.
- \* AAAx2 battery powered.
- \* Dimension 122x53x17.5mm

SKU: 6345



IP20



Dimmable



Battery

Remote Holder  
for all remotes  
SKU: 6334

## LED RGB/RGBW Remote Control

**4 Zone RF 2.4GHZ***Professional series*

- \* Match with OPTONICA Professional LED Controllers.
- \* Ultra sensitive color adjustment touch wheel.
- \* Each remote can match one or more receivers.
- \* Slim and light
- \* CR2032 battery powered.
- \* Dimension 107x58.5x9mm

SKU: 6335



IP20



Dimmable



Battery



Wall mounted holder for 6341

SKU: 6346



## LED Remote Control

**4 Zone Single Color RF 2.4GHZ***Professional series*

- \* Match with OPTONICA Professional LED Controllers.
- \* Each remote can match one or more receivers.
- \* Slim and light
- \* IP20
- \* CR2032 battery powered.
- \* Dimension 135x40x11mm

SKU: 6341



IP20



Dimmable



Battery



Wall mounted holder for 6340

SKU: 6346



## LED Remote Control

**1 Zone CCT RF 2.4GHZ***Professional series*

- \* Match with OPTONICA Professional LED Controllers.
- \* Each remote can match one or more receivers.
- \* Slim and light.
- \* IP20
- \* CR2032 battery powered.
- \* Dimension 107x58.5x9mm

SKU: 6340



IP20



Dimmable



Battery

## LED Controller

**3 Channel x 4A***Professional series*

IP20



SKU:	<b>6353</b>	Output Voltage	3X(12-24)VDC
Product Code	AC2-A3	Output Current	3CH,4A/CH
Input Voltage	12-24VDC	Output Power	144/288W
Input Current	12.5A	Output Type	Constant Voltage
Input Signal	RF2.4Ghz	Dimension	96x33x17 mm

- \* Match with OPTONICA Professional Series Remote Controls.
- \* One RF controller accept up to 10 remote control.
- \* Build in 10 dynamic mode, include jump or gradual change style.
- \* Auto-transmitting function: Controller automatically transmit signal of another controller with 30m control distance.
- \*Synchronize on multiple number of controllers.

## LED Controller

**4 Channel x 5A***Professional series*

IP20



SKU:	<b>6342</b>	Output Voltage	4x(12-36)VDC
Product Code	AC2-A3	Output Current	4CH,5A/CH
Input Voltage	12-36VDC	Output Power	4x(60-180)W
Input Current	20.5A	Output Type	Constant Voltage
Input Signal	RF2.4Ghz+Push	Dimension	175x45x27 mm

- \* Match with OPTONICA Professional Series Remote Controls.
- \* One RF controller accept up to 10 remote control.
- \* Build in 10 dynamic mode, include jump or gradual change style.
- \* Auto-transmitting function: Controller automatically transmit signal of another controller with 30m control distance.
- \*Synchronize on multiple number of controllers.
- \*Connect with external push switch to achieve on/off and dimming function.

## LED Controller

**4 Channel x 300mA Constant Current***Professional series*

IP20



SKU:	<b>6343</b>	Output Voltage	4x(12-48)VDC
Product Code	AC2-A3	Output Current	4CH,300mA/CH
Input Voltage	12-48VDC	Output Power	4x(3.6-14.4)W
Input Current	1.5A	Output Type	Constant Current
Input Signal	RF2.4Ghz+Push	Dimension	175x45x27 mm

- \* Match with OPTONICA Professional Series Remote Controls.
- \* One RF controller accept up to 10 remote control.
- \* Build in 10 dynamic mode, include jump or gradual change style.
- \* Auto-transmitting function: Controller automatically transmit signal of another controller with 30m control distance.
- \*Synchronize on multiple number of controllers.
- \*Connect with external push switch to achieve on/off and dimming function.



**Smart Wifi-BLE Music Controller**  
**IR 44 Keys RGB**

Input Voltage DC12-24V  
 Output 3 Channels  
 Output Current 2A (each channel)  
 Output Power 12V-72W ; 24V-144W  
 Dimension 70x30x15 mm

\* Support remote/ local control through 2G / 3G /4G / Wi-Fi networks.

SKU: 6336



IP20



Dimmable



Battery

**Smart Wifi-BLE Controller**  
**IR 24 Keys RGCCT**

Input Voltage DC12-24V  
 Output 5 Channels  
 Output Current 1A (each channel)  
 Output Power 12V-60W ; 24V-120W  
 Dimension 70x30x15 mm

\* Support remote/ local control through 2G / 3G /4G / Wi-Fi networks.

SKU: 6337



IP20



Dimmable



Battery

**Smart Wifi-BLE Controller**  
**IR 14 Keys CCT**

Input Voltage DC12-24V  
 Output 2 Channels  
 Output Current 2A (each channel)  
 Output Power 12V-48W ; 24V-96W  
 Dimension 70x30x15 mm

\* Support remote/ local control through 2G / 3G /4G / Wi-Fi networks.

SKU: 6338



IP20



Dimmable



Battery

**LED Controller**  
**IR 40 Keys RGBW**

Input Voltage DC12-24V  
 Output 4 Channels  
 Output Current 2A (each channel)  
 Output Power 12V-96W ; 24V-192W  
 Dimension 70x30x15 mm

\* Support remote/ local control through 2G / 3G /4G / Wi-Fi networks.

SKU: 6339



IP20



Dimmable



Battery

**LED Controller**
**1 Channel x 8A**

Professional series



IP20

SKU: 6321	Output Voltage	1X(12-24)VDC
Product Code AC2-A3	Output Current	8A/CH
Input Voltage 12-24VDC	Output Power	96/384W
Input Current 8A	Output Type	Constant Voltage
Input Signal RF2.4Ghz	Dimension	97x33x18 mm

\* Match with OPTONICA Professional Series Remote Controls.  
 \* Fade-in Fade-out LED dimmer with smooth fading effect for soft start and stop  
 \* The fading speed can be set via knob potentiometer, 1S, 3S, 5S, 10S, 20S selectable.  
 \* Connect with self-resetting metal button or push switch to achieve on/off and 0-100% dimming function.  
 \* Push input can accept either positive or negative trigger.

**LED Controller**
**1 Channel x 8A**

Professional series



IP20

SKU: 6322	Output Voltage	1X(5-36)VDC
Product Code AC2-A3	Output Current	1CH,8A
Input Voltage 5-36VDC	Output Power	40W/96W/192W/288W
Input Current 8.5A	Output Type	Constant Voltage
Input Signal RF2.4Ghz	Dimension	97x33x18 mm

\* 4096 levels 0-100% dimming smoothly without any fash.  
 \* One RF controller accept up to 10 remote control.  
 \* Match with RF 2.4G single zone or multiple zone dimming remote control.  
 \* Auto-transmitting function: Controller automatically transmit signal to another controller with 30m control distance.  
 \* Synchronize on multiple number of controllers.

**LED Controller**
**1 Channel x 8A**

Professional series



IP20

SKU: 6352	Input Signal	Tuya App + RF 2.4Ghz
Input Voltage 5-25VDC	Output Signal	SPI(TTL)x2
Input Current 8A	Dimension	120x43x27 mm

\* Multi-pixel RGB/RGBW LED strip controller with SPI signal output, Tuya APP cloud control.  
 \* Voice control, support for Amazon ECHO, Google, Tmall Genie and Xiaodu smart speakers.  
 \* Compatible with 45 kinds of RGB or RGBW LED strips.  
 \* Rich dynamic effects: 44 default and 10+ custom dynamic scenarios, 16 variations.  
 \* Match with RF 2.4G RGB remote control.

## DMX512 &amp; RDM Decoder

**4 Channel x 5A**

Professional series



IP20



SKU:	6364	Output Voltage	12-24VDC
Product Code	AC2-A3	Output Current	4CH,5A/CH
Input Voltage	12-24VDC	Output Power	4x(60-120)W
Input Current	20.5A	Output Type	Constant Voltage
IP Rating	IP20	Dimension	170x50x24 mm

- \* Match with OPTONICA Professional Series Remote Controls.
- \* Comply with the DMX512 standard protocols.
- \* Digital numeric display, set DMX address by buttons.
- \* RDM function can realize intercommunication between DMX master and decoder.
- \* 1/2/4 DMX channel output selectable.
- \* Stand-alone RGB/RGBW mode and 4 channel dimmer mode selectable.

## LED Dimmer

**4 Channel x 5A**

Professional series



IP20



SKU:	6369	Output Voltage	12-36VDC
Product Code	AC2-A3	Output Current	4CH,5A/CH
Input Voltage	12-36VDC	Output Power	4x(60-180)W
Input Current	20.5A	Output Type	Constant Voltage
Input Signal	0/1-10V+Push	Dimension	175x45x27 mm

- \* Match with OPTONICA Professional Series Remote Controls.
- \* 4 channel 0/1-10V LED dimming driver with push-dim function.
- \* 4 channel 0/1-10V input, 4 channel PWM constant voltage output.
- \* 0~100% dimming range via logarithmic characteristic can be very comfortable for human eyes.

## LED Controller

**5 Channel x 5A**

Professional series



IP20



SKU:	6366	Output Voltage	5x(12-24)VDC
Product Code	AC2-A3	Output Current	5CH,5A/CH
Input Voltage	12-24VDC	Output Power	5x(60-120)W
Input Current	25.5A	Output Type	Constant Voltage
IP Rating	IP20	Dimension	175x45x27 mm

- \* Match with OPTONICA Professional Series Remote Controls.
- \* One RF controller accept up to 10 remote control.
- \* Build in 10 dynamic mode, include jump or gradual change style.
- \* Auto-transmitting function: Controller automatically transmit signal of another controller with 30m control distance.
- \* Synchronize on multiple number of controllers.
- \* Connect with external push switch to achieve on/off and dimming function.

## DALI LED Dimmer

**1 Channel 15A**

Professional series



IP20



SKU:	6371	Output Voltage	12-24VDC
Product Code	AC2-A3	Output Current	1CH,15A
Input Voltage	12-24VDC	Output Power	180W/360W
Input Current	15A	Output Type	Constant Voltage
Input Signal	DALI+Push	Dimension	175x45x27 mm

- \* Match with OPTONICA Professional Series Remote Controls.
- \* Constant voltage DALI LED dimmer with 1 channel, 15A output.
- \* DALI address will be automatically assigned by DALI master, 1 DALI address.
- \* PWM digital dimming, standard DALI logarithmic dimming curve.
- \* Connect with external push switch to achieve on/off and dimming function.

## LED Dimmer

**1 Channel 12A**

Professional series



IP20



SKU:	6367	Output Voltage	12-36VDC
Product Code	AC2-A3	Output Current	1CH,12A
Input Voltage	12-36VDC	Output Power	144-432W
Input Current	12.5A	Output Type	Constant Voltage
Input Signal	0/1-10V+Push	Dimension	175x45x27 mm

- \* Match with OPTONICA Professional Series Remote Controls.
- \* 1 channel 0/1-10V LED dimming driver with push-dim function.
- \* 1 channel 0/1-10V input, 1 channel PWM constant voltage output.
- \* 0~100% dimming range via logarithmic characteristic can be very comfortable for human eyes.

## DALI LED Dimmer

**4 Channel x 5A**

Professional series



IP20



SKU:	6372	Output Voltage	12-24VDC
Product Code	AC2-A3	Output Current	4CH,5A/CH
Input Voltage	12-24VDC	Output Power	4x(60-120)W
Input Current	20.5A	Output Type	Constant Voltage
Input Signal	DALI	Dimension	175x45x27 mm

- \* Match with OPTONICA Professional Series Remote Controls.
- \* 4 channel constant voltage DALI LED Dimmer, 5A per channel.
- \* 4 DALI address, 4 channel work separately.
- \* DALI address will be automatically assigned by DALI master.
- \* PWM digital dimming, standard DALI logarithmic dimming curve.

## LED Controller

Professional series



SKU:	<b>6355</b>	Output Voltage	4x(12-24)VDC
Product Code	AC2-A3	Output Current	4CH,5A/CH
Input Voltage	12-24VDC	Output Power	4x(60-120)W
Input Current	20.5A	Output Type	Constant Voltage
IP Rating	IP20	Dimension	110x64x45mm



IP20

- \* Match with OPTONICA Professional Series Remote Controls.
- \* Digital numeric display and easy key operation.
- \* Can set as 1 channel dimmer, 4 channel, dual color, RGB or RGBW controller.
- \* Logarithmic or linear dimming curve selectable.
- \* Synchronize on multiple number of controllers.

## AC Triac RF Dimmer

RF 2.4GHz + Push

Professional series



SKU:	<b>6363</b>	Output Voltage	100-240VAC
Product Code	AC2-A3	Output Current	MAX 1A
Input Voltage	100-240VAC	Output Power	100-240W
Input Signal	RF2.4GHz+Push	Dimming level	256 levels
IP Rating	IP20	Dimension	56x56x26 mm



IP20

- \* Match with OPTONICA Professional Series Remote Controls.
- \* RF+ Push AC phase-cut dimmer, 1channel output.
- \* 0-100% dimming smoothly without any flash.
- \* Connect with external push switch to achieve ON/OFF and dimming function.
- \* Easy to be inserted into standard 86x86mm wall box

## AC TRIAC Dimmer

Professional series



SKU:	<b>6365</b>	Output Voltage	100-240VAC
Product Code	AC2-A3	Output Current	1CH,2A/CH
Input Voltage	100-240VAC	Output Power	200-480W
Input Signal	RF2.4GHz+Push	Dimming level	100 levels
IP Rating	IP20	Dimension	110x64x45 mm



IP20

- \* Match with OPTONICA Professional Series Remote Controls.
- \* RF+ Push AC phase-cut dimmer, 1channel output.
- \* Digital numeric display, set brightness by buttons.
- \* 0-100% dimming smoothly without any flash.
- \* Reverse-phase dimming or forward-phase dimming selectable.
- \* Minimum brightness set from 1% to 40%

## LED Controller

3 Channel x 10A

Professional series



SKU:	<b>6356</b>	Output Voltage	3x(12-36)VDC
Product Code	AC2-A3	Output Current	3CH,10A/CH
Input Voltage	12-36VDC	Output Power	3x(120-360)W
Input Current	30.5A	Output Type	Constant Current
Input Signal	RF2.4GHz	Dimension	105x75x25 mm



IP20

- \* Match with OPTONICA Professional Series Remote Controls.
- \* One RF controller accept up to 10 remote control.
- \* Build in 10 dynamic mode, include jump or gradual change style.
- \* Auto-transmitting function: Controller automatically transmit signal of another controller with 30m control distance.
- \* Synchronize on multiple number of controllers.

## Power Repeater

Professional series



SKU:	<b>6370</b>	Output Voltage	4x(12-24)VDC
Product Code	AC2-A3	Output Current	4CH,5A/CH
Input Voltage	12-24VDC	Output Power	4x(60-120)W
Input Current	20.5A	Output Type	Constant Voltage
IP Rating	IP20	Dimension	110x64x45 mm



IP20

- \* Match with OPTONICA Professional Series Remote Controls.
- \* To receive PWM signal control.
- \* Power repeater in series or in parallel to expand output unlimitedly.
- \* Apply to single color, dual color, RGB or RGBW constant voltage LED strip or module.
- \* 3KV Optoelectronic isolation.

## WiFi - Relay 2.4GHz

WiFi to RF Converter

Professional series



SKU:	<b>6354</b>	Output Control	RGB,RGBW,CT
Product Code	AC2-A3	Working Temp.	-20°C~50°C
Input Voltage	5-24VDC	Platform	iOS, Android
Wifi standard	802.11 b/g/n	Dimension	ø72x25 mm



IP20





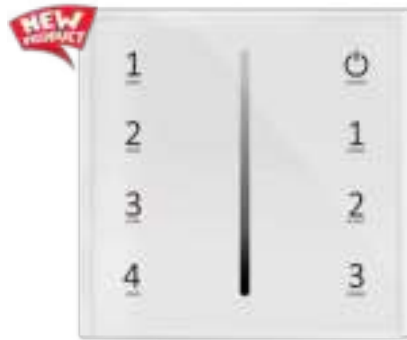

## LED 0-10V DIMMER

## 4 Zones - Touch glass panel

Professional series

SKU:	6398	Output Signal	0-10V (20mA)
Input Voltage	100-240V	Output Current	20mA/CH
IP Rating	IP20	Dimension	86x86x33 mm

- \*Touch panel 0-10V dimmer, output 4 channel 0-10V signal
- \* Output connect with 0/1-10V dimmable driver.
- \* Ultra sensitive high strength glass touch panel with touch slide in the middle.
- \* Compatibility with RF 2.4G dimming remote control.
- \*Touch keys with LED indicator.



## LED 0-10V DIMMER

## 1 Channel - Rotary glass panel

Professional series

SKU:	6399	Output Signal	0-10V (50mA)
Input Voltage	100-240V	Output Current	1.5A
IP Rating	IP20	Dimension	86x86x48 mm

- \* Rotary glass panel 1-10V dimmer, 1 channel output.
- \* Output connect with 0/1-10V dimmable driver.
- \* Output 1 channel 1-10V signal, connect with 1-10V dimmable driver.
- \* High voltage AC input, High voltage AC relay output.
- \*Compatibility with RF 2.4G single zone or multiple zone dimming remote control.



## LED AC TRIAC DIMMER

## 1 Channel - Rotary glass panel

Professional series

SKU:	6351	Output Power	150-360W
I/O Voltage	100-240V	Output Current	Max 1.5A
IP Rating	IP20	Dimension	86x86x48 mm

- \* Rotary glass panel AC phase-cut dimmer, 1 channel output.
- \* To dim and switch single color dimmable LED lamps, traditional incandescent and halogen lights.
- \* 256 levels 0-100% dimming smoothly without any flash.
- \* Leading edge dimming or trailing edge dimming set by dip switch.
- \* Over-heat / Over-load protection, recover automatically.



## LED Single Color Controller

## 4A\*3CH

Professional series

SKU:	6357	Output Voltage	3x(12-24)VDC
Product Code	AC2-A3	Output Current	3CH,4A/CH
Input Voltage	12-24VDC	Output Power	144-288W
Input Current	12.5A	Output Type	Constant Voltage
IP Rating	IP20	Dimension	86x86x53 mm



## LED RGB Controller

## 4A\*3CH

Professional series

SKU:	6358	Output Voltage	3x(12-24)VDC
Product Code	AC2-A3	Output Current	3CH,4A/CH
Input Voltage	12-24VDC	Output Power	144-288W
Input Current	12.5A	Output Type	Constant Voltage
IP Rating	IP20	Dimension	86x86x53 mm



## LED DMX Controller

## 4 Zones control DMX512+RF 2.4G

Professional series

SKU:	6361	Control Mode	4 Zone Control
Product Code	AC2-A3	Light Type	Single Color
Input Voltage	85-265V	Remote Distance	30m
Output Signal	DMX512+RF	Working Temp.	-20°C/+50°C
IP Rating	IP20	Dimension	86x86x36 mm



## LED RGBW DMX Controller

## 4 Zones control DMX512+RF 2.4G

Professional series

SKU:	6362	Control Mode	4 Zone Control
Product Code	AC2-A3	Light Type	RGBW
Input Voltage	85-265V	Remote Distance	30m
Output Signal	DMX512+RF	Working Temp.	-20°C/+50°C
IP Rating	IP20	Dimension	86x86x36 mm



## LED LINEAR AND TRACK LIGHTS



Highly specialized luminaires with concentrated light distribution angle intended for retail or other spot required presentation area. These adjustable fixtures can be combined with variously lengthen three phased tracks along with connectors to suit every design, including rapid solutions for trade fair halls and shopping malls.

#### Features:

- Three colour temperatures offered to match the needs of most commercial shelf products
- Upto 80% cost-saving use
- Quick and easy fool proof on and off installation

#### Application:

- Indoor use
- Any show-room, art gallery, dining rooms companions.
- Popular choice for both residential and commercial projects.



5 Years

Warranty



Linkable

**LED Linear Suspended Light**  
**40W Slim Linkable**

Product code	LN40-A3	CRI	Ra>80
Watts	40W	IP Rating	IP20
Input Voltage	AC : 200-240V	Dimension	1185x60x70 mm
Flux	4000lm	Body Color	BLACK
Beam Angle	120°	Dimmable	NO

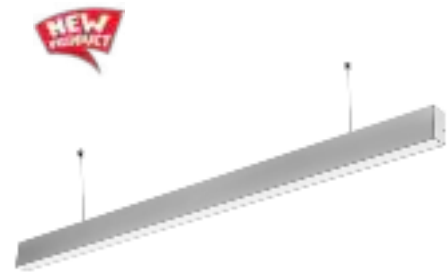
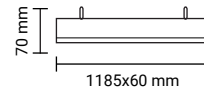
 SKU: 5470    SKU: 5380  
 6000K     4000K

5 Years

Warranty



Linkable

**LED Linear Suspended Light**  
**40W Slim Linkable**

Product code	LN40-A3	CRI	Ra>80
Watts	40W	IP Rating	IP20
Input Voltage	AC : 200-240V	Dimension	1185x60x70 mm
Flux	4000lm	Body Color	SILVER
Beam Angle	120°	Dimmable	NO

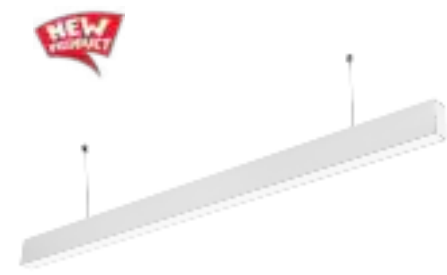
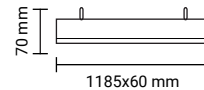
 SKU: 5471    SKU: 5381  
 6000K     4000K

5 Years

Warranty



Linkable

**LED Linear Suspended Light**  
**40W Slim Linkable**

Product code	LN40-A3	CRI	Ra>80
Watts	40W	IP Rating	IP20
Input Voltage	AC : 200-240V	Dimension	1185x60x70 mm
Flux	4000lm	Body Color	WHITE
Beam Angle	120°	Dimmable	NO

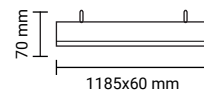
 SKU: 5472    SKU: 5382  
 6000K     4000K

5 Years

Warranty

**LED Linear L-Shape Connector**  
**12W Slim Linkable**

Product code	LN10-A3	CRI	Ra>80
Watts	12W	IP Rating	IP20
Input Voltage	AC : 200-240V	Dimension	176x176x70 mm
Flux	1000lm	Body Shape	L-Shape
Beam Angle	120°	Dimmable	NO

 White Light     6000K    Neutral White     4000K  
 SKU: 5060     Black Body     SKU: 5027     Black Body  
 SKU: 5061     Silver Body     SKU: 5028     Silver Body  
 SKU: 5062     White Body     SKU: 5029     White Body

5 Years

Warranty

**LED Linear T-Shape Connector**  
**15W Slim Linkable**

Product code	LN15-A3	CRI	Ra>80
Watts	15W	IP Rating	IP20
Input Voltage	AC : 200-240V	Dimension	300x176x70 mm
Flux	1500lm	Body Shape	T-Shape
Beam Angle	120°	Dimmable	NO

 White Light     6000K    Neutral White     4000K  
 SKU: 5063     Black Body     SKU: 5030     Black Body  
 SKU: 5064     Silver Body     SKU: 5036     Silver Body  
 SKU: 5065     White Body     SKU: 5037     White Body

5 Years

Warranty

**LED Linear X-Shape Connector**  
**20W Slim Linkable**

Product code	LN20-A3	CRI	Ra>80
Watts	20W	IP Rating	IP20
Input Voltage	AC : 200-240V	Dimension	300x300x70 mm
Flux	2000lm	Body Shape	X-Shape
Beam Angle	120°	Dimmable	NO

 White Light     6000K    Neutral White     4000K  
 SKU: 5066     Black Body     SKU: 5038     Black Body  
 SKU: 5067     Silver Body     SKU: 5039     Silver Body  
 SKU: 5068     White Body     SKU: 5040     White Body



LED Linear Suspended Light  
**50W UP-DOWN**



Product code	LN50-A3	CRI	Ra>80
Watts	50W	IP Rating	IP20
Input Voltage	AC : 200-240V	Dimension	1185x28x68 mm
Flux	5000lm	Body Color	BLACK
Beam Angle	120°	Dimmable	NO



SKU: 5383  
4000K

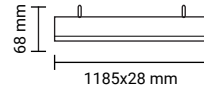

LED Linear Suspended Light  
**50W Linkable**



Product code	LN50-A4	CRI	Ra>80
Watts	50W	IP Rating	IP20
Input Voltage	AC : 200-240V	Dimension	1200x35x67 mm
Flux	4500lm	Body Color	BLACK
Beam Angle	60°	Dimmable	NO



Connector  
SKU: 5047

SKU: 5386  
4000K

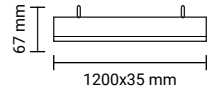

LED Linear Suspended Light  
**50W UP-DOWN**

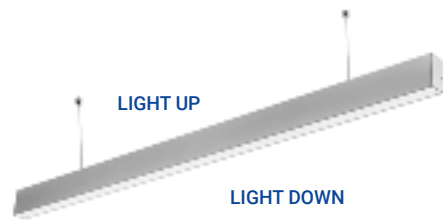

Product code	LN50-A3	CRI	Ra>80
Watts	50W	IP Rating	IP20
Input Voltage	AC : 200-240V	Dimension	1185x28x68 mm
Flux	5000lm	Body Color	SILVER
Beam Angle	120°	Dimmable	NO



SKU: 5384  
4000K

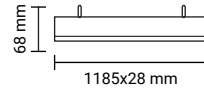

LED Linear Suspended Light  
**50W Linkabe**



Product code	LN50-A4	CRI	Ra>80
Watts	50W	IP Rating	IP20
Input Voltage	AC : 200-240V	Dimension	1200x35x67 mm
Flux	4500lm	Body Color	SILVER
Beam Angle	60°	Dimmable	NO



Connector  
SKU: 5047

SKU: 5387  
4000K

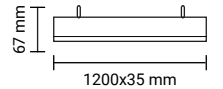

LED Linear Suspended Light  
**50W UP-DOWN**

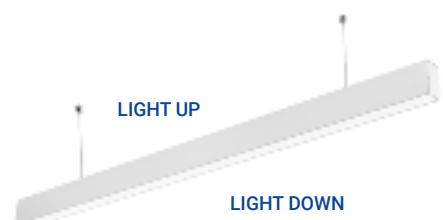

Product code	LN50-A3	CRI	Ra>80
Watts	50W	IP Rating	IP20
Input Voltage	AC : 200-240V	Dimension	1185x28x68 mm
Flux	5000lm	Body Color	WHITE
Beam Angle	120°	Dimmable	NO



SKU: 5385  
4000K

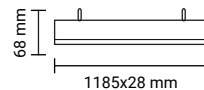

LED Linear Suspended Light  
**50W Linkable**



Product code	LN50-A4	CRI	Ra>80
Watts	50W	IP Rating	IP20
Input Voltage	AC : 200-240V	Dimension	1200x35x67 mm
Flux	4500lm	Body Color	WHITE
Beam Angle	60°	Dimmable	NO



Connector  
SKU: 5047

SKU: 5388  
4000K

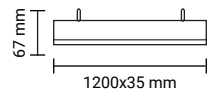



LED Wall washer for Tracks  
**30W** For 3 Phase 4 Line Tracks

**2700** Lumens  
 24°  
 Flicker Free LED

Product code	LN30-A3	CRI	Ra>80
Watts	30W	IP Rating	IP20
Input Voltage	AC : 200-240V	Dimension	610x40x90 mm
Flux	2700lm	Body Color	BLACK
Beam Angle	24°	Dimmable	NO

SKU: 5389  
■ 4000K

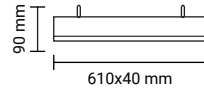

**5** Years  
Warranty

LED Wall washer for Tracks  
**40W** For 3 Phase 4 Line Tracks

**3600** Lumens  
 24°  
 Flicker Free LED

Product code	LN40-A4	CRI	Ra>80
Watts	40W	IP Rating	IP20
Input Voltage	AC : 200-240V	Dimension	9050x40x90 mm
Flux	3600lm	Body Color	BLACK
Beam Angle	24°	Dimmable	NO

SKU: 5390  
■ 4000K

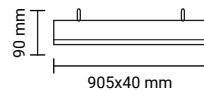

**5** Years  
Warranty



LED COB Track Light  
**25W** For 3 Phase 4 Line Tracks

**3** Years  
Warranty **2750** Lumens

Product code	FL25-A1	CRI	Ra>80
Watts	25W	IP Rating	IP20
Input Voltage	AC : 220-240V	Dimension	ø80x145x160mm
Flux	2750lm	Body Color	WHITE
Beam Angle	24°		

SKU: 5321 ■ 5000K    SKU: 5322 ■ 4500K    SKU: 5323 ■ 3000K

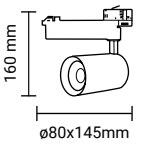

LED COB Track Light  
**25W** For 3 Phase 4 Line Tracks

**3** Years  
Warranty **2750** Lumens

Product code	FL25-A1	CRI	Ra>80
Watts	25W	IP Rating	IP20
Input Voltage	AC : 220-240V	Dimension	ø80x145x160mm
Flux	2750lm	Body Color	BLACK
Beam Angle	24°		

SKU: 5327 ■ 5000K    SKU: 5328 ■ 4500K    SKU: 5329 ■ 3000K

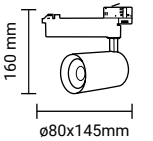

LED COB Track Light  
**35W** For 3 Phase 4 Line Tracks

**3** Years  
Warranty **3850** Lumens

Product code	WL35-A1	CRI	Ra>80
Watts	35W	IP Rating	IP20
Input Voltage	AC : 220-240V	Dimension	ø90x160x160mm
Flux	3850lm	Body Color	WHITE
Beam Angle	24°		

SKU: 5324 ■ 5000K    SKU: 5325 ■ 4500K    SKU: 5326 ■ 3000K

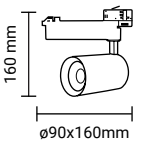

LED COB Track Light  
**35W** For 3 Phase 4 Line Tracks

**3** Years  
Warranty **3850** Lumens

Product code	WL35-A1	CRI	Ra>80
Watts	35W	IP Rating	IP20
Input Voltage	AC : 220-240V	Dimension	ø90x160x160mm
Flux	3850lm	Body Color	BLACK
Beam Angle	24°		

SKU: 5330 ■ 5000K    SKU: 5331 ■ 4500K    SKU: 5332 ■ 3000K

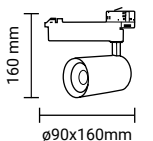

ACCESSORIES FOR TRACK LIGHTS



TRACK SYSTEM - 1M WHITE  
SKU: 5153



TRACK SYSTEM - 1M BLACK  
SKU: 5154



TRACK SYSTEM - 2M WHITE  
SKU: 5156



TRACK SYSTEM - 2M BLACK  
SKU: 5155



CONNECTOP ANGLE - WHITE  
SKU: 5157



CONNECTOP LINE - BLACK  
SKU: 5159



CONNECTOP ANGLE - WHITE  
SKU: 5158



CONNECTOP ANGLE - BLACK  
SKU: 5160



ACCESSORIES FOR 3-PHASE TRACK LIGHTS



TRACK SYSTEM 3PHASES - 1M WHITE  
SKU: 5007



TRACK SYSTEM 3PHASES - 1M BLACK  
SKU: 5009



TRACK SYSTEM 3PHASES - 2M WHITE  
SKU: 5008



TRACK SYSTEM 3PHASES - 2M BLACK  
SKU: 5010



STRAIGHT CONNECTOR WHITE  
SKU: 5013



MINI STRAIGHT CONNECTOR WHITE  
SKU: 5011



T-CONNECTOR WHITE  
SKU: 5017



END CAP WHITE  
SKU: 5023



STRAIGHT CONNECTOR BLACK  
SKU: 5014



MINI STRAIGHT CONNECTOR BLACK  
SKU: 5012



T-CONNECTOR BLACK  
SKU: 5018



END CAP BLACK  
SKU: 5024



L-FEEDER WHITE  
SKU: 5019



L-CONNECTOR WHITE  
SKU: 5015



X-CONNECTOR WHITE  
SKU: 5021



FLEXIBLE CONNECTOR WHITE  
SKU: 5025



L-FEEDER BLACK  
SKU: 5020



L-CONNECTOR BLACK  
SKU: 5016



X-CONNECTOR BLACK  
SKU: 5022



FLEXIBLE CONNECTOR BLACK  
SKU: 5026

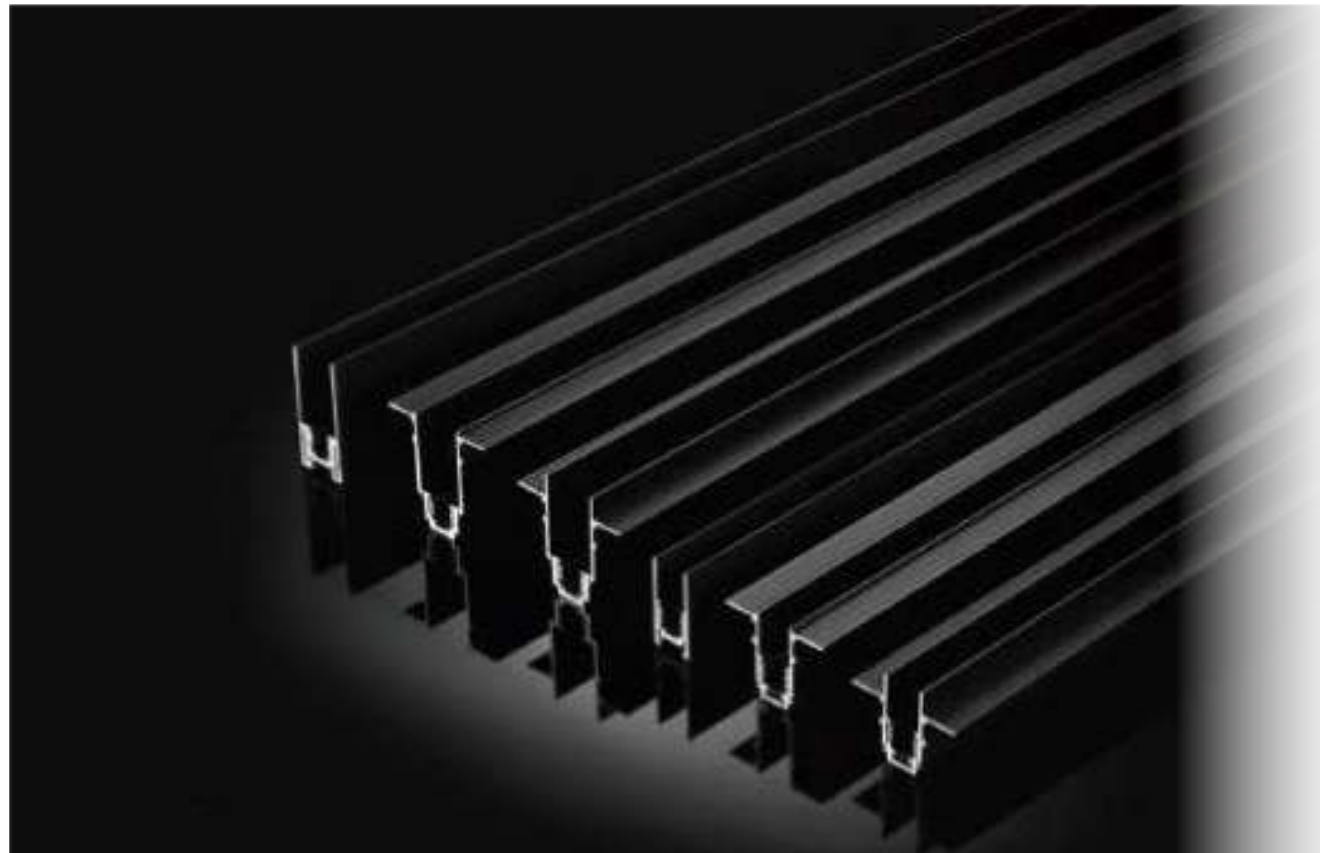

**NEW**  
 PRODUCT

# MAGNETIC TRACK SERIES

Magnetic force connects profile and modules both mechanical and electrical.



Magnetic

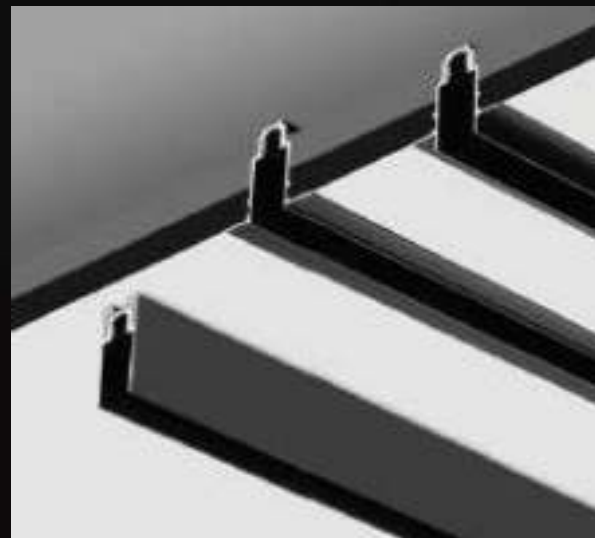

IP20

**TRACK SYSTEM 3 PHASES R35**

- SKU: 5350 BLACK BODY - 1m
- SKU: 5351 BLACK BODY - 1.5m
- SKU: 5352 BLACK BODY - 2m

 ANGLE CONNECTOR  
 SKU: 5358

 END CAP  
 SKU: 5353

Magnetic

**TRACK SYSTEM 3 PHASES R35 Build-in**

- SKU: 5360 BLACK BODY - 1m
- SKU: 5361 BLACK BODY - 1.5m
- SKU: 5362 BLACK BODY - 2m

 ANGLE CONNECTOR  
 SKU: 5363

 END CAP  
 SKU: 5411

Magnetic

**TRACK SYSTEM 3 PHASES R35B-Build-in**

- SKU: 5420 BLACK BODY - 1m
- SKU: 5421 BLACK BODY - 1.5m
- SKU: 5422 BLACK BODY - 2m

 ANGLE CONNECTOR  
 SKU: 5423

 END CAP  
 SKU: 5411

Magnetic

**TRACK SYSTEM 3 PHASES S20**

- SKU: 5364 BLACK BODY - 1m
- SKU: 5365 BLACK BODY - 1.5m
- SKU: 5366 BLACK BODY - 2m

 ANGLE CONNECTOR  
 SKU: 5412

 END CAP  
 SKU: 5413

Magnetic

**TRACK SYSTEM 3 PHASES R20 Build-In**

- SKU: 5367 BLACK BODY - 1m
- SKU: 5368 BLACK BODY - 1.5m
- SKU: 5369 BLACK BODY - 2m

 ANGLE CONNECTOR  
 SKU: 5414

 END CAP  
 SKU: 5415

Magnetic

**TRACK SYSTEM 3 PHASES R20B-Build-in**

- SKU: 5450 BLACK BODY - 1m
- SKU: 5451 BLACK BODY - 1.5m
- SKU: 5452 BLACK BODY - 2m

 ANGLE CONNECTOR  
 SKU: 5453

 END CAP  
 SKU: 5415

Magnetic



LED Magnetic Track Light  
**12W ; 20W**

Product code	LN12-A4 ; LN20-A4	CRI	Ra>80
Power	12W ; 20W	IP Rating	IP20
Beam Angle	120°	Dimension 12W	300x34x50mm
Voltage	DC:48V	Dimension 20W	600x34x50mm

**M35** TRACK

- SKU: 5340 12W 30cm ■ 3000K
- SKU: 5391 12W 30cm ■ 4000K
- SKU: 5341 20W 60cm ■ 3000K
- SKU: 5392 20W 60cm ■ 4000K



LED Magnetic Track Light  
**10W ; 20W**

Product code	LN10-A4 ; LN20-A4	CRI	Ra>80
Power	10W ; 20W	IP Rating	IP20
Beam Angle	24°	Dimension 10W	135x34x95mm
Voltage	DC:48V	Dimension 20W	270x34x95mm

**M35** TRACK

- SKU: 5347 10W 13.5cm ■ 3000K
- SKU: 5398 10W 13.5cm ■ 4000K
- SKU: 5348 20W 27cm ■ 3000K
- SKU: 5399 20W 27cm ■ 4000K



LED Magnetic Track Light  
**10W ; 20W**

Product code	LN10-A4 ; LN20-A4	CRI	Ra>80
Power	10W ; 20W	IP Rating	IP20
Beam Angle	24°	Dimension 10W	135x34x50mm
Voltage	DC:48V	Dimension 18W	270x34x50mm

**M35** TRACK

- SKU: 5342 10W 13.5cm ■ 3000K
- SKU: 5393 10W 13.5cm ■ 4000K
- SKU: 5343 20W 27cm ■ 3000K
- SKU: 5394 20W 27cm ■ 4000K



LED Magnetic Track Light  
**7W Focusing Spot Light**

Product code	LN7-A4	Beam Angle	15-60°
Watts	7W	CRI	Ra>90
Input Voltage	48V	IP Rating	IP20
Flux	560lm	Dimension	Φ60x200mm

**M35** TRACK

- SKU: 5349 Warm White ■ 3000K
- SKU: 5400 Neutral White ■ 4000K



LED Magnetic Track Light  
**7W**



Product code LN7-A4  
Watts 7W  
Input Voltage 48V  
Flux 560lm  
Beam Angle 15°

SKU: 5395    SKU: 5344  
4000K    3000K

CRI Ra>90  
IP Rating IP20  
Dimension  $\phi 55 \times 105 \text{mm}$   
Body Color Black



Power Supplies for Track Light  
**BUILT-IN 48V Output**



SKU: 5424 100W - 48V  
SKU: 5425 200W - 48V  
SKU: 5426 100W - 48V  
SKU: 5427 200W - 48V  
SKU: 5428 280W - 48V

Watts	100W	200W	100W	200W	280W
Input Voltage	220V	220V	220V	220V	220V
Output Voltage	DC: 48V	DC: 48V	DC: 48V	DC: 48V	DC: 48V
Current	2.1A	4.2A	2.1A	4.2A	5.85A
Material	PC	PC	PC	PC	PC
IP Rating	IP20	IP20	IP20	IP20	IP20
Dimension	190x90x30mm	220x120x30mm	220x120x30mm	220x120x30mm	220x120x30mm

Magnetic Track Light	M20	M20	M35	M35	M35
	TRACK	TRACK	TRACK	TRACK	TRACK

LED Magnetic Track Light  
**12W**



Product code LN12-A4  
Watts 12W  
Input Voltage 48V  
Flux 960lm  
Beam Angle 15°

SKU: 5396    SKU: 5345  
4000K    3000K

CRI Ra>90  
IP Rating IP20  
Dimension  $\phi 65 \times 130 \text{mm}$   
Body Color Black



LED Magnetic Track Light  
**20W**



Product code LN20-A4  
Watts 20W  
Input Voltage 48V  
Flux 1600lm  
Beam Angle 15°

SKU: 5397    SKU: 5346  
4000K    3000K

CRI Ra>90  
IP Rating IP20  
Dimension  $\phi 65 \times 130 \text{mm}$   
Body Color Black







800  
Lumens



1440  
Lumens

**LED Magnetic Track Light - M20**  
**10W ; 18W**

**M20**  
TRACK  
Magnetic  
IP20

Product code	LN10-A4 ; LN18-A4	CRI	Ra>80
Power	10W ;18W	IP Rating	IP20
Beam Angle	120°	Dimension 10W	300x22x25mm
Voltage	DC:48V	Dimension 18W	600x22x25mm

SKU: 5417	10W 30cm	3000K
SKU: 5416	10W 30cm	4000K
SKU: 5419	18W 60cm	3000K
SKU: 5418	18W 60cm	4000K



CRI  
90+

**LED Magnetic Track Light**  
**12W**

**M20**  
TRACK  
Magnetic  
IP20

Watts	12W	CRI	Ra>90
Input Voltage	DC48V	IP Rating	IP20
Flux	960lm	Dimension	Φ65x130mm
Beam Angle	15°	Body Color	Black

SKU: 5316	Warm White	3000K
SKU: 5315	Neutral White	4000K



CRI  
90+

**LED Magnetic Track Light**  
**10W**

**M20**  
TRACK  
Magnetic  
IP20

Watts	10W	CRI	Ra>90
Input Voltage	DC48V	IP Rating	IP20
Flux	800lm	Dimension	Φ70x100mm
Beam Angle	15-24°	Body Color	Black

SKU: 5379	Warm White	3000K
SKU: 5378	Neutral White	4000K



480  
Lumens



960  
Lumens

**LED Magnetic Track Light - M20**  
**6W ; 12W**

**M20**  
TRACK  
Magnetic  
IP20

Product code	LN6-A4 ; LN12-A4	CRI	Ra>80
Power	6W ;12W	IP Rating	IP20
Beam Angle	24°	Dimension 10W	112x22x45mm
Voltage	DC:48V	Dimension 18W	220x22x45mm

SKU: 5312	6W	3000K
SKU: 5311	6W	4000K
SKU: 5314	12W	3000K
SKU: 5313	12W	4000K



**Straight Joint**

SKU: 5356



**Joining Cable**

SKU: 5357



**Input Cable**

SKU: 5355



**Hanging Accessories**

SKU: 5354

**LED Magnetic Track Light  
9W**
  
720  
Lumens

**M20**  
TRACK

  
45°

  
Magnetic

  
IP20

Product code LN9-A4  
 Power 9W  
 Beam Angle 24°  
 Voltage DC:48V

CRI Ra>80  
 IP Rating IP20  
 Dimension 137x34x95mm

SKU: 5318 Warm White 3000K  
 SKU: 5317 Neutral White 4000K

**LED Magnetic Track Light  
5W**
  
560  
Lumens

**M20**  
TRACK

  
Magnetic

  
IP20

Product code LN5-A4  
 Power 5W  
 Beam Angle 15-60°  
 Voltage DC:48V

CRI Ra>80  
 IP Rating IP20  
 Dimension  $\phi 60 \times 200$ mm

SKU: 5319 Warm White 3000K  
 SKU: 5320 Neutral White 4000K

**LED Magnetic Track Light  
6W**
  
480  
Lumens

  
Magnetic

  
IP20

Product code LN6-A5  
 Watts 6W  
 Input Voltage DC48V  
 Flux 480lm  
 Beam Angle 90°

CRI Ra>80  
 IP Rating IP20  
 Dimension  $\phi 130$ mm  
 Body Color Black

SKU: 5335 Neutral White 4000K  
 SKU: 5334 Warm White 3000K

**M20**  
**M35**  
TRACK

**LED Magnetic Track Light  
10W**
  
800  
Lumens

  
Magnetic

  
IP20

Product code LN10-A5  
 Watts 10W  
 Input Voltage DC48V  
 Flux 800lm  
 Beam Angle 90°

CRI Ra>80  
 IP Rating IP20  
 Dimension  $\phi 85$ mm  
 Body Color Black

SKU: 5337 Neutral White 4000K  
 SKU: 5336 Warm White 3000K

**M20**  
**M35**  
TRACK

**LED Magnetic Track Light  
5W**
  
400  
Lumens

  
Magnetic

  
IP20

Product code LN5-A5  
 Watts 5W  
 Input Voltage DC48V  
 Flux 400lm  
 Beam Angle 50°

CRI Ra>80  
 IP Rating IP20  
 Dimension 88x75mm  
 Body Color Black

SKU: 5339 Neutral White 4000K  
 SKU: 5338 Warm White 3000K

**M20**  
**M35**  
TRACK



TRACK SYSTEM Three-Phase

**WHITE**

**Length: 1.0m ; 1.5m ; 2.0m**

**S35**

- SKU: 5241 WHITE BODY - 1m
- SKU: 5242 WHITE BODY - 1.5m
- SKU: 5243 WHITE BODY - 2m

**R35 Build-in**

- SKU: 5250 WHITE BODY - 1m
- SKU: 5251 WHITE BODY - 1.5m
- SKU: 5252 WHITE BODY - 2m

**R35B Build-in**

- SKU: 5255 WHITE BODY - 1m
- SKU: 5256 WHITE BODY - 1.5m
- SKU: 5257 WHITE BODY - 2m



**Accessories:**



**INPUT CABLE**  
SKU: 5246



**STRAIGHT JOINT**  
SKU: 5247



**JOINING CABLE**  
SKU: 5248



**COVER PLATE**  
SKU: 5254



**S35 SURFACE CORNER**  
SKU: 5249



**R35 SURFACE CORNER**  
SKU: 5253



**R35-B SURFACE CORNER**  
SKU: 5258



**R35-A Concave Angle**  
SKU: 5259



SLIM POWER SUPPLY 48V  
**100W 2.08A**

**M35**  
TRACK



Watts	100W	Current	2.08A
Input Voltage	220V	Material	Metal
Output Voltage	DC: 48V	IP Rating	IP20

SKU: 5216 WHITE BODY

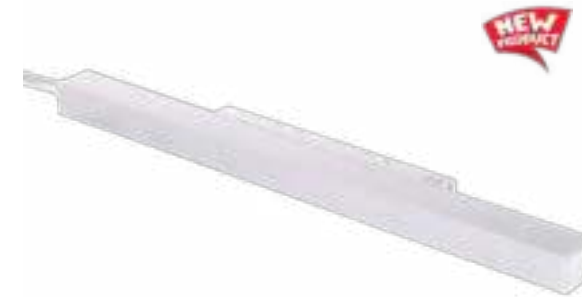

SLIM POWER SUPPLY 48V  
**200W 4.16A**

**M35**  
TRACK



Watts	200W	Current	4.16A
Input Voltage	220V	Material	Metal
Output Voltage	DC: 48V	IP Rating	IP20

SKU: 5217 WHITE BODY





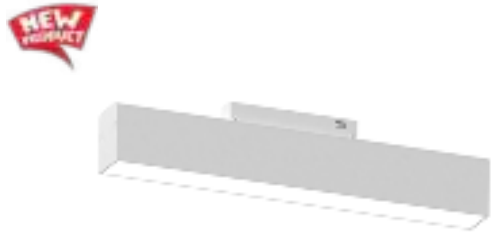

**LED Magnetic Track Light  
12W**

Watts 12W  
 Input Voltage DC48V  
 Flux 960lm  
 Beam Angle 120°

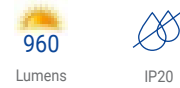
SKU: 5265    SKU: 5261  
 ■ 4000K    ■ 3000K



CRI Ra>90  
 IP Rating IP20  
 Dimension 300x34x50.5mm  
 Body Color White

**LED Magnetic Track Light  
20W**

Watts 20W  
 Input Voltage DC48V  
 Flux 1600lm  
 Beam Angle 120°

SKU: 5266    SKU: 5262  
 ■ 4000K    ■ 3000K



CRI Ra>90  
 IP Rating IP20  
 Dimension 600x34x50.5mm  
 Body Color White

**LED Magnetic Track Light  
10W**

Watts 10W  
 Input Voltage DC48V  
 Flux 800lm  
 Beam Angle 90°

SKU: 5268    SKU: 5267  
 ■ 4000K    ■ 3000K

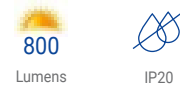

CRI Ra>90  
 IP Rating IP20  
 Dimension 134x34x50.5mm  
 Body Color White

**LED Magnetic Track Light  
20W**

Watts 20W  
 Input Voltage DC48V  
 Flux 1600lm  
 Beam Angle 120°

SKU: 5270    SKU: 5269  
 ■ 4000K    ■ 3000K

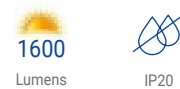

CRI Ra>90  
 IP Rating IP20  
 Dimension 270x34x50.5mm  
 Body Color White

**LED Magnetic Track Light  
12W**

Watts 12W  
 Input Voltage DC48V  
 Flux 960lm  
 Beam Angle 90°

SKU: 5271    SKU: 5263  
 ■ 4000K    ■ 3000K



CRI Ra>90  
 IP Rating IP20  
 Dimension Φ65x130  
 Body Color White

**LED Magnetic Track Light  
20W**

Watts 20W  
 Input Voltage DC48V  
 Flux 1600lm  
 Beam Angle 90°

SKU: 5272    SKU: 5264  
 ■ 4000K    ■ 3000K



CRI Ra>90  
 IP Rating IP20  
 Dimension Φ65x130  
 Body Color White

**LED Magnetic Track Light  
10W**

Watts 10W  
 Input Voltage DC48V  
 Flux 800lm  
 Beam Angle 24°

SKU: 5273  
 ■ 3000K



CRI Ra>90  
 IP Rating IP20  
 Dimension 137x34x95  
 Body Color White





TRACK SYSTEM Three-Phase

**BLACK**

**Length: 1.0m ; 1.5m ; 2.0m**

**S15**

- SKU: 5207 BLACK BODY - 1m
- SKU: 5208 BLACK BODY - 1.5m
- SKU: 5209 BLACK BODY - 2m

**R15 Build-in**

- SKU: 5204 BLACK BODY - 1m
- SKU: 5205 BLACK BODY - 1.5m
- SKU: 5206 BLACK BODY - 2m

**R15B Build-in**

- SKU: 5201 BLACK BODY - 1m
- SKU: 5202 BLACK BODY - 1.5m
- SKU: 5203 BLACK BODY - 2m



**ACCESSORIES:**



**POWER CONNECTOR**  
SKU: 5211



**STRAIGHT CONNECTOR**  
SKU: 5212



**ADJUSTABLE CONNECTOR**  
SKU: 5213

**SLIM POWER SUPPLY 48V - BLACK**



SKU: 5214  
80W 1.66A



SKU: 5215  
150W 3.12A

Watts	80W	Current	1.66A
Input Voltage	220V	Material	Metal
Output Voltage	DC: 48V	IP Rating	IP20

Watts	150W	Current	3.12A
Input Voltage	220V	Material	Metal
Output Voltage	DC: 48V	IP Rating	IP20



LED Magnetic Track Light  
**6W ; 10W**

**M15**  
TRACK



Watts	6W ; 10W	CRI	Ra>90
Input Voltage	DC48V	IP Rating	IP20
Flux	480 ; 800lm	Dimension	φ35x70 mm
Beam Angle	90°	Body Color	Black

480 Lumens	6W	SKU: 5221	SKU: 5222
		4000K	3000K

800 Lumens	10W	SKU: 5223	SKU: 5224
		4000K	3000K



LED Magnetic Track Light  
**10W ; 20W**

**M15**  
TRACK



Watts	10W ; 20W	CRI	Ra>90
Input Voltage	DC48V	IP Rating	IP20
Flux	650 ; 1300lm	Dimension 10W	300x15x18mm
Beam Angle	120°	Dimension 20W	600x15x18mm

650 Lumens	10W	SKU: 5225	SKU: 5226
		4000K	3000K

1300 Lumens	20W	SKU: 5227	SKU: 5228
		4000K	3000K



LED Magnetic Track Light  
**12W**

**M15**  
TRACK



Watts	12W	CRI	Ra>90
Input Voltage	DC48V	IP Rating	IP20
Flux	780lm	Dimension	232x15x18mm
Beam Angle	24°	Body Color	Black

780 Lumens	12W	SKU: 5229	SKU: 5230
		4000K	3000K



MINI MAGNETIC TRACK SYSTEM

**BLACK - 30mm**

**Length: 1.0m ; 1.5m ; 2.0m**

**MM30**

- SKU: 5480 BLACK BODY - 1m
- SKU: 5481 BLACK BODY - 1.5m
- SKU: 5482 BLACK BODY - 2m



**ACCESSORIES:**

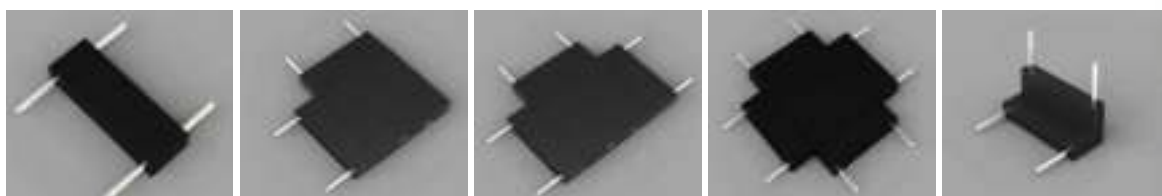

SKU: 5483

SKU: 5484

SKU: 5485

SKU: 5486

SKU: 5487



**SLIM POWER SUPPLY 48V**



**SKU: 5488 100W 2.08A**

Watts	100W	Current	2.08A
Input Voltage	220V	Material	Aluminium
Output Voltage	DC: 48V	IP Rating	IP20

**SKU: 5489 200W 2.08A**

Watts	200W	Current	4.16A
Input Voltage	220V	Material	Aluminium
Output Voltage	DC: 48V	IP Rating	IP20







**LED Mini Magnetic Track Light  
6W**

**720**  
Lumens

**IP20**

Watts	6W	CRI	Ra>90
Input Voltage	DC48V	IP Rating	IP20
Flux	720lm	Dimension	φ54x63x98mm
Beam Angle	32°	Body Color	Black

SKU: 5494    SKU: 5495  
■ 4000K    ■ 3000K



**MM30**  
TRACK



**LED Mini Magnetic Track Light  
5W**

**425**  
Lumens

**IP20**

Watts	5W	CRI	Ra>90
Input Voltage	DC48V	IP Rating	IP20
Flux	425lm	Dimension	48x35x60mm
Beam Angle	38°	Body Color	Black

SKU: 5496    SKU: 5497  
■ 4000K    ■ 3000K



**MM30**  
TRACK



**LED Mini Magnetic Track Light  
4W**

**240**  
Lumens

**IP20**

Watts	4W	CRI	Ra>90
Input Voltage	DC48V	IP Rating	IP20
Flux	240lm	Dimension	48x35x60mm
Beam Angle	80°	Body Color	Black

SKU: 5498    SKU: 5499  
■ 4000K    ■ 3000K



**MM30**  
TRACK



**LED Mini Magnetic Track Light  
12W**

**400**  
Lumens

**IP20**

Watts	12W	CRI	Ra>90
Input Voltage	DC48V	IP Rating	IP20
Flux	400lm	Dimension	300x32x11mm
Beam Angle	110°	Body Color	Black

SKU: 5490    SKU: 5491  
■ 4000K    ■ 3000K



**MM30**  
TRACK



**LED Mini Magnetic Track Light  
10W**

**520**  
Lumens

**IP20**

Watts	10W	CRI	Ra>90
Input Voltage	DC48V	IP Rating	IP20
Flux	520lm	Dimension	240x32x11mm
Beam Angle	25°	Body Color	Black

SKU: 5492    SKU: 5493  
■ 4000K    ■ 3000K



**MM30**  
TRACK





LED Floodlights are commonly used for outdoor lighting large areas. Applicable for villas and country houses, LED floodlights are number one choice for gardens and large open spaces.

Features:

- Up to 80% power saving
- High power and IP65 rating
- Large beam angles for single product lighting
- Wall or pylon mountable
- Tough and reliable
- Options with solar panels

Application:

- Outdoor lighting
- Large area coverage
- Houses or warehouse usage

**LED FLOODLIGHTS**

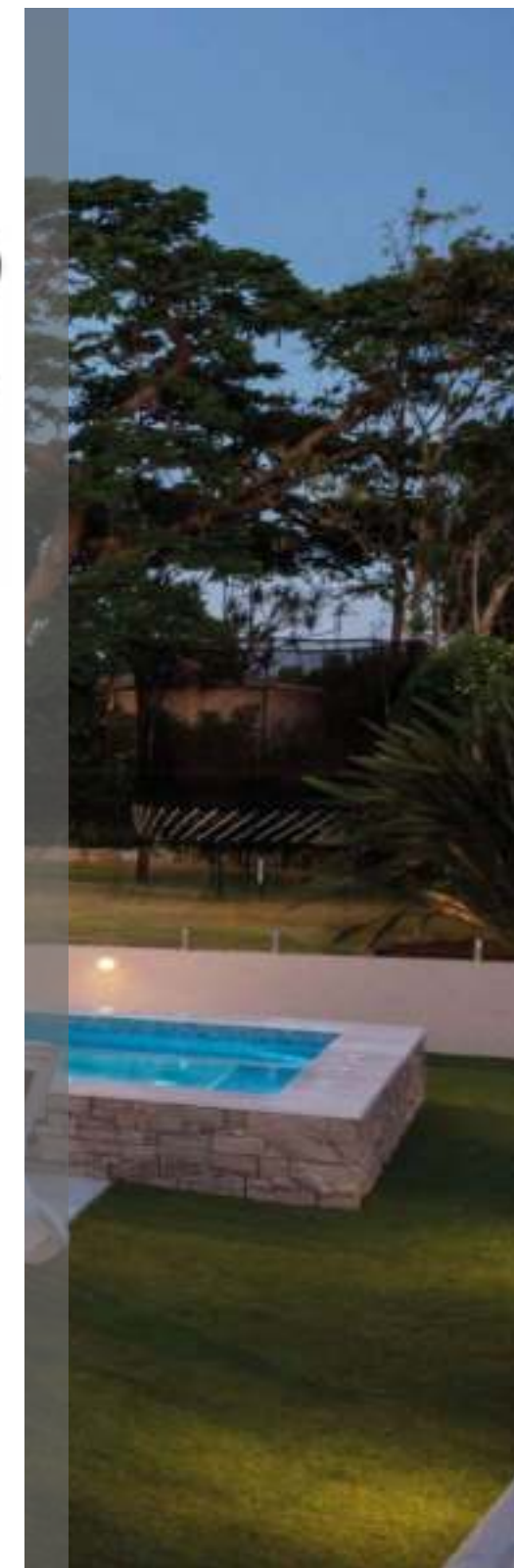

**LED FLOODLIGHTS**





LED CCT SOLAR FLOODLIGHT  
**Solar Panel Power:5V/10W**

1000 Lumens 120° IP65

EQ.Watts	10W	Beam Angle	120°
Battery	3.2V / 10Ah	CRI	Ra>80
Flux	1000lm	IP Rating	IP65

SKU: 5473  
CCT  
6000K 4500K 3000K

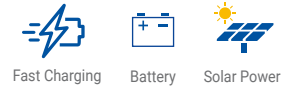

LED CCT SOLAR FLOODLIGHT  
**Solar Panel Power:5V/20W**

1800 Lumens 120° IP65

EQ.Watts	10W	Beam Angle	120°
Battery	3.2V / 20Ah	CRI	Ra>80
Flux	1800lm	IP Rating	IP65

SKU: 5474  
CCT  
6000K 4500K 3000K

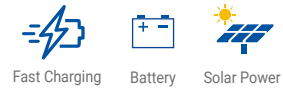

LED CCT SOLAR FLOODLIGHT  
**Solar Panel Power:5V/30W**

2700 Lumens 120° IP65

EQ.Watts	30W	Beam Angle	120°
Battery	3.2V / 30Ah	CRI	Ra>80
Flux	2700lm	IP Rating	IP65

SKU: 5475  
CCT  
6000K 4500K 3000K

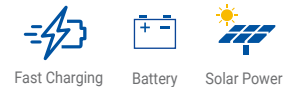

LED SMD SOLAR FLOODLIGHT  
**Solar Panel Power:6V/30W**

3000 Lumens 120° IP65

EQ.Watts	30W	Beam Angle	120°
Battery	3.2V / 30Ah	CRI	Ra>80
Flux	3000lm	IP Rating	IP65

SKU: 5468  
6000K



LED SMD SOLAR FLOODLIGHT  
**Solar Panel Power:6V/8W**

500 Lumens 120° IP65

EQ.Watts	16W	Beam Angle	120°
Battery	3.2V / 5Ah	CRI	Ra>80
Flux	500lm	IP Rating	IP65

SKU: 5430  
6000K

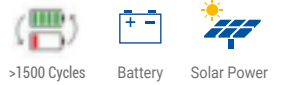

LED SMD SOLAR FLOODLIGHT  
**Solar Panel Power:6V/16W**

1200 Lumens 120° IP65

EQ.Watts	16W	Beam Angle	120°
Battery	3.2V / 10Ah	CRI	Ra>80
Flux	1200lm	IP Rating	IP65

SKU: 5431  
6000K



LED SMD SOLAR FLOODLIGHT  
**Solar Panel Power:6V/20W**

1600 Lumens 120° IP65

EQ.Watts	20W	Beam Angle	120°
Battery	3.2V / 15Ah	CRI	Ra>80
Flux	1600lm	IP Rating	IP65

SKU: 5432  
6000K



LED SMD SOLAR FLOODLIGHT  
**Solar Panel Power:6V/25W**

2200 Lumens 120° IP65

EQ.Watts	25W	Beam Angle	120°
Battery	3.2V / 20Ah	CRI	Ra>80
Flux	2200lm	IP Rating	IP65

SKU: 5433  
6000K







**LED SOLAR POWER FLOOD LIGHT PF>0.9 with Solar Panel and Remote**



**6W** EQ.Watts **800** Lumens  
Solar Panel Flux 6W/5V 800lm  
IP Rating IP65  
Body Color Black  
**3.2V 6Ah**  
SKU: 5291 **6000K**

**10W** EQ.Watts **1200** Lumens  
Solar Panel Flux 10W/5V 1200lm  
IP Rating IP65  
Body Color Black  
**3.2V 10Ah**  
SKU: 5292 **6000K**

**15W** EQ.Watts **2000** Lumens  
Solar Panel Flux 15W/5V 2000lm  
IP Rating IP65  
Body Color Black  
**3.2V 15Ah**  
SKU: 5293 **6000K**

**20W** EQ.Watts **2600** Lumens  
Solar Panel Flux 20W/5V 2600lm  
IP Rating IP65  
Body Color Black  
**3.2V 20Ah**  
SKU: 5294 **6000K**

**25W** EQ.Watts **3200** Lumens  
Solar Panel Flux 25W/5V 3200lm  
IP Rating IP65  
Body Color Black  
**3.2V 25Ah**  
SKU: 5295 **6000K**

**30W** EQ.Watts **3800** Lumens  
Solar Panel Flux 30W/5V 3800lm  
IP Rating IP65  
Body Color Black  
**3.2V 30Ah**  
SKU: 5296 **6000K**

**40W** EQ.Watts **4800** Lumens  
Solar Panel Flux 40W/5V 4800lm  
IP Rating IP65  
Body Color Black  
**3.2V 40Ah**  
SKU: 5297 **6000K**



**LED SMD FLOODLIGHT PF>0.9 with Solar Panels and Remote Control**



**900** Lumens  
Product code FL12-A6  
EQ.Watts 50W  
Battery 3.2V / 11Ah  
Flux 900lm  
Beam Angle 120°  
CRI Ra>80  
IP Rating IP65  
Body Color Black  
171 mm  
211x67 mm  
SKU: 5465 **6000K**

**2500** Lumens  
Product code FL35-A6  
EQ.Watts 100W  
Battery 6.4V / 16.5Ah  
Flux 2500lm  
Beam Angle 120°  
CRI Ra>80  
IP Rating IP65  
Body Color Black  
268 mm  
237x67 mm  
SKU: 5466 **6000K**

**3200** Lumens  
Product code FL40-A6  
EQ.Watts 150W  
Battery 6.4V / 22Ah  
Flux 3200lm  
Beam Angle 120°  
CRI Ra>80  
IP Rating IP65  
Body Color Black  
311 mm  
381x67 mm  
SKU: 5467 **6000K**



**LED SMD FLOODLIGHT PF>0.9**  
**With Solar Panels and Remote Control**



**800**  
Lumens

Product code	FL25-A6	Beam Angle	120°
EQ.Watts	12W	CRI	Ra>80
Battery	3.2V / 5.5Ah	IP Rating	IP65
Flux	800lm	Body Color	Black

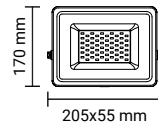

SKU: 5460  
6000K

**1300**  
Lumens

Product code	FL40-A6	Beam Angle	120°
EQ.Watts	40W	CRI	Ra>80
Battery	3.2V / 11Ah	IP Rating	IP65
Flux	1300lm	Body Color	Black

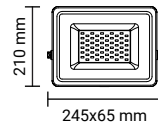

SKU: 5461  
6000K

**1800**  
Lumens

Product code	FL60-B2	Beam Angle	120°
EQ.Watts	20W	CRI	Ra>80
Battery	6.4V / 11Ah	IP Rating	IP65
Flux	1800lm	Body Color	Black

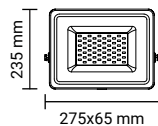

SKU: 5462  
6000K

**2500**  
Lumens

Product code	FL100-B2	Beam Angle	120°
EQ.Watts	35W	CRI	Ra>80
Battery	6.4V / 16.5Ah	IP Rating	IP65
Flux	2500lm	Body Color	Black

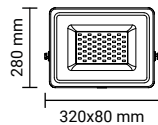

SKU: 5463  
6000K



**LED SMD FLOODLIGHT PF>0.9**  
**With Solar Panels and Remote Control**



**400**  
Lumens

Product code	FL6-B5	Beam Angle	90°
EQ.Watts	6W	CRI	Ra>80
Battery	3.2V / 5Ah	IP Rating	IP65
Flux	400lm	Body Color	Grey

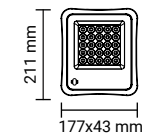

SKU: 5455  
6000K

**500**  
Lumens

Product code	FL8-B5	Beam Angle	90°
EQ.Watts	8W	CRI	Ra>80
Battery	3.2V / 6Ah	IP Rating	IP65
Flux	500lm	Body Color	Grey

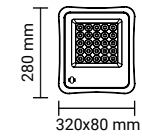

SKU: 5456  
6000K

**1200**  
Lumens

Product code	FL15-B5	Beam Angle	90°
EQ.Watts	15W	CRI	Ra>80
Battery	3.2V / 10Ah	IP Rating	IP65
Flux	1200lm	Body Color	Grey

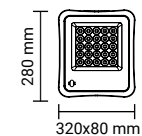

SKU: 5457  
6000K

**1800**  
Lumens

Product code	FL20-B5	Beam Angle	90°
EQ.Watts	20W	CRI	Ra>80
Battery	3.2V / 20Ah	IP Rating	IP65
Flux	1800lm	Body Color	Grey

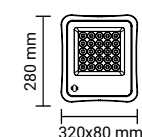

SKU: 5458  
6000K

**2400**  
Lumens

Product code	FL30-B5	Beam Angle	90°
EQ.Watts	30W	CRI	Ra>80
Battery	3.2V / 25Ah	IP Rating	IP65
Flux	2400lm	Body Color	Grey

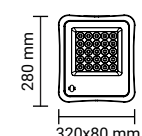

SKU: 5459  
6000K

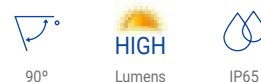

## LED SMD FLOODLIGHT

## White Body

**10W**900  
Lumens

Product code	FL10-B3	Beam Angle	90°
Watts	10W	CRI	Ra>80
Input Voltage	AC : 220-240V	IP Rating	IP65
Flux	900lm	Body Color	White

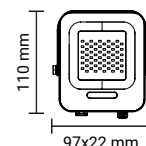
 SKU: 5701   SKU: 5702   SKU: 5703  
**20W**1800  
Lumens

Product code	FL20-B3	Beam Angle	90°
Watts	20W	CRI	Ra>80
Input Voltage	AC : 220-240V	IP Rating	IP65
Flux	1800lm	Body Color	White

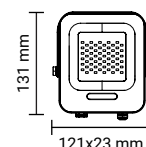
 SKU: 5704   SKU: 5705   SKU: 5706  
**30W**2700  
Lumens

Product code	FL30-B3	Beam Angle	90°
Watts	30W	CRI	Ra>80
Input Voltage	AC : 220-240V	IP Rating	IP65
Flux	2700lm	Body Color	White

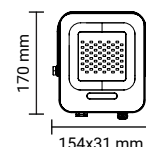
 SKU: 5707   SKU: 5708   SKU: 5709  
**50W**4500  
Lumens

Product code	FL50-B3	Beam Angle	90°
Watts	50W	CRI	Ra>80
Input Voltage	AC : 220-240V	IP Rating	IP65
Flux	4500lm	Body Color	White

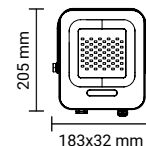
 SKU: 5710   SKU: 5711   SKU: 5712  
**100W**9000  
Lumens

Product code	FL100-B3	Beam Angle	90°
Watts	100W	CRI	Ra>80
Input Voltage	AC : 220-240V	IP Rating	IP65
Flux	9000lm	Body Color	White

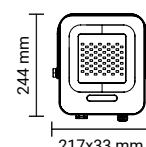
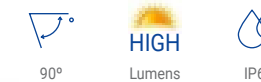

 SKU: 5713   SKU: 5714   SKU: 5715  

## LED SMD FLOODLIGHT

## Black Body

**10W**900  
Lumens

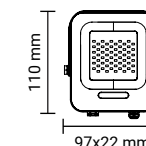
Product code	FL10-B3	Beam Angle	90°
Watts	10W	CRI	Ra>80
Input Voltage	AC : 220-240V	IP Rating	IP65
Flux	900lm	Body Color	Black

 SKU: 5721   SKU: 5722   SKU: 5723  
**20W**1800  
Lumens

Product code	FL20-B3	Beam Angle	90°
Watts	20W	CRI	Ra>80
Input Voltage	AC : 220-240V	IP Rating	IP65
Flux	1800lm	Body Color	Black

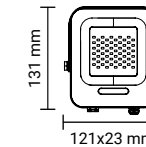
 SKU: 5724   SKU: 5725   SKU: 5726  
**30W**2700  
Lumens

Product code	FL30-B3	Beam Angle	90°
Watts	30W	CRI	Ra>80
Input Voltage	AC : 220-240V	IP Rating	IP65
Flux	2700lm	Body Color	Black

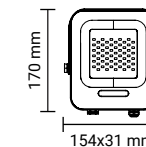
 SKU: 5727   SKU: 5728   SKU: 5729  
**50W**4500  
Lumens

Product code	FL50-B3	Beam Angle	90°
Watts	50W	CRI	Ra>80
Input Voltage	AC : 220-240V	IP Rating	IP65
Flux	4500lm	Body Color	Black

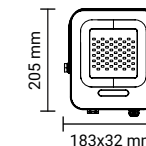
 SKU: 5730   SKU: 5731   SKU: 5732  
**100W**9000  
Lumens

Product code	FL100-B3	Beam Angle	90°
Watts	100W	CRI	Ra>80
Input Voltage	AC : 220-240V	IP Rating	IP65
Flux	9000lm	Body Color	Black

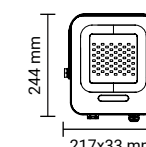
 SKU: 5733   SKU: 5734   SKU: 5735



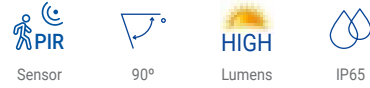

LED SMD FLOODLIGHT

**White Body - PIR Sensor**

<b>10W</b>  900 Lumens	Product code	FL10-B3	Beam Angle	90°
	Watts	10W	CRI	Ra>80
	Input Voltage	AC : 220-240V	IP Rating	IP65
	Flux	900lm	Body Color	White

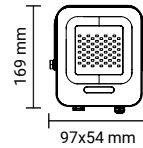

SKU: 5760	SKU: 5761	SKU: 5762

<b>20W</b>  1800 Lumens	Product code	FL20-B3	Beam Angle	90°
	Watts	20W	CRI	Ra>80
	Input Voltage	AC : 220-240V	IP Rating	IP65
	Flux	1800lm	Body Color	White

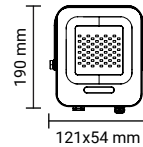

SKU: 5763	SKU: 5764	SKU: 5765

<b>30W</b>  2700 Lumens	Product code	FL30-B3	Beam Angle	90°
	Watts	30W	CRI	Ra>80
	Input Voltage	AC : 220-240V	IP Rating	IP65
	Flux	2700lm	Body Color	White

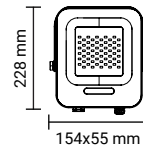

SKU: 5766	SKU: 5767	SKU: 5768

<b>50W</b>  4500 Lumens	Product code	FL50-B3	Beam Angle	90°
	Watts	50W	CRI	Ra>80
	Input Voltage	AC : 220-240V	IP Rating	IP65
	Flux	4500lm	Body Color	White

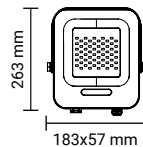

SKU: 5769	SKU: 5770

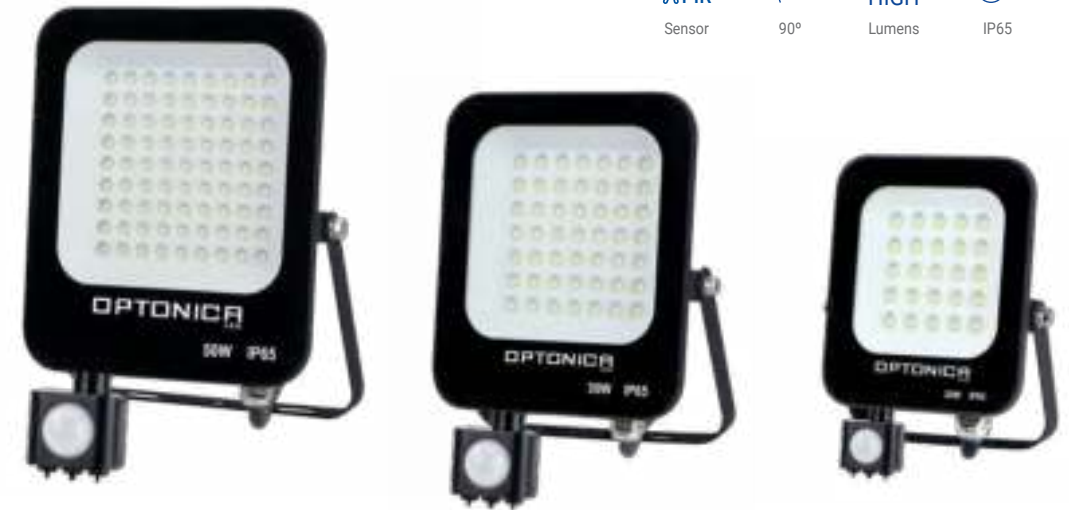
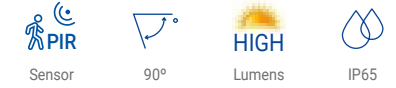

LED SMD FLOODLIGHT

**Black Body - PIR Sensor**

<b>10W</b>  900 Lumens	Product code	FL10-B3	Beam Angle	90°
	Watts	10W	CRI	Ra>80
	Input Voltage	AC : 220-240V	IP Rating	IP65
	Flux	900lm	Body Color	Black

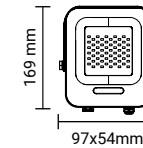

SKU: 5771	SKU: 5772	SKU: 5773

<b>20W</b>  1800 Lumens	Product code	FL20-B3	Beam Angle	90°
	Watts	20W	CRI	Ra>80
	Input Voltage	AC : 220-240V	IP Rating	IP65
	Flux	1800lm	Body Color	Black

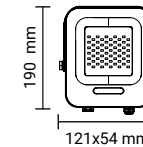

SKU: 5774	SKU: 5775	SKU: 5776

<b>30W</b>  2700 Lumens	Product code	FL30-B3	Beam Angle	90°
	Watts	30W	CRI	Ra>80
	Input Voltage	AC : 220-240V	IP Rating	IP65
	Flux	2700lm	Body Color	Black

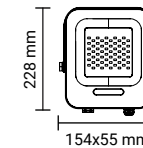

SKU: 5777	SKU: 5778	SKU: 5779

<b>50W</b>  4500 Lumens	Product code	FL50-B3	Beam Angle	90°
	Watts	50W	CRI	Ra>80
	Input Voltage	AC : 220-240V	IP Rating	IP65
	Flux	4500lm	Body Color	Black

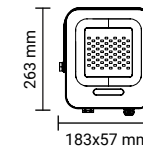

SKU: 5780	SKU: 5781



LED SMD FLOODLIGHT **PF>0.9**  
**High Power - Grey Body**

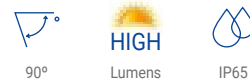

<b>100W</b>  10000 Lumens	Product code	FL100-B4	Beam Angle	90°
	Watts	100W	CRI	Ra>80
	Input Voltage	AC : 220-240V	IP Rating	IP65
	Flux	10000lm	Body Color	Grey

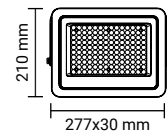

SKU: 5741 (6000K)    SKU: 5742 (4500K)



LED SMD FLOODLIGHT **PF>0.9**  
**High Power - Grey Body**



<b>300W</b>  36000 Lumens	Product code	FL150-A5	Beam Angle	90°
	Watts	300W	CRI	Ra>80
	Input Voltage	AC :220-240V	IP Rating	IP65
	Flux	36000lm	Body Color	Grey

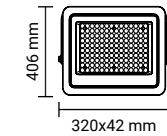

SKU: 5747 (6000K)    SKU: 5748 (4500K)

<b>150W</b>  15000 Lumens	Product code	FL150-B4	Beam Angle	90°
	Watts	150W	CRI	Ra>80
	Input Voltage	AC : 220-240V	IP Rating	IP65
	Flux	15000lm	Body Color	Grey

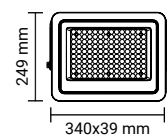

SKU: 5743 (6000K)    SKU: 5744 (4500K)

<b>400W</b>  48000 Lumens	Product code	FL200-A5	Beam Angle	90°
	Watts	400W	CRI	Ra>80
	Input Voltage	AC :220-240V	IP Rating	IP65
	Flux	48000lm	Body Color	Grey

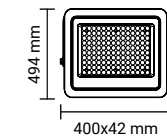

SKU: 5749 (6000K)    SKU: 5750 (4500K)

<b>200W</b>  20000 Lumens	Product code	FL200-B4	Beam Angle	90°
	Watts	200W	CRI	Ra>80
	Input Voltage	AC : 220-240V	IP Rating	IP65
	Flux	20000lm	Body Color	Grey

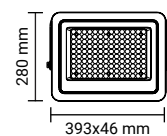

SKU: 5745 (6000K)    SKU: 5746 (4500K)



**5** Years  
Warranty

**HIGH**  
Lumens

IP65



Power Cable Length-0.70m



**LED SMD FLOODLIGHT PF>0.9**  
**Premium Line - White Body**

<b>10W</b>  850 Lumens	Product code	FL10-A5	Beam Angle	150°
	Watts	10W	CRI	Ra>80
	Input Voltage	AC : 175-265V	IP Rating	IP65
	Flux	850lm	Body Color	White

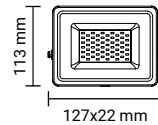

SKU: 5865    SKU: 5866    SKU: 5867  
6000K    4500K    2800K

<b>20W</b>  1700 Lumens	Product code	FL20-A5	Beam Angle	150°
	Watts	20W	CRI	Ra>80
	Input Voltage	AC : 175-265V	IP Rating	IP65
	Flux	1700lm	Body Color	White

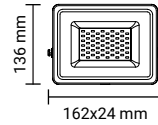

SKU: 5868    SKU: 5869    SKU: 5870  
6000K    4500K    2800K

<b>30W</b>  2550 Lumens	Product code	FL30-A5	Beam Angle	150°
	Watts	30W	CRI	Ra>80
	Input Voltage	AC : 175-265V	IP Rating	IP65
	Flux	2550lm	Body Color	White

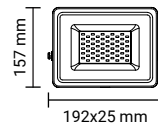

SKU: 5871    SKU: 5872    SKU: 5873  
6000K    4500K    2800K

<b>50W</b>  4250 Lumens	Product code	FL50-A5	Beam Angle	150°
	Watts	50W	CRI	Ra>80
	Input Voltage	AC : 175-265V	IP Rating	IP65
	Flux	4250lm	Body Color	White

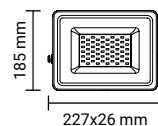

SKU: 5874    SKU: 5875    SKU: 5876  
6000K    4500K    2800K

<b>100W</b>  8500 Lumens	Product code	FL100-A5	Beam Angle	150°
	Watts	100W	CRI	Ra>80
	Input Voltage	AC : 175-265V	IP Rating	IP65
	Flux	8500lm	Body Color	White

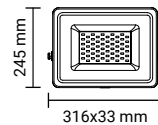

SKU: 5877    SKU: 5878    SKU: 5879  
6000K    4500K    2800K

**5** Years  
Warranty

**HIGH**  
Lumens

IP65



Power Cable Length-0.70m



**LED SMD FLOODLIGHT PF>0.9**  
**Premium Line - Black Body**

<b>10W</b>  850 Lumens	Product code	FL10-A5	Beam Angle	150°
	Watts	10W	CRI	Ra>80
	Input Voltage	AC : 175-265V	IP Rating	IP65
	Flux	850lm	Body Color	Black

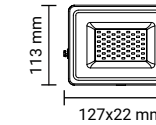

SKU: 5880    SKU: 5881    SKU: 5882  
6000K    4500K    2800K

<b>20W</b>  1700 Lumens	Product code	FL20-A5	Beam Angle	150°
	Watts	20W	CRI	Ra>80
	Input Voltage	AC : 175-265V	IP Rating	IP65
	Flux	1700lm	Body Color	Black

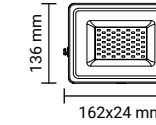

SKU: 5883    SKU: 5884    SKU: 5885  
6000K    4500K    2800K

<b>30W</b>  2550 Lumens	Product code	FL30-A5	Beam Angle	150°
	Watts	30W	CRI	Ra>80
	Input Voltage	AC : 175-265V	IP Rating	IP65
	Flux	2550lm	Body Color	Black

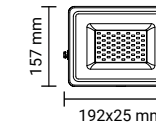

SKU: 5886    SKU: 5887    SKU: 5888  
6000K    4500K    2800K

<b>50W</b>  4250 Lumens	Product code	FL50-A5	Beam Angle	150°
	Watts	50W	CRI	Ra>80
	Input Voltage	AC : 175-265V	IP Rating	IP65
	Flux	4250lm	Body Color	Black

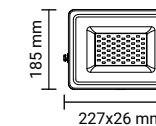

SKU: 5889    SKU: 5890    SKU: 5891  
6000K    4500K    2800K

<b>100W</b>  8500 Lumens	Product code	FL100-A5	Beam Angle	150°
	Watts	100W	CRI	Ra>80
	Input Voltage	AC : 175-265V	IP Rating	IP65
	Flux	8500lm	Body Color	Black

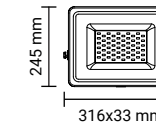

SKU: 5892    SKU: 5893    SKU: 5894  
6000K    4500K    2800K





LED SMD FLOODLIGHT **PF>0.9**  
**Premium Line - White Body**

**5** Years  
Warranty

**HIGH**  
Lumens

IP65



Power Cable Length-1.00m

**150W**  
**18000**  
Lumens

Product code FL150-A5  
Watts 150W  
Input Voltage AC : 100-265V  
Flux 18000lm

Beam Angle 150°  
CRI Ra>80  
IP Rating IP65  
Body Color White

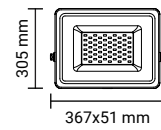

SKU: 5786 (6000K)    SKU: 5787 (4500K)

LED SMD FLOODLIGHT **PF>0.9**  
**Premium Line - Black Body**

**5** Years  
Warranty

**HIGH**  
Lumens

IP65



Power Cable Length-1.00m

**150W**  
**18000**  
Lumens

Product code FL150-A5  
Watts 150W  
Input Voltage AC : 100-265V  
Flux 18000lm

Beam Angle 150°  
CRI Ra>80  
IP Rating IP65  
Body Color Black

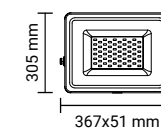

SKU: 5792 (6000K)    SKU: 5793 (4500K)

**200W**  
**24000**  
Lumens

Product code FL200-A5  
Watts 200W  
Input Voltage AC : 100-265V  
Flux 24000lm

Beam Angle 150°  
CRI Ra>80  
IP Rating IP65  
Body Color White

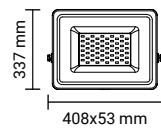

SKU: 5788 (6000K)    SKU: 5789 (4500K)

**200W**  
**24000**  
Lumens

Product code FL200-A5  
Watts 200W  
Input Voltage AC : 100-265V  
Flux 24000lm

Beam Angle 150°  
CRI Ra>80  
IP Rating IP65  
Body Color Black

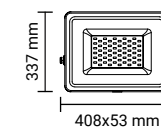

SKU: 5794 (6000K)    SKU: 5795 (4500K)

**300W**  
**36000**  
Lumens

Product code FL300-A5  
Watts 300W  
Input Voltage AC : 100-265V  
Flux 36000lm

Beam Angle 150°  
CRI Ra>80  
IP Rating IP65  
Body Color White

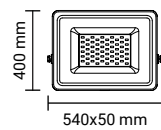

SKU: 5790 (6000K)    SKU: 5791 (4500K)

**300W**  
**36000**  
Lumens

Product code FL300-A5  
Watts 300W  
Input Voltage AC : 100-265V  
Flux 36000lm

Beam Angle 150°  
CRI Ra>80  
IP Rating IP65  
Body Color Black

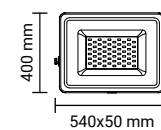

SKU: 5796 (6000K)    SKU: 5797 (4500K)

**LED SMD FLOODLIGHT**  
**CITY LINE - White Body**
**10W**800  
Lumens

Product code	FL10-B1	Beam Angle	120°
Watts	10W	CRI	Ra>80
Input Voltage	AC : 220-265V	IP Rating	IP65
Flux	800lm	Body Color	White

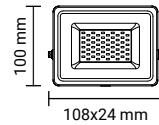

SKU: 5900	SKU: 5901	SKU: 5902
6000K	4500K	2800K

**LED SMD FLOODLIGHT**  
**CITY LINE - Black Body**
**10W**800  
Lumens

Product code	FL10-B1	Beam Angle	120°
Watts	10W	CRI	Ra>80
Input Voltage	AC : 220-265V	IP Rating	IP65
Flux	800lm	Body Color	Black

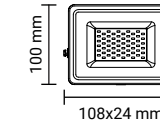

SKU: 5915	SKU: 5916	SKU: 5917
6000K	4500K	2800K

**20W**1600  
Lumens

Product code	FL20-B1	Beam Angle	120°
Watts	20W	CRI	Ra>80
Input Voltage	AC : 220-265V	IP Rating	IP65
Flux	1600lm	Body Color	White

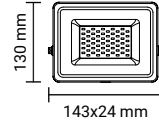

SKU: 5903	SKU: 5904	SKU: 5905
6000K	4500K	2800K

**20W**1600  
Lumens

Product code	FL20-B1	Beam Angle	120°
Watts	20W	CRI	Ra>80
Input Voltage	AC : 220-265V	IP Rating	IP65
Flux	1600lm	Body Color	Black

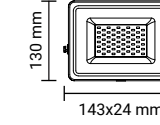

SKU: 5918	SKU: 5919	SKU: 5920
6000K	4500K	2800K

**30W**2400  
Lumens

Product code	FL30-B1	Beam Angle	120°
Watts	30W	CRI	Ra>80
Input Voltage	AC : 220-265V	IP Rating	IP65
Flux	2400lm	Body Color	White

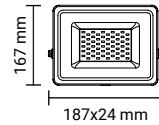

SKU: 5906	SKU: 5907	SKU: 5908
6000K	4500K	2800K

**30W**2400  
Lumens

Product code	FL30-B1	Beam Angle	120°
Watts	30W	CRI	Ra>80
Input Voltage	AC : 220-265V	IP Rating	IP65
Flux	2400lm	Body Color	Black

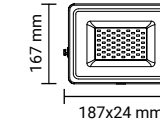

SKU: 5921	SKU: 5922	SKU: 5923
6000K	4500K	2800K

**50W**4000  
Lumens

Product code	FL50-B1	Beam Angle	120°
Watts	50W	CRI	Ra>80
Input Voltage	AC : 220-265V	IP Rating	IP65
Flux	4000lm	Body Color	White

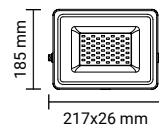

SKU: 5909	SKU: 5910	SKU: 5911
6000K	4500K	2800K

**50W**4000  
Lumens

Product code	FL50-B1	Beam Angle	120°
Watts	50W	CRI	Ra>80
Input Voltage	AC : 220-265V	IP Rating	IP65
Flux	4000lm	Body Color	Black

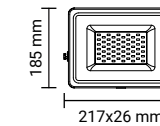

SKU: 5924	SKU: 5925	SKU: 5926
6000K	4500K	2800K

**100W**8000  
Lumens

Product code	FL100-B1	Beam Angle	120°
Watts	100W	CRI	Ra>80
Input Voltage	AC : 220-265V	IP Rating	IP65
Flux	8000lm	Body Color	White

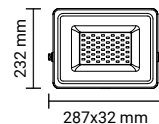

SKU: 5912	SKU: 5913	SKU: 5914
6000K	4500K	2800K

**100W**8000  
Lumens

Product code	FL100-B1	Beam Angle	120°
Watts	100W	CRI	Ra>80
Input Voltage	AC : 220-265V	IP Rating	IP65
Flux	8000lm	Body Color	Black

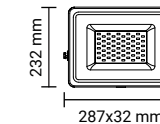

SKU: 5927	SKU: 5928	SKU: 5929
6000K	4500K	2800K

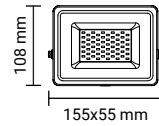

**LED SMD FLOODLIGHT**  
**CITY LINE- White Body**  
**With PIR Sensor**
**10W**  
**800**  
 Lumens

Product code	FL10-B2	Beam Angle	120°
Watts	10W	CRI	Ra>80
Input Voltage	AC : 220-265V	IP Rating	IP65
Flux	800lm	Body Color	White

 SKU: 5930 6000K  
 SKU: 5931 4500K  
 SKU: 5932 2800K

**20W**  
**1600**  
 Lumens

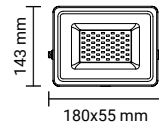
Product code	FL20-B2	Beam Angle	120°
Watts	20W	CRI	Ra>80
Input Voltage	AC : 220-265V	IP Rating	IP65
Flux	1600lm	Body Color	White

 SKU: 5933 6000K  
 SKU: 5934 4500K  
 SKU: 5935 2800K

**30W**  
**2400**  
 Lumens

Product code	FL30-B2	Beam Angle	120°
Watts	30W	CRI	Ra>80
Input Voltage	AC : 220-265V	IP Rating	IP65
Flux	2400lm	Body Color	White

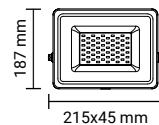
 SKU: 5936 6000K  
 SKU: 5937 4500K  
 SKU: 5938 2800K

**50W**  
**4000**  
 Lumens

Product code	FL50-B2	Beam Angle	120°
Watts	50W	CRI	Ra>80
Input Voltage	AC : 220-265V	IP Rating	IP65
Flux	4000lm	Body Color	White

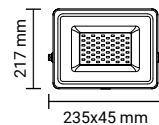
 SKU: 5939 6000K  
 SKU: 5940 4500K

**LED SMD FLOODLIGHT**  
**CITY LINE - Black Body**  
**With PIR Sensor**
**10W**  
**800**  
 Lumens

Product code	FL10-B2	Beam Angle	120°
Watts	10W	CRI	Ra>80
Input Voltage	AC : 220-265V	IP Rating	IP65
Flux	800lm	Body Color	Black

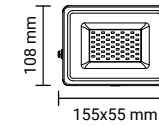
 SKU: 5941 6000K  
 SKU: 5942 4500K  
 SKU: 5943 2800K

**20W**  
**1600**  
 Lumens

Product code	FL20-B2	Beam Angle	120°
Watts	20W	CRI	Ra>80
Input Voltage	AC : 220-265V	IP Rating	IP65
Flux	1600lm	Body Color	Black

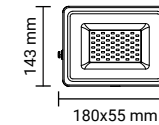
 SKU: 5944 6000K  
 SKU: 5945 4500K  
 SKU: 5946 2800K

**30W**  
**2400**  
 Lumens

Product code	FL30-B2	Beam Angle	120°
Watts	30W	CRI	Ra>80
Input Voltage	AC : 220-265V	IP Rating	IP65
Flux	2400lm	Body Color	Black

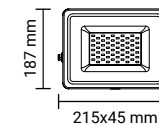
 SKU: 5947 6000K  
 SKU: 5948 4500K  
 SKU: 5949 2800K

**50W**  
**4000**  
 Lumens

Product code	FL50-B2	Beam Angle	120°
Watts	50W	CRI	Ra>80
Input Voltage	AC : 220-265V	IP Rating	IP65
Flux	4000lm	Body Color	Black

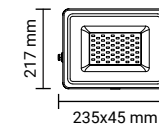
 SKU: 5950 6000K  
 SKU: 5951 4500K





LED SMD FLOODLIGHT **PF>0.9**  
**CCT LIGHT - Black Body**

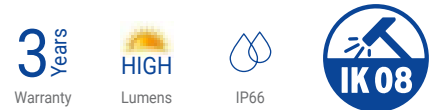

<b>50W</b>	Product code	FL50-A7	Beam Angle	120°
	Watts	50W	CRI	Ra>80
<b>5000</b>	Input Voltage	AC : 200-277V	IP Rating	IP66
Lumens	Flux	5 000lm	Body Color	Black

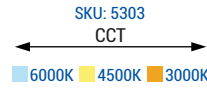
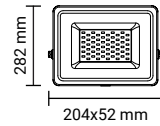

<b>100W</b>	Product code	FL100-A7	Beam Angle	120°
	Watts	100W	CRI	Ra>80
<b>10000</b>	Input Voltage	AC : 200-277V	IP Rating	IP66
Lumens	Flux	10000lm	Body Color	Black

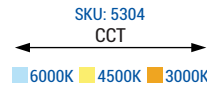
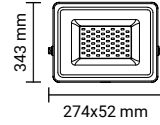

<b>150W</b>	Product code	FL150-A7	Beam Angle	120°
	Watts	150W	CRI	Ra>80
<b>15000</b>	Input Voltage	AC : 200-277V	IP Rating	IP66
Lumens	Flux	15000lm	Body Color	Black

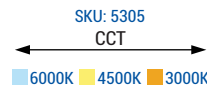
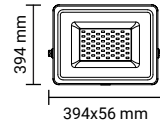

<b>200W</b>	Product code	FL200-A7	Beam Angle	120°
	Watts	200W	CRI	Ra>80
<b>20000</b>	Input Voltage	AC : 200-277V	IP Rating	IP66
Lumens	Flux	20000lm	Body Color	Black

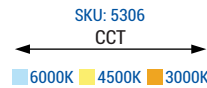
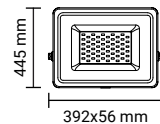

LED SMD FLOODLIGHT  
**CITY LINE - Black Body**  
**With PIR Sensor**

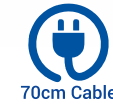

<b>10W</b>	Product code	FL10-B2	Beam Angle	120°
	Watts	10W	CRI	Ra>80
<b>800</b>	Input Voltage	AC : 220-265V	IP Rating	IP65
Lumens	Flux	800lm	Body Color	Black

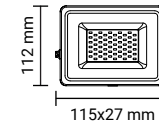

<b>20W</b>	Product code	FL20-B2	Beam Angle	120°
	Watts	20W	CRI	Ra>80
<b>1600</b>	Input Voltage	AC : 220-265V	IP Rating	IP65
Lumens	Flux	1600lm	Body Color	Black

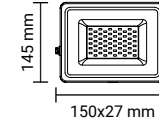

<b>30W</b>	Product code	FL30-B2	Beam Angle	120°
	Watts	30W	CRI	Ra>80
<b>2400</b>	Input Voltage	AC : 220-265V	IP Rating	IP65
Lumens	Flux	2400lm	Body Color	Black

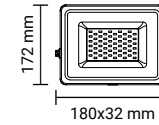

<b>50W</b>	Product code	FL50-B2	Beam Angle	120°
	Watts	50W	CRI	Ra>80
<b>4000</b>	Input Voltage	AC : 220-265V	IP Rating	IP65
Lumens	Flux	4000lm	Body Color	Black

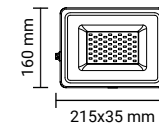



LED SMD FLOODLIGHT  
**On Stand - Foldable**



**20W**



1600  
Lumens

Product code	FL20-A8	Beam Angle	120°
Watts	20W	CRI	Ra>80
Input Voltage	AC : 200-240V	IP Rating	IP65
Flux	1600lm	Body Color	Yellow

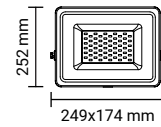

SKU: 5403  
■ 6000K

**30W**



2400  
Lumens

Product code	FL30-A8	Beam Angle	120°
Watts	30W	CRI	Ra>80
Input Voltage	AC : 200-240V	IP Rating	IP65
Flux	2400lm	Body Color	Yellow

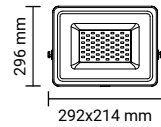

SKU: 5404  
■ 6000K

**50W**



4000  
Lumens

Product code	FL50-A8	Beam Angle	120°
Watts	50W	CRI	Ra>80
Input Voltage	AC : 200-240V	IP Rating	IP65
Flux	4000lm	Body Color	Yellow

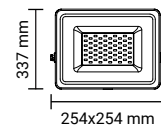

SKU: 5405  
■ 6000K



PORTABLE LED SMD FLOODLIGHT  
**Rechargeable + Battery**



Input Voltage	AC : 200-240V	Body Color	Yellow+Black
Beam Angle	120°	CRI	Ra>80
IP Rating	IP44	Dimension 10W	123x133x218mm
		Dimension 20W	156x163x250mm

**10W**



600  
Lumens



3.7V 2200mAh

SKU: 5401  
■ 6000K

**20W**



1200  
Lumens



3.7V 4400mAh

SKU: 5402  
■ 6000K



Flux	1850lm	Beam Angle	120°
Battery	3.7V 8Ah	CRI	Ra>80
Body Color	Yellow	Dimension	215x175x55mm

- SOS Emergency Light
- Power Bank Function
- USB Ports



3.7V 8Ah

LED SMD PORTABLE FLOODLIGHT  
**Solar Panel Power: 6V/2.3W**

SKU: 5464  
CCT  
■ 6000K ■ 4500K ■ 3000K



## LED SMD FLOODLIGHT

**Black Body -Green Light**

90°



IP65

**10W****800**

Lumens

Product code	FL10-B3	Beam Angle	90°
Watts	10W	CRI	Ra>70
Input Voltage	AC : 220-240V	IP Rating	IP65
Flux	800lm	Body Color	Black

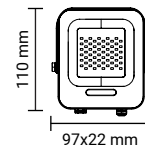
 SKU: 5751  
 Green

## LED RGB SMD FLOODLIGHT

**Black Body + Remote Control**

RGB



120°



IP65

**10W****800**

Lumens

Product code	FL10-B4	Beam Angle	120°
Watts	10W	CRI	Ra>80
Input Voltage	AC : 200-240V	IP Rating	IP65
Flux	800lm	Body Color	Black

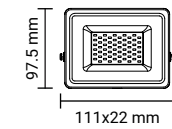
 SKU: 5754  
 RGB
**20W****1600**

Lumens

Product code	FL20-B3	Beam Angle	90°
Watts	20W	CRI	Ra>70
Product code	AC : 220-240V	IP Rating	IP65
Flux	1600lm	Body Color	Black

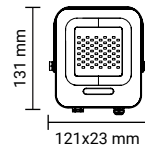
 SKU: 5752  
 Green
**30W****2400**

Lumens

Product code	FL30-B4	Beam Angle	120°
Watts	30W	CRI	Ra>80
Input Voltage	AC : 200-240V	IP Rating	IP65
Flux	2400lm	Body Color	Black

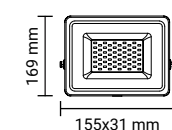
 SKU: 5755  
 RGB
**30W****2400**

Lumens

Product code	FL30-B3	Beam Angle	90°
Watts	30W	CRI	Ra>70
Input Voltage	AC : 220-240V	IP Rating	IP65
Flux	2400lm	Body Color	Black

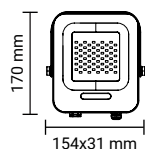

 SKU: 5753  
 Green
**50W****4000**

Lumens

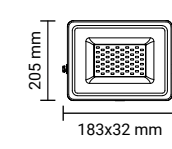
Product code	FL50-B4	Beam Angle	120°
Watts	50W	CRI	Ra>80
Input Voltage	AC : 200-240V	IP Rating	IP65
Flux	4000lm	Body Color	Black

 SKU: 5756  
 RGB

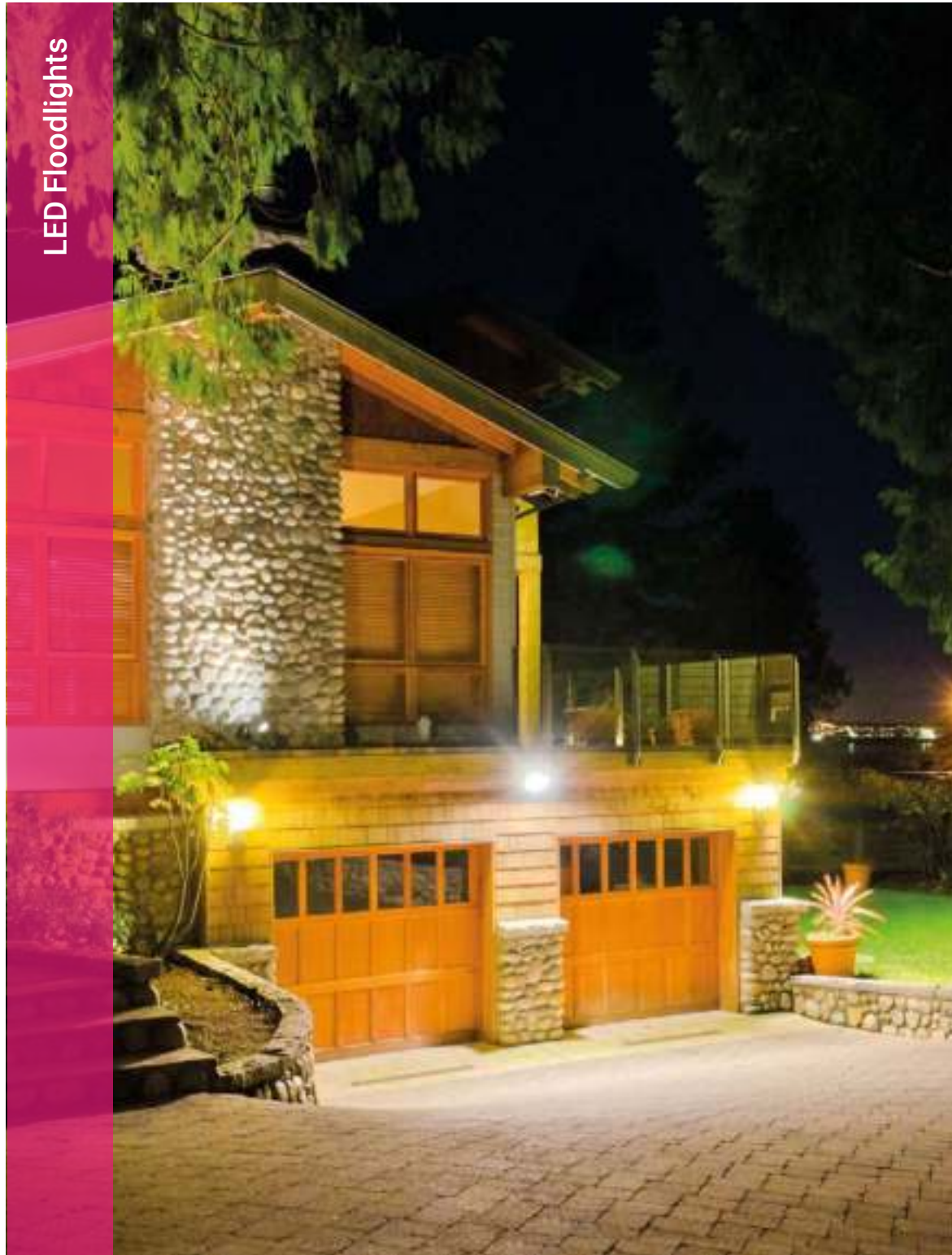



LED SMD5730 FLOODLIGHT **PF>0.9**  
**Dual Voltage With Terminal Block**



**100W**



Product code	FL100-A9	Beam Angle	120°
Watts	100W	CRI	Ra>80
Input Voltage	AC : 85-265V	IP Rating	IP65
Flux	9000lm	Body Color	Black

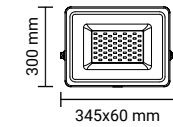

SKU: 5277  
6000K

**200W**



Product code	FL200-A9	Beam Angle	120°
Watts	200W	CRI	Ra>80
Input Voltage	AC : 85-265V	IP Rating	IP65
Flux	18000lm	Body Color	Black

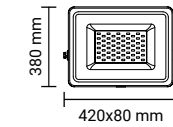

SKU: 5279  
6000K





LED SMD FLOODLIGHT  
**High Power - Black Body**



<b>150W</b> Lumens	Product code	FL150-B3	Beam Angle	90°
<b>13500</b>	Watts	150W	CRI	Ra>80
	Input Voltage	AC : 220-240V	IP Rating	IP65
	Flux	13500lm	Body Color	Black

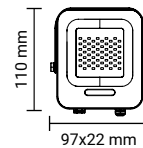

SKU: 5736 6000K  
SKU: 5737 4500K



LED SMD FLOODLIGHT  
**Classic Line 2 - High Power**



<b>150W</b> Lumens	Product code	FL150-A3	Beam Angle	100°
<b>12750</b>	Watts	100W	CRI	Ra>80
	Input Voltage	AC : 170-265V	IP Rating	IP65
	Flux	12750lm	Body Color	Black

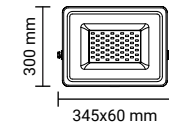

SKU: 5818 6000K  
SKU: 5819 4500K

<b>200W</b> Lumens	Product code	FL200-B3	Beam Angle	90°
<b>18000</b>	Watts	200W	CRI	Ra>80
	Input Voltage	AC : 220-240V	IP Rating	IP65
	Flux	18000lm	Body Color	Black

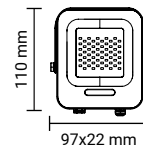

SKU: 5738 6000K  
SKU: 5739 4500K

<b>200W</b> Lumens	Product code	FL200-A3	Beam Angle	100°
<b>17000</b>	Watts	200W	CRI	Ra>80
	Input Voltage	AC : 170-265V	IP Rating	IP65
	Flux	17000lm	Body Color	Black

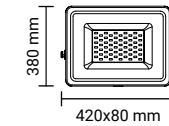

SKU: 5838 6000K  
SKU: 5839 4500K



**Floodlight Spike**  
Body Color: Black  
Material: Aluminium

SKU: 6682 160x35cm  
SKU: 6683 265x55cm



**Billboard Stand**  
Body Color: Black  
Material: Iron

SKU: 6684 150x500cm  
SKU: 6685 200x800cm





**TRIPOD FOR FLOODLIGHTS  
With Cross Bar**

Product code OT1-B9  
 Body Color Yellow , Black  
 Material Iron  
 Maximum size 157x64x64cm  
 Height Adjustment: 64-157cm  
 Sections: 3 Pcs

SKU: 6686 BLACK BODY ■  
 SKU: 6687 YELLOW BODY ■

**Terminal Block  
Waterproof Box**

Rated Voltage 250V  
 Material Flame Retardant PP  
 Wire Range 0.5-1.5mm<sup>2</sup>  
 Wire Range-T 0.5-2.5mm<sup>2</sup>  
 Rated Current 16A



SKU: 6641  
 SKU: 6642



**Terminal Blocks Professional  
Metal-Waterproof Box**

Rated Voltage 450V  
 Material Cast Aluminium  
 Body Size 80x75x60mm  
 Rated Current 24A



SKU: 6509 2-Connectors  
 SKU: 6510 3-Connectors  
 SKU: 6511 4-Connectors  
 SKU: 6512 4-X-Connectors



**Lever Connectors  
Easy Clip**

Rated voltage 450V  
 Rated current 32A  
 Wire range 18-12AWG 0.08--2.5mm<sup>2</sup>  
 Ambient temperature -40°C~+105°C  
 Strip length 12-13mm

SKU: 6501  
 SKU: 6502  
 SKU: 6503  
 SKU: 6504  
 SKU: 6505



Rated voltage 450V  
 Rated current 32A  
 Housing material: thermoplastic, 94V-0  
 Flame-retardant  
 Temperature: 110 degrees Celsius  
 Wire range: #24 to #12 AWG solid wires

SKU: 6506  
 SKU: 6507  
 SKU: 6508

**Terminal Block Splitter  
Waterproof Box**

Rated Voltage 250V  
 Material Polypropylene 94 V2  
 Wire Range 0.5-2.5mm<sup>2</sup>  
 Rated Current 16A



SKU: 6643



**Terminal Block Splitter  
Waterproof Box**

Rated Voltage 450V  
 Material Polypropylene 94 V2  
 Wire Range 0.5-4mm<sup>2</sup>  
 Rated Current 24A



SKU: 6644



**Terminal Blocks Professional  
Polycarbonate-Waterproof Box**

Rated Voltage 250V  
 Rated Current 16A  
 Material Polycarbonate  
 Body Size 120x35x50 mm



SKU: 6647 2-Connectors



Rated Voltage 450V  
 Rated Current 24A  
 Material Polycarbonate  
 Body Size 120x35x70 mm



SKU: 6648 3-Connectors

**Terminal Block Splitter  
Waterproof Box**

Rated Voltage 450V  
 Material Polypropylene 94 V2  
 Wire Range 0.5-4mm<sup>2</sup>  
 Rated Current 24A



SKU: 6645



**Terminal Block Splitter  
Waterproof Box**

Rated Voltage 450V  
 Material Polypropylene 94 V2  
 Wire Range 0.5-4mm<sup>2</sup>  
 Rated Current 24A



SKU: 6646







## LED STREET AND INDUSTRIAL LIGHTS



LED industrial lights are series of highly efficient, reliable and easy to install products for production sites, warehouses or specialised areas. With different types – low or high bays, bulbs or linear lighting fixtures. These products will meet all industry standards and cover any lighting needs.

**Features:**

- Up to 80% power saving
- Variety of shapes and types
- Long lifetime and reliability
- Different types of mounting options
- Comply with industrial standards

**Application:**

- Production sites and warehouses
- Industrial places and factories
- Special lighting requirements





LED SOLAR INDUSTRIAL LIGHTS

Remote Control



**30W**

**4300**  
Lumens

Power Solar	5V/30W	CRI	Ra>80
Beam Angle	60°	IP Rating	IP66
Flux	4300lm	Body Color	Black



SKU: 9141  
6000K

**40W**

**5200**  
Lumens

Power Solar	5V/40W	CRI	Ra>80
Beam Angle	60°	IP Rating	IP66
Flux	5200lm	Body Color	Black



SKU: 9142  
6000K

**50W**

**6300**  
Lumens

Power Solar	5V/50W	CRI	Ra>80
Beam Angle	60°	IP Rating	IP66
Flux	6300lm	Body Color	Black



SKU: 9143  
6000K



LED STREET LIGHT

Solar Power + Battery



**500**  
Lumens

Product code	SL8-B6	Beam Angle	120°
Watts	8W	CRI	Ra>70
Battery	3.2V 5AH	IP Rating	IP65
Flux	500lm	Body Color	Black

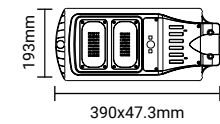

SKU: 9126  
6000K

**1200**  
Lumens

Product code	SL10-B6	Beam Angle	120°
Watts	10W	CRI	Ra>70
Battery	3.2V 10AH	IP Rating	IP65
Flux	1200lm	Body Color	Black

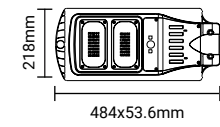

SKU: 9127  
6000K

**1800**  
Lumens

Product code	SL15-B6	Beam Angle	120°
Watts	15W	CRI	Ra>70
Battery	3.2V 15AH	IP Rating	IP65
Flux	1800lm	Body Color	Black

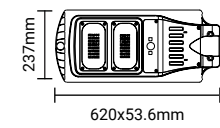

SKU: 9128  
6000K

**2400**  
Lumens

Product code	SL18-B6	Beam Angle	120°
Watts	18W	CRI	Ra>70
Battery	3.2V 20AH	IP Rating	IP65
Flux	2400lm	Body Color	Black

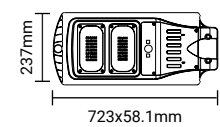

SKU: 9129  
6000K





LED STREET LIGHT  
**8W Solar Power + Battery**

Watts	8W	CRI	Ra>70
Battery	3.2V / 16.5Ah	IP Rating	IP65
Flux	950lm	Dimension	490x240x65mm
Beam Angle	120°	Body Color	Black

- \* Intelligent Light Control
  - \* Time Switch
- SKU: 9135  
6000K



Wireless Remote Control

950 Lumens    Battery    >1500 Cycles    Solar Power    IP65



LED STREET LIGHT  
**35W Solar Power + Battery**

Watts	35W	CRI	Ra>70
Battery	6.4V / 16.5Ah	IP Rating	IP65
Flux	2600lm	Dimension	490x240x65mm
Beam Angle	120°	Body Color	Black

- \* Intelligent Light Control
  - \* Time Switch
- SKU: 9137  
6000K



Wireless Remote Control

2600 Lumens    Battery    >1500 Cycles    Solar Power    IP65



LED STREET LIGHT  
**12W Solar Power + Battery**

Watts	12W	CRI	Ra>70
Battery	3.2V / 22Ah	IP Rating	IP65
Flux	1200lm	Dimension	650x250x65mm
Beam Angle	120°	Body Color	Black

- \* Intelligent Light Control
  - \* Time Switch
- SKU: 9136  
6000K



Wireless Remote Control

1200 Lumens    Battery    >1500 Cycles    Solar Power    IP65



LED STREET LIGHT  
**40W Solar Power + Battery**

Watts	40W	CRI	Ra>70
Battery	6.4V / 22h	IP Rating	IP65
Flux	3000lm	Dimension	490x240x65mm
Beam Angle	120°	Body Color	Black

- \* Intelligent Light Control
  - \* Time Switch
- SKU: 9138  
6000K



Wireless Remote Control

3000 Lumens    Battery    >1500 Cycles    Solar Power    IP65





**LED STREET LIGHT PF>0.9**  
**High Lumens**



<b>50W</b> 5000 Lumens	Product code Watts Input Voltage Flux	SL50-A9 50W AC : 220-240V 5000lm	Beam Angle CRI IP Rating Body Color	75x135° Ra>70 IP65 Gray
---------------------------	--	---	--	----------------------------------

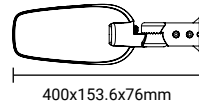

SKU: 9221  
6000K

<b>100W</b> 10000 Lumens	Product code Watts Input Voltage Flux	SL100-A9 100W AC : 220-240V 10000lm	Beam Angle CRI IP Rating Body Color	75x135° Ra>70 IP65 Gray
-----------------------------	--	--	--	----------------------------------

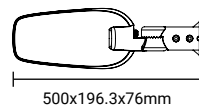

SKU: 9222  
6000K

<b>150W</b> 15000 Lumens	Product code Watts Input Voltage Flux	SL150-A9 150W AC : 220-240V 15000lm	Beam Angle CRI IP Rating Body Color	75x135° Ra>70 IP65 Gray
-----------------------------	--	--	--	----------------------------------

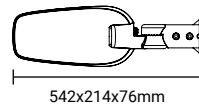

SKU: 9223  
6000K

<b>200W</b> 20000 Lumens	Product code Watts Input Voltage Flux	SL200-A9 200W AC : 220-240V 20000lm	Beam Angle CRI IP Rating Body Color	75x135° Ra>70 IP65 Gray
-----------------------------	--	--	--	----------------------------------

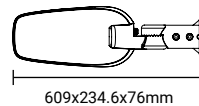

SKU: 9224  
6000K



**LED STREET LIGHT PF>0.9**  
**High Lumens**



<b>30W</b> 3000 Lumens	Product code Watts Input Voltage Flux	SL30-A9 30W AC : 220-240V 3000lm	Beam Angle CRI IP Rating Body Color	75x135° Ra>70 IP65 Gray
---------------------------	--	---	--	----------------------------------

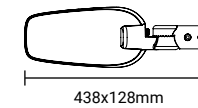

SKU: 9201  
6000K

SKU: 9202  
4500K

SKU: 9203  
2700K

<b>50W</b> 5000 Lumens	Product code Watts Input Voltage Flux	SL50-A9 50W AC : 220-240V 5000lm	Beam Angle CRI IP Rating Body Color	75x135° Ra>70 IP65 Gray
---------------------------	--	---	--	----------------------------------

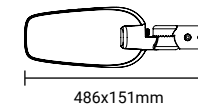

SKU: 9204  
6000K

SKU: 9205  
4500K

SKU: 9206  
2700K

<b>100W</b> 10000 Lumens	Product code Watts Input Voltage Flux	SL100-A9 100W AC : 220-240V 10000lm	Beam Angle CRI IP Rating Body Color	75x135° Ra>70 IP65 Gray
-----------------------------	--	--	--	----------------------------------

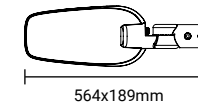

SKU: 9207  
6000K

SKU: 9208  
4500K

SKU: 9209  
2700K

<b>150W</b> 15000 Lumens	Product code Watts Input Voltage Flux	SL150-A9 150W AC : 220-240V 15000lm	Beam Angle CRI IP Rating Body Color	75x135° Ra>70 IP65 Gray
-----------------------------	--	--	--	----------------------------------

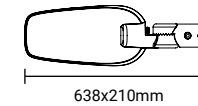

SKU: 9210  
6000K

SKU: 9211  
4500K

SKU: 9212  
2700K

<b>200W</b> 20000 Lumens	Product code Watts Input Voltage Flux	SL200-A9 200W AC : 220-240V 20000lm	Beam Angle CRI IP Rating Body Color	75x135° Ra>70 IP65 Gray
-----------------------------	--	--	--	----------------------------------

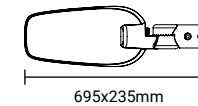

SKU: 9213  
6000K

SKU: 9214  
4500K

SKU: 9215  
2700K



LED STREET LIGHT **PF>0.95**  
**High Lumens-Moso Driver**



**5** Years  
Warranty

**150**  
Lumens/W

**HIGH**  
Lumens

**120°**

**IP65**

**100W**

**15000**  
Lumens

Product code	SL100-A7	Beam Angle	120°
Watts	100W	CRI	Ra>70
Input Voltage	AC : 220-240V	IP Rating	IP65
Flux	15000lm	Protection	Class 1

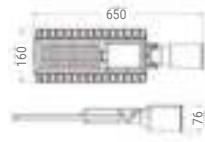

SKU: 9179  
5700K

**120W**

**18000**  
Lumens

Product code	SL120-A7	Beam Angle	120°
Watts	120W	CRI	Ra>70
Input Voltage	AC : 220-240V	IP Rating	IP65
Flux	18000lm	Protection	Class 1

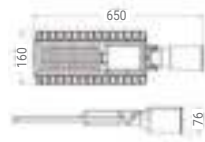

SKU: 9180  
5700K



LED STREET LIGHT **PF>0.95**  
**High Lumens-Moso Driver**



**5** Years  
Warranty

**140**  
Lumens/W

**HIGH**  
Lumens

**IP66**

**80W**

**11200**  
Lumens

Product code	SL80-A8	Beam Angle	120°
Watts	80W	CRI	Ra>70
Input Voltage	AC : 100-240V	IP Rating	IP66
Flux	11200lm	Protection	Class 1

SKU: 9196  
5700K

**100W**

**14000**  
Lumens

Product code	SL50-A8	Beam Angle	120°
Watts	100W	CRI	Ra>70
Input Voltage	AC : 100-240V	IP Rating	IP66
Flux	14000lm	Protection	Class 1

SKU: 9197  
5700K

**150W**

**21000**  
Lumens

Product code	SL150-A8	Beam Angle	120°
Watts	150W	CRI	Ra>70
Input Voltage	AC : 100-240V	IP Rating	IP66
Flux	21000lm	Protection	Class 1

SKU: 9198  
5700K

**180W**

**25200**  
Lumens

Product code	SL180-A8	Beam Angle	120°
Watts	180W	CRI	Ra>70
Input Voltage	AC : 100-240V	IP Rating	IP66
Flux	25200lm	Protection	Class 1

SKU: 9199  
5700K



Adjusting angle



LED STREET LIGHT **PF>0.9**  
**2 pcs BOX**



LED STREET LIGHT **PF>0.9**  
**2 pcs BOX**



**30W**  
 **4050**  
Lumens

Product code	SL30-A2	Beam Angle	120°
Watts	30W	CRI	Ra>70
Input Voltage	AC : 100-240V	IP Rating	IP65
Flux	4050lm	Protection	Class 1

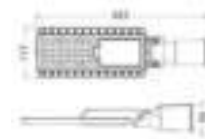

SKU: 9156  
■ 5700K

**20W**  
 **2000**  
Lumens

Product code	SL20-A1	Beam Angle	120°
Watts	20W	CRI	Ra>70
Input Voltage	AC : 220-240V	IP Rating	IP65
Flux	2000lm	Protection	Class 2

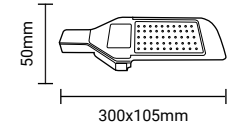

SKU: 9171  
■ 6000K

**50W**  
 **7500**  
Lumens

Product code	SL50-A2	Beam Angle	120°
Watts	50W	CRI	Ra>70
Input Voltage	AC : 100-240V	IP Rating	IP65
Flux	7500lm	Protection	Class 1

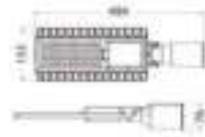

SKU: 9157  
■ 5700K

**50W**  
 **5000**  
Lumens

Product code	SL50-A1	Beam Angle	120°
Watts	50W	CRI	Ra>70
Input Voltage	AC : 220-240V	IP Rating	IP65
Flux	5000lm	Protection	Class 2

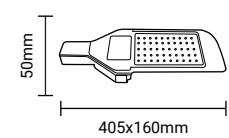

SKU: 9172  
■ 6000K

**80W**  
 **8000**  
Lumens

Product code	SL80-A1	Beam Angle	120°
Watts	80W	CRI	Ra>70
Input Voltage	AC : 220-240V	IP Rating	IP65
Flux	8000lm	Protection	Class 2

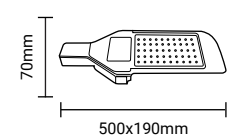

SKU: 9173  
■ 6000K

**60W**  
 **8100**  
Lumens

Product code	SL60-A2	Beam Angle	120°
Watts	60W	CRI	Ra>70
Input Voltage	AC : 100-240V	IP Rating	IP65
Flux	8100lm	Protection	Class 1

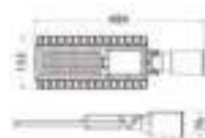

SKU: 9158  
■ 5700K

**100W**  
 **10000**  
Lumens

Product code	SL100-A1	Beam Angle	120°
Watts	100W	CRI	Ra>70
Input Voltage	AC : 220-240V	IP Rating	IP65
Flux	10000lm	Protection	Class 2

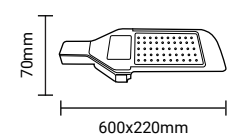

SKU: 9174  
■ 6000K





LED STREET LIGHT **PF>0.9**  
**Bridgelux 3030 Chips**

5 Years Warranty  
 HIGH Lumens  
 120°  
 IP65

**150W**  
 **14250**  
Lumens

Product code	SL150-A3	Beam Angle	120°
Watts	150W	CRI	Ra>70
Input Voltage	AC : 220-240V	IP Rating	IP65
Flux	14250lm	Protection	Class 1

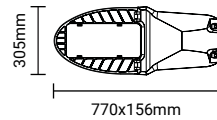

SKU: 9181  
■ 5700K

**200W**  
 **19000**  
Lumens

Product code	SL200-A3	Beam Angle	120°
Watts	200W	CRI	Ra>70
Input Voltage	AC : 220-240V	IP Rating	IP65
Flux	19000lm	Protection	Class 1

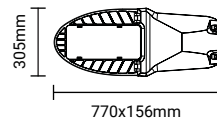

SKU: 9182  
■ 5700K

**Adapter Matt Grey Φ60mm to Φ40mm**

SKU: 9118



**Adapter Φ60mm to Φ60 mm Adjustable Angle 90°**

SKU: 9119



LED INDUSTRIAL LIGHTS **PF>0.9**  
**Stadium Floodlight**

5 Years Warranty  
 HIGH Lumens  
 90°  
 IP65

**100W**  
 **10000**  
Lumens

Product code	SL100-A5	Beam Angle	90°
Watts	100W	CRI	Ra>70
Input Voltage	AC : 220-240V	IP Rating	IP65
Flux	10000lm	Protection	Class 1

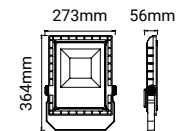

SKU: 9175  
■ 5700K

**150W**  
 **16500**  
Lumens

Product code	SL150-A5	Beam Angle	90°
Watts	150W	CRI	Ra>70
Input Voltage	AC : 220-240V	IP Rating	IP65
Flux	16500lm	Protection	Class 1

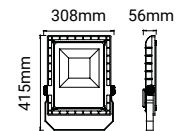

SKU: 9176  
■ 5700K

**240W**  
 **26400**  
Lumens

Product code	SL240-A5	Beam Angle	90°
Watts	240W	CRI	Ra>70
Input Voltage	AC : 220-240V	IP Rating	IP65
Flux	26400lm	Protection	Class 1

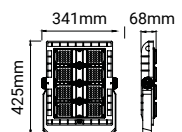

SKU: 9177  
■ 5700K

**480W**  
 **68000**  
Lumens

Product code	SL480-A5	Beam Angle	90°
Watts	480W	CRI	Ra>70
Input Voltage	AC : 220-240V	IP Rating	IP65
Flux	68000lm	Protection	Class 1

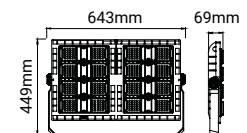

SKU: 9178  
■ 5700K



LED INDUSTRIAL LIGHTS **PF>0.9**  
**SLIM LINE**



**50W**

**5000**  
Lumens

Watts	50W	Beam Angle	90°
Input Voltage	AC : 220-240V	IP Rating	IP65
Flux	5000lm	Body Color	Grey

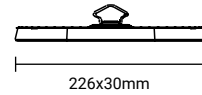

SKU: 8231    SKU: 8232  
6000K    4500K

**100W**

**10000**  
Lumens

Watts	100W	Beam Angle	90°
Input Voltage	AC : 220-240V	IP Rating	IP65
Flux	10000lm	Body Color	Grey

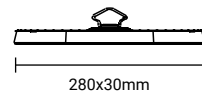

SKU: 8233    SKU: 8234  
6000K    4500K

**150W**

**15000**  
Lumens

Watts	150W	Beam Angle	90°
Input Voltage	AC : 220-240V	IP Rating	IP65
Flux	15000lm	Body Color	Grey

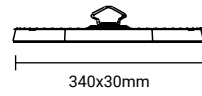

SKU: 8235    SKU: 8236  
6000K    4500K

**200W**

**20000**  
Lumens

Watts	200W	Beam Angle	90°
Input Voltage	AC : 220-240V	IP Rating	IP65
Flux	20000lm	Body Color	Grey

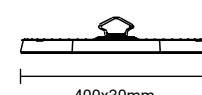

SKU: 8237    SKU: 8238  
6000K    4500K



LED INDUSTRIAL LIGHTS **PF>0.9**  
**High Lumens**



**100W**

**10000**  
Lumens

Product code	HB100-B1	Beam Angle	90°
Watts	100W	CRI	Ra>80
Input Voltage	AC : 220-240V	IP Rating	IP65
Flux	10000lm	Body Color	Black

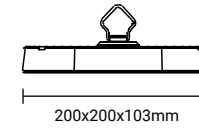

SKU: 8221 White Light 6000K  
SKU: 8222 Neutral Light 4500K

**150W**

**15000**  
Lumens

Product code	HB150-B1	Beam Angle	90°
Watts	150W	CRI	Ra>80
Input Voltage	AC : 220-240V	IP Rating	IP65
Flux	15000lm	Body Color	Black

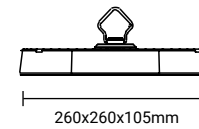

SKU: 8223 White Light 6000K  
SKU: 8224 Neutral Light 4500K

**200W**

**20000**  
Lumens

Product code	HB200-B1	Beam Angle	90°
Watts	200W	CRI	Ra>80
Input Voltage	AC : 220-240V	IP Rating	IP65
Flux	20000lm	Body Color	Black

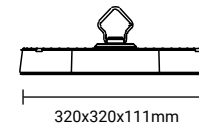

SKU: 8225 White Light 6000K  
SKU: 8226 Neutral Light 4500K



**LED INDUSTRIAL LIGHT HIGH LUMEN  
HIGH BAY PF>0.9**

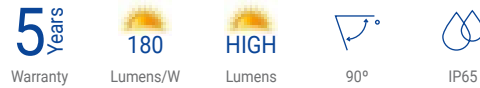

<b>100W</b>  <b>18000</b> Lumens	Product code	HB110-A1	Beam Angle	90°
	Watts	100W	CRI	Ra>80
	Input Voltage	AC : 220-240V	IP Rating	IP65
	Flux	18000lm	Protection	Class 1

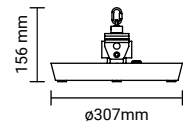

SKU: 8190  
■ 5700K



**LED INDUSTRIAL LIGHT  
HIGH BAY UFO PF>0.9**



<b>100W</b>  <b>11000</b> Lumens	Product code	HB100-A5	Beam Angle	90°
	Watts	100W	CRI	Ra>80
	Input Voltage	AC : 220-240V	IP Rating	IP54
	Flux	11000lm	Protection	Class 1

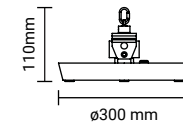

SKU: 8140  
■ 5700K

<b>150W</b>  <b>27000</b> Lumens	Product code	HB150-A3	Beam Angle	90°
	Watts	150W	CRI	Ra>80
	Input Voltage	AC : 220-240V	IP Rating	IP65
	Flux	27000lm	Protection	Class 1

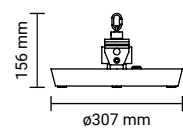

SKU: 8191  
■ 5700K

<b>150W</b>  <b>16500</b> Lumens	Product code	HB150-A5	Beam Angle	90°
	Watts	150W	CRI	Ra>80
	Input Voltage	AC : 220-240V	IP Rating	IP54
	Flux	16500lm	Protection	Class 1

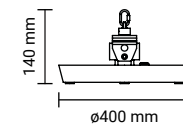

SKU: 8141  
■ 5700K

<b>200W</b>  <b>36000</b> Lumens	Product code	HB210-A1	Beam Angle	90°
	Watts	200W	CRI	Ra>80
	Input Voltage	AC : 220-240V	IP Rating	IP65
	Flux	36000lm	Protection	Class 1

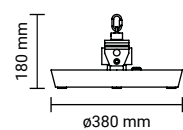

SKU: 8192  
■ 5700K

<b>200W</b>  <b>22000</b> Lumens	Product code	HB200-A5	Beam Angle	90°
	Watts	200W	CRI	Ra>80
	Input Voltage	AC : 220-240V	IP Rating	IP54
	Flux	22000lm	Protection	Class 1

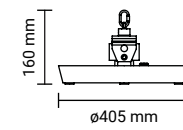

SKU: 8126  
■ 5700K



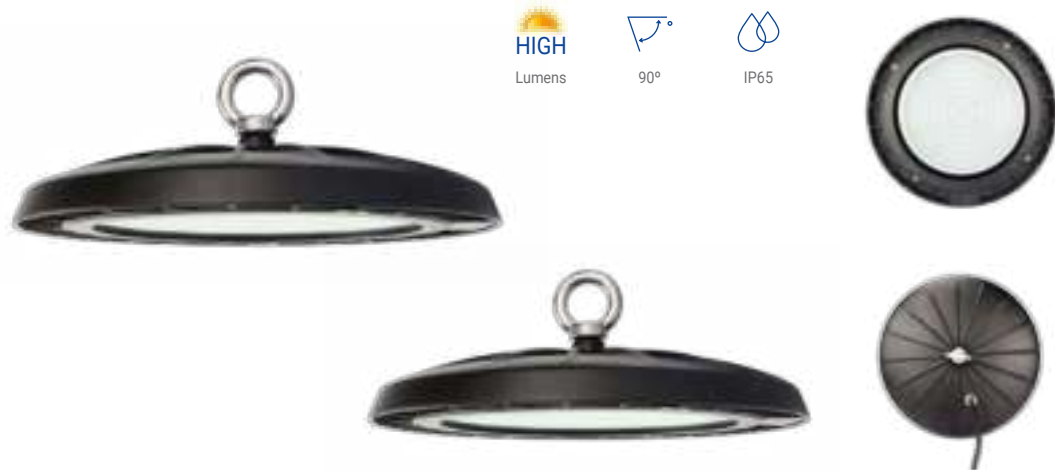

**HIGH**  
Lumens

**90°**

**IP65**

LED INDUSTRIAL LIGHT  
**HIGH BAY - UFO - 90°**

<b>50W</b>  <b>5000</b> Lumens	Product code	HB50-A8	Beam Angle	90°
	Watts	50W	CRI	Ra>70
	Input Voltage	AC : 220-240V	IP Rating	IP65
	Flux	5000lm	Protection	Class 1

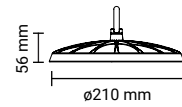

SKU: 8201    SKU: 8204  
6000K    4500K



**HIGH**  
Lumens

**120°**

**IP65**

LED INDUSTRIAL LIGHT  
**HIGH BAY - UFO - 120°**

<b>50W</b>  <b>5000</b> Lumens	Product code	HB50-A8	Beam Angle	120°
	Watts	50W	CRI	Ra>70
	Input Voltage	AC : 220-240V	IP Rating	IP65
	Flux	5000lm	Protection	Class 1

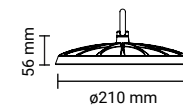

SKU: 8211    SKU: 8212  
6000K    4500K

<b>100W</b>  <b>10000</b> Lumens	Product code	HB100-A8	Beam Angle	90°
	Watts	100W	CRI	Ra>70
	Input Voltage	AC : 220-240V	IP Rating	IP65
	Flux	10000lm	Protection	Class 1

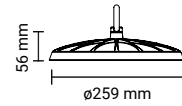

SKU: 8203    SKU: 8204  
6000K    4500K

<b>100W</b>  <b>10000</b> Lumens	Product code	HB100-A8	Beam Angle	120°
	Watts	100W	CRI	Ra>70
	Input Voltage	AC : 220-240V	IP Rating	IP65
	Flux	10000lm	Protection	Class 1

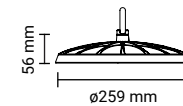

SKU: 8213    SKU: 8214  
6000K    4500K

<b>150W</b>  <b>15000</b> Lumens	Product code	HB150-A8	Beam Angle	90°
	Watts	150W	CRI	Ra>70
	Input Voltage	AC : 220-240V	IP Rating	IP65
	Flux	15000lm	Protection	Class 1

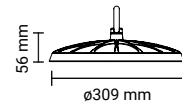

SKU: 8205    SKU: 8206  
6000K    4500K

<b>150W</b>  <b>15000</b> Lumens	Product code	HB150-A8	Beam Angle	120°
	Watts	150W	CRI	Ra>70
	Input Voltage	AC : 220-240V	IP Rating	IP65
	Flux	15000lm	Protection	Class 1

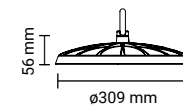

SKU: 8215    SKU: 8216  
6000K    4500K

<b>200W</b>  <b>20000</b> Lumens	Product code	HB200-A8	Beam Angle	90°
	Watts	200W	CRI	Ra>70
	Input Voltage	AC : 220-240V	IP Rating	IP65
	Flux	20000lm	Protection	Class 1

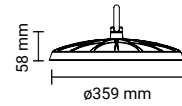

SKU: 8207    SKU: 8208  
6000K    4500K

<b>200W</b>  <b>20000</b> Lumens	Product code	HB200-A8	Beam Angle	120°
	Watts	200W	CRI	Ra>70
	Input Voltage	AC : 220-240V	IP Rating	IP65
	Flux	20000lm	Protection	Class 1

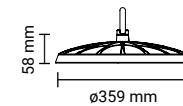

SKU: 8217    SKU: 8218  
6000K    4500K



LED INDUSTRIAL LIGHT  
**HIGH BAY - UFO 2 - 90°**



<b>50W</b>	Product code	HB50-A6	Beam Angle	90°
<b>4250</b>	Watts	50W	CRI	Ra>70
Lumens	Input Voltage	AC : 220-240V	IP Rating	IP65
	Flux	4250lm	Protection	Class 1

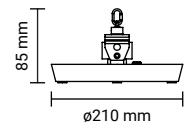

SKU: 8166    SKU: 8167  
 6000K    4500K



LED INDUSTRIAL LIGHT  
**HIGH BAY - UFO 2 - 120°**



<b>50W</b>	Product code	HB50-A6	Beam Angle	120°
<b>4250</b>	Watts	50W	CRI	Ra>70
Lumens	Input Voltage	AC : 220-240V	IP Rating	IP65
	Flux	4250lm	Protection	Class 1

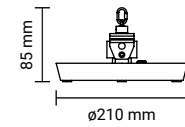

SKU: 8175  
 4500K

<b>100W</b>	Product code	HB100-A6	Beam Angle	90°
<b>8500</b>	Watts	100W	CRI	Ra>70
Lumens	Input Voltage	AC : 220-240V	IP Rating	IP65
	Flux	8500lm	Protection	Class 1

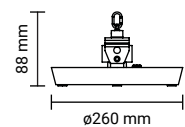

SKU: 8168    SKU: 8169  
 6000K    4500K

<b>100W</b>	Product code	HB100-A6	Beam Angle	120°
<b>8500</b>	Watts	100W	CRI	Ra>70
Lumens	Input Voltage	AC : 220-240V	IP Rating	IP65
	Flux	8500lm	Protection	Class 1

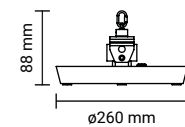

SKU: 8177  
 4500K

<b>150W</b>	Product code	HB150-A6	Beam Angle	90°
<b>12750</b>	Watts	150W	CRI	Ra>70
Lumens	Input Voltage	AC : 220-240V	IP Rating	IP65
	Flux	12750lm	Protection	Class 1

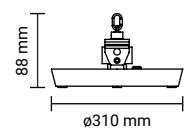

SKU: 8170    SKU: 8171  
 6000K    4500K

<b>150W</b>	Product code	HB150-A6	Beam Angle	120°
<b>12750</b>	Watts	150W	CRI	Ra>70
Lumens	Input Voltage	AC : 220-240V	IP Rating	IP65
	Flux	12750lm	Protection	Class 1

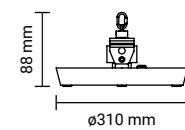

SKU: 8178    SKU: 8179  
 6000K    4500K

<b>200W</b>	Product code	HB200-A6	Beam Angle	90°
<b>17000</b>	Watts	200W	CRI	Ra>70
Lumens	Input Voltage	AC : 220-240V	IP Rating	IP65
	Flux	17000lm	Protection	Class 1

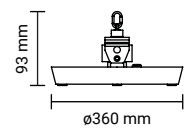

SKU: 8172    SKU: 8173  
 6000K    4500K

<b>200W</b>	Product code	HB200-A6	Beam Angle	120°
<b>17000</b>	Watts	200W	CRI	Ra>70
Lumens	Input Voltage	AC : 220-240V	IP Rating	IP65
	Flux	17000lm	Protection	Class 1

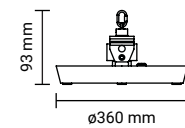

SKU: 8181  
 4500K



LED INDUSTRIAL LIGHT

**Linear High Bay**



**50W**



Product code	HB50-A2	Beam Angle	120°x60°
Watts	50W	CRI	Ra>70
Input Voltage	AC : 220-240V	IP Rating	IP44
Flux	5000lm	Body Color	Class 1

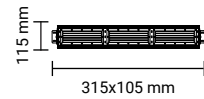

SKU: 8151    SKU: 8152  
6000K    4500K

**100W**



Product code	HB100-A2	Beam Angle	120°x60°
Watts	50W	CRI	Ra>70
Input Voltage	AC : 220-240V	IP Rating	IP44
Flux	10000lm	Body Color	Black

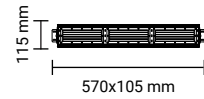

SKU: 8153    SKU: 8154  
6000K    4500K

**150W**



Product code	HB150-A2	Beam Angle	120°x60°
Watts	50W	CRI	Ra>70
Input Voltage	AC : 220-240V	IP Rating	IP44
Flux	15000lm	Body Color	Black

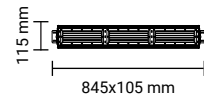

SKU: 8155    SKU: 8156  
6000K    4500K

**200W**



Product code	HB200-A2	Beam Angle	120°x60°
Watts	50W	CRI	Ra>70
Input Voltage	AC : 220-240V	IP Rating	IP44
Flux	20000lm	Body Color	Black

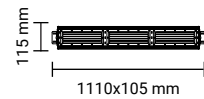

SKU: 8157    SKU: 8158  
6000K    4500K



LED INDUSTRIAL Bulb **PF>0.9**  
**40W E27**



Product code	HB40-A1	Socket	E27
Watts	40W	CRI	Ra>80
Input Voltage	AC : 180-264V	IP Rating	IP20
Flux	4100lm	Dimension	ø90x212 mm
Beam Angle	270°	Dimmable	NO

SKU: 225    SKU: 226  
6000K    4500K

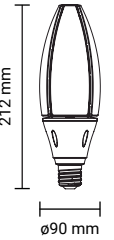

LED INDUSTRIAL Bulb **PF>0.9**  
**50W E40**



Product code	HB50-A3	Socket	E40
Watts	50W	CRI	Ra>70
Input Voltage	AC : 110-264V	IP Rating	IP20
Flux	5000lm	Dimension	ø75x235 mm
Beam Angle	270°	Dimmable	NO

SKU: 221  
6000K

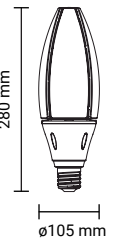



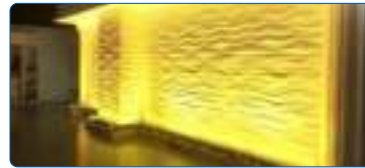

LED Wall Washers  
**30°**

**9W**  
 **700**  
Lumens

Product code	WW9-A1	Beam Angle	30°
Watts	9W	CRI	Ra>70
Input Voltage	AC : 220-240V	IP Rating	IP65
Flux	700lm	Body Color	Black

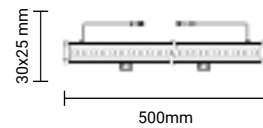

SKU: 7134    SKU: 7131  
6000K    2700K

**18W**  
 **1400**  
Lumens

Product code	WW18-A1	Beam Angle	30°
Watts	18W	CRI	Ra>70
Input Voltage	AC : 220-240V	IP Rating	IP65
Flux	1400lm	Protection	Black

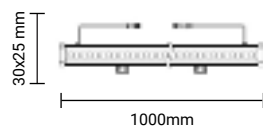

SKU: 7135    SKU: 7132  
6000K    2700K

**36W**  
 **2800**  
Lumens

Product code	WW36-A1	Beam Angle	30°
Watts	36W	CRI	Ra>70
Input Voltage	AC : 220-240V	IP Rating	IP65
Flux	2800lm	Protection	Black

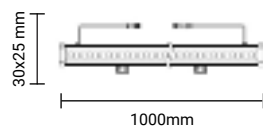

SKU: 7136    SKU: 7133  
6000K    2700K







## LED WALL AND STEP LIGHTS



You can even make your outdoor areas radiate in the worst of weather conditions: Our exterior use wall lights are robust, energy-efficient and powerful. You can choose between different designs and set stylish accents.

#### Features:

- Up to 80% power saving
- Home, garden or park use
- Different forms, shapes and colours
- Discrete, spot or main lighting
- Easy installation and long lifecycle
- With or without bulbs

#### Application:

- Wall or pylon mountable
- Lanes, alleys or pathways
- Gardens and parks







LED Wall Light - Black  
**2 Lens 4W**

**340**  
Lumens

48°

IP65

Watts	4W	CRI	Ra>80
Input Voltage	AC : 200-240V	IP Rating	IP65
Flux	340lm	Dimension	106x80x38 mm
Beam Angle	48°	Body Color	Black
Material	Aluminium	Dimmable	NO

SKU: 7407  
 3000K



LED Wall Light - Black  
**2 Lens 4W**

**340**  
Lumens

48°

IP65

Watts	4W	CRI	Ra>80
Input Voltage	AC : 200-240V	IP Rating	IP65
Flux	340lm	Dimension	106x80x38 mm
Beam Angle	48°	Body Color	White
Material	Aluminium	Dimmable	NO

SKU: 7408  
 3000K



LED Wall Light - Black  
**3 Lens 6W**

**510**  
Lumens

48°

IP65

Watts	6W	CRI	Ra>80
Input Voltage	AC : 200-240V	IP Rating	IP65
Flux	510lm	Dimension	158x80x40 mm
Beam Angle	48°	Body Color	Black
Material	Aluminium	Dimmable	NO

SKU: 7409  
 3000K



LED Wall Light - Black  
**3 Lens 6W**

**510**  
Lumens

48°

IP65

Watts	6W	CRI	Ra>80
Input Voltage	AC : 200-240V	IP Rating	IP65
Flux	510lm	Dimension	158x80x40 mm
Beam Angle	48°	Body Color	White
Material	Aluminium	Dimmable	NO

SKU: 7410  
 3000K



LED Wall Light - Black  
**2 Lens 8W**

**680**  
Lumens

48°

IP65

Watts	8W	CRI	Ra>80
Input Voltage	AC : 200-240V	IP Rating	IP65
Flux	680lm	Dimension	210x80x48 mm
Beam Angle	48°	Body Color	Black
Material	Aluminium	Dimmable	NO

SKU: 7411  
 3000K



LED Wall Light - Black  
**2 Lens 8W**

**680**  
Lumens

48°

IP65

Watts	8W	CRI	Ra>80
Input Voltage	AC : 200-240V	IP Rating	IP65
Flux	680lm	Dimension	210x80x48 mm
Beam Angle	48°	Body Color	White
Material	Aluminium	Dimmable	NO

SKU: 7412  
 3000K



**LED Wall Light**  
**12W**

Watts 12W  
 Input Voltage AC : 200-240V  
 Flux 600lm  
 Beam Angle 160°  
 Material Aluminium

SKU: 2095  
 3000K

CRI Ra>80  
 IP Rating IP20  
 Dimension 315x90x30mm  
 Body Color WHITE  
 Dimmable NO

600 Lumens  
 160°  
 IP20

**LED Wall Light**  
**12W**

Watts 12W  
 Input Voltage AC : 200-240V  
 Flux 600lm  
 Beam Angle 160°  
 Material Aluminium

SKU: 2096  
 3000K

CRI Ra>80  
 IP Rating IP20  
 Dimension 315x90x30mm  
 Body Color BLACK  
 Dimmable NO

600 Lumens  
 160°  
 IP20

**LED Solar Wall Light**  
**1W**

Watts 1W  
 Voltage 5.5V  
 Flux 60lm  
 Beam Angle 80°  
 Battery 3.7V/18Ah

SKU: 2085 6000K  
 SKU: 2086 4500K

CRI Ra>80  
 IP Rating IP44  
 Dimension ø85x238mm  
 Body Color White  
 Dimmable NO

Solar Power  
 60 Lumens  
 80°  
 IP44

**LED Solar Wall Light**  
**1W**

Watts 1W  
 Voltage 5.5V  
 Flux 60lm  
 Beam Angle 80°  
 Battery 3.7V/18Ah

SKU: 2087 6000K  
 SKU: 2088 4500K

CRI Ra>80  
 IP Rating IP44  
 Dimension ø85x238mm  
 Body Color Black  
 Dimmable NO

Solar Power  
 60 Lumens  
 80°  
 IP44



**LED Wall Light**  
**12W**

Watts 12W  
 Input Voltage AC : 200-240V  
 Flux 1200lm  
 Beam Angle 90°  
 Material Plastic

SKU: 2089  
 3000K

CRI Ra>80  
 IP Rating IP65  
 Dimension ø160x60mm  
 Body Color White  
 Dimmable NO

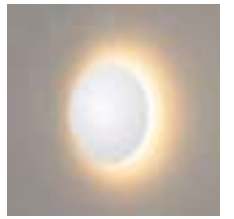
1200 Lumens  
 90°  
 IP65

**LED Wall Light**  
**12W**

Watts 12W  
 Input Voltage AC : 200-240V  
 Flux 1200lm  
 Beam Angle 90°  
 Material Plastic

SKU: 2090  
 3000K

CRI Ra>80  
 IP Rating IP65  
 Dimension ø160x60mm  
 Body Color BLACK  
 Dimmable NO

1200 Lumens  
 90°  
 IP65



**LED Wall Light - Aluminium**  
**12W**

Watts 12W  
 Input Voltage AC : 200-240V  
 Flux 670lm  
 Beam Angle 90°  
 Material Aluminium

SKU: 2091  
 3000K

CRI Ra>80  
 IP Rating IP65  
 Dimension ø150x46mm  
 Body Color WHITE  
 Dimmable NO

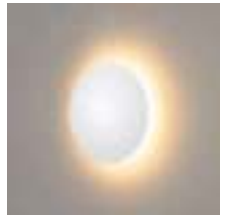
670 Lumens  
 90°  
 IP65

**LED Wall Light - Aluminium**  
**12W**

Watts 12W  
 Input Voltage AC : 200-240V  
 Flux 670lm  
 Beam Angle 90°  
 Material Aluminium

SKU: 2092  
 3000K

CRI Ra>80  
 IP Rating IP65  
 Dimension ø150x46mm  
 Body Color BLACK  
 Dimmable NO

670 Lumens  
 90°  
 IP65



LED Wall / Ceiling Light

**15W**



Watts 15W  
Input Voltage AC : 220-240V  
Flux 80lm  
Beam Angle 120°  
Shape Round

SKU: 7529    SKU: 7528  
■ 4200K    ■ 3000K

CRI Ra>80  
IP Rating IP65  
Dimension ø169x100 mm  
Body Color BLACK  
Dimmable NO

750 Lumens    120°    IP65

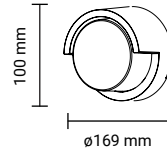

LED Solar Wall Light

**16W**



Watts 16W  
Input Voltage 220-240V  
Flux 1120lm  
Beam Angle 90°  
Material Aluminium  
CRI Ra>80  
IP Rating IP20  
Dimension 800x60x100mm  
Dimmable NO

SKU: 2093    SKU: 2094  
■ 4200K    ■ 3000K

1120 Lumens    90°    IP20



LED Wall / Ceiling Light

**15W**



Watts 15W  
Input Voltage AC : 220-240V  
Flux 80lm  
Beam Angle 120°  
Shape Square

SKU: 7531    SKU: 7530  
■ 4200K    ■ 3000K

CRI Ra>80  
IP Rating IP65  
Dimension 160x160x100 mm  
Body Color BLACK  
Dimmable NO

750 Lumens    120°    IP65

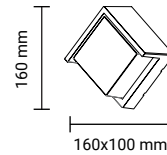

LED Wall Light

**9W**



Product code WL9-A1  
Watts 12W    CRI Ra>80  
Input Voltage AC : 200-240V    IP Rating IP54  
Flux 780lm    Dimension 230x110x76  
Beam Angle 6°    Body Color BLACK  
Shape Single Head    Dimmable NO

SKU: 7404    SKU: 7403  
■ 4000K    ■ 3000K

780 Lumens    6°    IP54



LED Wall / Ceiling Light

**15W**



Watts 15W  
Input Voltage AC : 220-240V  
Flux 1000lm  
Beam Angle 145°  
Shape Round

SKU: 7533    SKU: 7532  
■ 4200K    ■ 3000K

CRI Ra>80  
IP Rating IP65  
Dimension ø169x100 mm  
Body Color BLACK  
Dimmable NO

1000 Lumens    145°    IP65

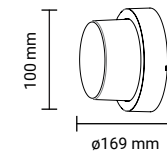

LED BULKHEAD WALL LIGHT

**12W**



Product code WL12-A3  
Watts 12W    CRI Ra>80  
Input Voltage AC : 220-240V    IP Rating IP65  
Flux 780lm    Dimension 230x110x76mm  
Beam Angle 120°    Body Color GREY  
Shape Rectangle    Dimmable NO

SKU: 7527    SKU: 7526  
■ 4200K    ■ 3000K

780 Lumens    120°    IP65



LED Wall / Ceiling Light

**15W**



Watts 15W  
Input Voltage AC : 220-240V  
Flux 1000lm  
Beam Angle 145°  
Shape Square

SKU: 7535    SKU: 7534  
■ 4200K    ■ 3000K

CRI Ra>80  
IP Rating IP65  
Dimension 160x160x100 mm  
Body Color BLACK  
Dimmable NO

1000 Lumens    145°    IP65

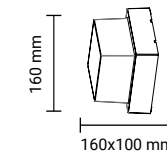

**LED Wall Light**  
**6W**

Watts	6W	CRI	Ra>80
Input Voltage	AC : 220-240V	IP Rating	IP54
Flux	660lm	Dimension	110x54x97
Beam Angle	120°	Body Color	WHITE
Shape	Single Head	Dimmable	NO

Rotatable 355°

 SKU: 7478    SKU: 7475  
 4000K    3000K

**LED Wall Light**  
**2x6W**

Watts	12W	CRI	Ra>80
Input Voltage	AC : 220-240V	IP Rating	IP54
Flux	1320lm	Dimension	221x54x97mm
Beam Angle	120°	Body Color	WHITE
Shape	Double Head	Dimmable	NO

Rotatable 355°

 SKU: 7484    SKU: 7481  
 4000K    3000K

**LED Wall Light**  
**6W**

Watts	6W	CRI	Ra>80
Input Voltage	AC : 220-240V	IP Rating	IP54
Flux	660lm	Dimension	110x54x97
Beam Angle	120°	Body Color	BLACK
Shape	Single Head	Dimmable	NO

Rotatable 355°

 SKU: 7479    SKU: 7476  
 4000K    3000K

**LED Wall Light**  
**2x6W**

Watts	12W	CRI	Ra>80
Input Voltage	AC : 220-240V	IP Rating	IP54
Flux	1320lm	Dimension	221x54x97mm
Beam Angle	120°	Body Color	BLACK
Shape	Double Head	Dimmable	NO

Rotatable 355°

 SKU: 7485    SKU: 7482  
 4000K    3000K

**LED Wall Light**  
**6W**

Watts	6W	CRI	Ra>80
Input Voltage	AC : 220-240V	IP Rating	IP54
Flux	660lm	Dimension	110x54x97
Beam Angle	120°	Body Color	GREY
Shape	Single Head	Dimmable	NO

Rotatable 355°

 SKU: 7480    SKU: 7477  
 4000K    3000K

**LED Wall Light**  
**2x6W**

Watts	12W	CRI	Ra>80
Input Voltage	AC : 220-240V	IP Rating	IP54
Flux	1320lm	Dimension	221x54x97mm
Beam Angle	120°	Body Color	GREY
Shape	Double Head	Dimmable	NO

Rotatable 355°

 SKU: 7486    SKU: 7483  
 4000K    3000K



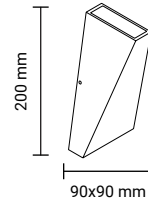

**LED Wall Light**  
**6W**

Watts	6W	CRI	Ra>80
Input Voltage	AC : 220-240V	IP Rating	IP54
Flux	660lm	Dimension	90x90x200mm
Beam Angle	Up 15°-Down 90°	Body Color	WHITE
Shape	Triangle	Dimmable	NO

 SKU: 7472    SKU: 7469  
 4200K    3000K

**LED Wall Light**  
**6W**

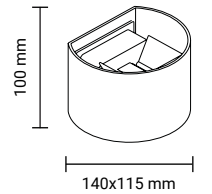
Watts	6W	CRI	Ra>80
Input Voltage	AC : 220-240V	IP Rating	IP54
Flux	660lm	Dimension	140x115x100mm
Beam Angle	0°- 90°	Body Color	WHITE
Shape	Round	Dimmable	NO

 SKU: 7466    SKU: 7463  
 4000K    3000K

**LED Wall Light**  
**6W**

Watts	6W	CRI	Ra>80
Input Voltage	AC : 220-240V	IP Rating	IP54
Flux	660lm	Dimension	90x90x200mm
Beam Angle	Up 15°-Down 90°	Body Color	BLACK
Shape	Triangle	Dimmable	NO

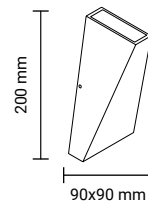
 SKU: 7473    SKU: 7470  
 4200K    3000K

**LED Wall Light**  
**6W**

Watts	6W	CRI	Ra>80
Input Voltage	AC : 220-240V	IP Rating	IP54
Flux	660lm	Dimension	140x115x100mm
Beam Angle	0°- 90°	Body Color	BLACK
Shape	Round	Dimmable	NO

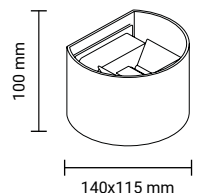
 SKU: 7467    SKU: 7464  
 4000K    3000K

**LED Wall Light**  
**6W**

Watts	6W	CRI	Ra>80
Input Voltage	AC : 220-240V	IP Rating	IP54
Flux	660lm	Dimension	90x90x200mm
Beam Angle	Up 15°-Down 90°	Body Color	GREY
Shape	Triangle	Dimmable	NO

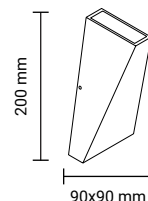
 SKU: 7474    SKU: 7471  
 4200K    3000K

**LED Wall Light**  
**6W**

Watts	6W	CRI	Ra>80
Input Voltage	AC : 220-240V	IP Rating	IP54
Flux	660lm	Dimension	140x115x100mm
Beam Angle	0°- 90°	Body Color	GREY
Shape	Round	Dimmable	NO

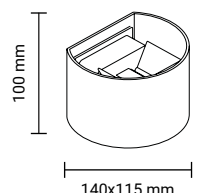
 SKU: 7468    SKU: 7465  
 4000K    3000K



LED Wall Light  
**6W**

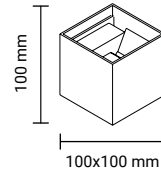

**WHITE**  
SKU: 7454    SKU: 7451  
4000K    3000K

**BLACK**  
SKU: 7455    SKU: 7452  
4000K    3000K

**GREY**  
SKU: 7456    SKU: 7453  
4000K    3000K

Watts	6W	CRI	Ra>80
Input Voltage	AC : 220-240V	IP Rating	IP54
Flux	660lm	Dimension	100x100 mm
Beam Angle	0°-90°	Body Colors	White ; Black ; Grey
Shape	Square	Dimmable	NO



LED Wall Light  
**4W-4 Beam**

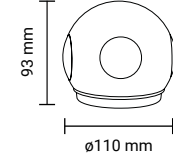

**WHITE**  
SKU: 7490    SKU: 7487  
4000K    3000K

**BLACK**  
SKU: 7491    SKU: 7488  
4000K    3000K

**GREY**  
SKU: 7492    SKU: 7489  
4000K    3000K

Watts	4W	CRI	Ra>80
Input Voltage	AC : 220-240V	IP Rating	IP54
Flux	440lm	Dimension	ø110x93 mm
Beam Angle	90°	Body Colors	White ; Black ; Grey
Shape	Round	Dimmable	NO



LED Wall Light  
**12W**

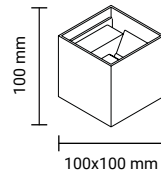

**WHITE**  
SKU: 7460    SKU: 7457  
4000K    3000K

**BLACK**  
SKU: 7461    SKU: 7458  
4000K    3000K

**GREY**  
SKU: 7462    SKU: 7459  
4000K    3000K

Watts	12W	CRI	Ra>80
Input Voltage	AC : 220-240V	IP Rating	IP54
Flux	1320lm	Dimension	100x100 mm
Beam Angle	0°-90°	Body Colors	White ; Black ; Grey
Shape	Square	Dimmable	NO



LED Wall Light  
**6W-2 Beam**

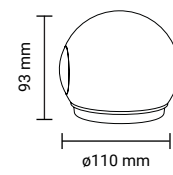

**WHITE**  
SKU: 7496    SKU: 7493  
4000K    3000K

**BLACK**  
SKU: 7497    SKU: 7494  
4000K    3000K

**GREY**  
SKU: 7498    SKU: 7495  
4000K    3000K

Watts	6W	CRI	Ra>80
Input Voltage	AC : 220-240V	IP Rating	IP54
Flux	660lm	Dimension	ø110x93 mm
Beam Angle	90°	Body Colors	White ; Black ; Grey
Shape	Round	Dimmable	NO

**LED STEP LIGHT**  
**2W Round**

Watts 2W  
 Input Voltage AC : 220-240V  
 Flux 80lm  
 Beam Angle 55°  
 Shape Round

CRI Ra>80  
 IP Rating IP65  
 Dimension  $\phi$ 150x27 mm  
 Body Color BLACK  
 Dimmable NO

SKU: 7504    SKU: 7503  
 4200K    3000K

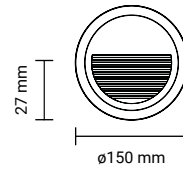
**LED STEP LIGHT**  
**2W Square**

Watts 2W  
 Input Voltage AC : 220-240V  
 Flux 80lm  
 Beam Angle 55°  
 Shape Square

CRI Ra>80  
 IP Rating IP65  
 Dimension 124x124x27mm  
 Body Color BLACK  
 Dimmable NO

SKU: 7510    SKU: 7509  
 4200K    3000K

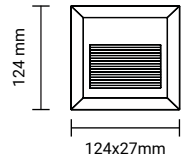
**LED STEP LIGHT**  
**2W Round**

Watts 2W  
 Input Voltage AC : 220-240V  
 Flux 80lm  
 Beam Angle 55°  
 Shape Round

CRI Ra>80  
 IP Rating IP65  
 Dimension  $\phi$ 150x27 mm  
 Body Color WHITE  
 Dimmable NO

SKU: 7506    SKU: 7505  
 4200K    3000K

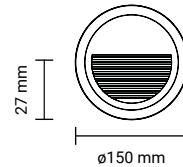
**LED STEP LIGHT**  
**2W Square**

Watts 2W  
 Input Voltage AC : 220-240V  
 Flux 80lm  
 Beam Angle 55°  
 Shape Square

CRI Ra>80  
 IP Rating IP65  
 Dimension 124x124x27mm  
 Body Color WHITE  
 Dimmable NO

SKU: 7512    SKU: 7511  
 4200K    3000K

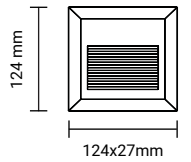
**LED STEP LIGHT**  
**2W Round**

Watts 2W  
 Input Voltage AC : 220-240V  
 Flux 80lm  
 Beam Angle 55°  
 Shape Round

CRI Ra>80  
 IP Rating IP65  
 Dimension  $\phi$ 150x27 mm  
 Body Color GREY  
 Dimmable NO

SKU: 7508    SKU: 7507  
 4200K    3000K

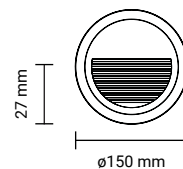
**LED STEP LIGHT**  
**2W Square**

Watts 2W  
 Input Voltage AC : 220-240V  
 Flux 80lm  
 Beam Angle 55°  
 Shape Square

CRI Ra>80  
 IP Rating IP65  
 Dimension 124x124x27mm  
 Body Color GREY  
 Dimmable NO

SKU: 7514    SKU: 7513  
 4200K    3000K

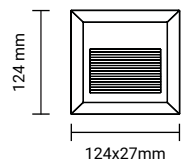



## LED STEP LIGHT

**3W Rectangular**

Watts	3W	CRI	Ra>80
Input Voltage	AC : 220-240V	IP Rating	IP65
Flux	150lm	Dimension	280x280x28 mm
Beam Angle	65°	Body Color	BLACK
Shape	Rectangular	Dimmable	NO

SKU: 7516    SKU: 7515  
 ■ 4200K    ■ 3000K

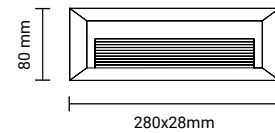

## LED STEP LIGHT

**3W Round**

Watts	3W	CRI	Ra>80
Input Voltage	AC : 220-240V	IP Rating	IP20
Flux	90lm	Dimension	ø80x51 mm
Beam Angle	34°	Body Color	WHITE
Shape	Round	Dimmable	NO

SKU: 7523    SKU: 7522  
 ■ 4200K    ■ 3000K

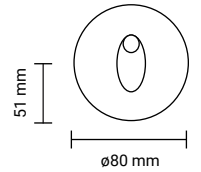

## LED STEP LIGHT

**3W Rectangular**

Watts	3W	CRI	Ra>80
Input Voltage	AC : 220-240V	IP Rating	IP65
Flux	150lm	Dimension	280x280x28 mm
Beam Angle	65°	Body Color	WHITE
Shape	Rectangular	Dimmable	NO

SKU: 7518    SKU: 7517  
 ■ 4200K    ■ 3000K

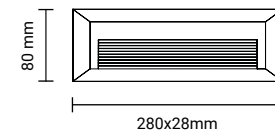

## LED STEP LIGHT

**3W Square**

Watts	3W	CRI	Ra>80
Input Voltage	AC : 220-240V	IP Rating	IP20
Flux	90lm	Dimension	80x80x51 mm
Beam Angle	34°	Body Color	WHITE
Shape	Square	Dimmable	NO

SKU: 7525    SKU: 7524  
 ■ 4200K    ■ 3000K

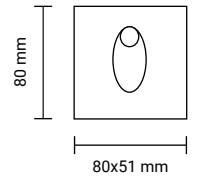

## LED STEP LIGHT

**3W Rectangular**

Watts	3W	CRI	Ra>80
Input Voltage	AC : 220-240V	IP Rating	IP65
Flux	150lm	Dimension	280x280x28 mm
Beam Angle	65°	Body Color	GREY
Shape	Rectangular	Dimmable	NO

SKU: 7520    SKU: 7519  
 ■ 4200K    ■ 3000K

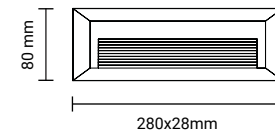

## LED STEP LIGHT

**3W Square**

Watts	3W	CRI	Ra>80
Input Voltage	AC : 220-240V	IP Rating	IP65
Flux	195lm	Dimension	84x27 mm
Beam Angle	58°	Body Color	WHITE
Shape	Square	Dimmable	NO

SKU: 7521  
 ■ 4200K

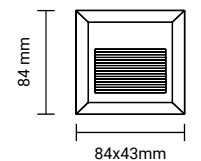

**LED CABINET LIGHT**  
**Slim Fit 1.5W**

Voltage	DC:5V	CRI	Ra>80
Flux	100lm	IP Rating	IP20
Beam Angle	120°	Body Color	Black
Battery	3.7V 0.9Ah	Dimension	240x40x10mm

 SKU: 240  

**LED CABINET LIGHT**  
**Slim Fit 1.5W**

Voltage	DC:5V	CRI	Ra>80
Flux	140lm	IP Rating	IP20
Beam Angle	120°	Body Color	Silver
Battery	3.7V 1.1Ah	Dimension	240x40x10mm

 SKU: 230   
 SKU: 231 

**LED CABINET LIGHT**  
**Slim Fit 1.5W**

Voltage	DC:5V	CRI	Ra>80
Flux	100lm	IP Rating	IP20
Beam Angle	120°	Body Color	Silver
Battery	3.7V 0.9Ah	Dimension	240x40x10mm

 SKU: 241  

**LED CABINET LIGHT**  
**Slim Fit 2.5W**

Voltage	DC:5V	CRI	Ra>80
Flux	200lm	IP Rating	IP20
Beam Angle	180°	Body Color	Silver
Battery	3.7V 2Ah	Dimension	240x40x10mm

 SKU: 232  
 CCT  



**LED CABINET LIGHT**  
**Slim Fit 3.5W**

Voltage	DC:5V	CRI	Ra>80
Flux	230lm	IP Rating	IP20
Beam Angle	120°	Body Color	Black
Battery	3.7V 2.2Ah	Dimension	600x40x10mm

 SKU: 242  

**LED CABINET LIGHT**  
**Magnetic Control 0.5W**

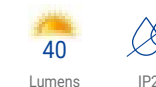
Voltage	DC:1.5V	CRI	Ra>80
Flux	40lm	IP Rating	IP20
Beam Angle	120°	Body Color	Silver
Battery	2*AAA	Dimension	64x43x15mm

 SKU: 233   
 SKU: 234 

**LED CABINET LIGHT**  
**Slim Fit 3.5W**

Voltage	DC:5V	CRI	Ra>80
Flux	230lm	IP Rating	IP20
Beam Angle	120°	Body Color	Silver
Battery	3.7V 2.2Ah	Dimension	600x40x10mm

 SKU: 243  

**LED CABINET LIGHT**  
**Hanging/Stand 0.5W**

Voltage	DC:1.5V	CRI	Ra>80
Flux	40lm	IP Rating	IP20
Beam Angle	120°	Body Color	Silver
Battery	3*AAA	Dimension	φ80x23mm

 SKU: 235   
 SKU: 236 



Step outside with our great range of outdoor lighting solutions. Whether you're looking to light up your garden with exterior use wall lights or increase your home's safety with security lights.

**Features:**

- Up to 80% power saving
- garden or park use
- Different forms, shapes and colours
- Discrete, spot or main lighting
- With or without bulbs

**Application:**

- Wall or pylon mountable
- Lanes, alleys or pathways
- Gardens and parks



LED OUTDOOR LIGHT

LED OUTDOOR LIGHT





LED SOLAR WALL LIGHT  
**Solar Panel Power: 5.5V 1.8W**



Voltage	5.5V	CRI	Ra>80
Flux	500lm	IP Rating	IP54
Beam Angle	60°	Body Color	Black
Battery	3.2V 2Ah	Dimension	160x130x28mm

SKU: 7541  
6000K



LED WALL LAMP 7W  
**Aluminium Body**

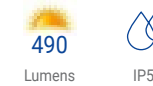

Power	7W	CRI	Ra>80
Voltage	AC: 220-240V	IP Rating	IP54
Flux	490lm	Body Color	Black
Beam Angle	60°	Dimension	160x130x28mm

SKU: 9343  
2700K



LED SOLAR WALL LIGHT  
**Solar Panel Power: 5.5V 5W**



Voltage	5.5V	CRI	Ra>80
Flux	1000lm	IP Rating	IP54
Beam Angle	60°	Body Color	Black
Battery	3.2V 4Ah	Dimension	350x140x28mm

SKU: 7542  
6000K



LED SOLAR WALL LIGHT  
**9W**

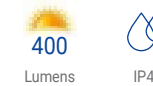

Voltage	5V	CRI	Ra>80
Flux	400lm	IP Rating	IP54
Beam Angle	110°	Body Color	Dark Grey
Battery	3.7V 2Ah	Dimension	160x130x190mm

SKU: 9345  
3000K



LED SOLAR WALL LIGHT  
**Solar Panel Power: 5V 12.5W**



Voltage	5V	CRI	Ra>80
Flux	1200lm	IP Rating	IP54
Beam Angle	60°	Body Color	Black
Battery	3.2V 6Ah	Dimension	350x266x28mm

SKU: 7543  
6000K



LED SOLAR WALL LIGHT  
**9W**

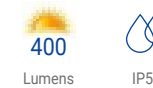

Voltage	5V	CRI	Ra>80
Flux	400lm	IP Rating	IP44
Beam Angle	110°	Body Color	Dark Grey
Battery	3.7V 2Ah	Dimension	180x120x127mm

SKU: 9347  
3000K





SKU: 7422 Stainless Steel



SKU: 7423 Stainless Steel

Wall Lamp Fitting  
**E27 Holder**

Product code	WL1-A1	IP Rating	IP44
Socket	E27	Dimension	303x100x91 mm
Input Voltage	AC : 220-240V	Body Colors	Stainless Steel
Material	Aluminium	Max Power	16W



E27 Holder



IP44

Wall Lamp Fitting  
**E27 Holder**

Product code	WL1-A1	IP Rating	IP44
Socket	E27	Dimension	245x180x93 mm
Input Voltage	AC : 220-240V	Body Colors	Black ; White
Material	Aluminium+Glass	Max Power	60W



E27 Holder



IP44

SKU: 7401 Black Body

SKU: 7402 White Body



LED Wall Light Fitting  
**GU10 Socket**

Product code	WL2-A3
Socket	GU10
Input Voltage	AC : 220-240V
Material	Aluminium

IP Rating	IP44
Dimension	100x66x92 mm
Body Colors	Black ; White ; Silver
Max Power	35W



GU10 Holder



IP44

SKU: 7443 Black Body

SKU: 7444 White Body

SKU: 7445 Silver Body



LED Wall Light Fitting  
**Two GU10 Sockets**

Product code	WL2-A4
Socket	2xGU10
Input Voltage	AC : 220-240V
Material	Aluminium

IP Rating	IP44
Dimension	92x68x150 mm
Body Colors	Black ; White ; Silver
Max Power	2x35W



GU10 Holder



IP44

SKU: 7446 Black Body

SKU: 7447 White Body

SKU: 7448 Silver Body

**LED Wall Light Fitting**  
**GU10 Socket**

Product code	WL2-A1	IP Rating	IP54
Socket	GU10	Dimension	92x68x80 mm
Input Voltage	AC : 220-240V	Body Colors	Black ; White ; Silver ; Polished
Material	Aluminium	Max Power	35W

SKU: 7431	Black Body
SKU: 7432	White Body
SKU: 7433	Silver Body
SKU: 7449	Polished

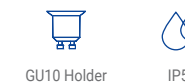
**LED Wall Light Fitting**  
**GU10 Socket**

Product code	WL2-A1	IP Rating	IP54
Socket	GU10	Dimension	100x66x92 mm
Input Voltage	AC : 220-240V	Body Colors	Black ; White ; Grey
Material	Aluminium	Max Power	35W

SKU: 7434	Black Body
SKU: 7435	White Body
SKU: 7436	Grey Body

**LED Wall Light Fitting**  
**Two GU10 Sockets**

Product code	WL2-A2	IP Rating	IP54
Socket	2xGU10	Dimension	92x68x150 mm
Input Voltage	AC : 220-240V	Body Colors	Black ; White ; Silver ; Polished
Material	Aluminium	Max Power	2x35W

SKU: 7437	Black Body
SKU: 7438	White Body
SKU: 7439	Silver Body
SKU: 7450	Polished

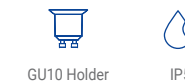
**LED Wall Light Fitting**  
**Two GU10 Sockets**

Product code	WL2-A2	IP Rating	IP54
Socket	2xGU10	Dimension	92x68x150 mm
Input Voltage	AC : 220-240V	Body Colors	Black ; White ; Grey
Material	Aluminium	Max Power	2x35W

SKU: 7440	Black Body
SKU: 7441	White Body
SKU: 7442	Grey Body





**LED SOLAR POWER GARDEN LIGHT**



LED SOLAR GARDEN LIGHT  
**Solar Panel Power: 5.5V 0.6W**



Voltage	5.5V	CRI	Ra>80
Flux	8lm	IP Rating	IP65
Beam Angle	120°	Body Color	Black
Battery	3.7V 2Ah	Dimension	165x165x31.5mm

Wall Mounted or Pin Mounted



LED SOLAR GARDEN LIGHT  
**Solar Panel Power: 5.5V 0.6W**



Voltage	5.5V	CRI	Ra>80
Flux	8lm	IP Rating	IP65
Beam Angle	120°	Body Color	Black
Battery	3.7V 2Ah	Dimension	165x165x31.5mm

Wall Mounted or Pin Mounted



LED Light Fixture  
**GU10 Socket**



Product code	WL2-A2	IP Rating	IP65
Socket	1xGU10	Dimension	92x68x150 mm
Input Voltage	AC : 220-240V	Body Colors	Black
Material	PC	Max Power	35W

SKU: 2084 GU10-Black



LED SOLAR LAMP  
**1.5W Lawn Light**

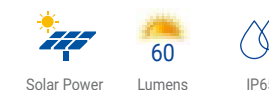

Watts	1.5W	CRI	Ra>80
Voltage	6V	IP Rating	IP65
Flux	60lm	Material	Aluminium
Beam Angle	110°	Body Color	Black
Battery	1.2V/1500mAh	Dimension	168x75.5x340 mm

- SKU: 9321 6000K
- SKU: 9322 3000K
- SKU: 9323 Blue Light
- SKU: 9324 Green Light

CHARGING TIME~(7-8) Hours  
DETECTION RANGE~8±2m



LED SOLAR LAMP  
**0.75W Wall Light**



Product code	WL2-A6	CRI	Ra>80
Watts	0.75W	IP Rating	IP54
Voltage	5.5V	Material	ABS+PC
Flux	110lm	Body Color	Black
Beam Angle	110°	Dimension	124x95x48mm
Battery	1200mAh		

SKU: 7405 White Light 6000K

CHARGING TIME~(7-8) Hours  
DETECTION RANGE~8±2m



LED SOLAR LAMP  
**1.5W Wall Light**



Product code	WL5-A6	CRI	Ra>80
Watts	1.5W	IP Rating	IP54
Voltage	7.4V	Material	ABS+PC
Flux	150lm	Body Color	Black
Beam Angle	110°	Dimension	196x115x45mm
Battery	1200mAh		

SKU: 7406 6000K

CHARGING TIME~(7-8) Hours  
DETECTION RANGE~8±2m



LED SOLAR GARDEN LIGHT  
**Solar Panel Power: 5.5V 1W**

60 Lumens IP54

Voltage	5.5V	CRI	Ra>80
Flux	60lm	IP Rating	IP54
Beam Angle	270°	Body Color	Black
Battery	3.7V 1.2Ah	Dimension	180x116x740mm

Table Way or Pin Mounted

SKU: 9349  
CCT  
6000K 4000K 3000K



LED SOLAR WALL LIGHT  
**0.5W**

40 Lumens IP44

Voltage	3.7V	CRI	Ra>80
Flux	40lm	IP Rating	IP44
Beam Angle	120°	Body Color	Black
Battery	3.7V 1.2Ah	Dimension	105x70x40mm

SKU: 9352  
3000K

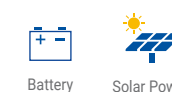

LED SOLAR GARDEN LIGHT  
**Solar Panel Power: 5.5V 1W**

60 Lumens IP54

Voltage	5.5V	CRI	Ra>80
Flux	60lm	IP Rating	IP54
Beam Angle	270°	Body Color	Black
Battery	3.7V 1.2Ah	Dimension	230x116x150mm

Table Way or Wall Mounted

SKU: 9350  
CCT  
6000K 4000K 3000K

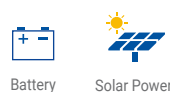

LED SOLAR LIGHT SPIKE  
**2W**

160 Lumens IP65

Voltage	3.7V	CRI	Ra>80
Flux	160lm	IP Rating	IP65
Beam Angle	120°	Body Color	Black
Battery	3.7V 1.8Ah	Dimension	102x169x313mm

Light Brigness Control

SKU: 9353  
3000K

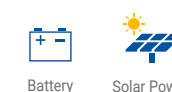

LED SOLAR GARDEN LIGHT  
**Solar Panel Power: 5V 1.8W**

70 Lumens IP54

Voltage	5.5V	CRI	Ra>80
Flux	70lm	IP Rating	IP54
Beam Angle	270°	Body Color	Black
Battery	3.7V 1.2Ah	Dimension	160x160x213mm

Remote Control

SKU: 9351  
CCT  
6000K 4000K 3000K

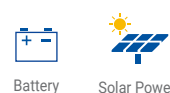

LED SOLAR LIGHT SPIKE  
**1W**

80 Lumens IP65

Voltage	3.7V	CRI	Ra>80
Flux	80lm	IP Rating	IP65
Beam Angle	120°	Body Color	Black
Battery	3.7V 1.2Ah	Dimension	φ130x395mm

Light Brigness Control

SKU: 9354  
3000K

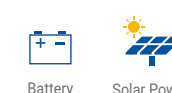



LED SOLAR LIGHT SPIKE  
**Solar Panel Power: 5V 1W**

90 Lumens IP65

Voltage	3.2V	CRI	Ra>80
Flux	90lm	IP Rating	IP65
Beam Angle	60°	Body Color	Black
Battery	3.2V 1.2Ah	Dimension	φ126x51.8mm

SKU: 9357  
6000K



2 PCS  
Box



LED LAWN LIGHT 7W  
**Aluminium Body**

490 Lumens IP54

Power	7W	CRI	Ra>80
Voltage	AC: 220-240V	IP Rating	IP54
Flux	490lm	Body Color	Dark Grey
Beam Angle	150°	Dimension	φ123x800mm

SKU: 9344  
3000K



LED SOLAR LAMP  
**9W**

400 Lumens IP44

Voltage	3.7V	CRI	Ra>80
Flux	400lm	IP Rating	IP44
Beam Angle	110°	Body Color	Dark Grey
Battery	3.7V 2Ah	Dimension	150x195x762mm

SKU: 9346  
3000K



LED SOLAR LIGHT SPIKE  
**Solar Panel Power: 5V 1W**

90 Lumens IP65

Voltage	3.2V	CRI	Ra>80
Flux	90lm	IP Rating	IP65
Beam Angle	60°	Body Color	Black
Battery	3.2V 1.2Ah	Dimension	φ126x51.8mm

SKU: 9358  
4000K



2 PCS  
Box



LED SOLAR LIGHT SPIKE  
**Solar Panel Power: 5V 1W**

90 Lumens IP65

Voltage	3.2V	CRI	Ra>80
Flux	90lm	IP Rating	IP65
Beam Angle	60°	Body Color	Black
Battery	3.2V 1.2Ah	Dimension	φ126x51.8mm

SKU: 9359  
RGB



2 PCS  
Box



LED SOLAR LAMP  
**9W**

400 Lumens IP44

Voltage	3.7V	CRI	Ra>80
Flux	400lm	IP Rating	IP44
Beam Angle	110°	Body Color	Dark Grey
Battery	3.7V 2Ah	Dimension	150x195x762mm

SKU: 9348  
3000K



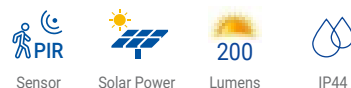

**LED SOLAR LAMP**  
**2W Wall Light**

Watts	2W	CRI	Ra>80
Voltage	3.7V	IP Rating	IP44
Flux	200lm	Material	Aluminium
Beam Angle	110°	Body Color	SS Brushed
Battery	3.7V/1200mAh	Dimension	142x125x188mm

 SKU: 9331  
 ■ 3000K

 CHARGING TIME~(7-8) Hours  
 DETECTION RANGE~8±2m

**LED SOLAR LAMP**  
**4.4W Wall Light**

Watts	4.4W	CRI	Ra>80
Voltage	3.7V	IP Rating	IP44
Flux	600lm	Material	Aluminium
Beam Angle	110°	Body Color	SS Brushed
Battery	3.7V/2600mAh	Dimension	173x160x155mm

 SKU: 9334  
 ■ 3000K

 CHARGING TIME~(7-8) Hours  
 DETECTION RANGE~8±2m

**LED SOLAR LAMP**  
**2W Lawn Spike**

Watts	2W	CRI	Ra>80
Voltage	3.7V	IP Rating	IP44
Flux	200lm	Material	Aluminium
Beam Angle	110°	Body Color	SS Brushed
Battery	3.7V/1200mAh	Dimension	125x125x500mm

 SKU: 9332  
 ■ 3000K

 CHARGING TIME~(7-8) Hours  
 DETECTION RANGE~8±2m

**LED SOLAR LAMP**  
**4.4W Lawn Spike**

Watts	4.4W	CRI	Ra>80
Voltage	3.7V	IP Rating	IP44
Flux	600lm	Material	Aluminium
Beam Angle	110°	Body Color	SS Brushed
Battery	3.7V/2600mAh	Dimension	160x160x500mm

 SKU: 9335  
 ■ 3000K

 CHARGING TIME~(7-8) Hours  
 DETECTION RANGE~8±2m

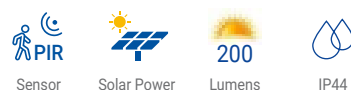
**LED SOLAR LAMP**  
**2W Lawn Light**

Watts	2W	CRI	Ra>80
Voltage	3.7V	IP Rating	IP44
Flux	200lm	Material	Aluminium
Beam Angle	110°	Body Color	SS Brushed
Battery	3.7V/1200mAh	Dimension	125x125x800mm

 SKU: 9333  
 ■ 3000K

 CHARGING TIME~(7-8) Hours  
 DETECTION RANGE~8±2m

**LED SOLAR LAMP**  
**4.4W Lawn Light**

Watts	4.4W	CRI	Ra>80
Voltage	3.7V	IP Rating	IP44
Flux	600lm	Material	Aluminium
Beam Angle	110°	Body Color	SS Brushed
Battery	3.7V/2600mAh	Dimension	142x125x188mm

 SKU: 9336  
 ■ 3000K

 CHARGING TIME~(7-8) Hours  
 DETECTION RANGE~8±2m

**LED SOLAR LAMP**  
**4.4W Wall Light**

Watts	4.4W	CRI	Ra>80
Voltage	3.7V	IP Rating	IP44
Flux	600lm	Material	Aluminium
Beam Angle	110°	Body Color	SS Brushed
Battery	3.7V/2600mAh	Dimension	162x150x155mm

 SKU: 9337  
 3000K

 CHARGING TIME~(7-8) Hours  
 DETECTION RANGE~8±2m

**LED SOLAR LAMP**  
**6W Wall Light**

Watts	6W	CRI	Ra>80
Voltage	3.7V	IP Rating	IP44
Flux	600lm	Material	Aluminium
Beam Angle	110°	Body Color	Black
Battery	3.7V/2200mAh	Dimension	173x160x155mm

 SKU: 9340  
 6000K

 CHARGING TIME~(7-8) Hours  
 DETECTION RANGE~8±2m

**LED SOLAR LAMP**  
**4.4W Lawn Spike**

Watts	4.4W	CRI	Ra>80
Voltage	3.7V	IP Rating	IP44
Flux	600lm	Material	Aluminium
Beam Angle	110°	Body Color	SS Brushed
Battery	3.7V/2600mAh	Dimension	150x150x500mm

 SKU: 9338  
 3000K

 CHARGING TIME~(7-8) Hours  
 DETECTION RANGE~8±2m

**LED SOLAR LAMP**  
**6W Lawn Light 50cm**

Watts	6W	CRI	Ra>80
Voltage	3.7V	IP Rating	IP44
Flux	600lm	Material	Aluminium
Beam Angle	110°	Body Color	Black
Battery	3.7V/2200mAh	Dimension	150x150x500mm

 SKU: 9341  
 6000K

 CHARGING TIME~(7-8) Hours  
 DETECTION RANGE~8±2m

**LED SOLAR LAMP**  
**4.4W Lawn Light**

Watts	4.4W	CRI	Ra>80
Voltage	3.7V	IP Rating	IP44
Flux	600lm	Material	Aluminium
Beam Angle	110°	Body Color	SS Brushed
Battery	3.7V/2600mAh	Dimension	150x150x800mm

 SKU: 9339  
 3000K

 CHARGING TIME~(7-8) Hours  
 DETECTION RANGE~8±2m

**LED SOLAR LAMP**  
**6W Lawn Light 90cm**



Watts	6W	CRI	Ra>80
Voltage	3.7V	IP Rating	IP44
Flux	600lm	Material	Aluminium
Beam Angle	110°	Body Color	Black
Battery	3.7V/2200mAh	Dimension	150x150x900mm

 SKU: 9342  
 6000K

 CHARGING TIME~(7-8) Hours  
 DETECTION RANGE~8±2m

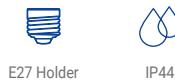

Wall Lamp Up  
**E27 Holder**



Product code	GD1-A1	IP Rating	IP44
Socket	E27	Dimension	215x170x220 mm
Input Voltage	AC : 220-240V	Body Colors	Black ; White
Material	Aluminium+PC	Max Power	60W

SKU: 9301 Black Body  
 SKU: 9302 White Body



Stand Lamp  
**E27 Holder**



Product code	GD1-A2	IP Rating	IP44
Socket	E27	Dimension	170x170x290 mm
Input Voltage	AC : 220-240V	Body Colors	Black ; White
Material	Aluminium+PC	Max Power	60W

SKU: 9305 Black Body  
 SKU: 9306 White Body



Wall Lamp Down  
**E27 Holder**



Product code	GD1-A1	IP Rating	IP44
Socket	E27	Dimension	215x170x220 mm
Input Voltage	AC : 220-240V	Body Colors	Black ; White
Material	Aluminium+PC	Max Power	60W

SKU: 9303 Black Body  
 SKU: 9304 White Body



Ceiling Lamp  
**E27 Holder**



Product code	GD1-A3	IP Rating	IP44
Socket	E27	Dimension	170x170x740 mm
Input Voltage	AC : 220-240V	Body Colors	Black ; White
Material	Aluminium+PC	Max Power	60W

SKU: 9307 Black Body  
 SKU: 9308 White Body





Lawn Lamp 60cm  
**E27 Holder**

Product code	GD1-A1	IP Rating	IP44
Socket	E27	Dimension	170x170x600 mm
Input Voltage	AC : 220-240V	Body Colors	Black ; White
Material	Aluminium+PC	Max Power	60W



SKU: 9309 Black Body  
SKU: 9310 White Body



Lawn Lamp 90cm  
**E27 Holder**

Product code	GD1-A1	IP Rating	IP44
Socket	E27	Dimension	170x170x900 mm
Input Voltage	AC : 220-240V	Body Colors	Black ; White
Material	Aluminium+PC	Max Power	60W



SKU: 9311 Black Body  
SKU: 9312 White Body



Lawn Lamp  
**E27 Holder**

Product code	GD1-A7	IP Rating	IP54
Socket	E27	Dimension	76x76x800/1000 mm
Input Voltage	AC : 220-240V	Body Colors	Grey
Material	Aluminium+PC	Max Power	16W



SKU: 9315 Grey Body 80cm  
SKU: 9316 Grey Body 100cm



1W



7W



1W



1.3W

Powerful LED Pond Wall Lights

**LED Light 1.3W ; 7W**

Product code	UN1-A5	IP Rating	IP68
Power	1.3W ; 7W	Dimension	60 x 60 x 78 mm
Voltage	DC:24V		

80lm/W Lumens

- SKU: 590 1W 3000K
- SKU: 856 7W 4200K

Decorative Mini LED Pond Wall Lights

**LED Light 1-1.3W**

Product code	UN1-A6	IP Rating	IP68
Power	1W -1.3W	Dimension	35 x 28 mm
Voltage	DC:24V		

80lm/W Lumens

- SKU: 591 RGB
- SKU: 594 6000K
- SKU: 595 3000K



1W



1.3W

Mini Wall & Floor Lights

**LED Light 1.2W**

Product code	UN1-A5	IP Rating	IP68
Power	1.2W	Dimension	38 x 30 mm
Voltage	DC:24V		

80lm/W Lumens

- SKU: 586 6000K
- SKU: 587 3000K
- SKU: 588 Blue
- SKU: 589 RGB

Powerful LED Pond Wall Light

**LED Light 1W-1.3W**

Product code	UN1-A9	IP Rating	IP68
Power	1W-1.3W	Dimension	32 x 44 mm
Voltage	DC:24V		

80lm/W Lumens

- SKU: 565 RGB
- SKU: 566 Blue
- SKU: 567 Green
- SKU: 568 Amber



1 Side Beam



2 Side Beam



1W



1.3W

Mini Directional Ground Lights

**LED Light 1.3W**

Product code	UN1-A8	IP Rating	IP68
Power	1.3W	Dimension	44 x 43 mm
Voltage	DC:24V		



- SKU: 596 ■ 6000K 1 Side Beam
- SKU: 597 ■ 3000K 1 Side Beam
- SKU: 598 ■ 6000K 2 Side Beam
- SKU: 599 ■ 3000K 2 Side Beam

LED Mini Floor Lights

**LED Light 1-1.3W**

Product code	UN1-A3	IP Rating	IP68
Power	1W -1.3W	Dimension	23 x 40 mm
Voltage	DC:24V		



- SKU: 580 1W ■ 6000K
- SKU: 581 1W ■ 3000K
- SKU: 582 1W ■ Blue
- SKU: 583 1.3W ■ 6000K
- SKU: 584 1.3W ■ 3000K
- SKU: 585 1.3W ■ Blue



LED Spike Lights  
**LED Light 1.3W**

Product code	UN1-A5	IP Rating	IP68
Power	1.3W	Dimension	38 x 30 mm
Voltage	DC:24V		



- SKU: 866 ■ 6000K
- SKU: 867 ■ 4000K
- SKU: 868 ■ 3000K



**Sleeve for LED Underground Lights**

- SKU: 873 Size - 22\*55MM
- SKU: 872 Size - 55\*150MM
- SKU: 874 Size - 35\*150MM



Mini Ground Lights  
**HALF-SHADING 1.3W**

Product code	UN1-A6	IP Rating	IP68
Power	1.3W	Dimension	60 x 45 mm
Voltage	DC:24V		

- SKU: 592 ■ 6000K
- SKU: 593 ■ 3000K



Mini Recessed Wall Lights  
**LED Light 1W**

Product code	UN1-A6	IP Rating	IP44
Power	1W	Dimension	64 x 43 mm
Voltage	DC:24V		

- SKU: 863 ■ 6000K
- SKU: 864 ■ 4000K
- SKU: 865 ■ 3000K
- SKU: 879 ■ Blue







**LED Pool Light  
12W PAR56**

**1200**  
Lumens
 90°
 IP68

Product code	PL12-A1	CRI	Ra>80
Watts	12W	IP Rating	IP68
Input Voltage	AC/DC :12V	Dimension	ø178x114 mm
Flux	1200lm	Body	Glass
Beam Angle	90°	Dimmable	NO
Socket	PAR56		

SKU: 571 ■ 6000K  
SKU: 572 ■ 2700K

**OSRAM**  
Chips



With Remote

**LED Pool Light  
12W PAR56**

**1200**  
Lumens
 90°
 IP68

Product code	PL12-A1	CRI	Ra>80
Watts	12W	IP Rating	IP68
Input Voltage	AC/DC :12V	Dimension	ø178x114 mm
Flux	1200lm	Body	Glass
Beam Angle	90°	Dimmable	NO
Socket	PAR56		

SKU: 573 ■ ■ RGB

**EPISTAR**  
Chips



**LED Outdoor Light  
1W Spotlight**

**80**  
Lumens
 18°
 IP65

Watts	1W	CRI	Ra>80
Input Voltage	AC : 220-245V	IP Rating	IP65
Flux	80lm	Dimension	ø65x78mm
Beam Angle	18°	Body Color	Stainless steel

SKU: 507 ■ 6000K  
SKU: 517 ■ 2800K

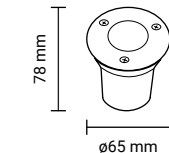

**LED Outdoor Light  
3W Spotlight**

**240**  
Lumens
 18°
 IP65

Watts	3W	CRI	Ra>80
Input Voltage	AC : 220-245V	IP Rating	IP65
Flux	240lm	Dimension	ø100x82mm
Beam Angle	18°	Body Color	Stainless steel

SKU: 501 ■ 6000K  
SKU: 502 ■ 2800K

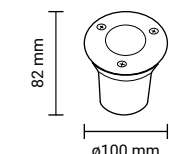

**LED Outdoor Light  
5W Spotlight**

**400**  
Lumens
 18°
 IP65

Watts	5W	CRI	Ra>80
Input Voltage	AC : 220-245V	IP Rating	IP65
Flux	400lm	Dimension	ø140x93 mm
Beam Angle	18°	Body Color	Stainless steel

SKU: 515 ■ 6000K  
SKU: 516 ■ 2800K

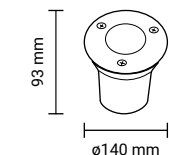

**LED Outdoor Light  
7W Spotlight**

**560**  
Lumens
 18°
 IP65

Watts	7W	CRI	Ra>80
Input Voltage	AC : 220-245V	IP Rating	IP65
Flux	560lm	Dimension	ø150x93 mm
Beam Angle	18°	Body Color	Stainless steel

SKU: 550 ■ 6000K  
SKU: 551 ■ 2800K

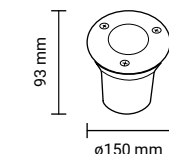

Outdoor Solar String Lights



Outdoor Solar String Lights- Milky  
**G50 Bulbs 20 pcs -10 Meters**

SKU: 9092  
2700K

128  
Lumens

Solar Power

IP65



Battery  
**3.7V 0.5Ah**



Outdoor Solar String Lights- Clear  
**G50 Bulbs 20 pcs -10 Meters**

SKU: 9093  
2700K

128  
Lumens

Solar Power

IP65



Battery  
**3.7V 0.5Ah**



Outdoor Solar String Lights- Milky  
**G50 Bulbs 20 pcs - 7 Meters**  
**- 8 Modes**

SKU: 9094  
2700K

200  
Lumens

Solar Power

IP65



Battery  
**3.7V 0.5Ah**



Outdoor Solar String Lights- Clear  
**G50 Bulbs 20 pcs - 7 Meters**  
**- 8 Modes**

SKU: 9095  
2700K

200  
Lumens

Solar Power

IP65



Battery  
**3.7V 0.5Ah**





Outdoor String Lights

**E27 Holders** OT1-A3

- \* 6 or 14.4 Meters Long String
- \* 10 or 15 Pcs E27 Sockets
- \* Up to 5A
- \* Suspended Sockets
- \* IP65
- \* Black Color

SKU: 5054 10pcs E27 - 6m  
SKU: 5051 15pcs E27 - 14.4m



Linkable up to 2 Strings

Outdoor String Lights

**Colourful Bulbs**

- \* 8 or 13 Meters Long String
- \* 10 or 20 Bulbs included
- \* 0.5 Watts Per Bulb
- \* IP65
- \* Black Color

SKU: 5056 10pcs Bulbs - 8m - 3W Colourful Bulbs  
SKU: 5092 20pcs Bulbs - 13m - 6W Colourful Bulbs



Outdoor String Lights

**E27 Holders** OT1-A3

- \* 6 or 14.4 Meters Long String
- \* 10 or 15 Pcs E27 Sockets
- \* Up to 5A
- \* Fixed Sockets
- \* IP65
- \* White Color

SKU: 5055 10pcs E27 - 6m  
SKU: 5053 15pcs E27 - 14.4m



Linkable up to 2 Strings

Outdoor String Lights

**Colourful Bulbs**

- \* 8 or 13 Meters Long String
- \* 10 or 20 Bulbs included
- \* 0.5 Watts Per Bulb
- \* IP65
- \* White Color

SKU: 5090 10pcs Bulbs - 8m - 3W Colourful Bulbs  
SKU: 5095 20pcs Bulbs - 13m - 6W Colourful Bulbs



Outdoor String Lights

**E27 Holders** OT1-A3

- \* 14.4 Meters Long String
- \* 15 Pcs E27 Sockets
- \* Up to 5A
- \* Fixed Sockets
- \* IP65
- \* Black Color

SKU: 5052 15pcs E27 - 14.4m



Linkable up to 2 Strings

Outdoor String Lights

**With Bulbs**

- \* 8 or 13 Meters Long String
- \* 10 or 20 Bulbs included
- \* 0.5 Watts Per Bulb
- \* IP65
- \* Black Color

SKU: 5057 10pcs Bulbs - 8m - 3W 6000K  
SKU: 5058 10pcs Bulbs - 8m - 3W 2700K  
SKU: 5093 20pcs Bulbs - 13m - 6W 6000K  
SKU: 5094 20pcs Bulbs - 13m - 6W 2700K



Linkable up to 2 Strings

Outdoor String Lights

**With Bulbs**

- \* 8 or 13 Meters Long String
- \* 10 or 20 Bulbs included
- \* 0.5 Watts Per Bulb
- \* IP65
- \* White Color

SKU: 5091 10pcs Bulbs - 8m - 3W 2700K  
SKU: 5096 20pcs Bulbs - 13m - 6W 2700K





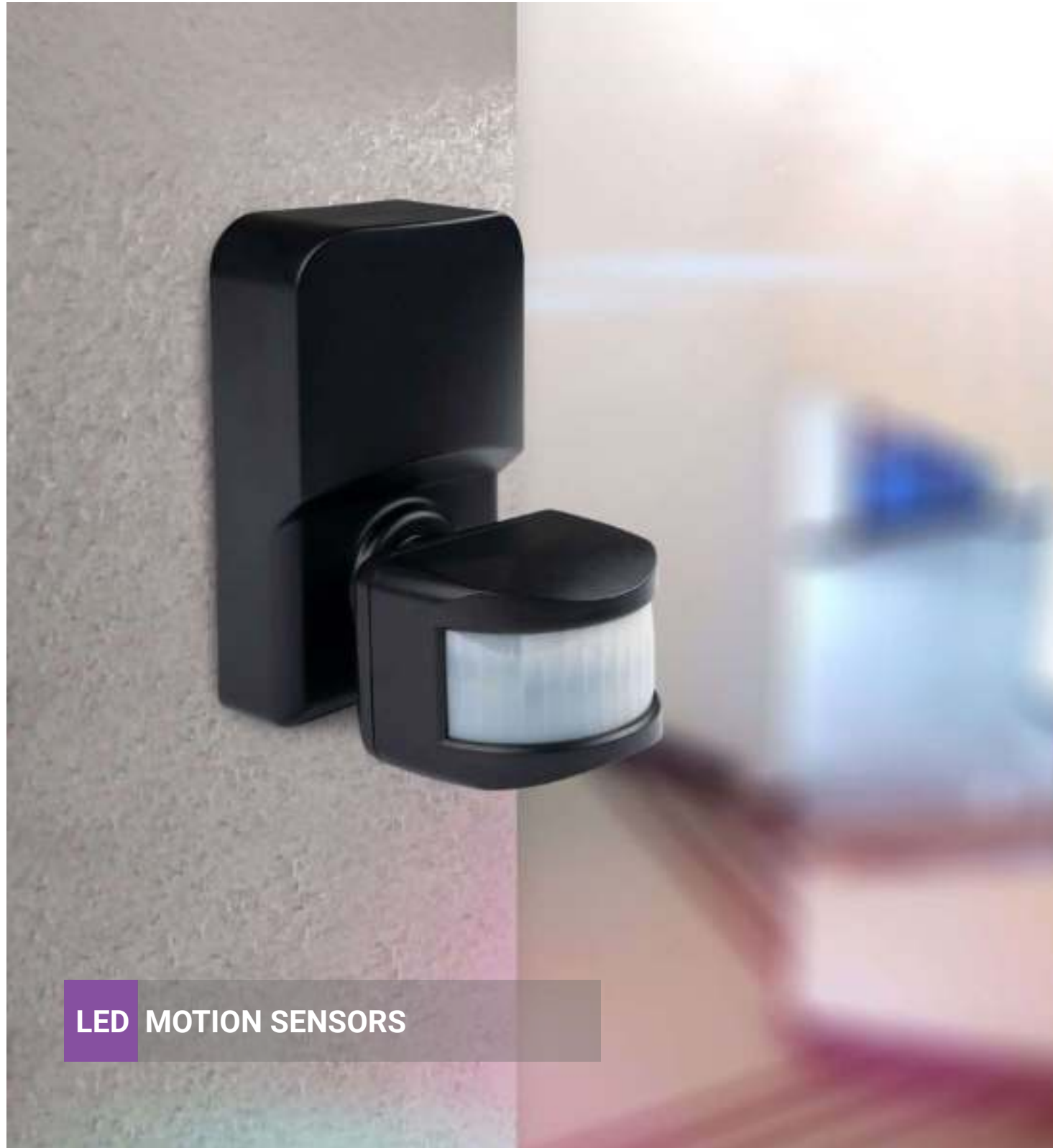

A universe of possibilities when combining the existing lighting solutions with various detecting devices to further enable energy saving and efficiency.

Features:

- Up to 80% power saving
- Home, office, garden or park use
- Different forms, shapes and colours
- Easy installation and long lifecycle

Application:

- Wall or pylon mountable

LED MOTION SENSORS

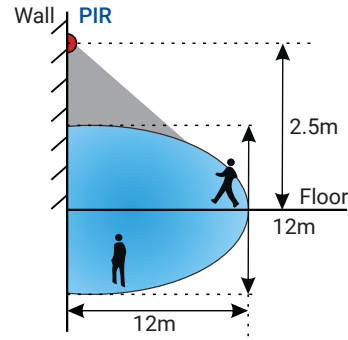

**PIR Motion Sensor**

Product code	SE1-A1	Body Color	White
Input Voltage	AC:110-240V	Class	II
Beam Angle	180°	Time	10sec-7min
Range	12m Max	Max Power	300W LED
Frequency	50-60 Hz	Ambient Light	<10Lux-2000Lux
Working Temp.	-30°C/+50°C	Material	Plastic+ALU
IP Rating	IP44	Dimension	ø65x86.5mm



SKU: 7301 White Body

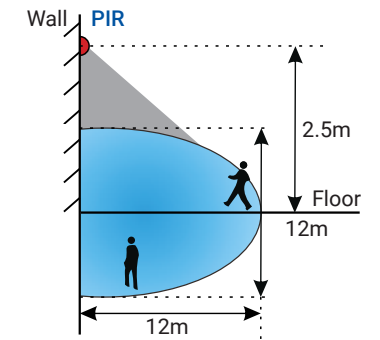

**PIR Motion Sensor**

Product code	SE1-A3	Body Color	White
Input Voltage	AC:110-240V	Class	II
Beam Angle	180°	Time	10sec-7min
Range	12m Max	Max Power	200W LED
Frequency	50-60 Hz	Ambient Light	<10Lux-2000Lux
Working Temp.	-30°C/+50°C	Material	Plastic+ALU
IP Rating	IP54	Dimension	ø77x70mm



SKU: 7306 White Body

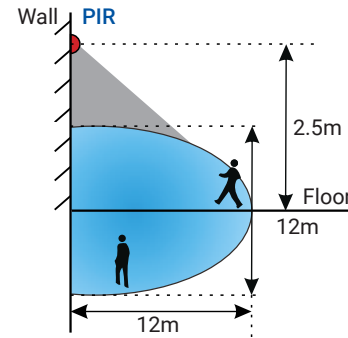

**PIR Motion Sensor**

Product code	SE1-A1	Body Color	Black
Input Voltage	AC:110-240V	Class	II
Beam Angle	180°	Time	10sec-7min
Range	12m Max	Max Power	300W LED
Frequency	50-60 Hz	Ambient Light	<10Lux-2000Lux
Working Temp.	-30°C/+50°C	Material	Plastic+ALU
IP Rating	IP44	Dimension	ø65x86.5mm



SKU: 7302 Black Body 3800156673021

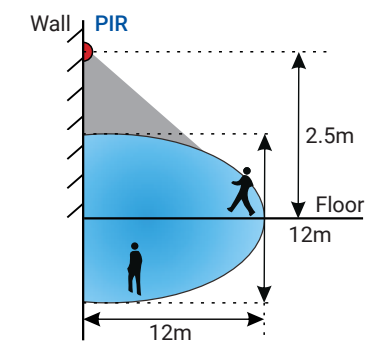

**PIR Motion Sensor**

Product code	SE1-A3	Body Color	Black
Input Voltage	AC:110-240V	Class	II
Beam Angle	180°	Time	10sec-7min
Range	12m Max	Max Power	200W LED
Frequency	50-60 Hz	Ambient Light	<10Lux-2000Lux
Working Temp.	-30°C/+50°C	Material	Plastic+ALU
IP Rating	IP54	Dimension	ø77x70mm



SKU: 7307 Black Body

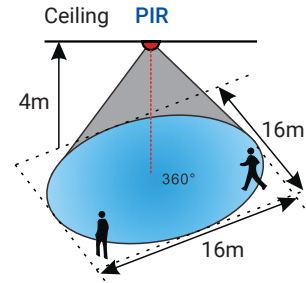

**PIR Motion Sensor**

Product code	SE1-A2	Body Color	White
Input Voltage	AC:110-240V	Class	II
Beam Angle	360°	Time	10sec-7min
Range	16m Max	Max Power	300W LED
Frequency	50-60 Hz	Ambient Light	<10Lux-2000Lux
Working Temp.	-30°C/+50°C	Material	Plastic+ALU
IP Rating	IP20	Dimension	∅88x55.5mm



SKU: 7305    White Body

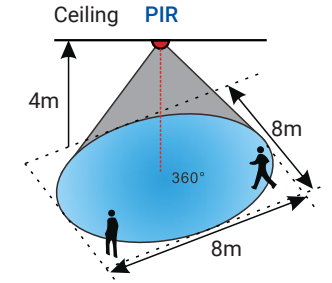

**PIR Motion Sensor**

Product code	SE1-A2	Body Color	White
Input Voltage	AC:110-240V	Class	II
Beam Angle	360°	Time	10sec-7min
Range	8m Max	Max Power	1000W LED
Frequency	50-60 Hz	Ambient Light	<10Lux-2000Lux
Working Temp.	-30°C/+50°C	Material	Plastic+ALU
IP Rating	IP20	Dimension	∅108x25mm



SKU: 7310    White Body

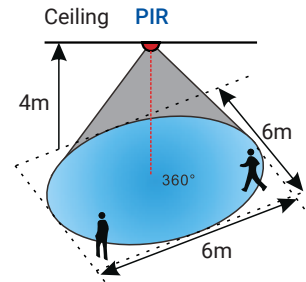

**PIR Motion Sensor**

Product code	SE1-A2	Body Color	White
Input Voltage	AC:220-240V	Class	II
Beam Angle	360°	Time	10sec-7min
Range	6m Max	Max Power	300W LED
Frequency	50-60 Hz	Ambient Light	<10Lux-2000Lux
Working Temp.	-30°C/+50°C	Material	Plastic+ALU
IP Rating	IP20	Dimension	∅76x58mm



SKU: 7317    White Body   
 SKU: 7320    Black Body   
 SKU: 7321    Gray Body

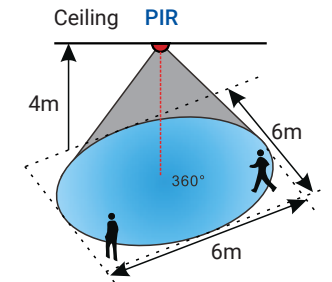

**PIR Motion Sensor**

Product code	SE1-A2	Body Color	White
Input Voltage	AC:110-240V	Class	II
Beam Angle	360°	Time	10sec-7min
Range	6m Max	Max Power	1000W LED
Frequency	50-60 Hz	Ambient Light	<10Lux-2000Lux
Working Temp.	-30°C/+50°C	Material	Plastic+ALU
IP Rating	IP20	Dimension	∅65x86.5mm



SKU: 7311    White Body



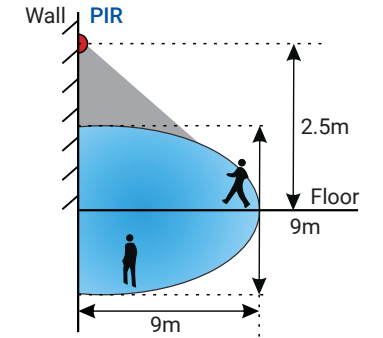
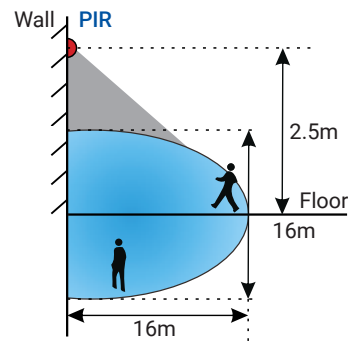

**PIR Motion Sensor**

Functions: D2D: DUSK TO DAWN

Product code	SE1-A2	Body Color	Black
Input Voltage	AC:220-240V	Class	II
Beam Angle	180°	Time	10sec-10min
Range	16m Max	Max Power	400W LED
Frequency	50-60 Hz	Ambient Light	<10Lux-2000Lux
Working Temp.	-30°C/+50°C	Material	Plastic+ALU
IP Rating	IP54		



SKU: 7318    Black Body

**PIR Motion Sensor**

Product code	SE1-A2	Body Color	White
Input Voltage	AC:220-240V	Class	II
Beam Angle	160°	Time	10sec-7min
Range	9m Max	Max Power	400W LED
Frequency	50-60 Hz	Ambient Light	<10Lux-2000Lux
Working Temp.	-30°C/+50°C	Material	Plastic+ALU
IP Rating	IP20		



SKU: 7322    White Body

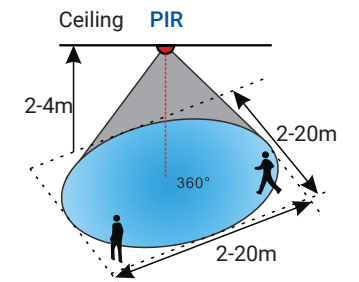
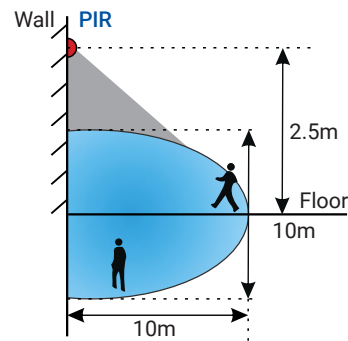

**PIR Motion Sensor**

Product code	SE1-A2	Body Color	White
Input Voltage	AC:220-240V	Class	II
Beam Angle	120°	Time	10sec-7min
Range	10m Max	Max Power	300W LED
Frequency	50-60 Hz	Ambient Light	<10Lux-2000Lux
Working Temp.	-30°C/+50°C	Material	Plastic+ALU
IP Rating	IP44		



SKU: 7319    White Body

**PIR Motion Sensor**

Product code	SE1-A2	Body Color	White
Input Voltage	AC:220-240V	Class	II
Beam Angle	360°	Time	5sec-10min
Range	20m Max	Max Power	1000W LED
Frequency	50-60 Hz	Ambient Light	<10Lux-2000Lux
Working Temp.	-30°C/+50°C	Material	Plastic+ALU
IP Rating	IP20	Dimension	ø65x86.5mm



SKU: 7323    White Body



ON/OFF via moving hand



Dimming + Driver  
**5.8 Ghz**

**Short Distance IR**

Product code	SE1-A2	Body Color	White
Input Voltage	AC:110-240V	Class	II
Beam Angle	180°	Time	10sec-7min
Range	5cm Max	Max Power	200W LED
Frequency	50-60 Hz	Ambient Light	<10Lux-2000Lux
Working Temp.	-30°C/+50°C	Material	Plastic
IP Rating	IP20	Dimension	75x18mm



SKU: 7304    White Body

**Microwave Sensor**

Product code	SE1-A5	Body Color	White
Input Voltage	AC:110-240V	Class	II
Beam Angle	180°/ 300°	Time	10sec-30min
Range	25-100%	Max Power	300W LED
Frequency	50-60 Hz	Ambient Light	5,10,20,30,50,100,200lux
Working Temp.	-30°C/+50°C	Material	Plastic+ALU
IP Rating	IP20	Dimension	75x47mm



SKU: 7315    White Body

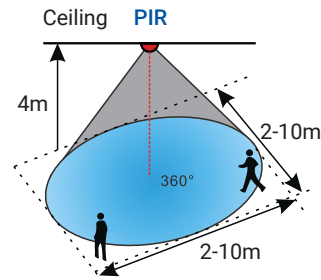

**PIR Motion Sensor**

Product code	SE1-A4	Body Color	White
Input Voltage	AC:110-240V	Class	II
Beam Angle	120°	Time	10sec-7min
Range	2-10m Max	Max Power	100W LED
Frequency	50-60 Hz	Ambient Light	<10Lux-2000Lux
Working Temp.	-30°C/+50°C	Material	Plastic+ALU
IP Rating	IP65	Dimension	57x35mm



SKU: 7309    White Body



Dimming + Driver  
**5.8 Ghz**

**Microwave Sensor**

Product code	SE1-A5	Body Color	White
Input Voltage	AC:110-240V	Class	II
Beam Angle	180°	Time	10sec-7min
Range	3-10m Max	Max Power	300W LED
Frequency	50-60 Hz	Ambient Light	<10Lux-2000Lux
Working Temp.	-30°C/+50°C	Material	Plastic+ALU
IP Rating	IP20	Dimension	56x42mm



SKU: 7316    White Body

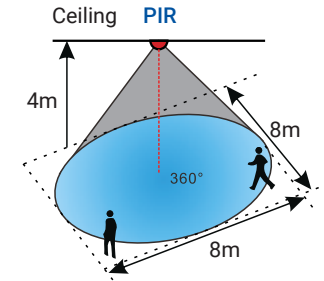

**PIR Motion Sensor**

Product code	SE1-A2	Body Color	White
Input Voltage	AC:110-240V	Class	II
Beam Angle	360°	Time	10sec-7min
Range	8m Max	Max Power	300W LED
Frequency	50-60 Hz	Ambient Light	<10Lux-2000Lux
Working Temp.	-30°C/+50°C	Material	Plastic+ALU
IP Rating	IP20	Dimension	∅80x62mm



SKU: 7312 White Body

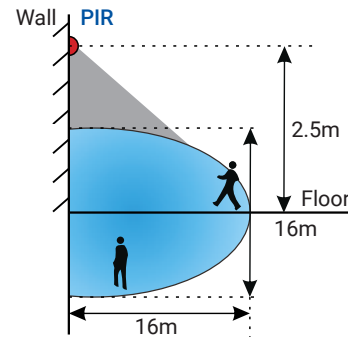

**PIR Motion Sensor**

Product code	SE1-A1	Body Color	White
Input Voltage	AC:110-240V	Class	II
Beam Angle	300°	Time	10sec-7min
Range	16m Max	Max Power	300W LED
Frequency	50-60 Hz	Ambient Light	<10Lux-2000Lux
Working Temp.	-30°C/+50°C	Material	Plastic+ALU
IP Rating	IP44	Dimension	165x117mm



SKU: 7313 White Body



**Light Control Sensor**

Product code	SE1-A1	Body Color	White+Blue
Input Voltage	AC:110-240V	Class	II
Power	6A Max	Ambient Light	<10Lux ON; >40Lux OFF
Frequency	50-60 Hz	Material	Plastic+ALU
Working Temp.	-30°C/+50°C	Dimension	46x44x35mm
IP Rating	IP44		



SKU: 7314 White Body





## LED DISPLAYS AND STAGE EFFECTS



LED Displays have large variety of applications – for commercial use, information boards and other decorative purposes, with wide customization options.

### Features:

- High power and flexible applications
- For commercial and public use
- Different options for resolutions
- Indoor and outdoor use
- Easy to install and maintain
- Low energy consumption

### Application:

- Stadiums and concerts
- Indoor music halls
- Commercial outdoor use





**LED Displays**

**Module Indoor**

- SKU: 608 P2Size
- SKU: 630 P2.5Size
- SKU: 631 P3 Size
- SKU: 601 P4 Size
- SKU: 629 P4 Size
- SKU: 602 P5 Size



	P2	P2.5	P3	P4	P4	P5
Pixel pitch	2 mm	2.5 mm	3 mm	4 mm	4 mm	5 mm
Module size	256x128 mm	320x160 mm	192x192 mm	256x128 mm	256x256 mm	320x160 mm
Module pixels	128x64 pixel	128x32 pixel	64x64 pixel	64x32 pixel	64x64 pixel	64x32 pixel
Brightness	2000cd/m <sup>2</sup>	1200cd/m <sup>2</sup>	1100cd/m <sup>2</sup>	1100cd/m <sup>2</sup>	2000cd/m <sup>2</sup>	2000cd/m <sup>2</sup>
Refresh rate	1920 Hz	1920 Hz	1920 Hz	1920 Hz	3840 Hz	1920 Hz
Drive mode	1/32 Scan	1/32 Scan	1/32 Scan	1/16 Scan	1/16 Scan	1/16 Scan
Module Power	16.5W	20W	16.5W	16.5W	33W	17W
Working Temp.	-20°C/+50°C	-20°C/+50°C	-20°C/+50°C	-20°C/+50°C	-20°C/+65°C	-20°C/+50°C
Pixel Composition	SMD 3in1 RGB	SMD 3in1 RGB	SMD 3in1 RGB	SMD 3in1 RGB	SMD 3in1 RGB	SMD 3in1 RGB
Life Span	50 000 h	50 000 h	50 000 h	50 000 h	50 000 h	50 000 h



**LED Display Cabinet**  
**Fix INDOOR Ver 2.0**

- SKU: 610 P3 Size
- SKU: 611 P4 Size
- SKU: 612 P5 Size



	P3	P4	P5
Pixel pitch	3 mm	4 mm	5 mm
Display size	960x960mm	768x768mm	960x960mm
Module size	192x192mm	256x128mm	320x192mm
Brightness	2000cd/m <sup>2</sup>	2000cd/m <sup>2</sup>	2000cd/m <sup>2</sup>
Pixel Density	111 111dots/ m <sup>2</sup>	62 500dots/ m <sup>2</sup>	40 000dots/ m <sup>2</sup>
Drive mode	1/32 Scan	1/16 Scan	1/16 Scan
Refresh rate	1920 Hz	1920 Hz	1920 Hz
Working Temp.	-20°C/+50°C	-20°C/+50°C	-20°C/+50°C
MAX Power	750W	750W	750W
Life Span	50 000 h	50 000 h	50 000 h

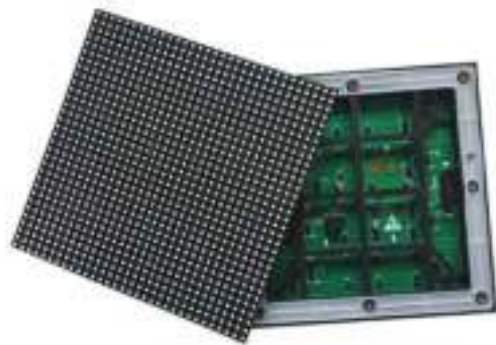

**LED Displays**

**Module Outdoor**

- SKU: 609 P3 Size
- SKU: 603 P4 Size
- SKU: 604 P5 Size
- SKU: 606 P6 Size
- SKU: 605 P8 Size



	P3	P4	P5	P6	P8
Pixel pitch	3 mm	4 mm	5 mm	6 mm	8 mm
Module size	192x192 mm	256x128 mm	320x160 mm	196x196 mm	256x128 mm
Module pixels	64x64pixel	64x32pixel	64x32 pixel	32x32 pixel	32x16 pixel
Brightness	6500cd/m <sup>2</sup>	5500cd/m <sup>2</sup>	5500cd/m <sup>2</sup>	5500cd/m <sup>2</sup>	5500cd/m <sup>2</sup>
Refresh rate	1920 Hz	1920 Hz	1920 Hz	1920 Hz	1920 Hz
Drive mode	1/16 Scan	1/16 Scan	1/16 Scan	1/16 Scan	1/4 Scan
Module Power	35W	35W	39W	26W	27W
Working Temp.	-20°C/+50°C	-20°C/+50°C	-20°C/+50°C	-20°C/+50°C	-20°C/+50°C
Pixel Composition	SMD 3in1 RGB	SMD 3in1 RGB	SMD 3in1 RGB	SMD 3in1 RGB	SMD 3in1 RGB
Life Span	50 000 h	50 000 h	50 000 h	50 000 h	50 000 h



**LED Display Cabinet**  
**Fix INDOOR Ver 2.0**

- SKU: 638 P3 Size
- SKU: 639 P4 Size
- SKU: 640 P5 Size



	P3	P4	P5
Pixel pitch	3 mm	4 mm	5 mm
Display size	960x960mm	768x768mm	960x960mm
Module size	192x192mm	256x128mm	320x192mm
Brightness	2000cd/m <sup>2</sup>	2000cd/m <sup>2</sup>	2000cd/m <sup>2</sup>
Pixel Density	111 111dots/ m <sup>2</sup>	62 500dots/ m <sup>2</sup>	40 000dots/ m <sup>2</sup>
Drive mode	1/32 Scan	1/16 Scan	1/16 Scan
Refresh rate	1920 Hz	1920 Hz	1920 Hz
Working Temp.	-20°C/+50°C	-20°C/+50°C	-20°C/+50°C
MAX Power	750W	750W	750W
Life Span	50 000 h	50 000 h	50 000 h



**LED Displays**  
**Module Indoor**

 SKU: 635 P2.5 Size  
 SKU: 636 P3.07 Size

	P2.5	P3.07
Pixel pitch	2.5 mm	3.07 mm
Module size	320x160 mm	320x160 mm
Module pixels	192x192 pixel	192x192 pixel
Brightness	650cd/m <sup>2</sup>	600cd/m <sup>2</sup>
Refresh rate	3840 Hz	3840 Hz
Drive mode	1/32 Scan	1/32 Scan
Module Power	140W	127W
Working Temp.	-20°C/+50°C	-20°C/+50°C
Pixel Composition	SMD 3in1 RGB	SMD 3in1 RGB
Life Span	100 000 h	100 000 h

**LED Transparent Displays**  
**Module Indoor**

SKU: 66020 P3.91 Size



	P3.91
Pixel pitch	Horizontal 3.91mm Vertical 7.82mm
Module size	1000x1000 mm
Drive mode	1/16 Scan
Brightness	2500cd/m <sup>2</sup>
Refresh rate	960 Hz
Pixel Density	32768 dot/m <sup>2</sup>
Module Power	400W/m <sup>2</sup>
Working Temp.	-20°C/+50°C
Pixel Composition	SMD 3in1 RGB
Life Span	50 000 h

**LED Display Front Service**  
**Module Indoor**

 SKU: 66019 P1.875 Size  
 SKU: 66018 P2.5 Size

	P1.875	P2.5
Pixel pitch	1.875 mm	2.5 mm
Module size	480x480 mm	480x480 mm
Module pixels	240x240 pixel	240x240 pixel
Brightness	500-800cd/m <sup>2</sup>	500-800cd/m <sup>2</sup>
Refresh rate	3840 Hz	3840 Hz
Pixel Density	284 444dots/m <sup>2</sup>	160 000dots/m <sup>2</sup>
Module Power	500W/m <sup>2</sup>	20W
Working Temp.	-20°C/+50°C	-20°C/+50°C
Pixel Composition	SMD 3in1 RGB	SMD 3in1 RGB
Life Span	50 000 h	50 000 h

**LED Displays Rental**  
**Module Indoor**

SKU: 101 P2.6 Size



	P2.6
Pixel pitch	2.6 mm
Module size	500x500 mm
Module pixels	192x192 pixel
Brightness	2000cd/m <sup>2</sup>
Refresh rate	3840 Hz
Drive mode	1/32 Scan
Module Power	650W Max
Working Temp.	-20°C/+50°C
Pixel Composition	SMD 3in1 RGB
Life Span	100 000 h



**LED Display Cabinet  
Fix OUTDOOR**

SKU: 617 P4 Size  
 SKU: 618 P5 Size  
 SKU: 619 P8 Size  
 SKU: 607 P10 Size



	P4	P5	P8	P10
Pixel pitch	5 mm	5 mm	8 mm	10 mm
Display size	768x768mm	960x960mm	768x768mm	960x960mm
Module size	256x128mm	160x160mm	256x128mm	160x160mm
Brightness	5500cd/m <sup>2</sup>	5500cd/m <sup>2</sup>	5500cd/m <sup>2</sup>	7500cd/m <sup>2</sup>
Pixel Density	62 500dots/ m <sup>2</sup>	40 000dots/ m <sup>2</sup>	15 625dots/ m <sup>2</sup>	40 000dots/ m <sup>2</sup>
Drive mode	1/8 Scan	1/8 Scan	1/8 Scan	1/8 Scan
Refresh rate	1920 Hz	1920 Hz	1920 Hz	1920 Hz
Working Temp.	-20°C/+50°C	-20°C/+50°C	-20°C/+50°C	-20°C/+50°C
MAX Power	800W	800W	800W	800W
Life Span	50 000 h	50 000 h	50 000 h	50 000 h

**LED Displays  
Rental INDOOR**

SKU: 620 P2.5 Size  
 SKU: 613 P4 Size  
 SKU: 614 P5 Size



	P2.5	P4	P5
Pixel pitch	2.5 mm	4 mm	5 mm
Display size	640x640mm	768x768mm	960x960mm
Module size	160x160mm	256x128mm	320x160mm
Brightness	2000cd/m <sup>2</sup>	2000cd/m <sup>2</sup>	2000cd/m <sup>2</sup>
Pixel Density	160 000dots/ m <sup>2</sup>	62 500dots/ m <sup>2</sup>	40 000dots/ m <sup>2</sup>
Drive mode	1/16 Scan	1/16 Scan	1/16 Scan
Port Type	HUB75	HUB75	HUB75
Working Temp.	-20°C/+50°C	-20°C/+50°C	-20°C/+50°C
MAX Power	600W	600W	750W
Life Span	50 000 h	50 000 h	50 000 h

## P3.91



## P5



	P3.91	P5
Pixel pitch	3.91 mm	5 mm
Display size	500x1000mm	960x960mm
Module size	250x250mm	320x160mm
Brightness	6500cd/m <sup>2</sup>	7500cd/m <sup>2</sup>
Pixel Density	65 532dots/ m <sup>2</sup>	40 000dots/ m <sup>2</sup>
Drive mode	1/16 Scan	1/8 Scan
Port Type	HUB75	HUB75
Working Temp.	-20°C/+50°C	-20°C/+50°C
MAX Power	800W	750W
Life Span	50 000 h	50 000 h

**LED Displays  
Rental OUTDOOR**

SKU: 615 P3.91 Size  
 SKU: 616 P5 Size



**LED Display Poster**
**Outdoor**

SKU: 66027 P3 Size

SKU: 66025 P3.84 Size



	P3	P3.84
Pixel pitch	3 mm	3.84 mm
Display size	600x1200mm	600x1200mm
Module size	200x200mm	200x200mm
Brightness	>6000cd/m <sup>2</sup>	>6000cd/m <sup>2</sup>
Pixel Density	102400dots/ m <sup>2</sup>	67600dots/ m <sup>2</sup>
Drive mode	1/16S	1/13S
Refresh rate	4000 Hz	4000 Hz
Working Temp.	-20°C/+70°C	-20°C/+70°C
MAX Power	950W /m <sup>2</sup>	820W /m <sup>2</sup>
Life Span	100 000 h	50 000 h

**LED Displays  
Rental INDOOR**

SKU: 102 P2.9 Size

SKU: 628 P3.91 Size



	P2.9	P3.91
Pixel pitch	2.9 mm	3.91 mm
Display size	500x500mm	500x500mm
Module size	168x168mm	128x128mm
Brightness	5000cd/m <sup>2</sup>	5000cd/m <sup>2</sup>
Pixel Density	28224dots/ m <sup>2</sup>	62 500dots/ m <sup>2</sup>
Drive mode	1/21 Scan	1/21 Scan
Refresh rate	3840 Hz	3840 Hz
Working Temp.	-20°C/+50°C	-20°C/+50°C
MAX Power	650W	650W
Life Span	100 000 h	100 000 h

**LED Display Poster**
**Outdoor Double-sided**

SKU: 66028 P3 Size

SKU: 66026 P3.84 Size



	P3	P3.84
Pixel pitch	3 mm	3.84 mm
Display size	600x1200mm	600x1200mm
Module size	200x200mm	200x200mm
Brightness	>6000cd/m <sup>2</sup>	>6000cd/m <sup>2</sup>
Pixel Density	102400dots/ m <sup>2</sup>	67600dots/ m <sup>2</sup>
Drive mode	1/16S	1/13S
Refresh rate	4000 Hz	4000 Hz
Working Temp.	-20°C/+70°C	-20°C/+70°C
MAX Power	950W /m <sup>2</sup>	820W /m <sup>2</sup>
Life Span	100 000 h	50 000 h

**LED Displays  
FIX OUTDOOR V2**

SKU: 624 P4 Size

SKU: 623 P8 Size



	P4	P8
Pixel pitch	2.9 mm	3.91 mm
Display size	960x960mm	960x960mm
Module size	321x160mm	320x1620mm
Brightness	6500cd/m <sup>2</sup>	6500cd/m <sup>2</sup>
Pixel Density	62 500dots/ m <sup>2</sup>	62 500dots/ m <sup>2</sup>
Drive mode	1/16 Scan	1/16 Scan
Refresh rate	3840 Hz	1920 Hz
Working Temp.	-20°C/+50°C	-30°C/+65°C
MAX Power	600W	600W
Life Span	100 000 h	100 000 h

**LED Display Screen  
OUTDOOR STADIUM**

SKU: 622 P10 Size



DC 5V



150°



IP65

	P10
Pixel pitch	10 mm
Module size	320x160mm
Module pixels	32x16 pixel
Brightness	7500cd/m <sup>2</sup>
Pixel Density	10 000dots/ m <sup>2</sup>
Drive mode	1/4 Scan
Port Type	HUB75
Working Temp.	-20°C/+50°C
MAX Power	700W
Life Span	50 000 h

**LED Displays  
INDOOR Poster Display**

SKU: 66024 P2 Size

SKU: 621 P3 Size



DC 5V



150°



IP20

	P2	P3
Pixel pitch	2 mm	3 mm
Module size	256x128 mm	192x192 mm
Module pixels	128x64 pixel	64x64 pixel
Brightness	1100nits/m <sup>2</sup>	2000cd/m <sup>2</sup>
Pixel Density	250 000dots/ m <sup>2</sup>	111 111dots/ m <sup>2</sup>
Drive mode	-	1/32 Scan
Port Type	HUB75	HUB75
Working Temp.	-20°C/+50°C	-20°C/+50°C
Pixel Composition	SMD 3in1 RGB	SMD 3in1 RGB
Life Span	100 000 h	100 000 h

**LED Display Accessories**
**Splitter**

DIS-300 is specialized for multi-screens and super large led screens. The card possesses two input ports and eight output ports, enabling that one split to eight and two split to four. Functions change automatically. Each RJ45 port can be independently adjusted, and support read back parameters from scan board.

**Description:**

- 1 in 8 out or 2 in 4 out, automatic switching.
- Each RJ45 port can be independently adjusted.
- No need to install the drivers



SKU: 952



IP20

**LED DISPLAYS**
**43 inch IR touch**

CPU: Bay Trail-D Celeron Quad-core J1900 2.0GHZ  
 Chipset: Intel Bay trail SOC  
 GPU Integrate: Intel HD Graphics  
 Display output : VGA, built-in VGA pin, HDMI, HDMI pin, LVDS  
 Memory: DDR3 2GB  
 Hard drive: 32G Hard drive

SKU: 671 43inch



IP20



**RECEIVING CARDS  
FOR LED DISPLAYS**

SKU No.	950	652	653	654	655
Resolution	256 x 226	512 x 256	256 x 226	256 x 226	512x256
RGB Data Output	16 Groups	32 Groups	24 Groups	24 Groups	32 Groups
Interface	8 x HUB75	16 x HUB75	8 x HUB75	12 x HUB75	16 x HUB75

**RECEIVING CARDS  
FOR LED DISPLAYS**

SKU No.	112	113	149
Resolution	256 x 226	512 x 384	512x512
RGB Data Output	24 Groups	24 Groups	24 Groups
Interface	12 x HUB75	32 x HUB75	24 x HUB75

**SENDING CARD  
FOR LED DISPLAYS**

SKU No.	650	651
Input Resolution	1280x1024,1024x1200,1600x848	1920x1200,2048x1152,2560x96
Capacity	1.3 million pixels	2.3 million pixels
Supply Voltage	5V	5V
Control Method	USB Interface	USB Interface
Video Interface	DVI	HDMI/DVI
Audio Interface	3.5mm	HDMI/3.5mm
Video Format	RGB	RGB ,YCrCb4:2:2,YCrCb4:4:4
Output Interface	2 Ethernet ports	4 Ethernet ports
Bit Depth	8bit	8/10/12bit

**Multifunctional CARD  
FOR LED DISPLAYS**

SKU: 972

MFN300  
 Ethernet connection: 2x Gigabit Ethernet connection  
 RS232: Sub-D 9-pin connector  
 Audio: 3.5mm  
 Supply voltage: DC 5V  
 Operating temperature: -20 ~ 75°C  
 Dimensions: 144 x 92 x 20mm  
 Weight: 0.165 kg



### Sending Box LED Display Controller

The Optonica Sender card control box is a sending card inside of an enclosure with a built in power supply. You can order the stand alone card if you do not need the enclosure.

Product Type:	Controller
Capacity:	1.3 million pixels
Supply Voltage:	AC-100-240V-50/60HZ
Control Method:	USB Interface
Video Interface:	DVI
Audio Interface:	3.5mm
Viedo Format:	RGB
Output Interface :	2 Ethernet ports
Bit Depth Of Video Resource:	8bit
Light Sensor Interface:	1
USB Cable:	1.5M

SKU: 948



IP20



### Sending Box Synchronous LED Display Controller MCTRL700

The MCTRL700 is a video controller for LED screens developed by NovaStar. It supports 1x DVI input, 1x HDMI input, 1x audio input and 6 Ethernet outputs, with a loading capacity of 1920x1200@60Hz. The MCTRL700 is suitable for rental and fixed installations, such as concerts, live shows, monitoring centers, events, sports halls, etc.

Product specification: Product Type Controller  
 Inputs: 1xSL-DVI (IN-OUT) 1xHDMI 1.3 (IN-OUT) 1xAUDIO  
 Outputs: 6x RJ45, 1x HDMI 1.3, 1x SL-DVI  
 Capacity: 650,000 pixels  
 Dimensions (w/h/d): 482.6 x 44.4 x 268.50mm  
 Weight: 2.6 kg

SKU: 114



IP20



VX600



VX1000



### Video Processor for LED screens LED Display Controller

High-quality and precise video processor used in LED screen installations

Тип: Video Controller

SKU: 150 VX600

Inputs: 2x HDMI 1.3, 1x DVI, 1x 3G-SDI (max. 1920x1080@60Hz)  
 Outputs: 6x LED-Out (RJ45) 1x HDMI 1.3 Out, 2x OPT-Out (10G)  
 Capacity: 3.9 million pixels

SKU: 151 VX1000

Inputs: 2x HDMI 1.4, 1x DVI, 1x 3G-SDI Max. width: 4092 pixels (4092x1136@60Hz)  
 Outputs: 10x LED-Out (RJ45) 1x HDMI 1.3 Out, 2x OPT-Out (10G)  
 Capacity: 6.5 million pixels with a maximum width of 10,240 pixels and a maximum height of 8192 pixels

Dimensions (w/h/d): 483.6 x 351.2 x 50.1mm  
 Weight: 4 kg



IP20



### Sending Box Synchronous LED Display Controller

supports extra-large resolution. With HDMI/DVI video input and four Ethernet port outputs, a single unit is able to load 2560x960. Multiple units can be cascaded for uniform control.

Product specification: Product Type Controller  
 Input Resolution: 1920x1200,2048x1152,2560x960  
 Capacity: 2.3 million pixels  
 Supply Voltage: AC-100-240V-50/60HZ  
 Control Method: USB Interface  
 Video Interface: HDMI / DVI  
 Audio Interface: HDMI/3.5mm  
 Viedo Format: RGB,YCrCb4:2:2,YCrCb4:4:4  
 Output Interface: 4 Ethernet ports  
 Bit Depth Of Video Resource: 8/10/12bit  
 Light Sensor Interface: 1

SKU: 947



IP20



### MCTRL4K LED Screen Controller

The MCTRL 4K is a 4K x 2K controller with a loading capacity of up to 4096x2160@60Hz and supports every resolution in that range. These features make this controller suitable for very large and wide LED displays

Type: Video Controller  
 Inputs: 1x DP 1.2, 1x HDMI 2.0, 2x Dual-Link DV  
 Outputs: 16x LED output (RJ45), 4x OPT Out (2x Main, 2x Backup)  
 Capacity: 8.8 million pixels  
 Dimensions (w/h/d): 482.6 x 372 x 89mm  
 Weight: 4.6 kg.

SKU: 171



IP20



### TB40 CONTROLLER

#### Multimedia Players

Wi-Fi media player used in the construction of LED screens with 2 Ethernet ports with a capacity of up to 1,300,000 pixels each with a maximum width of 4096 pixels and a maximum height of 4096 pixels.

TB40 enables intelligent control of the LED screen with an application for tablets and smartphones.

- 4 core 1.8 GHz processor
- 1 GB of RAM
- 16 GB of internal storage (4 GB available)
- Dual Wi-Fi modes

SKU: 152



IP20



### TB40 CONTROLLER

#### Multimedia Players

Wi-Fi media player used in the construction of LED screens with 2 Ethernet ports with a capacity of up to 1,300,000 pixels each with a maximum width of 4096 pixels and a maximum height of 4096 pixels.

TB40 enables intelligent control of the LED screen with an application for tablets and smartphones.

- 4 core 1.8 GHz processor
- 1 GB of RAM
- 16 GB of internal storage (4 GB available)
- Dual Wi-Fi modes

SKU: 153



IP20



### TB1 CONTROLLER

#### Multimedia Players

Wi-Fi media player used in the construction of LED screens with a capacity of up to 650,000 pixels with a maximum width of 1920 pixels and a maximum height of 1080 pixels. TB1 enables intelligent control of the LED screen with an application for tablets and smartphones.

- 4 core 1.5 GHz processor
- 1 GB of RAM
- 8 GB of internal storage (4 GB available)

SKU: 115



IP20





### TB2 CONTROLLER

Multimedia Players

Wi-Fi media player used in the construction of LED screens with a capacity of up to 650,000 pixels with a maximum width of 1920 pixels and a maximum height of 1080 pixels. TB2 enables intelligent control of the LED screen with an application for tablets and smartphones.

- 4 core 1.5 GHz processor
- 1 GB of RAM
- 8 GB of internal storage (4 GB available)



IP20

SKU: 116



### TB4 CONTROLLER

Multimedia Players

Wi-Fi media player used in the construction of LED screens with 2 Ethernet ports with a capacity of up to 1,300,000 pixels each with a maximum width of 4096 pixels and a maximum height of 1920 pixels.

TB4 enables intelligent control of the LED screen with an application for tablets and smartphones.

- 8 core 1.5 GHz processor
- Hardware decoding and playback of H.265 4K HD videos
- Hardware decoding of 1080P videos
- 2 GB of RAM
- 8 GB of internal storage (4 GB available)
- Dual Wi-Fi modes



IP20

SKU: 117



### TB6 CONTROLLER

Multimedia Players

- Loading capacity up to 1,300,000 pixels, with the maximum width of 4096 pixels and maximum height of 1920 pixels
- Wired Gigabit Ethernet
- Stereo audio output
- HDMI Loop
- HDMI input and auto full-screen display
- 2 USB ports allowing for USB playback
- Onboard light sensor connector allowing for automatic and scheduled brightness adjustment
- Synchronization mechanism for multi-screen playing
- Powerful processing capability
- Comprehensive control plans
- Synchronous and asynchronous dual-mode
- Dual-Wi-Fi mode
- Redundant backup



IP20

SKU: 661



### TB8 CONTROLLER

Multimedia Player

- 4 Ethernet ports, loading capacity of each port up to 2,300,000 pixels, with the maximum width of 4096 pixels and maximum height of 1920 pixels
- Wired Gigabit Ethernet
- Stereo audio output
- HDMI Loop
- HDMI input and auto full-screen display
- 2 USB ports allowing for USB playback
- Onboard light sensor connector allowing for automatic and scheduled brightness adjustment synchronization mechanism for multi-screen playing
- Powerful processing capability
- Comprehensive control plans
- Synchronous and asynchronous dual-mode
- Dual-Wi-Fi mode



IP20

SKU: 946

### ALL-IN-1 CONTROLLER

#### LED VIDEO PROCESSOR WITH SDI



Product Type :	Video Controller
Inputs :	HDMI, DVI, VGA × 2, CVBS × 2, DP, SDI
Outputs :	Ethernet port × 4
Loading Capacity :	2.35 million pixels
Maximum pixel CLK :	165MHz
Video Loop :	DVI LOOP, SDI LOOP
Video Monitor :	VGA OUT, DVI OUT
Communication Mode:	USB/LAN
Image Mosaic :	Support
Crop Settings :	Support
PIP :	Support



SKU: 656



IP20

### 4G Module

#### for LED Multimedia Players



4G module can be used for all Optonica multimedia players. The 4G module, combined with external Sim card, enables you to access you're Optonica multi media player even when there is no Wi-Fi or LAN network available by using the 4G network. The compact module is plug and play, no further drivers are required.

- 4G module
- Access media player anywhere anytime
- Antenna included



SKU: 949



IP20

### Power Supplies

#### Metal 5V output



Watts	200W	300W
Input Voltage	220V	220V
Output Voltage	DC:5V	DC:5V
Current	40A	60A
Material	Metal	Metal
Dimmension	190x80x30mm	190x80x30mm

SKU: 6191 200W 3800156661912

SKU: 6192 300W 3800156661929



DC 5V



IP20

### Accessories



### Light Sensor

#### for Brightness Adjustment



Accessory light probe with the following features:

- Monitor the brightness of the environment to achieve automatic adjustment of screen brightness.
- Connect the sending card and sending box, asynchronous card or multi-function card.
- Marking the 5 meter line, can be extended to 100 meters;
- In the outdoor use, three defense;
- No external power supply is required.

SKU: 951



IP20



### 18\*10W Flat aluminium RGBW LED PAR Light

Voltage: AC90-260V 50/60Hz  
 Power: 180W  
 Light source: 18\*10W RGBW led par light  
 LED life: 50,000 hours.  
 Lens degree: 15° 25°, 45° (optional)  
 DMX channel: 4/8CH  
 Control Mode: Auto, Sound, DMX512, Master-slave  
 Strobe: 0 ~ 20 times / sec.

SKU: 683



RGB+W



IP20



### 7\*10w Mini RGBW LED PAR Light

Voltage: AC100~240V 50~60Hz  
 Power consumption: 70W  
 Light source: 7\*10W RGBW 4in1 LED  
 Beam angle: 15° 25° 40° optional  
 DMX channels: 7 CHS  
 Function: DMX AutoSound Master-slave, strobe, dimmer  
 Housing Material: plastic  
 Working Environment: -20~40  
 Packing size: 22.5\*10\*22.5cm (1pc/CTN)

SKU: 691



RGB+W



IP20



### 18\*10W Flat aluminium RGB LED PAR Light

Voltage: AC90-260V 50/60Hz  
 Power: 180W  
 Light source: 18x 10W 4 in 1 LED  
 LED life: 50,000 hours.  
 Lens degree: 15° 25°, 45° (optional)  
 DMX channel: 4/8CH  
 Control Mode: Auto, Sound, DMX512, Master-slave  
 Strobe: 0 ~ 20 times / sec.

SKU: 943



RGB



IP20



### 7\*10w Remote Mini RGB+WW LED PAR Light

Voltage: AC100~240V 50~60Hz  
 Power consumption: 70W  
 Light source: 7\*10W RGB+WW 4in1 LED  
 Beam angle: 25° optional  
 DMX channels: 4/6CH  
 Function: DMX, Remote, Auto, Sound, Master-slave, Strobe, Dimmer  
 Housing Material: Plastic  
 Protection power: IEC power in and out Working Environment: -20~40  
 Packing size: 22.5\*10\*22.5cm (1pc/CTN)

SKU: 692



RGB+WW



IP20



### LED Slim Flat PAR Can 18x18W RGBWA+UV 6 in 1

Voltage: AC90-245V, 50-60HZ  
 Power: 180W  
 Light source: 18x 18W RGBWA+UV 6 in 1 LED  
 LED life: 50,000 hours.  
 Lens degree: 15° 25°, 45° (optional)  
 DMX channel: 10/6CH  
 Control Mode: Auto, Sound, DMX512, Master-slave Function  
 effect: dimmer /Strobe /Eotic /Gradual change  
 Strobe: 0 ~ 20 times / sec.

Size: 265x80x280 mm  
 Net weight 3kg

SKU: 177



RGBWA+UV



IP20



### 36\*3W LED PAR Light

Voltage: AC100-260V 50Hz/60Hz  
 Consumption: 50W/120W  
 Lamp: 3W\*36\* LED lamp R12G12B12  
 Channel: 7CH  
 Mode of control: DMX512, automatic, voice active.  
 Function: Can make magic, color mixed, charming effect  
 Packing size: 290\*290\*410mm

SKU: 690



RGB



IP20



### Laser RGB5000



Voltage: AC90-240V, 50/60HZ  
 Consumption: 120W  
 Scanner: 25kkps  
 Laser power:  
 1x1000mW Red 638nm,  
 1x1000mW Green 520nm,  
 1X3000mW Blue 450nm  
 Colors: RGB full color  
 Control signal: DMX-512  
 Control mode: music, auto, master-slave and DMX-512, ILDA control  
 DMX channel: 10/34ch  
 Size: 270x200x160 mm  
 Weight: 5.5 kg



SKU: 166

IP20

### 3pcs \*60W warm white + 36 \*3W RGB



Input voltage: 100-240Vac/50-60Hz  
 Product power: 250W  
 Light source: 3pcs \*60W warm white + 36 \*3W RGB  
 Channel: 14CH/22CH  
 Control mode: DMX512, master/slave,  
 self-propelled, voice control  
 Dimming method: 0-100% ultra-smooth dimming  
 Strobe: 25 times/sec



SKU: 128

RGB

IP20

### Laser RGB3000



Voltage: AC90-240V, 50/60HZ  
 Consumption: 120W  
 Scanner: 25kkps  
 Laser power:  
 1x500mW Red 638nm,  
 1x800mW Green 520nm,  
 1X1700mW Blue 450nm  
 Colors: RGB full color  
 Control signal: DMX-512  
 Control mode: music, auto, master-slave and DMX-512, ILDA control  
 DMX channel: 10/34ch  
 Size: 270x200x160 mm  
 Weight: 5.5 kg



SKU: 165

IP20

### WATERPFOOR RGBW 4in1 Flat Par 18



Voltage: AC100-240V  
 Frequency: 50Hz-60Hz  
 Consumption: 180W  
 Lamp: 18pcs10W RGBW 4in1 LED  
 Channel: 8/4CH  
 IP rate: IP65  
 Mode of control: DMX512, Auto, Sound, Master-slave.  
 Function: Can make magic, color mixed, charming effect  
 Net weight: 3.7KG



SKU: 129

RGB+W

IP20

### Laser RGB1000



Voltage: AC90-240V, 50/60HZ  
 Consumption: 120W  
 Scanner: 20kkps  
 Laser power:  
 1x170mW Red 638nm,  
 1x100mW Green 520nm,  
 1X700mW Blue 445nm,  
 Colors: RGB full color  
 Control signal: DMX-512  
 Control mode: music, auto, master-slave and DMX-512, ILDA control  
 DMX channel: 10/34ch  
 Size: 270x200x160 mm  
 Weight: 5.5 kg



SKU: 164

IP20



### 7x100W Waterproof White Halogen Lamps

Work voltage: 220V/50-60HZ  
 Light source: 7x100W Halogen lamps (philips)  
 Power consumption: 700 W  
 Color temperature: 1650K-6500k  
 Control mode: Auto-run , Master-Slave , DMX control  
 DMX channel: 1CH/6CH /7CH  
 DMX connector: 3+5 pin XLR connector (selected)  
 Display: Color LCD display  
 Installation Tripod stand /Hang on /Base  
 Reflector bowl color: Silver  
 Size: 456\*520\*130 mm  
 Weight: 7.65KG



SKU: 967

IP65



Battery

### 7x12W Waterproof RGB 6IN1 LED PAR Light Battery - Wireless

Waterproof 7x12W RGB 6IN1 Battery Wireless Led Par  
 Light source: 7pcs 15w LED 4in1 mixing color  
 Beam Angle: 25°  
 Dimmer: 0-100% dimmer  
 Strobe rate:0-24HZ  
 Working Environment: -20-40  
 DMX Channels: 2 DMX modes, 4channels mode & 8 channels mode  
 Control Mode: DMX512,Master-slave,Sound,Auto,Wireless,remote.  
 Battery type: Lithium Ion  
 Battery Charge Time: 3hours(full power)  
 Battery Life: 3.5(all on) hours,14 (single Color) hours  
 Battery Power: 24V, 5Ah  
 Wireless effective distance: 400meters

SKU: 940



RGB



IP54



### Waterproof 44x10w RGBW 4in1 Led wall light

Power Supply: AC 90-240V/50-60Hz  
 Power consumption: 450W  
 Light source: 44pcsx10W RGBW Led  
 Beam Angel: 25-35°  
 Dimmer: 0-100% dimmer  
 IP rate: IP67,outdoor  
 Control Mode: RDM, DMX512 Control, Sweden Import wireless DMX

SKU: 66127



RGB+W



IP67



Battery

### 7x8W Waterproof RGB 6IN1 LED PAR Light Battery - Wireless

Light source: 7pcs 8w LED 4in1 mixing color  
 Beam Angle: 25°  
 Dimmer: 0-100% dimmer  
 Strobe rate:0-24HZ  
 Working Environment: -20-40  
 DMX Channels: 2 DMX modes, 4channels mode & 8 channels mode  
 Control Mode: DMX512,Master-slave,Sound,Auto,Wireless,remote.  
 Battery type: Lithium Ion  
 Battery Charge Time: 3hours(full power)  
 Battery Life: 3.5(all on) hours,14 (single Color) hours  
 Battery Power: 24V, 5Ah  
 Wireless effective distance: 400meters

SKU: 941



RGB



IP54



Battery

### 9\*10W Wifi control Waterproof RGBA+UV 6 in 1

Power Supply: AC 100-240V/50-60Hz  
 Power consumption: 90W  
 Light source: 9pcs LED RGBWA+UV 6in1 mixing color  
 Beam Angel: 15°  
 Dimmer: 0-100% dimmer  
 Strobe rate:0-24HZ  
 Working Environment: -20-40  
 DMX Channels: 2 DMX modes, 6channels mode & 10 channels mode  
 Control Mode: DMX512,Master-slave,Sound,Auto,Wireless,remote, wifi  
 Battery type: Lithium Ion  
 Battery Charge Time: 6 hours  
 Battery Life: (all on) 4 hours, (single Color) 24hours  
 Battery Power: 12V, 25Ah

SKU: 932



RGB+UV



IP54



### 12x10W Waterproof RGBWA+UV 6IN1 LED PAR Light

Voltage: AC100-240V 50Hz-60Hz  
 Consumption: 150W  
 LED: 12pcs 10W RGBWA+UV 6 in1 LED  
 Channel: 6CH/9CH  
 Mode of control: DMX512, Auto, Master-slave  
 Function: Can make magic, color mixed, charming effect

SKU: 945



RGB-WA



IP65



Battery

### 24X3W RGB 3IN1 LED Wall Washer Battery - Wireless

Power Supply: AC 100-240V/50-60Hz  
 Power consumption:80W  
 Light source: 24pcs\*3w LED RGB 3in1 mixing color  
 Beam Angle: 10/20/25 degree  
 Dimmer: 0-100% dimmer  
 Strobe rate:0-24HZ  
 Control Mode: DMX512,Master-slave,Sound,Auto, remote  
 Build-in more than 9 build-in programs  
 Generate endless effects with built-in, automated programs  
 Product size: 1030x62x58mm

SKU: 936



RGB+W



IP20

### Pixel control 18\*10w RGBW 4in1 LED Wallwasher



Voltage: AC90V-245V/50-60Hz  
 Power: 200W Light source  
 Pixel control: 18\*10w RGBW 4in1 LED wash  
 Beam angle: 15° or 40° Rate :use indoor only  
 Leds: 18pcs 10W RGBW 4IN1 LEDS  
 Life time: >100 thousand hours  
 Color: RGBW Wcolor can be mixed to more than 16.7million kinds of color  
 Function effect: dimmer, strobe, eotic, gradual change

SKU: 993



### Compact Pinspot LED 40W RGBW 4in1 Par with manual zoom

Power Supply: AC 100-240V/50-60Hz  
 Power consumption: 40W  
 Light source: 40 W RGBW 4in1 LED  
 Beam Angle: 40°  
 Zoom range: 4~60° manual zoom  
 Dimmer: 0-100% dimmer  
 Strobe rate: 0-20HZ  
 Working Environment: -20-40  
 IP rate: IP20,indoor  
 DMX Channels: 6ch  
 Control Mode: DMX512,Master-slave,Sound,Auto, Remote  
 Net weight: 2kg

SKU: 990



### 5 Head Matrix Blinder



Voltage: AC100-240V 50/60Hz  
 Power: 60W  
 Light source: 5PCS 10W CREE RGB 3in1 LED  
 Function: Color mix, automatic color change, built-in program and strobe effect with adjustable speed, dimmer, master/slave  
 Light size: 620\*130\*160mm  
 Weight: 4kg

SKU: 992



### 1000W LED Strobe RGB

Voltage: AC110-240V, 50/60HZ  
 Consumption: 1000W  
 Light source: 800pcs 1.2w SMD RGB LEDs  
 Channel: 1CH /3CH/6CH  
 IP rate: IP20  
 Display Panel: LED Blue Display  
 Housing material: Black Aluminum shell  
 Mode of control: DMX512,Master-slave,Sound,Auto  
 Dimension: 510\*220\*305mm  
 Weight: 5.7kgs

SKU: 995



### LED COB Blinder 2X100 W



LED: 2pcs\*100W COB LED  
 Light Color: Single color WW(100W)  
 LED light time: over 50000 hours  
 Voltage: AC 100V-240V 50-60Hz  
 Power consumption: 260W  
 Beam angle: 30 degree  
 Dimmer: 0-100% linear adjustable  
 Strobe: Variable speed (1-30Hz)  
 Refresh rate: 11700Hz , 100% flicker free for film and TV camera  
 Color effect feature: with individual control effect  
 Power input: powercorn connector  
 Housing material: Metal  
 Control mode: DMX512,Master/Slave,Auto,Sound alone,Sound active  
 DMX Channel: 2/5 CH

SKU: 994



### Battery Mini 4 \*10W RGBWA+UV 6in1 LED PAR

Power Supply: AC 100-240V/50-60Hz  
 Power consumption: 40W  
 Light source: 4pcs 10W LED RGBWA+UV 6in1 mixing color  
 Beam Angle: 15°  
 Dimmer: 0-100% dimmer  
 Strobe rate: 0-24HZ  
 Working Environment: -20-40  
 IP rate: IP20,indoor  
 DMX Channels: 6CH ,10CH  
 Control Mode: DMX512, Master-slave,Sound,Auto, Remote

SKU: 988







Battery

### 4x10W Wifi Control RGB 6IN1 Charging F Case

Power Supply: AC 100-240V/50-60Hz  
 Power consumption: 40W  
 Light source: 4pcs LED RGBWA+UV 6in1 mixing color  
 Beam Angle: 15°  
 Dimmer: 0-100% dimmer  
 Strobe rate: 0-24HZ  
 DMX Channels: 2 DMX modes, 6channels mode & 10 channels mode  
 Control Mode: DMX512, Master-slave, Sound, Auto, Wireless, Wifi, Remote  
 Battery type: Lithium Ion  
 Battery Charge Time: 3 hours (full power)  
 Battery Life: (all on) 6hours, (single Color) 36hours  
 Battery Power: 12V, 10Ah  
 Wireless effective distance: 400meters  
 Product size: 140\*140\*200mm



RGB+WA



IP20

SKU: 935



### Beam Moving Head Double Prism

Voltage: 100-240V 50/60Hz  
 Power: 230W  
 Channel: 16ch  
 Light source: 230W Lamp  
 Gobo wheel: 17 metal gobos+white  
 Color wheel: 14 colors+white  
 8/16prism/24prism optional ,prism rotation  
 Lens : 6-layer optic glass lens  
 Motor : 2-phase step motors  
 Features: moving more smoothly and no shake  
 The channel list is same with Clay Paky  
 Display : Roller Button screen  
 Size: 410x460x510mm



IP20

SKU: 685



Battery

### 9X10W RGB 6IN1 LED PAR Light Charging F Case - Wireless Transmitter

Power consumption: 90W  
 Light source: 9pcs LED RGBWA+UV 6in1 mixing color  
 Beam Angle: 15°  
 Dimmer: 0-100% dimmer  
 Strobe rate: 0-24HZ  
 DMX Channels: 2 DMX modes, 6channels mode & 10 channels mode  
 Control Mode: DMX512, Master-slave, Sound, Auto, Wireless.  
 Battery type: Lithium Ion  
 Battery Charge Time: 6 hours  
 Battery Life: (all on) 4 hours, (single Color) 24hours  
 Battery Power: 12V, 25Ah  
 Wireless effective distance: 400meters



RGB+WA



IP20

SKU: 937



### Compact Mini Beam 7R Moving Head Light

Voltage: 100-240V 50/60Hz  
 Power: 250W  
 Channel: 16ch  
 Light source: 230W Lamp  
 Gobo wheel: 14 metal gobos+white  
 Color wheel: 13 colors+white  
 8facet prism ,prism rotation  
 Lens : 6-layer optic glass lens  
 Motor : 2-phase step motors  
 Features: moving more smoothly and no shake  
 The channel list is same with Clay Paky  
 Size: 310x220x440mm



IP20

SKU: 686



Battery

### 6X10 RGB 6in1 Battery LED PAR Light

Power consumption: 60W  
 Light source: 6pcs LED RGBWA+UV 6in1 mixing color  
 Beam Angel: 30°  
 Dimmer: 0-100% dimmer  
 Strobe rate: 0-24HZ  
 DMX Channels: 2 DMX modes, 6channels mode & 10 channels mode  
 Control Mode: DMX512, Master-slave, Sound, Auto, Wireless.  
 Battery type: Lithium Ion  
 Battery Charge Time: 4 hours  
 Battery Life: (all on) 3.5hours, (single LED) 21hours  
 Battery Power: 12V, 15Ah  
 Wireless effective distance: 400meters



RGB+WA



IP20

SKU: 938



### Beam Moving Head 330 15R

Power Supply: AC110v-240V 50/60hz  
 Power: 350w  
 Light source: 15R 330w lamp  
 Ballast: electronic ballast  
 Lens: 6-Layer option glass lens  
 Beam angle parallel beam angel : 0-3.8°  
 Channel: 16ch  
 Color temperature: 8000K  
 Prism: prism 1: Floral prism rotation, prism 2: 8 Prism rotation  
 Gobo: 13 gobos+blank double rotation rainbow effect  
 Colors 13 color+blank, single rotation rainbow effect  
 Focus: option focus  
 Mode of control: DMX512/Master-slave/Stand-alone /Auto mode  
 Pan: 540degree (16bit) Electric correction  
 Tilt: 270degree (16bit) Electric correction



IP20

SKU: 687

NEW PRODUCT



### 60W LED Spot Moving Head +12x0.2W RGB

Input Voltage: AC100V-240V,50-60HZ  
 Total power: 100W  
 Light source: 1x60W white lamp bead, 12 RGB 0.2W lamp bead  
 Pattern: 7 patterns + white light  
 Color: 7 colors + white light  
 Channel: 10/12CH  
 Control mode: Voice control, master - slave, self - walk, DMX  
 Level: X axis: 540° Y axis: 270°

SKU: 66122



RGB



IP20



NEW PRODUCT



### 37x15w RGBW 4in1 Moving Head

Input Voltage: AC100V-240V,50-60HZ , rated power 600W  
 Light source: 37 15W high brightness quad-bead, light source life: 50000 hours on average  
 Zoom Angle: 5-60°  
 Stroboscopic flashing: 1-25 times/second  
 Control signal: DMX512, master/slave, voice control or self - program  
 Control channel: 20/60 two DMX channel modes  
 Applicable environment: indoor  
 Color: red, green, blue and white in one  
 Level: 540 degrees +16bit fine tuning;  
 Vertical: 270 degrees +16bit fine tuning  
 Product size: 386 mm\*423 mm\*263 mm

SKU: 66126



RGB



IP20

NEW PRODUCT



### 400W BSW 3in1 moving head with CMY and CTO

Input Voltage: AC100V-240V,50-60HZ Power Consumption: 430W  
 Color temperature: 8000K  
 Light source specification: SSL350W Lumen illuminance: 4 meters 80,000 lm  
 Focusing system: linear adjustment from 4 meters to 50 meters  
 Atomization system: 1 independent atomization effect, soft and natural light spot  
 High-speed strobe: 0-30 times/sec. Adjustable speed strobe effect.  
 Color: 12 colors + white light. Color half-color function  
 Color system: independent CMY+CTO color mixing system  
 Fixed patterns: 12 fixed patterns + white light  
 Prism system: standard single 6-row prism and 8 + 8 prism, each prism can be independently forward and reverse  
 Product size: 380\*270\*650 mm

SKU: 66125



IP20

NEW PRODUCT



### 37x15w RGBW 4in1 Moving Head

Input Voltage: AC100V-240V,50-60HZ , rated power 600W  
 Light source: 37 15W high brightness quad-bead, light source life: 50000 hours on average  
 Zoom Angle: 5-60°  
 Stroboscopic flashing: 1-25 times/second  
 Control signal: DMX512, master/slave, voice control or self - program  
 Control channel: 20/60 two DMX channel modes  
 Applicable environment: indoor  
 Color: red, green, blue and white in one  
 Level: 540 degrees +16bit fine tuning;  
 Vertical: 270 degrees +16bit fine tuning  
 Product size: 386 mm\*423 mm\*263 mm

SKU: 66123



RGB+W



IP20

NEW PRODUCT



### 5x60w Pixel Beam Wash Strobe Bar Led Moving Head

Input Voltage: AC100V-240V,50-60HZ Power Consumption: 500W  
 Light Source: Front: Original Osram 5x 60W RGBW 4in1 LED;  
 Back: 42x 3W White LED + 84x 0.3W RGB 3in1 LED  
 LED Control Feature: Front: 5pcs RGBW LED each Pixel control; Back: 14 sections pixel control, each section 9pcs led.  
 Control mode: DMX512, Sound, Master/Slave, Auto run & Sound active  
 Channel: 24CH/29CH/105CH - Zoom: 3.8° - 50°  
 Pan/Tilt movement: 360 degree infinite rotating  
 Power connector: Powercon in/out  
 DMX connector: 3-pin XLR in/out  
 Effect: Beam , Wash , Strobe Multiple Effect, Pan Tilt infinite rotating

SKU: 66124



RGB+W



IP20





### 120w Moving Head

Working voltage: AC95V-245V/50Hz  
 Product power: 120W  
 Pattern parameters: 10 patterns, 8 colors 4. Lamp bead parameters: 1 100W white light bead  
 Control mode: international general DMX512, 10 channels  
 Working mode: DMX512, master/slave, self-propelled, voice control  
 Dimming mode: 0~100% ultra-smooth dimming  
 Strobe: 20 times/second  
 Opening size: 22cm deep 8cm

SKU: 977



IP20



### 120W Three Prism Wash Gobo 2in1 Moving Head

Working voltage: AC95V-245V/50Hz  
 Total product power: 140W  
 Pattern parameters: 8 patterns, 8 colors 4. Lamp parameters: 1 80W white lamp, 6 5050 8W RGBW lamp beads  
 Control mode: international general DMX512, 15 channels  
 Working mode: DMX512, master/slave, self-propelled, voice control  
 Dimming mode: 0~100% ultra-smooth dimming  
 Strobe: 20 times/second  
 Opening size: 22cm deep 8cm

SKU: 974



RGB+W



IP20



### 4 LED Wash Moving Head

Working voltage: AC95V-245V/50Hz  
 Power sumption: 100W  
 Control mode: DMX512, auto, sound, master-slave  
 Channel: 15/10CH  
 Dimmer: 0-100% super dimmer  
 Strobe: 25 times per second

SKU: 976



IP20



### 100W Small Steel Cannon Moving Head

Working voltage: AC95V-245V/50Hz  
 Product power: 100W  
 Pattern parameters: 10 patterns, 8 colors 4. Lamp bead parameters: 1 80W white light bead  
 Control mode: international general DMX512, 10 channels  
 Working mode: DMX512, master/slave, self-propelled, voice control  
 Dimming mode: 0~100% ultra-smooth dimming  
 Strobe: 20 times/second  
 Opening size: 22cm deep 8cm

SKU: 975



IP20



### Mini Beam 100W

Power: 150W  
 Light source: 1pc 100W LED White color  
 Working lifetime: About 50000 hours  
 Working temperature: -20-40  
 Control mode: DMX 512, Auto, Master-slave, sound  
 Power Socket: Powercon In/Out  
 DMX socket: 3pin DMX In/Out  
 Prism: 8 prisms  
 Color wheel: 7colors+white  
 Gobo wheel: 7gobos+white  
 Size: 330x280x260mm

SKU: 973



IP20





### 60W RGBW LED 5050 SMD 3in1 MINI Moving Head

Input Voltage: AC100V-240V,50-60HZ  
 Power Consumption: 60W  
 Light Source: 60W RGBW LED with 5050 SMD 3in1 MINI moving  
 Control mode: DMX512,Sound, Master/Slave, Auto run&Sound active  
 Channel: 16/21 CH  
 Beam Angle: 8°  
 Product Size:160/150/230cm

SKU: 965



### Remote control LED 30W spot moving head

Voltage: AC100-240V, 50/60HZ 60W  
 Light Source: 1pc\*30W White Lamp Bead  
 Laser: Green 80mW  
 Control Channel: 9/11CH  
 Control Mode: Auto,DMX512,Master-slave,Sound  
 Pan/Tilt": 540 degrees / 270 degrees

SKU: 123



### 6x10W Bee Eyes Shaking Head + Laser

Voltage: AC100-240V 50/60 HZ  
 Total power: 120W  
 Light source 1: 6 Cree+ 10W four-in-one (RGBW) lamp beads  
 Light source 2: 1 515nm green laser  
 Channel: 15CH  
 Control mode: DMX512, master-slave, self-propelled, voice control  
 X-axis: 540°  
 Y-axis: 180°

SKU: 966



### 260 9R Beam Moving Head

Voltage: AC90-260V 50/60hz Power: 450W  
 Source: YODN MSD 260W 9R,  
 Average Lamp Life: 2000H Lumen Output: 10400LM  
 Color Wheel: 14 color + white, halftone effect adjustment  
 Gobo Wheel: 11 patterns + white  
 Prisms: 8prism + Honeycomb prism (2 prisms can be superimposed to 40, can be two-way independent rotation)  
 Pan: 540°(16bit accuracy) Tilt: 270°(16bit accuracy)  
 Motors: 14 super mute motors, XY three-phase motor  
 Frost/Atomization: independent frost effect, spot soft and natural  
 Channel: 16/20CHs  
 Size: 320\*220\*580mm (LWH)  
 Net Weight: 14.8kg

SKU: 124



### MINI 7x12W LED RGBW Moving Head

Input Voltage: AC100-240V/50-60Hz  
 Power consumption: 95W  
 Light Source: 7pcs 12W LEDs RGBW  
 DMX channel: 10CH/15CH  
 Control mode: DMX512,auto-run,sound-control,master-slave  
 Movement: Pan:540°Tilt:190°  
 Display: LED Display  
 Housing: LCP+Aluminium Alloy  
 Weight: 4.5kg  
 Dimension: 160\*150\*300 mm

SKU: 964



### 150W LED Beam Spot Wash 3in1 Moving Head

Voltage: AC100-240V,50/60Hz Power: 280W  
 Led source: 150W White LED  
 Led Life Time: 50000 Hours  
 Channel: 18 DMX channel  
 Pan: 540 degree + fine ; Tilt: 270 degree + fine  
 Zoom range: 8-17°  
 Strobe: 1-25 Hz with pulse effect  
 Color Wheel: 9 colors + open, with rainbow effect  
 Static Gobo Wheel: 10 gobos  
 Rotation gobo wheel: 6 gobos+open  
 Prism: 3 facet prism with bi-direction rotating  
 Frost: With frost effect  
 Display: LCD display, can adjust 180 degree to fit  
 Product size: 275\*200\*475mm  
 Net Weight: 9kg

SKU: 125





### 250W LED BSW Moving Head Light

Input Voltage: AC90-260V 50/60Hz  
 Power Consumption: 350W  
 Light Source: 250W High Output White LED  
 Control Signal: DMX 512, master-slave and sound activated or auto operation  
 Control Channel: 16/18 DMX Channels USITT DMX-512  
 Prism: 8-facet Prism, bi-directional rotatable at variable speeds  
 Dimensions: 320\*220\*480mm  
 Weight: 13.50kg

SKU: 981

LED



Light

IP20



### 60W LED Spot Moving Head Light

Voltage: 100-240V 50/60Hz  
 Power consumption: 80 W  
 Color: 8 colors  
 Gobo: 8 gobos  
 Channel: 9/11 ch  
 Light source: 1PCS 60W high power White LED  
 Control: DMX, Sound, Master-slave, Auto  
 Size: 198\*144\*272 mm  
 Net weight: 3.2 kg

SKU: 689

LED



Light

IP20



### 80W LED Zoom Beam Moving Head

Input voltage: 110-260 V, 50/60 Hz Power: 150W  
 Light source: 80W LED  
 Working lifetime: About 50000 hours  
 Control mode: DMX 512, Auto, Master-slave, Sound  
 Channel: 16ch /20ch  
 2DMX Modes: STD (16ch)/EXT (20ch)  
 Prism: 8 linear prism rotating ,16 linear prism rotating  
 Color Wheel: 13 colors+white  
 Gobo Wheel: 11 gobos+white,gobo-flow effect,gobo shake  
 Function: Dyeing, strobe, zoom, light beam effect  
 Pan: 540° (16bit) Tilt: 270° (16bit)  
 DMX socket: 3-pin IN/OUT  
 Power socket: Power Con IN  
 Dimensions: 460\*250\*290mm

SKU: 982

LED



Light

IP20



### 10W LED Moving Head Spot

Input power: AC100-240V 50/60Hz  
 Power consumption: 22W  
 Output LUX: 1500 LUX at 3 meters  
 LED: 1 PCS 10W high power white Cree LED  
 DMX Channel: 9/11 channels  
 Pan:X axis 540 degree ; Tilt:Y axis 270 degree  
 Control mode: DMX512/Master-slave/Auto/Sound  
 Display: LCD display  
 Color wheel: 7 color+open  
 Gobo Wheel: 7 gobo+open, gobo-flow effect,gobo shake  
 Feature: 8 internal program, sound mode can control by DMX512  
 Beam angle: 13 degree  
 Net weight: 2.5kg  
 Size: 140\*160\*290 cm

SKU: 984

LED



Light

IP20



### 36\*18W RGBWA+UV LED Moving Head+Zoom Light

Input Voltage: AC90-260V 50/60Hz  
 LED: 36 \*18W 6in1 RGBWA+UV LED moving  
 Power Consumption: 650W  
 Control Channel: 18/15 DMX channels  
 Control Signal: DMX512, master-slave and sound activated or auto operation  
 Power connection: Powercon In DMX data In/  
 Out: XLR 3pin(XLR 5pin is optional)  
 Packing Dimensions: 450\*320\*430mm  
 Weight: 9 kg

SKU: 983

LED



Light

IP20



### 6pcs LED Moving Head

Voltage: AC100V~240V/50~60Hz  
 Machine power: 120W  
 Lamp beads: 15W, RGBW four-in-one LED lamp beads  
 Lamp life: more than 50,000 hours  
 Lens: Lens Aspheric lens Supports DMX signal priority recognition, signal retention when DMX signal is interrupted  
 Beam angle: 1.5°  
 Spot angle: minimum 6°, maximum 51°  
 Color Rotation System: Color Rotation System: RGBW 4-in-1 Rotation, Macro Function Color System  
 Strobe: 1-30 times / sec electronic strobe and random strobe  
 Scanning system: horizontal 540° / 1.5 seconds, vertical 180° / 0.5 seconds

SKU: 986

LED



Light

IP20



### 200W LED Spot Moving Head

Input Voltage: AC100-240V 50/60Hz  
 Power: 200W  
 Light Source: 1 LED (white) 200 W,  
 Beam Angle: 16°  
 Colors: 7 + white, split colors, continuous scroll at variable speeds  
 Rotation wheel (1): 6 + open (5 aluminum + 1 glass), rotating,  
 interchangeable, slot-n-lock, continuous scroll at variable speeds  
 Static wheel (2): 8 + open (8 stamped), continuous scroll at variable speeds  
 Prism: 3-facet round, bidirectional rotation at variable speeds  
 Strobe Rate: 0 to 15 Hz  
 DMX Channels: 10 or 16  
 Control mode : DMX 512, master-slave , sound , Auto  
 DMX connector : 3-pin XLR connectors IN/OUT  
 Dimension: 290x194x432mm



SKU: 681 3800156606814

Light

IP20



### 90W LED Spot Moving Head Light

Voltage: 100-240V 50/60Hz  
 Power: 120v 60Hz 148W(0.1A)max,2A inrush  
 Beam angle: 14degrees  
 Channel: 14ch  
 Light source: 1PCS 90W high power White LEDs  
 Life rated: more than 50,000hrs  
 Size: 250\*255\*360mm  
 Net weight: 6kg  
 Carton size: 370\*360\*340mm



SKU: 985

Light

IP20



### 120W LED Spot Pattern Moving Head

Input Voltage: AC100-240V 50/60Hz  
 Power: 120W  
 Light Source: 1 LED (white) 120 W,  
 Beam Angle: 16°  
 Colors: 7 + white, split colors, continuous scroll at variable speeds  
 Rotation wheel (1): 6 + open (5 aluminum + 1 glass), rotating,  
 interchangeable, slot-n-lock, continuous scroll at variable speeds  
 Static wheel (2): 8 + open (8 stamped), continuous scroll at variable speeds  
 Prism: 3-facet round, bidirectional rotation at variable speeds  
 Strobe Rate: 0 to 15 Hz  
 Control mode : DMX 512, master-slave , sound , Auto  
 Cooling : Efficient low noise fan cooling system  
 DMX connector : 3-pin XLR connectors IN/OUT



SKU: 684 3800156606845

Light

IP20



### 7x40w LED Wash Moving Head RGBW Mixing Color

Input: 110-240 V, 50/60 Hz  
 Power: 320W  
 Light source: 7\* 40W RGBW 4in1 mixing color LED wash moving head  
 Control mode:DMX512,Auto,Master-slave,Sound  
 Channel:17ch/12ch  
 2DMX Modes:STD(17ch)/HSI(12ch)  
 Function:the dyeing effect,strobe,zoom, the beam light effect  
 Pan:540°(16bit)Electric correction  
 Tilt:270°(16bit)Electric correction  
 Zoom range:9°~ 50°  
 Dimmer:0-100% dimmer  
 Size:240x300x405mm



SKU: 682

RGBW

IP20



### 300W LED Moving Head

LED source: 300W LED ; 8000K white LED,16\*10W RGBW  
 Working Time (hours): 50000  
 Fixed gobo wheel: 8 fixed gobos + open and bi-direction rotation  
 Color Temperature(CCT): 6000K (Daylight Alert)  
 Pan X: 540 degree, Tilt Y: 270 degree  
 Channel: 25ch/18ch Dimmer from 0-100%, Strobe  
 Beam angle: 3 degree 1 rotate gobo wheel (7 gobos + open) and 1 fixed  
 gobo wheel (8 gobos + open)  
 1 Color wheel: 7 main colors + open with rainbow effect 2 Prism disk,  
 Rotation prism,  
 Focus Temperature protect function powercon in & out, color screen,  
 Silent fan, good housing Pan/Tilt 0-255 speed controllable



SKU: 126

Light

IP20



### 12x10w LED Moving Head RGBW

Voltage: AC 110-240V 50/60 Hz  
 Power: 150W  
 LED QTY: 12\*10W RGBW 4in1 LED Moving Head Light  
 Lumens: 4500+, Lux @2m 40500+  
 Control: Master-Slave / Auto / Sound / DMX  
 Channel control: 15CH  
 Dimmer: 0-100%  
 Flash: 0-20Hz  
 Pan / Tilt: User -selectable Pan / Tilt ranges  
 Pan/ Tilt: 540 degrees / 270 degrees  
 Fine Turning: 8-16 bit  
 Color: Black / White  
 Size: 300x245x385mm



SKU: 688

RGBW

IP20





### 19x15W AURA LED Beam Moving Head Light Zoom RGBW

Input Voltage: AC90-260V 50/60Hz  
 Power Consumption: 300W  
 Zoom range: 8-28degree. Motor: 3pcs  
 Control mode: DMX512, master-slave, Sound, Auto  
 Channel: 14/25CHs  
 Beam (Primary LED array): provide the main output  
 Aura (Secondary background LED array): illuminate the front of the head, provide local diffuse light output and can be set to contrast with the beam output.  
 Beam: RGBW color control with color temperature control  
 Aura: RGB control ; Dimming: 0-100% smoothly dimmer  
 Strobe: 20t/s strobe effect with variable speed and pulse effects  
 540° PAN and 270° TILT movement  
 Size: 410x320x470mm



RGBW



IP20

SKU: 693



### 4x12W LED Moving Head Light RGBW

Voltage: AC 100\*240v 50/60 hz  
 Power Consumption: 60w  
 Lighting Source: 4\*12w RGB+W  
 RGBW color mixing  
 DMX Channels: Two DMX channels model , 11 or 18  
 Control Mode: Auto, Sound Active, Master/Slave, DMX 512  
 Dimming: 0-100%  
 Strobe: slow to fast  
 Pan: 540 degrees, Tilt: 180 deagrees  
 Size: 300x20x240mm



RGBW



IP20

SKU: 933

#### Power CON IN



SKU: 679 Female



SKU: 960 Male

#### XLR 3PIN -Male , Female - LH P005A



SKU: 678 Male



SKU: 963 Female

#### Power CON OUT



SKU: 961 Female



SKU: 962 Male

#### Hook

SKU: 698 30mm  
SKU: 699 50mm

#### Safety Rope



SKU: 697



### Spark Firework Machine

Voltage: AC 110-240V 50/60 HZ  
 Power: 400W  
 Control: DMX, remote control  
 Temperature: (-10/+50°C)  
 Height: 1-5 m  
 Spray direction: erect  
 DMX Channel: 2  
 NW: 9.5 kg



IP20

SKU: 902



### Stage Fog Waterproof Spark Machine

Power: 400W  
 Control: DMX, Remote control  
 Temperature (-10/+50°C)  
 Height: 1-4 meter  
 Spray direction fall  
 DMX Channel: 2  
 Machine Size: 200x200x180mm  
 NW: 6.5KG



IP54

SKU: 903



### LPG Fire Machine

Voltage: AC110-240V 50/60HZ  
 Power: 250W  
 Spary Height: 1-2 meter  
 Control: DMX512/Electric Control/remote control  
 DMX Channel: 1  
 Gas: LPG fire gas bottle  
 Machine Size: 420x165x200mm  
 NW: 7KG



IP20

SKU: 904



### Firebolt Fire Machine

Voltage: AC110-240V 50/60HZ  
 Power: 250W  
 Spary Height: 1-4 meter  
 Control: DMX512/remote control  
 DMX Channel: 4  
 Gas: LPG Gas bottle  
 Machine Size: 50x35x27CM  
 NW: 13KG



IP20

SKU: 905



### Fog Machine Hand-held CO2 Gun

DJ CO2 Gun only needs a container with CO2. Easy to operate. This product is recommended for DJs, discos, bars and parties.

JET DIST: 6 m  
NW: 3.2 kg

SKU: 901



### LED Fog Machine 900W

Voltage: AC110-240V 50/60HZ  
Power: 920W  
Control: remote control  
Re-heating time: 3 mins  
LED: 3WX6pcs  
Capacity of oil tanks 1.5L  
Size:385x230x140mm  
NW 4KG

SKU: 911



### Water Low Fog Machine

Voltage: AC110-240V 50/60HZ  
Power: 3000W  
Cover area:150-200 square meter  
Control:DMX512/remote control/manual  
DMX Channel: 2  
Consumable materials: water+heavy fog liquid  
Capacity of fog tank: 3L  
Capacity of water tank: 15L  
Machine Size: 714x400x316mm  
GW: 52KG

SKU: 908



### Fog Machine 1000W

Voltage: AC110 - 240V 50/60HZ  
Power: 1000W  
Control: remote control/wire control  
Re-heating time: 5 mins  
Capacity of oil tanks 1 L  
Size: 360x200x130mm  
NW: 4KG

SKU: 912



### Dry Ice Machine 3000W

Voltage: AC110-240V 50/60HZ  
Power: 3000W  
Cover area: 100-200 square meter  
Control: Manual  
Consumable materials: Dry ice and water  
Machine Size: 660x 370x580mm  
NW: 16KG

SKU: 909



### Fog Machine 1500W

Voltage AC110 240V 50/60HZ  
Power: 1500W  
Control:remote contro/DMX 512  
Re-heating time: 5 mins  
Capacity of oil tanks 3 L  
Size 510x260x150mm  
NW: 6KG

SKU: 913



### Fog Machine 900W

Voltage AC220V-240V 50/60HZ  
Power: 900W  
Control:remote control/wire control  
Re-heating time 5 mins  
Capacity of oil tanks 1.5L  
Body color: black with hanging bracket  
Machine Size:36.5x18.5x17cm  
NW 3KG

SKU: 910



### LED Fog Machine 1500W

Voltage: AC110-240V 50/60HZ  
Power: 1520W  
Control: remote contro/wire control/ time  
Re-heating time: 5 mins  
Capacity of oil tanks: 2.5 L  
Machine Size: 540x330x260mm  
NW: 6KG

SKU: 914





### 900W Fog Machine Remote

Voltage: AC220V-240V 50/60HZ  
 Power: 900W  
 Control: remote control/wire control  
 Re-heating time: 40s  
 Capacity of oil tanks: 1.5L  
 Body color: black with hanging bracket  
 Machine Size: 530×270×320cm  
 Weight: 3KG

SKU: 910.2



IP20



### DMX384 Moving Light Control

DMX384 moving light control DMX512 controller for controlling spectacular stage lighting.

Channels: 384  
 DMX input/output: 3 pin male/female XLR  
 Power supply: DC 9V 1000mA  
 Dimensions: 520mm×183mm×73mm  
 Weight: 2.6 kg

SKU: 696



IP20



### 300W Bubble Machine

Voltage: AC 110/230V 50-60Hz ± 10%  
 Power: 200W  
 Bubble Oil Capacity: 2.5L  
 Bubble covered area: 200 m<sup>2</sup>  
 Control: Remote control (30) meters, manual  
 Product Dimensions: 415×250×415mm  
 Weight: 12 kg

SKU: 968



IP20



### Wireless DMX512 Controller

Input voltage: 9-12V DC 300mA min  
 Communication distance: 700m (visible distance)  
 Operating frequency: 2.4G ISM, 126 frequency band  
 Maximum transmission power: 20dBm  
 Receive sensitivity: -94dBm  
 DMX signal output: 3/5 pin XLR  
 Dimensions: 75 x 147 x 43mm  
 Weight: 360g

SKU: 662



IP20



### LED RGB CO2 Machine

LEDs: 12x3w RGB 3 in 1  
 Voltage: AC220/110V 50/60HZ  
 Power: 250W  
 Control: DMX512, remote control  
 DMX channels: 9  
 Column height: 8-10 m  
 Machine Size: 310×310×430 mm  
 Weight: 7.0KG

SKU: 664



RGB



IP20



### DMX Power Splitter

3 pin XLR IN/OUT  
 Power: 15W  
 Output: 4 or 8 DMX  
 Size: 430x50x180mm  
 Net weight: 2.35kg

SKU: 694 Output: 4 DMX



SKU: 695 Output: 8 DMX



IP20





### Fog Machine 3000W

Voltage: AC110~240V 50/60HZ  
 Power: 3000W  
 Control: DMX512/remote control  
 Re-heating time: 5 mins  
 Capacity of oil tanks: 5L  
 Size: 68x31x20CM  
 NW: 13KG

SKU: 915



FOG



### Portable Haze Machine

Voltage: AC110~240V 50/60HZ  
 Power: 1500W  
 Re-heating time: 45 sec  
 Control: DMX512/ Remote control/Manual  
 Use consumables: Water based haze liquid  
 Capacity of oil tank: 2L  
 Size: 325x153x340mm  
 NW: 8KG

SKU: 916



HAZE



### Hanging Type Haze Machine

Voltage: AC110~240V 50/60HZ  
 Power: 1000W  
 Warm-up time: 30 sec  
 Control: DMX512/ Remote control/Manual  
 Use consumables: Water based haze liquid  
 Capacity of oil tank: 2L  
 Weight: 9kg  
 Size: 440x340x340mm

SKU: 917



HAZE



### Hand Confetti Machine

Voltage: AC110~240V 50/60HZ  
 Confetti capacity: 0.5kg  
 Control: Manual  
 Use consumables: Bullion paper/Color paper  
 Gas: Co2/N2  
 Weight: 7kg  
 Size: 970x300x210mm

SKU: 906



Confetti



### Oil Based Haze Machine

Voltage: AC110~240V 50/60HZ  
 Power: 650W  
 Re-heating time: 0 second  
 Capacity of oil tank: 2.5L  
 Control: DMX-512,remote control, Manual  
 Machine size: 590x450x450mm  
 NW: 23KG

SKU: 918



HAZE



### LED Electric Confetti Machine

Voltage: AC110~240V 50/60HZ  
 Power: 1236W  
 Control: DMX 512,remote control  
 Height of ejection: 6-8M  
 DMX Channel: 7  
 Confetti capacity: 0.5KG  
 Size: 280x280x550mm  
 NW: 8KG

SKU: 907



Light



Confetti



**OPTONICA COMFORT PRODUCTS**



**WiFi E27 SMART CAMERA BULB**

Video resolution: HD  
Frame rate: 25fps  
View angle: 360 degrees (Horizontal)  
90 degrees (Vertical)  
Motion detection: About 5 meters  
Night vision: About 5 meters  
Max memory: Up to 128Gb (Not Include)  
App: JXLCAM

**SKU: 227**



E27



IP20



**WiFi SMART CAMERA BULB**

Video resolution: HD  
Frame rate: 25fps  
View angle: 360 degrees (Horizontal)  
90 degrees (Vertical)  
Motion detection: About 5 meters  
Night vision: About 5 meters  
Max memory: Up to 128Gb (Not Include)  
App: JXLCAM

**SKU: 244**



EU Plug Socket



IP20



Window cleaning  
**Robot**

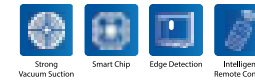

Window cleaning  
**Robot**

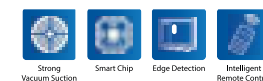

Cleaning speed 2 minutes / m2  
Power 80W  
Size 300x150x120mm  
Cleaning Modes 3 modes

SKU: 757



Cleaning speed 2 minutes / m2  
Power 80W  
Size 250x250x9.5mm  
Cleaning Modes 3 modes  
UPS 20min

SKU: 758



## Air Purifier & Humidifier

*Breathe Cleaner and Healthier Air*

**7 Stage Air Purification + Humidifier**  
**UV Lamp and IONIZER + WIFI**

CADR(PM2.5)	450m <sup>3</sup> /h
Power	85W
Area	~50 m <sup>2</sup>
Size	400x230x620mm
Purification	Pre-filter, Cold-catalyst, Formaldehyde removal filter (Honeycomb activated carbon filter Optional), Antibacterial filter, UV Sterilization, HEPA filter, Anion release.
SKU: 733	3800156607330



## Air Purifier

*Breathe Cleaner and Healthier Air*

**6 Stage Air Purification**  
**UV Lamp and IONIZER**

CADR(PM2.5)	150m <sup>3</sup> /h
Power	43W
Area	~30 m <sup>2</sup>
Size	330x180x505mm
Purification	Cold-catalyst, Formaldehyde removal filter (Honeycomb activated carbon filter Optional), Antibacterial filter, UV Sterilization, HEPA filter, Anion release.
SKU: 731	3800156607316



## Air Purifier & Humidifier

*Breathe Cleaner and Healthier Air*

**6 Stage Air Purification + Humidifier**  
**UV Lamp and IONIZER**

CADR(PM2.5)	300m <sup>3</sup> /h
Power	65W
Area	~38 m <sup>2</sup>
Size	360x195x565(mm)
Purification	Cold-catalyst, Formaldehyde removal filter (Honeycomb activated carbon filter Optional), Antibacterial filter, UV Sterilization, HEPA filter, Anion release.
SKU: 732	3800156607323



## Air Purifier

*Breathe Cleaner and Healthier Air*

**7 Stage Air Purification**  
**UV Lamp and IONIZER**

CADR(PM2.5)	320m <sup>3</sup> /h
Power	80W
Area	~40 m <sup>2</sup>
Size	370x195x605mm
Purification	Pre-filter, Cold-catalyst, Formaldehyde removal filter (Honeycomb activated carbon filter Optional), Antibacterial filter, UV Sterilization, HEPA filter, Anion release.
SKU: 734	3800156607347







LED FLOOR LIGHT  
**20W - Remote Control**



Watts	20W	CRI	Ra>80
Input Voltage	AC : 220-240V	IP Rating	IP20
Flux	500lm	Dimension	130x1045 mm
Beam Angle	120°	Dimmable	YES

SKU: 237  
RGB+3000K

DIY modular assembly  
Multiple mode changes



LED FLOOR LIGHT  
**17W - Remote Control**



Watts	17W	CRI	Ra>80
Input Voltage	AC : 220-240V	IP Rating	IP20
Flux	400lm	Dimension	φ23.5x1462 mm
Beam Angle	120°	Dimmable	YES

SKU: 238  
RGB+3000K

DIY modular assembly  
Multiple mode changes

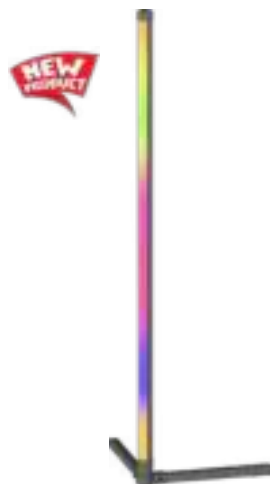

LED FLOOR LIGHT 5V  
**8W - Remote Control**



\* AC Adapter NOT Included

Watts	8W	CRI	Ra>80
Input Voltage	DC 5V 2A	IP Rating	IP20
Flux	220lm	Dimension	Φ30x1047 mm
Beam Angle	120°	Dimmable	YES

SKU: 239  
RGB+6000K

DIY modular assembly  
Multiple mode changes



POWER BANK - WATERPROOF  
**10000 mAh**



Battery: 10000MAh  
Rated Power: 37Wh/3.7V  
Input Micro :5V/2A  
Input Type-C: 5V/3A  
Output USB1/2 t: 5V/3A  
Output Type-C : 5V/3A  
Solar Panel:1.2W  
Size: 159\*78\*19.5mm  
Flashlight:2W LED

SKU: 7691 Black Body



POWER BANK - WATERPROOF  
**20000 mAh**



Battery: 20000MAh  
Rated Power: 74wh/3.7V  
Input Micro :5V/2A  
Input Type-C: 5V/3A  
Output USB1/2 t: 5V/3A  
Output Type-C : 5V/3A  
Solr Panel:1.2W  
Product Size: 167\*86\*33.5mm  
Flashlight:4w Led

SKU: 7692 Black Body



POWER BANK  
**10000 mAh**



Battery: 10000mAh  
Rated Power: 3.7V/37Wh  
Input Micro :1 DC 5V/2A | 9V/2A | 12V/1.5A  
Input Type-C :2 DC 5V/3A | 9V/2A | 12V/1.5A  
Output1 Type-C DC 5V/3A | 9V/2A | 12V/1.5A  
Output2 USB-A/B DC 4.5V/5A | 5V/4A | 9V/2A  
Product Size: 140\*69\*15.5mm

SKU: 7693 White Body  
SKU: 7694 Black Body



POWER BANK  
**20000 mAh**



Battery: 20000mAh  
Rated Power: 3.7V/74Wh  
Input Micro :1 DC 5V/2A | 9V/2A | 12V/1.5A  
Input Type-C :2 DC 5V/3A | 9V/2A | 12V/1.5A  
Output1 Type-C DC 5V/3A | 9V/2A | 12V/1.5A  
Output2 USB-A/B DC 4.5V/5A | 5V/4A | 9V/2A  
Product Size: 140\*69\*27.5mm

SKU: 7695 Black Body

**SMART CAMERA ROBOTIC VACUUM CLEANER**

SKU: 752



**BRUSHLESS VACUUM MOTOR+ROLLER BRUSH**

Clean thoroughly



1 Side Brush	2 Power Button	3 Camera	4 Power Switch
5 Glass Cover	6 Anti-drop Sensor	7 Charging Connect	8 Universal Wheel
9 Battery Cover	10 Wheel	11 Roller Brush	12 Mop

**Working Time Per Charge: 80-120mins**

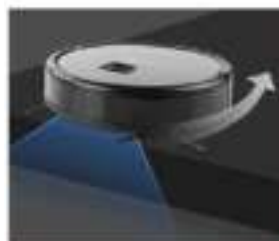

**ANTI-DROP SENSORS**

Keep machine safety away from stairs

**ANTI-COLLISION SENSORS**

Effective protect machine and furniture



**EASY CLIMBING**

Moves over thresholds

**GO TO CLEAN UNDER THE FURNITURE**

Without omission



**AUTOMATIC CHARGING**

Back to charging dock automatically when battery is low

**BREAKPOINT RESUME OPERATION**

After charging, machine returns to breakpoint, continue to clean the remaining area.



**SMART GYRO ROBOTIC VACUUM CLEANER**

SKU: 753



**GYROSCOPE NAVIGATION  
MULTIPLE CLEANING MODES**

**AUTO CLEANING ROBOTIC VACUUM CLEANER**

SKU: 754



**ROADROVER WHEELS**

Climbing ability reach 2cm  
With cross-country wheel,  
Easy go crossing the obstacle

**10 PAIRS OF INFRARED ANTI-COLLISION SENSORS**



**AUTOMATIC DOCK AND CHARGING**



**STRONG SUCTION**

Up to 1000PA, no dust can hide from it



**VARIOUS GROUND TYPE APPLICATION**

Suitable for various floor type, low pile carpet, tile, wood floor, etc



**3 in 1 Wireless Charging Station**  
Apple iPhone/AirPods/iWatch  
Samsung Phone/Buds/Watch



Wireless Charging IP20

3-in-1 Wireless Charging Compact Design Phone Stand

SKU: 9500 For iPhone  
SKU: 9501 For Samsung

**3 in 1 Multifunction Desk Lamp**  
Wireless Charging



Wireless Charging IP20

3-in-1 Wireless Charging Phone Stand

SKU: 9512 Black Body

**6 in 1 Multi-function Charging Station**  
Match multiple devices



Wireless Charging IP20

for phone for iWatch for AirPods

SKU: 9502 Black Body  
SKU: 9503 White Body

**3 USB Quick Charger**  
36W Max Power **PD + 3USB**



IP20

quick charge 3 USB ports PD 20W smart chip

SKU: 9510 Black Body  
SKU: 9511 White Body

**Wireless Charger Pad**  
Qi Standard



Compact Design Wireless Charging IP20

● Universal input: 5.0V=2A Universal output: 5.0V 1A  
● Fast charge input: 9.0V 2A Fast charge output: 9.0V 1.2A

SKU: 9508 Black Body  
SKU: 9509 White Body

**Car Wireless Charger Stand**  
36W Max Power



Wireless Charging IP20

**10W**  
Wireless charging   
Steady Large area induction coil

SKU: 9506 Gold Body  
SKU: 9507 Silver Body



**Wireless Charging Clock**  
supports iOS and Android

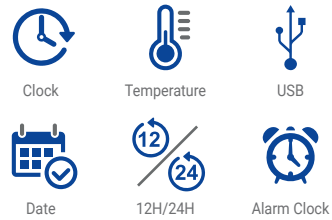

SKU: 9514 Clock

**Solar Portable Bluetooth Speaker + Lamp**  
Solar Panel Power: 5V/3.5W



- SOS Emergency Light
- Power Bank Function
- USB Ports

Battery  
**3.7V 6Ah**

SKU: 223  
CCT  
6000K 4500K 3000K



**Bluetooth FM Transmitter**  
Car Charger With MP3 Player



SKU: 9504 FM Transmitter

**3 in 1 Magnetic USB Cable**  
Type-C, Micro USB, For Apple



SKU: 9516 Charging Cable

**Solar Portable Bluetooth Speaker + Lamp**  
Solar Panel Power: 5V/3.5W



- SOS Emergency Light
- Power Bank Function
- USB Ports

Battery  
**3.7V 6Ah**

SKU: 224  
CCT  
6000K 4500K 3000K



**CCT Selfie Ring Light**  
10W 5V USB - Dimmable



Watts 10W  
Input Voltage 5V USB  
Flux 800lm  
Beam Angle 120°  
Dimmable YES

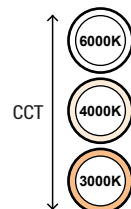

SKU: 9515 Selfie Ring Light

**Solar Portable Bluetooth Speaker + Lamp**  
Solar Panel Power: 5V/3.5W



- SOS Emergency Light
- Power Bank Function
- USB Ports

Battery  
**3.7V 6Ah**

SKU: 228  
CCT  
6000K 4500K 3000K





SKU: 7601 - 3 Sockets 1.5m 16A  
SKU: 7602 - 3 Sockets 3m 16A



SKU: 7607 - 3 Sockets 1.5m 16A  
SKU: 7608 - 3 Sockets 3m 16A

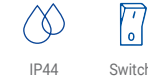
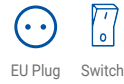

SKU: 7613 - 4 Sockets 5m 16A



SKU: 7614 - 6 Sockets 10m 16A



SKU: 7603 - 4 Sockets 1.5m 16A  
SKU: 7604 - 4 Sockets 3m 16A



SKU: 7609 - 4 Sockets 1.5m 16A  
SKU: 7610 - 4 Sockets 3m 16A

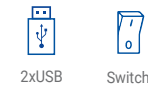
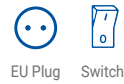

SKU: 7615 - 3 Sockets 1.5m 16A



SKU: 7616 - 5 Sockets 1.5m 16A



SKU: 7605 - 5 Sockets 1.5m 16A  
SKU: 7606 - 5 Sockets 3m 16A



SKU: 7611 - 5 Sockets 1.5m 16A  
SKU: 7612 - 5 Sockets 3m 16A

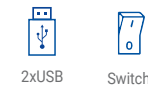
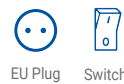

SKU: 7617 - 3 Sockets 3m 16A



SKU: 7618 - 5 Sockets 3m 16A

Reel: 1000W(4.35A)  
Unreel: 3200W(13.91A)



SKU: 7623 - 4 Sockets 25m 16A

Reel: 1100W(4.8A)  
Unreel: 3200W(13.91A)



SKU: 7624 - 4 Sockets 10m 16A



IP44

SKU: 7631 - Schuko Male 16A



IP44

SKU: 7632 - Schuko Female 16A



IP44

SKU: 7625 - 2 Sockets 5m 16A



IP44 Timer

SKU: 7626 - 2 Sockets 5m 16A



SKU: 7633 - Schuko Male 16A



SKU: 7634 - Schuko Female 16A



SKU: 7635 - 2 Sockets Adapter 16A



IP44

SKU: 7637 - 2 Sockets Adapter 16A



SKU: 7621 - 1 Sockets 10m 16A  
SKU: 7622 - 1 Sockets 20m 16A



SKU: 7636 -3 Sockets 16A





SKU:	Page No.	SKU:	Page No.	SKU:	Page No.	SKU:	Page No.	SKU:	Page No.	SKU:	Page No.	SKU:	Page No.	SKU:	Page No.	SKU:	Page No.	SKU:	Page No.	SKU:	Page No.		
2071	86	2349	187	2439	186	2503	133	2644	181	2741	162	2847	144	2916	136	3271	196	4431	213	4552	235	4800	207
2072	87	2350	163	2440	186	2504	133	2666	178	2744	165	2848	144	2917	136	3272	196	4432	213	4553	235	4801	207
2073	87	2351	163	2441	186	2505	132	2669	178	2745	165	2849	145	2918	136	3273	196	4433	213	4554	235	4802	207
2074	87	2363	163	2442	186	2506	133	2670	178	2746	170	2850	145	2919	136	3274	196	4441	218	4555	235	4807	207
2075	87	2372	167	2443	186	2535	122	2671	178	2770	162	2851	145	2920	136	3275	196	4451	213	4561	241	4808	207
2080	74	2373	167	2444	187	2536	122	2672	178	2771	162	2852	145	2921	137	3276	196	4452	213	4562	241	4809	208
2081	74	2374	167	2445	187	2537	122	2673	178	2772	167	2853	145	2922	137	3277	196	4453	213	4563	241	4810	208
2082	74	2382	163	2446	187	2538	122	2674	178	2773	167	2854	145	2923	137	3278	196	4454	219	4564	240	4811	208
2083	74	2383	163	2447	187	2539	123	2675	178	2776	163	2855	145	2924	137	3284	192	4455	219	4580	237	4823	207
2084	399	2384	163	2448	187	2540	123	2676	178	2777	163	2856	145	2925	137	3285	192	4456	219	4581	237	4825	207
2085	374	2391	167	2449	187	2541	123	2677	178	2780	170	2857	145	2926	137	3286	192	4461	218	4582	237	4827	207
2086	374	2392	167	2450	187	2542	123	2678	179	2781	170	2858	146	2927	137	3287	193	4462	218	4583	237	4838	208
2087	374	2394	168	2451	187	2581	188	2680	179	2782	170	2859	146	2928	137	3288	193	4463	218	4584	237	4840	208
2088	374	2395	168	2452	187	2582	188	2681	179	2788	168	2860	147	2929	138	3289	193	4471	218	4585	237	4841	208
2089	375	2396	168	2453	187	2583	188	2682	179	2789	168	2861	147	2930	138	3290	192	4480	220	4586	237	4842	208
2090	375	2397	168	2454	187	2584	188	2683	179	2790	168	2870	142	2931	138	3291	192	4481	221	4587	237	4843	208
2091	375	2398	168	2455	187	2585	188	2684	179	2791	169	2871	142	2941	130	3292	192	4482	221	4588	237	4850	211
2092	375	2399	168	2456	187	2586	190	2686	179	2792	169	2872	142	2942	130	3293	193	4483	220	4589	237	4851	211
2093	377	2401	124	2470	182	2587	190	2687	179	2793	169	2873	142	2943	130	3294	193	4484	220	4590	236	4852	211
2094	377	2402	124	2471	182	2590	184	2688	179	2794	169	2874	142	2944	131	3295	193	4485	219	4591	236	4853	211
2095	374	2403	124	2472	182	2591	184	2689	179	2795	169	2875	142	2945	131	3296	191	4486	219	4592	236	4854	211
2096	374	2404	124	2473	182	2592	184	2701	164	2796	169	2876	142	2946	131	3297	191	4487	220	4593	236	4855	211
2231	126	2405	124	2474	182	2593	184	2702	164	2797	169	2877	142	3201	194	3298	191	4488	220	4594	236	4856	211
2232	126	2406	124	2475	182	2594	185	2703	164	2798	169	2878	142	3202	194	3299	191	4490	223	4595	236	4857	211
2235	126	2407	124	2476	182	2595	185	2704	164	2799	169	2879	143	3203	194	4311	209	4491	223	4596	236	4858	211
2236	126	2408	124	2477	182	2596	185	2705	164	2801	141	2880	143	3204	194	4312	209	4492	223	4597	236	4861	209
2237	127	2409	124	2478	182	2597	185	2706	164	2802	141	2881	143	3205	194	4313	205	4511	240	4598	236	4862	209
2238	127	2410	124	2479	182	2601	180	2707	164	2803	141	2882	143	3206	194	4314	205	4512	240	4599	236	4865	216
2241	127	2411	124	2480	182	2602	180	2708	164	2804	141	2883	143	3207	194	4315	209	4513	240	4611	239	4866	216
2242	127	2412	124	2481	182	2603	180	2711	165	2805	141	2884	143	3212	194	4316	209	4514	240	4612	239	4867	216
2243	126	2413	125	2482	182	2604	180	2712	165	2806	141	2885	143	3222	194	4321	224	4515	240	4613	239	4904	210
2244	126	2414	125	2483	182	2605	180	2713	165	2807	140	2886	143	3223	194	4322	224	4516	240	4700	204	4905	210
2245	126	2415	125	2484	182	2606	180	2714	172	2808	140	2887	143	3224	194	4323	224	4521	240	4702	204	4906	210
2246	126	2416	125	2485	183	2608	180	2715	172	2809	140	2888	148	3225	194	4324	226	4522	240	4703	204	4911	210
2247	126	2417	125	2486	183	2609	180	2716	172	2810	140	2889	148	3241	195	4325	226	4523	240	4704	204	4912	210
2248	126	2418	125	2487	183	2610	180	2717	165	2811	140	2901	134	3242	195	4326	226	4524	240	4706	204	4913	210
2249	126	2419	125	2488	183	2611	180	2718	165	2812	140	2902	134	3243	195	4327	226	4525	240	4710	204	4921	210
2250	126	2420	125	2489	183	2612	180	2726	166	2813	140	2903	135	3251	195	4328	225	4526	240	4711	204	4922	210
2251	127	2421	125	2490	183	2613	180	2727	166	2814	140	2904	135	3254	195	4329	225	4531	241	4720	206	4923	210
2252	127	2422	125	2491	183	2614	181	2728	166	2815	140	2905	134	3260	197	4330	225	4532	241	4721	206	4931	215
2253	127	2423	125	2492	183	2615	181	2731	172	2816	140	2906	134	3261	197	4403	222	4533	241	4731	206	4932	215
2254	127	2424	125	2493	183	2616	181	2732	172	2817	140	2907	135	3262	197	4404	222	4534	241	4732	206	4933	215
2255	127	2431	186	2494	183	2617	181	2733	172	2818	140	2908	135	3263	197	4405	222	4535	241	4733	206	4934	215
2256	127	2432	186	2495	183	2618	181	2734	166	2840	144	2909	134	3264	192	4406	222	4541	234	4734	206	4935	215
2257	127	2433	186	2496	183	2619	181	2735	166	2841	144	2910	134	3265	192	4421	213	4542	234	4735	206	4936	215
2258	127	2434	186	2497	183	2630	181	2736	166	2842	144	2911	135	3266	192	4422	213	4543	234	4736	206	4937	215
2297	149	2435	186	2498	183	2631	181	2737	166	2843	144	2912	135	3267	193	4423	213	4544	234	4740	204	4938	215
2335	186	2436	186	2499	183	2632	181	2738	166	2844	144	2913	136	3268	193	4424	219	4545	234	4761	205	4939	215
2336	186	2437	186	2501	132	2642	181	2739	166	2845	144	2914	136	3269	193	4425	219	4546	234	4762	205	4940	216
2348	187	2438	186	2502	132	2643	181	2740	162	2846	144	2915	136	3270	196	4426	219	4551	235	4763	205	4941	212

SKU:	Page No.	SKU:	Page No.	SKU:	Page No.	SKU:	Page No.	SKU:	Page No.	SKU:	Page No.	SKU:	Page No.	SKU:	Page No.	SKU:	Page No.	SKU:	Page No.	SKU:	Page No.	SKU:	Page No.
4942	212	5041	201	5102	228	5183	228	5257	300	5332	287	5392	292	5465	315	5540	99	5710	318	5768	320	5886	325
4943	212	5042	201	5103	228	5184	227	5258	300	5334	299	5393	292	5466	315	5541	100	5711	318	5770	320	5887	325
4944	212	5043	201	5104	227	5185	227	5259	300	5335	299	5394	292	5467	315	5542	100	5712	318	5771	321	5888	325
4945	212	5044	200	5105	227	5188	175	5261	302	5336	299	5395	294	5468	312	5543	100	5713	318	5772	321	5889	325
4946	212	5045	200	5106	227	5190	227	5262	302	5337	299	5396	294	5470	282	5544	100	5714	318	5773	321	5890	325
4947	214	5046	200	5107	228	5191	227	5263	303	5338	299	5397	294	5471	282	5545	100	5715	318	5774	321	5891	325
4948	214	5047	285	5108	227	5192	227	5264	303	5339	299	5398	293	5472	282	5546	100	5721	319	5775	321	5892	325
4949	214	5051	420	5109	228	5193	227	5265	302	5340	292	5399	293	5473	312	5547	100	5722	319	5776	321	5893	325
4950	214	5052	420	5110	228	5197	175	5266	302	5341	292	5400	293	5474	312	5548	100	5723	319	5777	321	5894	325
4951	238	5053	420	5111	229	5198	175	5267	302	5342	292	5401	335	5475	312	5549	100	5724	319	5778	321	5900	328
4952	238	5054	420	5112	229	5201	304	5268	302	5343	292	5402	335	5480	306	5588	98	5725	319	5779	321	5901	328
4953	238	5055	420	5113	227	5202	304	5269	302	5344	294	5403	334	5481	306	5589	98	5726	319	5780	321	5902	328
4954	238	5056	421	5114	230	5203	304	5270	302	5345	294	5404	334	5482	306	5590	98	5727	319	5781	321	5903	328
4955	238	5057	421	5115	230	5204	304	5271	303	5346	294	5405	334	5483	306	5591	98	5728	319	5786	326	5904	328
4956	238	5058	421	5116	230	5205	304	5272	303	5347	293	5411	291	5484	306	5592	98	5729	319	5787	326	5905	328
5001	229	5060	283	5117	230	5206	304	5273	303	5348	293	5412	291	5485	306	5593	98	5730	319	5788	326	5906	328
5002	229	5061	283	5118	230	5207	304	5277	339	5349	293	5413	291	5486	306	5594	98	5731	319	5789	326	5907	328
5003	189	5062	283	5119	230	5208	304	5279	339	5350	291	5414	291	5487	306	5595	98	5732	319	5790	326	5908	328
5004	189	5063	283	5120	230	5209	304	5291	314	5351	291	5415	291	5488	306	5596	98	5733	319	5791	326	5909	328
5005	189	5064	283	5121	230	5211	304	5292	314	5352	291	5416	296	5489	306	5597	98	5734	319	5792	327	5910	328
5006	189	5065	283	5122	230	5212	304	5293	314	5353	291	5417	296	5490	309	5598	98	5735	319	5793	327	5911	328
5007	289	5066	283	5123	230	5213	304	5294	314	5354	297	5418	296	5491	309	5599	98	5736	340	5794	327	5912	328
5008	289	5067	283	5124	230	5214	304	5295	314	5355	297	5419	296	5492	309	5601	103	5737	340	5795	327	5913	328
5009	289	5068	283	5125	230	5215	304	5296	314	5356	297	5420	291	5493	309	5602	103	5738	340	5796	327	5914	328
5010	289	5070	70	5128	231	5216	301	5297	314	5357	297	5421	291	5494	308	5603	103	5739	340	5797	327	5915	329
5011	289	5071	70	5130	231	5217	301	5303	332	5358	291	5422	291	5495	308	5604	103	5741	322	5818	341	5916	329
5012	289	5072	70	5132	231	5221	305	5304	332	5360	291	5423	291	5496	308	5605	103	5742	322	5819	341	5917	329
5013	289	5073	70	5133	231	5222	305	5305	332	5361	291	5424	295	5497	308	5606	103	5743	322	5838	341	5918	329
5014	289	5074	70	5134	231	5223	305	5306	332	5362	291	5425	295	5498	308	5607	103	5744	322	5839	341	5919	329
5015	289	5075	70	5150	228	5224	305	5311	296	5363	291	5426	295	5499	308	5608	103	5745	322	5865	324	5920	329
5016	289	5076	71	5151	221	5225	305	5312	296	5364	291	5427	295	5501	99	5609	103	5746	322	5866	324	5921	329
5017	289	5077	71	5152	221	5226	305	5313	296	5365	291	5428	295	5502	99	5610	102	5747	323	5867	324	5922	329
5018	289	5078	71	5153	288	5227	305	5314	296	5366	291	5430	313	5503	99	5611	102	5748	323	5868	324	5923	329
5019	289	5081	69	5154	288	5228	305	5315	297	5367	291	5431	313	5504	99	5614	102	5749	323	5869	324	5924	329
5020	289	5082	69	5155	288	5229	305	5316	297	5368	291	5432	313	5505	99	5615	102	5750	323	5870	324	5925	329
5021	289	5083	69	5156	288	5230	305	5317	298	5369	291	5433	313	5506	99	5617	102	5751	336	5871	324	5926	329
5022	289	5084	69	5157	288	5241	300	5318	298	5378	297	5450	291	5507	99	5618	102	5752	336	5872	324	5927	329
5023	289	5085	69	5158	288	5242	300	5319	298	5379	297	5451	291	5508	99	5626	105	5753	336	5873	324	5928	329
5024	289	5086	69	5159	288	5243	300	5320	298	5380	282	5452	291	5509	99	5627	105	5754	337	5874	324	5929	329
5025	289	5090	421	5160	288	5246	300	5321	287	5381	282	5453	291	5511	101	5629	105	5755	337	5875	324	5930	330
5026	289	5091	421	5162	229	5247	300	5322	287	5382	282	5455	317	5512	101	5630	105	5756	337	5876	324	5931	330
5027	283	5092	421	5165	229	5248	300	5323	287	5383	284	5456	317	5513	101	5701	318	5759	320	5877	324	5932	330
5028	283	5093	421	5166	229	5249	300	5324	287	5384	284	5457	317	5514	101	5702	318	5760	320	5878	324	5933	330
5029	283	5094	421	5170	71	5250	300	5325	287	5385	284	5458	317	5515	101	5703	318	5761	320	5879	324	5934	330
5030	283	5095	421	5171	71	5251	300	5326	287	5386	285	5459	317	5516	101	5704	318	5762	320	5880	325	5935	330
5036	283	5096	421	5172	71	5252	300	5327	287	5387	285	5460	316	5517	101	5705	318	5763	320	5881	325	5936	330
5037	283	5097	71	5175	227	5253	300	5328	287	5388	285	5461	316	5518	101	5706	318	5764	320	5882	325	5937	330
5038	283	5098	71	5180	139	5254	300	5329	287	5389	286	5462	316	5519	101	5707	318	5765	320	5883	325	5938	330
5039	283	5099	71	5181	139	5255	300	5330	287	5390	286	5463	316	5538	99	5708	318	5766	320	5884	325	5939	330
5040	283	5101	228	5182	175	5256	300	5331	287	5391	292	5464	335	5539	99	5709	318	5767	320	5885	325	5940	330





SKU:	Page No.	SKU:	Page No.	SKU:	Page No.	SKU:	Page No.	SKU:	Page No.	SKU:	Page No.
9046	152	9128	347	9304	2408	9406	12	9500	492	5611-m	104
9047	152	9129	347	9305	409	9407	13	9501	492	5612-m	104
9048	152	9135	348	9306	409	9408	14	9502	492	5613-m	104
9049	152	9136	348	9307	409	9410	17	9503	492	5623-m	104
9050	90	9137	349	9308	409	9411	16	9504	494	5624-m	104
9051	90	9138	349	9309	410	9412	18	9506	493	5643-m	104
9052	90	9141	346	9310	410	9413	19	9507	493		
9053	90	9142	346	9311	410	9418	8	9508	492		
9054	90	9143	346	9312	410	9419	8	9509	492		
9055	90	9156	354	9315	411	9420	8	9510	493		
9056	90	9157	354	9316	411	9421	8	9511	493		
9057	90	9158	354	9321	399	9422	8	9512	493		
9058	91	9171	355	9322	399	9423	8	9514	494		
9059	91	9172	355	9323	399	9424	11	9515	494		
9060	91	9173	355	9324	399	9425	11	9516	494		
9061	91	9174	355	9331	404	9426	11	9601	28		
9062	92	9175	357	9332	404	9427	11	9602	28		
9063	92	9176	357	9333	404	9428	8	9603	29		
9064	92	9177	357	9334	405	9429	8	9604	29		
9065	92	9178	357	9335	405	9431	10	9605	29		
9066	92	9179	352	9336	405	9434	13	9606	29		
9067	93	9180	352	9337	406	9435	25	9607	29		
9068	93	9181	356	9338	406	9436	25	9608	29		
9069	93	9182	356	9339	406	9437	24	9609	29		
9070	93	9196	353	9340	407	9438	24	9610	28		
9071	93	9197	353	9341	407	9439	28	9611	29		
9072	88	9198	353	9342	407	9451	12	9612	29		
9073	88	9199	353	9343	393	9452	12	9613	29		
9074	89	9201	351	9344	403	9453	12	9614	29		
9075	89	9202	351	9345	393	9454	12	9615	29		
9076	88	9203	351	9346	403	9455	13	9616	29		
9077	88	9204	351	9347	393	9456	13	9656	20		
9078	89	9205	351	9348	403	9457	12	9658	21		
9079	89	9206	351	9349	400	9458	12	9659	21		
9080	94	9207	351	9350	400	9461	23	66018	438		
9081	94	9208	351	9351	400	9462	23	66019	438		
9082	94	9209	351	9352	401	9463	23	66020	439		
9083	94	9210	351	9353	401	9464	13	66024	445		
9084	95	9211	351	9354	401	9471	22	66025	442		
9085	95	9212	351	9355	398	9472	22	66026	442		
9086	95	9213	351	9356	398	9473	22	66027	442		
9087	95	9214	351	9357	402	9481	26	66028	442		
9092	419	9215	351	9358	402	9482	26	66122	466		
9093	419	9221	350	9359	402	9483	26	66123	466		
9094	419	9222	350	9400	9	9484	26	66124	467		
9095	419	9223	350	9401	9	9485	26	66125	467		
9118	356	9224	350	9402	9	9491	27	66126	466		
9119	356	9301	408	9403	11	9492	27	66127	461		
9126	347	9302	408	9404	10	9493	27	5611-m	104		
9127	347	9303	408	9405	15	9494	27	5612-m	104		

SKU:	Page No.	SKU:	Page No.	SKU:	Page No.	SKU:	Page No.	SKU:	Page No.	SKU:	Page No.
9046	152	9128	347	9304	2408	9406	12	9500	492	5611-m	104
9047	152	9129	347	9305	409	9407	13	9501	492	5612-m	104
9048	152	9135	348	9306	409	9408	14	9502	492	5613-m	104
9049	152	9136	348	9307	409	9410	17	9503	492	5623-m	104
9050	90	9137	349	9308	409	9411	16	9504	494	5624-m	104
9051	90	9138	349	9309	410	9412	18	9506	493	5643-m	104
9052	90	9141	346	9310	410	9413	19	9507	493		
9053	90	9142	346	9311	410	9418	8	9508	492		
9054	90	9143	346	9312	410	9419	8	9509	492		
9055	90	9156	354	9315	411	9420	8	9510	493		
9056	90	9157	354	9316	411	9421	8	9511	493		
9057	90	9158	354	9321	399	9422	8	9512	493		
9058	91	9171	355	9322	399	9423	8	9514	494		
9059	91	9172	355	9323	399	9424	11	9515	494		
9060	91	9173	355	9324	399	9425	11	9516	494		
9061	91	9174	355	9331	404	9426	11	9601	28		
9062	92	9175	357	9332	404	9427	11	9602	28		
9063	92	9176	357	9333	404	9428	8	9603	29		
9064	92	9177	357	9334	405	9429	8	9604	29		
9065	92	9178	357	9335	405	9431	10	9605	29		
9066	92	9179	352	9336	405	9434	13	9606	29		
9067	93	9180	352	9337	406	9435	25	9607	29		
9068	93	9181	356	9338	406	9436	25	9608	29		
9069	93	9182	356	9339	406	9437	24	9609	29		
9070	93	9196	353	9340	407	9438	24	9610	28		
9071	93	9197	353	9341	407	9439	28	9611	29		
9072	88	9198	353	9342	407	9451	12	9612	29		
9073	88	9199	353	9343	393	9452	12	9613	29		
9074	89	9201	351	9344	403	9453	12	9614	29		
9075	89	9202	351	9345	393	9454	12	9615	29		
9076	88	9203	351	9346	403	9455	13	9616	29		
9077	88	9204	351	9347	393	9456	13	9656	20		
9078	89	9205	351	9348	403	9457	12	9658	21		
9079	89	9206	351	9349	400	9458	12	9659	21		
9080	94	9207	351	9350	400	9461	23	66018	438		
9081	94	9208	351	9351	400	9462	23	66019	438		
9082	94	9209	351	9352	401	9463	23	66020	439		
9083	94	9210	351	9353	401	9464	13	66024	445		
9084	95	9211	351	9354	401	9471	22	66025	442		
9085	95	9212	351	9355	398	9472	22	66026	442		
9086	95	9213	351	9356	398	9473	22	66027	442		
9087	95	9214	351	9357	402	9481	26	66028	442		
9092	419	9215	351	9358	402	9482	26	66122	466		
9093	419	9221	350	9359	402	9483	26	66123	466		
9094	419	9222	350	9400	9	9484	26	66124	467		
9095	419	9223	350	9401	9	9485	26	66125	467		
9118	356	9224	350	9402	9	9491	27	66126	466		
9119	356	9301	408	9403	11	9492	27	66127	461		
9126	347	9302	408	9404	10	9493	27	5611-m	104		
9127	347	9303	408	9405	15	9494	27	5612-m	104		

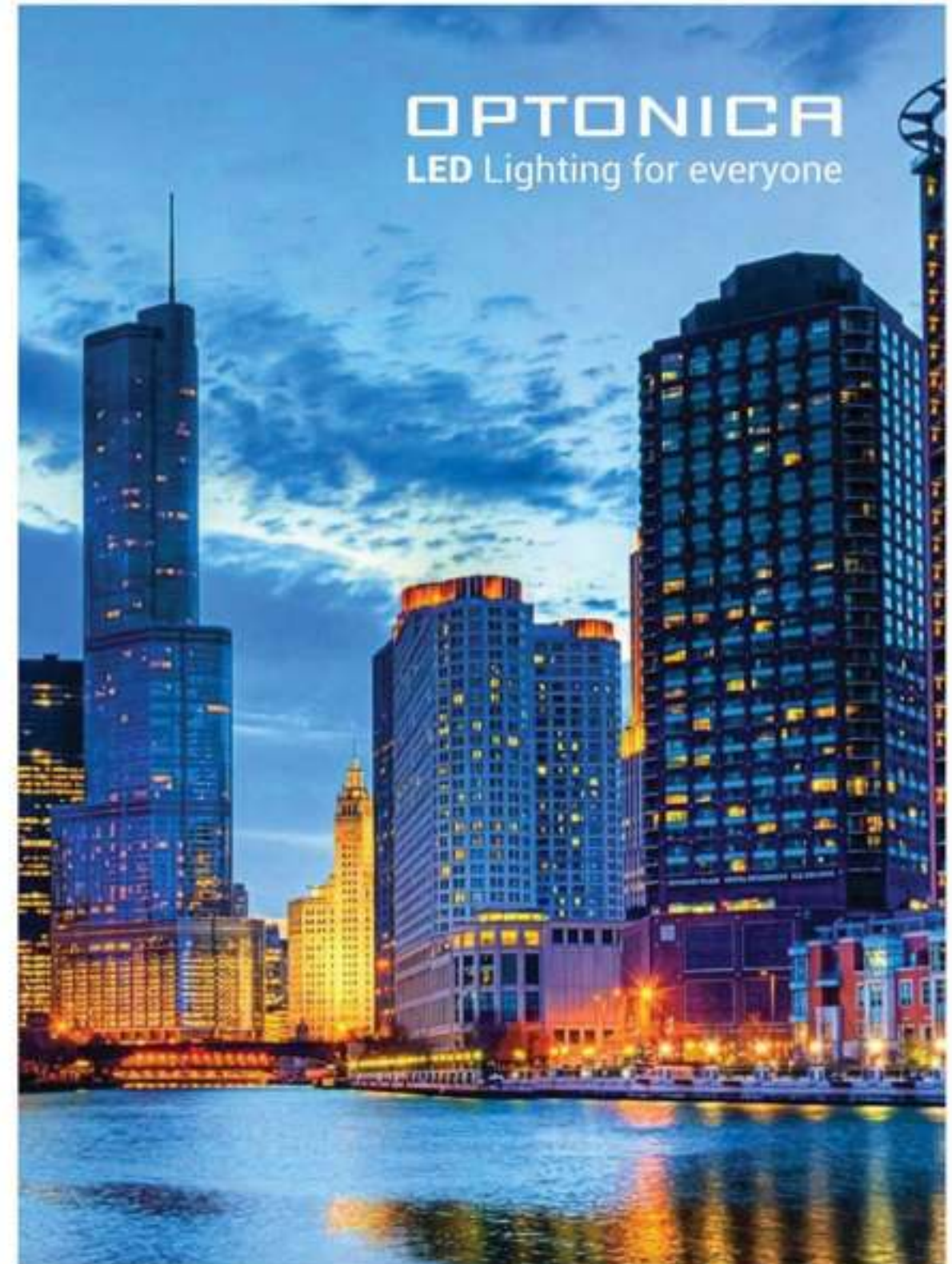





OPTONICA

**LED MALL**  
**Catalogo**  
**2024**



604 23 94 75



[office@ledmall.es](mailto:office@ledmall.es)