

# OMINI

electrical & lighting

20 years of extensive research.  
20 years of remarkable innovation.  
20 years of brilliance.



2019-2020  
PRODUCT CATALOGUE

# PRACTICAL ADVANTAGES

## OF USING OMNI



	
<b>40W Incandescent Bulb</b>	<b>6W Omni LED A50 Bulb</b>
Light Output 470lm	Light Output 500lm
Consumption 40W	Consumption 6W
Life 1,000hrs	Life 20,000hrs

You can save up to **80% off** on your **BILLS** if you switch to OMNI LED Lights.

PARAMETERS	 Incandescent	VS	 CFL	VS	 LED
On and Off Cycling	some		yes		no effect
Shock Resistance	fragile		fragile		durable
Heat Emissions	85 btu/hr		30 btu/hr		3.4 btu/hr
Failure Modes	abrupt		abrupt		dims over time
Color Rendering Index	2700k		2700K to 6500K		2700K to 6500K
Turns on Instantly	yes		no		yes

# TABLE OF CONTENTS

## LED General Lighting Series

LED GU10 / MR16 GLOBE .....	01
LED Dimmable Downlight .....	04
LED Recessed Circular Downlight .....	09
LED Lite GLS Bulb Series .....	11
LED Lite Fancy Round Bulb Series .....	13
LED Lite Sphere Bulb Series .....	15
LED Lite Mini Colored Bulb .....	17
LED R Series Bulb & LED Lite 12V Bulb .....	19
LED Lite Filament Bulb Series .....	21
LED Lite Candle Bulb .....	23
LED Lite Dimmable Bulb .....	25
LED Lite Pin Bulb .....	29
LED Capsule Bulb .....	31
LED G4/ G9 Bulb & LED R7S/R7X .....	33
LED Desk Lamp .....	35
LED T8 Tube .....	37

## LED Outdoor Lighting Series

LED PAR Bulb .....	39
LED Security Sensor Light .....	41
LED Low Profile Lamp .....	43
LED Panel Light .....	45
LED Weatherproof Fixture .....	47
LED Bunker Light .....	49
LED Lite Flood Light .....	51
LED Flood Light .....	53
LED Sky-Pad Highbay Light .....	55
LED High Bay Bulb .....	57
LED Highbay Light .....	59
LED Multi Functional Floodlight .....	61

## Electrical Product Series

LED Dimmable Trailing Edge .....	64
Quick Connect Socket .....	65
Standard socket with mounting plate .....	66
Junction Box .....	67
Enclosed Mounting Box .....	68
Mounting Block .....	69
Cable Gland .....	70
Adaptable Box & Cable Clips .....	71
Cable Connector & Cable Tie .....	72



Do away with high-temperature halogen bulbs and help preserve your possessions with OMNI LED MR16 reflectorized lamp. It offers 90% energy savings and is great for accent or spot lighting.

**LED**  
*Lite*

## LED GU10 / MR16 GLOBE

### FEATURES

- 90% energy savings when compared to halogen bulbs
- Safe to use with GU10 twist to lock base
- UV and IR free
- Mercury free
- SMD LED Technology
- Less heat emission
- SAA / CE and RoHS Compliant
- 20,000 hours of operations



## GU10 Non-Dimmable



### 5W LED GU10 Globe

MODEL	WATT	CCT	LUMENS	CRI
LFGU10-5W-DL	5W	6500K	400lm	>80
LFGU10-5W-WW	5W	3000K	380lm	>80



### LED GU10 / MR16 GLOBE



### 8W LED GU10 Globe

MODEL	WATT	CCT	LUMENS	CRI
LFGU10-8W-DL	8W	5000K	650lm	>80
LFGU10-8W-WW	8W	3000K	600lm	>80



## MR16 Non-Dimmable



### 8W LED MR16 Globe 12V

MODEL	WATT	CCT	LUMENS	CRI
LFMR16-8W-DL	8W	5000K	650lm	>80
LFMR16-8W-WW	8W	3000K	600lm	>80



PACKING:48pcs/ctn

## GU10 Dimmable



**8W LED GU10 Globe**

MODEL	WATT	CCT	LUMENS	CRI
LFGU10D-8W-DL	8W	5000K	650lm	>80
LFGU10D-8W-WW	8W	3000K	600lm	>80



**12W LED GU10 Globe**

MODEL	WATT	CCT	LUMENS	CRI
LFGU10D-12W-DL	12W	5000K	1000lm	>80
LFGU10D-12W-WW	12W	3000K	950lm	>80

## MR16 Dimmable



**8W LED MR16 Globe 12V**

MODEL	WATT	CCT	LUMENS	CRI
LFMR16D-8W-DL	8W	5000K	650lm	>80
LFMR16D-8W-WW	8W	3000K	600lm	>80



**LED Driver**

MODEL	INPUT	OUTPUT	Tc:	Ta:	PACKING
LDD-020	95-240V~50/60Hz	12V=,1A 1-10W	75°C	40°C	40pcs/ctn

**FEATURES:**

- Applicable to low power ≤10W LED lamp product
- Maintains current and voltage at narrow level
- Compact and light weight allows installation in various indoor areas

### LED GU10 / MR16 GLOBE



Halogen 50W 70W VS LED 8W 12W



PACKING: 48pcs/ctn

**LED**  
*Victor Series*



page 64-Omni Dimmer



**Features and Advantages**

- Pure aluminum housing, better heat-sink.
- Powder coated and plated finish, white and silver gray casing are optional.
- Outstanding dimming compatibility, matching the popular dimmers with leading edge, trailing edge and universal edge in Australia market.
- Dimming range 2-100%.
- Taiwan LEXTAR LED chips, stable and better performance.
- Special private tooling and patent.
- PC diffuser with soft-lighting, eyes-protection.
- Up to 40,000 hrs life span.
- SAA/IC-F certificate passed.
- With 1.2m cable and plug.

 10/12W	 240V	 100°	 40,000Hours	 IP Rating IP20
 Dimmable	 Flex & Plug	 Ø 70/90mm	<b>IC Rating</b> IC-F	



**10/12W VICTOR Series ( White / Silver Housing )**

MODEL	WATT	HOUSING	CCT	LUMEN	CRI	PACKING
LVDD-10W-DL/WH	10W	White	5000K	800lm	>80	24pcs/ctn
LVDD-10W-WW/WH	10W	White	3000K	720lm	>80	24pcs/ctn
LVDD-10W-CW/WH	10W	White	4000K	750lm	>80	24pcs/ctn
LVDD-10W-DL/SW	10W	Silver	5000K	800lm	>80	24pcs/ctn
LVDD-10W-WW/SW	10W	Silver	3000K	720lm	>80	24pcs/ctn
LVDD-10W-CW/SW	10W	Silver	4000K	750lm	>80	24pcs/ctn
LVDD-12W-DL/WH	12W	White	5000K	1000lm	>80	24pcs/ctn
LVDD-12W-WW/WH	12W	White	3000K	900lm	>80	24pcs/ctn
LVDD-12W-CW/WH	12W	White	4000K	950lm	>80	24pcs/ctn
LVDD-12W-DL/SW	12W	Silver	5000K	1000lm	>80	24pcs/ctn
LVDD-12W-WW/SW	12W	Silver	3000K	900lm	>80	24pcs/ctn
LVDD-12W-CW/SW	12W	Silver	4000K	950lm	>80	24pcs/ctn

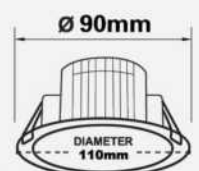

# LED Prestige Series



page 64-Omni Dimmer



12W	240V	60°	40,000Hours	IP Rating IP20
Dimmable	Flex & Plug	Ø 90mm	IC Rating IC-F	

## Features and Advantages

- Pure aluminum housing
- Improved anti-dust performance
- Triac dimming 2-100%
- CCT dimming
- Anti-glare, eye-protection.
- Outstanding dimmer compatibility
- Luminus and SHARP COB leds, 40000hrs
- <0.5% defective rate
- Ø 90mm, 12W
- SAA/IC-F
- With 1.2m cable and plug



## 12W VICTOR Prestige Series ( White Housing )

MODEL	WATT	HOUSING	CCT	LUMEN	CRI	PACKING
LVPU-12W-DL/WH	12W	White	5000K	1000lm	>80	24pcs/ctn
LVPU-12W-WW/WH	12W	White	3000K	900lm	>80	24pcs/ctn
LVPU-12W-CW/WH	12W	White	4000K	950lm	>80	24pcs/ctn
LVPN-12W-DL/WH	12W	White	5000K	1000lm	>80	24pcs/ctn
LVPN-12W-WW/WH	12W	White	3000K	900lm	>80	24pcs/ctn
LVPN-12W-CW/WH	12W	White	4000K	950lm	>80	24pcs/ctn
LVPS-12W-DL/WH	12W	White	5000K	1000lm	>80	24pcs/ctn
LVPS-12W-WW/WH	12W	White	3000K	900lm	>80	24pcs/ctn
LVPS-12W-CW/WH	12W	White	4000K	950lm	>80	24pcs/ctn
LVPC-12W-WW/WH	12W	White	2000-3000K	800lm	>80	24pcs/ctn

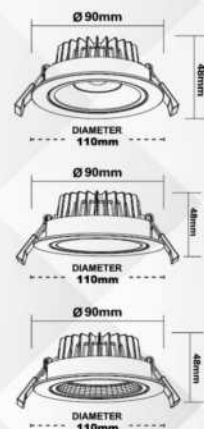



**LED**  
*Star Series*



page 64-Omni Dimmer



### Features and Advantages

- Poly Carbonate housing with aluminum heat-sink inside.
- Integrated design with dimmable driver inside, easy installation.
- Built-in dimmable driver with outstanding dimmable compatibility, matching the popular dimmers in Australia market.
- High-efficiency EVERLIGHT LED chips.
- Special private tooling and patent.
- PC diffuser with soft-lighting, eyes-protection.
- Up to 20,000 hrs life span.
- SAA/IC-4 certificate passed.
- With 1.2m cable and plug.
- White trim included.
- Interchangeable white and silver or black trim only available for 10W.

 8/10W	 240V	 120°	 20,000Hours	 IP Rating IP40
 Dimmable	 Flex & Plug	 ø70/90mm	 IC Rating IC-4	



### 8/10W STAR Series ( White Housing )

MODEL	WATT	HOUSING	CCT	LUMEN	CRI	PACKING
LSDD-8W-DL/WH	8W	White	5000K	750lm	>80	24pcs/ctn
LSDD-8W-WW/WH	8W	White	3000K	700lm	>80	24pcs/ctn
LSDD-8W-CW/WH	8W	White	4000K	720lm	>80	24pcs/ctn
LSDD-10W-DL/WH	10W	White	5000K	950lm	>80	24pcs/ctn
LSDD-10W-WW/WH	10W	White	3000K	900lm	>80	24pcs/ctn
LSDD-10W-CW/WH	10W	White	4000K	920lm	>80	24pcs/ctn



# LED Star Series



page 64-Omni Dimmer



## Features and Advantages

- Integrated driver
- Triac dimmable technology
- 3-in-1, 3000K / 4000K / 5000K
- Interchangeable white and silver or black trim
- White trim included
- Silver and Black trim available at additional cost
- With 1.2m cable and plug

10W	240V	120°	20,000Hours	IP Rating IP40
Dimmable	Flex & Plug	Ø 90mm	IC Rating IC-4	



### 10W LED Star Series ( White )

MODEL	WATT	HOUSING	CCT	LUMEN	CRI	PACKING
LSDT-10W-CCT/WH	10W	White	3000/4000/5000K	900lm	>80	24pcs/ctn

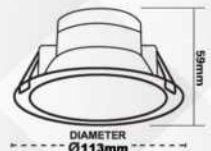

### LED Downlight Star Trim

MODEL	CUTOUT	COLOUR	PACKING
LSDR-P90-SG	Ø90mm	Silver Gray	240pcs/carton 24pcs/inner box
LSDR-P90-BK	Ø90mm	Black	240pcs/carton 24pcs/inner box

**LED**  
*La Ville*



### Features and Advantages

- Patent design with 360° adjustable direction without gap for dust proof.
- High efficient COB LEDs with adjustable CCT 3000/4000/5000K.
- Aluminium housing and external driver are good for heat-sink.
- Integrated multi-switch for easy-adjustable CCT 3-in-1, saving stock.
- External driver with improved block is easy for connection in series.
- Triac dimmable tech. make it easier match with popular dimmer.
- Remix housing and adjustable module in white and black color are available.
- With 1.2m cable and plug.
- SAA / IC-4 certificate approved.

 8W	 240V	 60°	 40,000Hours	 IP Rating IP44
 Dimmable	 Flex & Plug	 ø 90mm	 <b>IC</b> Rating IC-4	



**8W | LED LaVille (White Housing)**

Model NO.	Watt	Housing	CCT	Lumen	CRI	Packing
LLDT-8W-CCT/WH	8W	White	3000/4000/5000K	650lm	>80	48pcs/ctn





Wider beam angle, brighter illumination, and softer light output.  
Switch to OMNI LED Recessed Circular Downlight for your general lighting needs.



## RECESSED CIRCULAR DOWNLIGHT

### FEATURES

- Maintenance free fixture. Lamp and driver in one assembly
- Easy to install
- Round molded plastic casing
- 120° light angle
- Matte white finish that is readily adaptable to any ceiling design
- Soft light output appearance because of opaque diffuser
- Mercury free
- SMD LED Technology
- Less heat emission
- SAA / CE and RoHS Compliant
- 20,000 hours of operations





**15W** LED Recessed Circular Downlight

MODEL	WATT	CCT	LUMENS	CRI
LLRC-15WDL	15W	5000K	1100lm	>80
LLRC-15WW	15W	3000K	1000lm	>80

Cutout Size  
  
 ∅120mm

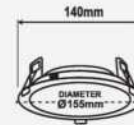

LED Recessed Circular Downlight



**20W** LED Recessed Circular Downlight

MODEL	WATT	CCT	LUMENS	CRI
LLRC-20WDL	20W	5000K	1500lm	>80
LLRC-20WW	20W	3000K	1400lm	>80

Cutout Size  
  
 ∅165mm

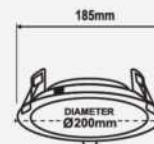

**25W** LED Recessed Circular Downlight

MODEL	WATT	CCT	LUMENS	CRI
LLRC-25WDL	25W	5000K	1700lm	>80
LLRC-25WW	25W	3000K	1600lm	>80

Cutout Size  
  
 ∅200mm

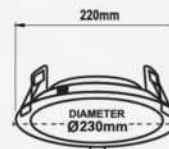

PACKING:10pcs/ctn



General lighting made brighter.

Available in four different wattages, OMNI LED A-Bulb Series promises high-quality but eco-friendly and low-cost energy lighting solution for your general lighting needs.



## GLS Bulb Series

### FEATURES

- Up to 85% Energy Savings
- 300° Beam Angle
- Concealed aluminum heat sink enveloped in heat absorbing compound
- Enclosed in polycarbonate plastic that is impact and heat resistant
- Lights up instantly compared to CFL
- Not affected by frequency of ON and OFF
- High colour rendering index
- Mercury Free
- SMD LED Technology
- Less heat emission
- SAA / CE and RoHS Compliant
- 20,000 Hours of operations





6W		LED A50 Bulb			
MODEL	WATT	CCT	LUMENS	CRI	
LLA50E27-6W-DL	6W	5000K	500lm	>80	
LLA50E27-6W-WW	6W	3000K	450lm	>80	
LLA50B22-6W-DL	6W	5000K	500lm	>80	
LLA50B22-6W-WW	6W	3000K	450lm	>80	



7W		LED A55 Bulb			
MODEL	WATT	CCT	LUMENS	CRI	
LLA55E27-7W-DL	7W	5000K	600lm	>80	
LLA55E27-7W-WW	7W	3000K	580lm	>80	
LLA55B22-7W-DL	7W	5000K	600lm	>80	
LLA55B22-7W-WW	7W	3000K	580lm	>80	



9W		LED A60 Bulb			
MODEL	WATT	CCT	LUMENS	CRI	
LLA60E27-9W-DL	9W	5000K	800lm	>80	
LLA60E27-9W-WW	9W	3000K	750lm	>80	
LLA60B22-9W-DL	9W	5000K	800lm	>80	
LLA60B22-9W-WW	9W	3000K	750lm	>80	



12W		LED A65 Bulb			
MODEL	WATT	CCT	LUMENS	CRI	
LLA65E27-12W-DL	12W	5000K	1100lm	>80	
LLA65E27-12W-WW	12W	3000K	1000lm	>80	
LLA65B22-12W-DL	12W	5000K	1100lm	>80	
LLA65B22-12W-WW	12W	3000K	1000lm	>80	



15W		LED A72 Bulb			
MODEL	WATT	CCT	LUMENS	CRI	
LLA72E27-15W-DL	15W	5000K	1300lm	>80	
LLA72E27-15W-WW	15W	3000K	1250lm	>80	
LLA72B22-15W-DL	15W	5000K	1300lm	>80	
LLA72B22-15W-WW	15W	3000K	1250lm	>80	

LED GLS BULB SERIES



Incandescent	LED
40W	6W
60W	7W
75W	9W
80W	12W
100W	15W

-  6/7/9/12/15W
-  240V
-  20,000 Hours
-  Non-Dimmable
-  E27/E22
-  300°
-  RoHS Compliance
-  CE
-  FC
-  SAFE EASY TO USE
-  NO UV/IR
-  UP TO 85% ENERGY SAVINGS
- 

PACKING: 48pcs/ctn



Energy-saving and eco-friendly, without compromising quality.

Make the switch to OMNI LED Lite – the most affordable quality LED bulb for your general lighting requirements.



## Fancy Round Bulb Series

### FEATURES

- Up to 85% Energy Savings
- 220°/300° Beam Angle
- Concealed aluminum heat sink enveloped in heat absorbing compound
- Enclosed in polycarbonate plastic that is impact and heat resistant
- Lights up instantly compared to CFL
- Not affected by frequency of ON and OFF
- High colour rendering index
- Mercury Free
- SMD LED Technology
- Less heat emission
- SAA / CE and RoHS Compliant
- 20,000 Hours of operations







**4W LED G45 Bulb**

MODEL	WATT	CCT	LUMENS	CRI
LLG45E14-4W-DL	4W	5000K	340lm	>80
LLG45E14-4W-WW	4W	3000K	325lm	>80
LLG45E27-4W-DL	4W	5000K	340lm	>80
LLG45E27-4W-WW	4W	3000K	325lm	>80
LLG45B15-4W-DL	4W	5000K	340lm	>80
LLG45B15-4W-WW	4W	3000K	325lm	>80
LLG45B22-4W-DL	4W	5000K	340lm	>80
LLG45B22-4W-WW	4W	3000K	325lm	>80

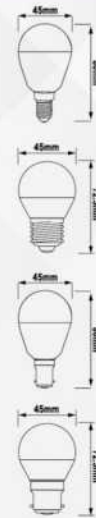

LED Fancy Round Bulb Series



PACKING: 48pcs/ctn



**4W LED G45 Prestige Bulb**

MODEL	WATT	CCT	LUMENS	CRI
LCG45E14-4W-DL	4W	5000K	350lm	>80
LCG45E14-4W-WW	4W	3000K	325lm	>80
LCG45E27-4W-DL	4W	5000K	350lm	>80
LCG45E27-4W-WW	4W	3000K	325lm	>80
LCG45B15-4W-DL	4W	5000K	350lm	>80
LCG45B15-4W-WW	4W	3000K	325lm	>80
LCG45B22-4W-DL	4W	5000K	350lm	>80
LCG45B22-4W-WW	4W	3000K	325lm	>80

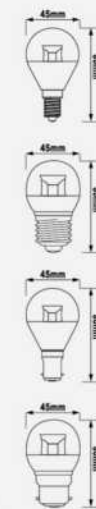



Enhance and illuminate any corner of your home with OMNI LED Globe Lamp.  
It has high colour rendering index and is available in three wattages.

# LED *Lite*

## Sphere Bulb Series

### FEATURES

- Up to 85% Energy Savings
- Concealed aluminum heat sink enveloped in heat absorbing compound
- Enclosed in polycarbonate plastic that is impact and heat resistant
- Lights up instantly compared to CFL
- Not affected by frequency of ON and OFF
- High colour rendering index
- Mercury Free
- SMD LED Technology
- Less heat emission
- SAA / CE and RoHS Compliant
- 20,000 Hours of operations





**8W LED G70 Sphere Bulb**

MODEL	WATT	CCT	LUMENS	CRI
LLG70E27-8W-DL	8W	5000K	650lm	>80
LLG70E27-8W-WW	8W	3000K	600lm	>80
LLG70B22-8W-DL	8W	5000K	650lm	>80
LLG70B22-8W-WW	8W	3000K	600lm	>80

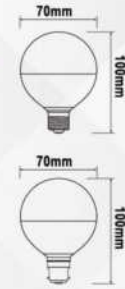

LED Sphere Bulb Series

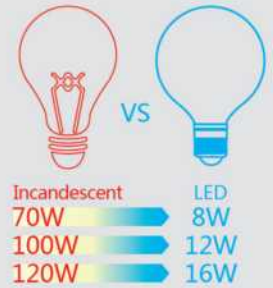

**12W LED G95 Sphere Bulb**

MODEL	WATT	CCT	LUMENS	CRI
LLG95E27-12W-DL	12W	5000K	1050lm	>80
LLG95E27-12W-WW	12W	3000K	1000lm	>80
LLG95B22-12W-DL	12W	5000K	1050lm	>80
LLG95B22-12W-WW	12W	3000K	1000lm	>80

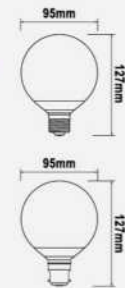

**16W LED G120 Sphere Bulb**

MODEL	WATT	CCT	LUMENS	CRI
LLG120E27-16W-DL	16W	5000K	1200lm	>80
LLG120E27-16W-WW	16W	3000K	1150lm	>80
LLG120B22-16W-DL	16W	5000K	1200lm	>80
LLG120B22-16W-WW	16W	3000K	1150lm	>80

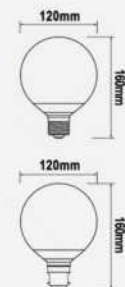

PACKING  
G70 30pcs/ctn  
G95 24pcs/ctn  
G120 12pcs/ctn



Add more colors to your exterior or interior illumination while saving on energy consumption.



## Mini Colored Bulb

### FEATURES

- Up to 85% Energy Savings
- Concealed aluminum heat sink enveloped in heat absorbing compound
- Enclosed in polycarbonate plastic that is impact and heat resistant
- Lights up instantly compared to CFL
- Not affected by frequency of ON and OFF
- High colour rendering index
- Mercury Free
- SMD LED Technology
- Less heat emission
- SAA / CE and RoHS Compliant
- 20,000 Hours of operations





LED Life Mini Colored

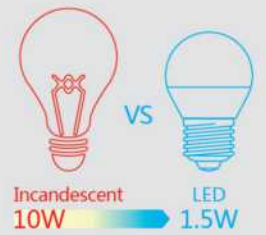

 1.5W	 240V	 20,000 Hours
 Non-Dimmable	 E27	 UP TO 85% ENERGY SAVINGS
 RoHS Compliant	 CE	 RoHS Compliant
 FC	 SAFE EASY TO USE	 NO UV/IR
		

1.5W LED Colored Round Bulb

MODEL	BASE	WATT	COLOR
LRB-1.5W	E27	1.5W	Blue
LRG-1.5W	E27	1.5W	Green
LRR-1.5W	E27	1.5W	Red
LRY-1.5W	E27	1.5W	Yellow

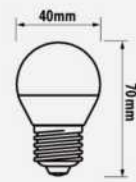

PACKING: 60pcs/ctn



4W		LED G45 Blub 12V			
MODEL	WATT	CCT	LUMENS	CRI	
LCG45E27-4W-12V-DL	4W	5000K	340lm	>80	
LCG45E27-4W-12V-WW	4W	3000K	320lm	>80	
LCG45B22-4W-12V-DL	4W	5000K	340lm	>80	
LCG45B22-4W-12V-WW	4W	3000K	320lm	>80	



8W		LED A60 Blub 12V			
MODEL	WATT	CCT	LUMENS	CRI	
LLA60E27-8W-12V-DL	8W	5000K	700lm	>80	
LLA60E27-8W-12V-WW	8W	3000K	600lm	>80	
LLA60B22-8W-12V-DL	8W	5000K	700lm	>80	
LLA60B22-8W-12V-WW	8W	3000K	600lm	>80	

LED Lite 12V Bulb

Incandescent  
30W  
60W

VS

LED 12V  
4W  
8W

PACKING:48pcs/ctn

**LED**  
*Lite*



**5W LED R50 Blub**

MODEL	WATT	CCT	LUMENS	CRI
LPR50E14-5W-DL	5W	5000K	370lm	>80
LPR50E14-5W-WW	5W	3000K	350lm	>80



**8W LED R63 Blub**

MODEL	WATT	CCT	LUMENS	CRI
LPR63E27-8W-DL	8W	5000K	700lm	>80
LPR63E27-8W-WW	8W	3000K	600lm	>80
LPR63B22-8W-DL	8W	5000K	700lm	>80
LPR63B22-8W-WW	8W	3000K	600lm	>80





**10W LED R80 Blub**

MODEL	WATT	CCT	LUMENS	CRI
LPR80E27-10W-DL	10W	5000K	900lm	>80
LPR80E27-10W-WW	10W	3000K	800lm	>80
LPR80B22-10W-DL	10W	5000K	900lm	>80
LPR80B22-10W-WW	10W	3000K	800lm	>80



**LED R Series Bulb**



Incandescent vs LED

35W	5W
60W	8W
80W	10W



PACKING: 48pcs/ctn



General lighting made brighter.

Available in four different wattages, OMNI LED A-Bulb Series promises high-quality but eco-friendly and low-cost energy lighting solution for your general lighting needs.

## LED *Lite* Filament Bulb

### FEATURES

- Retro-style LED bulb, classical model.
- Long life span, low heat, not hot when touch.
- Traditional filament design, use 3D light emitting filament, wide beam angle, high efficacy.
- Adopt special light transmission glass cover, high transmittance rate, no shadow and dark space.







**4W LED Candle**

MODEL	WATT	CCT	LUMENS	CRI
LFCC35E14D-4W-WW	4W	2700K	450lm	>80
LFCC35E14D-4W-CW	4W	4000K	500lm	>80



**4W LED G45 Bulb**

MODEL	WATT	CCT	LUMENS	CRI
LFCG45E14D-4W-WW	4W	2700K	450lm	>80
LFCG45E27D-4W-WW	4W	2700K	450lm	>80
LFCG45B15D-4W-WW	4W	2700K	450lm	>80

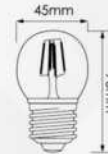

**6W LED GLS A60**

MODEL	WATT	CCT	LUMENS	CRI
LFCA60E27D-6W-WW	6W	2700K	580lm	>80
LFCA60B22D-6W-WW	6W	2700K	580lm	>80



**6W LED Sphere G95**

MODEL	WATT	CCT	LUMENS	CRI
LFCG95E27D-6W-WW	6W	2700K	580lm	>80
LFCG95B22D-6W-WW	6W	2700K	580lm	>80



**6W LED Sphere G125**

MODEL	WATT	CCT	LUMENS	CRI
LFCG125E27D-6W-WW	6W	2700K	580lm	>80
LFCG125B22D-6W-WW	6W	2700K	580lm	>80



**6W LED Pear P64**

MODEL	WATT	CCT	LUMENS	CRI
LFCP64E27D-6W-WW	6W	2700K	580lm	>80
LFCP64B22D-6W-WW	6W	2700K	580lm	>80

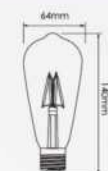

LED Lite Filament Bulb Series

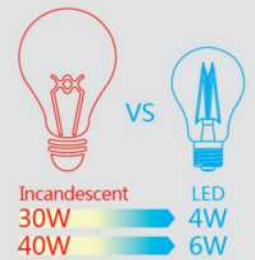

- 4/6W
- 240V
- 20,000 Hours
- Dimmable
- E27/E26 E14/B15
- 320°
- RoHS Compliant
- FC
- SAFE EASY TO USE
- NO UV/IR
- UP TO 85% ENERGY SAVINGS
- 

PACKING

Candle/G45/A60: 48pcs/ctn  
G95 / P64: 24pcs/ctn  
G125: 12pcs/ctn



Make the switch to DC-operated OMNI LED Candle Bulbs to elegantly illuminate your lamps, chandeliers and other lighting fixtures without the high energy consumption of incandescent bulbs.

## LED *Lite* CANDLE BULBS

### FEATURES

- Up to 90% Energy Savings
- 220° Beam Angle on Frosted and 220° Beam Angle on Clear cover.
- Concealed aluminum heat sink enveloped in heat absorbing compound
- Enclosed in polycarbonate plastic that is impact and heat resistant
- Lights up instantly compared to CFLs
- Not affected by frequency of ON and OFF
- High colour rendering index
- Mercury Free
- SMD LED Technology
- Less heat emission
- SAA / CE and RoHS Compliant
- 20,000 Hours of operations





**4W LED Candle Bulb**

MODEL	WATT	CCT	LUMENS	CRI
LCC35E14-4W-DL	4W	5000K	300lm	>80
LCC35E14-4W-WW	4W	3000K	270lm	>80
LCC35E27-4W-DL	4W	5000K	300lm	>80
LCC35E27-4W-WW	4W	3000K	270lm	>80
LCC35B15-4W-DL	4W	5000K	300lm	>80
LCC35B15-4W-WW	4W	3000K	270lm	>80
LCC35B22-4W-DL	4W	5000K	300lm	>80
LCC35B22-4W-WW	4W	3000K	270lm	>80



LED Candle Bulb



- 4W
- 240V
- 20,000 Hours
- Non-Dimmable
- E14/B15 E27/R22
- 220°
- CE
- RoHS Compliant
- FC
- SAFE EASY TO USE
- NO UV/IR
- UP TO 85% ENERGY SAVINGS
- 

PACKING: 48pcs/ctn



**4W LED Candle Bulb**

MODEL	WATT	CCT	LUMENS	CRI
LCF35E14-4W-DL	4W	5000K	300lm	>80
LCF35E14-4W-WW	4W	3000K	270lm	>80
LCF35E27-4W-DL	4W	5000K	300lm	>80
LCF35E27-4W-WW	4W	3000K	270lm	>80
LCF35B15-4W-DL	4W	5000K	300lm	>80
LCF35B15-4W-WW	4W	3000K	270lm	>80
LCF35B22-4W-DL	4W	5000K	300lm	>80
LCF35B22-4W-WW	4W	3000K	270lm	>80





LED  
*Lite*

Dimmable Bulb





**7W LED A55 Bulb Dimmable**

MODEL	WATT	CCT	LUMENS	CRI
LLA55E27D-7W-DL	7W	5000K	600lm	>80
LLA55E27D-7W-WW	7W	3000K	580lm	>80
LLA55B22D-7W-DL	7W	5000K	600lm	>80
LLA55B22D-7W-WW	7W	3000K	580lm	>80

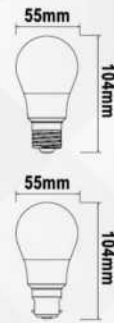

LED Life Dimmable Bulb



- 7/9/12W
- 240V
- 20,000 Hours
- Dimmable
- E27/B22
- 300°
- CE
- RoHS Compliant
- FC
- SAFE EASY TO USE
- NO UV/IR
- UP TO 85% ENERGY SAVINGS
- X



**9W LED A60 Bulb Dimmable**

MODEL	WATT	CCT	LUMENS	CRI
LLA60E27D-9W-DL	9W	5000K	800lm	>80
LLA60E27D-9W-WW	9W	3000K	750lm	>80
LLA60B22D-9W-DL	9W	5000K	800lm	>80
LLA60B22D-9W-WW	9W	3000K	750lm	>80

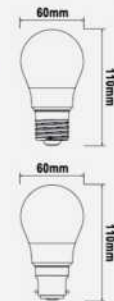

**12W LED A65 Bulb Dimmable**

MODEL	WATT	CCT	LUMENS	CRI
LLA65E27D-12W-DL	12W	5000K	1100lm	>80
LLA65E27D-12W-WW	12W	3000K	1000lm	>80
LLA65B22D-12W-DL	12W	5000K	1100lm	>80
LLA65B22D-12W-WW	12W	3000K	1000lm	>80

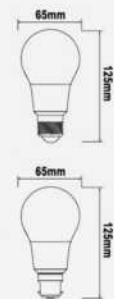

PACKING:48pcs/ctn



### 6W LED G45 Bulb Dimmable

MODEL	WATT	CCT	LUMENS	CRI
LLG45E14D-6W-DL	6W	5000K	420lm	>80
LLG45E14D-6W-WW	6W	3000K	400lm	>80
LLG45E27D-6W-DL	6W	5000K	420lm	>80
LLG45E27D-6W-WW	6W	3000K	400lm	>80
LLG45B15D-6W-DL	6W	5000K	420lm	>80
LLG45B15D-6W-WW	6W	3000K	400lm	>80
LLG45B22D-6W-DL	6W	5000K	420lm	>80
LLG45B22D-6W-WW	6W	3000K	400lm	>80

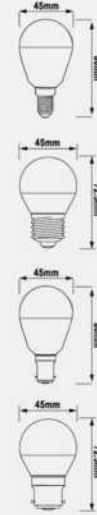

### LED Lite Dimmable Bulb

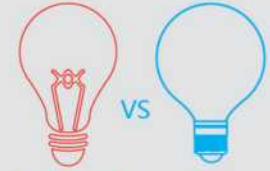

Incandescent  
40W  
100W  
120W

LED  
6W  
12W  
16W



PACKING  
G45 48pcs/ctn  
G95 24pcs/ctn  
G120 12pcs/ctn



### 12W LED G95 Bulb Dimmable

MODEL	WATT	CCT	LUMENS	CRI
LLG95E27D-12W-DL	12W	5000K	1050lm	>80
LLG95E27D-12W-WW	12W	3000K	1000lm	>80
LLG95B22D-12W-DL	12W	5000K	1050lm	>80
LLG95B22D-12W-WW	12W	3000K	1000lm	>80

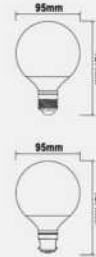

### 16W LED G120 Bulb Dimmable

MODEL	WATT	CCT	LUMENS	CRI
LLG120E27D-16W-DL	16W	5000K	1200lm	>80
LLG120E27D-16W-WW	16W	3000K	1150lm	>80
LLG120B22D-16W-DL	16W	5000K	1200lm	>80
LLG120B22D-16W-WW	16W	3000K	1150lm	>80

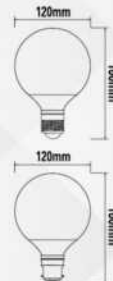



**6W LED Candle Bulb Dimmable**

MODEL	WATT	CCT	LUMENS	CRI
LCC35E14D-6W-DL LCC35E14D-6W-WW	6W	5000K 3000K	410lm 390lm	>80 >80
LCC35E27D-6W-DL LCC35E27D-6W-WW	6W	5000K 3000K	410lm 390lm	>80 >80
LCC35B15D-6W-DL LCC35B15D-6W-WW	6W	5000K 3000K	410lm 390lm	>80 >80
LCC35B22D-6W-DL LCC35B22D-6W-WW	6W	5000K 3000K	410lm 390lm	>80 >80



**LED Lite Dimmable Bulb**



 6W	 240V	 20,000 Hours
 Dimmable	 E27/E22/E14/B15	 220°
 RoHS Compliant	 CE	 SAFE EASY TO USE
 FC	 NO UV/IR	 UP TO 85% ENERGY SAVINGS
		

PACKING: 48pcs/ctn



**6W LED Candle Bulb Dimmable**

MODEL	WATT	CCT	LUMENS	CRI
LCF35E14D-6W-DL LCF35E14D-6W-WW	6W	5000K 3000K	410lm 390lm	>80 >80
LCF35B15D-6W-DL LCF35B15D-6W-WW	6W	5000K 3000K	410lm 390lm	>80 >80
LCF35B22D-6W-DL LCF35B22D-6W-WW	6W	5000K 3000K	410lm 390lm	>80 >80





The effective, all-around illumination for your work spaces.

Make the switch to OMNI LED Pinlight, the energy-saving alternative to fluorescent pinlights.

**LED**  
*Lite*

## PIN Bulb

### FEATURES

- 50% energy savings when compared to cfl pinlights
- 360° beam angle
- Mercury free
- SMD LED Technology
- Less heat emission
- SAA / CE and RoHS Compliant
- 20,000 hours of operations







**7W LED PIN Bulb**

MODEL	WATT	CCT	LUMENS	CRI
LPLG24D-7W-DL	7W	5000K	600lm	>80
LPLG24D-7W-WW	7W	3000K	550lm	>80
LPLE27-7W-DL	7W	5000K	600lm	>80
LPLE27-7W-WW	7W	3000K	550lm	>80
LPLE14-7W-DL	7W	5000K	600lm	>80
LPLE14-7W-WW	7W	3000K	550lm	>80
LPLB22-7W-DL	7W	5000K	600lm	>80
LPLB22-7W-WW	7W	3000K	550lm	>80
LPLB15-7W-DL	7W	5000K	600lm	>80
LPLB15-7W-WW	7W	3000K	550lm	>80



**LED Lite Pin Bulb**

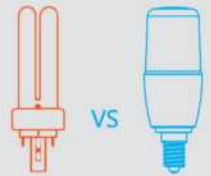

Compact Fluorescent Lamp vs LED  
 11W vs 7W  
 14W vs 9W  
 18W vs 12W

- 7/9/12W
- 240V
- 20,000 Hours
- Non-Dimmable
- E27/B22/E14/B15/G24D
- 360°
- CE
- RoHS Compliant
- FC
- SAFE EASY TO USE
- NO UV/IR
- UP TO 85% ENERGY SAVINGS
- Energy Star



**9W LED PIN Bulb**

MODEL	WATT	CCT	LUMENS	CRI
LPLG24D-9W-DL	9W	5000K	840lm	>80
LPLG24D-9W-WW	9W	3000K	810lm	>80
LPLE27-9W-DL	9W	5000K	840lm	>80
LPLE27-9W-WW	9W	3000K	810lm	>80
LPLB22-9W-DL	9W	5000K	840lm	>80
LPLB22-9W-WW	9W	3000K	810lm	>80

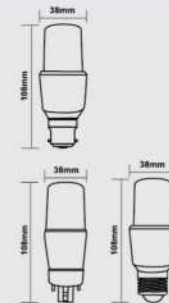

PACKING:48pcs/ctn



**12W LED PIN Bulb**

MODEL	WATT	CCT	LUMENS	CRI
LPLG24D-12W-DL	12W	5000K	1100lm	>80
LPLG24D-12W-WW	12W	3000K	1000lm	>80
LPLE27-12W-DL	12W	5000K	1100lm	>80
LPLE27-12W-WW	12W	3000K	1000lm	>80
LPLB22-12W-DL	12W	5000K	1100lm	>80
LPLB22-12W-WW	12W	3000K	1000lm	>80

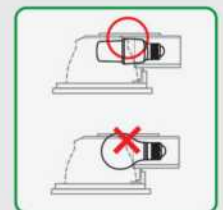
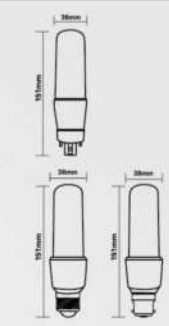



*Make the switch to Omni LED Capsule lamps, in replacement for mercury lamps. Effective illumination at lower energy cost.*

## LED *Lite* Capsule Bulb

### FEATURES

- 360° light angle
- Higher light output at 100 lumen per watt
- 20,000hrs of operation
- Mercury free
- SMD LED Technology
- Less heat emission
- SAA/CE/RoHS passed





**20W LED Capsule Bulb**

MODEL	WATT	CCT	LUMENS	CRI
LM65E27-20W-DL	20W	5000K	2100lm	>80
LM65E27-20W-WW	20W	3000K	2000lm	>80



LED Capsule Bulb

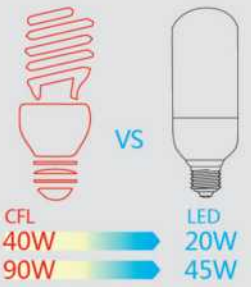

20/45W	240V	20,000 Hours
Non-Dimmable	E27/E40	360°
RoHS Compliant	CE	FC
SAFE EASY TO USE	NO UV/IR	85% ENERGY SAVINGS

PACKING:24pcs/ctn



**45W LED Capsule Bulb**

MODEL	WATT	CCT	LUMENS	CRI
LM95E40-45W-DL	45W	5000K	3800lm	>80





### 1.5W LED G4 Bulb

MODEL	WATT	CCT	LUMENS	CRI
LCG4-1.5W-DL	1.5W	5000K	110lm	>80
LCG4-1.5W-WW	1.5W	3000K	100lm	>80



### LED G4 / G9 Bulb



PACKING:144pcs/ctn



### 2.5W LED G9 Bulb

MODEL	WATT	CCT	LUMENS	CRI
LCG9-2.5W-DL	2.5W	5000K	250lm	>80
LCG9-2.5W-WW	2.5W	3000K	220lm	>80

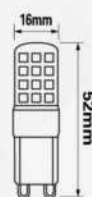



**22W LED R7S**

MODEL	WATT	CCT	LUMENS	CRI
OM-R7S-22W-DL	22W	5000K	2000lm	>80
OM-R7S-22W-CW	22W	4000K	1900lm	>80

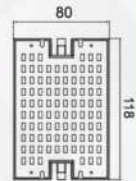

**Transfer From :**

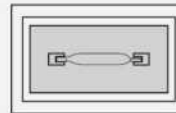

**To:**

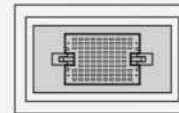

**LED R7S / R7X**

-  22W
-  240V
-  40,000 Hours
-  Non-Dimmable
-  85% ENERGY SAVINGS
-  RoHS Compliant
-  CE
-  FC
-  SAFE EASY TO USE
-  NO UV/IR
- 

PACKING:30pcs/ctn



**22W LED R7X**

MODEL	WATT	CCT	LUMENS	CRI
OM-R7X-22W-DL	22W	5000K	2000lm	>80
OM-R7X-22W-CW	22W	4000K	1900lm	>80

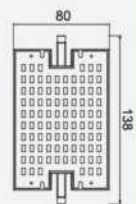

**Transfer From :**

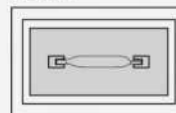

**To:**

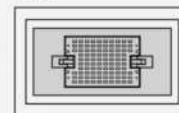



Combining functionality, elegance and ease of use.

OMNI LED Touch Lamps are adjustable with three levels of brightness to match your daily activities.

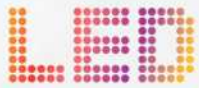

## Desk Lamp

### FEATURES

- Modern stylish design
- Touch sensitive, 3-level brightness (dimmable)
- Adjustable and foldable lamp holder
- Built-in LED
- Last up to 20,000 hours
- Indoor use only
- Environment-friendly
- Mercury free
- SAA/CE and RoHS Compliant





**4W LED Desk Lamp**

MODEL	WATT	CCT	LUMENS	COLOUR	CRI
DEL-1302/S-CW	4W	4000K	300lm	SILVER	>80



**2.5W LED Desk Lamp**

MODEL	WATT	CCT	LUMENS	COLOUR	CRI
DEL-1306/B-CW	2.5W	4000K	540lm	BLACK	>80
DEL-1306/W-CW	2.5W	4000K	540lm	WHITE	>80



**4.5W LED Desk Lamp**

MODEL	WATT	CCT	LUMENS	COLOUR	CRI
DEL-1212/W-CW	4.5W	4000K	400lm	WHITE	>80

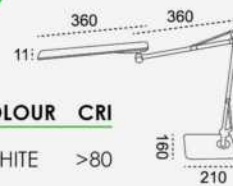

**4.5W LED Desk Lamp**

MODEL	WATT	CCT	LUMENS	COLOUR	CRI
DEL-1211/B-CW	4.5W	4000K	540lm	BLACK	>80

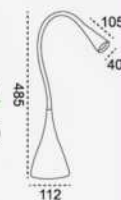

LED Desk Lamp



PACKING

1302	12pcs/ctn
1306	20pcs/ctn
1212	8pcs/ctn
1211	8pcs/ctn



Make the switch to Modern day Omni LED linear lamps. It helps you save up to 60% on your electricity by retrofitting conventional fluorescent tubes to led tubes, get your investment back in less than 3 months, need not to buy a separate fixture.

# LED T8 TUBE SUPERLUX

SINGLE ENDED INPUT

## FEATURES

- 60% energy savings
- High lumen output 100lm/w
- 330° beam angle
- Comes with free mounting clips and accessories for retrofitting and independent installation
- Mercury free
- SMD LED Technology
- Less heat emission
- SAA / CE and RoHS Compliant
- 20,000 hours of operations



Alfa Mart

IEC60598 IEC61347 IEC62471 IEC62612 IEC62717 IEC62031 IEC62560







**10W LED T8 Tube**

MODEL	WATT	CCT	LUMENS	CRI
LT8S-10W-DL	10W	6500K	1200lm	>80
LT8S-10W-CW	10W	4000K	1100lm	>80



\* **FREE** Fuse and Accessories for direct installation

**20W LED T8 Tube**

MODEL	WATT	CCT	LUMENS	CRI
LT8S-20W-DL	20W	6500K	2200lm	>80
LT8S-20W-CW	20W	4000K	2100lm	>80
LT8S-20W-WW	20W	3000K	2000lm	>80



\* **FREE** Fuse and Accessories for direct installation

LED T8 Tube

Fluorescent Tube VS LED

18W 36W vs 10W 20W

- 10/20W
- 240V
- 20,000 Hours
- Non-Dimmable
- G13
- 330°
- CE
- RoHS Compliant
- FC
- SAFE EASY TO USE
- NO UV/IR
- UP TO 85% ENERGY SAVINGS
- Recycling symbol

PACKING: 20pcs/ctn



FUSE for Retrofitting





Add life to your outdoor lighting while saving substantially on your electric bills with OMNI LED Par Lamps. You can also use them along with our uniquely-designed holders for better functionality.

## LED *Lite* PAR Bulb

### FEATURES

- 85% energy savings
- weatherproof IP65 rating
- Lightweight
- Stays cool even after long period of use
- Higher light intensity of up to 15 meters
- Polycarbonate enclosure
- Mercury free
- SMD LED Technology
- Less heat emission
- SAA / CE and RoHS Compliant
- 40,000 hours of operations





LED PAR Bulb



PACKING  
10W 24pcs/ctn  
15W 12pcs/ctn

**10W** LED Par 30 Lamps

MODEL	WATT	COLOR	LUMENS	CRI
LPR30E27-10W/B	10W	BLUE	-	>80
LPR30E27-10W/Y	10W	YELLOW	-	>80
LPR30E27-10W/G	10W	GREEN	-	>80
LPR30E27-10W/R	10W	RED	-	>80
LPR30E27-10W/D	10W	6500K	750lm	>80
LPR30E27-10W/W	10W	3000K	700lm	>80



**15W** LED Par 38 Lamps

MODEL	WATT	COLOR	LUMENS	CRI
LPR38E27-15W/B	15W	BLUE	-	>80
LPR38E27-15W/Y	15W	YELLOW	-	>80
LPR38E27-15W/G	15W	GREEN	-	>80
LPR38E27-15W/R	15W	RED	-	>80
LPR38E27-15W/D	15W	6500K	1100lm	>80
LPR38E27-15W/W	15W	3000K	1000lm	>80

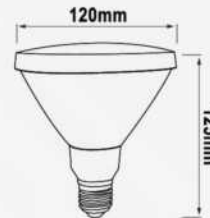



# Security Sensor Light

Aluminium Body

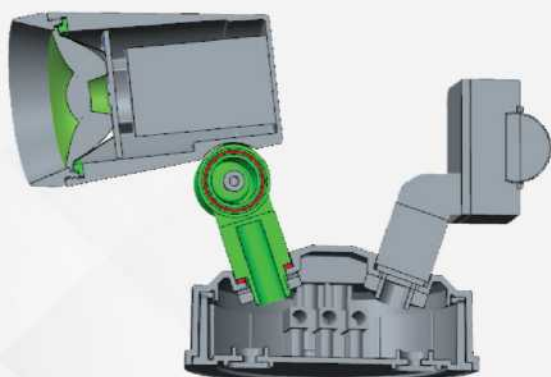

## Features and Advantages

- Improved design with smaller base, easier for installation.
- Built-in isolated driver.
- ADC12 Die-casting aluminium housing, good heat-sink.
- Base with materials PC UL94-V0 and with color RAL9005.
- LEDs SMD2835 with lens makes higher efficiency.
- Infrared sensor.
- Beam angle 60°.
- Rated IP65 and IK08.
- Up to 50,000 hrs @25°C by L70B50.
- Working temp. -20°C~+40°C.
- Cable range 0.75~2.5mm<sup>2</sup>



16W

LED Security Sensor Light

MODEL	CCT	WATT	VOLTAGE	LUMENS	PF	CRI	BEAM ANGLE	IP RATING	PACKING
LSLS-16W-DL/BK	5000K	16W	240V	1600lm	0.9	80	60°	IP65	24pcs/ctn
LSLS-16W-WW/BK	3000K	16W	240V	1280lm	0.9	80	60°	IP65	24pcs/ctn

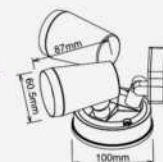



*Make the switch to Omni LED Low profile Lamps as replacement to traditional louvers. A modern and stylish touch for our homes and office spaces.*



## LED LOW PROFILE LAMP

### FEATURES

- Neat design and smooth finish
- Soft acrylic type diffuser
- High lumen output
- Non-breakable
- Slim and lightweight to only 75mm width and 24mm thick
- cool operation, Mercury free
- SMD LED Technology
- Less heat emission
- SAA / CE and RoHS Compliant
- 40,000 hours of operations



**18W** LED Low profile Lamp

MODEL	WATT	CCT	LUMENS	CRI
OM-LSP-18W-DL	18W	5000K	1630lm	>80
OM-LSP-18W-WW	18W	3000K	1570lm	>80

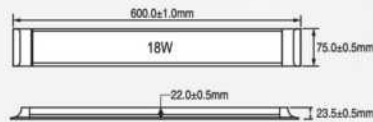

LED Low profile Lamp



Installation accessories

PACKING: 10pcs/ctn

**36W** LED Low profile Lamp

MODEL	WATT	CCT	LUMENS	CRI
OM-LSP-36W-DL	36W	5000K	3280lm	>80





For a safer and more uniform lighting.

Suitable for indoor applications such as in hospitals and food factories, OMNI LED Panel Lights offer great light distribution and reduce the risk of broken glass falling on work areas.

## LED Panel Light

### FEATURES

- Slim fit design
- LED driver included plus installation accessories ( wall-mounted, ceiling-mounted or suspended )
- Wide Beam Angle
- Lasts up to 25,000hrs
- Indoor use only
- Environment-friendly
- Mercury free
- SAA/CE/RoHS passed





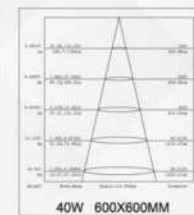
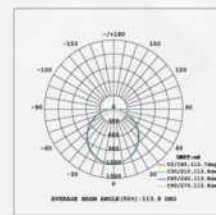
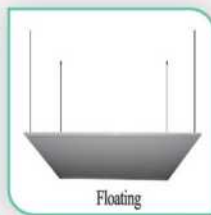

**Application**

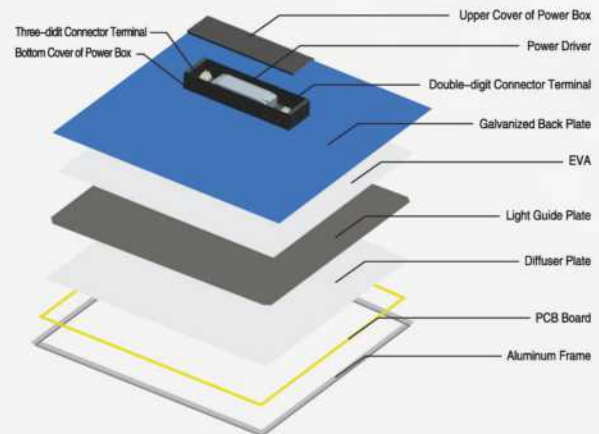

**40W LED Panel Light**

MODEL	SIZE	WATT	VOLTAGE	LUMENS	CCT	PF	CRI	AVE.LIFE
LP660-40W-DL/WH	595*595*9	40W	AC180-277V	3600lm	6500K	>0.9	>80	25000
LP312-40W-DL/WH	295*1195*9	40W	AC180-277V	3600lm	6500K	>0.9	>80	25000
LP312-40W-CW/WH	295*1195*9	40W	AC180-277V	3400lm	4000K	>0.9	>80	25000
LP312-40W-CCT/WH	295*1195*9	40W	AC180-277V	3000-3400lm	2800-6500K	>0.9	>80	25000
LP660-FRSM	600*600							
LP312-FRSM	300*1200							
LPA660								

Frame for surface mounting installation LP660-40W-DL/CW  
 Frame for surface mounting installation LP312-40W-DL/CW  
 Suspended mounting kit for LP660 , LP312



INSTALLATION ACCESSORIES INCLUDED



(suspended mounting kit)

LPA660

*Lighter  
Thinner  
Brighter*

## WEATHERPROOF FIXTURE

Replace your traditional louvers with LED Weatherproof Fixture for uniform light output and better coverage.

### **FEATURE and ADVANTAGE**

- Integrated slim design
- Uniform light output for better area coverage
- Built-in high efficient SMD LED chips
- Built-in aluminium heat-sink
- Indoor and outdoor applications
- Surface mount or suspended application
- Easy plug and play installation
- Up to 30,000hrs
- SAA/CE/RoHS/EMC approved

**18W** LED Weatherproof Fixture

MODEL	WATT	CCT	LUMENS	PF	CRI
LLW-18W-DL	18W	5000K	1600lm	>0.9	>80
LLW-18W-CW	18W	4000K	1500lm	>0.9	>80

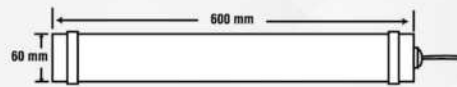

\* Installation accessories included.

**36W** LED Weatherproof Fixture

MODEL	WATT	CCT	LUMENS	PF	CRI
LLW-36W-DL	36W	5000K	3200lm	>0.9	>80
LLW-36W-CW	36W	4000K	3100lm	>0.9	>80

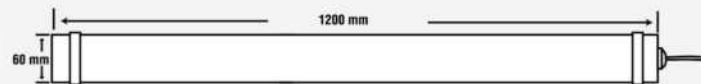

\* Installation accessories included.

**45W** LED Weatherproof Fixture

MODEL	WATT	CCT	LUMENS	PF	CRI
LLW-45W-DL	45W	5000K	4000lm	>0.9	>80
LLW-45W-CW	45W	4000K	3900lm	>0.9	>80

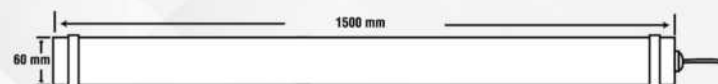

\* Installation accessories included.

LED Weatherproof Fixture

-  18/36/45W
-  240V
-  30,000 Hours
-  Non-Dimmable
-  IP Rating IP65
-  120°
-  CE
-  RoHS Compliant
-  FC
-  SAFE EASY TO USE
-  NO UV/IR
-  UP TO 85% ENERGY SAVINGS
- 



Installation accessories

PACKING: 20pcs/ctn



*Make the switch to Omni LED bunker light for outdoor illumination.*

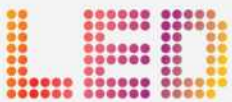

## Bunker Light

### FEATURES

- Non corrosive plastic casing & polycarbonate design
- Impact resistant IP65
- Can be ceiling or wall mounted
- Opaque diffuser for soft light effect without glare
- Mercury free
- SMD LED Technology
- Less heat emission
- SAA / CE and RoHS Compliant
- 20,000 hours of operations



**10W** LED Bunker Light Plastic Casing

MODEL	WATT	CCT	LUMENS	CRI
LWOL-10WDL	10W	5000K	850lm	>80
LWOL-10WW	10W	3000K	800lm	>80

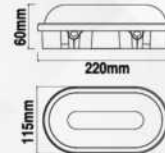

**20W** LED Bunker Light Plastic Casing

MODEL	WATT	CCT	LUMENS	CRI
LWOL-20WDL	20W	5000K	1700lm	>80
LWOL-20WW	20W	3000K	1600lm	>80

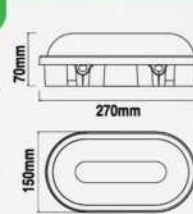

**10W** LED Bunker Light Plastic Casing

MODEL	WATT	CCT	LUMENS	CRI
LWCL-10WDL	10W	5000K	850lm	>80
LWCL-10WW	10W	3000K	800lm	>80



**20W** LED Bunker Light Plastic Casing

MODEL	WATT	CCT	LUMENS	CRI
LWCL-20WDL	20W	5000K	1700lm	>80
LWCL-20WW	20W	3000K	1600lm	>80



LED Bunker Light



PACKING: 10pcs/ctn



# LED *Lite* Flood Light

## FEATURES

- SMD LED technology,  $\geq 90$  lumens/watt.
- Efficient and robust LED driver technology
- Heavy duty aluminum casing
- Weatherproof IP65 rating and With surge protection
- Heavy duty steel yoke with stainless steel screws, for post top, surface or wall mounting options
- Impact resistant, tempered glass cover
- Cool operation, noiseless and maintenance less
- Environment friendly, no IR & UV, non hazardous, CE & RoHS compliant, performance & safety operation conforms to international standards.

Prices are subject to change without prior notice

**10W LED Lite Flood Light**

MODEL	WATT	CCT	LUMENS	CRI
LLFL-10WDL	10W	5000K	900lm	>70

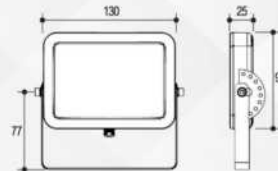

**20W LED Lite Flood Light**

MODEL	WATT	CCT	LUMENS	CRI
LLFL-20WDL	20W	5000K	1800lm	>70

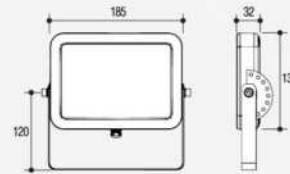

**30W LED Lite Flood Light**

MODEL	WATT	CCT	LUMENS	CRI
LLFL-30WDL	30W	5000K	2700lm	>70

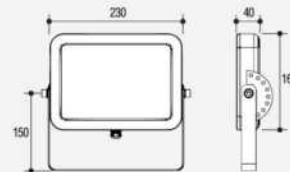

**40W LED Lite Flood Light**

MODEL	WATT	CCT	LUMENS	CRI
LLFL-40WDL	40W	5000K	3600lm	>70

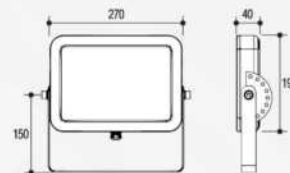

**LED Lite Flood Light**



**PACKING**  
 10W 20pcs/ctn  
 20W 10pcs/ctn  
 30W 10pcs/ctn  
 40W 10pcs/ctn

Make the switch to Omni LED Weatherproof square floodlights for effective outdoor illumination



Flood Light



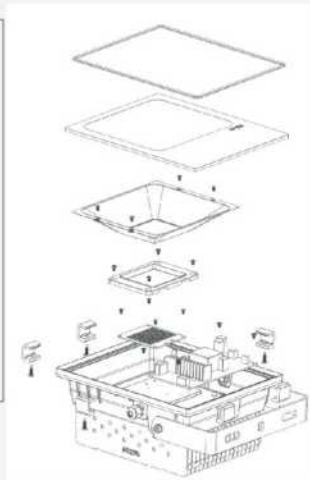
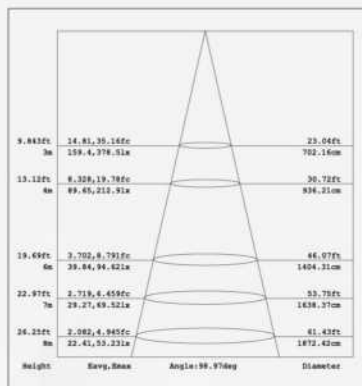
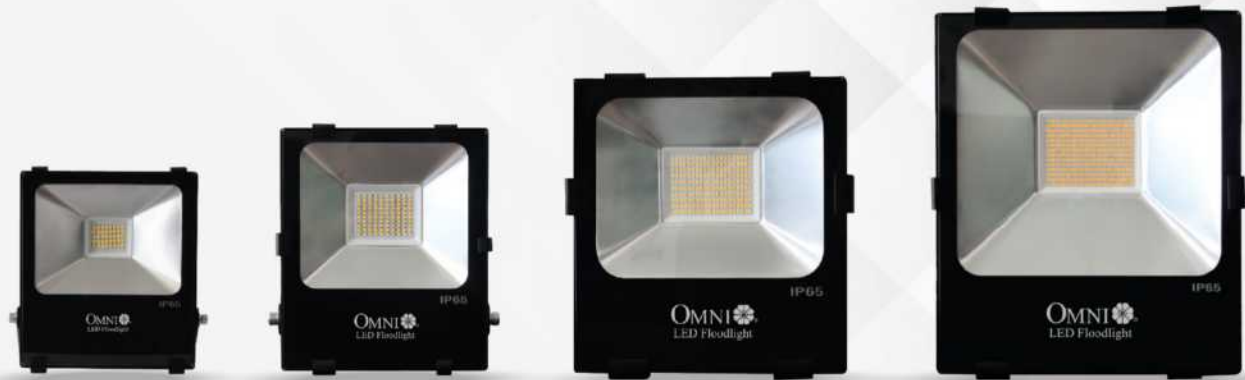

## Features and Advantages

- LED retrofit for traditional metal halide light, more energy-saving solution.
- High-pure aluminum in IP65, good for heat-sink.
- High luminous efficiency, up to 100lm/W.
- NO UV/IR, eco-friendly.
- Long life span, up to 40,000hrs.
- SAA/CE /RoHS passed.
- Suitable for station, stadium, shopping mall, housing and shop deco., parking lot, etc.

### ▲ 100W

### Application



## 20/50/100/200W LED Flood Light

MODEL	CCT	WATT	VOLTAGE	LUMENS	PF	CRI	ANGLE	AVE.LIFE	PACKING
LFLD-20WDL	6500K	20W	240V	2000lm	>0.9	>80	100°	40,000 hrs.	10pcs/ctn
LFLD-50WDL	6500K	50W	240V	5000lm	>0.9	>80	100°	40,000 hrs.	4pcs/ctn
LFLD-100WDL	6500K	100W	240V	10000lm	>0.9	>80	100°	40,000 hrs.	1pcs/ctn
LFLD-200WDL	6500K	200W	240V	20000lm	>0.9	>80	100°	40,000 hrs.	1pcs/ctn

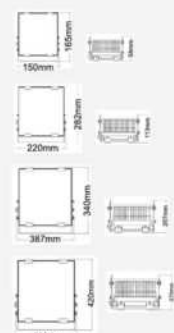



## Sky-Pad Highbay Light



## Features and Advantages

- Patent housing design with cold forging tech, better heat-sink.
- Philips SMD LEDs with stable performance.
- 120 or 60 degree beam angle
- Meanwell driver.
- High efficiency up to 130lm/W.
- Multi-installation, hanging, ceiling fixing, adjustable.
- Wave sensor and light sensor are available.
- AL/PC reflector are available.
- IES report is available.
- SAA/CE/RoHS.
- IP65 rating
- IPART Approved ([www.ess.nsw.gov.au](http://www.ess.nsw.gov.au)) (Brand-OMNI)  
150watt (13542S16-EJJGGCDI)  
200watt (13542S16-LPJBEDQ)



### 100/150/200W LED Sky-Pad Highbay Light

MODEL	CCT	WATT	VOLTAGE	LUMENS	PF	CRI	DIM	AVE.LIFE	PACKING
LSHE-100W-DL	5000K	100W	240V	13000lm	>0.9	>80	NO	40000hrs	1pc/ctn
LSHN-150W-DL	5000K	150W	240V	19500lm	>0.9	>80	NO	40000hrs	1pc/ctn
LSHN-200W-DL	5000K	200W	240V	26000lm	>0.9	>80	NO	40000hrs	1pc/ctn

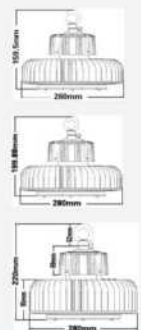

DOMA-16/60 Aluminium dome, 60 degree beam angle, 16 inches



## High Bay Bulb

*Make the switch to Omni LED High bay lamps for illuminating your workplaces and shopping areas, effective illumination at lower energy cost.*

### FEATURES

- 85% energy savings when compared with halogen or mercury lamps
- Suitable for High Bay Lighting
- Durable enclosure made of aluminum and polycarbonate plastic
- No need for acrylic dome
- Mercury free
- SMD LED Technology
- Less heat emission
- SAA / CE and RoHS Compliant
- 40,000 hours of operations



IES LM-79-08

**50W LED High Bay Bulb**

MODEL	WATT	CCT	LUMENS	CRI
LHP170E40-50WDL	50W	5000K	5000lm	>80
LHP170E40-50WCW	50W	4000K	4800lm	>80



**50W LED High Bay Bulb**

MODEL	WATT	CCT	LUMENS	CRI
LHP170E40-70WDL	70W	5000K	6500lm	>80
LHP170E40-70WCW	70W	4000K	6400lm	>80



**LED High Bay Bulb**



MERCURY LAMP 150W VS LED 50W/70W

- 50/70W
- 240V
- 40,000 Hours
- Non-Dimmable
- E40
- 120°
- CE
- RoHS Compliant
- FC
- SAFE EASY TO USE
- NO UV/IR
- UP TO 85% ENERGY SAVINGS

PACKING: 6pcs/ctn

**Acrylic High Bay Luminaire with Aluminum Lampholder E40**

Bulb: LHP170E40-50WDL/CW, LHP170E40-70WDL/CW





## Highbay Light

### FEATURES

- LED retrofit for traditional HID/HPS, energy-saving solution.
- Aluminum housing with FIN design in IP65, good for heat-sink.
- High luminous efficiency, up to 100lm/W.
- NO UV/IR, eco-friendly.
- Long life span, up to 40000hrs.
- SAA/CE/RoHS passed.
- Suitable for use in warehousing, manufacturing, conference centers, industrial lighting, canopies, etc.

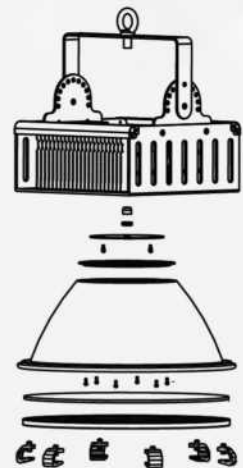

### 150/200W LED Highbay Light

MODEL	CCT	WATT	VOLTAGE	LUMENS	PF	CRI	ANGLE	AVE.LIFE	PACKING
LHB-150WDL	5000K	150W	240V	13500lm	>0.9	>85	45°	40,000 hrs	1pcs/ctn
LHB-200WDL	5000K	200W	240V	17000lm	>0.9	>85	45°	40,000 hrs	1pcs/ctn

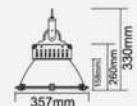
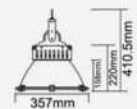

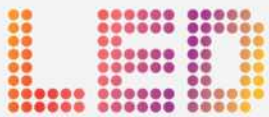

# Multi Functional Floodlight

▲ 150W





◀ LTL-150W



◀ LMFL-300W

## Features and Advantages

- LED retrofit for traditional HID/HPS, more energy-saving solution.
- High-pure aluminum housing with FIN design in IP65, good for heat-sink.
- High luminous efficiency, up to 100lm/W.
- NO UV/IR, eco-friendly.
- Long life span, up to 40,000hrs.
- SAA/CE /RoHS passed.
- Suitable for using in petrol station, tunnel etc.

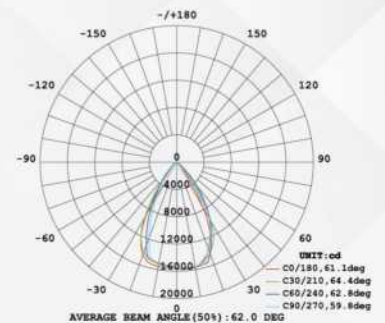

## Installation

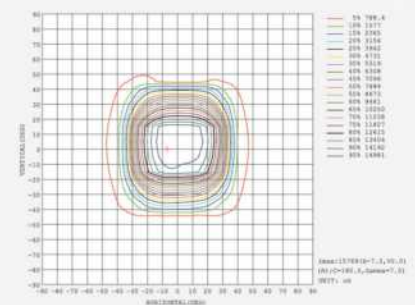

60\*60°

### 150W/300W LED Multi Functional Floodlight

MODEL	WATT	CCT	CCT	LUMENS	PF	CRI	ANGLE	PACKING
LTL-150W-DL	150W	6500K	240V	13500lm	>0.9	>80	60*60°	1pcs/ctn
LMFL-300W-DL	300W	6500K	240V	39000lm	>0.9	>80	80*150°	1pcs/ctn

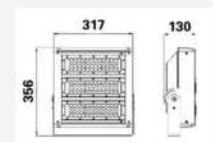

# OMNI ®



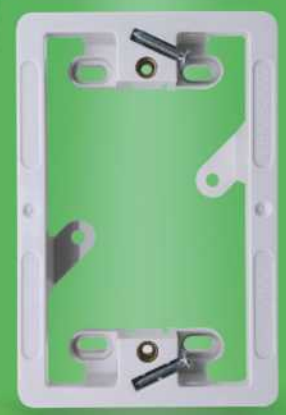
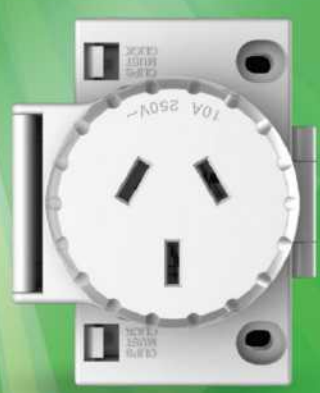

Power for life.



# LED Dimmer Trailing Edge LDT-400A



## LOAD COMPATIBILITY

	LED
	Incandescent 240Vac Halogen Lamps
	12V Electronic Trans
	Iron Core Trans

## FEATURES

- Optimised for dimming LED loads.
- Suitable for LED, incandescent, 240V halogen, 12V electronic transformer, etc.
- Minimum load rating 5W.
- Minimum dimming level typically almost 0%.
- 2-wire design, no neutral wire required.
- Thermal wind-back for overload, over-temperature protection.
- Built-in devices for Over-current and short circuit protection.
- Fits for Australian 84mm wall plate.
- Fits for Australian safety and EMC standards.



## LED Dimmer Trailing Edge

Model	Watt	Voltage	Description	Packing
LDT-400A	400W MAX 5W MIN~	AC220~240V~50Hz	Rotary Controlled LED Dimmer,400VA	48pcs/carton 24pcs/inner box

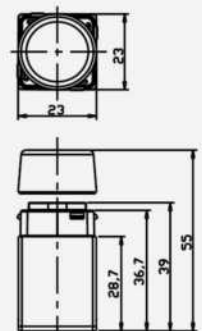

# Quick Connect Socket

## QCS-A01

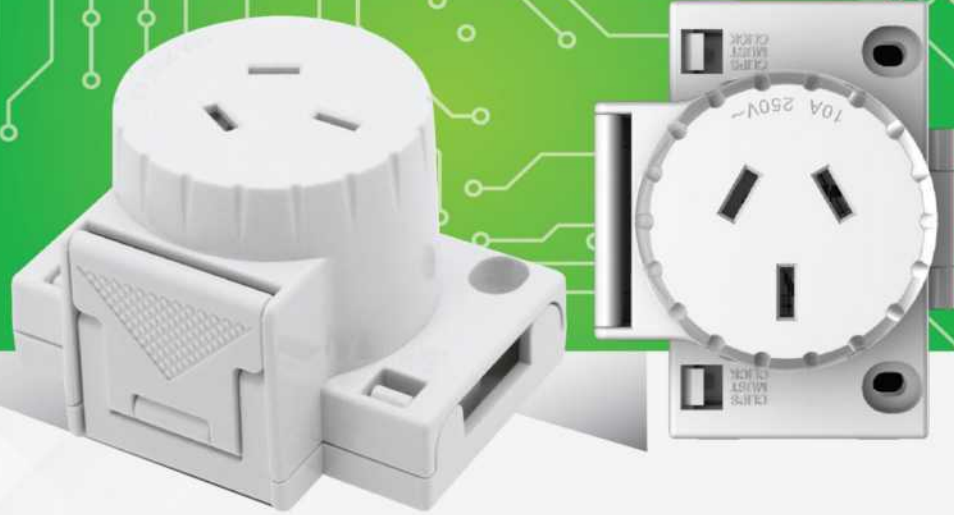

	 10A	 AC250 a.c
--	--	--

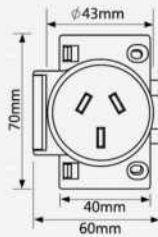

### FEATURES

- Rating 10A 250V a.c.
- 1.0~2.5mm<sup>2</sup> cable.
- Improved out-look and installation operations, more convenient.
- Selected materials make it more stronger and flexible.
- Fit for related AS/NZS standards.

### ⚠ WARNING

This QCS product should be installed by the qualified electrician.



### Quick Connect Socket

Model	Output	Voltage	Packing
QCS-A01	10A	AC250 a.c	100pcs/carton 10pcs/inner box

# Standard surface Socket with mounting Plate SSP-A01



## Standard surface Socket with mounting Plate

Model	Output	Voltage	Packing
SSP-A01	10A	250V a.c	100pcs/carton 10pcs/inner box

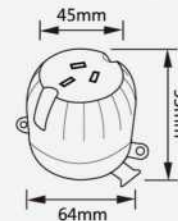

## FEATURES

- Rating 10A 250V a.c.
- Improved out-look and installation operations, more convenient.
- Selected materials make it more stronger and flexible.
- Fit for related AS/NZS standards.

## WARNING

This product should be installed by the qualified electrician.



# Junction Box

## JB007-A01 / JB107-A01



### Junction Box

Model	Output	Voltage	Size	Packing
JB007-A01	40A	500V a.c	70x70mm	100pcs/ctn
JB107-A01	40A	500V a.c	100x70mm	100pcs/ctn

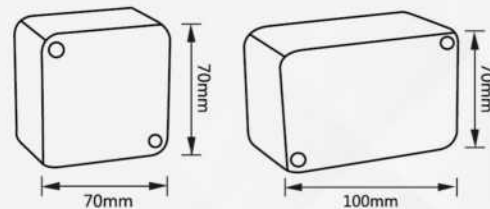

### FEATURES

- Rating 40A 500V a.c.
- Improved out-look and installation operations, more convenient.
- Selected materials make it more stronger and flexible.
- Fit for related AS/NZS standards.

### WARNING

This product should be installed by the qualified electrician.



# Enclosed Mouting Box MBX173-006

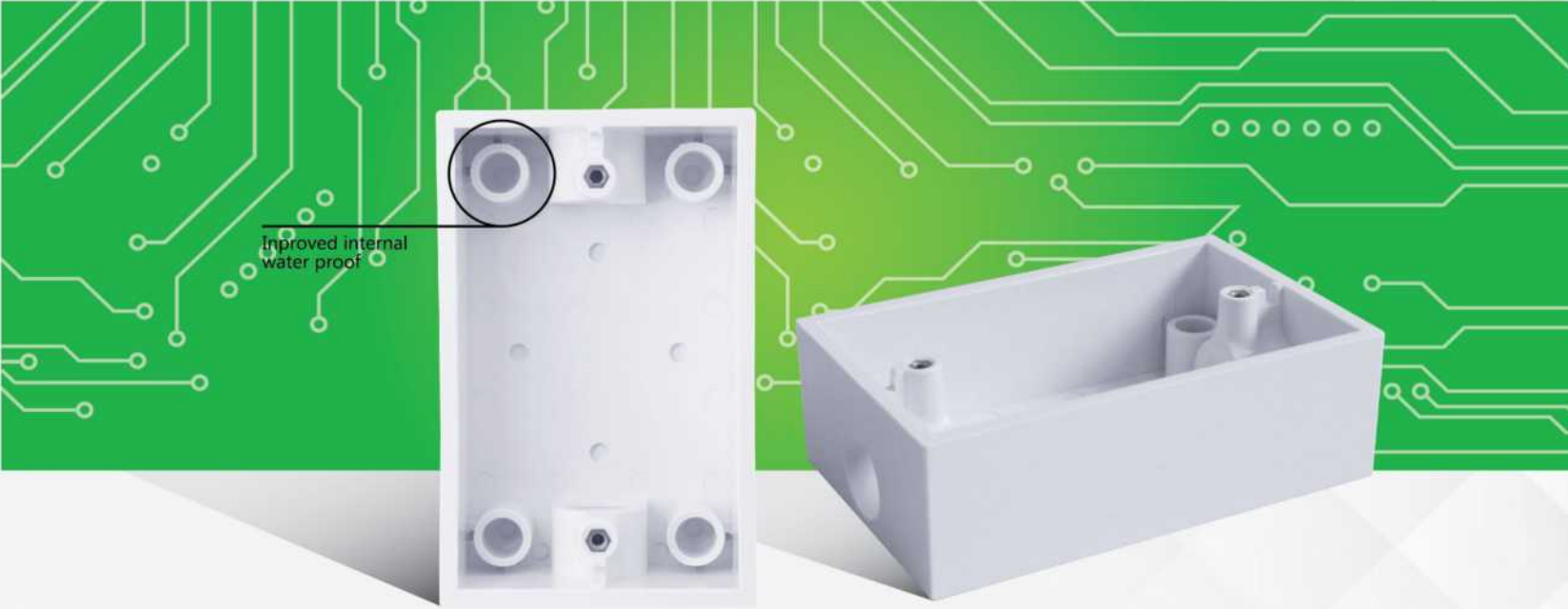

Improved internal  
water proof

## Enclosed Mouting Box

Model	Current	Voltage	Packing
MBX173-006	40A	AC500 a.c	100pcs/ctn

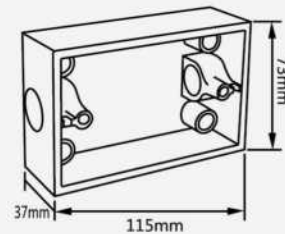

## FEATURES

- Improved internal water proof.
- Rating 40A 500V a.c.
- Improved out-look and installation operations, more convenient.
- Selected materials make it more stronger and flexible.
- Fit for related AS/NZS standards.

### **WARNING**

This product should be installed by the qualified electrician.



# Mounting Block

## MBK180-007



### Mounting Block

Model	Current	Voltage	Packing
MBK180-007	40A	AC500 a.c	100pcs/ctn

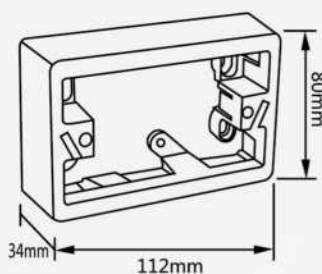

### FEATURES

- Rating 40A 500V a.c.
- Improved out-look and installation operations, more convenient.
- Selected materials make it more stronger and flexible.
- Fit for related AS/NZS standards.

### **⚠️ WARNING**

This product should be installed by the qualified electrician.





# Cable Gland

## OCG12/16/20/25/32/40/50/63



### FEATURES

- Selected eco-friendly materials, nylon PA66(A/C/E) and EPDM rubber(B/D).
- Rated IP68
- Anti-rust and weather proofing, fire protection.
- 1.5 metric thread
- Operating temp. -40°C to 100°C

### WARNING

This product should be installed by the qualified electrician.

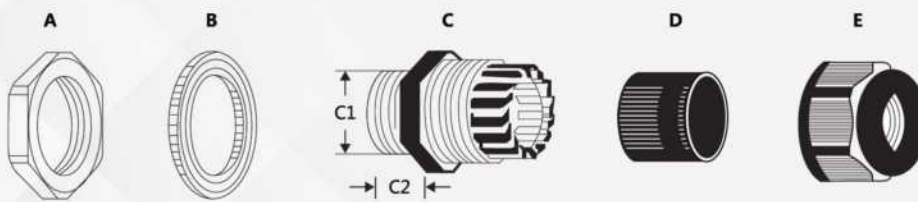

### Cable Gland

Model	Threads	Cable Range (mm)	C1 (mm)	C2 (mm)	Wrench Diameter (mm)	Qty/Box (pcs)
OCG12	M12*1.5	3-6.5	12	8.5	18/15	50
OCG16	M16*1.5	5-10	16	15	22/22	50
OCG20	M20*1.5	8.5-14	20	15	27/27	50
OCG25	M25*1.5	12.5-18	25	15	33/33	20
OCG32	M32*1.5	17-25	32	15	41/42	20
OCG40	M40*1.5	23-32	40	15	50/52	10
OCG50	M50*1.5	30-41	50	15	62/62	4
OCG63	M63*1.5	35-45	63	18	76/65	4

# Adaptable Box

IP66

## FEATURES

- Improved out-look and structure size, more convenient for installation.
- Selected ABS materials makes it strong and tough.
- Fit for related AS/NZS standards.

### ⚠ WARNING

This product should be installed by the qualified electrician.



Model	Set	Dimension (mm)			Qty/Ctn (pcs)
		Plate	Cover Height	Base Height	
ADB110-005	108.5*108.5*72.7	100*100	32	42	100
ADB151-008	159*118.5*80	153*112	23	57	50
ADB191-009	201*155*139.5	195*148	70	70	20

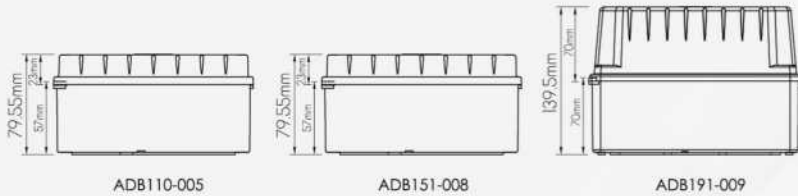

# Cable Clips

## FEATURES

- Clips with impact resistant PP, nail with zinc plated hardened steel and rockwell 47 hardness.
- Standard size and series.

Model	Flat (mm)	Cable (mm)	Qty/Jar (pcs)	Qty/Ctn (pcs)
OCP215-010	10mm	2 core, 1.5mm	500pcs/Jar	12500pcs/ctn
OCP225-012	12mm	2 core, 2.5mm	500pcs/Jar	12500pcs/ctn

# Cable Tie



## FEATURES

- Selected eco-friendly high-quality nylon material- PA66.
- Flammability rating of UL94 V-2.
- Robust, rigid, and highly stable nylon cable ties can help withstand severe conditions.
- Smooth edges help to eliminate damage to valuable equipment.
- Acid and corrosion resistant, quality insulation, long life.
- Black cable ties are resistant to ultraviolet light
- Oval locking head design allows positive cable feed.
- Ziplock packaging design assists with partial usage.
- Operating temperature. -40°C to 80°C

Model	Dimension L*W	Min $\Phi$ (mm)	Max $\Phi$ (mm)	Rated Load (kg)	Color	Qty/Pack (pcs)
OCT100-25B	100x2.5	3	21	8	Black	100
OCT150-36B	150x3.6	3	36	18	Black	100
OCT200-48B	200x4.8	3	50	22	Black	100
OCT200-48B/1000	200x4.8	3	50	22	Black	1000
OCT250-48B	250x4.8	3	65	22	Black	100
OCT250-48B/1000	250x4.8	3	65	22	Black	1000
OCT300-48B	300x4.8	3	81	22	Black	100
OCT300-48B/1000	300x4.8	3	81	22	Black	1000
OCT370-48B	370x4.8	3	104	22	Black	100
OCT370-76B	370x7.6	6	104	55	Black	100

# Cable Connector



## FEATURES

- Selected eco-friendly materials.
- Flame retardant PVC insulator.
- Combination flat screw head.
- Standard series size with matched cable.

Model	Description	Qty/Jar (pcs)	Qty/Ctn (pcs)
OCR-S01	3x6mm <sup>2</sup> single screw	50pcs/Jar	2500pcs/ctn
OCR-T02	2x6mm <sup>2</sup> double screw	50pcs/Jar	2500pcs/ctn



### **Yatai International Corporation**

Yatai Tower, 2673-C Rafael Alunan Street, Interior Road  
Malate, Manila, Philippines  
Tel. No. : +63-2-567-0000 Fax No.: +63-2-567-2342  
Email: info@omni.net.ph  
www.omni.net.ph

### **Yatai (China) Electrical Co., Ltd.**

5th Floor, No. 5 building Guanyinshan International Business Park,  
Siming District, Xiamen, China  
Tel. No.: +86-592-5058882 Fax No.: +86-592-5033882  
www.omni-china.com

### **Omni Electrical (HK) Co. Ltd.**

Room D, 18/F, Blk. 1, Vigor Ind. Bldg., 49-53 Ta Chuen Ping St.,  
Kwai Chung, Hongkong  
Tel. No.: +852-2305-4478 Fax No.: +852-3971-0647  
Email: sales@omni-hk.com  
www.omni-hk.com

### **Omni Electrical and Lighting (Australia) Pty., Ltd.**

#### **Head Office**

Address: 17 Lacey St Croydon Vic 3136 Australia

#### **NSW Office and Showroom**

Address: 8/29 Wurrook Circuit Caringbah NSW 2229  
Tel. No.: +61-1300 333 001 Fax No.: +61-1300 333 002  
Email: sales@omni-au.com  
www.omni-au.com