



SABAI

SABAI Welcome to the Sabai Family!

Let's get cozy.

We're so glad you've joined the party!

Sabai means “comfy,” “relaxed,” and “easy” in Thai. We want you to feel that way about both our products and your experience with us, from start to finish.

Let's get friendly.

You can lounge easy knowing we've worked hard to minimize your sofa's impact on the environment.

Our Packaging:

As you unpack your sofa, you'll notice that our packaging does not use any plastic.

Our Frames:

FSC certified wood.

Our Cushions:

CertiPUR-US certified foam.

Our Pillows:

Recycled fiber.

Our Fabric:

We offer a selection of recycled, upcycled, and natural fiber fabrics.

Our Closed Loop Promise

Furniture is the least recycled household item, with over 80% ending up in landfills. To ensure our sofas do not meet the same fate, we guarantee that we will buy any sofa back within 3 years at 20% of the retail price.

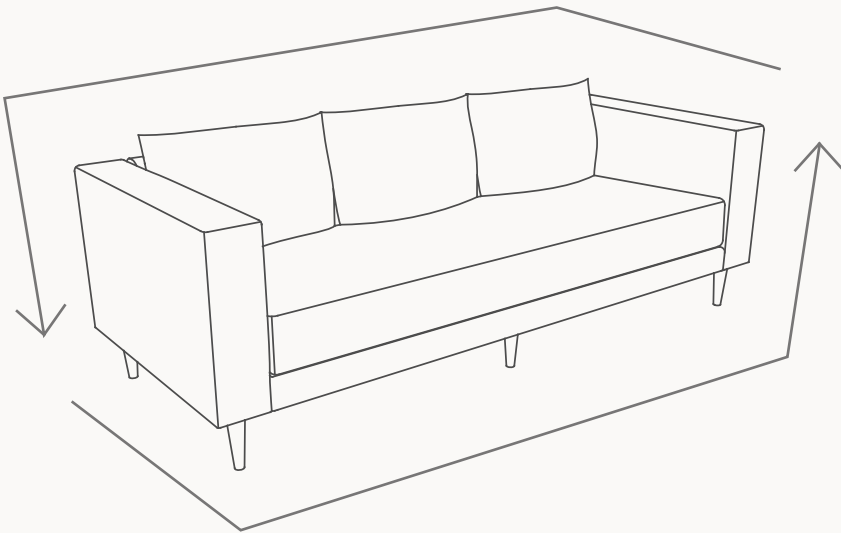

Get ready to lounge!

The Essential Ottoman: Components

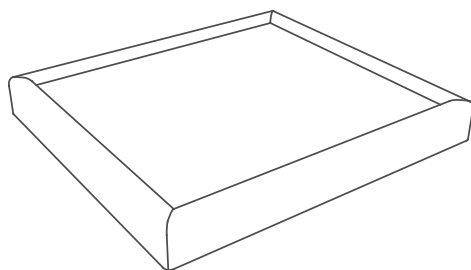

Base (A)

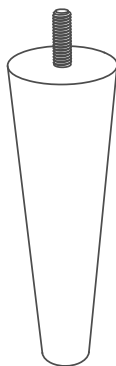

Legs (B x 4)

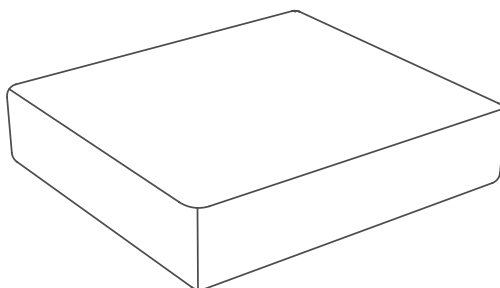

Cushion (C)

How to Assemble: The Essential Ottoman

1. Flip Ottoman Base (A) over.

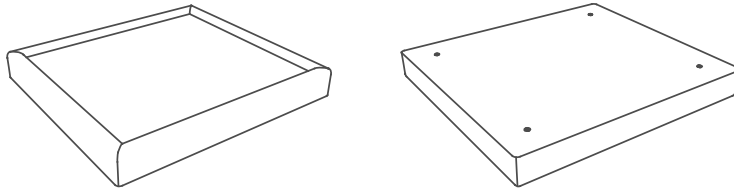

2. Screw 4 Legs (B) into the holes indicated on the bottom of the Ottoman Base.

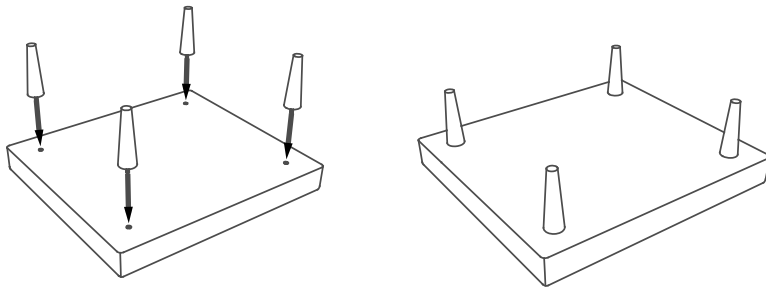

3. Flip ottoman rightside up.

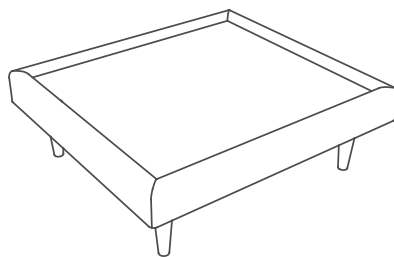

4. Put the Cushion (C) on top.

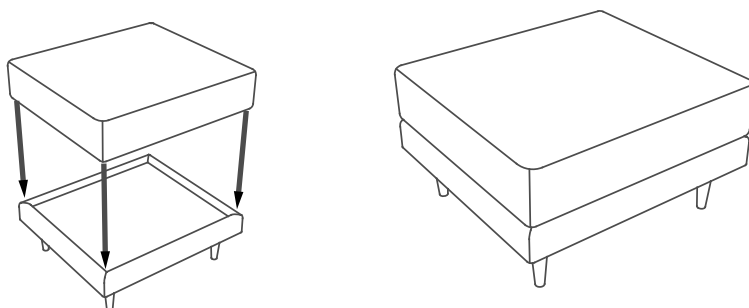





SABAI

Where to find us:

 [sabai.design](#)

 [sabai.design](#)

Questions or concerns?

general@sabai.design