

Maytech MTSKR1905WF Waterproof Remote Control User Manual V3.0

(Firmware V3.0 or higher)

1. Remote (transmitter) appearance:	2
2. Receiver appearance	2
3. Switch on/off	2
4. Display	2
5. Cruise Speed Control in SF (Eurf) Mode	3
6. Charging	3
7. Main Menu Description	4
(1) Thr. Mode	5
(2) 1st Speed Mode	5
(3) 2nd Speed Mode	5
(4) 3rd Speed Mode	5
(5) Batt. Type	6
(6) Batt. Ser Num	6
(7) Pair	6
(8) Calibration	7
(9) Data Source (Default:MTSESC-WP32)	7
(10) M.Pole Pairs (Default: 7)	11
(11) Wheel Dia. (Default: 90)	12
(12) Gear Ratio (Default: 1.0)	12
(13) Dist. Unit (Default: km)	12
(14) VESC Thr. (Default: None)	12
(15) Dist. Rst	13
(16) Thr. Lock(Default:OFF)	13
(17) RF Mode (Default:ECO)	14
8. Other Option Functions you may use in your applications:	14
(1) Receiver Built-in Relay and Transistor switches using instructions	15
(2) Some functions for your reference - Use Relay switch as safety switch	15

Using Video for your reference:

<https://youtu.be/fMK0k7K8LBs>

1. Remote (transmitter) appearance:

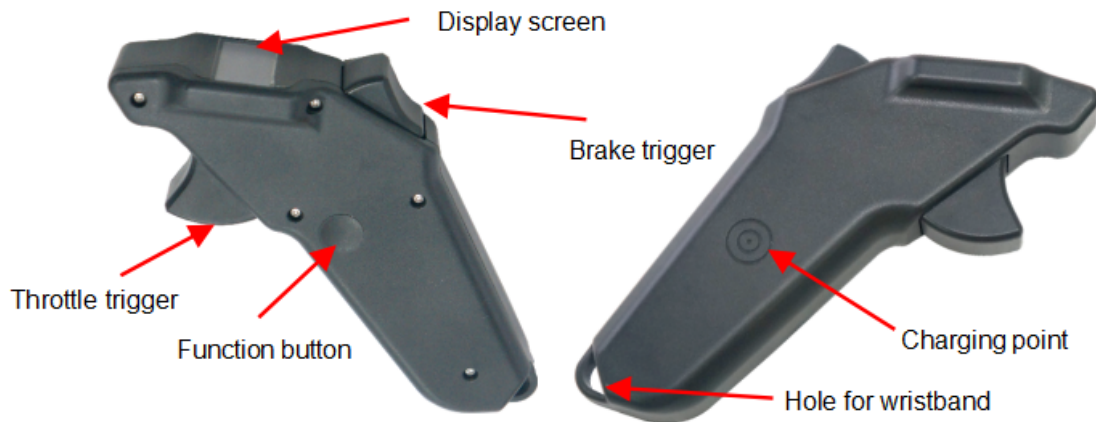

2. Receiver appearance



3. Switch on/off

【Switch on】 When remote is off, long press the function button 1s, screen displays Maytech logo and firmware version to switch on the remote.

【Switch off】 When remote is on, long press the function button 1.5s, screen displays POWER OFF to switch off the remote.

4. Display

When remote is in main interface, Click Function Button to Switch data display on main interface.

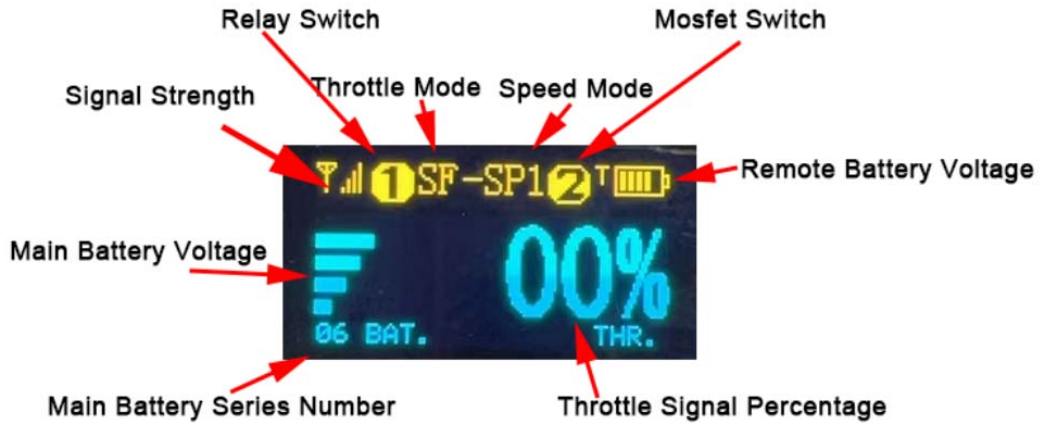

Following Display Page is different for different Throttle mode/Data source. Please Refer this manual “7. Main Menu Description--(9). Data Source”.

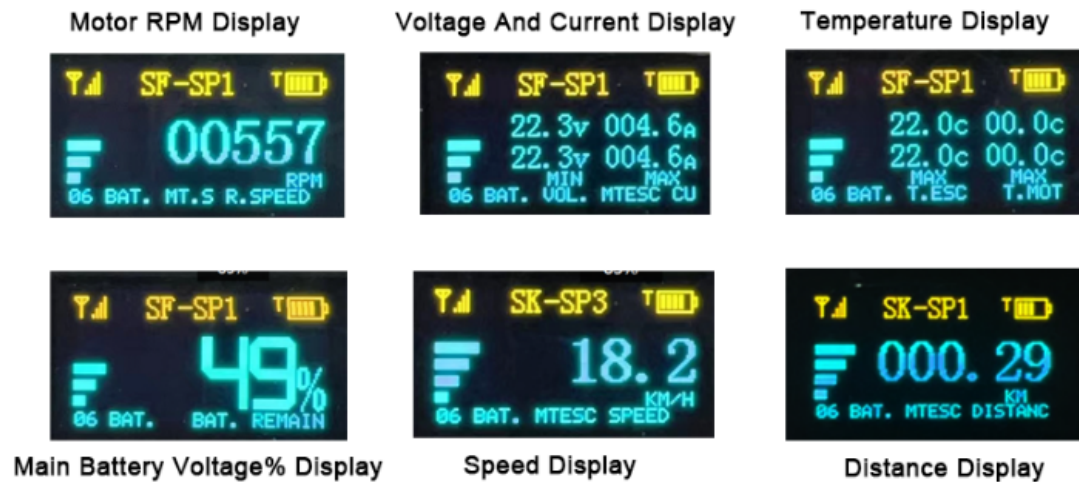

5. Cruise Speed Control in SF (Eurf) Mode

When Throttle trigger is at 10%-100% throttle position, press Brake Trigger for 3 seconds, it enters the cruise speed control mode, and the throttle keeps its original output after release throttle trigger. The cruise control will be canceled when the brake trigger is pressed again or the throttle trigger exceeds the cruise throttle value.

6. Charging

To ensure the waterproof effect, the remote(transmitter) only supports wireless chargers which meet Qi standard. The charger in the kit is shown in the figure below. Charging time is no more than one hour.



- When remote battery icon  has 2 or less bars, it needs to charge the remote. Please keep remote dry when charging.
- Connect wireless charger to power, put remote Charging Point right on the wireless charger; it will automatically charge after 2 seconds.
- Remote screen will show charger input voltage “Input” and current battery voltage “Batt.”.

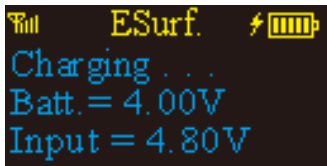

- When remote battery gets to 4.2V, it will stop charging automatically. The screen displays voltage data all the time and will not shut down automatically. Please don't put remote on charger for longtime after full-charged!
- Charging without supervision is prohibited!
- When the remote control is not used, please charge it once a month, otherwise the battery life will be shortened or even scrapped due to long-term power loss.

7. Main Menu Description

【Entry Main Menu】 Hold brake trigger to the end and press Function button.

【Select options in Main Menu】 Short press function button, jump to the next option; Long press function button, select current option and enter sub-menu.

【Exit Main Menu】 When the parameters are edited, press the brake to the end, exit from the sub-menu to the main menu, and then press again to exit from the main menu to the main interface. Special case: when set “Calibration”, trigger will be occupied, please long press function button to exit from Calibration sub-menu to main menu.

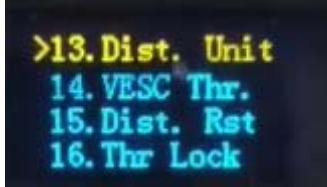
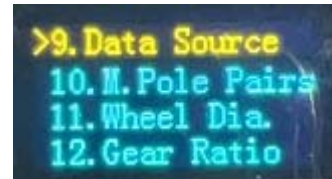
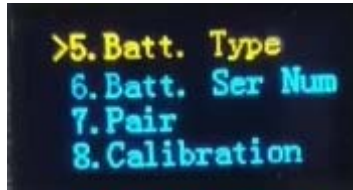
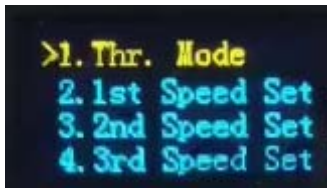

(1) Thr. Mode (Default: Surfboard)

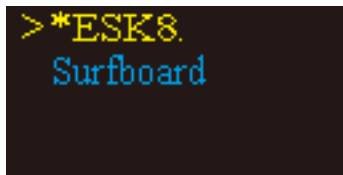

【ESK8.】 Electric skateboard mode (SK):

Throttle trigger 1.5-2ms PWM; Brake Trigger 1.5-1ms PWM; Zero position 1.5ms PWM;

【Surfboard】 Electric surfboard mode (SF):

Throttle Trigger 1-2ms PWM; Brake Trigger No PWM output; Zero position 1ms PWM.

Select 【>1. Thr. Mode】 and long press function button for 1 second to enter Sub-menu. Short press function button to select control mode. Mode with * is current mode, Mode with > is selected mode. Long press function button to move * to the mode you wanted. After setting, press brake trigger back to main menu.

(2) 1st Speed Set (Default: 100)

(3) 2nd Speed Set (Default: 100)

(4) 3rd Speed Set (Default: 100)

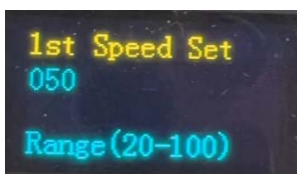

Max throttle% can be adjusted in these 3 speed modes (20%-100%).

For example, if you set '1st Speed Set' to 50, then when you use this SP1 mode and press the throttle trigger to max, the max output throttle signal is 50%.



In the main interface, click function button two times to switch SP1/SP2/SP3.

Select 【>2.1st Speed Set】 and long press function button for 1 second to enter Sub-menu; Long press Function Button to enter Data Setting Interface; Long Press function button to

select digit; Short press function button to add number.

Press Brake Trigger to exit.

(5) Batt. Type (Default: 3.7V)

(6) Batt. Ser Num (Default: 10S)



These two settings are your main battery type and battery cell number in series. The full voltage of the main battery can be obtained by matching these two settings. According to the collected actual voltage, it will calculate the percentage of main battery voltage and display it on screen.



【3.2V】 Lithium-ion ferrous phosphate batteries; 3.2 V per cell.

【3.7V】 Lithium ion or lithium polymer batteries; 3.7 V per cell.

Select **【>5.Batt.】** and long press function button for 1 second to enter Sub-menu.

Short press function button to select control mode. Mode with * is current mode, Mode with > is selected mode. Long press function button to move * to the mode you wanted. After setting, press brake trigger back to main menu.

Select **【>6.Bat.Num】** and long press function button for 1 second to enter Sub-menu.

Press function button to add Battery number. Max number is 18.

Press brake trigger to save number and return to main menu.

(7) Pair

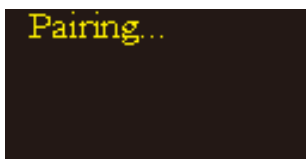

1. If remote and receiver are paired successfully before, then no need to pair them again.
2. If remote and receiver does not get paired before, please pair them according to below steps:

1) Turn off receiver.

2) Select **【>7.Pair】** and long press function button for 1 second to enter pair status. When screen shows **【Pairing...】**, turn on receiver and it will auto-pair with remote control in 0.5 second. Red led lights steady. Pairing completed. Remote screen will automatically return to main menu.

If auto-pairing time is over 1 second and screen still shows **【Pairing...】**, pairing fails and it needs to turn off and turn on receiver again to pair them. If you don't want to continue the pairing process, long press function button to exit to main menu.

(8) Calibration

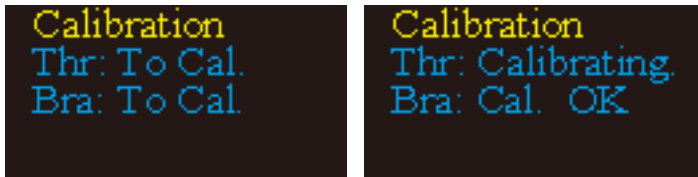

Due to environmental changes during use, remote calibration may be out of proportion to the output of PWM signal. Then it needs to do calibration.

Select **>8.Calibration** and long press function button for 1 second to enter Sub-menu. Once enter calibration, it must need to be finished. If don't continue calibration and exit, remote and receiver will stop working together.

Press throttle trigger to top and loose it. Then press brake trigger to top and loose. When press trigger, the screen will prompt **【Calibrating】** and **【 Cal. OK】** .

After both two are **【 Cal. OK】**, long press function button to return to main menu and save the results.

(9) Data Source (Default:MTSESC-WP32)



This is an important parameter. If you want to show RPM in SF Mode (Esurf) or Speed&Distance in SK mode (Esk8) , please select suitable Data Source in here.

All Data obtained by different data source has some tolerance, it's only for reference. Please note.

And for different options, please wiring receiver and your ESC accordingly.

【 No Source 】 No Data Source, remote screen will not display any information of RPM/Distance/Current/Temperature.

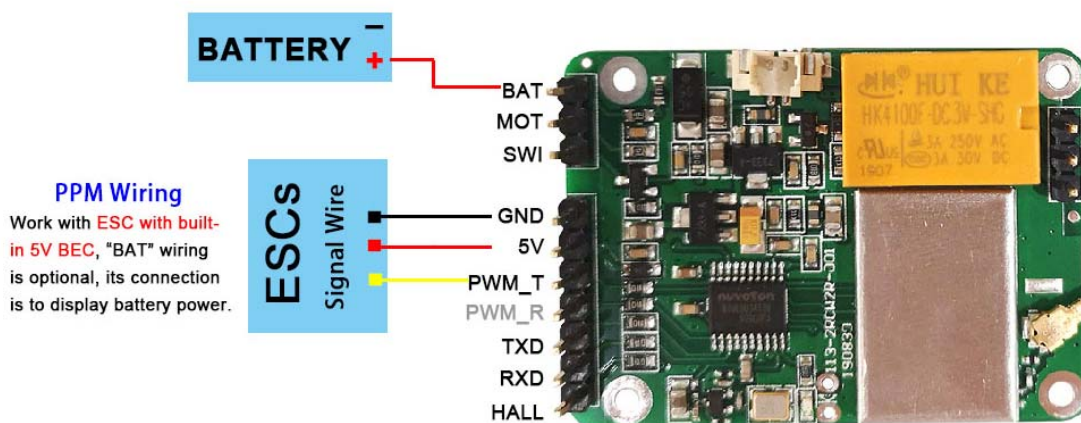

Data Source - **No Source** (Throttle Mode-SF (Surfboard))



Data Source - **No Source** (Throttle Mode-SK (ESK8))



【MTSESC-WP32】 The motor ERPM is obtained by Maytech 32Bit ESC signal wire.

Wiring with Maytech MTSF300A-WP32 ESC

1. Long White + Long Black + Red wire is for PWM throttle signal connection;
2. Short White and Short Black wire is for programming, only connect when you program;
3. Yellow wire is for programming Signal RX or MT Updated Receiver RX Pin
(For Updated MTSKR1905WF Remote to display Batt Volt, Current, ESC temp, Motor RPM
Please leave note when you buy remote if you want this function, so we can update remote firmware for you before shipment.
4. Select "MTSESC-WP32" in "Data Source" in remote.

- "Y" -- Yellow wire
- "LW" -- Long White wire
- "LB" -- Long Black wire
- "SW" -- Short White wire
- "SB" -- Short Black wire

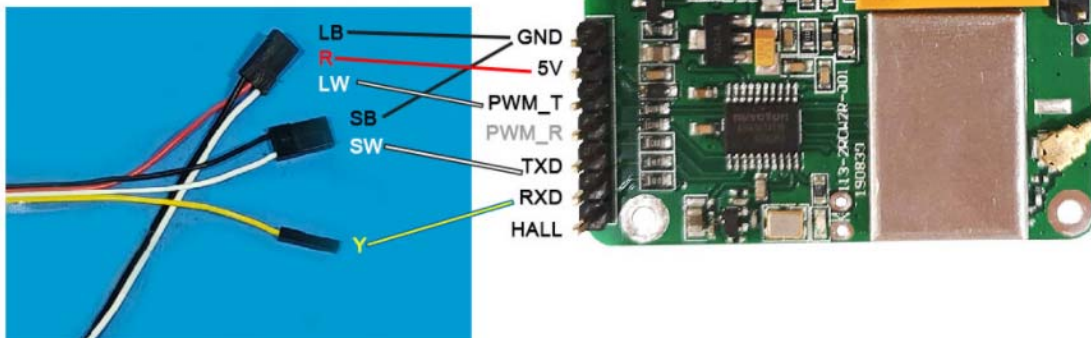

Data Source - **MTSESC-WP32** (Throttle Mode-SF (Surfboard))

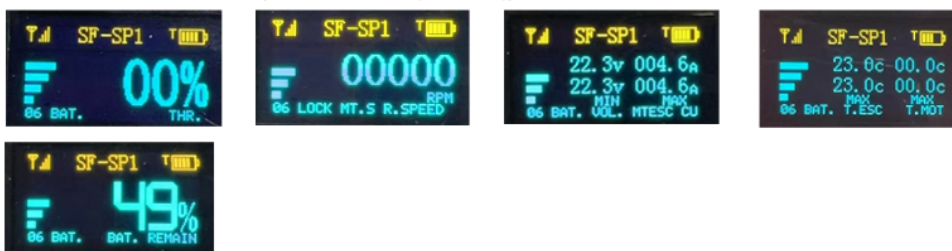

Data Source - **MTSESC-WP32** (Throttle Mode-SK (ESK8))



【VESC】 Read all kinds of valid data from VESC through UART port.

PPM and UART Wiring

(Only works with VESC:
 1. select "VESC" in "Data Source" in remote
 2. Select "PPM and UART" control in VESCTOOL can display voltage, rpm, current, temp, etc values)
 3. Set "Baudrate" to 115200 bps
 4. Remote "14.VESC Thr" needs to be adjusted to "None".

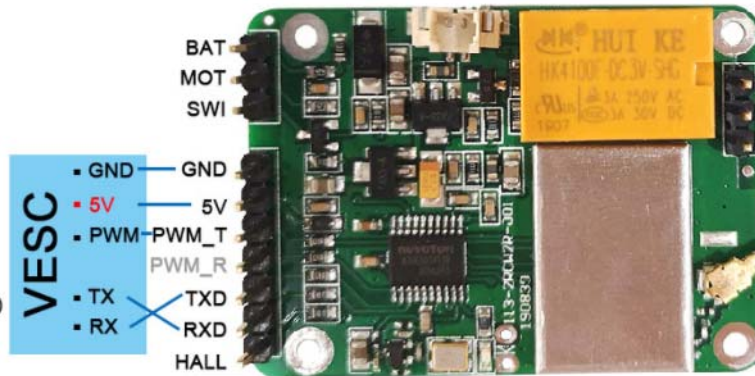

UART Wiring

(Only works with VESC:
 1. select "VESC" in "Data Source" in remote
 2. Select "UART" control in VESCTOOL can display voltage, rpm, current, temp, etc values)
 3. Set "Baudrate" to 115200 bps
 4. Remote "14.VESC Thr" needs to be adjusted to "Current Mode".or "Duty Cycle".

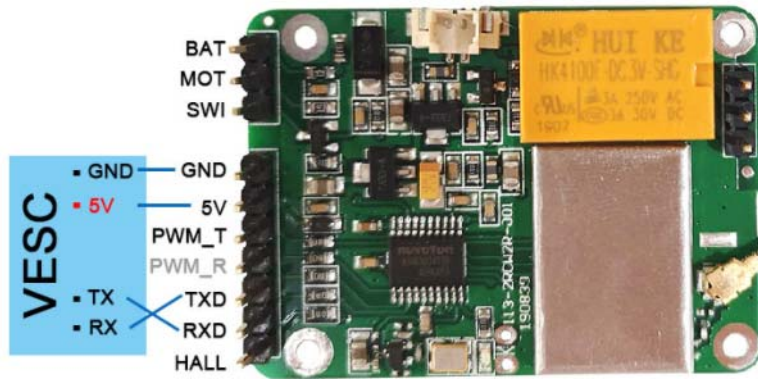

Data Source - VESC (Throttle Mode-SF (Surfboard))

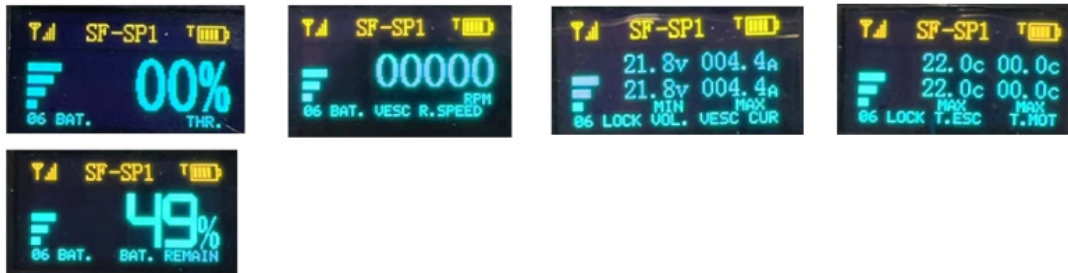

Data Source - VESC (Throttle Mode-SK (ESK8))



【Motor Wire】 The motor ERPM is detected by the motor phase wire back electromotive force.

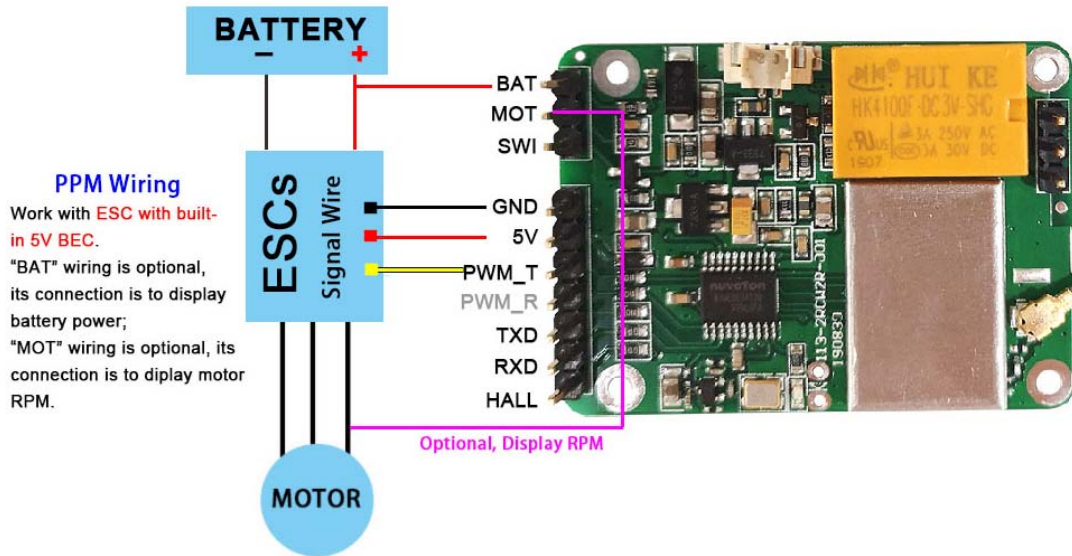

Data Source - Motor Wire (Throttle Mode-SF (Surfboard))



Data Source - Motor Wire (Throttle Mode-SK (ESK8))



If your ESC is OPTO ESC without Built-in 5V BEC, Please connect as below:

Wiring with OPTO ESCs (without built-in 5V BEC)

5V UBEC or 5V external power supply is needed, in the wiring we show diagram with 5V UBEC.

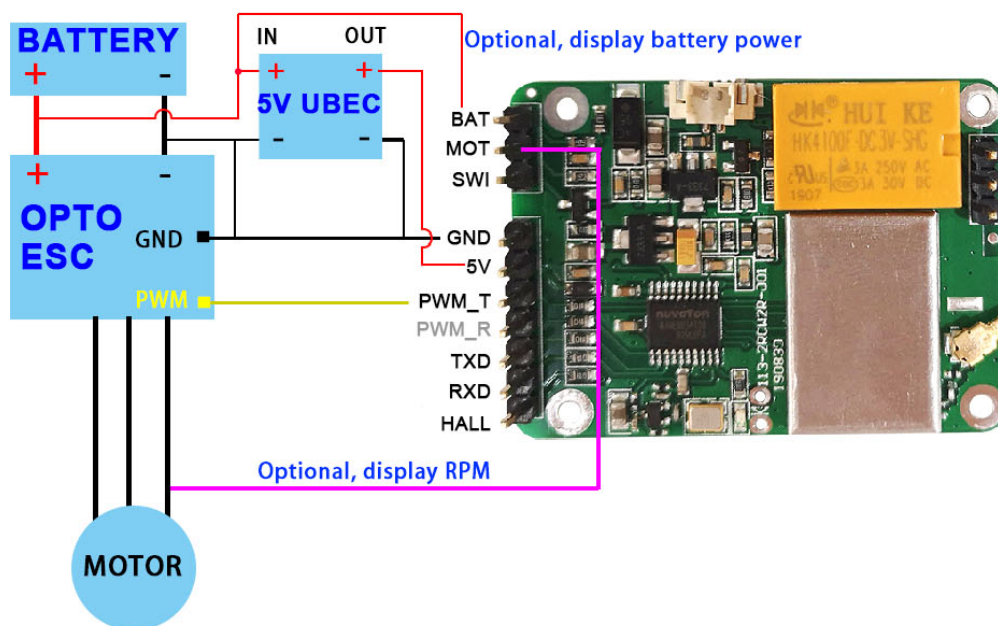

【Hall Sensor】 The motor ERPM is detected by the state change of the Hall sensor.

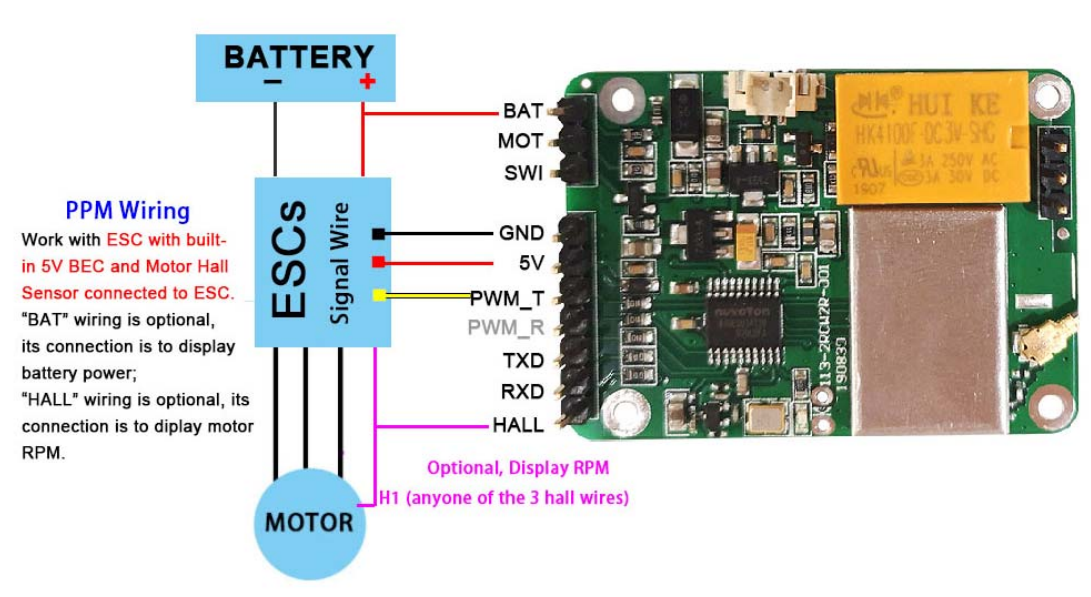

Data Source - Hall Sensor (Throttle Mode-SF (Surfboard))

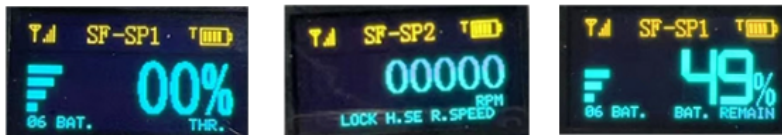

Data Source - Hall Sensor (Throttle Mode-SK (ESK8))

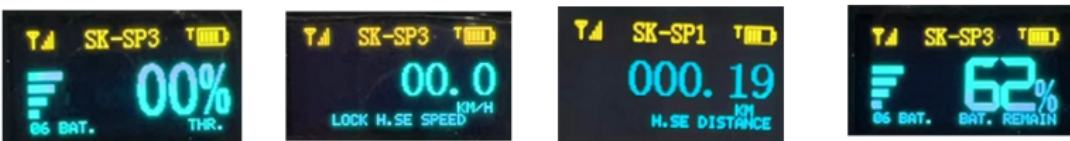

Select **【>9.Data Source】** and long press function button for 1 second to enter Sub-menu. Long press function button to move * to the option you want. After setting, press brake trigger back to main menu.

(10) M.Pole Pairs (Default: 7)

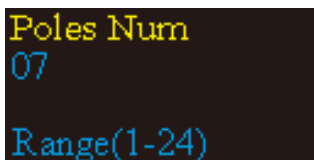

This is your Motor Pole Pairs number! This data is used to calculate motor speed(or RPM) based on motor ERPM (ERPM is obtained by 9. Data Source).

For example, if your motor is 14 poles (magnets number), please set this value to 7 (pairs); If your motor is 20poles (magnets number), please set this value to 10 (pairs).

Press function button to add pole pairs number. Max number is 24.

Press brake trigger to save number and return to main menu.

(11) Wheel Dia. (Default: 90)

```
Tire Dia(mm)
090
Range(40-200)
```

This data is only valid in SK mode (for Electric skateboard). It's to calculate speed and distance.

Long Press function button to select digit; Short press function button to add number.
Press brake trigger to save number and return to main menu.

(12) Gear Ratio (Default: 1.0)

```
Gear Ratio.
03.0
Range(1.0-20.0)
```

$\text{Gear Ratio} = \text{Motor RPM} / (\text{Propeller RPM or Wheel RPM})$. It's to calculate RPM in SF mode (Esurf) or speed and distance in SK mode (Esk8).

Long Press function button to select digit; Short press function button to add number.
Press brake trigger to save number and return to main menu.

(13) Dist. Unit (Default: km)

```
> km
* mile
```

This data is only valid in SK mode (for Electric skateboard). It's unit of measurement for driving distance.

Available units: km and mile. After selecting, speed unit will change to KM/H and MPH correspondingly.

Select **【>13.Dist. Unit】** and long press function button for 1 second to enter Sub-menu.
Long press function button to move * to the option you want. After setting, press brake trigger back to main menu.

(14) VESC Thr. (Default: None)

```
> None
* Current Mode
Duty Cycle
```

This data is only valid when you use VESC speed controllers.

1. If select Current mode or Duty cycle mode, it will automatically open UART port communication. After connecting hardware, please set following 2 parameters in

VESC_TOOL:

APP Setting>>General>>APP to USE>>UART;

APP Setting>>UART>>Baudrate 115200 bps

2. Current mode throttle of the VESC is controlled by the motor current. To get good throttle linearity, the maximum current must be set in VESC_TOOL to match the maximum current actually needed. Too low maximum current will cause too low speed even with top throttle and the maximum power of the motor will not be reached. Too high maximum current will cause motor getting max speed with 50% throttle. 50%-100% throttle has no effect.

3. The benefit of the Current Mode is when release throttle, the motor is free to coast without risk, so this is the common throttle mode for skateboards and surfboards.

4. In the Duty Cycle mode, the VESC takes the speed of the motor as the control target. When the throttle is released to the initial position, the motor will stop immediately. It is possible to throw people off skateboards or surfboards. This mode is only available for differential-controlled robotic carts.

(15) Dist. Rst



This data is only valid in SK mode (for Electric skateboard). It's to reset Driving Distance to 0.

Select **[>15. Dist. Rst]** and long press function button to reset the distance to zero.

(16) Thr. Lock(Default:60S)



[off] Throttle won't be locked;

[10s] If No Action of Remote for 10S, throttle output will be locked to 0% for safety;

[20s] If No Action of Remote for 20S, throttle output will be locked to 0% for safety;

[30s] If No Action of Remote for 30S, throttle output will be to locked to 0% for safety;

[60s] If No Action of Remote for 60S, throttle output will be locked to 0% for safety;

[120s] If No Action of Remote for 120S, throttle output will be to locked to 0% for safety;

Press the Brake Trigger for 3 seconds to unlock the throttle.

Select **[>16. Thr. Lock]** and long press function button for 1 second to enter Sub-menu. Long press function button to move * to the option you want. After setting, press brake trigger back to main menu.

(17) RF Mode (Default:ECO)

Our remote signal has 2 power levels, we define them 1, 2:
Level 1 < Level 2.

【ECO】 Level 1 Signal Strength; Most energy-saving;

【PRO】 Level 2 Signal Strength; Working time per charge is less than “ECO” Mode;
Strongest signal strength, Best performance, More power consumption.

Select **【>17.RF Mode】** and long press function button for 1 second to enter Sub-menu.
Long press function button to move * to the option you want. After setting, press brake trigger back to main menu.

8. Other Option Functions you may use in your applications:

(1) Receiver Built-in Relay and Transistor switches using instructions

Both switches work in Esk8 and Esurf modes.

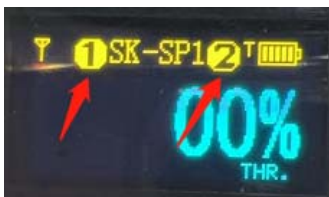

- 1. Transistor Switch (MOSFET Switch) -- Max 20V 2A
-Connect the SWI switch, your LED light and 3S battery as following shows.
-When (Short press Function button four times) transistor switch is on (display of **【2】** in Screen Main interface), transistor switch source will be connected to GND and turn on LED. When it's off(no display of **【2】** in Screen Main interface), LED is off.

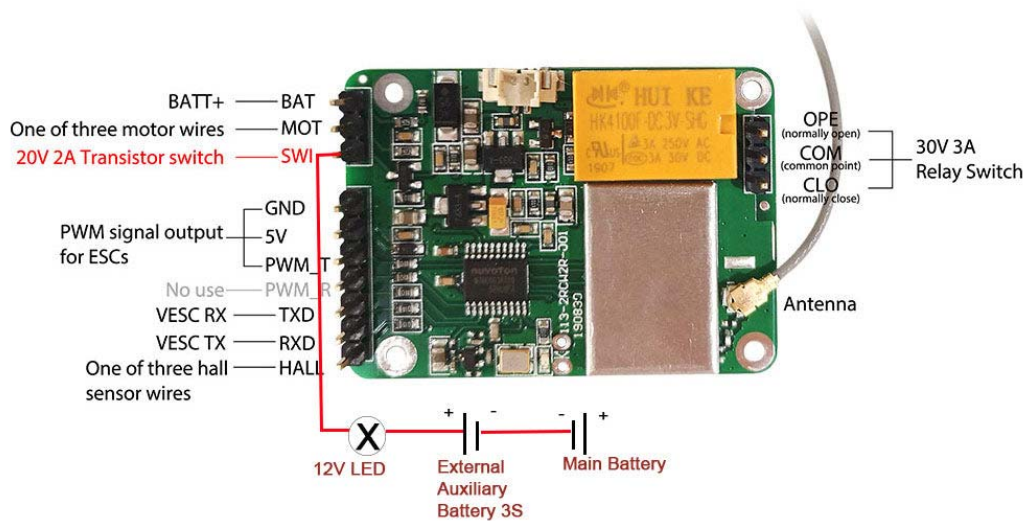

● 2. Relay Switch -- Max 30V 3A

-Max current of relay switch contacts is 3A. Recommend use this switch for water pump or main lighting system. Recommend to connect as following:

-When (Short press Function button three times) relay switch is on or off (display of 【1】 in Screen Main interface).

-When relay switch is in original position(no display of 【1】 in Screen Main interface) , COM(common point) and CLO(normally close) are connected.

-When Short press Function button three times (display of 【1】 in Screen Main interface) , COM(common point) and OPE(normally open) are connected.

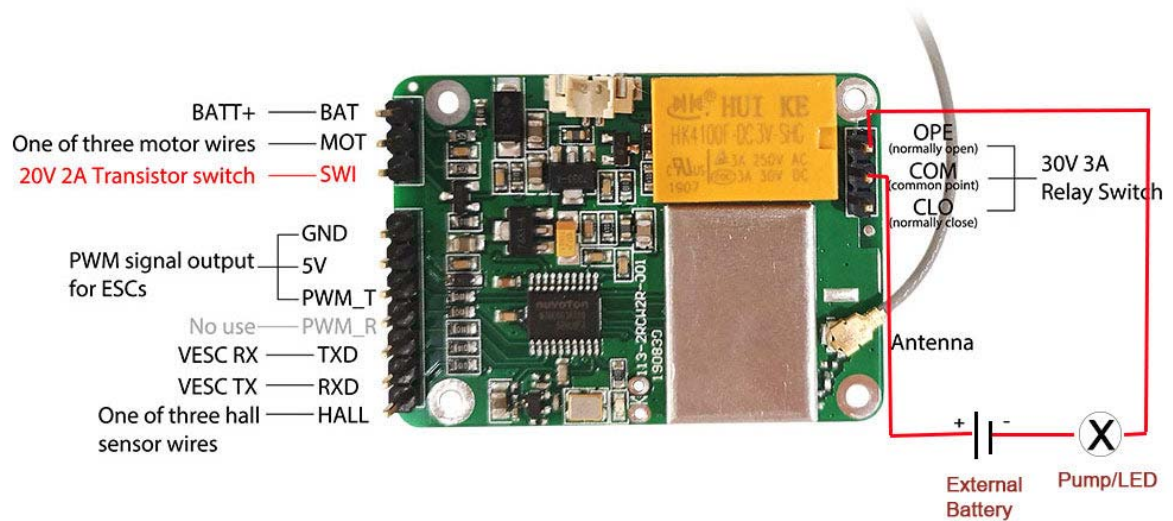

(2) Some functions for your reference - Use Relay switch as safety switch:

冲浪板电调与接收机全功能连接图，继电器做安全开关

