

SANWA

USER MANUAL

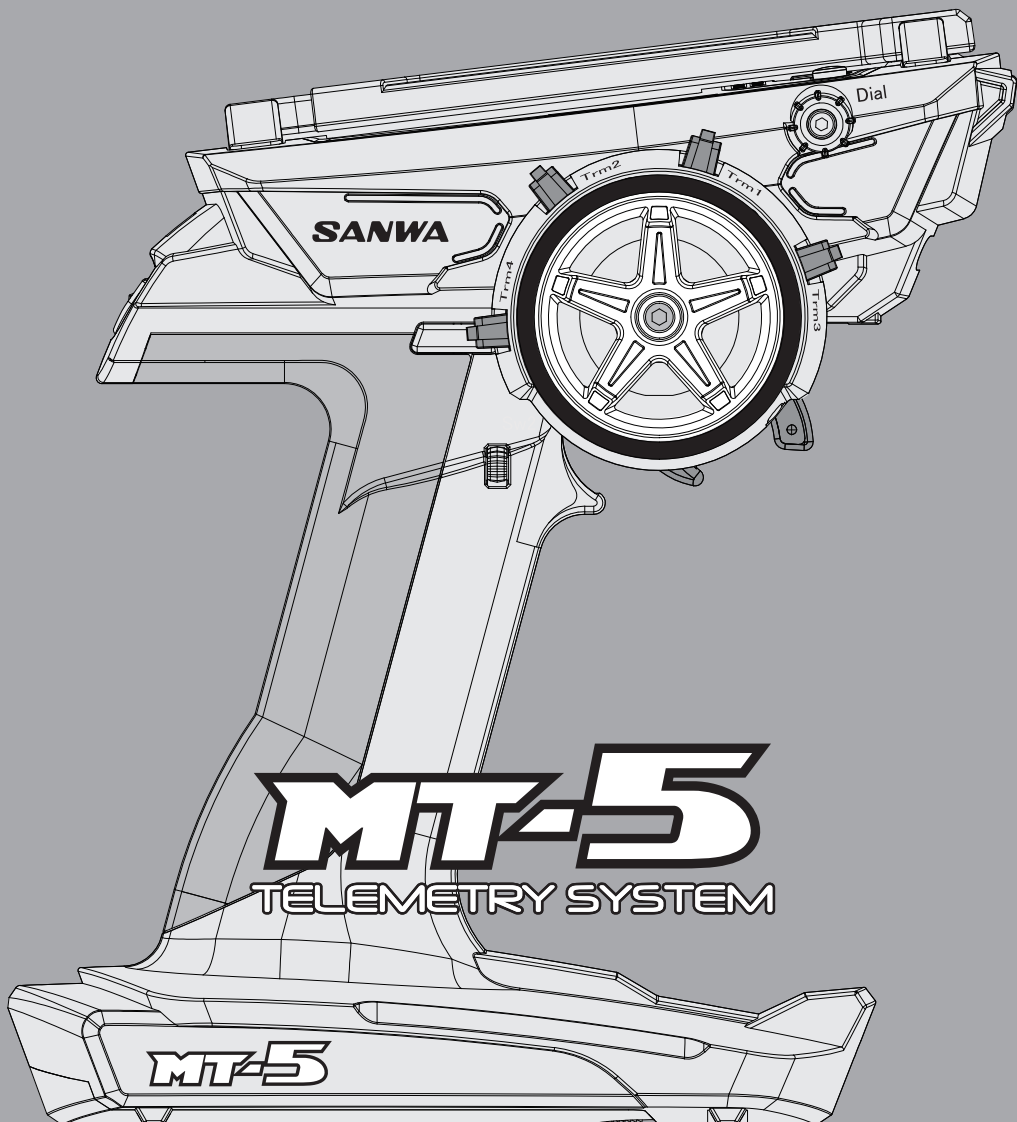

Safe Handling and Precautions

To use your purchased R/C System properly and safely, please read this instruction carefully and make sure to follow the precautions. Improper use of the product or negligence of following safety precautions can cause trouble to others or harm to the user.

- For safety, please make sure to follow each of the precautions below.



Warning

Precautions for Installation and Operation

- When turning the power switch of R/C System on, please turn on in order of 1.Transmitter → 2.Receiver. And when turning the power switch off, please do so in order of 1.Receiver→2.Transmitter.
- ☆ If you reverse the order of the switches, it causes sudden high rotation of the engine and the motor and it's extremely dangerous.

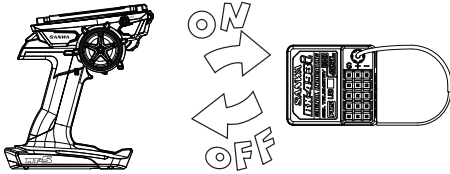

- Please use electrical noise countermeasure on the body of your car.
- ☆ If metals rub against each other, it causes electrical noise which may lead to abnormal performance. Please be sure that all screws and nuts are not loose.
- ☆ Nitro or gas engine and electric motor can cause noise. Please use a noise countermeasure such as a plug with resistor or noise killer condenser.
- Please make sure to run a performance check (signal reception test) of R/C System before operation. When it moves abnormally or it doesn't move, please don't operate. Even if the test result on a desk is normal, please be cautious when operating for the first time especially, since the radio wave arrival distance varies depending on the installation method of the receiver, how the antenna is set, the direction of the transmitter antenna is facing and geography.
- Never operate on a rainy day.
- ☆ The interior of the transmitter is built with sensitive electronic parts. If water runs on the surface of the case and enters inside, it can cause abnormal performance or malfunction and it can be dangerous.
- ☆ If the receiver or a servo sinks in the water, immediately collect it and dry the interior. When the interior is dry, please submit it to the Sanwa Service for inspection even if it performs normally.



- The receiver is a precise instrument. Please do not add a strong impact or vibration.
- ☆ Use a thick sponge to prevent vibrations. Install the receiver as far as possible from the speed controller, motor and the battery.
- When installing the receiver on a metallic chassis or a carbon chassis, use three layers of double adhesive tape pieces to keep the receiver from touching the chassis.
- When there is a radio disturbance, change the installation location of the receiver or change from a vertical placement to a horizontal placement or vice versa.
- Don't place a motor cord or a battery cord close to the receiver since it can cause abnormal performance.
- Keep the antenna of the receiver out as much as possible. And keep it straight and stretched. Don't cut the extra length of the line or bend it.
- ☆ It's dangerous when the antenna is short since the range of travelling becomes narrow.
- ☆ Never cut the antenna.



- Don't place the antenna close to a motor cord or a battery cord.
- Using a conductive piano wire on a metallic chassis or carbon chassis can cause abnormal performance from electrical noise. Don't place a piano wire close to the chassis.

Warning Careful When Driving

When operating an RC car, please make sure to follow the following notes and avoid giving trouble to others.

- Maintain the body of the car (boat) in a perfect condition and check the safety.
- Do not operate an RC car in a crowd or on a public road.
- Make sure to disconnect the connector of the power battery and remove the power battery from the car after operation.
- When operating simultaneously with other RC users, make sure to have a control staff and follow the instruction of the control staff.
- Try not to interfere with other people's operation.
- Be sure to apply for a radio control insurance.
- For application to apply a radio control insurance, inquire a radio control operator registration agency.
- Be sure to install a "muffler (sound absorber)" with a silencing effect on an engine car.
- Don't start engine early in the morning.
- Please make sure to clean the location used for operation before you leave.

Caution About Usage

- Do not use this RC system for other than model use.
- Since this product is manufactured for models based on the Radio Law in each country, it cannot be used in countries other than your original place of purchase.

Caution Daily Care

- When the exhaust of the engine or fuel is on the radio, wipe it with a soft, dry cloth. When it gets dirty, please wipe it with a tightly squeezed clean soft cloth impregnated with water or neutral detergent. Thinner, benzene, alcohol, motor cleaner, brake cleaner, etc. may cause surface finish to deteriorate or degenerate, so please do not use.

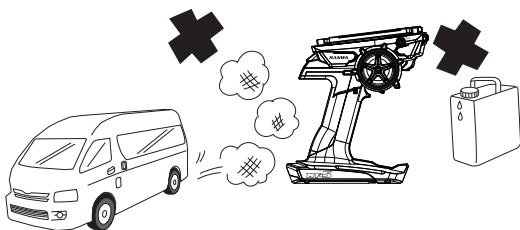

Caution Handling Transmitter



- Please do not hit, drop or cause strong shocks. In addition, if you touch the transmitter, receiver, servo, FET speed controller, etc. with hands applied with tire traction agent, it will cause breakdown or case deformation.

Caution About Storage

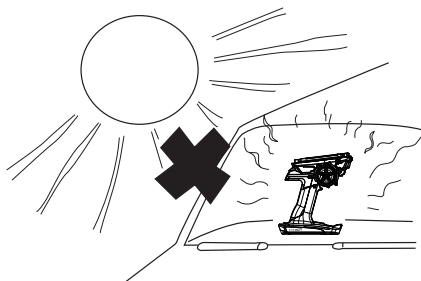
- Do not store in following places.
 - ☆ Extremely hot place or extremely cold place.
 - ☆ A place that is exposed to direct sunlight for a long time. Especially if you leave it in a place where direct sunlight hits like in a closed car window, the interior temperature becomes 80.0 °C (176.0°F) or more depending on the season, so please be careful as it may cause deformation or breakdown.
 - ☆ A place with high humidity, poor ventilation.
 - ☆ A place with considerable vibrations.
 - ☆ Places with high dust places subjected to steam or hot air.
 - ☆ A place that gets exhaust gas from an engine or a place near the fuel tank.



Meaning of the mark

-  **Caution** Things you are expected to do to prevent accidents and injuries.
-  **Warning** Things that you should follow in order to prevent break down.

Safe Handling and Precautions



Warning Note Precautions for Safe Use

- 2.4 GHz frequency band is not only used for radio control. This frequency band is shared with ISM (Industry, Science and Medical) band. It can be affected by microwave ovens, wireless LAN, digital cordless telephones, audio equipment, Bluetooth of game machines or cell phones and short-range communication such as VICS. Also, be cautious about being affected by amateur radio and premises radio stations for moving body identification since this frequency band is used for them as well. When a harmful radio frequency interference is done to an existing radio station, stop the transmission of the radio frequency immediately and take a measure to avoid the interference.
- For RC circuit, minimize the use of equipment that can affect 2.4 GHz systems and make sure to check the safety beforehand. Also, follow the instruction of the facility manager.
- When operating the models behind a building or a steel tower, blocking the direction of radio wave transmission can cause reduction of operation response or loss of control. Always operate within the range you can visually check.
- Don't grab the transmitter antenna. Doing so can be dangerous since it can weaken the radio signal output and narrow the range of operation.
- Don't attach any metal parts around the antenna of the transmitter.
- If you have the transmitter's antenna extremely close to a servo or speed controller other than the receiver, it can cause malfunction but it is an influence of a strong high frequency output and it is not abnormal.
- The receiver is a precise instrument. Don't subject it to strong impact or vibrations. Use a thick sponge to prevent vibrations.
- Keep the antenna wire of the receiver out as much as possible. And keep it straight and stretched. Don't cut the extra length of the antenna line or bend it.
- Keep the antenna wire of the receiver out as much as possible. And keep it straight and stretched. Don't cut the extra length of the antenna line or bend it.
- Don't place the antenna wire of the receiver close to a electrical noise source like a motor wire or a battery wire.
- When installing the receiver on a metallic chassis or a carbon chassis, use layers of double adhesive tape pieces to keep the receiver from touching the chassis as much as possible.
- MT-5 do not have automatic power off system. The transmitter would not be turned off until switching off. Please make sure to switch off the transmitter when finishing to use the transmitter. If the transmitter was turned on for an extreme long time, transmitter battery would be over discharged and led to damage. The battery damages would lead to battery liquid leaking, ignition, detonation, and so on.
- If expecting to store MT-5 for a long time, please store the transmitter without plugging the transmitter battery.

INDEX

■ Structure and the Standard of the Set.....	5
● Structure of the set (5)	
● Set specification (5)	
■ Before Using.....	6-8
● Adjusting tension of the steering and throttle, the grip pad (6)	
● Adjusting the the full adjustable trigger (7)	
● About the power source, about micro SD card (8)	
■ About connecting and installing the receiver.....	9-10
● About the receiver, handling the antenna (9)	
● About connection setup (10)	
■ Names of each part of the transmitter.....	11-12
■ How to use each feature.....	13-60
● About Key Operation (13)	
● About Power On Alarm (13)	
● About the Display Panel (14)	
● About the Menu Structure (15)	
● About Short Cut Menu (16-18)	
• Direct Model Select (16)	
• Quick Setup Wizard (17-18)	
● Setting [SETTING] (19-32)	
• Dual Rates (D/R) (19)	
• Speed [SPEED](20)	
• Curve [CURVE] (21-24)	
• Fail Safe [F/S] (25)	
• Base [BASE] (26-28)	
• Reverse [REV] (26)	
• Sub Trim [SUB-T] (26)	
• End Point Adjustment [EPA] (27-28)	
• Trim [TRIM] (29-30)	
• Anti-Lock Brake [ALB] (31)	
• Offset [OFFSET] (32)	
• Throttle Type [TH TYPE] (32)	
● AUX [AUX] (33-36)	
• Step AUX [STEP AUX] (33)	
• Point AUX [POINT AUX](33)	
• 4 Wheel Steering [4WS] (34)	
• Motor On Axle [MOA] (34)	
• AUX Mixing [AUX-MIX] (35)	
• Code AUX [CODE AUX] (36)	
● Timer [TIMER] (37-39)	
• Setup [SETUP] (37,38)	
• Lap Timer [LAP TIMER] (38)	
• Interval Timer [INT TIMER](39)	
• Down Timer [DOWN TIMER] (39)	
● Telemetry [TELEMETRY] (40-44)	
• LOG [LOG DATA] (40)	
• View Data (41)	
• Data Name (41)	
• Export [.CSV] (42)	
• Protect (42)	
• Delete (42)	
• Telemetry Setting [TELEMETRY SETTING](43)	
• Graph Setting [GRAPH SETTING] (44)	
• Telemetry Switch [TELEMETRY SWICH] (44)	
● Model [MODEL] (45-48)	
• Model Select [MODEL SELECT] (45)	
• Model Name [MODEL NAME](46)	
• Model Copy [MODEL COPY] (47)	
• Model Clear [MODEL CLEAR] (48)	
● System [SYSTEM] (49-60)	
• Bind [BIND] (49-50)	
• Key Assign Switch [KEY ASSIGN SW](51)	
• Key Assign Trim [KEY ASSIGN TRIM] (52)	
• Custom List [CUSTOM-LIST] (53)	
• AUX TYPE [AUX TYPE] (54)	
• Racing Mode [RACING MODE] (55)	
• Battery [BATTERY] (56)	
• Buzzer [BUZZER] (56)	
• LCD [LCD] (57)	
• LED [LED] (57)	
• Clock [CLOCK] (58)	
• Setup [SETUP] (58)	
• Calibration [CALIBRATION] (59)	
• Firmware [FIRMWARE] (60)	
■ Assign Function List	61
■ RX-DATA (Receiver Installation)	62
■ Index.....	63
■ When this happens.....	64
■ Service and Support.....	65
■ FCC Compliance Statement.....	66

Structure and the Standard of the Set

STRUCTURE OF THE SET

	MT-5 RX-493i PC (Primary Component)
<A> Transmitter	MT-5(TX-491)
 Receiver	RX-493i
<C> Servo	—
<D> Accesories	Strap Hook x1 Trigger Angle Spacer x2 Brake Trigger +1/+2 x each 1 Grip Pad S size x1 Receiver Dust Cover x1 Bind Plug x1 Antenna Pipe x1 Sponge for Optional Battery x1 User Manual x1

●Please check items before use

SET SPECIFICATION

<A> Transmitter	
Product No.	MT-5(TX-491)
Output Display	Analog/Digital display (Power Source Voltage Display)
Modulation	2.4 GHz Spread Spectrum System
Power Source	AAA BATT x3 (Corresponding VOLT:TDC2.7 - 5.0 V)
Weight	382 g

 Receiver	
Product No.	RX-493i
Modulation	2.4GHz Spread Spectrum System
Size	26.0x23.2x14.0mm
Power Source	DC3.7~7.4V
Weight	6.2 g

*Be careful with the input voltage.
 If voltage above allowable voltage is inputted, the transmitter will be damaged.

Before Using

ADJUSTING THE STEERING AND THROTTLE TENSION

MT-5 can adjust the tension of the steering/throttle trigger to match operation of the steering/throttle to the user's preference.

Adjusting the Steering Tension

By inserting a hex wrench driver (1.5mm) to the place where the arrow is pointing at in the illustration on the right and turning, you can adjust the tension of the steering spring.

*The spring tension is the softest at the time when the product is shipped out from the factory. As you tighten with a hexagon wrench driver (1.5mm), the spring tension will be hardened.

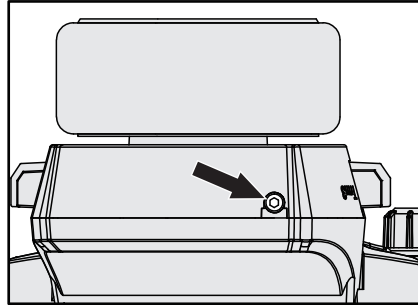

Adjusting the Throttle Trigger Tension

By inserting a hex wrench driver (1.5mm) to the place where the arrow is pointing at in the illustration on the right and turning, you can adjust the tension of the throttle spring.

*Please do CALIBRATION for steering and throttle when changing the tension. (p.59)

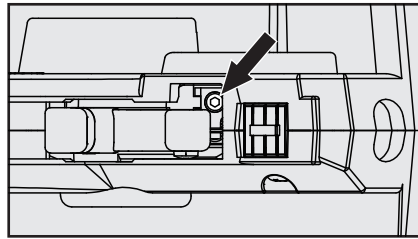

ADJUSTING THE GRIP PAD

MT-5 can change a grip pad from two types of normal/small to suit the size of the user's hand.

(The normal size is installed at the factory.) Do not pull forcefully because it's locked to the grip of the transmitter with tabs of the grip pad (at 11 locations).

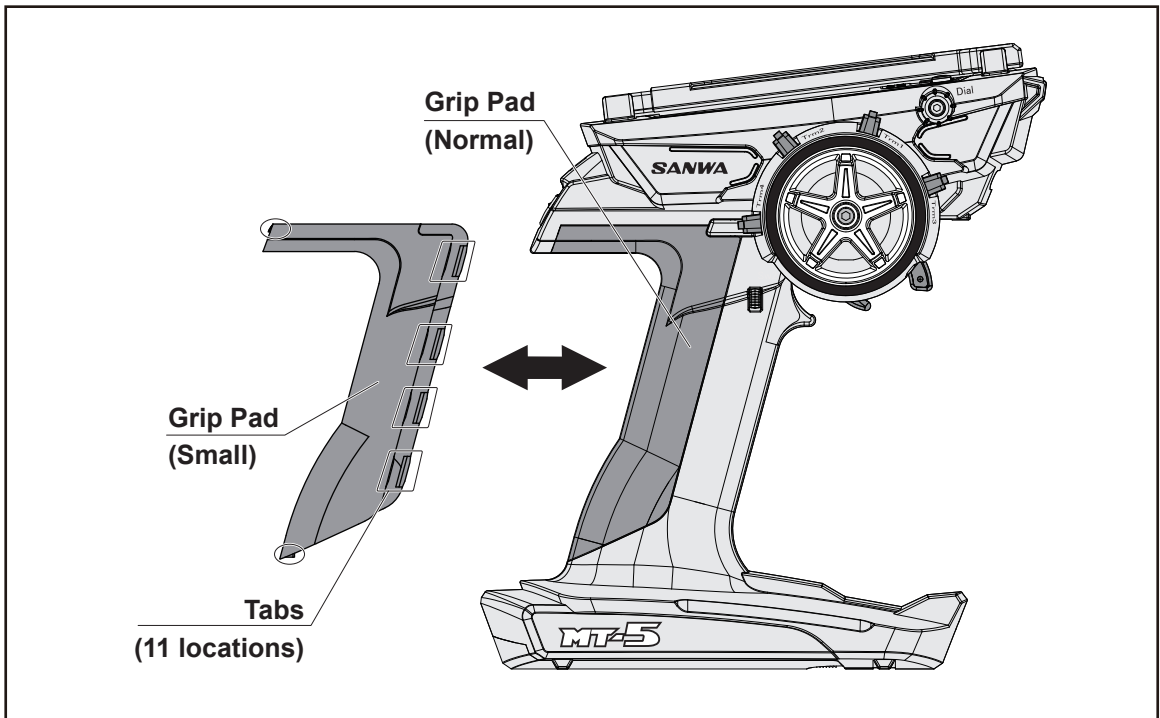

Before Using

ADJUSTING THE FULL ADJUSTABLE TRIGGER

Adjusting the trigger position

Loosen the fixing screws of the trigger on the back of the transmitter. Then, adjust the adjusting screw of the trigger position on the back of the transmitter to set the trigger at the position of your preference. When you turn the adjusting screw of the trigger position clockwise, the trigger position gauge moves to the direction A. By turning it counter clockwise, the trigger position gauge moves to the direction B.

*The range of the trigger movement is 5mm. If you turn the screw forcefully beyond the range, it can cause malfunction. Once you set the trigger position, tighten the fixing screw and adjusting the trigger is done.

*Be careful with the direction of turning the screw because the trigger position is set at the furthest point of the A side at the factory.

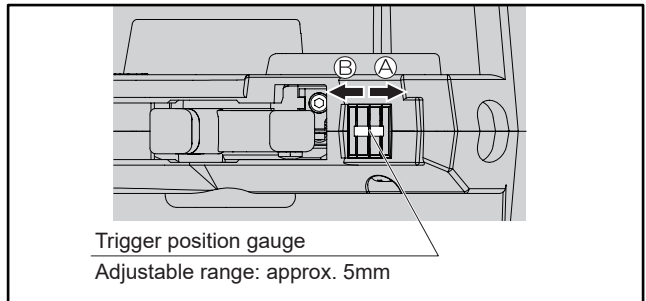
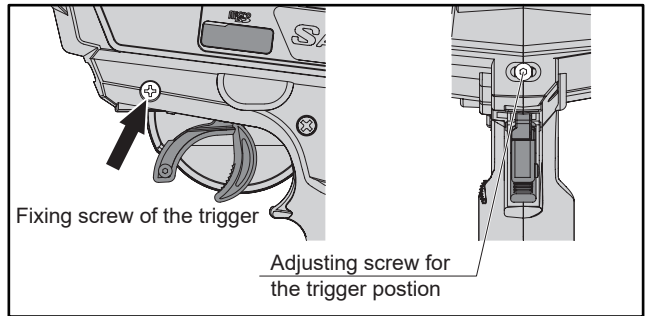

Adjusting the trigger angle

By switching the angle spacer A/B/C, it is possible to adjust the angle of the throttle trigger to five steps.

- 1) Remove the fixing screw of the trigger on the back of the transmitter.
- 2) Adjust the angle by changing the direction of the angle spacer to have an angle easy to operate.
- 3) Once the trigger angle is set, fix the fixing screw of the trigger on the back of the transmitter.

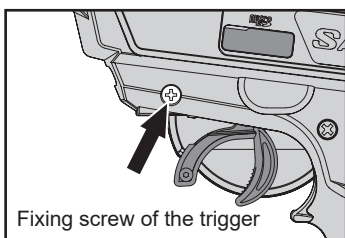
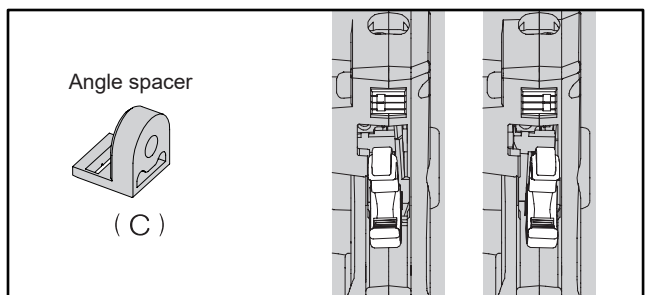
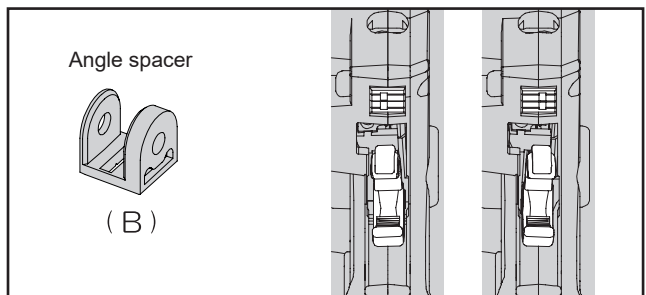
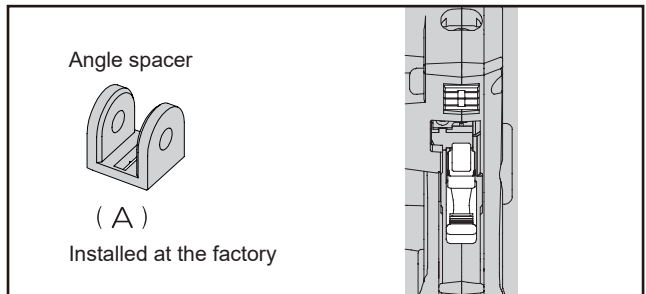

Adjusting the brake trigger

You can adjust brake trigger position according to your fingers by replacing the included brake trigger. Standard Size, +1 Size, +2 Size is included.

- 1) Remove the brake trigger fixing screw.
- 2) Select Brake Trigger according to your fingers.
- 3) Fix the brake trigger by the screw.

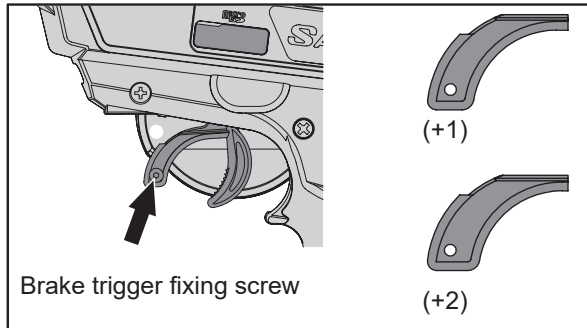

ABOUT THE POWER SOURCE

HOW TO PLACE THE TRANSMITTER BATTERIES

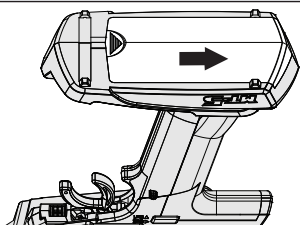

<1>Open the battery compartment cover by sliding the cover to the direction of the arrow while pressing it lightly.

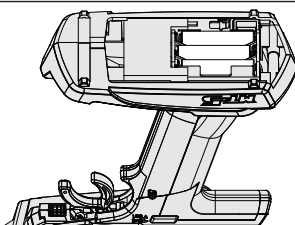

<2>Place 3 size AAA batteries. Make sure to observe correct polarities.

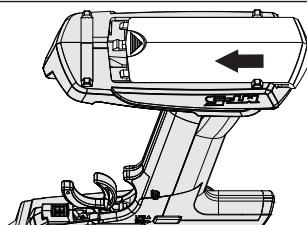

<3>Align the convex part of the battery compartment cover and the groove of the battery compartment, slide the cover to the direction of the arrow and close tightly.

ABOUT THE OPTIONAL BATTERY

- When using an optional battery, you can access to the charging port on the side of the battery from the connector cover.

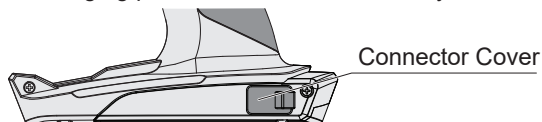

ABOUT MICRO SD CARD

- MT-5 is compatible to Micro SD Cards. By using a Micro SD Card, it is possible to save model data and telemetry data. Also, it is possible to do firmware update using a Micro SD Card when a firmware update of MT-5 is released. Please take care of direction. Metal terminal should be bottom.
 - After inserting micro SD card into MT-5, the file named "MT-5" is made and the folder named "MODEL" is made. The model data is saved in the folder. If the log data is exported, the folder named "Log" is made and the data named "csv" is saved in the folder.
- *Compatible Micro SD card capacity is maximum 32GB. Other manufacture Micro SD card might not be able to use. Please use Micro SD card by SANWA.

When micro SD card is inserted, this mark will be on.

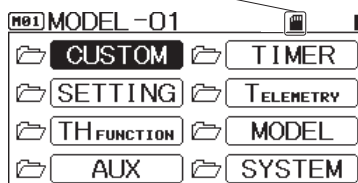
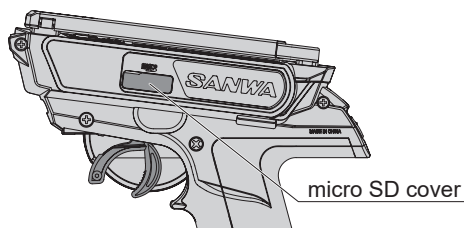

Connections and Installation of Receiver

ABOUT THE RECEIVER

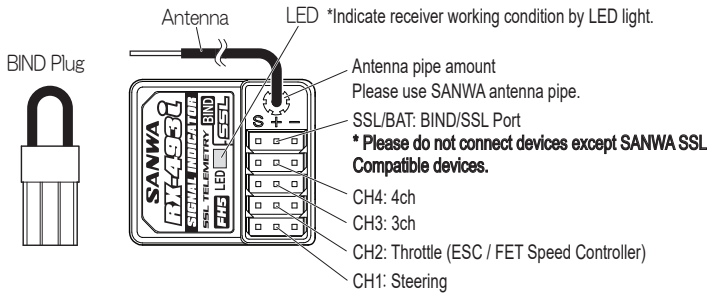

Indication of Receiver Working Condition by LED light

Connected	Blue light On *When binding with 2 transmitter, blue light flush at 2 sec intervals.
NOT Connected	—
In BIND Setting	Blue light flushing Blue light blinking
Battery Fail Safe Working	Blue and red light on
Receiver is not connected in Battery Fail Safe working	Red light on

● RX-493i

RX-493i can evaluate received signal strength and packet delivery ratio from transmitter.

RX-493i can store 2 transmitter ID Number. It is able to combine using individual transmitter which is different setting in endurance race .

If you bind with 2 different transmitter, the receiver store the different transmitter and can operate by transmitters without re-bind.

*CANNOT operate by the 2 different transmitter at the same time. 2 ID store system is only compatible with M17 or MT-5.

Throttle neutral position or operation quantities might be different each transmitter. Please adjust each transmitter setting to fit chassis linkage.

When setting SSL compatible devices by MT-5 CODE AUX function, please connect SSL compatible device to SSL port.

MUST set fail-safe setting on each transmitter.

Please set same RF mode and response mode as 1st transmitter when you bind 2nd transmitter. If it was different mode, cannot bind with 2 transmitters.

*If 2nd transmitter was different RF mode and response mode from 1st transmitter, 1st transmitter ID No. is deleted and only write 2nd transmitter.

*If you bound 3rd transmitter, 1st transmitter ID No. will be deleted.

*When using first time, please bind with receiver. (p.49)

ABOUT HANDLING THE ANTENNA

- Reception distance may vary depending on the location where the receiver and the antenna are installed.
- To protect the reception part (3 cm from the top) of the antenna, make sure to place the antenna in the antenna pipe as shown in the right illustration so that the top of the antenna is not exposed outside of the antenna pipe.
- Don't bend the antenna reception part or the antenna coaxial cable because breaking can occur inside.
- Don't pull the coaxial cable forcefully. It may damage the receiver interior.
- Install the antenna on an RC car so that the antenna reception part is in as high place as possible.
- Don't cut or bind the antenna reception part or the antenna coaxial cable since the receiver sensitivity might decrease.
- Keep the receiver antenna away from the motor and the ESC (FET Speed Controller) including cables and raise it straight.

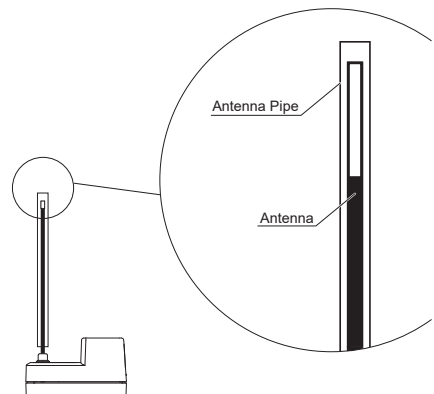

ABOUT CONNECTION SETUP

Please refer the below picture for receiver and servo connection

●Connection example in case of using in EP car

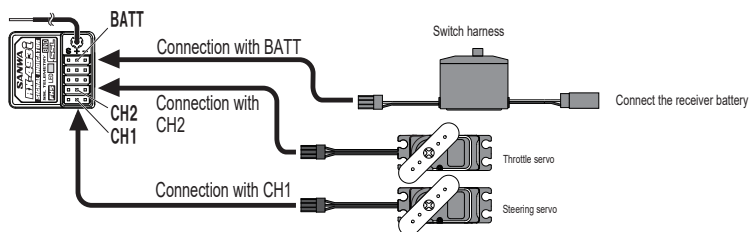
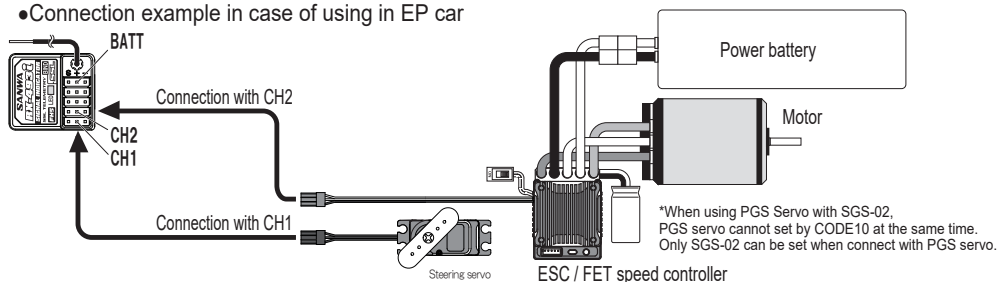

■Case of connecting PGS servo and SUPER VORTEX Gen2 / PRO / Stock / SV-D2 to SSL port

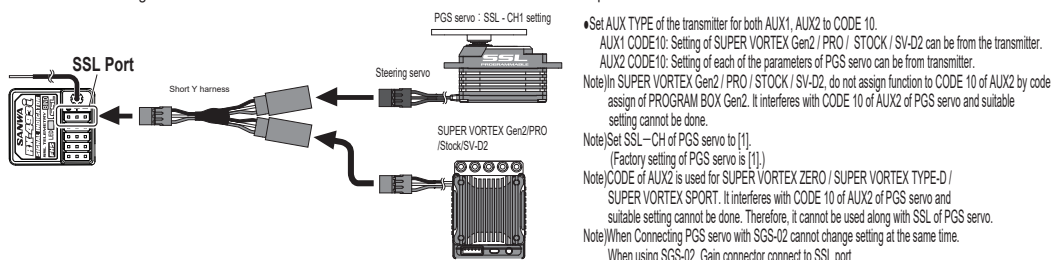

■Case of connecting PGS servo to 2 SSL ports

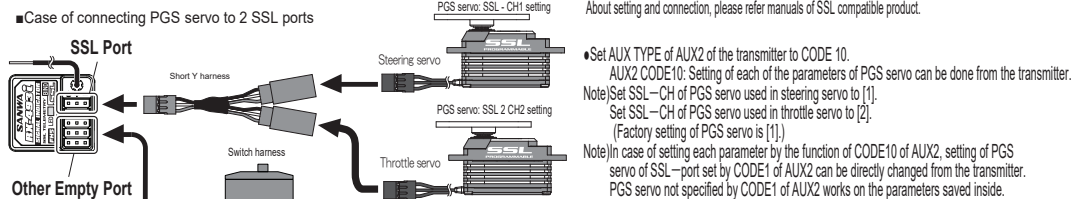

*Please, refer on our Website about any other examples. <http://www.sanwa-denshi.com>

! Note

- If the connector is disconnected due to a vibration during operation, it can cause runaway. Connect the connector of the receiver, servos and switches securely.
 - Because the receiver is susceptible to vibration, impact and water, make sure to take measures for vibration-proof and waterproof. Negligence of taking these measures can cause runaway.
 - When installing the receiver, keep the receiver away from a carbon chassis and metallic chassis.
 - If metal parts installed on an RC car touch each other, it can cause noise that affects reception performance and it can cause runaway.
 - Make sure to install a noise killer condenser on the brush motor for electric RC cars. Without a noise killer condenser, it can cause noise and runaway.
 - For R/C System parts such as the transmitter, receiver, servos, ESC (FET Speed Controller) and transmitter battery, use genuine SANWA products.
- *When combining products other than genuine SANWA products, modifying, adjusting or exchanging parts is done at a place other than SANWA, we do not take any responsibility.

Names of each part of transmitter

Names of each part of the transmitter

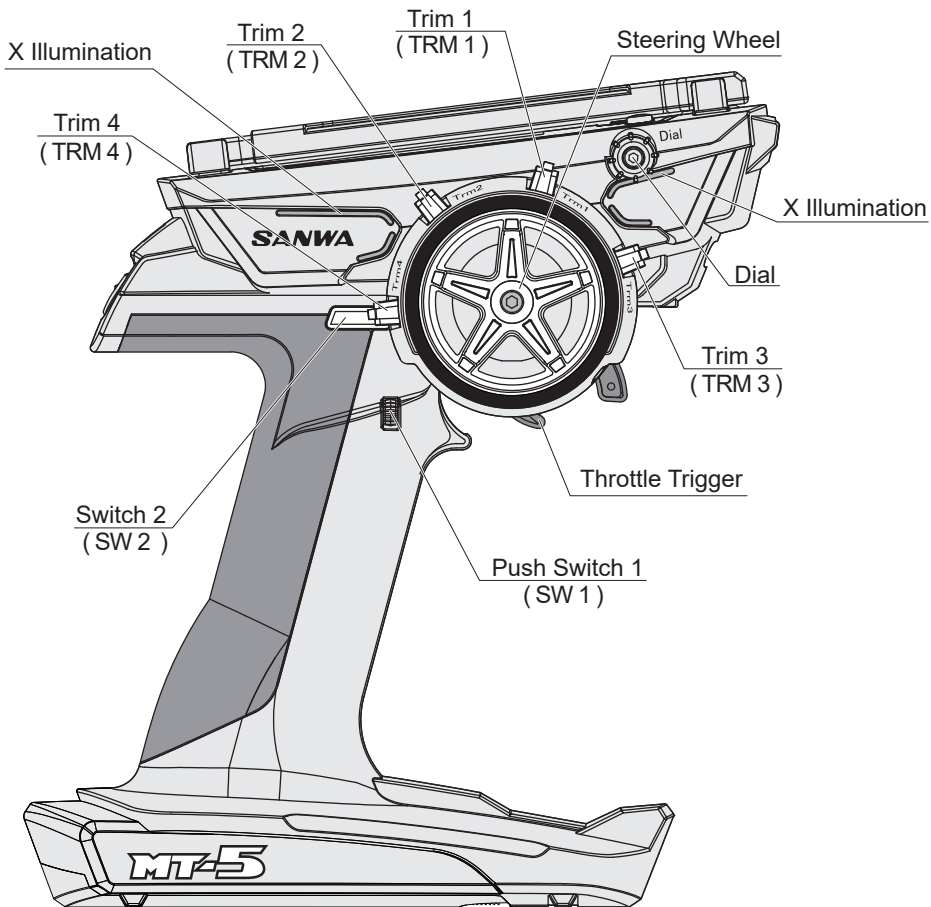
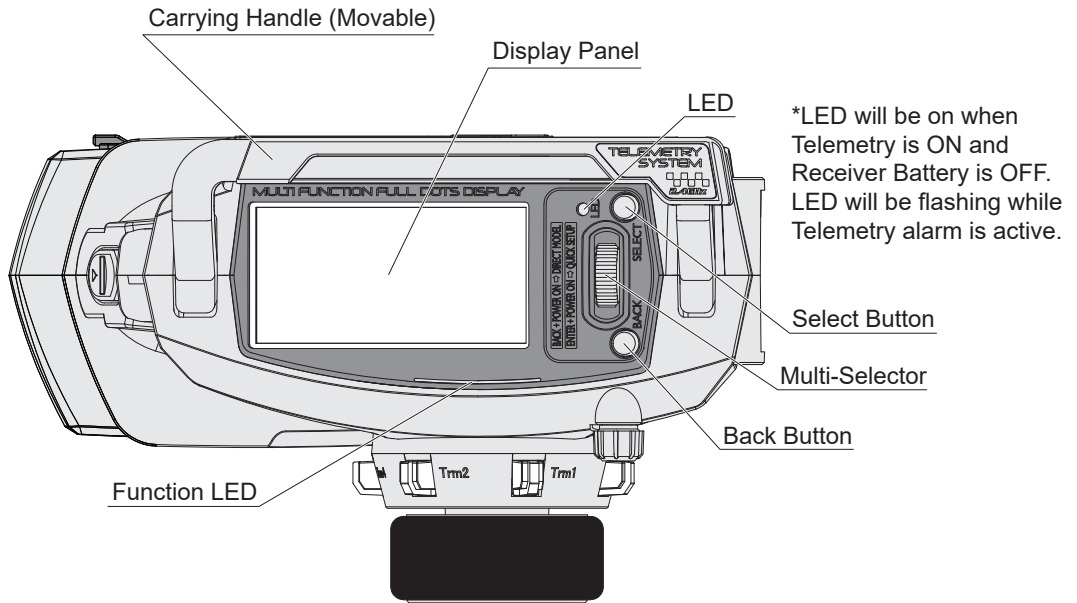

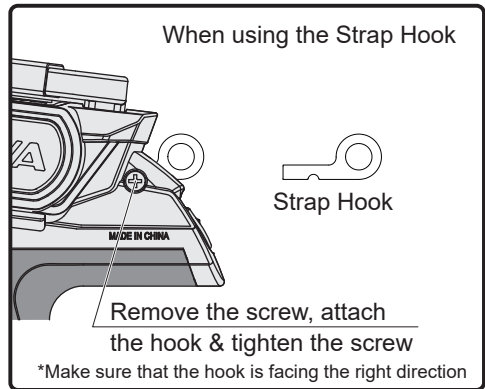
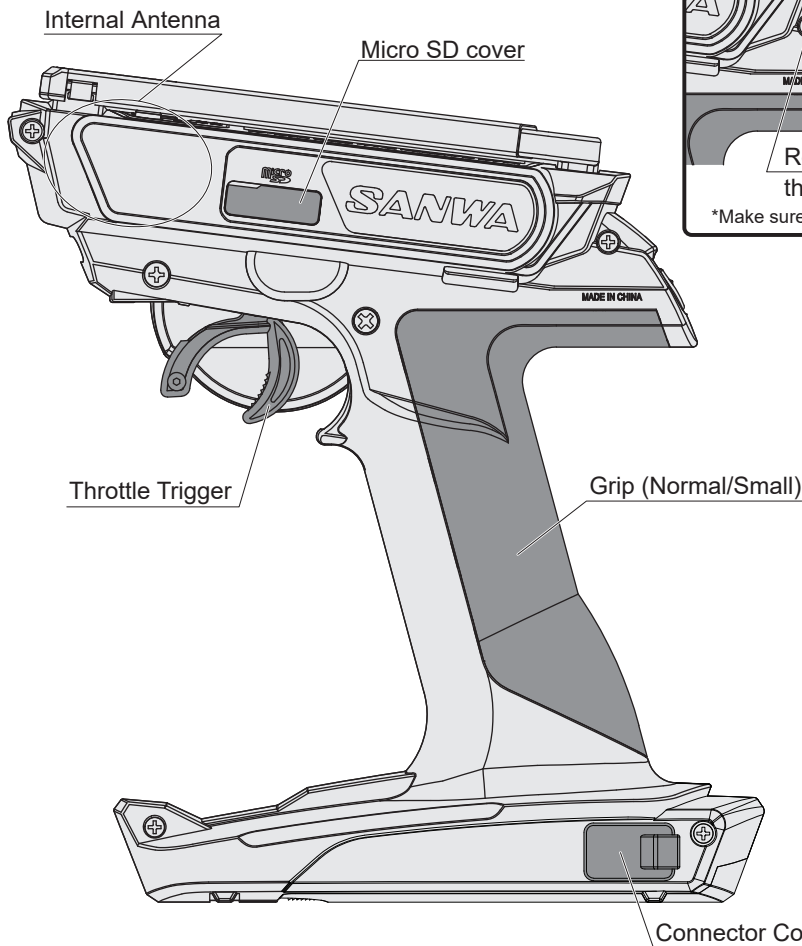
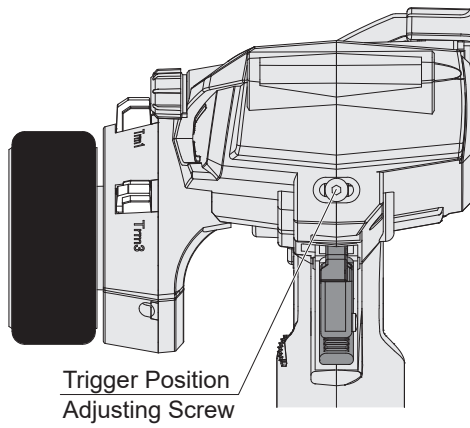
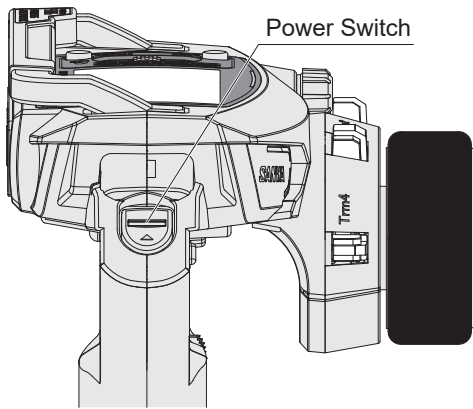

Indicator Function (RX-DATA)

- MT-5 can check signal receiving conditions to use with RX-493i.
The conditions can be used for devices glitch and checking receiver place on the car.

There are 2 different types of data for checking signal condition.

Received Signal Strength (RSS)

Indicate signal strength which receiver received from the transmitter.

The value will be changed by placing of receiver and antenna, RC circuit, places of operation.

Please take care the value is not decreasing when driving on circuit first time or replacing receivers.

Packet Delivery Ratio (PDR)

Indicate packet delivery ratio which receiver received from the transmitter.

Values might be decreased when a lot of driver drive as the same time or using another 2.4 GHz devices at the same time.

In case of too low RSS values, PDR values are also decreased.

How to set and check data

- 1) Received Signal Strength (RSS) Setting
Select TELEMETRY SETTING in Telemetry menu by multi-selector, then press enter.
Change RX-DATA at DATA-TYPE (in TLM1)
- 2) Received Signal Strength (RSS) Setting
Select TELEMETRY SETTING in Telemetry menu by multi-selector, then press enter.
Change RX-DATA at DATA-TYPE (in TLM2)

After complete setting, go to the Telemetry display and can see RSS and PDR in the display.

Telemetry Display

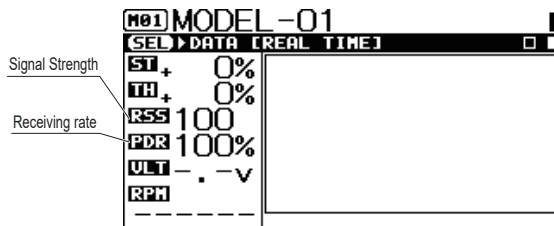

About reference values

In case RSS is below 20, please check receiver where and how placed on the car.

Please change the receiver place to increase RSS values.

*Please refer on p.1 and p.9 for receiver replacing.

In case PDR is below 40, please turn off and restart the transmitter. Then, please check PDR values again.

*About telemetry data

In case telemetry data displays "---", transmitter does not receive telemetry data from receiver.

This does not indicate about receiver does not works and receiver does not receive transmitter signal.

Due to telemetry data signal from receiver is not stronger than transmitter signal, transmitter may not get telemetry data from receiver due to distance which signal from receiver cannot reach.

Telemetry data on transmitter may display as "---" in this case.

In case of showing "---" on the transmitter, please check to see car movement by transmitter operation.

When this happens...

Symptom	Cause	Measure
There is no power.	Batteries are consumed. Batteries are placed improperly.	Replace with new batteries or recharged batteries. Reinstall the batteries as the polarity is indicated.
Power is cut off occasionally.	Bad connection of connectors.	Bring to Sanwa Service
Insufficient length	Batteries are consumed.	Replace with new batteries or recharged batteries. If the problem cannot be solved, please contact Sanwa Service
Alarm will not stop.	Battery voltage of the transmitter is decreasing.	Replace with new batteries or recharged batteries.
There is no click sound when pressing the key.	Volume of the BUZZER feature is OFF (0).	Check BUZZER feature (P.56).
The servo speed is slow.	SPEED feature is set to minus.	Check SPEED feature (P.20).
	Battery voltage of the receiver is decreasing.	Replace with new batteries or recharged batteries.
	Linkage of the car body side is heavy.	Check if the Linkage of the car body side moves lightly.
Rudder angles of left and right are different even when they are aligned.	Trim neutral is not aligned.	Align Trim and reset EPA. (P.29, 30)
When operating, the servos will not work on both ends	Rudder angle settings of D/R and EPA are too large.	Set either value to below 100%. (P. 19, 27, 28)
The servo will not move when operating Trim.	One side of the Trim movement range is full.	Reset the servo horn and the Trim center. (P. 29. 30)
Not working even if turning on transmitter and receiver.	Bind is not completed. Different Model-Data and Safety Link No.	Please check Model-Data and Safety Link No. on transmitter. Please bind with receiver.

Service and Support

This is warranted against manufacturer defects in materials and workmanship, at the original date of purchase. This warranty does not cover components worn by use or damage caused by improper voltage, tempering, modification, misuse, abuse, improper wiring, reverse polarity, moisture or using outside its intended scope of use.

Terms of this warranty can vary by region. Please read the warranty card included with your radio control system for specific warranty information.

If you have any questions or concerns, we're here to help. If you encounter a problem with your radio control system, first check the Troubleshooting Guide on Page 64.

If you require further help that cannot be solved using The Troubleshooting Guide, or if you have technical questions, please contact SANWA service center in your region.

For a complete list of distributors in your region, please visit www.sanwa-denshi.com/rc/distributors.html.

For Service In North America:

Serpent America

5121 NW 79 Ave. Unit 03,
Doral, Florida 33166 USA

Telephone: (305)-677-3253

Fax: (305)-675-0415

Email: info@serpentamerica.com

Factory Service:

Sanwa Electronic Instrument CO., LTD.

1-2-50 Yoshita-Honmachi
Higashiosaka, Osaka, 578-0982 Japan

Telephone: 81-729-62-1277

Fax: 81-729-64-2831

Email: rcintl@sanwa-denshi.co.jp

Product features and specifications can vary by region. Not all products are legal for use in all regions.



Please note that products purchased outside of North America cannot be serviced under warranty by Serpent America. In some cases, we can make repairs for products purchased outside of North America, however, applicable repair costs and shipping charges will be applicable. For warranty claims outside North America, please contact the service center in your region.

Before Using

ADJUSTING THE STEERING AND THROTTLE TENSION

MT-5 can adjust the tension of the steering/throttle trigger to match operation of the steering/throttle to the user's preference.

Adjusting the Steering Tension

By inserting a hex wrench driver (1.5mm) to the place where the arrow is pointing at in the illustration on the right and turning, you can adjust the tension of the steering spring.

*The spring tension is the softest at the time when the product is shipped out from the factory. As you tighten with a hexagon wrench driver (1.5mm), the spring tension will be hardened.

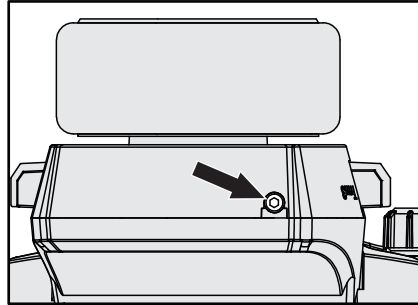

Adjusting the Throttle Trigger Tension

By inserting a hex wrench driver (1.5mm) to the place where the arrow is pointing at in the illustration on the right and turning, you can adjust the tension of the throttle spring.

*Please do CALIBRATION for steering and throttle when changing the tension. (p.59)

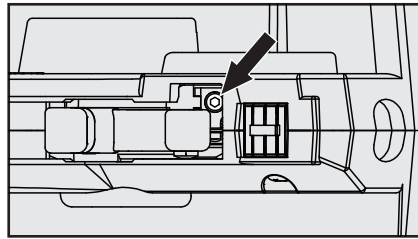

ADJUSTING THE GRIP PAD

MT-5 can change a grip pad from two types of normal/small to suit the size of the user's hand.

(The normal size is installed at the factory.) Do not pull forcefully because it's locked to the grip of the transmitter with tabs of the grip pad (at 11 locations).

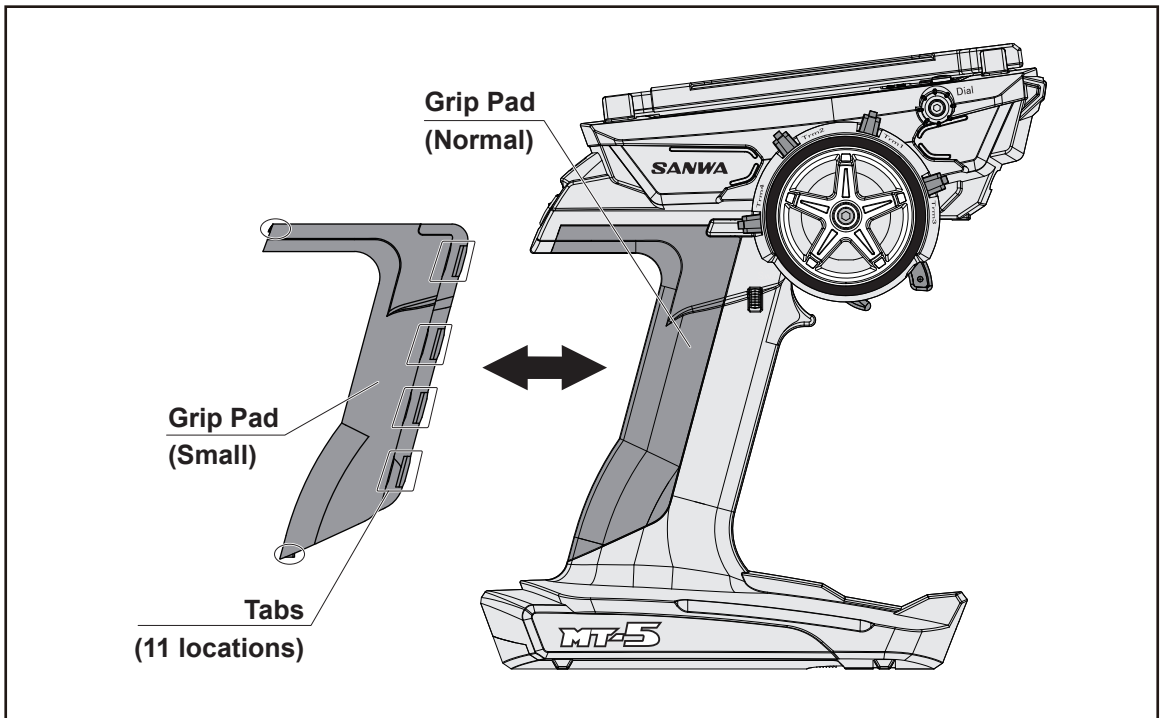

Before Using

ADJUSTING THE FULL ADJUSTABLE TRIGGER

Adjusting the trigger position

Loosen the fixing screws of the trigger on the back of the transmitter. Then, adjust the adjusting screw of the trigger position on the back of the transmitter to set the trigger at the position of your preference. When you turn the adjusting screw of the trigger position clockwise, the trigger position gauge moves to the direction A. By turning it counter clockwise, the trigger position gauge moves to the direction B.

*The range of the trigger movement is 5mm. If you turn the screw forcefully beyond the range, it can cause malfunction. Once you set the trigger position, tighten the fixing screw and adjusting the trigger is done.

*Be careful with the direction of turning the screw because the trigger position is set at the furthest point of the A side at the factory.

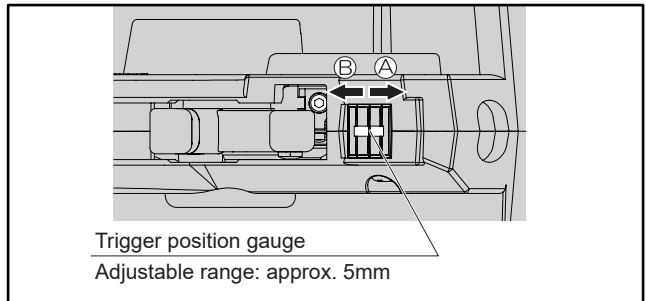
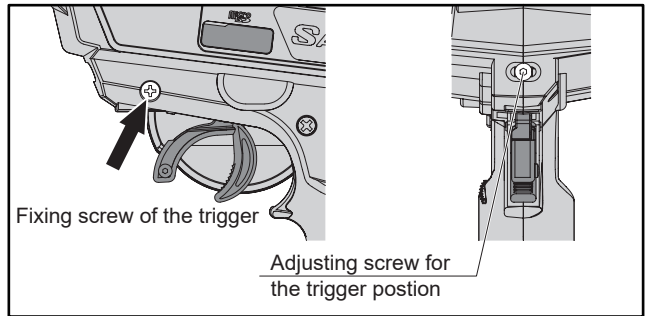

Adjusting the trigger angle

By switching the angle spacer A/B/C, it is possible to adjust the angle of the throttle trigger to five steps.

- 1) Remove the fixing screw of the trigger on the back of the transmitter.
- 2) Adjust the angle by changing the direction of the angle spacer to have an angle easy to operate.
- 3) Once the trigger angle is set, fix the fixing screw of the trigger on the back of the transmitter.

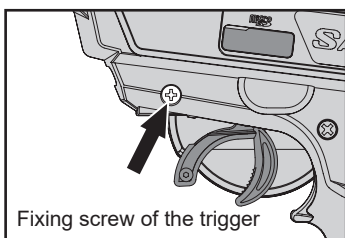
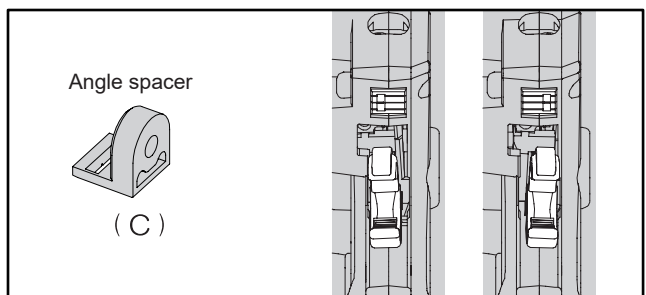
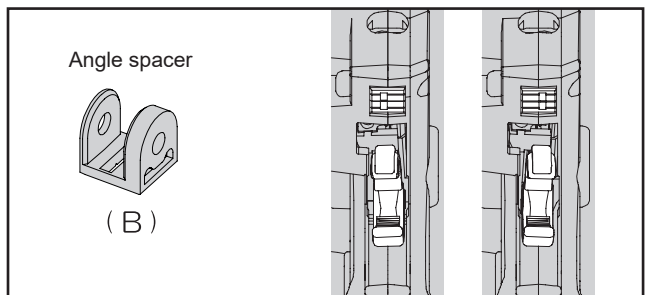
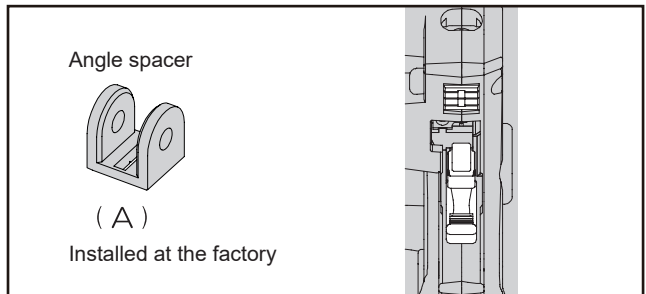

Adjusting the brake trigger

You can adjust brake trigger position according to your fingers by replacing the included brake trigger. Standard Size, +1 Size, +2 Size is included.

- 1) Remove the brake trigger fixing screw.
- 2) Select Brake Trigger according to your fingers.
- 3) Fix the brake trigger by the screw.

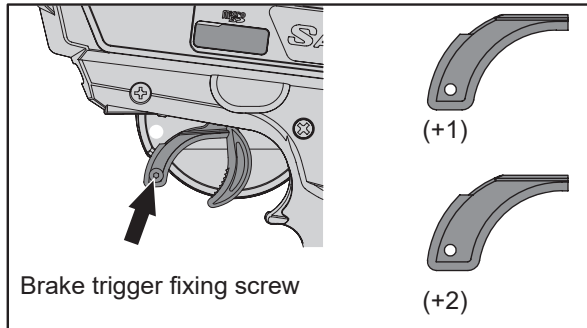

ABOUT THE POWER SOURCE

HOW TO PLACE THE TRANSMITTER BATTERIES

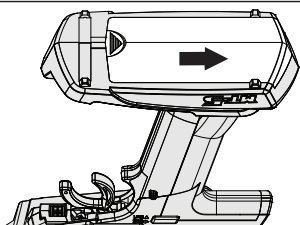

<1>Open the battery compartment cover by sliding the cover to the direction of the arrow while pressing it lightly.

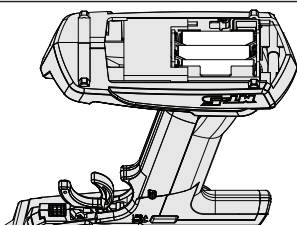

<2>Place 3 size AAA batteries. Make sure to observe correct polarities.

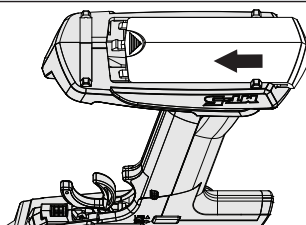

<3>Align the convex part of the battery compartment cover and the groove of the battery compartment, slide the cover to the direction of the arrow and close tightly.

ABOUT THE OPTIONAL BATTERY

- When using an optional battery, you can access to the charging port on the side of the battery from the connector cover.

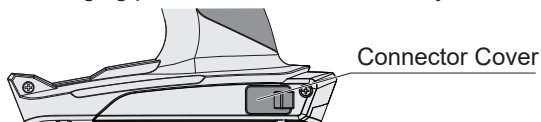

ABOUT MICRO SD CARD

- MT-5 is compatible to Micro SD Cards. By using a Micro SD Card, it is possible to save model data and telemetry data. Also, it is possible to do firmware update using a Micro SD Card when a firmware update of MT-5 is released. Please take care of direction. Metal terminal should be bottom.
 - After inserting micro SD card into MT-5, the file named "MT-5" is made and the folder named "MODEL" is made. The model data is saved in the folder. If the log data is exported, the folder named "Log" is made and the data named "csv" is saved in the folder.
- *Compatible Micro SD card capacity is maximum 32GB. Other manufacture Micro SD card might not be able to use. Please use Micro SD card by SANWA.

When micro SD card is inserted, this mark will be on.

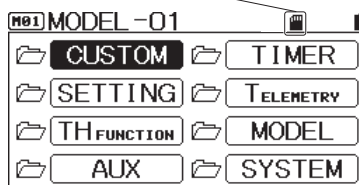
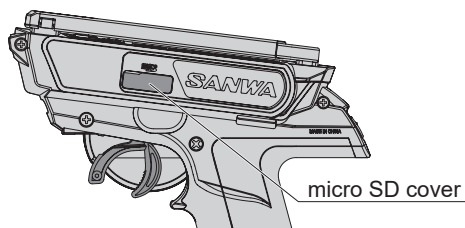

Connections and Installation of Receiver

ABOUT THE RECEIVER

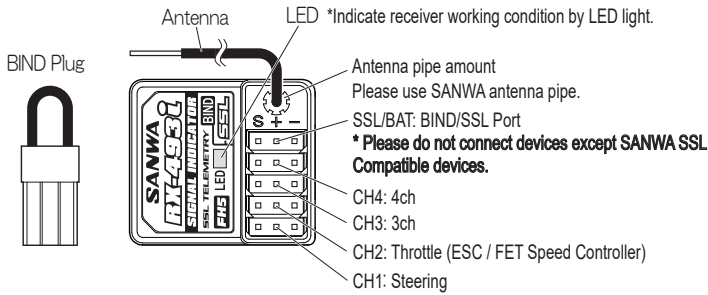

Indication of Receiver Working Condition by LED light

Connected	Blue light On *When binding with 2 transmitter, blue light flush at 2 sec intervals.
NOT Connected	—
In BIND Setting	Blue light flushing Blue light blinking
Battery Fail Safe Working	Blue and red light on
Receiver is not connected in Battery Fail Safe working	Red light on

● RX-493i

RX-493i can evaluate received signal strength and packet delivery ratio from transmitter.

RX-493i can store 2 transmitter ID Number. It is able to combine using individual transmitter which is different setting in endurance race .

If you bind with 2 different transmitter, the receiver store the different transmitter and can operate by transmitters without re-bind.

*CANNOT operate by the 2 different transmitter at the same time. 2 ID store system is only compatible with M17 or MT-5.

Throttle neutral position or operation quantities might be different each transmitter. Please adjust each transmitter setting to fit chassis linkage.

When setting SSL compatible devices by MT-5 CODE AUX function, please connect SSL compatible device to SSL port.

MUST set fail-safe setting on each transmitter.

Please set same RF mode and response mode as 1st transmitter when you bind 2nd transmitter. If it was different mode, cannot bind with 2 transmitters.

*If 2nd transmitter was different RF mode and response mode from 1st transmitter, 1st transmitter ID No. is deleted and only write 2nd transmitter.

*If you bound 3rd transmitter, 1st transmitter ID No. will be deleted.

*When using first time, please bind with receiver. (p.49)

ABOUT HANDLING THE ANTENNA

- Reception distance may vary depending on the location where the receiver and the antenna are installed.
- To protect the reception part (3 cm from the top) of the antenna, make sure to place the antenna in the antenna pipe as shown in the right illustration so that the top of the antenna is not exposed outside of the antenna pipe.
- Don't bend the antenna reception part or the antenna coaxial cable because breaking can occur inside.
- Don't pull the coaxial cable forcefully. It may damage the receiver interior.
- Install the antenna on an RC car so that the antenna reception part is in as high place as possible.
- Don't cut or bind the antenna reception part or the antenna coaxial cable since the receiver sensitivity might decrease.
- Keep the receiver antenna away from the motor and the ESC (FET Speed Controller) including cables and raise it straight.

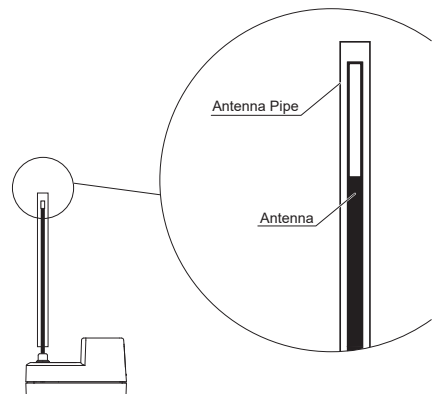

ABOUT CONNECTION SETUP

Please refer the below picture for receiver and servo connection

●Connection example in case of using in EP car

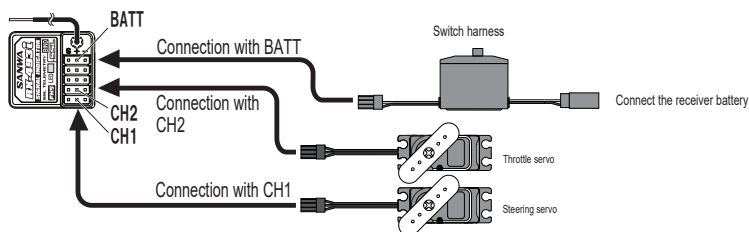
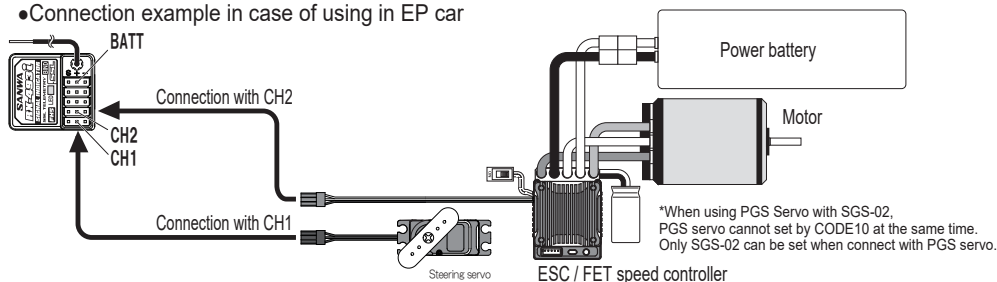

■Case of connecting PGS servo and SUPER VORTEX Gen2 / PRO / Stock / SV-D2 to SSL port

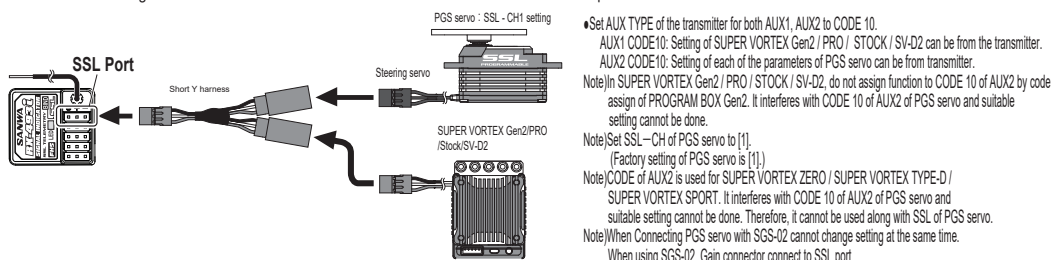

■Case of connecting PGS servo to 2 SSL ports

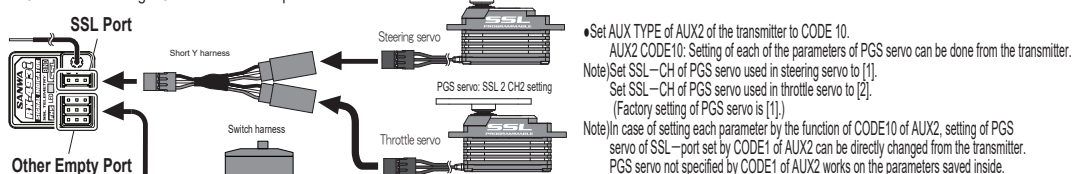

*Please, refer on our Website about any other examples. <http://www.sanwa-denshi.com>

! Note

- If the connector is disconnected due to a vibration during operation, it can cause runaway. Connect the connector of the receiver, servos and switches securely.
 - Because the receiver is susceptible to vibration, impact and water, make sure to take measures for vibration-proof and waterproof. Negligence of taking these measures can cause runaway.
 - When installing the receiver, keep the receiver away from a carbon chassis and metallic chassis.
 - If metal parts installed on an RC car touch each other, it can cause noise that affects reception performance and it can cause runaway.
 - Make sure to install a noise killer condenser on the brush motor for electric RC cars. Without a noise killer condenser, it can cause noise and runaway.
 - For R/C System parts such as the transmitter, receiver, servos, ESC (FET Speed Controller) and transmitter battery, use genuine SANWA products.
- *When combining products other than genuine SANWA products, modifying, adjusting or exchanging parts is done at a place other than SANWA, we do not take any responsibility.

Names of each part of transmitter

Names of each part of the transmitter

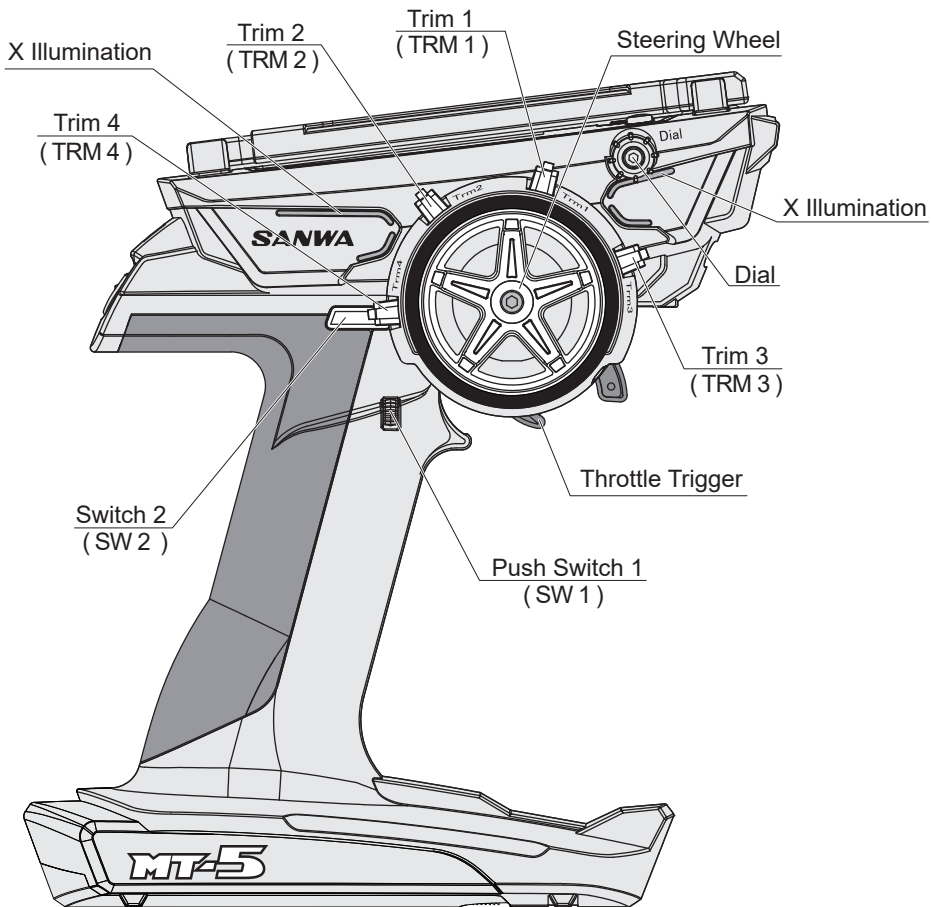
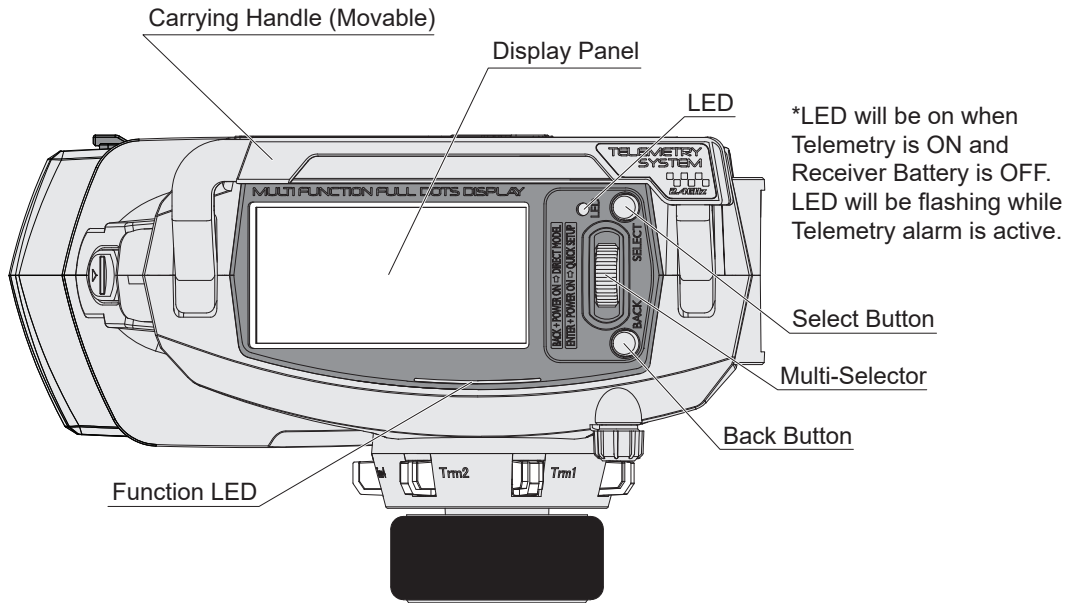

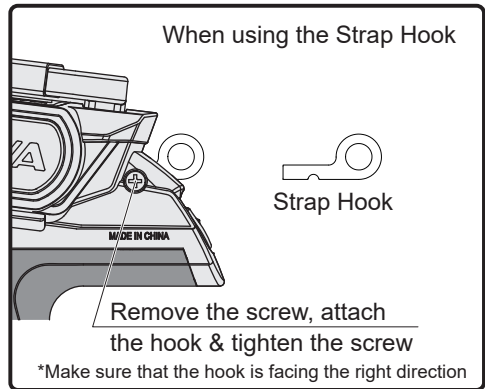
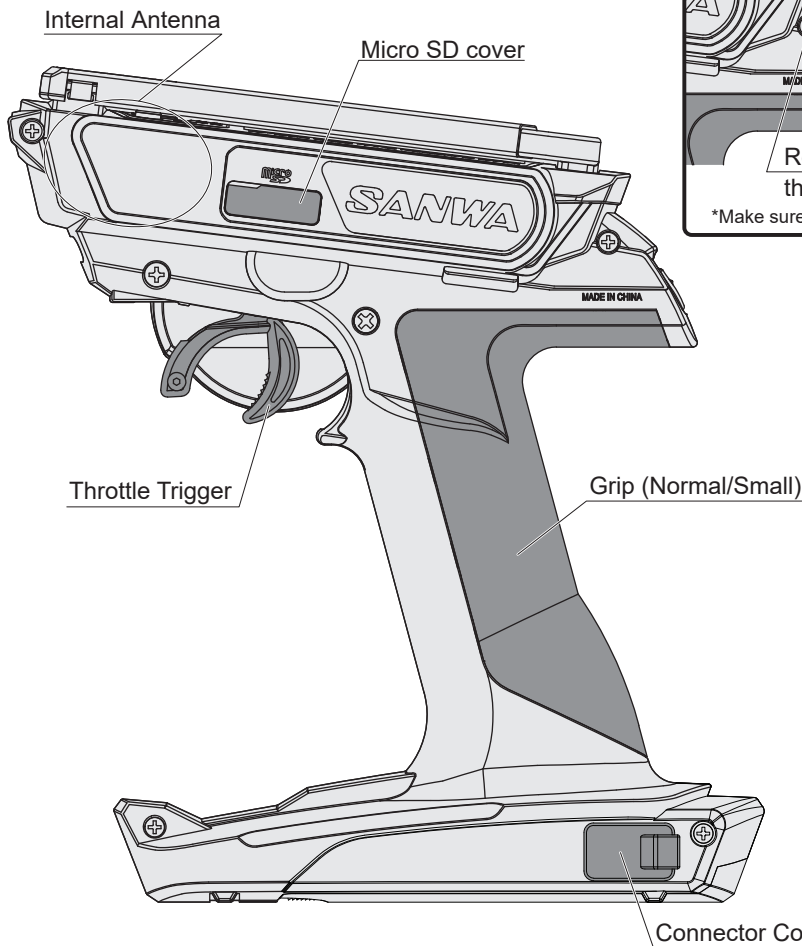
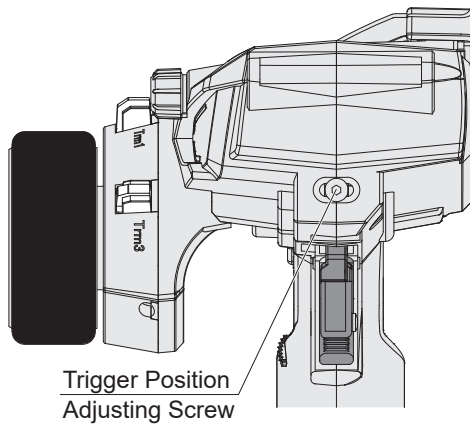
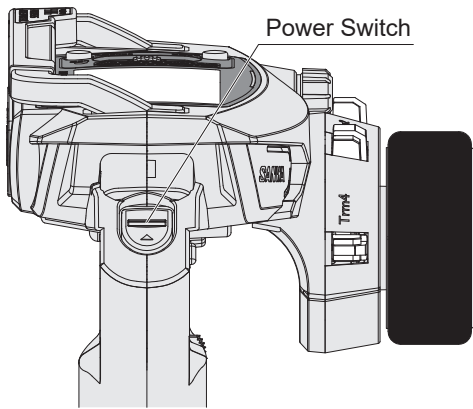

Names of each part of the transmitter

How to Use Each Feature

ABOUT KEY OPERATION

- The user can set up and make a calling easily with the Multi-Selector and Select button/Back button.

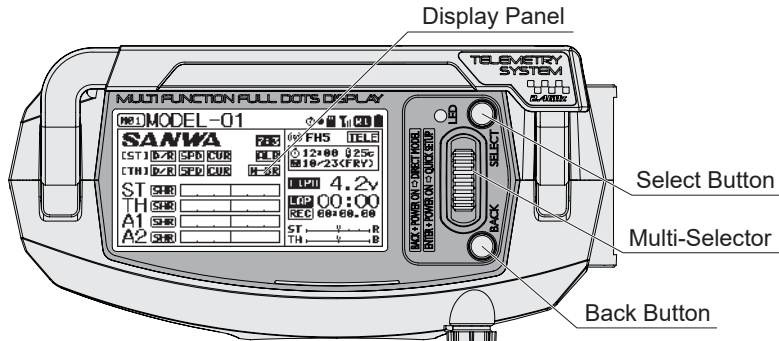

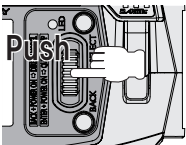
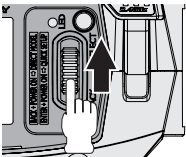
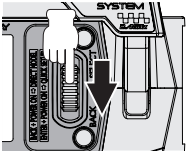
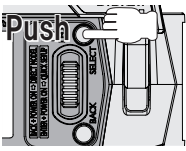
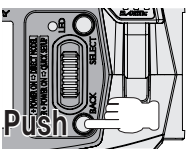
Key Operation	Names	Performance
	Enter	<ul style="list-style-type: none"> ● Moves to the setup screen from the top screen. ● Selects a feature and item to set. *By long pressing the Enter, the setting goes back to default.
	Multi-Selector UP	<ul style="list-style-type: none"> ● The cursor moves upward. ● The set value increases.
	Multi-Selector Down	<ul style="list-style-type: none"> ● Moves the cursor downward. ● The set value decreases.
	Select	<ul style="list-style-type: none"> ● Selects a channel or feature.
	Back/Cancel	<ul style="list-style-type: none"> ● Goes back to one step before. ● Cancels the setting.

ABOUT POWER ON ALARM

- MT-5 displays “No Operation” with a warning alarm after 10 minutes of no steering wheel, throttle trigger and switches. Alarm is turned off, if the steering wheel, throttle trigger or a switch is operated. In case you do not use them, turn the power switch off.

*If the transmitter was turned on for an extreme long time, the transmitter battery would be over discharged and led to damage. The battery damages would lead to battery liquid leaking, ignition, detonation, and so on.

ABOUT DISPLAY PANEL

- Each feature of MT-5 allows you to directly select a feature with the Multi-Selector.
- You can set up each channel feature separately.
- As you turn the power switch on, the top screen launches after the boost screen is displayed(when the boot setting is on). When changing each setting, select the menu by operating the Multi-Selector.

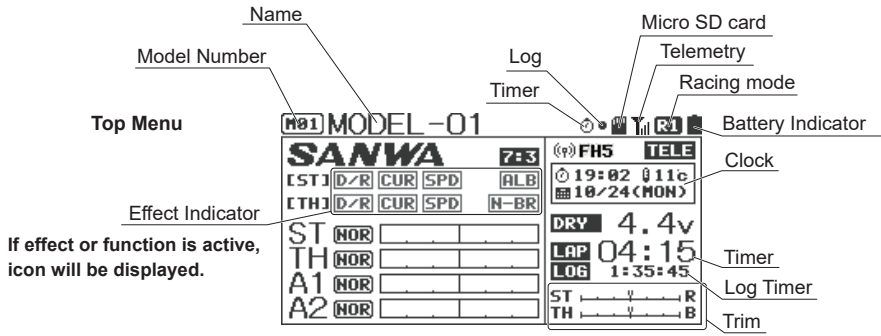

When scrolling up and down by multi selector, display switches top display to telemetry display

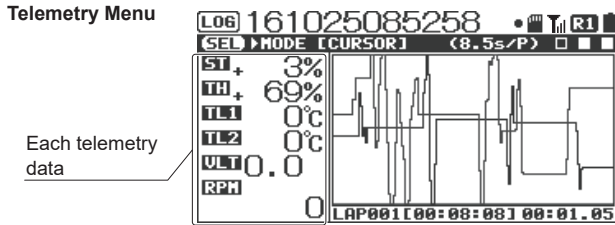

When using RX-491/492/493/493i and SUPER VORTEX Series/PGS Servo Series/SGS-02, Turn telemetry function on, then display telemetry data from receiver.

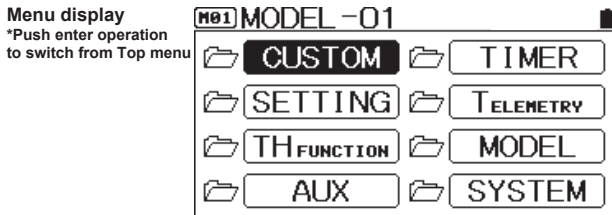

How to Use Each Feature

ABOUT THE MENU STRUCTURE

- The user can set up features and do model memory call easily by using each key.
- The Menu consists of Setting, AUX, CUSTOM, MODEL, TELEMETRY, TH-FUNCTION, TIMER and SYSTEM, and related features are included in each menu.

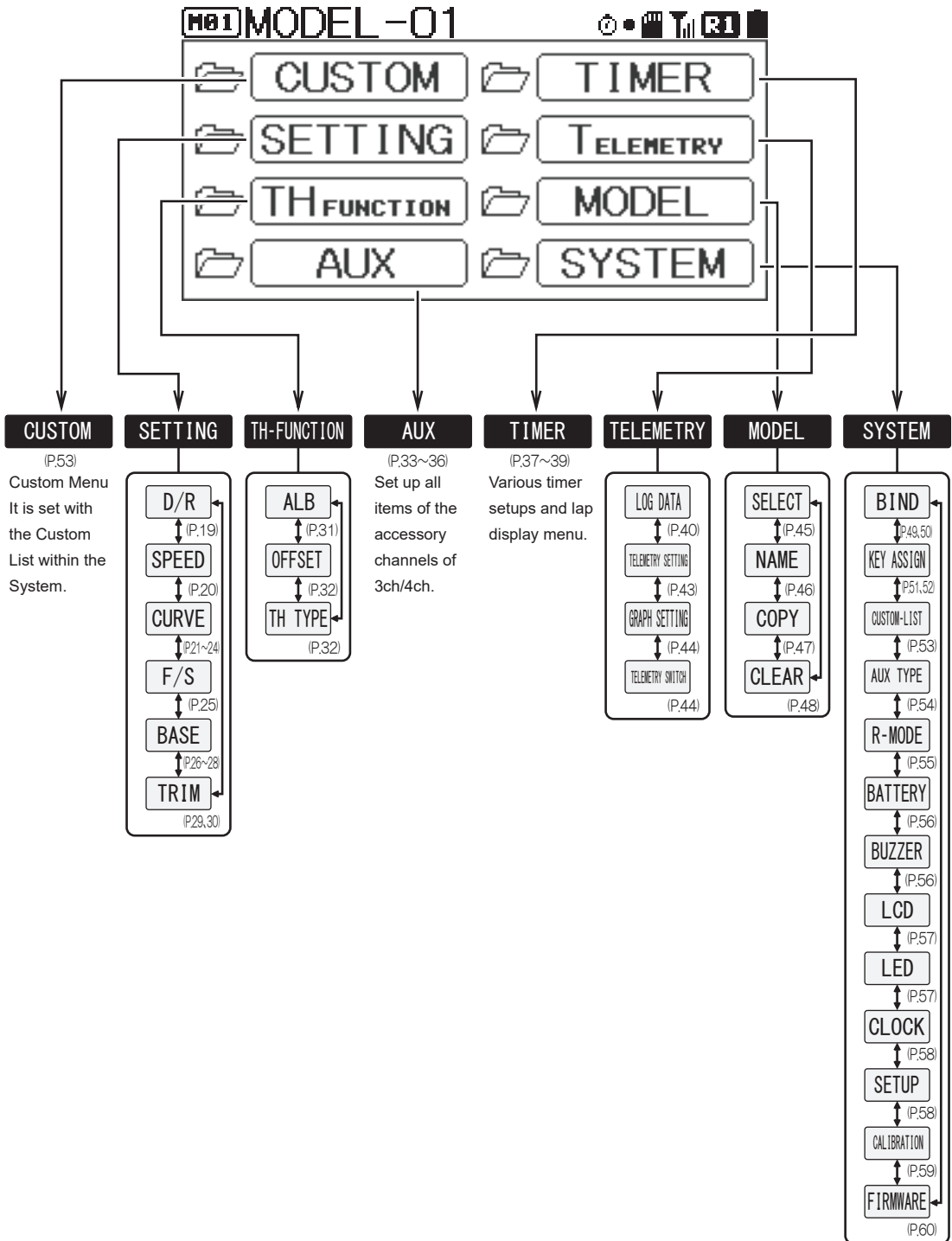

ABOUT SHORT CUT MENU

- MT-5 has a feature of Short Cut Menu that is launched as the user performs key operation when operating the power switch.
When you turn the power switch on with holding on the Back Button, it becomes the Direct Model Select. When you turn the power switch on with holding on Enter operation, the Quick Setup feature launches. Direct Model Select is a feature for quickly selecting a model to run and Quick Setup is a feature for various setup with easy operation when setting up a new RC car.
- Quick Setup feature is set in the following order using the Enter operation after launching.
Selecting Model→Selecting Type→Initializing Model→Selecting RF Modes→Selecting Response Mode→BIND→Setting Base

DIRECT MODEL SELECT <DIRECT MODEL>

- Direct Model Select
- 1) Turn on the power switch with holding the Back button.

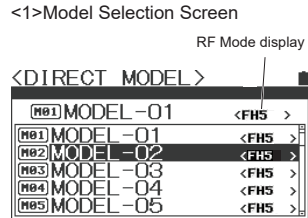
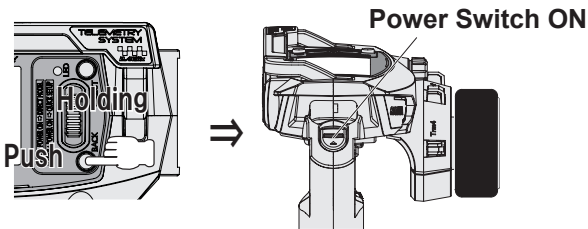

- 2) Selecting Model
Select a Model you wish to call with Multi-Selector.
○ Selection range: M01 ~ M20
- 3) Move the cursor to the Model and choose model by enter operation.
A message is displayed on the screen. Select a Model following the display.

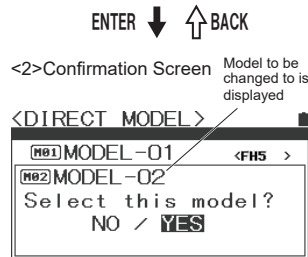

No→Back to <1>.
Yes→Change model and move to the top.

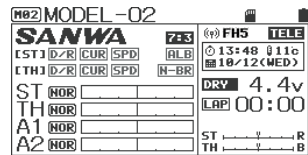

How to Use Each Feature

ABOUT SHORT CUT MENU

QUICK SETUP WIZARD

● Quick Setup

1) Turn the power switch on while doing Enter operation.

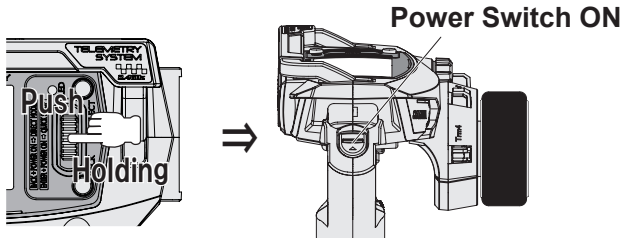

2) Quick Setup screen is displayed.

As you do Enter operation, Quick Setup Wizard is launched.

3) When the screen is changed to Model selection screen, select a Model to set up by using Multi-Selector. When a Model to set is selected, set with Enter operation.

4) When the screen is changed to Car Type selection screen, select a Car Type using Multi-Selector. When a Car Type is selected, set with Enter operation.

Setting up Type

○ Setting Range:

- EP CAR STANDARD
- EP CAR (LED UNIT)
- EP CAR (SVZ)
- EP CAR (SVD)
- EP CAR (SV-D2)
- EP CAR (SV-G2P)
- GP CAR STANDARD
- 1/5 GP CAR DUAL BR1
- 1/5 GP CAR DUAL BR2
- CRAWLER 4WS/MOA

○ Default:

EP CAR STANDARD

*Channel operation of each type will be as follows.

CH	TYPE	EP CAR STANDARD	EP CAR (LED UNIT)	EP CAR (SVZ)	EP CAR (SVD)	EP CAR (SV-D2)	EP CAR (SV-G2P)	GP CAR STANDARD	1/5 GP DUAL BR1	1/5 GP DUAL BR2	CRAWLER 4WS/MOA
CH1	STEERING	STEERING	STEERING	STEERING	STEERING	STEERING	STEERING	STEERING	STEERING 1	STEERING	STEERING F
CH2	ESC	ESC	ESC	ESC	ESC	ESC	ESC	THROTTLE /BRAKE	THROTTLE /BRAKE R	THROTTLE	ESC F
CH3	AUX1	LED-ST	CODE5	CODE5	CODE10	CODE10	CODE10	AUX1	STEERING 2	BRAKE R	STEERING R
CH4	AUX2	LED-TH	CODE5	CODE5	CODE10	CODE10	CODE10	CODE10	BRAKE F	BRAKE F	ESC R

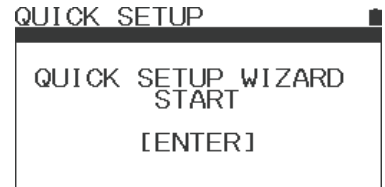

ENTER ↓ ↑ BACK

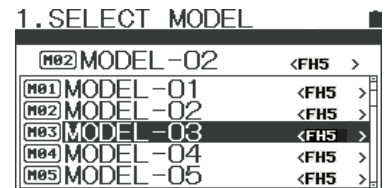

ENTER ↓ ↑ BACK

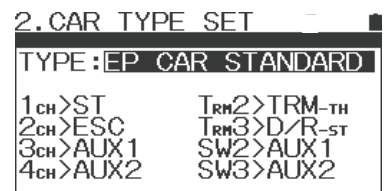

ENTER ↓ ↑ BACK

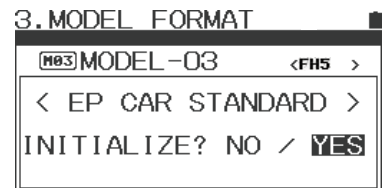

ENTER ↓ ↑ BACK

*Select a type to be used according to an R/C.

- 5) When deciding the car type using Enter, the screen changes to Initialization (Model Initialization) screen. Do initialization following the message.
- 6) When initializing (Initializing Model) is completed, the screen changes to RF Mode Selection Screen.
MT-5 is only compatible FH5 RF mode.
 - Default: FH5
 - Compatible Receivers: FH5
RX-491, RX-492, RX-493, RX-493i
- 7) Once RF Mode for the receiver is determined, the screen changes to the Response Mode screen. Set Response Mode according to the servos and the equipment to be used. Set with Up key/Down key and finalize with the Enter key.
 - Setting Range: NOR (Normal / Analog Servo)
 - SHR (High Response / Digital Servo)
 - SSR (Super Response / SRG Servo)
 - SUR (Ultra Response / PGS Servo)
 - Default: NOR (Normal / Analog Servo)
 - *In case of unknowing the device compatible response mode, please set NOR.
 - *If using connected devices with wrong response mode, the devices might be glitch or broken.
- 8) When Response Mode setting is completed, the screen changes to BIND Set up Screen. Follow the screen message and start Binding.
- 9) When Binding (BIND) is done, the screen changes to the Base Set Up screen. Complete setting for each channel (refer to P. 26-28).
- 10) When Base setting is done, Set Up Wizard will end. If you press the Enter button, the screen changes to the Top screen.

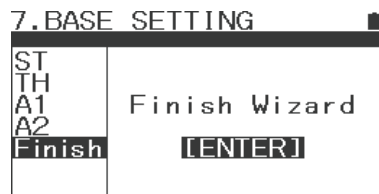
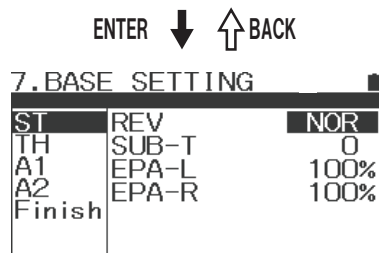
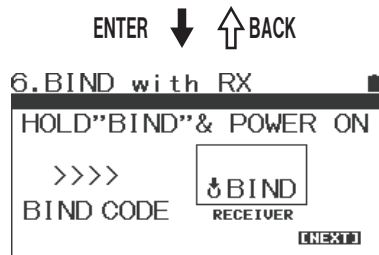
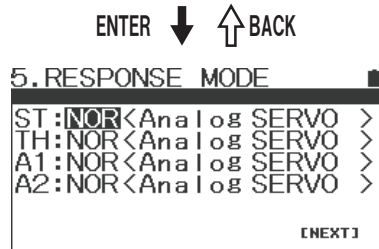
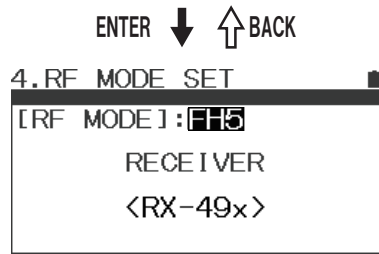

IMPORTANT

- Please note that the analog servos do not work in SHR/SSR/SUR modes. If you mistakenly use the analog servos in SHR/SSR/SUR modes, it does not work normally and the servos will be broken. Never use analog servos in SHR/SSR/SUR modes. For digital servos (SRG, ERB, ERS Series and Digital ERG Series), either NOR or SHR mode works.
- SSR mode works only for PGS, SRG Servos, SUPER VORTEX/SV-PLUS series, HV-12, STOCK SPECIAL and HV-01.
- SUR mode works only for PGS servo, SUPER VORTEX Gen2 / PRO / SV-D2.
- With SHR/SSR/SUR mode, BL-RACER, BL-FORCE, F2000, F2200, F3000 F3300, SBL-01 02 and 03CL do not work. Make sure to use them in NOR mode.
- BL-SIGMA, SV-08, HV-10, HV-12 and F2500 work in NOR/SHR modes.
- Please read user manual of using speed controller.

How to Use Each Feature

DUAL RATE [D/R]

SETTING

- You can adjust rudder angle when operating the steering wheel and throttle trigger to their peak. To correspond to the RC car or road condition, adjust the rudder angle as you operate.
*You can adjust steering for both right and left at the same time and throttle separately for high and brake sides. You can also adjust the brake side more precisely than adjusting with EPA.
- Don't increase the setting rate of dual rates (D/R) from the condition in which the linkage locks by operating the steering wheel and throttle trigger.
- You can also adjust more precisely by adjusting dual rates of the throttle side.
*When AUX1/AUX2 are set to CODE5/CODE10, setting change of D/R will not be reflected to the performance.

- 1) Select [SETTING] with multi-selector and enter.
- 2) Select features [ST/TH (H, L)/AUX1/AUX2] to adjust with the Select key.
- 3) Determine the feature to adjust with the Enter key. Adjust the value of DUAL RATE by multi-selector.
- 4) During operation, the steering dual rates can be adjusted with Trim 3, brake dual rates can be adjusted with Trim 4. It's possible to assign other features to Trim 3 and Trim 4 with the key assign trim feature (P. 52).

*When cancelling a selected feature, operate the Back button.

- Setting Range:
ST/TH-H/AUX1/AUX2: 0%~100%
TH-L: 0%~120%
- Default:
ST/TH/AUX1/AUX2: 100%

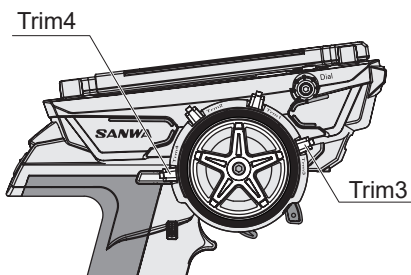

*Make sure that the servos do not lock to make clicking sound!
Note) The same for throttle.

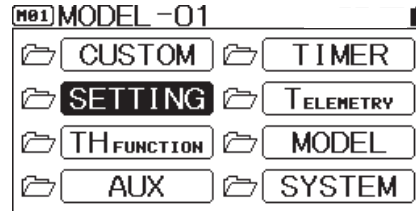
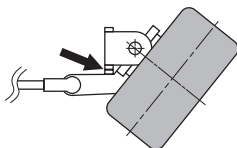

ENTER ↓ ↑ BACK

Dual Rates Selection Screen

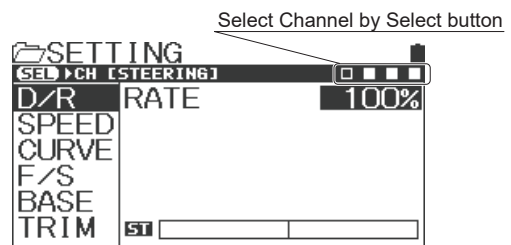

ENTER ↓ ↑ BACK

Steering Dual Rates Selection Screen

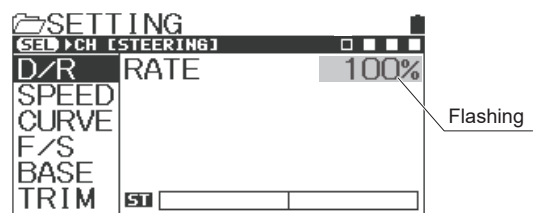

Note

• If the linkage is locked for a long period, it can cause the servo motor breakage.

SUPPLEMENT

- Adjust the end point of the steering/throttle linkage before adjusting dual rates (P. 27, 28).

SPEED

SETTING

- Features to control the speed of the servos used for steering and throttle. By setting, the RC car is not affected even when doing a sudden operation. On the steering side, smooth corner work becomes possible and on the throttle side, stable rising from a corner by throttle work with saved power.
*When setting AUX TYPE to [CODE5/CODE10], adjusting the speed feature of the AUX channel does not affect the performance.
*When setting the speed of the AUX channel, do so using steering/throttle as a reference.

[ST] STEERING SPEED

- A feature to delay the speed of the steering servos against the steering operation. You can set speed for steering forward and returning individually. For steering operation slower than setting, the speed feature does not work.

- 1) [ST (Steering)] with Select key.
- 2) Setting on the forward side [FORWARD]
Select [FORWARD] with the Enter key and adjust the setting value by multi-selector.

*When cancelling a selected feature, use the Back key.

- Setting Range: 0~100
- Default: 0

- 3) Setting on the Return side [RETURN]
Select [RETURN] with the Enter key and adjust the setting value with by multi-selector.

- Setting Range: 0~100
- Default: 0

*Adjust during actual operation. When not using the features or when a setting value cannot be determined even after adjustment, set the value to 0% (linear).

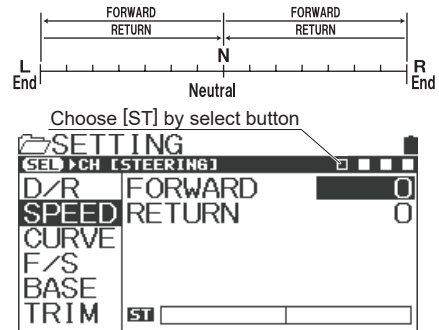

SUPPLEMENT

- For driving an RC car, steering operation that suits the movement of the RC car is important and excessive operation is not recommended. Steering speed can minimize unnecessary operation and enables smooth cornering.
- When steering speed and steering curve are combined, the effect is doubled.

[TH] THROTTLE SPEED

- A feature to slow down the performance speed of the throttle servos and delay the response of the speed controller against throttle operation. You can set speed for entering throttle (Forward) and returning (Return) individually. The speed feature does not work with throttle operation slower than the setting.

*Setting is only for High side and Brake side cannot be set.

- 1) Select [TH (Throttle)] with Select key.
- 2) Setting on the forward side [FORWARD]
Select [FORWARD] with the Enter key and adjust the setting value by multi-selector.

*When cancelling a selected feature, use the Back key.

- Setting Range: 0~100
- Default: 0

- 3) Setting on the Return side (RETURN)
Select [RETURN] with the Enter key and adjust the setting value by multi-selector.

- Setting Range: 0~100
- Default: 0

*Adjust during actual operation. When not using the features or when a setting value cannot be determined even after adjustment, set the value to 0% (linear).

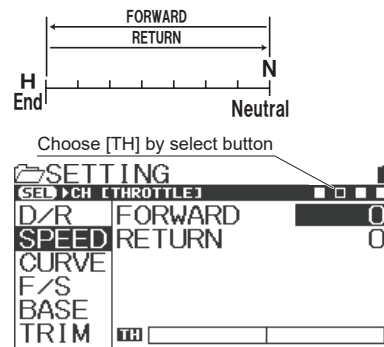

SUPPLEMENT

- For driving an RC car, throttle operation that suits the movement of the RC car is important and excessive operation is not recommended. Throttle speed can minimize unnecessary operation and enables smooth performance.
- When throttle speed and throttle curve are combined, the effect is doubled.

How to Use Each Feature

CURVE

SETTING

- Function of making operation volume of servo variable with respect to the operation of the steering wheel, throttle trigger, AUX. It responds quickly when the set value is on plus (+) side whereas it responds mildly when the set value is on minus (-) side.
- Exponential (EXP) of curve operation and adjustable rate controller (ARC) of linear position can be selected.
 - *If the AUX type is set to [CODE], adjustment of the curve feature of the AUX channel does not affect the performance.
 - * In case of adjustment of curve setting of the AUX channel, use the steering/ throttle as a reference.

Exponential (EXP)

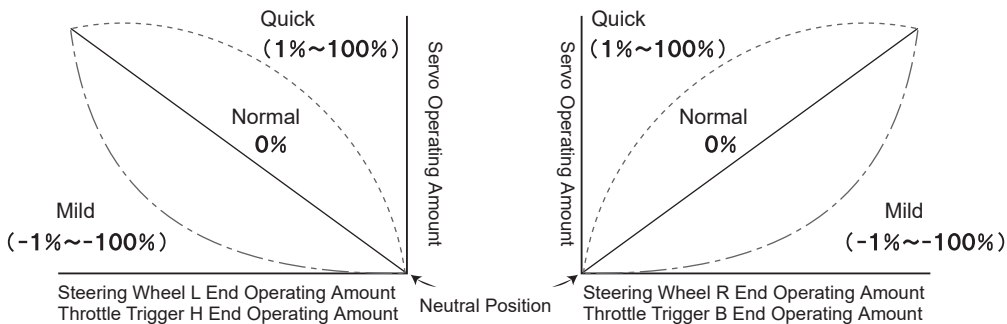

Adjustable rate controller (ARC)

Position at which operation is variable can be changed by adjusting the setting of POINT.

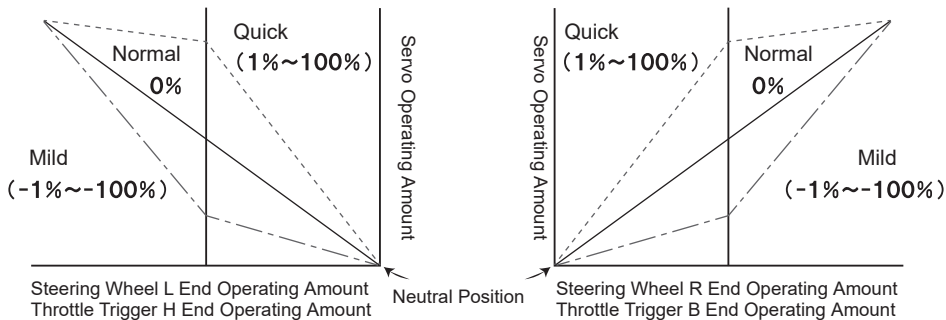

[ST]

STEERING EXPONENTIAL

- Steering characteristics can vary from Mild to Linear and to Quick. Generally, when the RC car senses the over-steer, the setting value is set to minus side, and when the RC car senses the under-steer, the numerical value is set to plus.

Steering exponential will do the L/R concurrent setting.

- 1) Select ST with the Select button and set CURVE TYPE of ST to [EXP] with the multi-selector.
- 2) Adjust the setting value with the multi-selector.

- Setting Range: -100~100%
- Default: 0%

*When cancelling a selected feature, use the Back button.

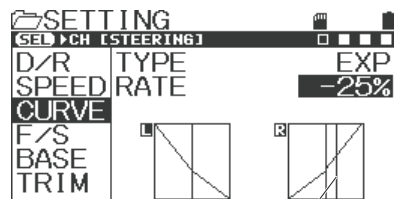

Steering Operation Position

[TH]

THROTTLE EXPONENTIAL

- You can change the throttle feature from Mild to Linear and to Quick.
In general, when operating on a slippery road or if you find over powering, change the setting to the minus side and when operating on a high-grip road or if you find lack of power in the power unit, change to the plus side. You can set the High side and the brake side separately.

*Selection of the High side and the brake side is done by trigger operation.

- 1) Select TH with the Select button and set CURVE TYPE of TH to [EXP] with the multi-selector.
- 2) Adjust the setting value with the multi-selector.
 - Setting Range: -100~100%
 - Default: 0%

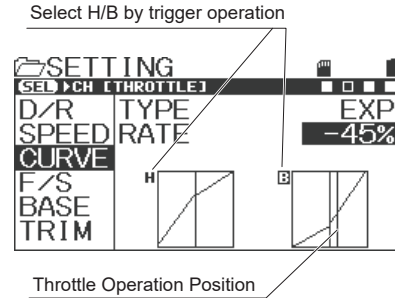

[AUX1]

AUX1 • EXPONENTIAL

- You can change the operation feature of AUX1 from Mild to Linear to Quick.
You can set the High end and the Low end separately.
*When setting AUX1 to [CODE5/CODE10] in AUX TYPE, changing the setting does not affect the performance.

- 1) Select TH with the Select button and set CURVE TYPE of TH to [EXP] with the multi-selector.
- 2) Adjust the setting value with the multi-selector.
 - Setting Range: -100~100%
 - Default: 0%

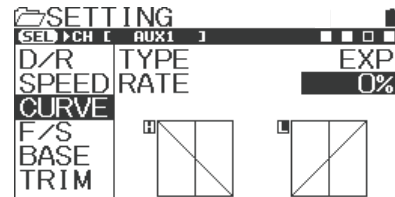

[AUX2]

AUX2 • EXPONENTIAL

- You can change the operation feature of AUX2 from Mild to Linear and to Quick.
You can set the High end and the Low end separately.
*When setting AUX2 to [CODE5/CODE10] in AUX TYPE, changing the setting does not affect the performance.

- 1) Select AUX2 with the Select button and set CURVE TYPE of AUX2 to [EXP] with the multi-selector.
- 2) Adjust the setting value with the multi-selector.
 - Setting Range: -100~100%
 - Default: 0%

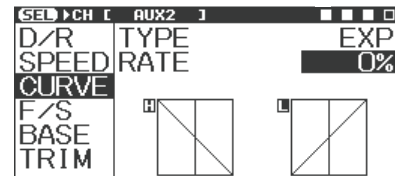

How to Use Each Feature

CURVE

SETTING

[ST] STEERING ADJUSTABLE RATE CONTROL

- You can change the steering feature from Mild to Linear and to Quick.
In general, if you find your RC car oversteering, change the setting to the minus side and if you find understeering, change to the plus side. Steering Adjustable Rate Control is a simultaneous setting for L and R.

1) Select ST with the Select button and set CURVE TYPE of ST to [ARC] with the multi-selector.

2) Setting Rate [RATE]

Select [RATE] with the multi-selector and adjust the setting value.

- Setting Range: -100~100%
- Default: 0%

3) Setting Point [POINT]

Select [POINT] with the multi-selector and adjust the setting value.

- Setting Range: 1~99%
- Default: 50%

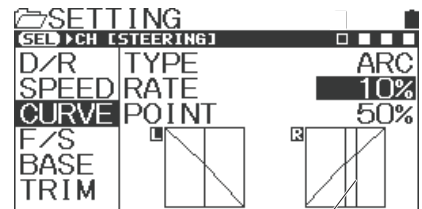

Steering Operation Position

*When cancelling a selected feature, use the Back button.

[TH] THROTTLE ADJUSTABLE RATE CONTROL

- You can change the throttle feature from Mild to Linear and to Quick.
In general, when operating on a slippery road or if you find over powering, change the setting to the minus side and when operating on a high-grip road or if you find lack of power in the power unit, change to the plus side. You can set the High side and the brake side separately.

*Selection of the High side and the brake side is done by trigger operation.

1) Select TH with the Select button and set CURVE TYPE of TH to [ARC] with the multi-selector.

2) Setting Rate [RATE]

Select [RATE] with the multi-selector and adjust the setting value.

- Setting Range: -100~100%
- Default: 0%

3) Setting Point [POINT]

Select [POINT] with the multi-selector and adjust the setting value.

- Setting Range: 1~99%
- Default: 50%

Select H/B by trigger operation

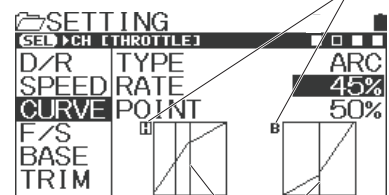

Point Steering Position

*When cancelling a selected feature, use the Back button.

[AUX1] AUX1 · ADJUSTABLE RATE CONTROL

- You can change the AUX1 performance feature from Mild to Linear and to Quick. You can set the High side and the Low side separately.

*When setting AUX1 to [CODE5/CODE10] in AUX TYPE, changing the setting does not affect the performance.

- Select AUX1 with the Select button and set CURVE TYPE of AUX1 to [ARC] with the multi-selector.

- Setting Rate [RATE]

Select [RATE] with the multi-selector and adjust the setting value.

- Setting Range: -100~100%
- Default: 0%

- Setting Point [POINT]

Select [POINT] with the multi-selector and adjust the setting value.

- Setting Range: 1~99%
- Default: 50%

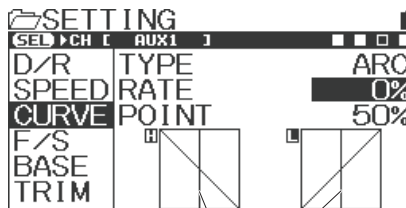

Point Setting Position

*When cancelling a selected feature, use the Back button.

[AUX2] AUX2 · ADJUSTABLE RATE CONTROL

- You can change the operation feature of AUX2 from Mild to Linear and to Quick. You can set the High side and the Low side separately.

*When setting AUX2 to [CODE5/CODE10] in AUX TYPE, changing the setting does not affect the performance.

- Select AUX2 with the Select button and set CURVE TYPE of AUX2 to [ARC] with the multi-selector.

- Setting Rate [RATE]

Select [RATE] with the multi-selector and adjust the setting value.

- Setting Range: -100~100%
- Default: 0%

- Setting Point [POINT]

Select [POINT] with the multi-selector and adjust the setting value.

- Setting Range: 1~99%
- Default: 50%

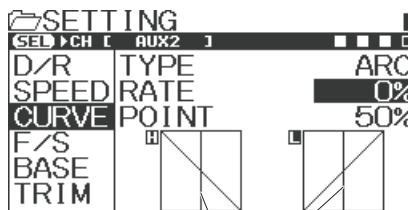

Point Setting Position

*When cancelling a selected feature, use the Back button.

How to Use Each Feature

FAIL SAFE [F/S]

SETTING

- Fail Safe Operation is a feature to keep the servos in a predetermined position for each channel in the event that the receiver cannot receive a signal from the transmitter. A feature to keep the servos in a predetermined position for the servo of the throttle channel (2ch) in the event that the battery voltage on the receiver side of an engine RC car goes below the set voltage is Battery Fail Safe Operation.
- Battery Fail Safe Operation cannot be set when the throttle channel (2ch) is set to FREE/HOLD (*Battery Fail Safe Operation works only for the throttle channel).
*Don't use Battery Fail Safe Operation feature for electric RC cars.

1) Select F/S with the multi-selector and select a channel to set fail safe operation (ST/TH/AUX1/AUX2) with the select button.

2) Enter the set channel and operate the multi-selector.
The fail safe mode setting changes in order of
FREE→FS→HOLD.

- Setting Range: FREE/FS(-100~100%)/HOLD
- Default: FREE

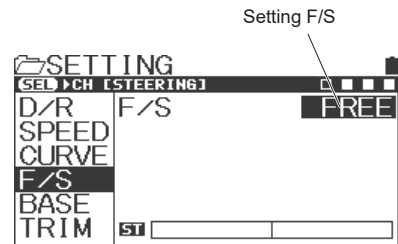

FREE (Free Mode)

When the receiver cannot receive the signal from the transmitter, the signal output to the servo stops and the servo will be free.

FS (Fail Safe Mode)

When the receiver cannot receive the signal from the transmitter, the servo will be held in the set position.

HOLD(Hold Mode)

The last position before the signal from the transmitter to the receiver is lost will be held.

- *When using with Gyro, please set HOLD. In case of FREE, the Gyro might be able to be misworking.
- *When the receiver can receive the signal from the transmitter again, each mode of FREE/HOLD/FS is automatically released.

3) Setting the Fail Safe (FS)

Move to the position where the Fail Safe Operation is used. When the position is determined, long press the Enter key to set the position when the Fail Safe Operation works.

*For safety reason, we recommend setting the throttle channel on the brake side when setting the Fail Safe.

4) Setting the Battery Fail Safe Operation

After setting the throttle channel position, move the cursor to [B-F/S] to set the voltage.

- Setting Range: OFF, 3.5v ~7.4v

*The Battery Fail Safe Operation is a feature to activate Fail Safe Operation when the receiver battery voltage belows to the set voltage on a Nitro car.

Don't use the Battery Fail Safe feature on electric RC cars.

5) Checking the Fail Safe Operation

Turn off the power of the receiver while the Fail Safe Operation is set and check if the servo moves to the position where the Fail Safe Operation is set.

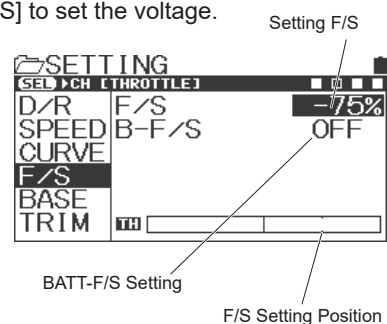

IMPORTANT

- About the Fail Safe Operation
When the Fail Safe feature is on, check the setting of the Fail Safe before operating.
Don't change the setting of the Fail Safe during operation.

BASE

SETTING

- Base [BASE] is a feature to integrate features of the Reverse that determines the direction of the servo of each channel and the speed controller according to a specific RC car, the Sub Trim that adjusts the neutral position and the End Point Adjustment [EPA] that sets the operating quantity into one feature (Base) to allow you to make a setting all at once.

REVERSE [REV]

- This is used when operation and the movement of the servo are reversed while operating Steering/throttle/AUX1/AUX2.

- 1) Select BASE with the multi-selector and select a channel to set (ST/TH/AUX1/AUX2) with the select button.
 - 2) Enter with the channel to be set and use the multi-selector. The Reverse setting will be changed.
- *When cancelling a selected feature, use the Back key.

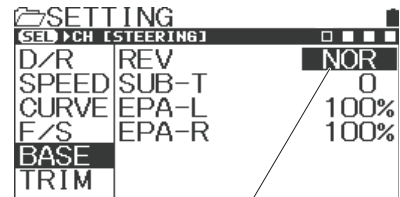

Setting REV

- Setting Range: NOR/REV
- Default: NOR

SUB TRIM [SUB-T]

- Using the Sub Trim feature, correct the neutral (center) of Steering/Throttle/AUX1/AUX2 so that Trim can be used in the center position. When installing a servo on to RC car, center the servo with Sub Trim first before adjusting End Point Adjustment.

- 1) Before using, center (0) each main trim.
- 2) Select SUB-T with the multi-selector and select a channel (ST/TH/AUX1/AUX2) to adjust Sub Trim with the select button.
- 3) Determine by Enter operation in the channel to set.
- 4) Install servo saver horn (servo arm) as close to centered as possible.

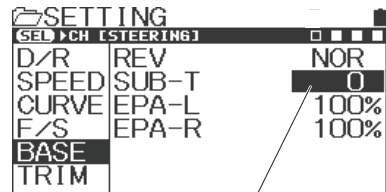

Setting SUB-T

- *For installation position of the servo horn, follow the instruction on the car body side.

- 5) Use the multi-selector to adjust the center.

- Setting Range: L150~R150(ST)
H150~B150(TH)
H150~L150(AUX1, AUX2)
- Default: 0

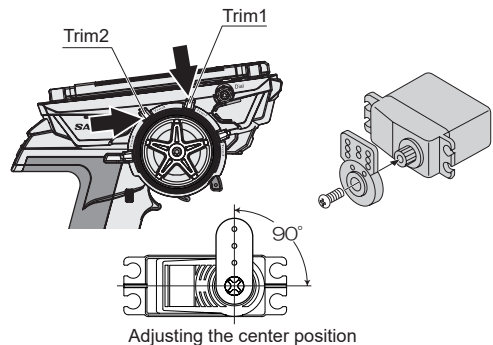

! Note

When installing the servo horn onto your servo, fix the servo horn as close to the center as possible and center it with Sub Trim. If Sub Trim and the transmitter main trim are off to one side, it causes dead band (the range the servo does not move) to the steering wheel and the throttle trigger.

● About Trim and Sub Trim

Trim is a feature for adjusting the neutral (center) position of the servo. When your model does not run straight after installing the steering servo onto the model, Trim adjusts the main trim of the steering. Also, the neutral position of the carburetor on RC cars needs neutral adjustment of the throttle servo along with linkage adjustment after installing the servo. Neutral position adjustment is necessary not only after installing the servo but for changes that happen during running such as tire wears and chassis twist. MT-5 Trim features two types of Trim including Center Trim that adjusts only the neutral position without changing the end of the operating angle and Parallel Trim that moves the end of the operating angle and the neutral position simultaneously. Sub Trim that adjusts the neutral (center) position before fixing the servo horn is Parallel Trim and the main trim is Center Trim.

○ Center Trim (Main Trim)

Even if you move the neutral position with Trim, the end of the operation angle does not move.

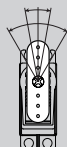

○ Parallel Trim (Sub Trim)

When you move the neutral position with Trim, the end of the operation angle also moves. When Sub Trim is adjusted after linkage is completed, readjustment of End Point Adjustment (EPA) will be necessary.

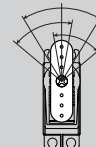

How to Use Each Feature

BASE

SETTING

- Base [BASE] is a feature to integrate features of Sub Trim that adjusts the direction of the servo of each channel and the speed controller according to a specific RC car and the End Point Adjustment [EPA] that sets the operating quantity into one feature (Base) to allow you to make a setting all at once.

END POINT ADJUSTMENT [EPA]

- You can adjust left and right operating quantity of the steering servo when operating the steering wheel/ throttle trigger and operating quantity of the high side and the brake side of the throttle servo, and the servo operating quantity of AUX1, AUX2 (3ch, 4ch).

[ST-EPA] STEERING END POINT ADJUSTMENT

- Due to linkage, suspension balance and the difference of the tire diameter, left and right cornering radius can be different. In case of this, this feature adjusts the servo operating quantity of left and right so that left and right cornering radius can be the same.

- 1) Before adjusting Steering End Point Adjustment (ST-EPA), make a neutral adjustment of the servo (P.26). Neutral adjustment is to align the center position with Sub Trim by turning the power on and installing the servo horn in the approximate center position.

- 2) Select either of [EPA-L/EPA-R] with the multi-selector and determine with the Enter.

- 3) Adjust the operating quantity with the multi-selector.

*When the cursor is on either of EPA-L/EPA-R, it is also possible to move the cursor by steering operation.

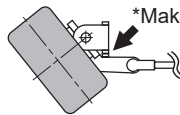

- Setting Range: L/R 0% ~ 150%
- Default: L/R 100%

Choose [ST] by select button

SETTING		
SEL CH	[STEERING]	
D/R	REV	NOR
SPEED	SUB-T	0
CURVE	EPA-L	100%
F/S	EPA-R	100%
BASE		
TRIM		



Note • If the linkage is locked for a long period, it can cause the servo breakage.

[TH-EPA] THROTTLE END POINT ADJUSTMENT

- It adjusts the High Point of FET Speed Controller, Brake Point, carburetor of engine and the brake operating quantity.

- 1) For a nitro car, make a neutral adjustment of the servo (P.26) before adjusting the Throttle End Point Adjustment (TH-EPA). Neutral adjustment is to align the center position with Sub Trim by turning the power on and installing the servo horn in the approximate center position.

- 2) Select [TH/Throttle] with the Select button.

- 3) Select either of [EPA-H/EPA-B] with the multi-selector and determine with the Enter.

- 4) Adjust the operating quantity with the multi-selector.

When adjusting ESC (FET Speed Controller), normally set both the high side and the brake side to 100% and set neutral, high point and brake point on the ESC side (Setting method is different depending on the ESC).

*When the cursor is on either of EPA-H/EPA-B, it is also possible to move the cursor by trigger operation.

*Make sure the servos do not lock to make clicking sound

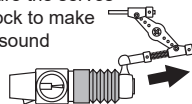

- Setting Range: H/B 0% ~ 150%
- Default: H/B 100%

Choose [TH] by select button

SETTING		
SEL CH	[THROTTLE]	
D/R	REV	NOR
SPEED	SUB-T	0
CURVE	EPA-H	100%
F/S	EPA-B	100%
BASE		
TRIM		



Note • When EPA setting value is too large on the fully open side of the carburetor and the brake side for throttle linkage, the servo is locked and it can cause the motor malfunction and runaway.

[AUX1-EPA]

AUX1 • END POINT ADJUSTMENT

● You can use AUX1 for functions of accessories and adjust the maximum steering angle (operating quantity) with EPA. Since you can set H/L separately, precise adjustment is possible.
*When setting AUX1 to [CODE5/CODE10] in AUX TYPE, the operation will not be reflected even by adjusting EPA.

- 1) Before adjusting AUX1 End Point Adjustment (AUX1-EPA), make a neutral adjustment of the servo (P. 26). Neutral adjustment is to align the center position with SubTrim by turning the power on and installing the servo horn in the approximate center position.
- 2) Select [AUX1] with the Select button. Select either of [EPA-H/EPA-L] with the multi-selector and determine with the Enter.
- 3) Adjust the operating quantity with the multi-selector.

- Setting Range: H/L 0%~150%
- Default: H/L 100%

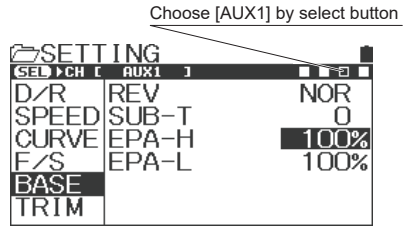

[AUX2-EPA]

AUX2 • END POINT ADJUSTMENT

● You can use AUX2 for functions of accessories and adjust the maximum steering angle (operating quantity) with EPA. Since you can set H/L separately, precise adjustment is possible.
*When setting AUX2 to [CODE5/CODE10] in AUX TYPE, the operation will not be reflected even by adjusting EPA.

- 1) Before adjusting AUX2 End Point Adjustment (AUX2-EPA), make a neutral adjustment of the servo (P. 26). Neutral adjustment is to align the center position with Sub Trim by turning the power on and installing the servo horn in the approximate center position.
- 2) Select [AUX2] with the Select button. Select either of [EPA-H/EPA-L] with the multi-selector and determine with the Enter.
- 3) Adjust the operating quantity with the multi-selector.

- Setting Range: H/L 0%~150%
- Default: H/L 100%

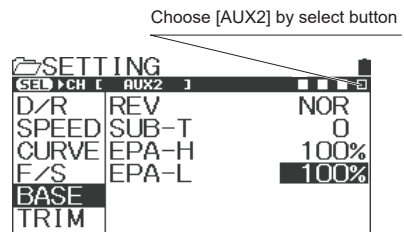

How to Use Each Feature

TRIM

SETTING

- For Trim, you can adjust Trim for each channel and set the Trim action (center/parallel).

TRIM

- Correct neutral (center) of each channel (ST/TH/AUX1/AUX2) with Trim.
- As default, steering is set for Trim 1 (TRM1), and throttle for Trim 2 (TRM2).

- 1) Select a channel (ST/TH/AUX1/AUX2) for adjusting Trim with the Select button.
- 2) Determine with Enter operation and adjust with the multi-selector.

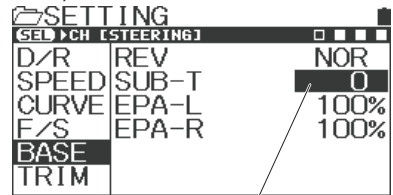

Setting SUB-T

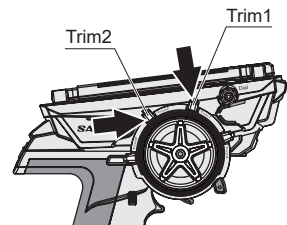

- Setting Range:
ST:L100~R100
TH:H100~B100
AUX1:H100~L100
AUX2:H100~L100

- Default:
ALL : 0

*Make an adjustment with TRM1 (ST) and TRM2 (TH) during operation. You can change the Trim lever position with the Key Assignments Trim feature (P. 52).

IMPORTANT

• About Trim

Trim is a feature to adjust the neutral (center) position of the servos. After installing the steering servo onto a car, you can adjust with Trim when the car does not move straightly. Neutral position adjustment is necessary not only after installing the servo but for changes that happen during running such as tire wears and chassis twist.

- It's Sub Trim that adjusts the center position when adjusting linkage (P. 26)



Note

- If Trim and Sub Trim are off to one side, it causes dead band (the range the servo does not move) to the steering wheel and the throttle trigger. When installing the servo horn, fix the servo horn as close to the center as possible and center it with Sub Trim.

TRIM TYPE

- You can set Trim performance of each channel to Center Trim (CENT) and Parallel (PARA).
- As default, steering is set for Trim 1 (TRM1), and throttle for Trim 2 (TRM2).

- 1) Select a channel (ST/TH/AUX1/AUX2) to set with the Select button. Selecting a channel with the select button
- 2) Determine with Enter operation and adjust with the multi-selector.

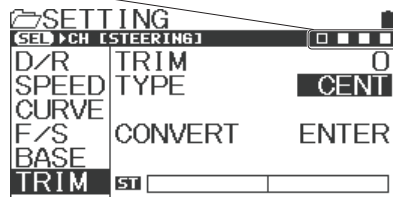

IMPORTANT

• About Center Trim and Parallel Trim

There are two types of Trim including Center Trim that adjusts only the neutral position without changing the end of the operating angle and Parallel Trim that moves the end of the operating angle and the neutral position simultaneously. Sub Trim that adjusts the neutral (center) position before fixing the servo horn is Parallel Trim and the main trim has options of Center Trim and Parallel Trim. You can select according to your purpose.

○Center Trim

Even if you move the neutral position with Trim, the end of the operation angle does not move.

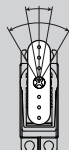

○Parallel Trim

When you move the neutral position with Trim, the end of the operation angle also moves. When Sub Trim is adjusted after linkage is completed, readjustment of End Point Adjustment (EPA) will be necessary.

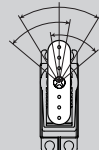

CONVERT

● A feature to convert Trim that has been adjusted in each channel to Sub Trim and EPA and to correct Trim to center. Depending on a setting, there is a case you cannot convert.

- 1) Select a channel (ST/TH/AUX1/AUX2) to convert with the Select button.
- 2) Once a channel to set is determined, launch the convert feature with Enter operation.
- 3) For example, if the converting feature is used when SteeringTrim is [L20] and each [EPA] is 100%, the flow will be as shown in right illustration. Trim will be centered [0] and the portion of the Trim movement will be converted to Sub Trim and EPA.

*Conversion can be set in each channel.

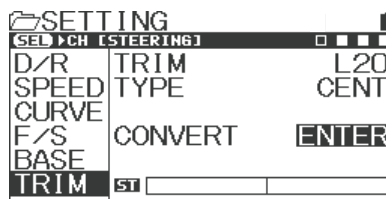

ENTER ↓ ↑ BACK

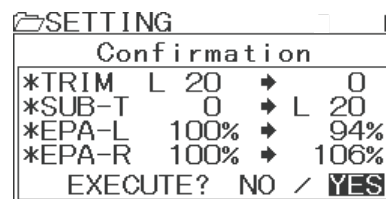

ENTER ↓ ↑ BACK

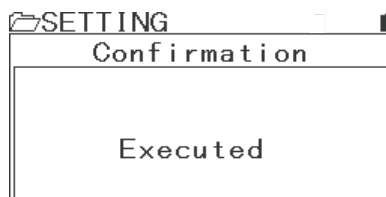

Conversion is completed. ↓↓

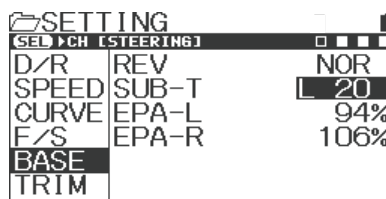

How to Use Each Feature

THROTTLE FUNCTION

- The throttle function allows you to adjust the setting values of ALB (Anti-Lock Brake), OFFSET and TH TYPE (throttle type) of the throttle channel.

ANTI-LOCK BRAKE [ALB]

THROTTLE FUNCTION

- Anti-Lock Brake enables stable braking on a low grip road.
- Because of the stable braking, you can trace cornering lines as intended.

1) Select the throttle function with the multi-selector and determine with the Enter operation.

2) When selecting [ALB] with the multi-selector and determining with the Enter, the menu changes to ALB setup menu.

3) Setting Stroke (STROKE)

Set Stroke of ALB with the multi-selector.

Stroke is the width of repeated actions at the time of braking.

- Setting Range: OFF, 1%~100%
- Default: OFF *ALB does not work when it is off.

After turning on ALB function, please assign ALB to SW2 by Key Assign SW..Mode is selected PUSH or TOGGLE. PUSH setting is turning on ALB while holding SW2. TOGGLE setting is switching on and off ALB when pushed SW2. Please refer p.50 how to set key assign setting.

4) Setting Point (POINT)

Set Point of ALB with the multi-selector. Point is the position where ALB starts acting when operating the brake.

- Setting Range: 5%~100%
- Default: 80%

5) Setting Lag (LAG)

Set Lag of ALB with the multi-selector.

Lag is a setting of time lag from the time when operating to the point to the time when ALB starts acting.

- Setting Range: 0.00s~1.00s
- Default: 0.00s

6) Setting Cycle (CYCLE)

Set a cycle of ALB with the multi-selector.

Cycle is a frequency setting of repeated actions for braking.

- Setting Range: 0.01s~1.00s
- Default: 0.03s

7) Setting Duty (DUTY)

Set Duty of ALB with the multi-selector. Duty is adjust the ratio of brake ON to OFF of a cycle.

- Setting Range: 20~100%
- Default: 50%

*Working Anti-Lock Brake, X illumination and function LED will flash.

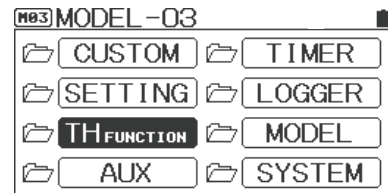

ENTER ↓ ↑ BACK



ENTER ↓ ↑ BACK

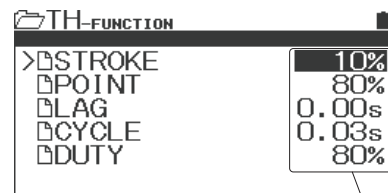

Set each parameter.

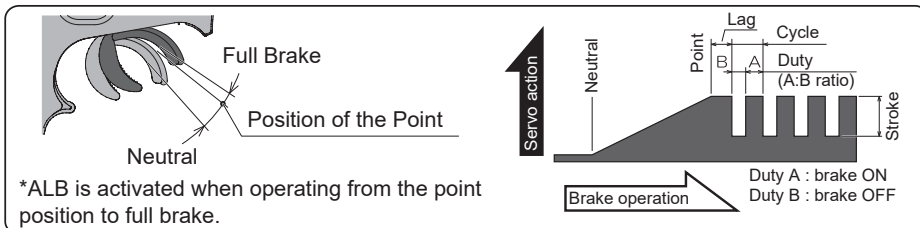

SUPPLEMENT

- Activate the brake rather strongly not to the extent that the tires of your RC car lose their grips (not to slip) and adjust so that Anti-Lock Brake is activated just before the tires are locked and slide.
- If you set ALB using a speed controller with a back on an RC car, you may not able to operate back movement. When using a back movement, turn ALB off.

OFFSET

THROTTLE FUNCTION

- By moving the position of the throttle neutral at the time of starting a nitro RC car engine, it improves the start-up performance of the engine.
- You can fix at a position where idling speed is increased so that the engine will not stop during refueling your nitro RC car.
- By operating the switch that has been set, you can stop the engine of your RC boat.
- You can use various power sources with Offset feature.
- ON/OFF of the Offset feature is not assigned to the keys at the factory. When using, assign the features with key assignment (P. 51, 52).

- 1) Select the throttle function with the multi-selector and determine with the Enter operation.
- 2) Select [OFFSET] with the multi-selector and determine with Enter. It will change to OFFSET Setting menu.
- 3) Setting Offset [OFFSET]
Set ON/OFF of the Offset feature with the multi-selector.

- Setting Range: ON/OFF
- Default: OFF

- 4) Setting Type [TYPE]

Set Type of the Offset with the multi-selector.

- Setting Range: I-UP (Idle Up)/N-BR (Neutral Brake)
- Default: I-UP

- 5) Setting Point [POINT]

Set Point of the Offset with the multi-selector.

- Setting Range: 0%~100%
- Default: 0%

- 6) Setting Beep [BEEP]

Set Alarm (Beep) that goes off when the Offset is activated.

- Setting Range: ON/OFF
- Default: ON

*When the Offset feature is working, X illumination and Function LED flash.

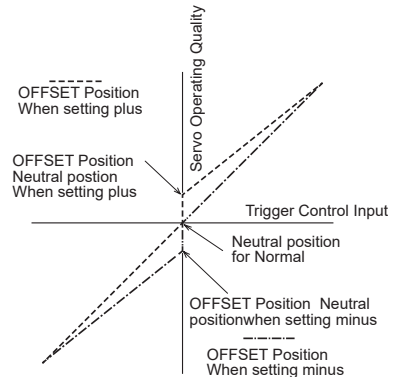

ENTER ↓ ↑ BACK



THROTTLE TYPE [TH TYPE]

THROTTLE FUNCTION

- You can move the neutrals position of the throttle and set the operating ratio of the forward side and the brake (backward) side to either 7:3 or 5:5.

*Set the throttle type according to the speed controller to be used.

- 1) Select the throttle function with the multi-selector and determine with the Enter operation.
- 2) Select [TH TYPE] with the multi-selector and determine with Enter.

- 3) Setting the Throttle Type

Set the Throttle Type with the multi-selector.

- Setting Range: F7:B3 / F5:B5
- Default: F7:B3

*When changing TH TYPE, the screen changes to the confirmation screen and a message is displayed. Operate following the message.



ENTER ↓ ↑ BACK

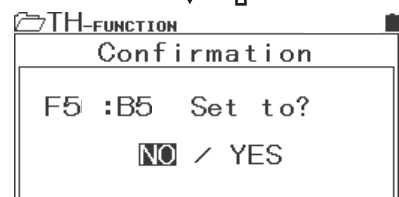

How to Use Each Feature

AUX

- AUX is a feature to set the performance of AUX1 and AUX2 (3ch, 4ch). You can choose from STEP AUX (STEP), POINT AUX (POINT), 4WS (4-Wheel Steering: Coordinate Phase, Opposite Phase). MOA (Motor On Axle), AUX-MIX (AUX Mixing: ST → AUX/TH-AUX) and CODE5/CODE10 (Code Communication).
*Setting of AUX TYPE is done in the System Menu. Make a setting according to the purpose of the use.

STEP AUX

- Setting Step AUX allows you to set the operating quantity by operating assigned Trim or a switch.
- By factory default, the AUX feature is set to the Step AUX.

- 1) Select [AUX] with the multi-selector and define with the Enter operation.
- 2) Setting Step AUX (STEP AUX)
Determine [CH] to activate with the Select button and set the position of the motion with the multi-selector.

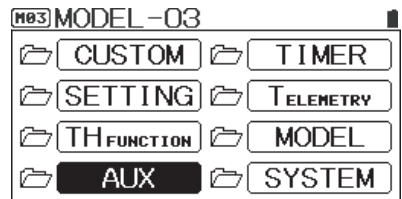

ENTER ↓ ↑ BACK

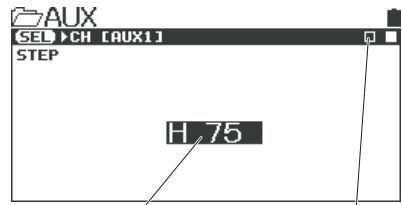

Motion Position Display

Securing a Channel

*Operating quantity can be set with EPA (End Point Adjustment, P.27, 28).

*Assign the features to Trim and Dial with Key Assignments according to the used method.

POINT AUX

- By setting Point AUX and assigning the movement of AUX1/AUX2 (3ch, 4ch) to the switch and Trim, you can move the servo to the set Point. The Point that moved can be set with EPA (End Point Adjustment). Adjust the Point position according to the usage.
*Amount of Points will be 2 ~ 6 points and can be set with AUX TYPE

- 1) Select [AUX] with the multi-selector and set with AUX TYPE.
- 2) Setting Point AUX (POINT AUX)
Determine [CH] to activate with the Select button and set the Point of the motion with the multi-selector.

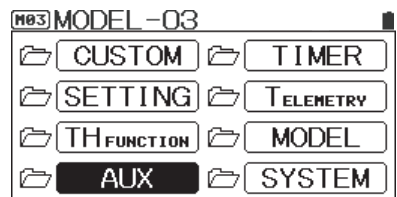

ENTER ↓ ↑ BACK

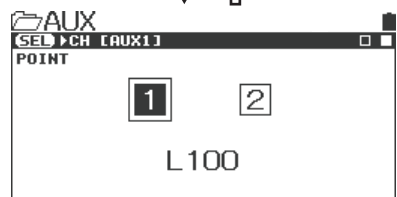

*Set to [POINT AUX] with [AUX TYPE] of [SYSTEM] according to the usage.

*Assign the features to Dial and Trim with Key Assignments to operate or operate with the multi-selector.

4-WHEEL STEERING

AUX

● With the operation of assigned Trim or Switch, control the motion of the 4 Wheel Steering.

1) Select [AUX] with the multi-selector and define with the Enter operation.

2) Setting Operating Mode

Set the Operating Mode of 4WS with the multi-selector.

Set the Operating Mode according to the usage.

*When using during operation, assign the feature of the Operating Mode to Trim or the switch 1.

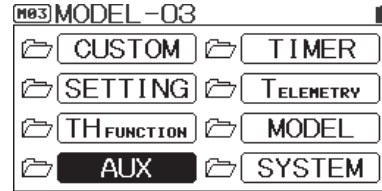

ENTER ↓ ↑ BACK

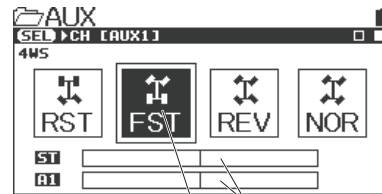

Servo monitor

Switching the Operation Mode

Steering the Motion Image

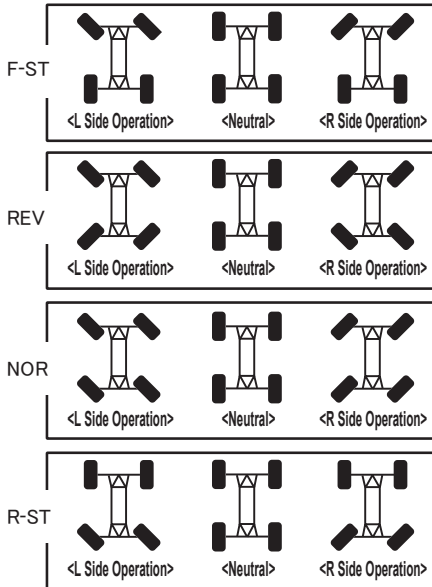

[MOA] FRONT-REAR WHEEL SEPARATE DRIVE

AUX

● By setting Motor On Axle (MOA), you can adjust the drive ratio of front and rear wheels of a front-rear dual motor car.

1) Select [AUX] with the multi-selector and define with the Enter operation.

2) Setting Operating Mode

Set the Operating Mode of MOA with the multi-selector.

*Adjust Step setting to change the drive distribution of front-rear with [MODE] of [AUX TYPE] of [SYSTEM].

*When using, assign the features to Dial or Trim or operate with the multi-selector.

*Connect the speed controller for controlling the rear motor to the channel (AUX1/AUX2) that is set to MOA.

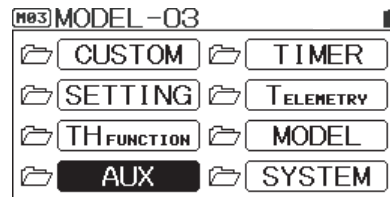

ENTER ↓ ↑ BACK

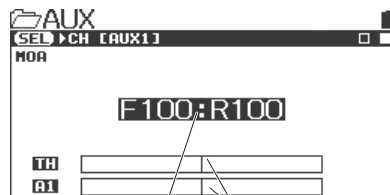

Servo monitor

Front-rear drive ratio

MOA Motion Image

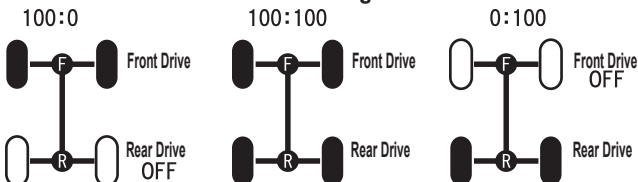

*By changing the ratio, you can adjust the gear ratio of front-rear.

How to Use Each Feature

AUX

- AUX is a feature to set the performance of AUX1 and AUX2 (3ch, 4ch). You can choose from STEP AUX (STEP), POINT AUX (POINT), 4WS (4-Wheel Steering: Coordinate Phase, Opposite Phase). MOA (Motor On Axle), AUX-MIX (AUX Mixing: ST → AUX/TH-AUX) and CODE5/CODE10 (Code Communication).
*Setting of AUX TYPE is done in the System Menu. Make a setting according to the purpose of the use.

AUX MIXING

AUX

- Setting AUX Mixing allows you to mix from the steering to AUX and from the throttle to AUX.
*Set AUX TYPE and MODE for operation to use for [AUX TYPE] of [SYSTEM].
- At factory, the AUX feature is set to Step AUX.

1) Select [AUX] with the multi-selector and define with the Enter operation.

2) Setting Mixing Rate

Set the Mixing Rate with the multi-selector.

- Setting Range: 0%~100%
- Default: 100%

*Set to [AUX MIX] with [AUX TYPE] of [SYSTEM] and set the Mixing performance with [MODE] according to the usage. (p.52)

*Assign the features of the Mixing Rate to Trim or the switch with Key Assignments, or operate with the multi-selector.

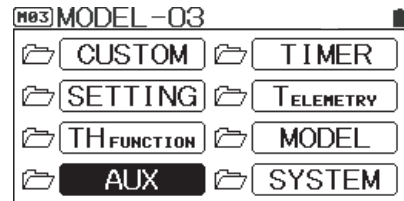

ENTER ↓ ↑ BACK

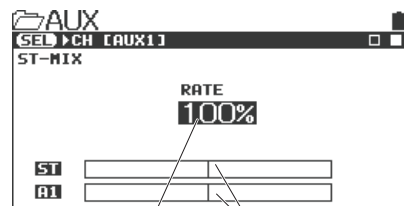

Servo monitor

Setting Mixing Rate

CODE AUX

AUX

- Code AUX (CODE AUX) is a feature to perform code communication by assigning a setting value to each code of CODE5/CODE10. It is an extension feature to change the setting of speed controller (SUPER VORTEX series/ SV-D2), PGS servo series, and the Gyro System (SGS-01C/SGS01D/SGS-02) that are compatible to CODE AUX.
- You can set 2 types of Code AUX1 and CODE AUX2.
 - *Setting of CODE is done by setting [TYPE] of [SYSTEM] menu. By setting [MODE], the display is changed according to each equipment. When setting [MODE] to [USER], each code display allows the user to set.
 - *When using an AUX channel as CODE AUX, make sure to set the response mode of A1/A2 that are set for BIND to [SHR] (See P.49, 50).
 - *When using CODE AUX, do not connect the servo to CH3 and CH4 of the receiver to be used.
 - *When using, assign the features to Dial or Trim with the Key assignments or operate with the multi-selector.

- 1) Select [AUX] with the multi-selector and define with the Enter operation.
- 2) Setting Code AUX
Select [CODE AUX] to change setting and adjust the setting value with the multi-selector.

- Setting Range: -100%~100%
- Default: 0%

*In case of setting CODE5/CODE10 on AUX TYPE, CODE AUX setting condition will display on top screen as below pictures.

*Please check CODE5/CODE10 compatible devices on SANWA HP. Please check each compatible device user manual about detail setting for the each device.

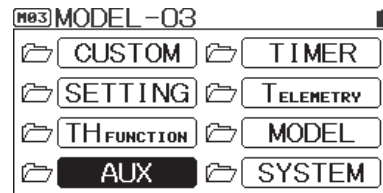

ENTER ↓ ↑ BACK

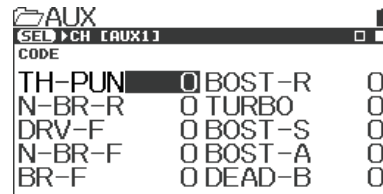

When TYPE setting is [CODE10] and MODE setting is [SV-G/D]

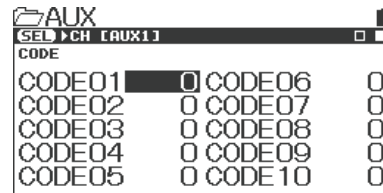

When MODE setting is [USER]

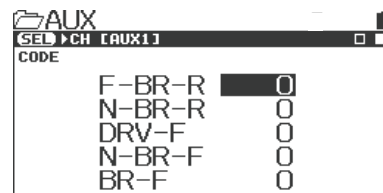

When TYPE setting is [CODE5] and MODE setting is [SVZ]

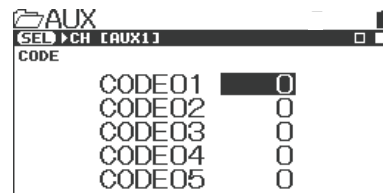

When MODE setting is [USER]

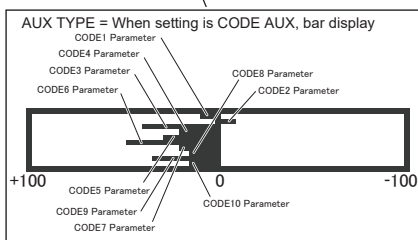
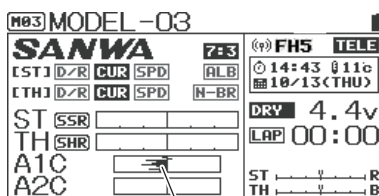

How to Use Each Feature

TIMER

- It has three timer features including Lap Timer, Interval Timer and Down Timer.
 - When selecting a timer and operate the Select button, you can toggle between the timer screen and the setting screen.
- *When a timer is activated, X Illumination and Function LED flash.

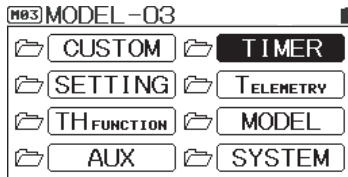

ENTER ↓ ↑ BACK

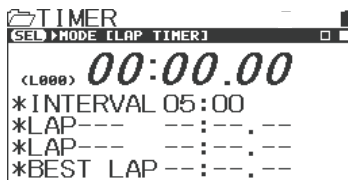

<LAP TIMER SCREEN>

- You can check the lap time measured on the LAP TIMER screen.
- When Enter is being operated while Lap Timer is activated/not activated, the screen is changed to the Lap Time display. You can check each lap time with the multi-selector.

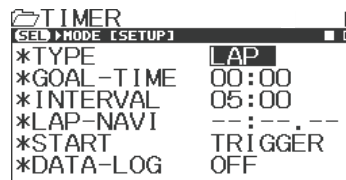

<SETUP SCREEN>

SETUP

TIMER

- Make all settings of the timers with the Setup Menu.
- Setting TYPE
 Select [TYPE] with the multi-selector to do setting.
 - Setting Range: LAP/INT/DOWN
 - Default:LAP
 - LAP: Possible to measure and record each lap up to 999 laps (for all models)
 - INT: The timer is activated at the set time.
 - DOWN: It can be a guideline for calculating running time and fuel consumption of a Nitro car.
 - Setting GOAL TIME
 By setting a goal time, the Alarm is activated.
 - Setting Range: 00: 00 ~ 99: 59 (00: 01 unit)
 - Default: 05: 00
 - Setting INTERVAL
 The Alarm is activated at the set time (It tells you the lap time).
 - Setting Range: 00: 00 ~ 99: 59 (00: 01 unit)
 - Default: 01: 00
 - Setting LAP NAVI
 It activates the alarm at the set time at the time of running and uses it as a guideline for the goal time.
 - Setting Range: 00:00.01s~99:59.99
 - Default: --:--:--

*LAP NAVI will not start at 00 : 00. 00.

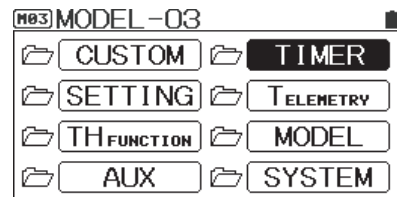

ENTER ↓ ↑ BACK

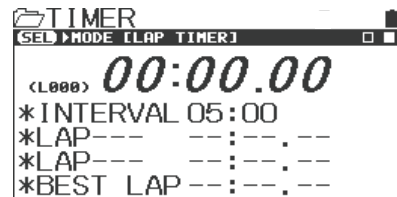

Select Button

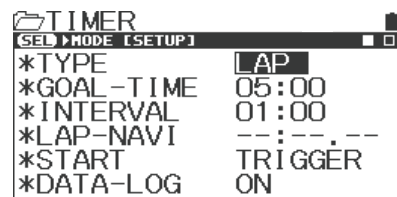

5) Setting START

Set the Timer Start from the Trigger Interlock/Switch/Random.

- Setting Range: TRIGGER/KEY/STARTER
- Default: TRIGGER

6) Setting DATA-LOG

It sets Telemetry Data Log (record) along with the timer.

- Setting Range: ON/OFF
- Default: ON

*Log starts along with the timer feature.

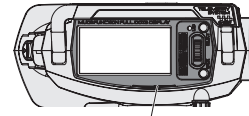

Function LED

X Illumination



LED flashes while the timer is activated.

LAP TIMER

TIMER

- You can measure and record each lap up to 999 laps (works for all models).
- Pre Alarm (PRE-ALM) is installed and the alarm goes off before the goal.

1) Select [TIMER] with the multi-selector and determine with the Enter operation.

2) Starting the Timer

As a default, the timer switch is set to SW1. By holding SW1, the timer becomes a standby state for starting and by either pressing SW1 again or operating the throttle trigger, measuring starts.

3) Every time you operate SW1, lap time is measured.

The switch does not work for 3 seconds after operating SW1.

4) Completing measuring

By holding SW1, measuring will be completed.

*You can check the measured lap time on the LAP TIMER screen. When Enter is being operated while the lap timer is activated/stopped on the LAP TIMER screen, the screen is changed to the lap time display. You can check each lap time with the multi-selector operation (not possible on the SETUP screen).

*When turning the power switch off while the timer is activated, the timer will be reset.

*When the timer is set to SW1/SW2, the timer will be in the standby mode by holding the switch even on a screen other than the setting screen.

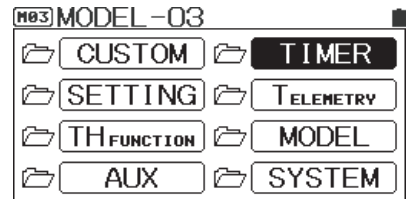

ENTER ↓ ↑ BACK

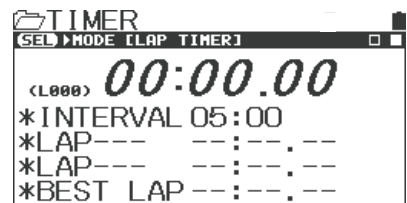

ENTER ↓ ↑ BACK

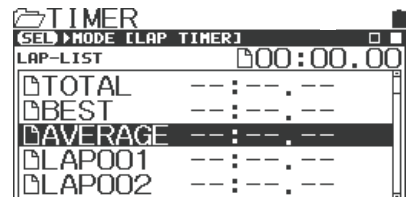

Switch 1

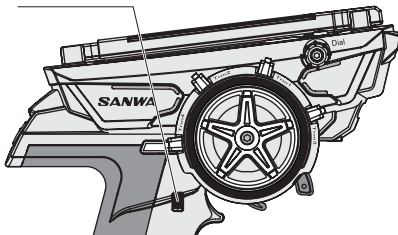

How to Use Each Feature

INTERVAL TIMER

TIMER

● It activates the alarm at the time set at the beginning of running and uses it as the guideline for the goal time.

1) Select [TIMER] with the multi-selector and determine with the Enter operation.

2) Setting the Type [TYPE]

Operate the Select button and select [INT] with [TYPE].

3) Setting Interval (INTERVAL)

Set the Interval Timer with [INTERVAL].

4) Starting Interval Timer

As a default, the timer switch is set to SW1. When holding SW1, the timer will be in the standby mode and measuring will start when you press SW1 again or operate the trigger.

5) Every time you operate SW1, the Interval Timer will be reset.

6) Completing measuring

By holding SW1, measuring will be completed.

*When turning the power switch off while the timer is activated, the timer will be reset.

*When the timer is set to SW1/SW2, the timer will be in the standby mode by holding the switch even on a screen other than the setting screen.

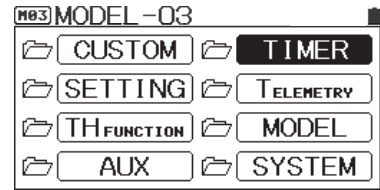

ENTER ↓ ↑ BACK

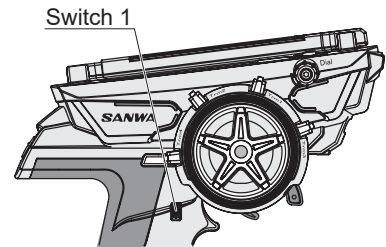
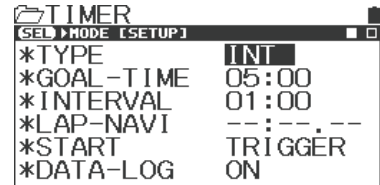

DOWN TIMER

TIMER

● It can be a guideline for calculating running time of an electric RC car and the fuel consumption of an engine RC car.

● You can set for per second up to 99 : 59.

● When the timer switches to the Up Timer after the Down Timer ends, you can check the lap time after the end.

1) Select [TIMER] with the multi-selector and determine with the Enter operation.

2) Setting the Type [TYPE]

Operate the Select button and select [DOWN] with [TYPE].

*Set the Down Timer with [GOAL-TIME] of SETUP.

3) Starting Down Timer

As a default, the timer switch is set to SW1. When holding SW1, the timer will be in the standby mode and measuring will start when you press SW1 again or operate the throttle trigger.

4) Every time you operate SW1, the Down Timer will restart.

5) Completing measuring

By holding SW1, measuring will be completed.

*When turning the power switch off while the timer is activated, the timer will be reset.

*When the timer is set to SW1, the timer will be in the standby mode by holding the switch even on a screen other than the setting screen.

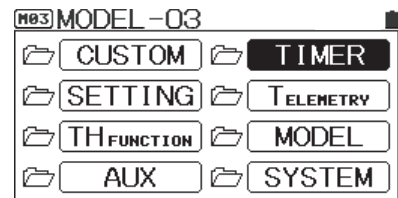

ENTER ↓ ↑ BACK

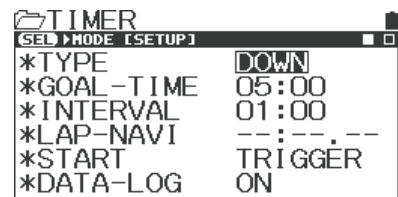

TELEMETRY

- A menu for setting Telemetry-related LOG DATA, TELEMETRY SETTING, GRAPH SETTING and TELEMETRY SWITCH.
- To use the Telemetry feature, you can make it compatible by using a compatible receivers, SUPER VORTEX series / Gen2 / PRO / SV-D2.
 - * Telemetry data is only capable with SANWA compatible devices. Telemetry data cannot be displayed in case of using other manufacture products.
 - *About voltage on the telemetry data, the voltage is not directly from battery. The voltage is BEC voltage which is supplying through ESC.
- With Telemetry, you can check the data of 2 temperature systems, battery voltage and number of rotations with the transmitter.
 - LOG DATA: Menu for controlling log data that is being recorded
 - TELEMETRY SETTING: Various settings of Telemetry features
 - GRAPH SETTING: Setting for graph display
 - TELEMETRY SWITCH: Various settings of the switch to activate based on the Telemetry data.

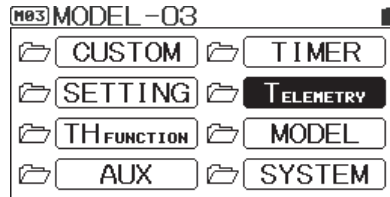

ENTER ↓ ↑ BACK

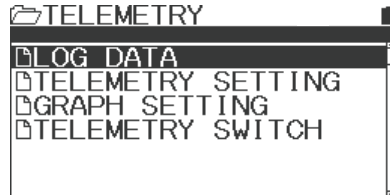

LOG DATE

TELEMETRY

- A feature to control the log data for creating a graph, saving onto an Micro SD card and deleting log data by reading the recorded log data.
- 1) Select [LOGGER] with the multi-selector and determine with the Enter operation.
 - 2) Select [LOG DATA] and determine with the Enter operation.
 - *In case of selecting MEMORY CLEAR, all telemetry data will be deleted after confirmation.
 - 3) Select the saved log data with the multi-selector. When Enter is being operated the menu is displayed. Select the menu and determine with the Enter operation.
 - VIEW DATA: Reads the recorded log data and creates a graph.
 - DATA NAME: Edits the file names of the log data.
 - EXPORT [.CSV]: Converts the telemetry data to [.CSV] format and saves onto a micro SD card.
 - PROTECT: Protects and saves the log data.
 - DELETE: Deletes the log data.

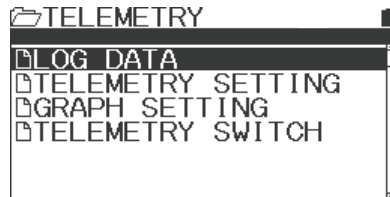

ENTER ↓ ↑ BACK

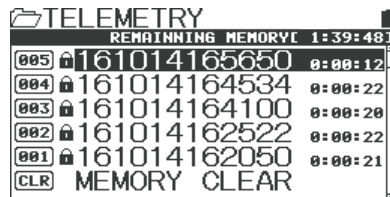

ENTER ↓ ↑ BACK

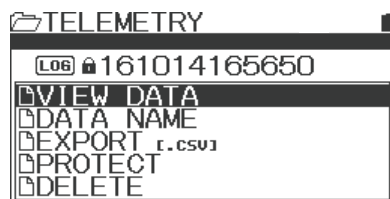

How to Use Each Feature

VIEW DATA

- A menu to read the recorded log data and creates a graph.
- 1) Select [LOG DATA] with the multi-selector and determine with the Enter operation.
 - 2) Select LOG DATA to create a graph and determine with the Enter operation.
 - 3) By selecting the log data, a menu will be displayed. By selecting [VIEW DATA], the log data is displayed as a graph.
 - 4) Setting the Display Size
 - When Enter is being operated while a graph is displayed, it sets the size of the graph to display.
 - Setting Range: 1/1 (8.5s/PAGE): 1 page/8.5 seconds
 1/2 (17s/PAGE): 1 page/17 seconds
 1/4 (34s/PAGE): 1 page/34 seconds
 1/8 (68s/PAGE): 1 page/68 seconds
 - Default: 1/1(8.5s/PAGE)
 - 5) Methods to move a page
 - When operating the Select button while a graph is displayed, you can set the method to move the displayed page.
 - Setting Range: Cursor/Page/Lap
 - Default: Cursor
 - *When Enter is being operated on the screen, which a graph is displayed on, it moves to the lap list.

TELEMETRY

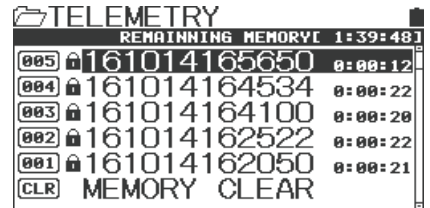

ENTER ↓ ↑ BACK

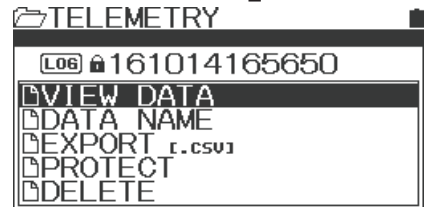

ENTER ↓ ↑ BACK

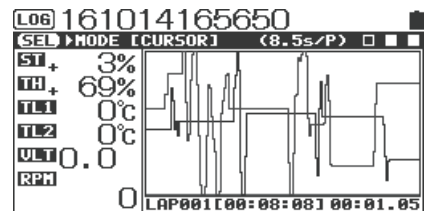

DATA NAME

- A feature to change the file names of the selected log data.
 - Only alphabets and numbers can be used for file names.
- 1) Select [LOG DATA] with the multi-selector and determine with the Enter operation.
 - 2) Select LOG DATA to change the file name and determine with the Enter operation.
 - 3) Setting the Data Name
 - With the multi-selector, move the cursor “_” to the position where texts are entered. Once the position is set, determine the cursor position with the Enter operation.
 - *Once the cursor position is set, it moves to the selection of text input.
 - 4) Determining Texts to enter
 - Select texts to enter with the multi-selector. Once you have determined which texts to enter, input with the Enter operation.
 - Setting Range: A~Z, 0~9, Symbols
 - *When changing texts that have been entered or moving the cursor of text input, press the back button and cancel the action.
 - *To switch between alphabets and numbers, use the Select button.

TELEMETRY

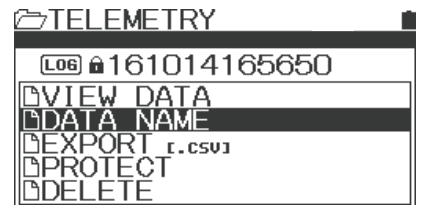

ENTER ↓ ↑ BACK

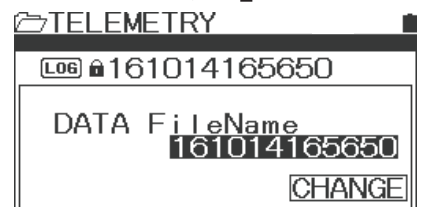

ENTER ↓ ↑ BACK

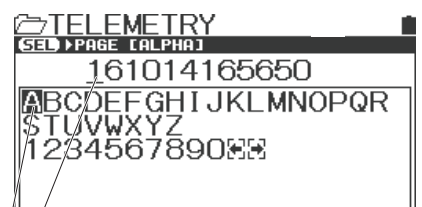

Text Position Cursor
(it flashes when moving the cursor.)

Text Input Selection Cursor

EXPORT [.CSV]

- A feature to convert the selected log data to a graph with PC (Personal Computer) software such as a spreadsheet software.
- Please note that data converted by the Export feature cannot be converted to a graph with the transmitter.
- When using the Export feature, a micro SD card is necessary.

- 1) Select [LOG DATA] with the multi-selector and determine with the Enter operation.
- 2) Select LOG DATA to export and determine with the Enter operation.
*With the Enter operation, it moves to CSV file name (Changing File Name).
- 3) Setting CSV File Name
When changing the format, you can change the File Name also Text input is the same as the data name. Refer to the data name input.
- 4) Conversion to CSV File Format
Move the cursor to [SAVE] and convert with the Enter operation.

*You can cancel the conversion operation during converting data with the back operation.

*Move the data to the PC via a micro SD card after converting the data and display a graph.

TELEMETRY

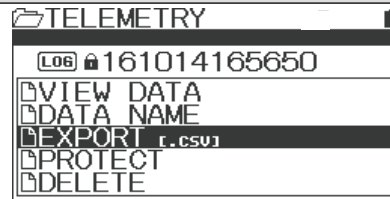

ENTER ↓ ↑ BACK

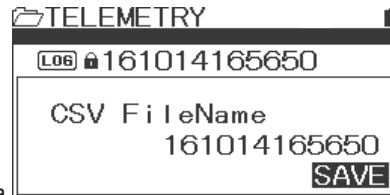

ENTER ↓

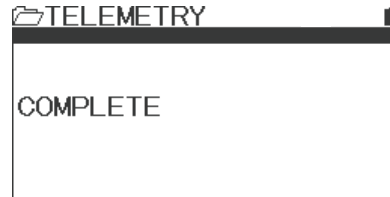

PROTECT

- A feature to protect the log data from accidental deletion.
- 1) Select [LOG DATA] with the multi-selector and determine with the Enter operation.
 - 2) Select LOG DATA to protect and determine with the Enter operation.

*With every Enter operation, it toggles Effective/Non-effective of protection.

TELEMETRY

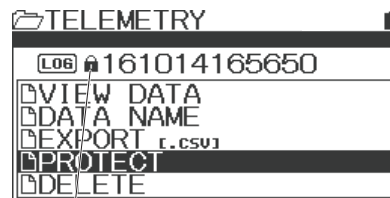

Protection Mark

DELETE

- A feature to delete the log data.
 - Protected data cannot be deleted.
- 1) Select [LOG DATA] with the multi-selector and determine with the Enter operation.
 - 2) Select log data to delete and determine with the Enter operation. The confirmation screen will be displayed. Operate the following screen display.

TELEMETRY

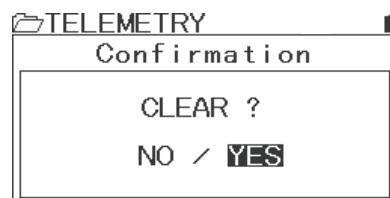
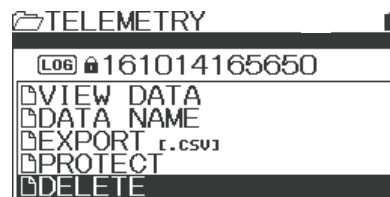

How to Use Each Feature

TELEMETRY

TELEMETRY SETTING

TELEMETRY

● Set each feature of Telemetry. Select the feature to set with the select button.

- TLM1/TLM2: Received condition, temperature, telemetry data setting.

In case of selecting TL-DATA

[NAME]: Up to 3 characters of data names of TLM1/TLM2 are changeable.

[UNIT]: Setting the Temperature and changing the Speed display. (°C/ °F/ KM [Speed unit is changeable])

[MAX]: Setting maximum value when displaying the data as a graph.

[ALERT]: Activates the alarm at the set temperature. (*It cannot set for displaying the speed.)

[MIN]: Setting minimum value when displaying the data as a graph.

In case of selecting RX-DATA (p.62)

[MAX]: Setting maximum value when displaying the data as a graph.

[MIN]: Setting minimum value when displaying the data as a graph.

- RPM: Setting the Speed figured from the number of rotation data [UNIT]: Switching the number of rotation and the speed display (RPM, km/h, mph)

[MAX SCALE]: Setting the graph's minimum value when displaying the data as a graph.

- RATIO: When setting RATIO RPM sensor in the subtracted position, you can display the number of rotations of the motor and engine after calculating backward by setting RATIO.

- Setting Range: 00.001~64.999
- Default: 01.000

- 10COUNT DIST: When setting to [10 Count Distance] Speed display, the RPM sensor measures the moving distance that has been detected 10 times, calculate the speed and displays it by setting the value.

- Setting Range: 1cm~255cm
- Default: 30cm

- VOLT: Alarm is activated at the set voltage corresponding to the Telemetry Data and LED flashes.

[MAX VOLT]: Setting the Maximum Voltage

- Setting Range: 3.0V~9.0V, OFF
- Default: 8.4V

[ALERT VOLT]: Setting the Alarm Activation Voltage

- Setting Range: 3.0V~9.0V, OFF
- Default: 3.8V

[HOLD TIME]: Setting the Hold Time

*It is function to ensure that the alarm is not operated in case of the instantaneous voltage drop of throttle operation etc., in order to set the HOLD TIME.

- Setting Range: 0.0sec~5.0sec
- Default: 1.0sec

[MIN VOLT]: Setting of the Minimum Voltage

- Setting Range: 0.0V~9.0V, OFF
- Default: 3.0V

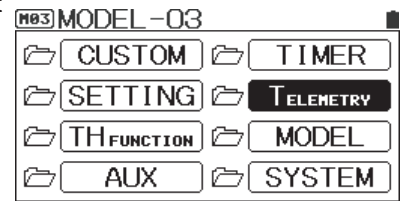

ENTER ↓ ↑ BACK

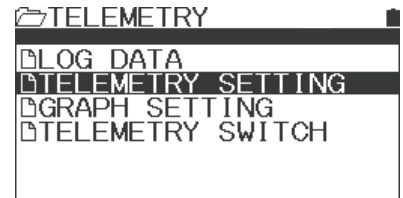

ENTER ↓ ↑ BACK

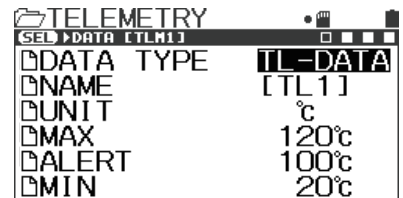

Select Button ↓↓

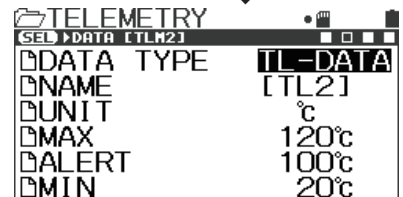

Select Button ↓↓

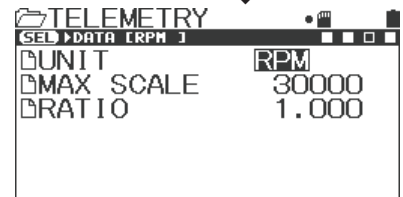

Select Button ↓↓

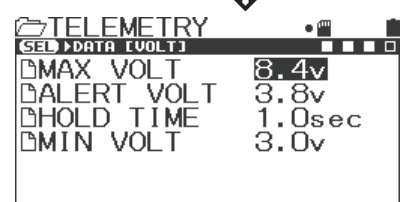

GRAPH SETTING

TELEMETRY

● A feature to select 3 items to be displayed in a graph when displaying Telemetry data as a graph.

1) Select [TELEMETRY] with the multi-selector and determine with the Enter operation.

2) Setting GRAPH SETTING

Select [GRAPH SETTING] with the multi-selector and determine with the Enter operation.

○ Setting Range: TL1/TL2/RPM/VOLT/ST/TH
 TLM1/2: Telemetry Data
 RMP: Rotation Number Data
 VOLT: Receiver Input Voltage

○ Default: LINE1: ST (Steering Data)
 LINE2: TH (Throttle Data)
 LINE3: VOLT (Receiver Input Voltage)

*In a graph, LINE1 is displayed in black, LINE2 in dark gray and LINE3 in light gray.

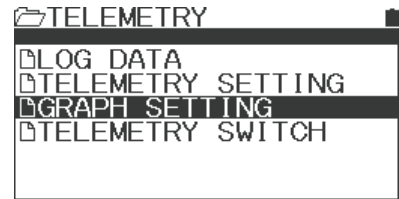

ENTER ↓ ↑ BACK

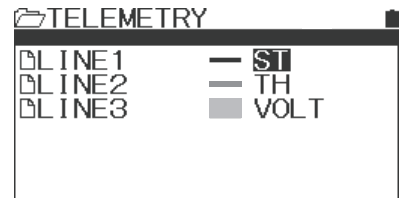

TELEMETRY SWITCH

TELEMETRY

● A feature that allows you to activate the switch with the Telemetry data based on the change of the same data.

- TRIGGER: Selects the data that will be the source of the switch operation.
- BORDER: A setting for operation standards of temperature or voltage.
- FUNCTION: Assigns functions.

1) Select [TELEMETRY] with the multi-selector and determine with the Enter operation.

2) Setting TELEMETRY SWITCH

Select [TELEMETRY SWITCH] with the multi-selector and determine with the Enter operation.

○ Setting Range: TRIGGER: OFF/TL1/TL2/VOLT
 BORDER: When setting temperature, 0~150
 When setting voltage, 3.0 ~ 9.0V
 FUNCTION: TIMER ON/OFF
 RACING MODE
 TH RATE

○ Default: MODE: TOGGLE/ONE SHOT
 TRIGGER: OFF
 BORDER: --- (OFF)
 FUNCTION: --- (OFF)
 MODE: --- (OFF)

*In case of setting RX-DATA of DATA TYPE on TLM1/TLM2, TL1/TL2 cannot be selected on TELEMETRY SWITCH.

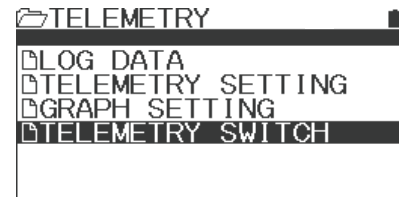

ENTER ↓ ↑ BACK

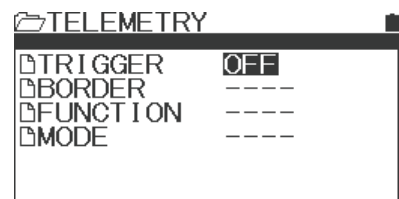

How to Use Each Feature

MODEL MENU

MODEL

- You can set the features about Model Select, Model Name, Model Copy and Model Clear.
- Installed with high capacity EEPROM and it can memorize data for 20 models of M01 ~ M20.

MODEL SELECT

- You can call model data of memorized M01 ~ M20 easily.

- 1) Select [MODEL] with the multi-selector and determine with the Enter operation.
- 2) Setting Model Select (MODEL SELECT)
Select [MODEL SELECT] with the multi-selector and determine with the Enter operation.
- 3) Selecting Model
Select Model to call with the multi-selector.
- Setting Range: M01 ~M20
- 4) When moving the cursor to the model to call and Enter is being operated, a message is displayed on the screen. Follow the display to operate and select a model.

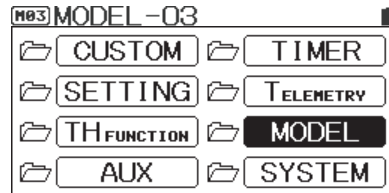

ENTER ↓ ↑ BACK

<1>Model Screen

Current Model Display

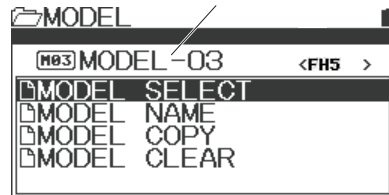

ENTER ↓ ↑ BACK

<2>Model Select Screen

RF Mode

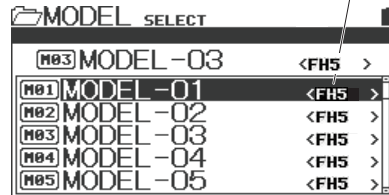

ENTER ↓ ↓ BACK

Completing Model Selection

<1>To the Model Screen

SUPPLEMENT

MT-5 has a feature of Direct Model Select. When turning the power switch of the transmitter on while pressing the Back button, it starts from the MODEL SELECT screen so that you can easily call a model to use. (P. 16)

How to Use Each Feature

MODEL MENU

MODEL

- You can set the features about Model Select, Model Name, Model Copy and Model Clear.
- Installed with high capacity EEPROM and it can memorize data for 20 models of M01 ~ M20.

MODEL COPY

- You can copy a selected model data to another model.

- 1) Select [MODEL] with the multi-selector and determine with the Enter operation.
- 2) Setting Model Copy [MODEL COPY]
Select [MODEL COPY] with the multi-selector and determine with the Enter operation.
- 3) Selection of a Copy Destination Model
Select a Copy Destination Model with the multi-selector.

*You can also select the copy source Model.

*For the copy source Model and the Copy destination Model, you can also select a micro SD card. When selecting a micro SD card as a copy source, and when there is no model data, you cannot copy.

- 4) When Enter is being operated a message is displayed on the screen. Follow the display to operate and complete Model Copy.

- About the Mode of Model Copy

FULL

All settings in the Model Data will be copied.

SYSTEM

Select the contents of SYSTEM of Model Data.

MODEL

Setting within Model Data, TH Function

Copying only the setting value of AUX

Select a mode of Model Copy for your usage.

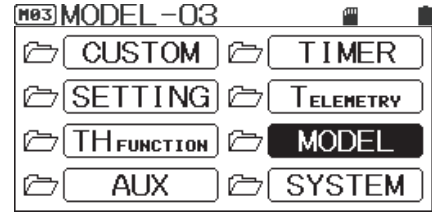

ENTER ↓ ↑ BACK

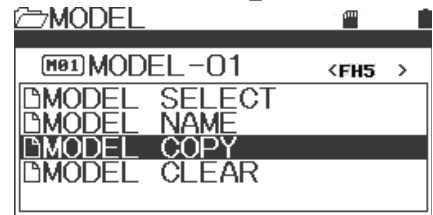

ENTER ↓ ↑ BACK

<1>Selecting Copy Destination

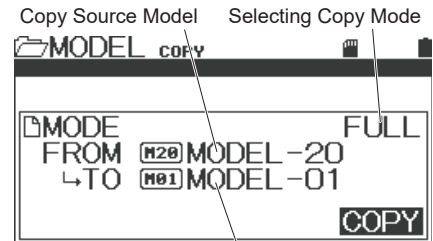

Copy Destination Model

<2>Copy Confirmation Screen

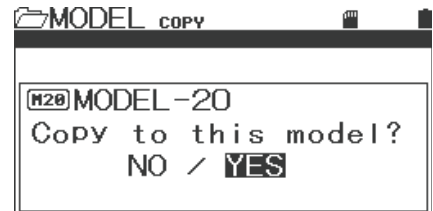

ENTER ↓
 •NO→Back to <1>
 •YES→Move to <3>

<3>Copying

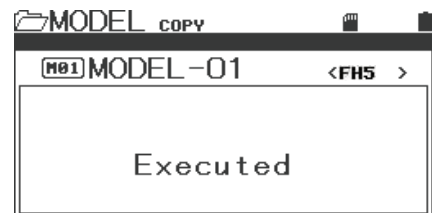

Back to 1 after copying

- About copying from a micro SD card
When performing Model Copy, the main body memory and a micro SD card can select designation of the copy source and the copy destination. When selecting a Model on the copy destination selection screen, you can select with the Select button operation.

- 1) When a model is selected, designation of the copy source and the copy destination other than the main body memory can also be selected. It is switched by the operation of the select button.

- MEMORY (Main Body Memory): 20 memory
- SD CARD (Micro SD Card): 250 memory
- SD EXP. (Micro SD EXP.): 20 memory

*SD EXP. copies data like the template data. Download the template data from our HP to use.

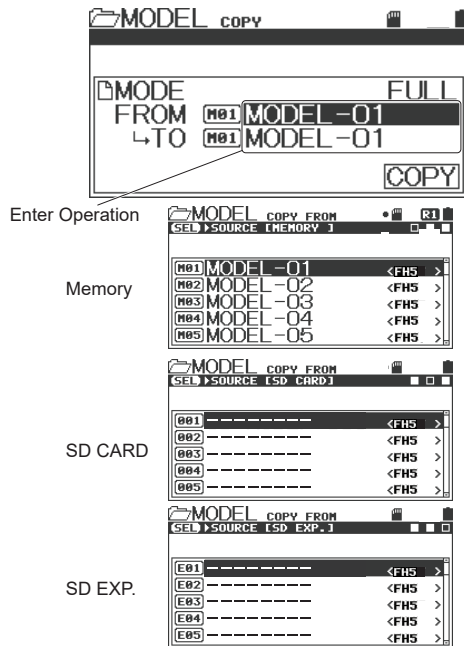

MODEL CLEAR

- A feature to clear (initialize) the setting data of Models.

- 1) Select [MODEL] with the multi-selector and determine with the Enter operation.
- 2) Setting Model Clear [MODEL CLEAR]
Select [MODEL CLEAR] with the multi-selector and determine with the Enter operation.
- 3) Select Model Data to perform Model Clear.
You can also select the main body memory and Model Data in the micro SD card by operating the Select button.
- 4) When Enter is being operated, a message is displayed on the screen. Follow the display to operate and complete Model Clear.

- About the Model Clear Mode

- FULL
All settings in the Model Data will be cleared.

- SYSTEM
Select in the contents of SYSTEM of Model Data and clearing

- MODEL
Setting within Model Data, TH Function
Clearing only the setting value of AUX

Select for your usage.

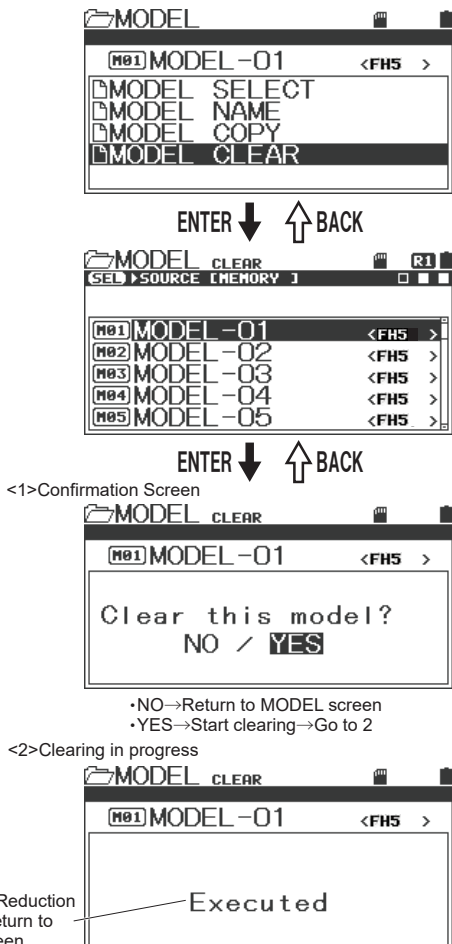

How to Use Each Feature

SYSTEM MENU

SYSTEM

- A feature for setting system of the transmitter, such as Bind (BIND), Key Assignments (KEY ASSIGN), BUZZER (Buzzer), Battery (BATTERY), LCD and CALIBRATION (Calibration).

BIND

- Select the output system that suits the receiver, set a mode for the servo (analog/digital) and the speed controller to be used and bind the transmitter with the receiver.
When using first time, please bind with receiver.

- 1) Select [SYSTEM] with the multi-selector and determine with the Enter operation.
- 2) Select [BIND] with the multi-selector and determine with the Enter operation.
- 3) Setting RF MODE (Signal output system)
 - Output System
 - FH5
RX-491, RX-492, RX-493, RX-493i
 - *FH4, FH3, FH2, FH-E, DS mode receivers are not compatible with MT-5.

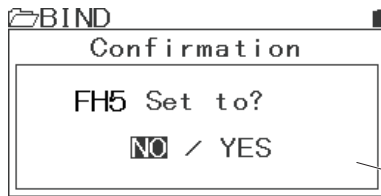

- 4) Setting TELEMETRY
Set TELEMETRY with the multi-selector.
 - Setting Range: ON/OFF
 - Default: ON

*Telemetry Compatible Equipment
RX-491, RX-492, RX-493, RX-493i
*Re-BIND is necessary if setting is changed.

- 5) Setting SAFETY LINK
Set SAFETY LINK (Safety Link) with the multi-selector.
 - Setting Range: 01~50
 - Default: 01

*When changing the setting of SAFETY LINK after BINDING, BIND again.
*Recommend to bind each car and receiver with different safety link number. In case of selecting wrong model, this can be avoiding misoperation or misworking.

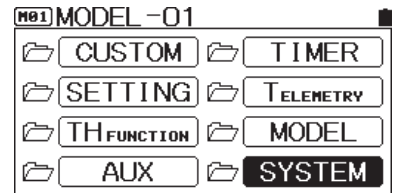

ENTER ↓ ↑ BACK

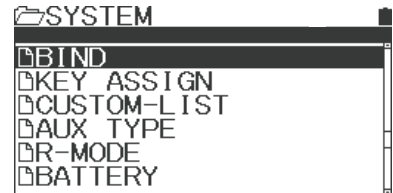

ENTER ↓ ↑ BACK

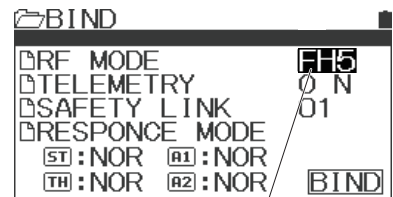

Output System

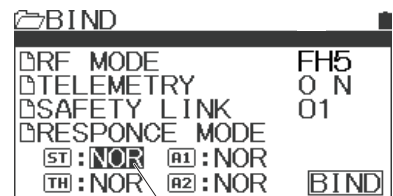

Response Mode

6) Setting Channel Mode

Set the response mode for each channel with Up key/Down key.

• You can set the response mode for each channel.

- Setting Range: NOR(Normal)
 - SHR(High Response)
 - SSR(Super Response)
 - SUR (Ultra Response)
- Default: NOR

IMPORTANT

- Note that, in SHR/SSR/SUR mode, an analog servo will not work. If you mistakenly use an analog servo in SHR/SSR/SUR mode, it will not operate normally and the servo will be broken. Do not use an analog servo in SHR/SSR/SUR mode.
- For digital servo (SRG, ERB ERS series, Digital ERG series), it can work for either mode of NOR/SHR.
- SSR mode works only for PGS, SRG servo, SUPER VORTEX series, HV-12 STOCK SPECIAL and HV-01.
- SUR mode works for only PGS servo, SUPER VORTEX Gen2 / PRO / SV-D2.
- In SHR/SSR mode, BL/RACER, BL/FORCE, F2000, F2200, F3000, F3300, SBL-01, 02 and 03CL do not work.
- BL-SIGMA, SV-08, HV-10, HV-12 and F2500 work in NOR/SHR mode.

7) Setting BIND

● What is BIND: Each of MT-5 transmitters has its own unique ID (solid identification) number. BIND is to let the receiver memorize the ID number. Operation will be possible only between the transmitter and the receiver that completed Binding.

- 1] When setting in the BIND menu is done, set BIND with the multi-selector.
- 2] Move the cursor to [ENTER] in the BIND menu and operate Enter. The transmitter now is ready for BIND operation.

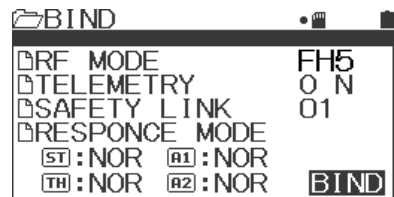
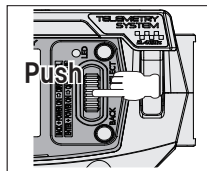

ENTER ↓

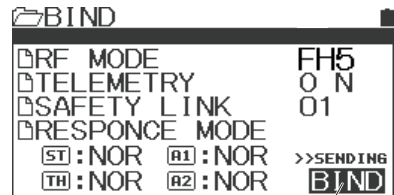

Flashing

- 3] Turn on the receiver with inserting Bind Plug in BIND/SSL port.

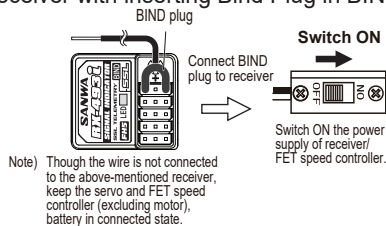

- 4] When BINDING is done properly, the LED of the receiver starts flashing slowly at first then it flashes in high speed and the LED goes off. When the LED of the receiver goes off, operate the Enter key of the transmitter to complete BINDING of the transmitter. When BINDING is done properly, the LED of the receiver is lit. When the LED of the receiver is lit, activate the servo to check if BINDING is completed.

*When BINDING cannot be done properly, restart from step 2).

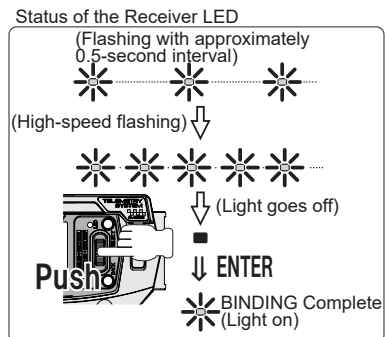

Note

- BINDING is not done at the factory. Please make sure to complete BINDING before use.
- When the receiver is new, make sure to complete BINDING for the transmitter and the new receiver.
- Make sure to use the set of the transmitter and the receiver that completed BINDING.
- When changing the setting in the BIND menu after BINDING, repeat BINDING.
- When changing the setting of the mode (NOR/SHR/SSR/SUR) after BINDING, repeat BINDING. If you do not re-BIND, setting changes will not be reflected.

How to Use Each Feature

SYSTEM MENU

SYSTEM

Positions of the Switch and Trim

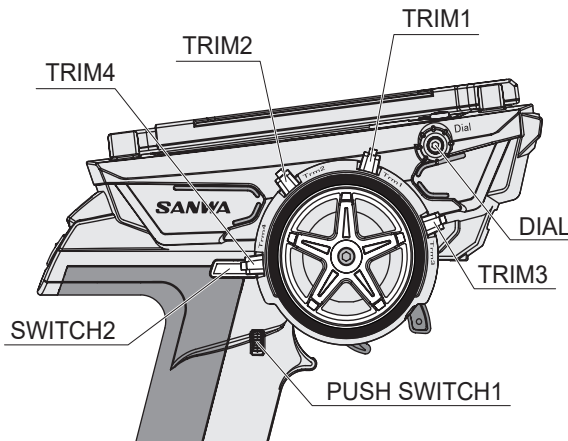

Features assigned to the Switch and Trim at the factory

- TR1:Steering Trim(TRM-ST)
- TR2:Throttle Trim(TRM-TH)
- TR3:Dual Rate ST(D/R-ST)
- TR4:Dual Rate BR(D/R-BR)
- SW1:Timer (TIMER)
- SW2:CUSTOM

KEY ASSIGN SWITCH

● You can assign features to the switches (SW1, SW2, SW3) of the transmitter and toggle ON/OFF of the features during operation.

- 1) Select [SYSTEM] with the multi-selector and determine with the Enter operation.
- 2) Select [KEY ASSIGN] with the multi-selector and determine with the Enter operation.
- 3) Setting the Switch (SW1/SW2)
Operate the Enter with [SW] and set the feature to assign to the switch with Up key/Down key.

Switch	An assignable feature
SW1 SW2	OFF, ASIST-ST, D/R-ST, D/R-TH, D/R-BR, CUR-ST, CUR-TH, SPD-ST, SPD-TH, ALB, OFFSET, AUX1, AUX2, TIMER, MAX-CLR, R-MODE, CUSTOM

○ Default : SW1: TIMER SW2: CUSTOM

*BY Setting [ASSIST-ST] onto SW1/SW2, you can turn ON/OFF the feature of D/R, SPEED and CURVE that can be set onto the steering.

4) Setting Mode

It sets the switch performance but there are cases that you cannot set depending on the feature to assign.

○ Setting Range

TOGGLE (Switching between ON/OFF when pressed every time)

PUSH (ON only during being pressed)

Tips

*Please set TOGGLE when assigned ALB function on SW2.

*In case of assigned TOGGLE, ALB switches ON and OFF when pushing SW2.

*ALB setting is not working only for setting ON at ALB function (p.31)

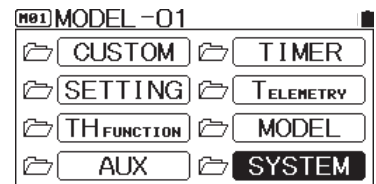

ENTER ↓ ↑ BACK

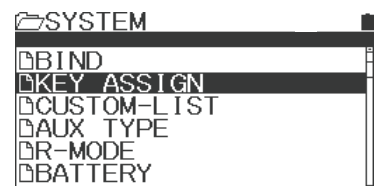

ENTER ↓ ↑ BACK

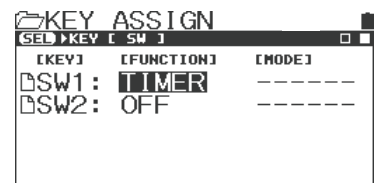

KEY ASSIGN TRIM

- You can change the setting value of each feature with Trim1 - Trim4.
- You can also change the setting of the variation change in one time of Trim operation with the STEP setting and the direction of the action with the REV setting.

1) Select [SYSTEM] with the multi-selector and determine with the Enter operation.

2) Select [KEY ASSIGN] with the multi-selector, switch to [TRIM] with the Select button, select an item to set and determine with the Enter operation.

3) Setting Trim (TRM1/TRM2/TRM3/TRM4)
Select [TRIM] to change the setting and set a feature to assign with the multi-selector.

KEY ASSIGN			
SEL	KEY	TRIM	
[KEY]	[FUNCTION]	[STEP]	[REV]
TR1	:TRM-ST	5	NOR
TR2	:TRM-TH	5	NOR
TR3	:D/R-ST	1	NOR
TR4	:D/R-BR	1	NOR
DIAL	:OFF	---	---

○ Setting Range:

TRIM	An assignable feature
TRIM1	OFF, TRIM-ST, TRM-TH, TRIM-A1, TRIM-A2, D/R-ST, D/R-TH, D/R-BR,
TRIM2	CU-R-ST, CU-R-TH, CU-R-BR, SP-ST-F, SP-ST-R, SP-TH-F, SP-TH-R,
TRIM3	ALB-PO, ALB-ST, ALB-LG, ALB-CY, OFFSET, AUX1, AUX1(CODE1~
TRIM4	10), AUX2, AUX2(CODE1~10)

○ Default: TR1:TRM-ST
 TR2:TRM-TH
 TR3:D/R-ST
 TR4:D/R-BR

4) Setting Step
Set the variation of the movement by one-time Trim operation. Select [STEP] with the multi-selector, determine with the Enter operation and set the variation.

○ Setting Range: 1~100
 ○ Default: 5

5) Setting the Direction of Action
Set the direction of action when operating Trim. Select [REV] with the multi-selector, determine with the Enter operation and set the direction of action.

○ Setting Range: NOR/REV
 ○ Default: NOR

About Dial

- *Assigned on Dial also can set as same as assigned TRIM.
- *In case of setting GAIN on assigned Dial, please select AUX1 or AUX2 to assign Dial.
- *If setting STEP MODE is 1 on AUXTYPE, value can be set 1 each when turing Dial. (Default MODE setting is 5, so values set 5 each in default setting when turing Dial)
- *Please refer to CODE AUX compatible device user manual when setting CODE AUX and select assigned function.

How to Use Each Feature

SYSTEM MENU

SYSTEM

CUSTOM-LIST

- By setting an often-used menu onto the custom list, you can build your favorite menu. You can create a custom list for each model memory and you can create a 4-page list.
- A menu set with the custom list will be usable in custom.

- 1) Select [SYSTEM] with the multi-selector and determine with the Enter operation.
- 2) Select [CUSTOM-LIST] with the multi-selector and determine with the Enter operation.
- 3) Setting Custom List
Using the multi-selector, set the channel/feature/item. You can assign 6 features per page and set for 4 pages.

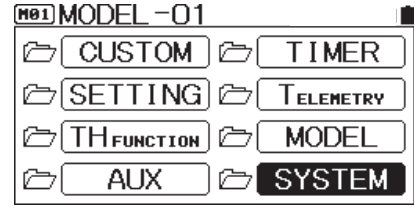

ENTER ↓ ↑ BACK

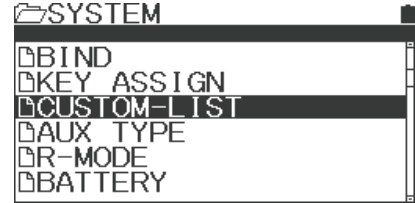

ENTER ↓ ↑ BACK

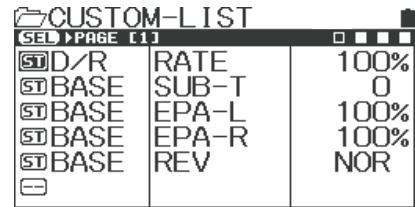

CUSTOM-LIST SETTING ↓

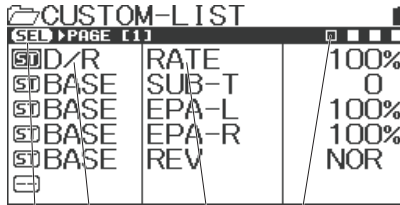
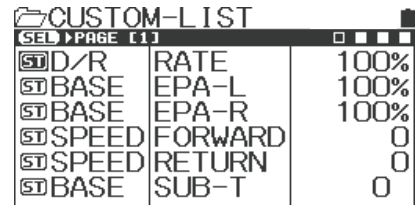

Channel Selection
Function Selection
Item Selection
Page Selection (Select Button)

*Custom List previously set for the type.
Customize the Custom List as you wish.
Depending on the feature/item, there are things you cannot set

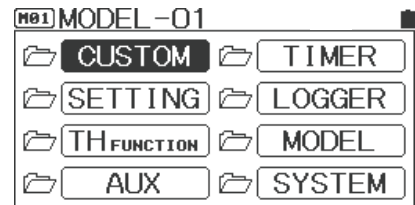

ENTER ↓ ↑ BACK

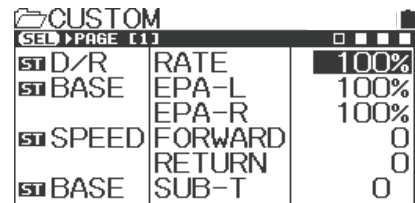

AUX TYPE

● A feature to set the performance of AUX1 and AUX2 (3ch and 4ch).

- 1) Select [SYSTEM] with the multi-selector and determine with the Enter operation.
- 2) Select [AUX TYPE] with the multi-selector and determine with the Enter operation.
- 3) Set AUX TYPE with the multi-selector.

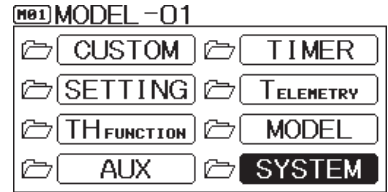

ENTER ↓ ↑ BACK

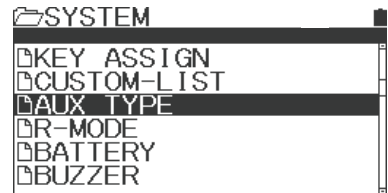

ENTER ↓ ↑ BACK

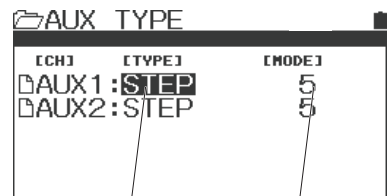

Switching Type Mode Type

○ Setting Items:

TYPE	MODE
STEP	1/2/5/10/20/25/50/100
POINT	2/3/4/5/6
4WS	2mode/3mode/4mode
MOA	1/2/5/10/20/25/50/100
AUX MIX	ST-mix/TH-mix
CODE5	USER/SVZ/SVD
CODE10	USER/SV-G/D/PGS/SGS-02

○ Default:AUX1:STEP MODE:5

AUX2:STEP MODE:5

*Action image of 4WS Mode setting

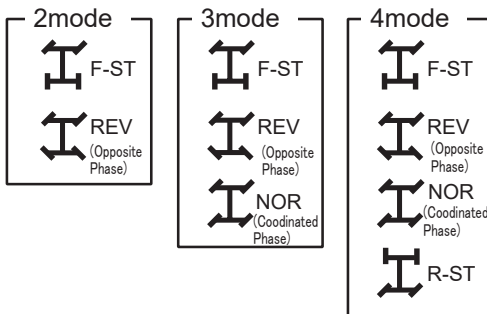

*For ST-mix, mixing is in effect from Steering onto AUX; for TH-mix, from Throttle onto AUX.

*When setting AUX TYPE to CODE, change of setting of the compatible equipment can be done from the transmitter. Compatible equipment like PGS servo series, SUPER VORTEX Series, and SGS-01C/ SGS-01D/ SGS-02.

*When AUX TYPE is set to CODE, do not connect any equipment that are not compatible to AUX1 and AUX2 (3ch and 4ch) of the receiver. If you connect equipment that is not compatible, the connected equipment will be failed.

*For POINT AUX, see P. 33, for CODE AUX, see P.36.

*CODE10 is a compatible feature to PGS Servo/SUPER VORTEX Gen2/Gen2 PRO/SV-D2/STOCK/SGS-02.

*When setting MODE to USER with CODE5/CODE10, you can freely register names of each item.

How to Use Each Feature

SYSTEM MENU

SYSTEM

RACING MODE

- A feature to adjust the running characteristics of your RC car by switching the Racing Mode so that the features compatible to the Racing Mode can respond to your RC car and road conditions.
- It allows you to set two setting values of R1 and R2 individually for features that are compatible to the Racing Mode for each Model Memory, and to change by the switches that are assigned during operation.
- As a default, ON/OFF of R-MODE is not assigned to the switch.

- 1) Select [SYSTEM] with the multi-selector and determine with the Enter operation.
- 2) Select [R-MODE] with the multi-selector and determine with the Enter operation.
- 3) Set the features that corresponds to the action of the Racing Mode with the multi-selector. Channel selection is done by the Select button.

○ Setting Range:
R-MODE: OFF/2
Compatible equipment: Each Feature ON/OFF

○ Default:
R-MODE: OFF
Compatible equipment: Each Feature OFF

○ Compatible Equipment:
ST/TH: D/R, SPEED, CURVE, TRIM
AUX: D/R, SPEED, CURVE, TRIM, AUX

- 4) By setting the feature of R-MODE onto the switch and operating during running, you can switch to the Racing Mode. The Assignments feature allows you to add changes to the Trim lever and the switch (P. 51, 52).
*Set according to a setting change of SUPER VORTEX, tire wear, change of the road condition.

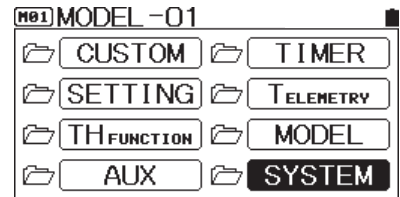

ENTER ↓ ↑ BACK

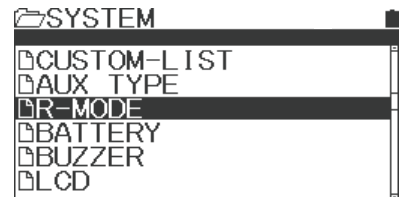

ENTER ↓ ↑ BACK



Channel Selection

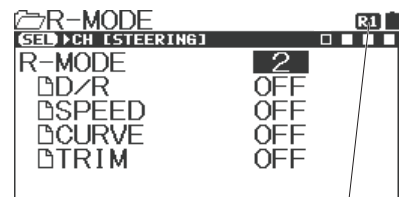

Racing Mode Display

BATTERY

- You can change the voltage setting of the battery alarm of the transmitter.
- By selecting Type [DRYx3 (Batteries)/Ni-MHx3 (Nickel Hydride)/Li-Pox1 (Lithium Polymer),CUSTOM], you can set the alarm easily.
*When selecting CUSTOM with the Type, you can set ALERT VOLT that sets voltage to make Alarm go off and LIMIT VOLT of the lower voltage.
- TH SLOW (Throttle Slow) is a feature to limit (50%) the operating quantity of the throttle's high side when the battery voltage of the transmitter becomes LIMIT VOLT (Fail-Safe feature).

- 1) Select [SYSTEM] with the multi-selector and determine with the Enter operation.
- 2) Select [BATTERY] with the multi-selector and determine with the Enter operation.

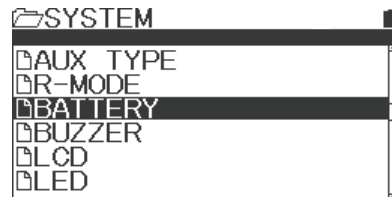

ENTER ↓ ↑ BACK

- 3) Setting TYPE
Set TYPE for the battery to be used with the multi-selector.

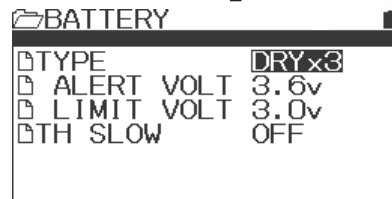

- Setting Range: DRYx3 (AAA x3)
Ni-MHx3 (Nickel Hydride)
Li-Pox1 (Lithium Polymer)
CUSTOM: ALERT VOLT:2.5 ~ 5.0v
LIMIT VOLT:2.7 ~ 5.0v
- Default: DRYx3 (AAA x3)

*MT-5 do not have automatic power off system. Please make sure turning off when finishing to use the transmitter.

BUZZER

- You can set operating sounds of key operation, Trim and Switch and the buzzer scales.
- For key operation only, you can set the first and last half of the operation sound.
- You can set 5 steps of the volume and 7 types of scales.

- 1) Select [SYSTEM] with the multi-selector and determine with the Enter operation.
- 2) Select [BUZZER] with the multi-selector and determine with the Enter operation.

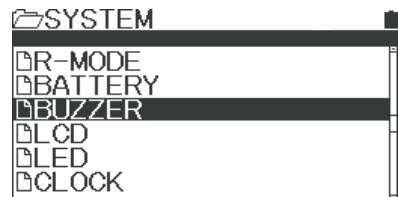

ENTER ↓ ↑ BACK

- 3) Setting Tone and Volume
You can switch between Tone (scales) and Volume (Sound Volume) with Select button operation. Select an item to change setting to adjust.

- Setting Range: KEY-CLICK
TLM1-ALERT
TLM2-ALERT
VOLT-ALERT
TIMER
INTERVAL
LAP-NAVI

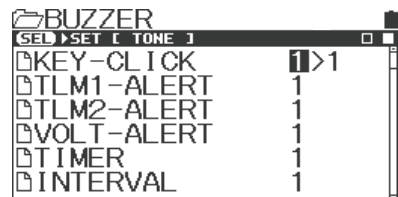

ENTER ↓ ↑ BACK

*You can set the first and last half of the operation sound for KEY CLICK tone (scales).

- Setting Range: TONE 1~7
VOLUME OFF ~ 5
- Default: VOLUME 4
TONE 1 [KEY CLICK 2→1]

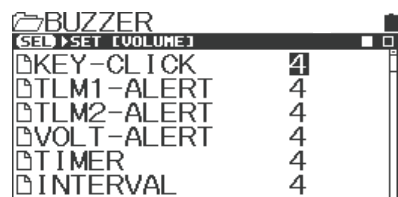

How to Use Each Feature

SYSTEM MENU

SYSTEM

LCD

- You can set LCD (Liquid Crystal) contrast (intensity), brightness and lighting mode (lighting time) of Back Light.
- 1) Select [SYSTEM] with the multi-selector and determine with the Enter operation.
- 2) Select [LCD] with the multi-selector and determine with the Enter operation.
- 3) Set LCD (Liquid Crystal Display) contrast (intensity), brightness and lighting mode (lighting time) of Back Light.
*In some contrast, you may not see screen display.
- Setting Items: CONTRAST (Intensity of Display)
BRIGHT (Brightness of Display)
LIGHTS-MODE (Backlight Lighting Mode)
LIGHT-TIME (Backlight Lighting Time)
- Setting Range: CONTRAST:0~30
BRIGHT:0~10
LIGHT-MODE:OFF/KEY-ON/ALWAYS
LIGHT-TIME:1~30sec
- Default: CONTRAST:15
BRIGHT:8
LIGHT-MODE:KEY-ON
LIGHT-TIME:10sec

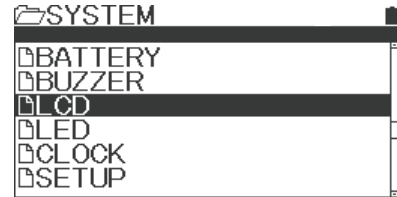

ENTER ↓ ↑ BACK

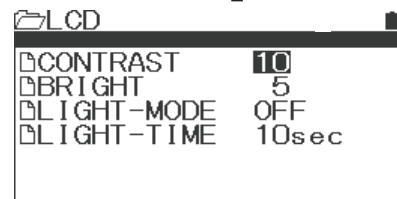

LED

- A feature to adjust the operating mode and brightness of the function LED installed on the transmitter body.
- 1) Select [SYSTEM] with the multi-selector and determine with the Enter operation.
- 2) Select [LED] with the multi-selector and determine with the Enter operation.
- 3) Set the operating mode and brightness of the Function LED.
- Setting Items: MODE(Operating Mode)
BRIGHT(Brightness of LED)
- Setting Range: MODE:ALWAYS/WAVE/OFF
BRIGHT:0~10
*BRIGHT is only for setting ALWAYS
- Default: MODE:WAVE
BRIGHT:10

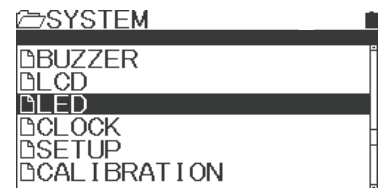

ENTER ↓ ↑ BACK

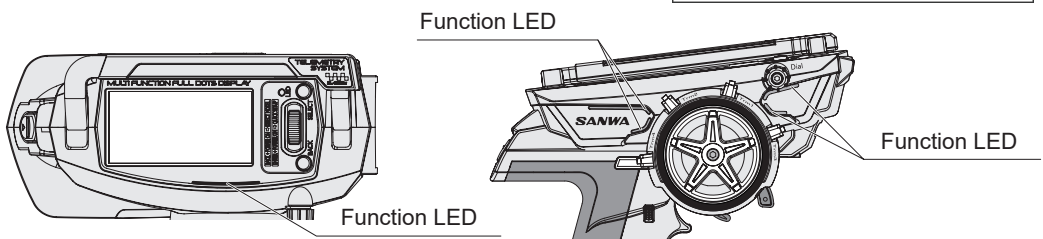
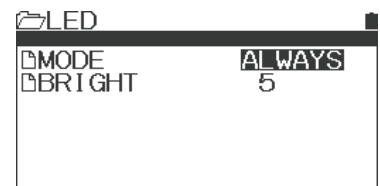

CLOCK

- A menu to control the calendar and the clock display on the top screen and the time used.
- There are resettable [ON TIME1] that is a guideline for replacing and recharging the batteries and [ON TIME2] that is a guideline for overhaul of the main body unit.

- 1) Select [SYSTEM] with the multi-selector and determine with the Enter operation.
- 2) Select [CLOCK] with the multi-selector and determine with the Enter operation.
- 3) Set the CLOCK feature with the multi-selector. Because setting the clock is necessary for managing log data, make sure to set the calendar and the clock.

*Holding Enter Key on ON TIME1 will be reset clock setting. Confirmation display will show up, please select YES when reset the setting.

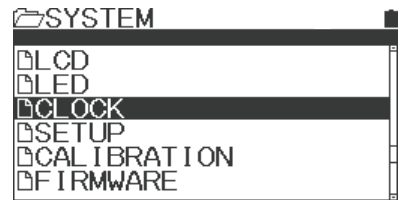

ENTER ↓ ↑ BACK

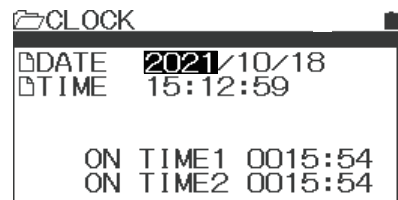

SETUP

- Select a language for the screen display during setting up and set up the unit of the temperature display for Telemetry data and the opening logo display when the power switch is turned on.

- 1) Select [SYSTEM] with the multi-selector and determine with the Enter operation.
- 2) Select [SETUP] with the multi-selector and determine with the Enter operation.
- 3) Select items to set with the multi-selector and adjust.

- Setting Items: LANGUAGE(Display Language):ENG/JPN
UNIT(Unit of the temperature for Telemetry):°C/°F
BOOT(Opening logo when the power switch is turned on):DEMO/NONE
RESUME (Resume):OFF/ON
- Default: LANGUAGE:ENG
UNIT:°C
BOOT:DEMO
RESUME:OFF

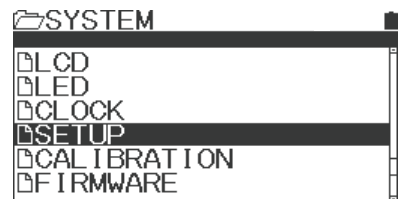

ENTER ↓ ↑ BACK

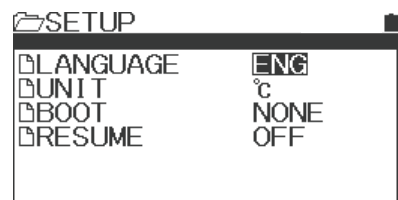

*When Resume is set to ON, it memorizes the menu at the time when power is turned off.

How to Use Each Feature

SYSTEM MENU

SYSTEM

CALIBRATION

- Due to wearing and tearing of the internal mechanical elements over the usage time, the neutral position and the operation angle might become off. In such case, you can correct the neutral positions of the steering and the throttle and the operation angle.

- 1) Select [SYSTEM] with the multi-selector and determine with the Enter operation.
- 2) Select [CALIBRATION] with the multi-selector and determine with the Enter operation.
- 3) Select a channel to calibrate with the multi-selector and determine with the Enter operation.
- 4) When selecting [STEERING], operate the Enter with the steering wheel in neutral, then operate the steering wheel fully to left and right.
- 5) When entering the range, [OK] is displayed. Operate following the display.
- 6) When calibration is done, [Executed] is displayed.
- 7) If the throttle side also needs calibration, refer to the steering to set.

*Unless necessary, do not set up calibration. If the setting is not done properly, it may not operate normally.

- About Steering wheel angle adjustment
MT-5 can adjust steering wheel angle. Please take off wide steering pad and put hex screws in accessory box on holes of steering wheel (there are 2 holes at steering wheel). Please adjust steering angle by the hex screws. (*Both screws height must be equally).

*After adjusting steering wheel angle, Calibration is required.

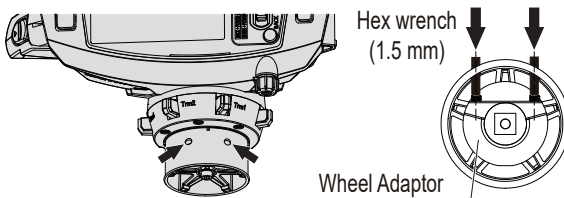

SUPPLEMENT

- If not correctly working after calibration, please calibrate again or setting changes USER to FACTORY. If the operation does not return to normal after calibration, contact Sanwa Service.
- In case steering wheel angle was too narrow, calibration will not be able to work correctly. Please do NOT extremely tight hex screws for steering wheel angle adjustment.
- When changing back angle to default, please loose hex screws until do not touch the steering base. After loosening the hex screws, please do calibration again.
- Please do CALIBRATION when changing steering, throttle tension, or some parts for steering or throttle.

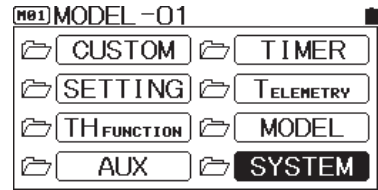

ENTER ↓ ↑ BACK

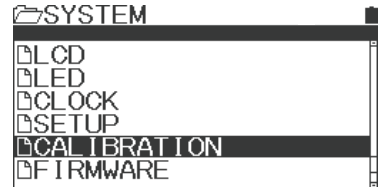

ENTER ↓ ↑ BACK

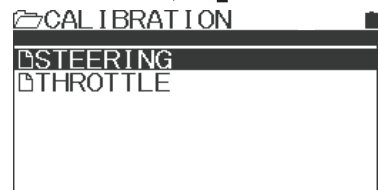

ENTER ↓

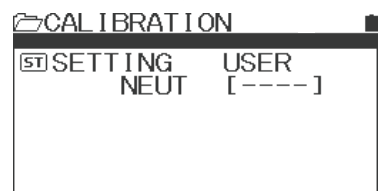

ENTER ↓

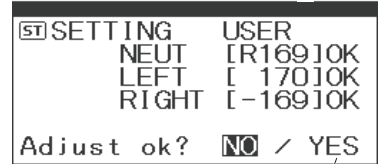

Select Yes, if it is OK.

Yes Selected. ↓

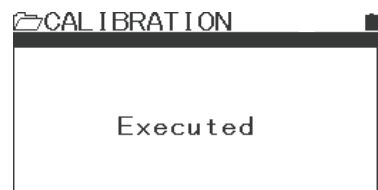

Calibration complete

FIRMWARE

● You can check the firmware version installed on the main body unit and the language file, and run updating.

- 1) Select [SYSTEM] with the multi-selector and determine with the Enter operation.
- 2) Select [FIRMWARE] with the multi-selector and determine with the Enter operation.
- 3) When updating the firmware and the language file, download the data file onto the micro SD card to proceed.

*Update folder will be created to enter UPDATE on FIRMWARE and LANG.FILE in case of inserting Micro SD card without update folder.

*Compatible Micro SD card capacity is maximum 32GB. Other manufacture Micro SD card might not be able to use. Please use Micro SD card by SANWA.

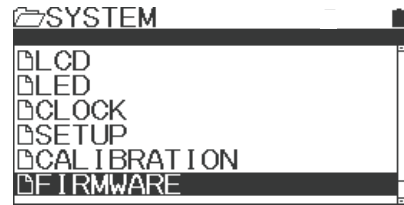

ENTER ↓ ↑ BACK

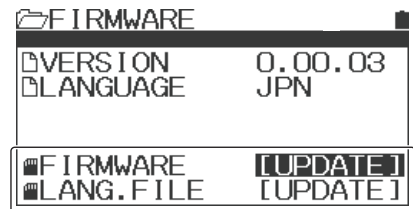

Unless you insert a micro SD card, it will not be displayed.

Assign Function List

Screen Display	Name of the Features	TRIM/Dial	SW1	SW2
OFF	— — — (No assigned feature)	○	○	○
ASSIST-ST	Steering Drive Assistance	—	○	○
TRIM-ST	Steering Trim	○	—	—
TRIM-TH	Throttle Trim	○	—	—
TRIM-A1	AUX1 Trim	○	—	—
TRIM-A2	AUX2 Trim	○	—	—
D/R-ST	Steering Dual Rate	○	○	○
D/R-TH	Throttle Dual Rate	○	○	○
D/R-BR	Brake Dual Rate	○	○	○
CUR-ST	Steering Curve	—	○	○
CUR-TH	Throttle Curve	—	○	○
CU-R-ST	Steering Curve Rate	○	—	—
CU-R-TH	Throttle Curve Rate	○	—	—
CU-R-BR	Brake Curve Rate	○	—	—
SPD-ST	Steering Speed	—	○	○
SPD-TH	Throttle Speed	—	○	○
SP-ST-F	Steering Speed Forward	○	—	—
SP-ST-R	Steering Speed Return	○	—	—
SP-TH-F	Throttle Speed Forward	○	—	—
SP-TH-R	Throttle Speed Return	○	—	—
ALB	Anti-Lock Brake	—	○	○
ALB-PO	Anti-Lock Brake Point	○	—	—
ALB-ST	Anti-Lock Brake Stroke	○	—	—
ALB-LG	Anti-Lock Brake Lag	○	—	—
ALB-CY	Anti-Lock Brake Cycle	○	—	—
OFFSET	Offset	○	○	○
AUX1	AUX1	○	○	○
AUX1[CD1]	AUX1[Code1]	○	—	—
AUX1[CD2]	AUX1[Code2]	○	—	—
AUX1[CD3]	AUX1[Code3]	○	—	—
AUX1[CD4]	AUX1[Code4]	○	—	—
AUX1[CD5]	AUX1[Code5]	○	—	—
AUX1[CD6]	AUX1[Code6]	○	—	—
AUX1[CD7]	AUX1[Code7]	○	—	—
AUX1[CD8]	AUX1[Code8]	○	—	—
AUX1[CD9]	AUX1[Code9]	○	—	—
AUX1[CD10]	AUX1[Code10]	○	—	—
AUX2	AUX2	○	○	○
AUX2[CD1]	AUX2[Code1]	○	—	—
AUX2[CD2]	AUX2[Code2]	○	—	—
AUX2[CD3]	AUX2[Code3]	○	—	—
AUX2[CD4]	AUX2[Code4]	○	—	—
AUX2[CD5]	AUX2[Code5]	○	—	—
AUX2[CD6]	AUX2[Code6]	○	—	—
AUX2[CD7]	AUX2[Code7]	○	—	—
AUX2[CD8]	AUX2[Code8]	○	—	—
AUX2[CD9]	AUX2[Code9]	○	—	—
AUX2[CD10]	AUX2[Code10]	○	—	—
TIMER	Timer	—	○	○
MAX-CLR	Telemetry MAX Clear	—	○	○
CUSTOM	CUSTOM	—	○	○
RX-MODE	R-MODE	—	○	○

Settable・・・「○」 Not Settable・・・「—」

Indicator Function (RX-DATA)

- MT-5 can check signal receiving conditions to use with RX-493i.
The conditions can be used for devices glitch and checking receiver place on the car.

There are 2 different types of data for checking signal condition.

Received Signal Strength (RSS)

Indicate signal strength which receiver received from the transmitter.

The value will be changed by placing of receiver and antenna, RC circuit, places of operation.

Please take care the value is not decreasing when driving on circuit first time or replacing receivers.

Packet Delivery Ratio (PDR)

Indicate packet delivery ratio which receiver received from the transmitter.

Values might be decreased when a lot of driver drive as the same time or using another 2.4 GHz devices at the same time.

In case of too low RSS values, PDR values are also decreased.

How to set and check data

- 1) Received Signal Strength (RSS) Setting
Select TELEMETRY SETTING in Telemetry menu by multi-selector, then press enter.
Change RX-DATA at DATA-TYPE (in TLM1)
- 2) Received Signal Strength (RSS) Setting
Select TELEMETRY SETTING in Telemetry menu by multi-selector, then press enter.
Change RX-DATA at DATA-TYPE (in TLM2)

After complete setting, go to the Telemetry display and can see RSS and PDR in the display.

Telemetry Display

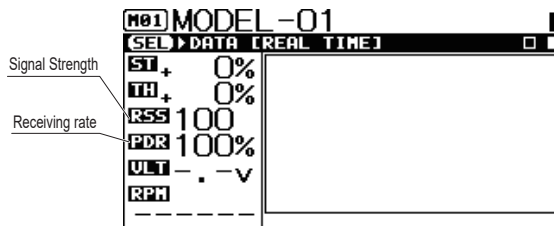

About reference values

In case RSS is below 20, please check receiver where and how placed on the car.

Please change the receiver place to increase RSS values.

*Please refer on p.1 and p.9 for receiver replacing.

In case PDR is below 40, please turn off and restart the transmitter. Then, please check PDR values again.

*About telemetry data

In case telemetry data displays "---", transmitter does not receive telemetry data from receiver.

This does not indicate about receiver does not works and receiver does not receive transmitter signal.

Due to telemetry data signal from receiver is not stronger than transmitter signal, transmitter may not get telemetry data from receiver due to distance which signal from receiver cannot reach.

Telemetry data on transmitter may display as "---" in this case.

In case of showing "---" on the transmitter, please check to see car movement by transmitter operation.

INDEX

A	
Anti-Lock Brake [ALB]	P.31
AUX	P.33-36
AUX Mixing [AUX-MIX]	P.35
B	
BASE	P.26
BATTERY	P.56
BIND	P.49, P.50
BUZZER	P.56
C	
CALIBRATION	P.59
CODE AUX	P.36
Curve [CURVE]	P.21-24
D	
DOWN TIMER	P.39
Dual Rates [D/R]	P.19
E	
End Point Adjustment [EPA]	P.27, P.28
F	
Fail Safe [F/S]	P.25
4-Wheel Steering [4WS]	P.34
G	
GRAPH SETTING	P.44
I	
Interval Timer [INT TIMER]	P.39
K	
Key Assignments Switch [KEY ASSIGN SW]	P.51
Key Assignments Trim [KEY ASSIGN TRIM]	P.52
L	
LAP TIMER	P.38
LCD	P.57
LED	P.57
M	
MODEL	P.45-48
MODEL CLEAR	P.48
MODEL COPY	P.47
MODEL NAME	P.46
MODEL SELECT	P.45
Motor On Axel [MOA]	P.34
O	
Offset	P.32
P	
POINT AUX	P.33
Q	
QUICK SETUP	P.17, P.18
R	
Reverse [REV]	P.26
RX-DATA	P.62
S	
SETTING	P.19-32
SPEED	P.20
STEP AUX	P.33
SUB TRIM	P.26
SYSTEM	P.49-60
T	
TELEMETRY SETTING	P.43
TELEMETRY SWITCH	P.44
Throttle Type [TH TYPE]	P.32
TIMER	P.37-39
TRIM	P.29, P.30

When this happens...

Symptom	Cause	Measure
There is no power.	Batteries are consumed. Batteries are placed improperly.	Replace with new batteries or recharged batteries. Reinstall the batteries as the polarity is indicated.
Power is cut off occasionally.	Bad connection of connectors.	Bring to Sanwa Service
Insufficient length	Batteries are consumed.	Replace with new batteries or recharged batteries. If the problem cannot be solved, please contact Sanwa Service
Alarm will not stop.	Battery voltage of the transmitter is decreasing.	Replace with new batteries or recharged batteries.
There is no click sound when pressing the key.	Volume of the BUZZER feature is OFF (0).	Check BUZZER feature (P.56).
The servo speed is slow.	SPEED feature is set to minus.	Check SPEED feature (P.20).
	Battery voltage of the receiver is decreasing.	Replace with new batteries or recharged batteries.
	Linkage of the car body side is heavy.	Check if the Linkage of the car body side moves lightly.
Rudder angles of left and right are different even when they are aligned.	Trim neutral is not aligned.	Align Trim and reset EPA. (P.29, 30)
When operating, the servos will not work on both ends	Rudder angle settings of D/R and EPA are too large.	Set either value to below 100%. (P. 19, 27, 28)
The servo will not move when operating Trim.	One side of the Trim movement range is full.	Reset the servo horn and the Trim center. (P. 29. 30)
Not working even if turning on transmitter and receiver.	Bind is not completed. Different Model-Data and Safety Link No.	Please check Model-Data and Safety Link No. on transmitter. Please bind with receiver.

Service and Support

This is warranted against manufacturer defects in materials and workmanship, at the original date of purchase. This warranty does not cover components worn by use or damage caused by improper voltage, tempering, modification, misuse, abuse, improper wiring, reverse polarity, moisture or using outside its intended scope of use.

Terms of this warranty can vary by region. Please read the warranty card included with your radio control system for specific warranty information.

If you have any questions or concerns, we're here to help. If you encounter a problem with your radio control system, first check the Troubleshooting Guide on Page 64.

If you require further help that cannot be solved using The Troubleshooting Guide, or if you have technical questions, please contact SANWA service center in your region.

For a complete list of distributors in your region, please visit www.sanwa-denshi.com/rc/distributors.html.

For Service In North America:

Serpent America

5121 NW 79 Ave. Unit 03,
Doral, Florida 33166 USA

Telephone: (305)-677-3253

Fax: (305)-675-0415

Email: info@serpentamerica.com

Factory Service:

Sanwa Electronic Instrument CO., LTD.

1-2-50 Yoshita-Honmachi
Higashiosaka, Osaka, 578-0982 Japan

Telephone: 81-729-62-1277

Fax: 81-729-64-2831

Email: rcintl@sanwa-denshi.co.jp

Product features and specifications can vary by region. Not all products are legal for use in all regions.



Please note that products purchased outside of North America cannot be serviced under warranty by Serpent America. In some cases, we can make repairs for products purchased outside of North America, however, applicable repair costs and shipping charges will be applicable. For warranty claims outside North America, please contact the service center in your region.

FCC COMPLIANCE STATEMENT

This equipment has been tested and found to comply with the limits for a Class B digital device, pursuant to Part 15 of the FCC Rules. These limits are designed to provide reasonable protection against harmful interference in a residential installation. This equipment generates, uses, and can radiate radio frequency energy and, if not installed and used in accordance with the operating instructions, may cause harmful interference to radio communications. However, there is no guarantee that interference will not occur in a particular installation. If this equipment does cause harmful interference to radio or television reception, which can be determined by turning the equipment OFF and ON, the user is encouraged to try to correct

the interference by one or more of the following measures:

- Reorient or relocate the receiving antenna.
- Increase the separation between the equipment and the receiver.
- Connect the equipment into an outlet on a circuit different from that to which the receiver is connected.
- Consult the dealer or an experienced technician for help.

This device complies with Part 15 of the FCC Rules. Operation is subject to the following two conditions:

- 1) This device may not cause harmful interference, and...
- 2) This device must accept any interference received, including interference that may cause undesired operation.



Changes or modifications made to this equipment not expressly approved by SANWA may void the FCC authorization to operate this equipment.

RF Exposure Statement:

This transmitter has been tested and meets the FCC RF exposure guidelines when used with the SANWA accessories supplied or designated for this product, and provided at least 20cm separation between the antenna the user's body is maintained. Use of other accessories may not ensure compliance with FCC RF exposure guidelines.



SANWA ELECTRONIC INSTRUMENT CO., LTD.

**1-2-50 Yoshita-Honmachi
Higashiosaka, Osaka, 578-0982 Japan**

Telephone: 81-729-62-1277

Facsimile: 81-729-64-2831

Email: general@sanwa-denshi.co.jp

Features and Specifications are Subject to Change Without Notice.

All contents © 2021 Sanwa Electronic Instrument Co., LTD

All Rights Reserved. Revision 1 9.30.2021

670A14982A