

Tribeca *Aleternum*[®]



Low thermal inertia



Low water consumption



Versatility



Working pressure



Available in 24 colors



CE¹⁴



Radiator Tribeca: without decoration

Anticorrosion internal treatment *Aleternum*[®] provided.

All **TRIBECA** models are guaranteed **15 years** from installation date on manufacturing faults, provided that the installation has been performed in compliance with the current norms and respecting the instructions relating to the installation, the correct use and the correct maintenance as illustrated on this catalogue.

MODEL:	RADIATOR TYPE:
235 - 335 - 350 - 435 500 - 535 - 600	Radiator made of 4 to 20 sections
685 - 700 - 800 - 835	Radiator made of 4 to 16 sections
900 - 935 - 1000 1135 - 1200 - 1400	Radiator made of 4 to 9 sections
1435 - 1600 - 1735	Radiator made of 4 to 9 sections
1800 - 1935 - 2000	Radiator made of 4 to 12 sections

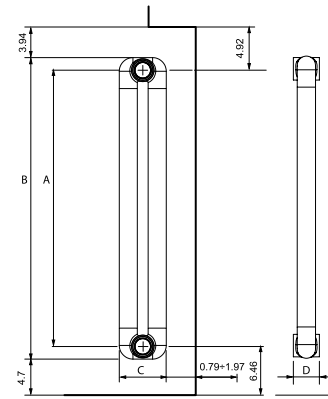

Model	Heat output				
	WT 122°F	WT 140°F	WT 158°F	WT 176°F	WT 194°F
	Btu/h per section				
235	54.7	78.7	104.4	131.5	159.9
335	71.9	103.9	138.2	174.5	212.6
350	74.3	107.3	143.0	180.4	219.7
435	87.5	126.6	168.6	213.1	259.8
500	97.4	141.1	188.0	237.9	290.2
535	102.7	148.8	198.6	251.1	306.4
600	112.4	163.1	217.7	275.7	336.5
685	125.1	181.7	242.9	307.7	375.9
700	127.3	185.0	247.4	313.3	382.8
800	142.0	206.7	276.7	350.9	429.2
835	147.1	214.3	287.0	364.1	445.4
900	156.8	228.5	306.1	388.5	475.4

Model	Heat output				
	WT 122°F	WT 140°F	WT 158°F	WT 176°F	WT 194°F
	Btu/h per section				
935	162.0	236.1	316.3	401.6	491.5
1000	171.7	250.3	335.4	426.1	521.5
1135	191.8	279.9	375.3	477.1	584.2
1200	204.5	298.6	394.8	509.3	623.8
1400	231.6	338.6	454.8	578.7	709.4
1435	237.0	346.6	465.4	592.1	725.8
1600	262.9	384.3	515.9	656.1	804.0
1735	284.5	415.6	557.5	709.1	868.8
1800	295.0	430.9	578.0	734.9	900.4
1935	317.0	462.9	620.7	789.1	966.5
2000	327.8	478.5	641.8	815.5	998.7

Model	Depth	Height	Centre distance	Length mm/elem	Connection diameters	Water content
	(C) inches	(B) inches	(A) inches	(D) inches	inches	gallons
235	3.54	11.18	9.25	1.97	G1	0.11
335	3.54	15.12	13.19	1.97	G1	0.15
350	3.54	15.71	13.78	1.97	G1	0.19
435	3.54	19.06	17.13	1.97	G1	0.22
500	3.54	21.61	19.69	1.97	G1	0.25
535	3.54	22.99	21.06	1.97	G1	0.26
600	3.54	25.55	23.62	1.97	G1	0.29
685	3.54	28.90	26.97	1.97	G1	0.30
700	3.54	29.49	27.56	1.97	G1	0.31
800	3.54	33.43	31.50	1.97	G1	0.35
835	3.54	34.80	32.87	1.97	G1	0.36
900	3.54	37.36	35.43	1.97	G1	0.40
935	3.54	38.74	36.81	1.97	G1	0.41
1000	3.54	41.30	39.37	1.97	G1	0.44
1135	3.54	46.61	44.69	1.97	G1	0.50
1200	3.54	49.17	47.24	1.97	G1	0.52
1400	3.54	57.05	55.12	1.97	G1	0.60
1435	3.54	58.43	56.50	1.97	G1	0.62
1600	3.54	64.92	62.99	1.97	G1	0.69
1735	3.54	70.24	68.31	1.97	G1	0.75
1800	3.54	72.80	70.87	1.97	G1	0.78
1935	3.54	78.11	76.18	1.97	G1	0.82
2000	3.54	80.67	78.74	1.97	G1	0.85

Maximum working pressure: 232 psi

EXAMPLE EXTRAPOLATION CODE:

TRIBECA radiator 600 from 10 sections gloss White colour.

Es: EA20C0 + 04 + 10

TRIBECA radiator 600 from 12 sections gloss Ardesia colour.

Es: EA20C0 + 2B + 12

To obtain the radiator code, it is necessary to add to the code the four final numbers concerning the finishing and the desired colour.

Model	TRIBECA	
	Code	Finishing/Colour
235	EA21A0	XX XX*
335	EA21B0	
350	EA20A0	
435	EA21C0	
500	EA20B0	
535	EA21D0	
600	EA20C0	
685	EA21E0	

Model	TRIBECA	
	Code	Finishing/Colour
700	EA20D0	XX XX*
800	EA20E0	
835	EA21F0	
900	EA20F0	
935	EA21G0	
1000	EA20G0	
1135	EA21H0	
1200	EA20H0	

Model	TRIBECA	
	Code	Finishing/Colour
1400	EA20I0	XX XX*
1435	EA21I0	
1600	EA20L0	
1735	EA21L0	
1800	EA20M0	
1935	EA21M0	
2000	EA20N0	

COLOURS

All colours are available in four finishes:





- GLOSS
- MATT
- TEXTURED MATT
- PEARL

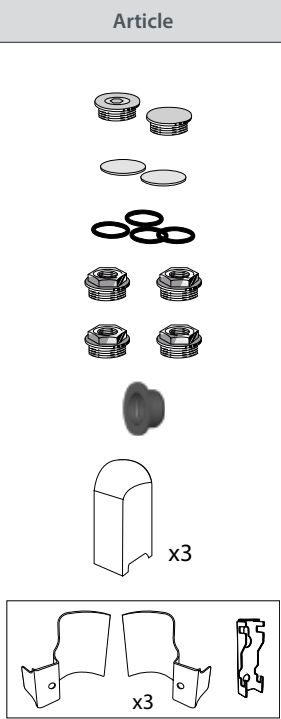



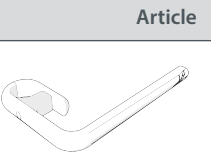







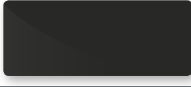
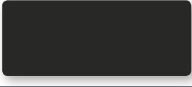

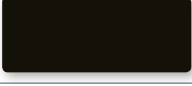
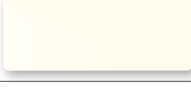
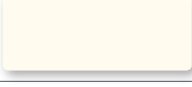
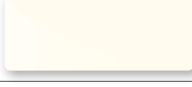
The colours shown are merely indicative and not binding, as they may slightly differ, due to the printing process.

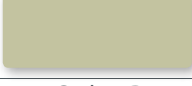
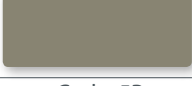
*The two final numbers change according to chosen finishing/colour.

Article	Description	Code	Colour
	Special fixing kit with white pincers + plugs and adapters: 1 Flat ½ bleed valve 2 White plastic cover 1 Flat ½ plug 2 White ½ rh adapter 2 White ½ lh adapter 1 Bag with 3 metal sheet brackets 1 Bag with 3 white plastic covers 3 White rh pincers 3 White lh pincers 4 O-ring seals 1" 1 Rubber retaining plug	550122	Withe
		550122MP	Withe - Pearl
		550122L	Corvino textured matt
		550122LL	Corvino glossy
		550122NP	Pearl glossy
		550122NL	Pearl glossy
		550122NO	Pearl matt
		550122DL	Organza glossy
		550122DO	Organza matt
		550122PO	Turtle matt
		550122P	Turtle textured matt
		550122CL	Copper glossy
		550122C	Copper textured matt
		550122FL	Silver glossy
		550122F	Silver textured matt
		550122EL	Ardesia glossy
		550122E	Ardesia textured matt
		550122BL	Rubino glossy
		550122H	Helois textured matt
		550122IL	Turquoise beach glossy
550122R	Grafite textured matt		
550122SL	Terra bruciato glossy		
550122V	Black coffee textured matt		
550122T	Metropolitan textured matt		

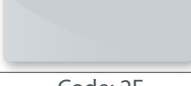
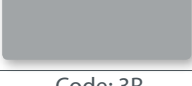
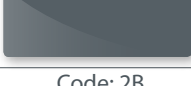
Coloured versions:
45% price increase on the price of a gloss White RAL 9010.

Article	Code	Description
	570125	Towel rack kit, with decoration, mm 237
	570126	Towel rack kit, with decoration, mm 337
	570127	Towel rack kit, with decoration, mm 437
	570128	Towel rack kit, with decoration, mm 537
	A 30/2 521011M	Rubber lockshield plug Mood-Tribeca (water diaphragm)
	A 32/1 530102	O-ring seal for nipples, plugs and adapters
	A74 550120	Fixing kit for horizontal installation, colour white (4 pieces package)
	A75 550121	Fixing kit for horizontal installation, colour chrome (4 pieces package)

	GLOSS	MATT	TEXTURED MATT	PEARL
WHITE				
	Code: 04			Code: 4M
CORVINO				
	Code: 2L		Code: 3L	
METROPOLITAN				
			Code: 3T	
BLACK COFFEE				
			Code: 3V	
PEARL				
	Code: 2N	Code: 5N		Code: 4N
ORGANZA				
	Code: 2D	Code: 5D		
TURTLE				
		Code: 5P	Code: 3P	
COPPER				
	Code: 2C		Code: 3C	
TERRA BRUCIATA				
	Code: 2S			
SILVER				
	Code: 2F		Code: 3F	
GRAFITE				
			Code: 3R	
ARDESIA				
	Code: 2B		Code: 3B	
RUBINO				
	Code: 2A			
HELOISE				
			Code: 3H	
TURQUOISE BEACH				
	Code: 2I			

Coloured versions: 45% price increase on the price of a gloss White RAL 9010.

