

ULTRAVIEW™

UV SLIDER™

Designed with enhanced ergonomics to provide lethal functionality, UV Slider™ is the ultimate bowhunting sight.

UV Slider™ establishes a new benchmark for sliding sights with innovations such as DualDial™, TripleMark™, and QuickBreak™ ensuring unparalleled precision. With these innovations, UV Slider™ allows you to stay focused in the moment.

MAP \$599.99

MOUNTING STYLE



BRIDGE-LOCK



SIDE MOUNT



PICATINNY



Scan for more information about UV Slider™.

DUALDIAL™

Driven by a concentric dial architecture with zero backlash and optimized gear ratio, UV Slider™ touts effortless adjustments with a single turn of the dial.

TRIPLEMARK™

A unified pin and indicator pairing solution that makes every pin a floating pin – guaranteeing precision at any distance. The indicator pins are ultra-fine and close to the tape for increased precision.

UV3XL™ SE

UV3XL™ Slider Edition offers superior functionalities and enhanced ease of use with an integrated, removable light cartridge for consistent pin brightness.

QUICKBREAK™

allows for quick breakdown of the sight and scope unit from the vertical rail, making traveling and cleaning easy for when distant hunts get dirty.



UV BUTTON™

UV Button™ is equipped with our new ULTRAGLIDE™ bushing technology resulting in an incredibly low maintenance, smooth, and reliable release. Designed to perfectly fit your hand - UV Button™ makes every shot comfortable and consistent.

With a wide range of travel and force adjustment, spring-actuated d-loop retainment, wrist strap slot, ergonomic contoured knob, rubber bumper silencing system and highly durable finish - nothing was spared and no detail overlooked on UV Button™.

UV Button™ also shares the same profile as The Hinge 2, making the switch between both releases seamless.

2 and 4 finger attachments sold separately.



ALUMINUM

MAP \$299.99

Medium: 3.1 oz
Large: 3.4 oz



STAINLESS STEEL

MAP \$349.99

Medium: 5.6 oz
Large: 6.2 oz



Scan for more information
about UV Button™.

ADJUSTABILITY

Micro-adjust wide ranges of force and travel. The force can be set feather-light or super-heavy without needing to swap springs.

STRING RETAINER

Allows you to keep UV Button™ on your string without it falling off, ensuring you're ready at all times - a must have for all hunters.

LANYARD SLOT

Inspired by the Hunting Bracket, the third finger has a lanyard slot for archers who prefer using a wrist lanyard.

DURABLE FINISH

Unmatched durable Smoke Gray and Matte Black finish options available.

CONTOUR KNOB

The Contour thumb knob has an ergonomic dished contour with non-slip spiral grooves - ensuring it fits your thumb while creating a tactile repeatable point of reference.



THE HINGE 2

With The Hinge 2, we started the design by first looking at the human hand. Your release hand is one of two sources of input to your bow -- making your release one of the most important equipment decisions you can make.

We measured hundreds of hands and researched how they work -- all the way down to the bone and muscle structure. The Hinge 2 release is truly one of the most comfortable releases you'll ever shoot; designed to fit your hand perfectly every time you draw your bow.

This consistent hand placement helps you develop rock-solid shot execution and tighter groups. Never let your release hang up again and improve your shot with The Hinge 2.

2 and 4 finger attachments sold separately.



ALUMINUM

MAP \$249.99

Medium: 2.2 oz
Large: 2.6 oz



STAINLESS STEEL

MAP \$299.99

Medium: 4.2 oz
Large: 5.1 oz

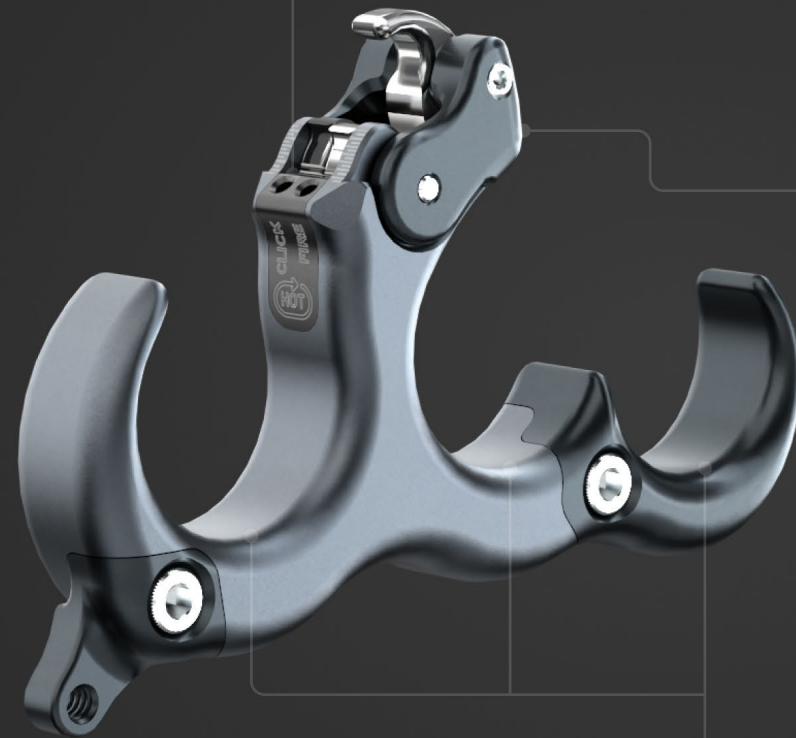

Scan for more information
about The Hinge 2.

MICRO-ADJUST CLICK & FIRE

A dual moon system allows you to micro-adjust the timing of both your click and fire moons.

DEADLY QUIET MAGNETIC HEAD RETENTION

Making it whisper quiet in the woods and always at the ready.

ACCESSORIES

Can be fitted with 2 and 4 finger attachments to customize your grip.

DESIGNED FOR COMFORT AND CONSISTENCY

The Hinge 2 has deliberate, ergonomic finger beds that fit your hand perfectly.



BEERREAL MATHEWS GRIP 2.0

We've engineered the BEERREAL 2.0 with a flat grip face, a deep rounded throat, and an overmolded rubber panel – all designed to enhance accuracy and moderate input – without sacrificing comfort.

The BEERREAL 2.0 grip body is molded from high-quality ceramic polymer composite so that the cold is never an issue.

MAP \$99.99

COLOR OPTIONS



BLACK



CARBON
GRAY



DUNE



OD
GREEN



Scan for more information
about BEERREAL 2.0.

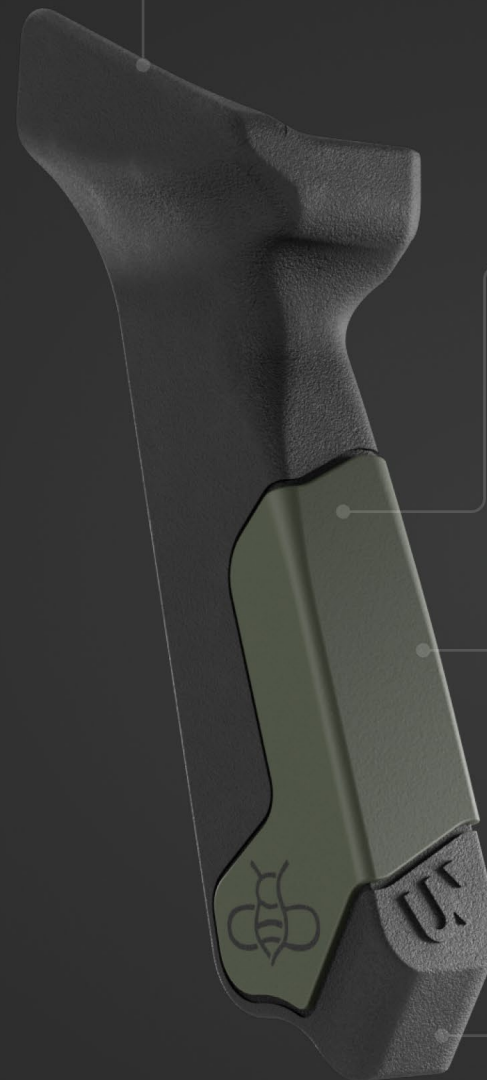

ARROW SHELF

Designed to help protect your fingers when in close proximity to arrows, as well as secure your arrows in place.

FLAT GRIP FACE

Designed with a flat grip face that contours into a deeply rounded grip throat that comfortably optimizes accuracy and consistency.

RUBBER OVERMOLDING

Specifically designed to provide excellent grip in adverse weather conditions, while retaining rigidity for consistency from shot to shot.

ENGINEERED POLYMER GRIP

Ceramic polymer grip body has excellent - thermal properties to stay warm to the touch, even in cold weather.



UV3XL™ SE

An acclaimed scope system optimized for UV Slider™.

The UV3XL™ Slider Edition enhances precision for bowhunters prioritizing field time. It pairs seamlessly with the UV Slider™ sight, featuring the UV Cartridge system for easy pin adjustments without losing sight marks.

The integrated light cartridge ensures consistent pin brightness in all conditions. Recognized for superior performance, this award-winning scope system redefines its category, enhancing your field effectiveness with unparalleled performance.

UV3XL™ SE also fits most major archery sights. See compatibility chart at the QR code below.

MAP \$249.99

KIT OPTIONS

HUNTING

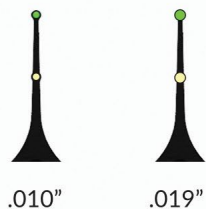

.010"

.019"

TARGET



0x, 2x, 4x, 6x, 8x



Scan for more information about UV3XL™ SE.



TECH INFO

41mm ID | Made from Aircraft Grade Aluminum | 100% Ambidextrous | Over 6hrs of battery life at 80% brightness

FINITE ADJUSTMENT

Our innovative 3-Pin design ensures no-jump adjustability and no lockdown slop.

3 PINS

Designed with a center-mounted fixed pin, 2 adjustable pins, and a bonus pin for extra distance.

Available As

UV3XL™ SE SCOPE KIT

This kit includes a 3 Pin cartridge mounted in UV3XL™ SE -- and everything you need to start shooting -- right out of the box.

EASY SWAPS

The centered fixed pin allows you to easily swap between single and double pin cartridges without losing your center mark.

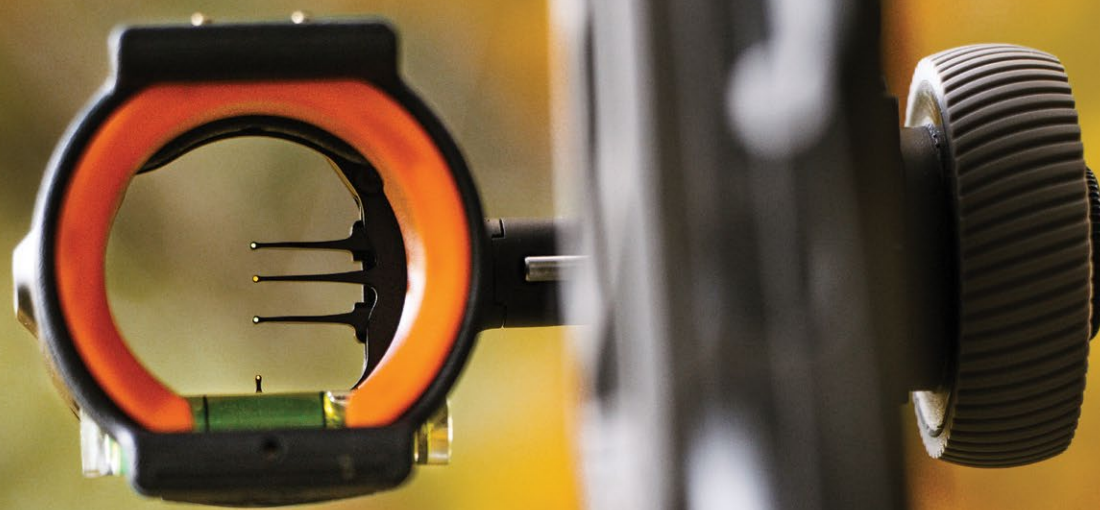

UV3™ SE

The UV3™ SE is designed for bowhunters who prioritize precision and maximizing their time in the field.

Thanks to the revolutionary UV Cartridge system, swapping pin-counts and pin-sizes is a breeze while maintaining your existing sight marks.

Moreover, the UV3™ SE features a seamlessly integrated light cartridge that can be effortlessly removed as needed, guaranteeing consistent pin brightness in any conditions.

Widely acclaimed for its exceptional performance, this award-winning scope sets a new benchmark in its category, offering unrivaled conveniences that significantly elevate your effectiveness on the hunt.

MAP \$249.99

KIT OPTIONS

HUNTING

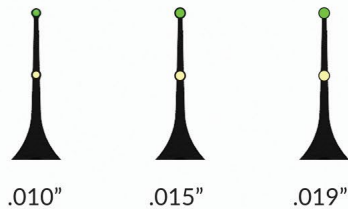

TARGET



0x, 2x, 4x, 6x, 8x



Scan for more information about UV3™ SE.

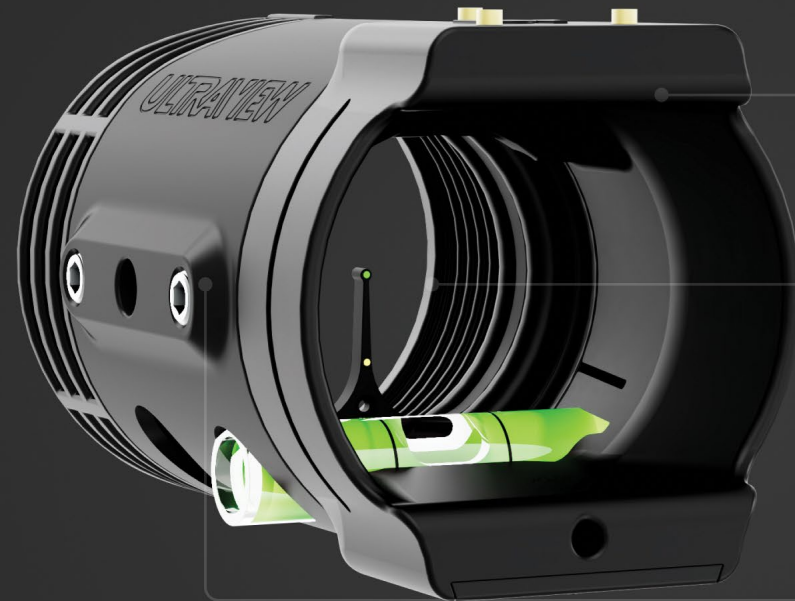

TECH INFO

30mm ID | Made from Aircraft Grade Aluminum | 100% Ambidextrous | Over 6hrs of battery life at 80% brightness



COMPACT INTEGRATED LIGHT

UV3™ SE and UV3XL™ SE are fitted with a fully-integrated, compact, and dimmable UV light to make pins glow.

CARTRIDGE SYSTEM

Easily swap cartridges for any shooting style or preference.

WATERPROOF

For use in adverse conditions.

UV3™ SE & UV3XL™ SE CARTRIDGE SYSTEM

The UV3™ SE and UV3XL™ SE scopes have a replaceable cartridge system that allows you to easily swap out cartridges without having to adjust your hunting pins or target dots.

Included with all scopes is the World Archery compliant "No-Light" cap that replaces the light cartridge. This will also make UV3™ SE and UV3XL™ SE legal in states that don't allow electronics on hunting setups.

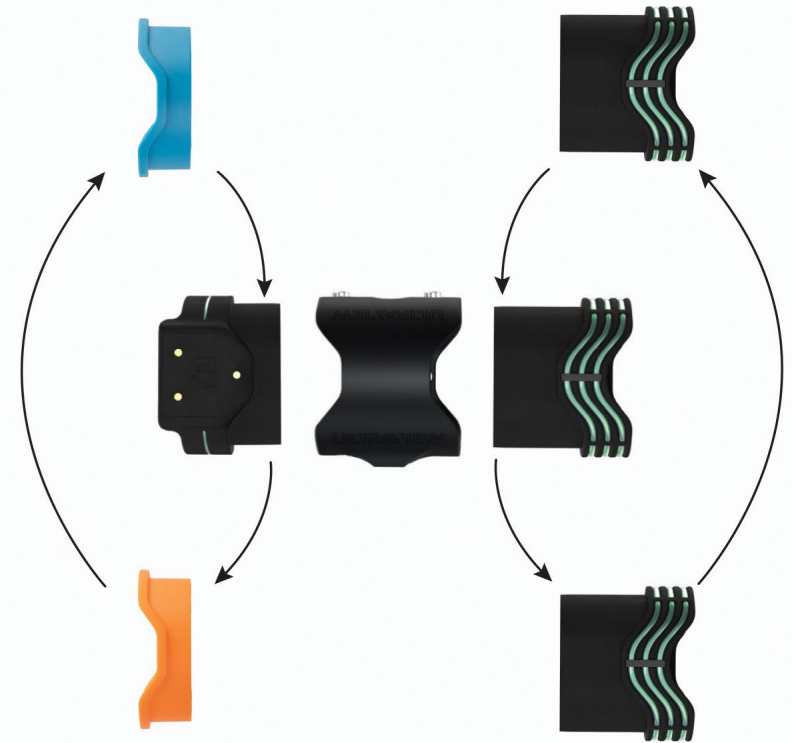

LIGHT CARTRIDGE & NO-LIGHT CAP

CARTRIDGES

TARGET CARTRIDGES

*Target kits come with multi-colored sticker kits for near limitless reticle combinations



HUNTING CARTRIDGES

3 PIN

Double Pin .019"

UV3™ SE ONLY
Double Pin .015"

Double Pin .010"

Single Pin .019"

Single Pin .010"



UV STABILIZER™

Precision and Power - Perfectly Balanced

UV Stabilizer™ is a high-performance stabilizer that delivers precision in every shot and power in every ounce.

On average, UV Stabilizer™ is 13% stiffer than bars with similar diameters. Its patent-pending UV QuickWeight™ system allows for quick and easy weight changes, making it a versatile choice for target archers of all styles.

UV Stabilizer™ is the ultimate choice for anyone looking to take their archery game to the next level. Proudly designed and built in America.



30"
MAP \$299.99



28"
MAP \$299.99



15"
MAP \$149.99



12"
MAP \$79.99



Scan for more information about UV STABILIZER™.

STIFFNESS

UV Stabilizer™ is 13% stiffer than the competitive average stiffness using the internal single fixed point testing method.

LIGHTNESS

UV Stabilizer™ is designed to be one of the lightest stabilizers on the market. The 30" bar-only weighs in at 5.17oz while the 15" bar- only weighs in at 3.25oz.

THIN DIAMETER

At .5", UV Stabilizer™ is extremely thin, allowing it to cut through the air with minimal drag, giving you a more stable and precise hold, even in harsh winds.

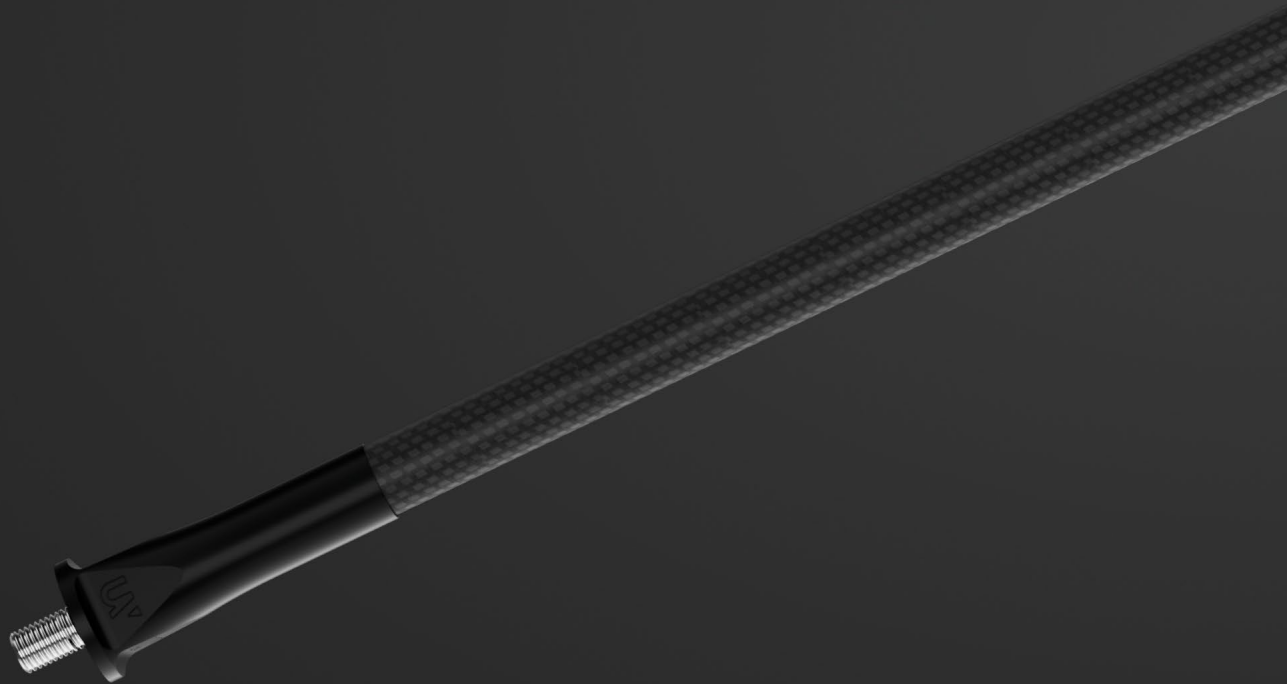

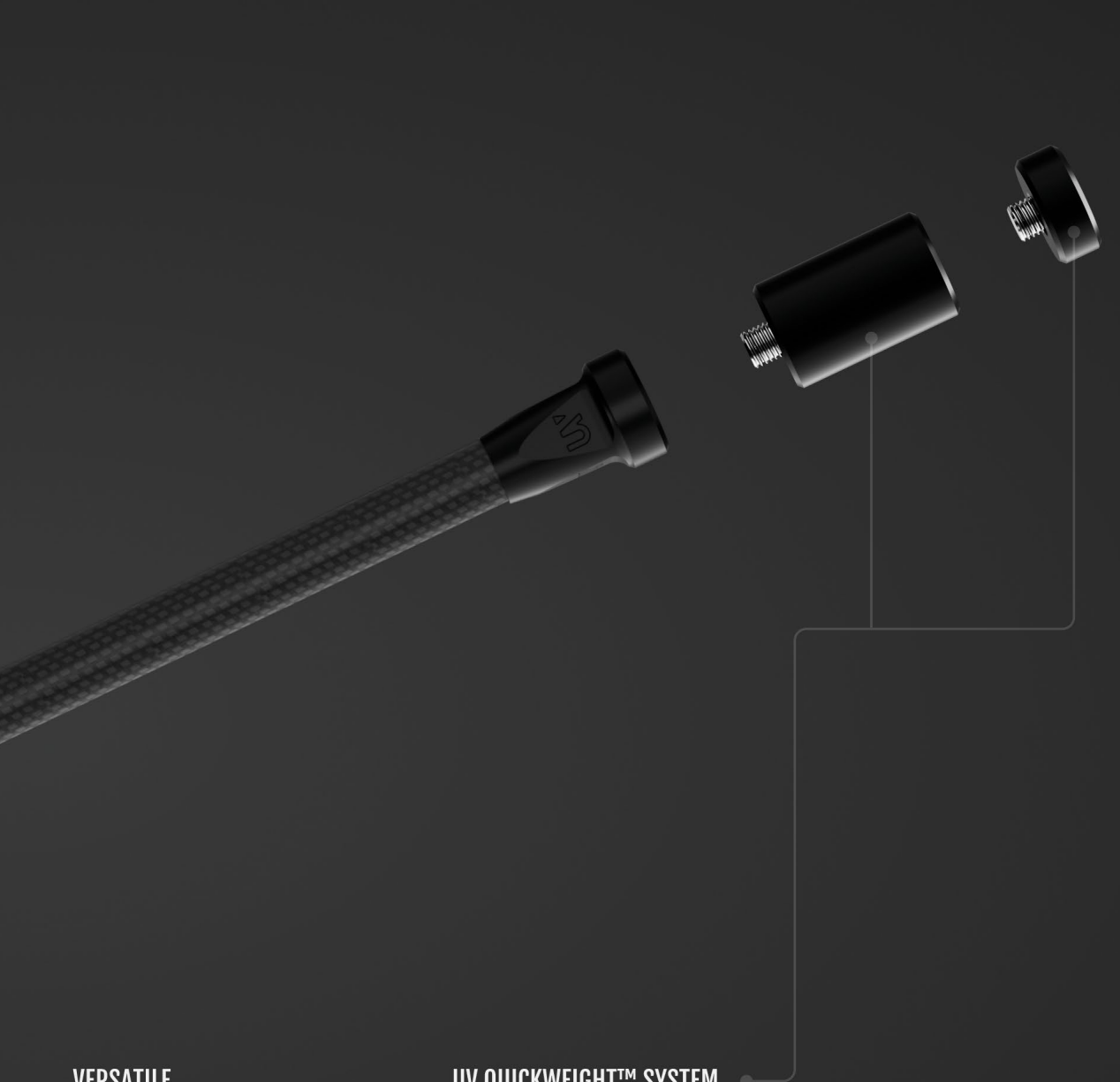

VERSATILE

The UV Stabilizer™ is compatible with a wide range of bows and archery styles, making it a versatile choice for any target archer looking to take their game to the next level.

UV QUICKWEIGHT™ SYSTEM

The patent-pending UV QuickWeight™ system allows for quick and easy weight changes without extra hardware and is coated in supremely durable PVD coating.

UV QUICKWEIGHT™

UV QuickWeight™ is an innovative, patent-pending stabilizer weight solution that streamlines weight changes without requiring extra hardware like set-screws or lengthy threaded rods.

Made from premium-grade stainless steel and coated with an ultra-durable PVD process, these weights have a flawless black finish.

With UV QuickWeight™, adjusting your stabilizer setup is effortless, convenient, and enjoyable. Experience the ultimate weight upgrade with UV QuickWeight™.



TUNGSTEN 4oz
MAP \$59.99



STEEL 1oz
MAP \$19.99



STEEL 4oz
MAP \$29.99



Scan for more information about UV QuickWeights™.

UV SIDE MOUNT™

UV Side Mount™ is a rear-mounting side mount designed for use with UV Stabilizers. Machined from top-quality aluminum, this mount provides an uncompromising stability that withstands the test of time.

Its wide range of adjustability allows for effortless customization, while the integrated T-slotted quick-disconnect feature simplifies the installation of the rear stabilizer.

In addition, UV Side Mount™ is expertly anodized to perfectly match UV Stabilizer™, delivering a seamless and cohesive look.

UV Side Mount™ is threaded with 5/16"x24 threads for compatibility with nearly all archery stabilizers.

MAP \$99.99



ADJUSTABLE

Effortlessly customize your set up with a wide range of finite adjustability.

TOUGH

The top-quality aluminum withstands the test of time.

T-SHAPE LOCKING NUT

Simplify installation with the integrated UV Quick Disconnect system.

STYLE

The anodized surface gives a clean finish that matches perfectly with UV Stabilizer™



Scan for more information about UV Side Mount™.

UV DOUBLET™ LENS

UV Doublet™ is the best-performing and highest-quality lens for 3D and Target Archery.

Single lenses deform light to magnify targets, a second lens – bonded in perfect lenticular plane to the first – balances light distribution and wavelengths to perfectly replicate the target down range.

You won't get color fringing (aberrations) or focus differences as you get farther from the optical center – UV Doublet™ is sharp edge to edge allowing you to shoot your absolute best.

MAP \$299.99



UV3™ LENS

1.35"



UV3XL™ LENS

1.75"



ACHROMATIC

Prevents aberrations (color fringing) for optimal edge-to-edge clarity.

MAGNIFICATION

Available in 2x, 4x, 5x, 6x and 8x magnifications.

EDGE-TO-EDGE SHARPNESS

Maintains consistent focus across the entire lens.

PRE-INSTALLED

UV Doublet™ comes pre-installed in a lens cartridge, ready to swap in to any existing UV3™ SE (1.35") or UV3XL™ SE (1.75").



Scan for more information about UV Doublet™.

ADDITIONAL POPULAR PRODUCTS



UV QUICK DISCONNECT

Outfitted with a t-shaped locking nut to ensure maximum lockdown while still allowing for easy removal, this is the perfect pair for UV Stabilizer™.

Available in 0 and 8 degree configurations.

MAP \$39.99



UV SCOPE ROD

We offer scope rods to ensure your UV3™ or UV3XL™ are compatible with your favorite slider sight.

MAP \$19.99

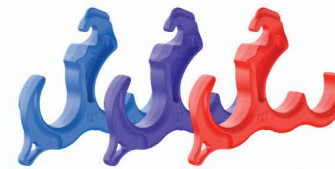

TRY BEFORE YOU BUY

Exact replica of UV Button™ and the Hinge 2.

This exact plastic replica of UV Button™ and The Hinge 2, allows you to see what it feels like before fully committing to buying the real thing. It is 100% free – just pay shipping! Feel how comfortable UV releases are at no extra cost! Only ships as size medium – if the medium feels too small you probably need a large.

MAP \$0.00



NO-LIGHT CAP

The No-Light Cap allows you to remove the light cartridge from your UV3™ or UV3XL™ SE to be compliant with local laws and regulations.

Add a bit of flare by choosing from 10 unique colors!

MAP \$19.99



2 & 4 FINGER ATTACHMENTS

Customize the UV Button™ and the Hinge 2 with these finger options.

The multi-finger attachments also let target archers fine tune the weight of their release for additional customizability.

MAP \$39.99

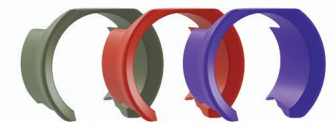

UV3™ SE & UV3XL™ SE – VIZ RING

By popular demand, the Viz Ring is now available for UV3™ SE & UV3XL™ SE. Easy to install and made for all bowhunting scenarios, the Viz Ring is perfect for shot alignment in high-pressure situations.

Choose from 11 awesome colors!

MAP \$19.99



UV CONTOUR KNOB™

The Contour Knob™ has an ergonomic dished contour with non-slip spiral grooves – ensuring it fits your thumb while creating a tactile repeatable point of reference.

MAP \$19.99



UV HELIX KNOB™

The Helix Knob™ has been a fan favorite since 2017. At first glance the knob looks a little atypical but it works great! The peak of the ridge fits perfectly into the valley of your thumb knuckle crease and provides you with extremely consistent thumb placement -- resulting in rock-solid shot execution.

MAP \$19.99



NOCK-ON PSE ULTRAVIEW GRIP

The all-new Nock On PSE aftermarket grip, custom designed in partnership between John Dudley and ULTRAVIEW, ensures hand placement repeatability and optimized positioning, resulting in increased accuracy.

MAP \$49.99



ULTRAGRIP FOR HOYT HUNTING BOWS

Fits all Hoyt hunting models between 2006 and 2021

Beautifully crafted in a ceramic-composite polymer to ensure longevity and a warm-to-the-touch feel, even in extremely cold weather.

MAP \$59.99



UV LENS

Features the latest and most advanced multi-layer coatings available, the lens offers a distortion free image while maintaining a light transmittance over 99%.

Offered in 0x, 2x, 4x, 6x, and 8x and comes with the most optimal center drilled fiber size of 0.019".

MAP UV3™ \$99.99
UV3XL™ SE 109.99



UV THUMB PEG™

Compatible with HINGE 2 and includes hardware for attaching to most other hinge-style releases.

ULTRAVIEW's pioneered through-hole design of the peg allows the mounting bolt to be inserted through the whole peg, and into your release to provide a wide range of compatibility and added strength.

MAP \$19.99



DUALDIAL™ – WHEEL GRIP

Add some flare to your UV Slider™ by choosing between our 4 unique color options.

MAP \$19.99



ULTRAVIEW APPAREL

Look good, feel good, and shoot good.



Scan for UV Apparel.

ULTRAVIEW™