

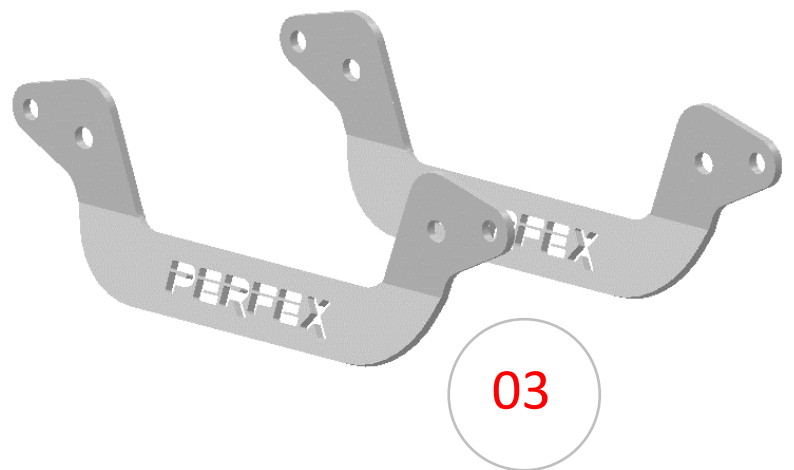

INSTALLATION INSTRUCTIONS

SKU: **LK-10294**

1,5" LIFT KIT CFMOTO CFORCE 500HO/600 (14-20)

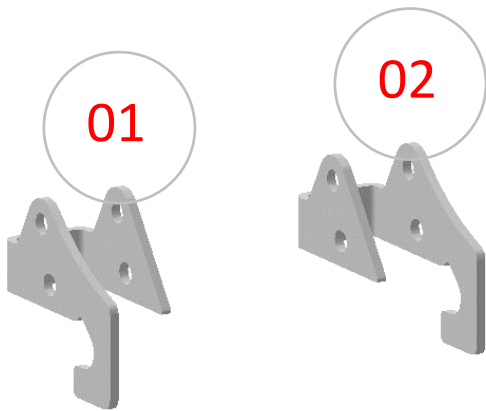

Item	Part No.	Description	Torque	Qty.
LIFT COMPONENTS				
Those items are shown on the first page.				
01	294-01L	Front Lift Bracket (left side)		1
02	294-01R	Front Lift Bracket (right side)		1
03	294-02	Rear Lift Bracket		2

FRONT HARDWARE				
Those items are included with each kit to install the front lift components.				
04	A-1058	M10 Flat Heavy Washer		4
05	A-1509	M10-1.50 Flange Lock Nut	36 to 38 ft-lbs	4
06	A-3021	M10-1.50 x 60mm Hex Flange Bolt	36 to 38 ft-lbs	4
07	B-5219	12mm ID. x 11/16" OD. x 1-3/16" Lg. Spacer		2

REAR HARDWARE				
Those items are included with each kit to install the rear lift components.				
04	A-1058	M10 Flat Heavy Washer		4
08	A-1104	3/8" x 1.000" OD. Flat Washer		1
09	A-1105	3/8" x 1.250" OD. Flat Fender Washer		12
05	A-1509	M10-1.50 Flange Lock Nut	36 to 38 ft-lbs	4
10	A-3023	M10-1.50 x 65mm Hex Flange Bolt	36 to 38 ft-lbs	4
11	A-3030-25	M10-1.25 x 90mm Hex Bolt	38 to 40 ft-lbs	1
12	B-5220	12mm ID. x 11/16" OD. x 1-1/4" Lg. Spacer		2

PLEASE READ AND UNDERSTAND BEFORE THE INSTALLATION

CUSTOMER AND/OR END USER:

This product is designed for use on ATVs and/or UTVs to increase ground clearance and fender clearance. Purchasers should be aware that use of this product may increase the frequency of required maintenance, part wear...

Using a lift kit will raise the center of gravity on your ATV and/or UTV, increasing risk of roll-over, injury and death on ALL types of terrain. It's YOUR RESPONSIBILITY to always inform other operators and passengers of this vehicle about the added risks.

Our products are designed to best fit user's ATV/UTV under stock conditions. Adding, modifying, or fabricating any OEM or aftermarket parts will void warranty. PERFEX Industries products could interfere with other aftermarket accessories. If the user has aftermarket products on machine, please contact PERFEX Industries to verify that they will work together.

Adding aftermarket suspension components and/or more aggressive tires can cause breakage of other OEM driveline components such as differentials, axles or drive shafts.

We ALWAYS recommend that wider tires and/or wheel spacers be used to achieve a wider stance and to improve stability of the ATV and/or UTV. Riders should be advised that the handling characteristics of a taller ATV and/or UTV are different and require extra care when riding, particularly on side hills or off-camber situations. If you further raise the center of gravity by adding taller tires, heavy loads to racks or seats, or by any other means, the ATV and/or UTV must be operated with even more care, at slower speeds and on relatively flat ground. All turns should be done at a slow speed, even on level ground.

Operation of an ATV and/or UTV with or without modified suspension components, while or shortly after consuming alcohol or drugs, subjects the rider to the risk of serious bodily harm or possible death. This risk is compounded if the rider does not wear an approved helmet and other safety gear.

PERFEX Industries urges that all approved safety gear be worn when riding an ATV and/or UTV as a driver or passenger.

By purchasing and installing PERFEX Industries products, user agrees that should damages occur, PERFEX Industries will not be held responsible for loss of time, use, labor fees, replacement parts, or freight charges. WE (PERFEX Industries) will not be held responsible for any direct, indirect, incidental, special, or consequential damages that result from any product purchased from PERFEX Industries.

PLEASE TAKE NOTE: The total liability of seller to user for all damages, losses, and causes of action, will never exceed the total purchase price paid for the product that gives rise to the claim.

DEALER AND/OR OTHER INSTALLERS:

You are responsible for informing your customer and end user of the information contained above and the increased potential hazards of operating an ATV and/or UTV equipped with modified suspension components.

If you install any suspension modifying components, it is your responsibility to also install a warning label prominently in view of the driver and in prominent view of the driver and passenger on UTVs and multi-passenger ATVs.

They should also be instructed to notify anyone operating the vehicle, as well as any passengers, that said vehicle is modified.

As discussed above, it is critically important that they be instructed in the need for slower speed operation, regardless of terrain, after this lift kit is installed.

FRONT INSTALLATION INSTRUCTIONS

PREPARATION

- Using a jack under center of front end, lift until the front wheels leave the ground.
- Remove the wheels.
- Disconnect the bottom of the shocks from the suspension arms. Use a 15mm wrench and socket.

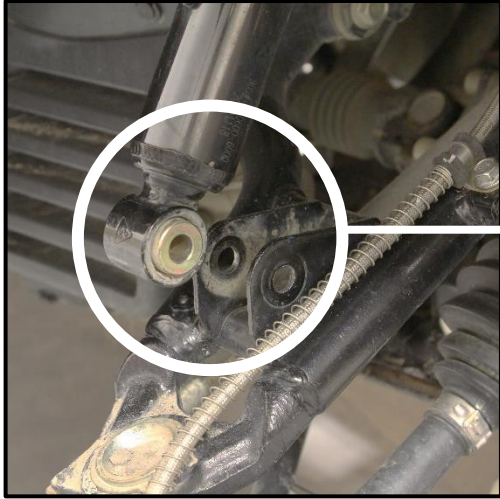

DISCONNECT BOTH SIDE

- Remove all the dirt that is on your a-arms, on each side of the shocks mount.

INSTALLATION

1. Install one front bracket (you have one for the left and one for the right) to the shock mount. Use (1x) M10-1.50 x 60mm bolt, (1x) 1-3/16" Lg. spacer and (1x) M10-1.50 lock nut.

NOTE: The top of the bracket will hook the A-arm.

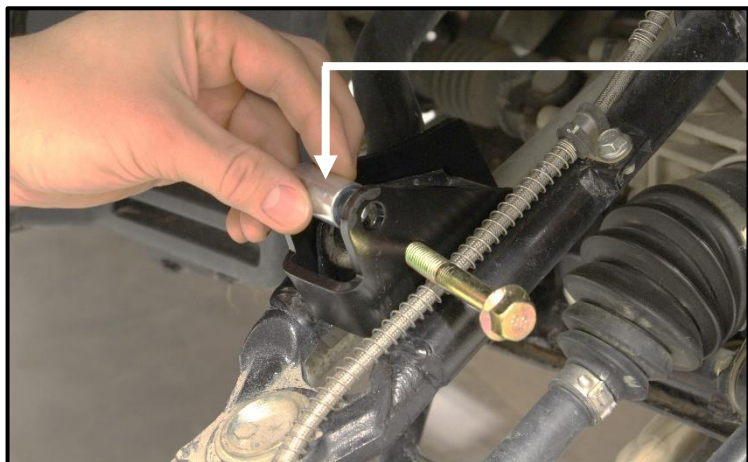
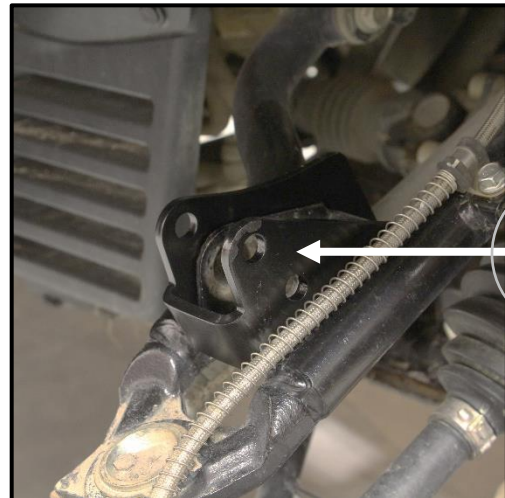
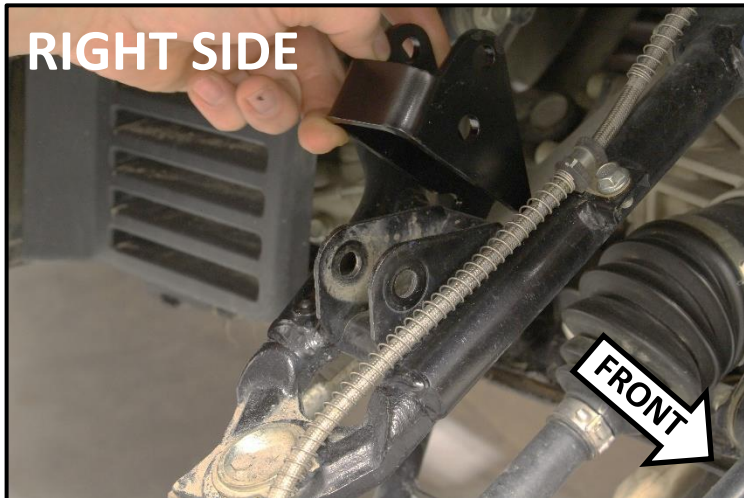

SPACER

2. Connect the bottom of the shock to the new shock location on the bracket. Use (1x) M10-1.50 x 60mm bolt, (2x) M10 washer and (1x) M10-1.50 lock nut. Put one washer on each side of the shock eyelet.

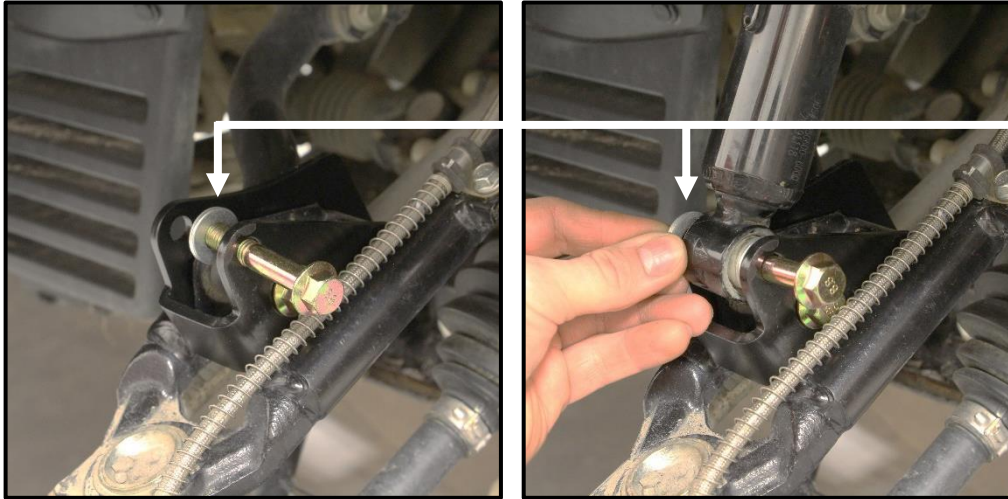

WASHERS

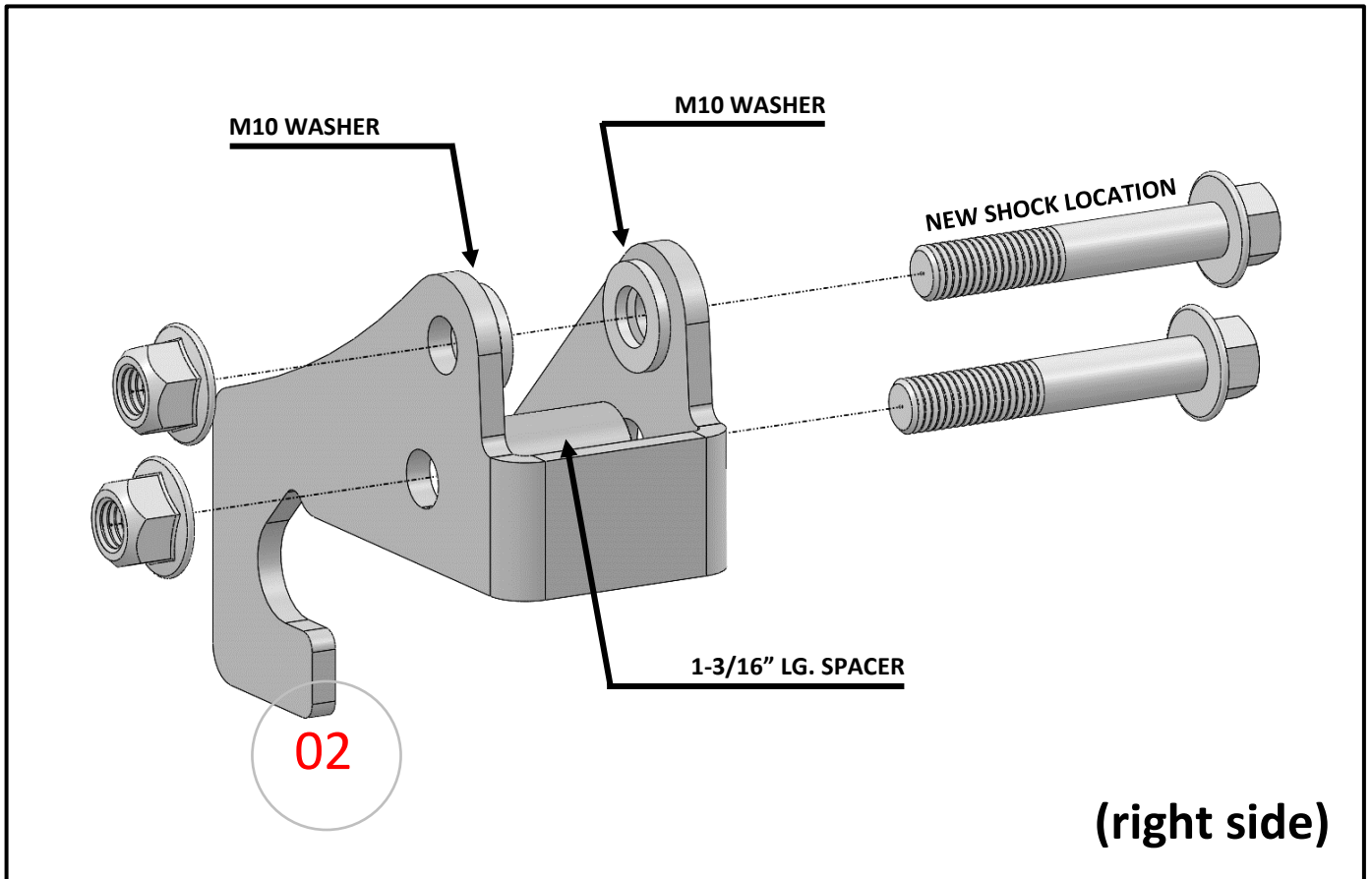

3. Tight all the hardware appropriately at this point. Use a 14mm and a 15mm wrench and socket.
4. Repeat the same steps for the opposite side.
5. Put the wheels back on the vehicle when the installation is finished. Torque all lugs to factory specification.



REAR INSTALLATION INSTRUCTIONS

PREPARATION

- Using a jack under center of rear end, lift until the rear wheels leave the ground.
- Remove the wheels.
- Disconnect the top of the shocks from the frame shock mount. Use a 15mm wrench and socket.

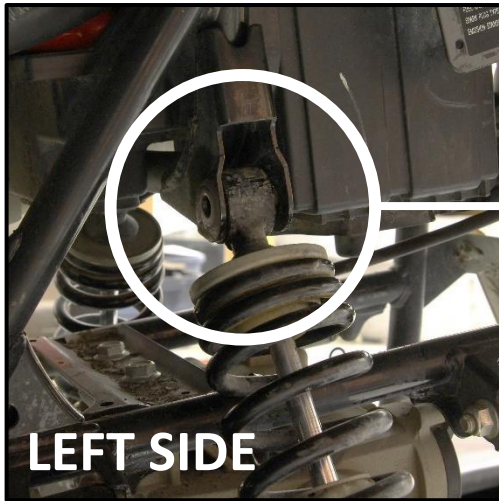

DISCONNECT BOTH SIDE

- Remove the bolt that fix the muffler to the frame. Use a 15mm socket.

INSTALLATION

1. Reconnect the muffler using (1x) M10-1.25 x 90mm bolt, (1x) 3/8" washer and (12x) 3/8" fender washer. Put the 3/8" washer with the head of the bolt, and the 3/8" fender washers between the frame and the muffler. Tighten this bolt using a 17mm socket.

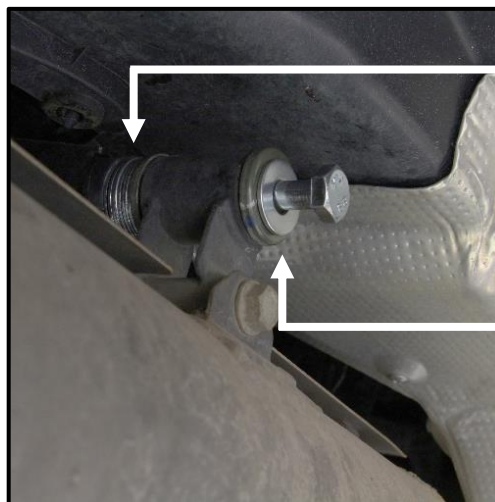
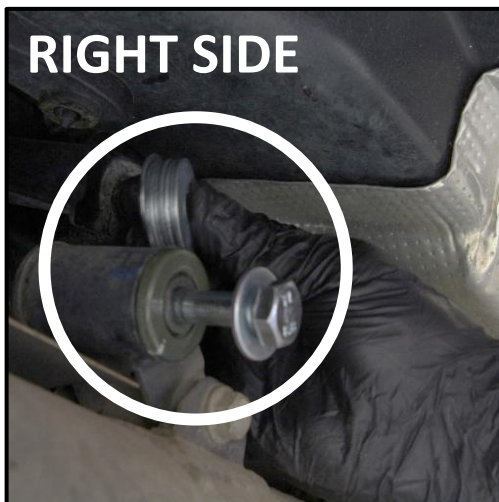

3/8" FENDER WASHERS

3/8" WASHER

2. Insert the rear brackets (03) to the frame shock mount. Use (2x) M10-1.50 x 65mm bolt, (2x) 1-1/4" Lg. spacer and (2x) M10-1.50 lock nut. Put the spacers inside of the shock mount.



SPACER

3. Connect the top of the shocks to the new shock location on the brackets. Use (2x) M10-1.50 x 65mm bolt, (4x) M10 washer and (2x) M10-1.50 lock nut. Put one washer on each side of the shocks eyelet.

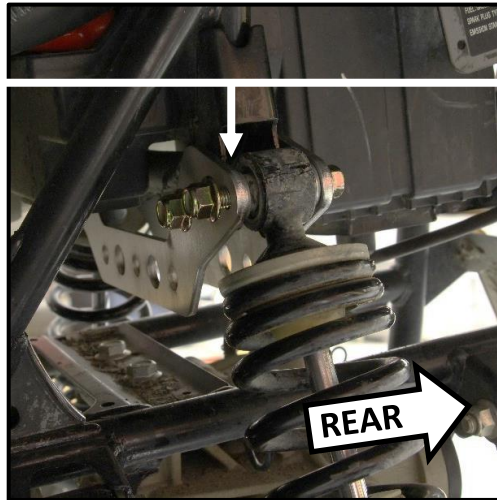
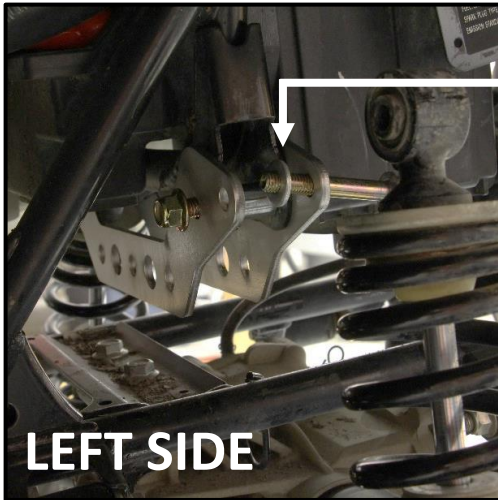

WASHERS

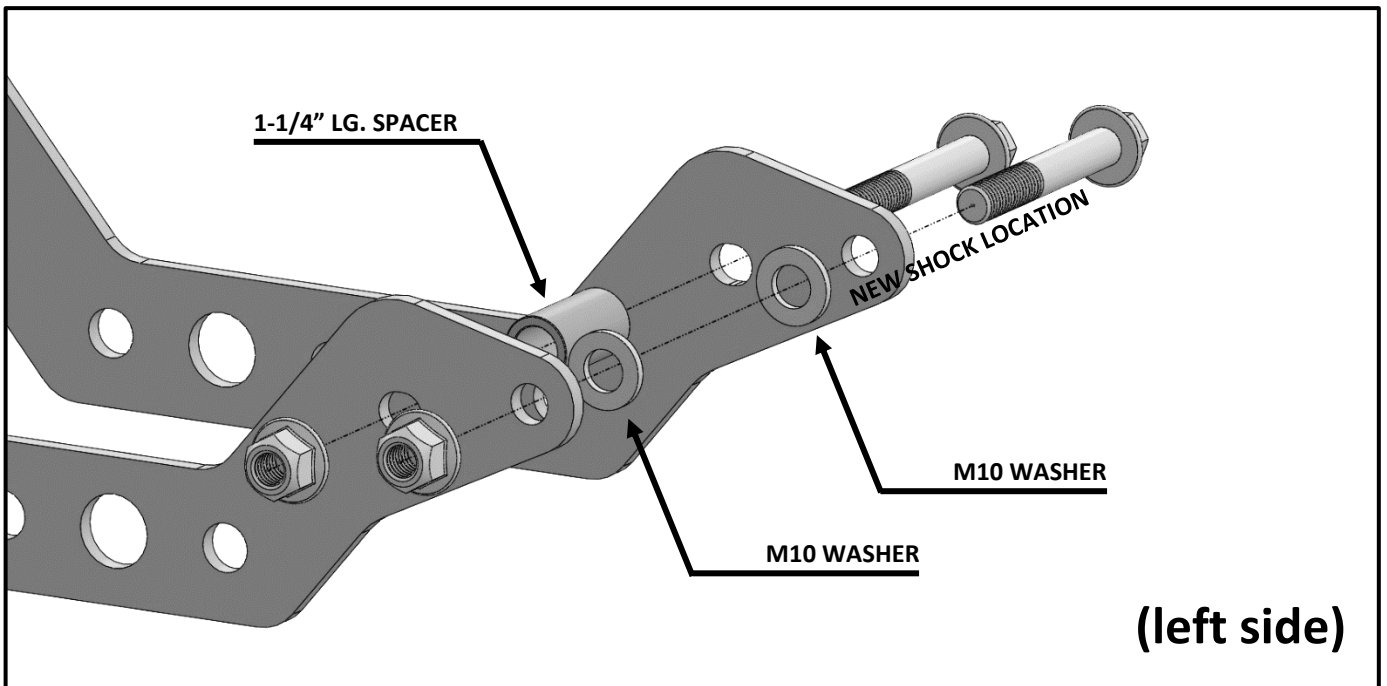

(left side)

6. Tight all the remaining hardware appropriately at this point. Use a 14mm and a 15mm wrench and socket.
7. Put the wheels back on the vehicle when the installation is finished. Torque all lugs to factory specification.