



INSTALLATION INSTRUCTIONS

SKU: **LK-10274**



2" LIFT KIT CAN-AM OUTLANDER G2 650-1000 (17-18)

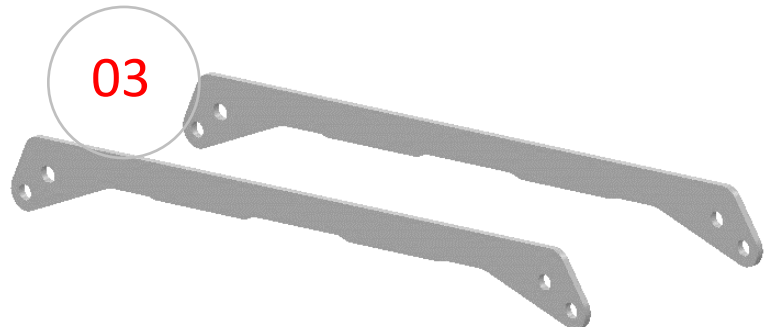
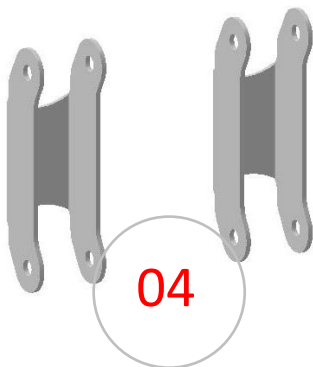
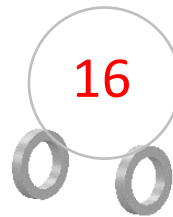
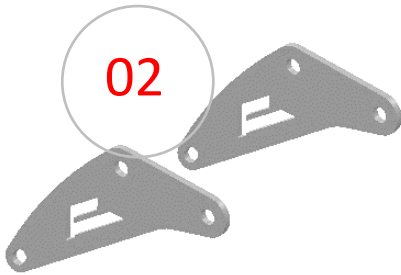
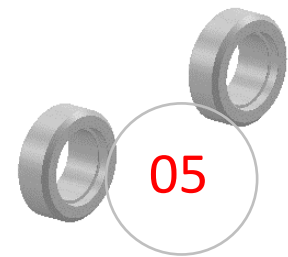
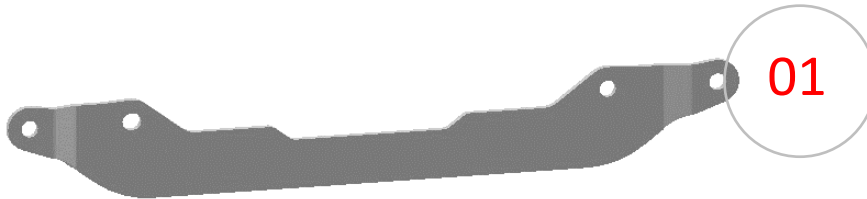

Item	Part No.	Description	Torque	Qty.
LIFT COMPONENTS				
Those items are shown on the first page.				
01	236-01	Front Lift Bracket		1
02	236-02	Front Lift Bracket		2
03	284-03	Rear Lift Bracket		2
04	236-05	Rear Sway Bar Link Bracket		2
05	284-07	Rear Spring Spacer		2

FRONT HARDWARE				
Those items are included with each kit to install the front lift components.				
06	A-1507	M8-1.25 Flange Lock Nut	18.75 ft-lbs	2
07	A-1509	M10-1.50 Flange Lock Nut	36 to 38 ft-lbs	2
08	A-2807	M8-1.25 x 25mm Hex Flange Bolt	18.75 ft-lbs	2
09	A-3021	M10-1.50 x 60mm Hex Flange Bolt	36 to 38 ft-lbs	2
10	B-5214	12mm ID. x 11/16" OD. x 7/8" Lg. Spacer		2

REAR HARDWARE				
Those items are included with each kit to install the rear lift components.				
11	A-1016	M18 Flat Washer		2
07	A-1509	M10-1.50 Flange Lock Nut	36 to 38 ft-lbs	4
12	A-1611	M18-1.50 Castellated Nut (Low Slotted)	200 ft-lbs	2
13	A-3023	M10-1.50 x 65mm Hex Flange Bolt	36 to 38 ft-lbs	4
14	B-5003	10mm ID. x 5/8" OD. x 3/16" Lg. Spacer		4
15	B-5220	12mm ID. x 11/16" OD. x 1-1/4" Lg. Spacer		2
16	B-5618	Rear Axle Spacer		2

PLEASE READ AND UNDERSTAND BEFORE THE INSTALLATION

CUSTOMER AND/OR END USER:

This product is designed for use on ATVs and/or UTVs to increase ground clearance and fender clearance. Purchasers should be aware that use of this product may increase the frequency of required maintenance, part wear...

Using a lift kit will raise the center of gravity on your ATV and/or UTV, increasing risk of roll-over, injury and death on ALL types of terrain. It's YOUR RESPONSIBILITY to always inform other operators and passengers of this vehicle about the added risks.

Our products are designed to best fit user's ATV/UTV under stock conditions. Adding, modifying, or fabricating any OEM or aftermarket parts will void warranty. PERFEX Industries products could interfere with other aftermarket accessories. If the user has aftermarket products on machine, please contact PERFEX Industries to verify that they will work together.

Adding aftermarket suspension components and/or more aggressive tires can cause breakage of other OEM driveline components such as differentials, axles or drive shafts.

We ALWAYS recommend that wider tires and/or wheel spacers be used to achieve a wider stance and to improve stability of the ATV and/or UTV. Riders should be advised that the handling characteristics of a taller ATV and/or UTV are different and require extra care when riding, particularly on side hills or off-camber situations. If you further raise the center of gravity by adding taller tires, heavy loads to racks or seats, or by any other means, the ATV and/or UTV must be operated with even more care, at slower speeds and on relatively flat ground. All turns should be done at a slow speed, even on level ground.

Operation of an ATV and/or UTV with or without modified suspension components, while or shortly after consuming alcohol or drugs, subjects the rider to the risk of serious bodily harm or possible death. This risk is compounded if the rider does not wear an approved helmet and other safety gear.

PERFEX Industries urges that all approved safety gear be worn when riding an ATV and/or UTV as a driver or passenger.

By purchasing and installing PERFEX Industries products, user agrees that should damages occur, PERFEX Industries will not be held responsible for loss of time, use, labor fees, replacement parts, or freight charges. WE (PERFEX Industries) will not be held responsible for any direct, indirect, incidental, special, or consequential damages that result from any product purchased from PERFEX Industries.

PLEASE TAKE NOTE: The total liability of seller to user for all damages, losses, and causes of action, will never exceed the total purchase price paid for the product that gives rise to the claim.

DEALER AND/OR OTHER INSTALLERS:

You are responsible for informing your customer and end user of the information contained above and the increased potential hazards of operating an ATV and/or UTV equipped with modified suspension components.

If you install any suspension modifying components, it is your responsibility to also install a warning label prominently in view of the driver and in prominent view of the driver and passenger on UTVs and multi-passenger ATVs.

They should also be instructed to notify anyone operating the vehicle, as well as any passengers, that said vehicle is modified.

As discussed above, it is critically important that they be instructed in the need for slower speed operation, regardless of terrain, after this lift kit is installed.

FRONT INSTALLATION INSTRUCTIONS

PREPARATION

- Using a jack under center of front end, lift until the front wheels leave the ground.
- Remove the wheels.
- Remove the inner fenders from both side.
- Disconnect the top of the shocks from the frame shock mount. Use a 15mm key and socket.
- Remove the 8mm factory bolts and nuts that they are fixed just under the top of the shock. Use a 13mm wrench and socket.

INSTALLATION

1. Install (1x) small front bracket (02) inside of the frame shock mount, face of the rear of the ATV. Use OEM bolt with (1x) 7/8" Lg. spacer.

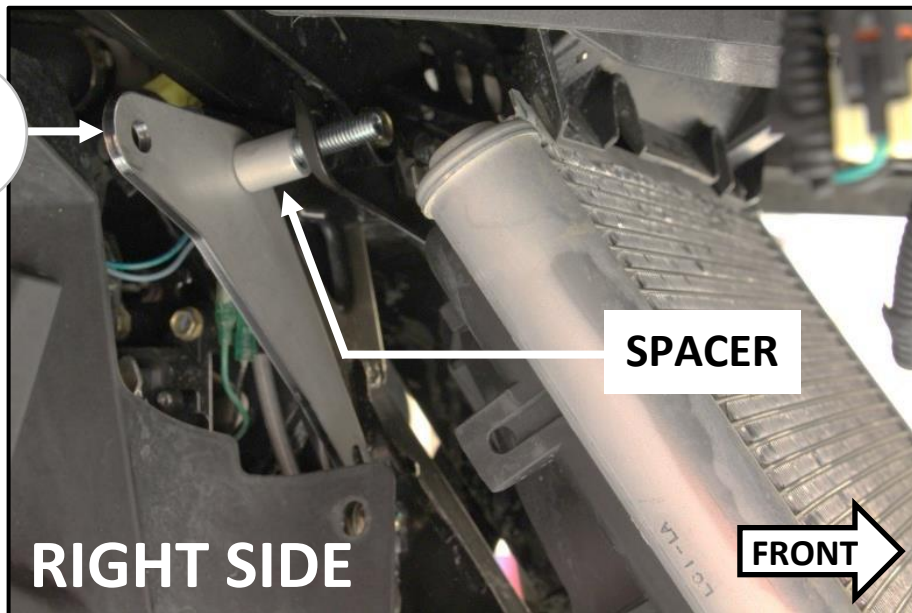

2. Secure the bottom of the bracket to the frame, where the 8mm factory bolt was. Use the provided M8-1.25 bolt and nut. Tight this bolt using a 12mm and a 13mm wrench and socket.

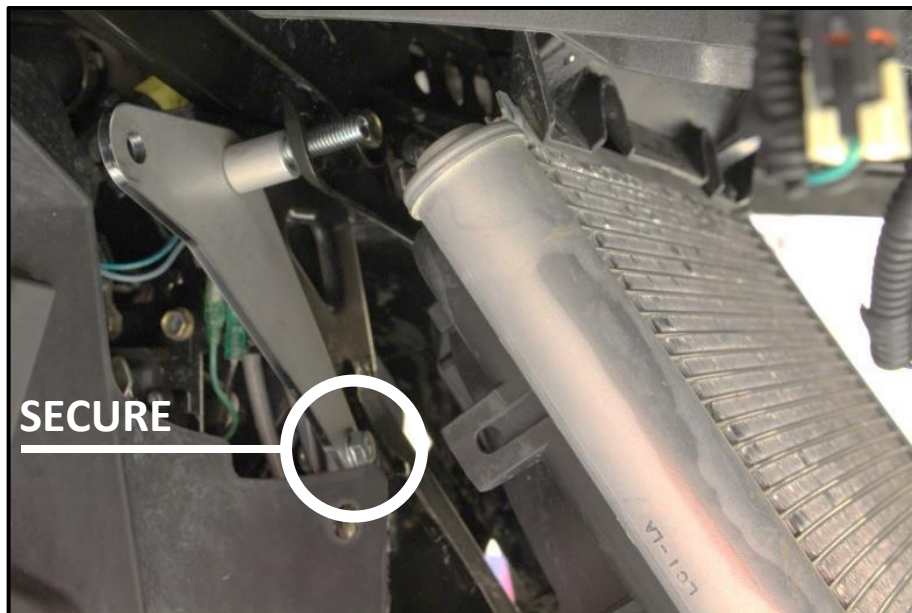

3. Repeat the same steps for the other side.

4. Insert the long front bracket (01) to the assembly, inside of the frame shock mount. Secure using OEM nuts.

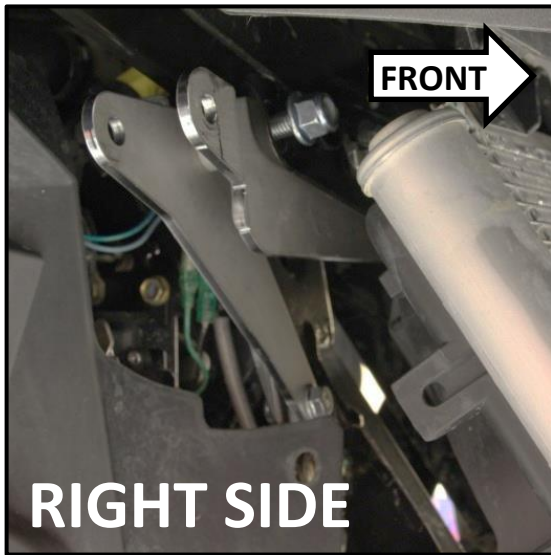

5. Put the inner fenders back in place.
6. Connect the top of the shocks to the new shock locations. Use (2x) M10-1.50 x 60mm bolt and (2x) M10-1.50 lock nut.

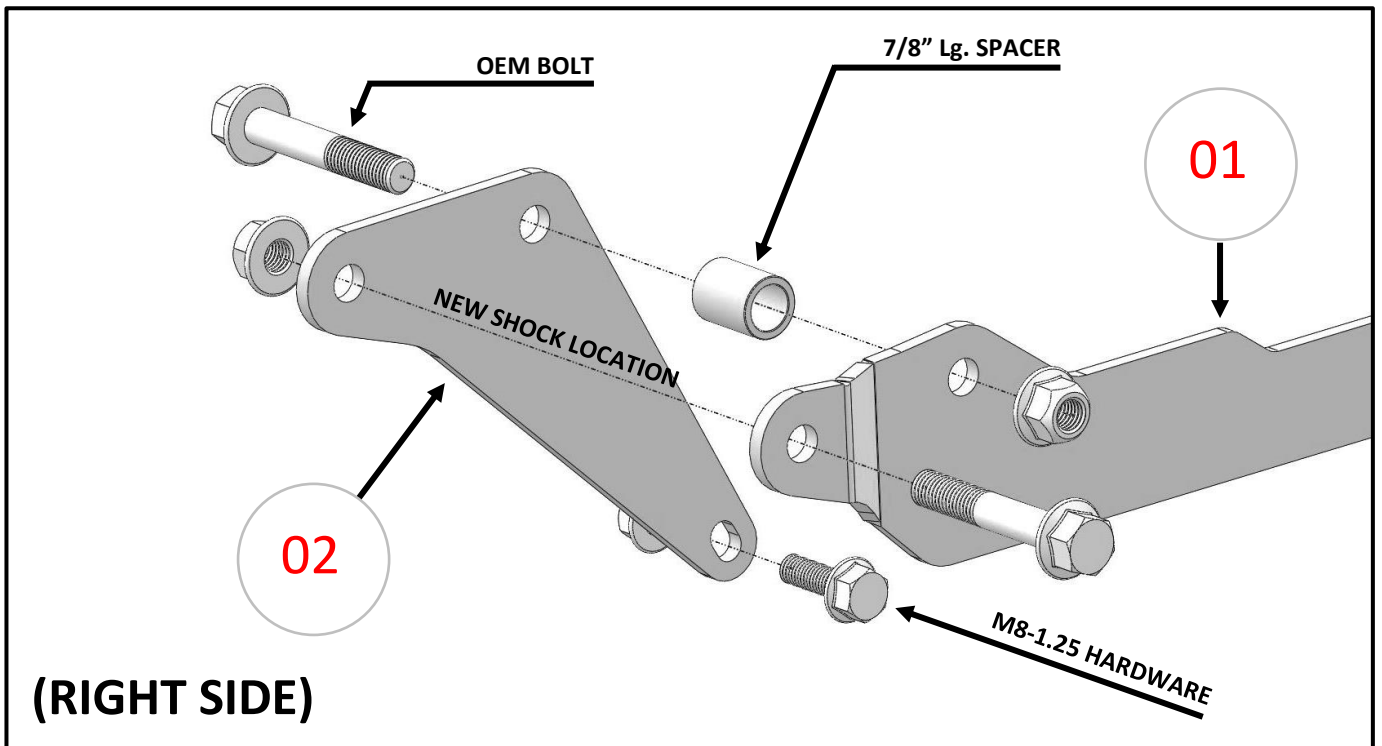
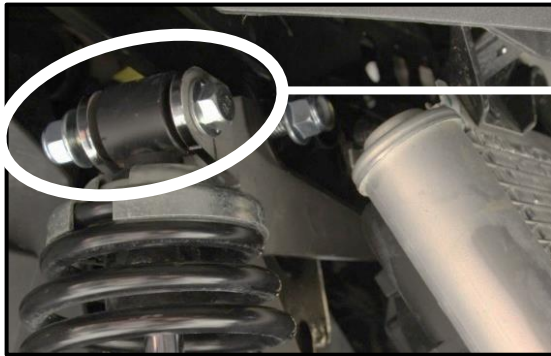

7. Tight all the remaining hardware appropriately at this point. Use a 14mm and a 15mm wrench and socket.
8. Put the wheels back on the vehicle when the installation is finished. Torque all lugs to factory specification.

REAR INSTALLATION INSTRUCTIONS

PREPARATION

- Remove the rear rack kit completely.
- Remove the seat and the rear storage box cover. You will need to have a full access to your frame where are bolted your shocks.
- Using a jack under center of rear end, lift until the rear wheels leave the ground.
- Remove the wheels.
- Remove the shocks. Use a 15mm wrench and socket.
- Disconnect the bottom of the brackets that connect the sway bar to the suspension arms. Use a 15mm wrench and socket.

INSTALLATION

1. When the rear arms will be at full extension, they will be resting on a plate that is welded to the frame. You will need to mark this area where it's touching and trim later. **You will need to trim both sides.**
2. Remove both hubs from the ATV. Use a 27mm socket.



3. Remove completely the pivot rod from the ATV. Use a 24mm wrench and socket.

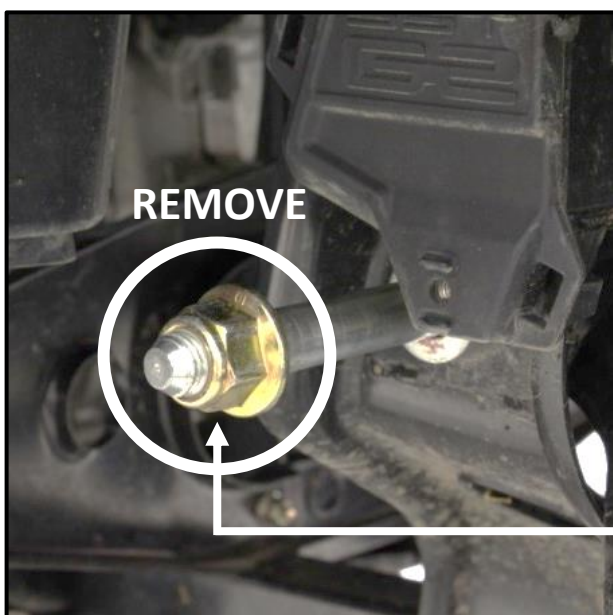

PIVOT ROD

4. Once the pivot rod will be removed completely, you will be able to remove the suspension arms completely from the ATV.

5. Using a grinder, trim the areas marked at step 1. Remove about 1/2 inch of depth. Refer to picture below.

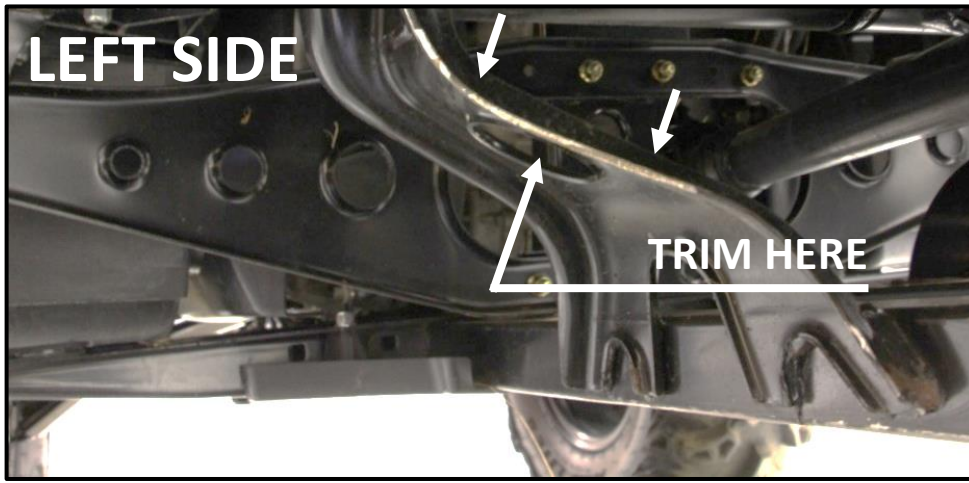

6. Insert (1x) axle spacer (16) at the end of EACH axle, as shown below. Then, put the hubs back. Use the new M18-1.50 castle nuts with the new M18 washers to fix the hub on the axle. Don't forget to put back the factory washer and cotter pin.

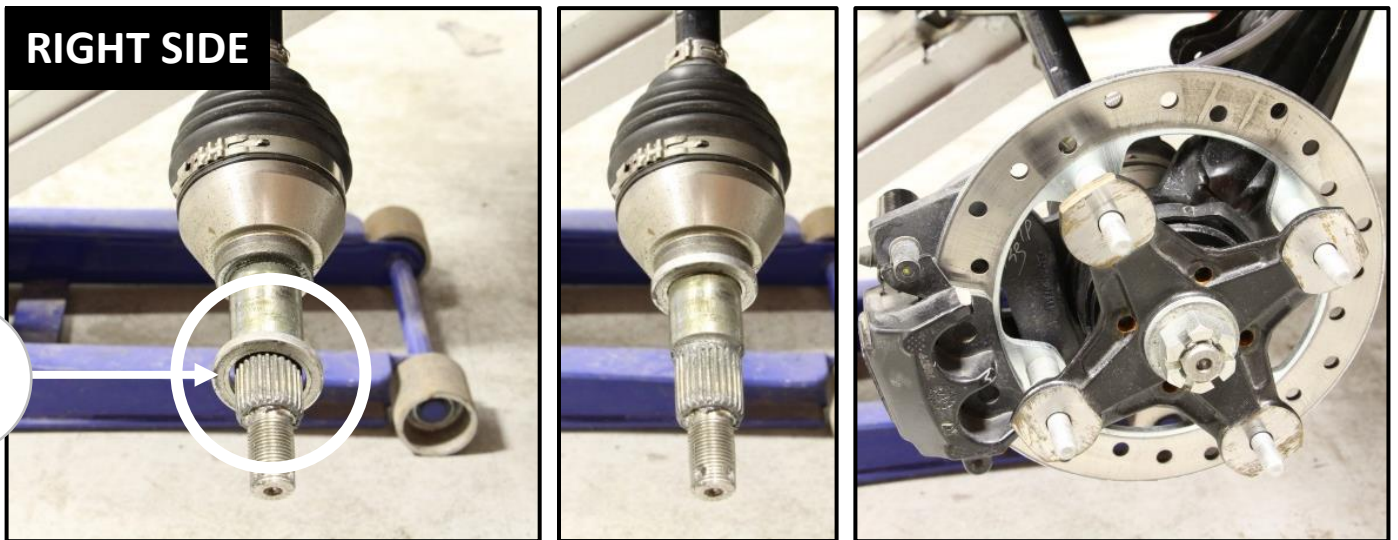

7. Once both suspension arms will be fixed, put the pivot rod back on the ATV. Torque the pivot rod to factory specification.
NOTE: It will be way easier on this step if you can have a helper with you to align the pivot rod with the suspension arms.
8. Connect the new sway bar link brackets (04) to the sway bar and the suspension arm. Use OEM hardware.

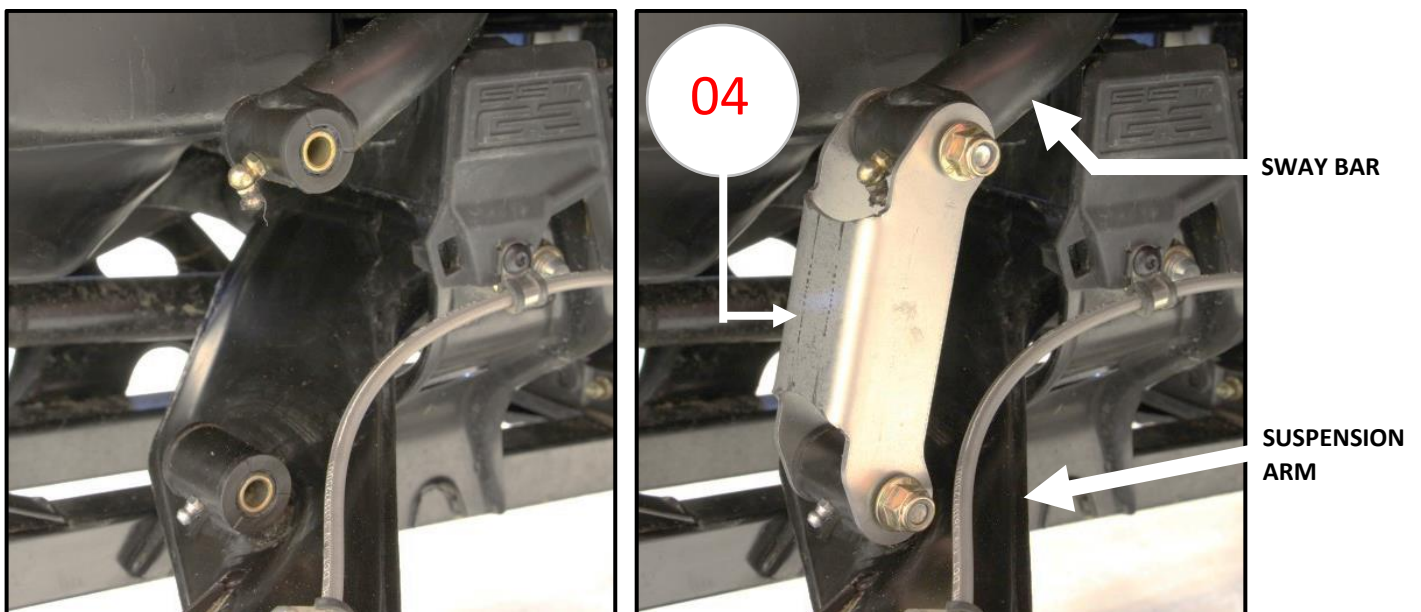

9. Using a spring compressor, remove the retainer and the spring of the shock absorber.



REMOVE THE RETAINER



10. Insert the spring spacer (05) on the shock absorber.

- **DPS MODELS:** Put the spacer on the bottom of the shock.
- **XT-P MODELS:** Put the spacer between the small and the big spring.

11. Put the spring and the retainer back on the shock absorber.

12. Repeat the same steps (9-11) for the other side.



13. Insert the rear brackets (03) on each side of the frame shock mount.

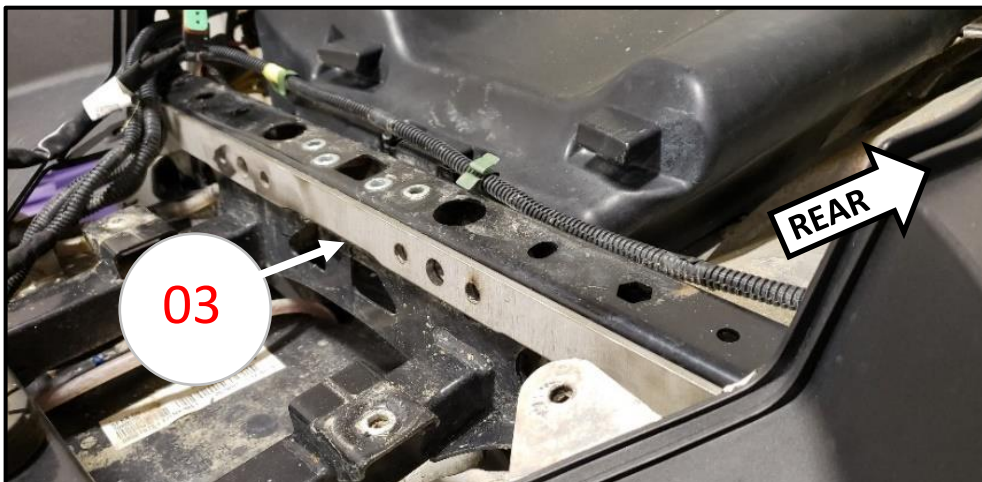

14. Install the brackets to the frame shock mount using (2x) M10-1.50 x 65mm bolt, (2x) 1-1/4" Lg. spacer and (2x) M10-1.50 lock nut. Put the spacers inside of the shock mount.

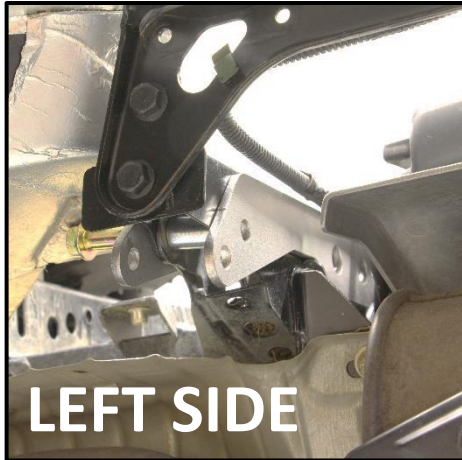

15. Connect the top of the shocks to the new shock location on the brackets. FOR EACH SIDE, use (1x) M10-1.50 x 65mm bolt, (2x) 3/16" Lg. spacer and (1x) M10-1.50 lock nut. Put one spacer on each side of the shock eyelet.



16. Reconnect the bottom of the shocks to the suspension arms. Use OEM hardware.
17. Tight all the hardware appropriately at this point. Use a 14mm and a 15mm wrench and socket.
18. Put the wheels back on the vehicle when the installation is finished. Torque all lugs to factory specification.
19. Put the storage box cover, the seat and the rack back on the ATV.

NOTE: You will need to cut a small portion of plastic on the storage box cover to clear the lift bracket. See images below.

