

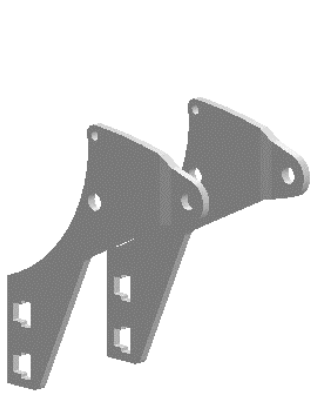

# INSTALLATION INSTRUCTIONS

SKU: **LK-10260**

**3" LIFT KIT CAN-AM MAVERICK 1000 TURBO (15-18)**



01

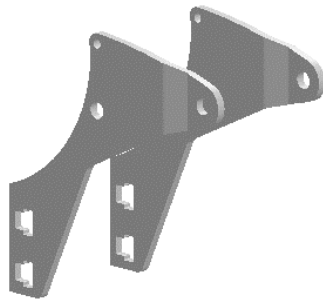

02

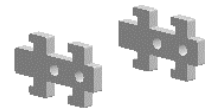

03

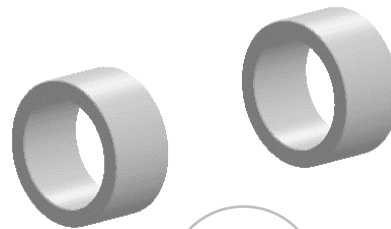

04

Item	Part No.	Description	Torque	Qty.
------	----------	-------------	--------	------

**LIFT COMPONENTS**

Those items are shown on the first page.

01	246-01L	Front Lift Bracket (left)		2
02	246-01R	Front Lift Bracket (right)		2
03	246-02	Front Link Bracket		2
04	279-02	Rear Spring Spacer		2

**FRONT HARDWARE**

Those items are included with each kit to install the front lift components.

05	A-1010	M12 Flat Washer		2
06	A-1150	1/4" William Flat Heavy Washer		4
07	A-1505	M6-1.00 Flange Lock Nut	7.8 ft-lbs	2
08	A-1507	M8-1.25 Flange Lock Nut	18.75 ft-lbs	4
09	A-1510	M12-1.75 Lock Nut	62 to 64 ft-lbs	2
10	A-2621	M6-1.00 x 60mm Hex Flange Bolt	7.8 ft-lbs	2
11	A-2809	M8-1.25 x 30mm Hex Flange Bolt	18.75 ft-lbs	4
12	A-3222	M12-1.75 x 65mm Hex Bolt	62 to 64 ft-lbs	2
13	B-5212	12mm ID. x 11/16" OD. x 3/4" Lg. Spacer		4

# PLEASE READ AND UNDERSTAND BEFORE THE INSTALLATION

## CUSTOMER AND/OR END USER:

---

This product is designed for use on ATVs and/or UTVs to increase ground clearance and fender clearance. Purchasers should be aware that use of this product may increase the frequency of required maintenance, part wear...

Using a lift kit will raise the center of gravity on your ATV and/or UTV, increasing risk of roll-over, injury and death on ALL types of terrain. It's YOUR RESPONSIBILITY to always inform other operators and passengers of this vehicle about the added risks.

Our products are designed to best fit user's ATV/UTV under stock conditions. Adding, modifying, or fabricating any OEM or aftermarket parts will void warranty. PERFEX Industries products could interfere with other aftermarket accessories. If the user has aftermarket products on machine, please contact PERFEX Industries to verify that they will work together.

Adding aftermarket suspension components and/or more aggressive tires can cause breakage of other OEM driveline components such as differentials, axles or drive shafts.

We ALWAYS recommend that wider tires and/or wheel spacers be used to achieve a wider stance and to improve stability of the ATV and/or UTV. Riders should be advised that the handling characteristics of a taller ATV and/or UTV are different and require extra care when riding, particularly on side hills or off-camber situations. If you further raise the center of gravity by adding taller tires, heavy loads to racks or seats, or by any other means, the ATV and/or UTV must be operated with even more care, at slower speeds and on relatively flat ground. All turns should be done at a slow speed, even on level ground.

Operation of an ATV and/or UTV with or without modified suspension components, while or shortly after consuming alcohol or drugs, subjects the rider to the risk of serious bodily harm or possible death. This risk is compounded if the rider does not wear an approved helmet and other safety gear.

PERFEX Industries urges that all approved safety gear be worn when riding an ATV and/or UTV as a driver or passenger.

By purchasing and installing PERFEX Industries products, user agrees that should damages occur, PERFEX Industries will not be held responsible for loss of time, use, labor fees, replacement parts, or freight charges. WE (PERFEX Industries) will not be held responsible for any direct, indirect, incidental, special, or consequential damages that result from any product purchased from PERFEX Industries.

**PLEASE TAKE NOTE: The total liability of seller to user for all damages, losses, and causes of action, will never exceed the total purchase price paid for the product that gives rise to the claim.**

## DEALER AND/OR OTHER INSTALLERS:

---

You are responsible for informing your customer and end user of the information contained above and the increased potential hazards of operating an ATV and/or UTV equipped with modified suspension components.

If you install any suspension modifying components, it is your responsibility to also install a warning label prominently in view of the driver and in prominent view of the driver and passenger on UTVs and multi-passenger ATVs.

They should also be instructed to notify anyone operating the vehicle, as well as any passengers, that said vehicle is modified.

As discussed above, it is critically important that they be instructed in the need for slower speed operation, regardless of terrain, after this lift kit is installed.

# FRONT INSTALLATION INSTRUCTIONS

## PREPARATION

- Using a jack under center of front end, lift until the front wheels leave the ground.
- Remove the wheels.
- Remove the shock. Save factory hardware.

## INSTALLATION

1. Insert one front left bracket and one right bracket, inside of the frame shock mount. Secure using **(1x)** M6-1.00 x 60mm bolt, **(2x)** 1/4" heavy washer, **(1x)** 3/4" Lg. spacer and **(1x)** M6-1.00 lock nut.
  - Put the washer outside of the bracket, but inside of the shock mount.
  - Put the spacer inside the brackets.



2. Flip the bottom of the bracket to the top and insert the bracket C between both front lift brackets. Secure to the frame using **(2x)** M8-1.25 x 30mm bolt and **(2x)** M8-1.25 lock nut. **Do not overtighten now.**

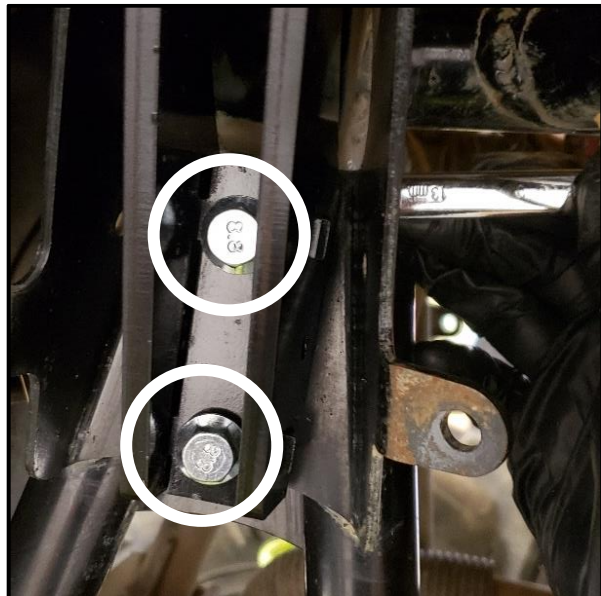
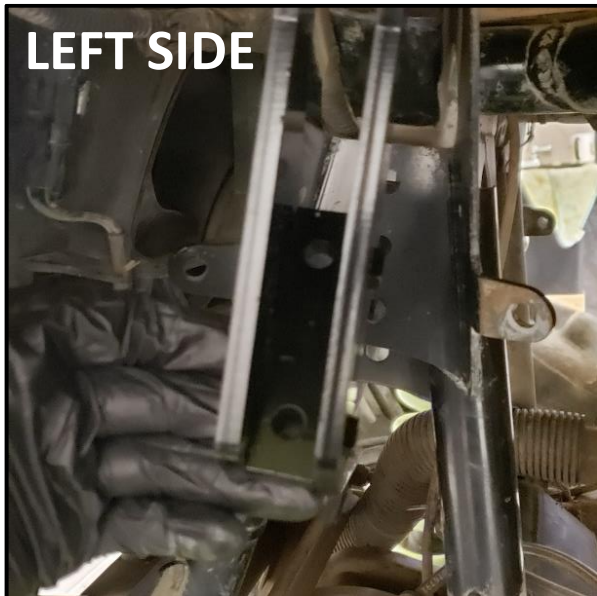

3. Install the front brackets to the frame shock mount. Use factory hardware and (1x) 3/4" Lg. spacer. Put the spacer between the brackets.
4. Then, connect the top of the shock to the new shock location. Use (1x) M12-1.75 x 65mm bolt, (1x) M12 washer and (1x) M12-1.75 lock nut.
5. Re-connect the bottom of the shock using factory hardware.
6. Tight all the hardware appropriately at this point.
7. Repeat the same steps for the opposite side.
8. Put the wheels back on the vehicle when the installation is finished. Torque all lugs to factory specification.

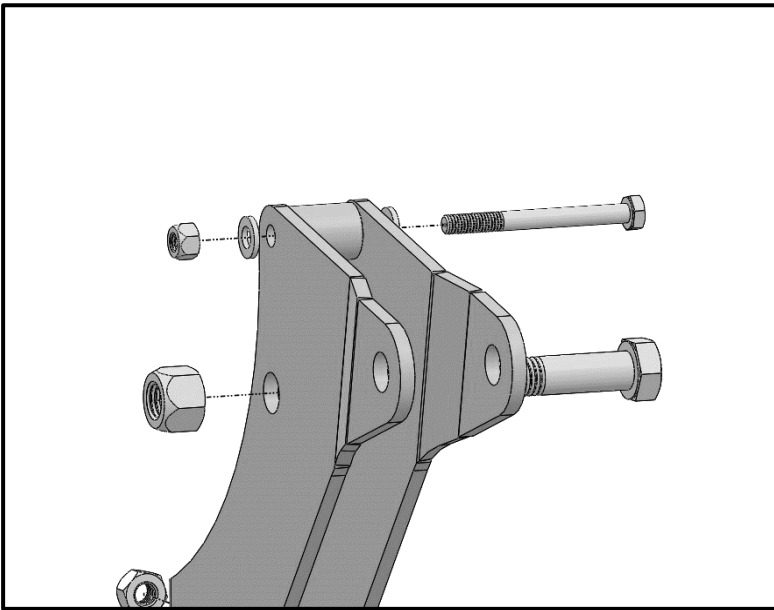
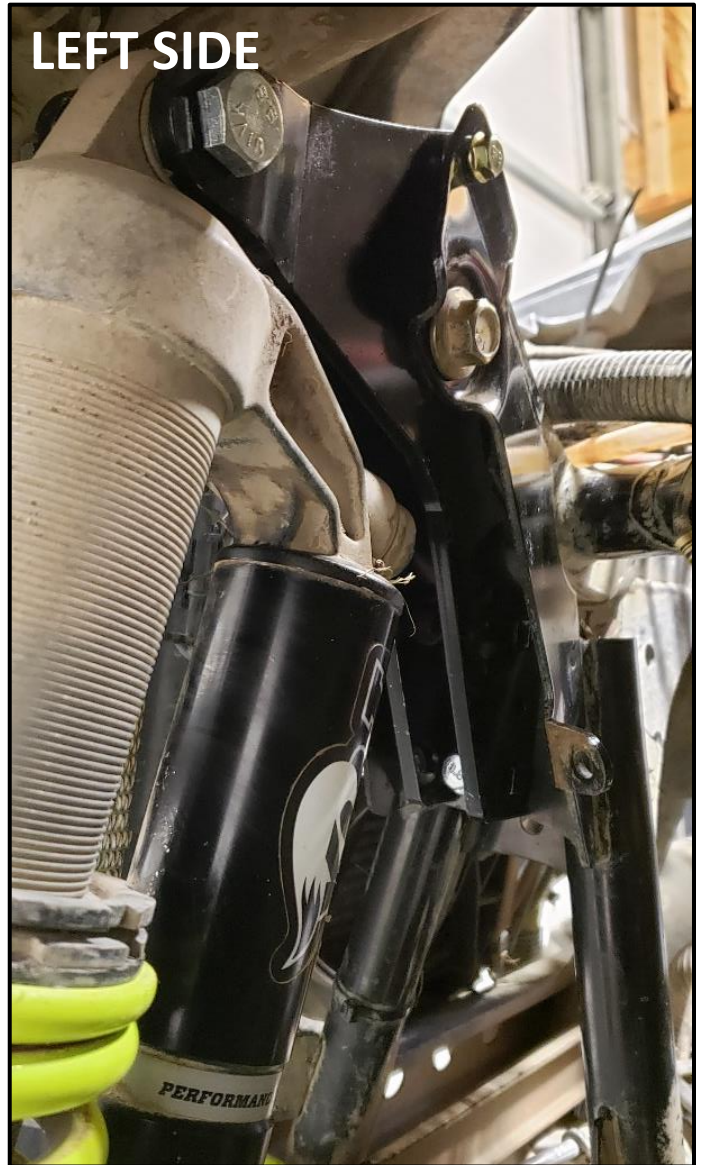



# REAR INSTALLATION INSTRUCTIONS

## PREPARATION

- Using a jack under center of rear end, lift until the rear wheels leave the ground.
- Remove the wheels.
- Remove the shocks from the UTV. Save factory hardware.

## INSTALLATION

1. Using a shock compressor, remove the bigger spring from the shock.
2. Remove the plastic separator between the two springs.
3. Insert the lift spacer to the plastic separator (on the longer side).
4. Flip and put the plastic separator back on the shock.
5. Put the bigger spring back on the shock.
6. Install the shock to the UTV.
7. Adjust the nut so that the distance is 1-1/2" from the top of the nut to the mount.
8. Repeat the same steps for the opposite side.
9. Put the wheels back on the vehicle when the installation is finished. Torque all lugs to factory specification.

