



INSTALLATION INSTRUCTIONS

SKU: **LK-10252**

2" LIFT KIT POLARIS SPORTSMAN 550-1000 TOURING (2014+)

01



02



03

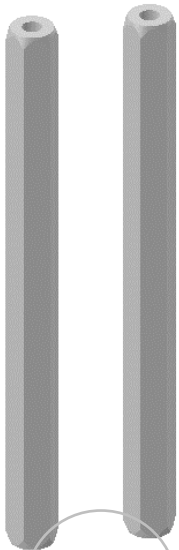

Item	Part No.	Description	Torque	Qty.
LIFT COMPONENTS				
Those items are shown on the first page.				
01	250-01	Front Lift Bracket		2
02	228-02	Rear Lift Bracket		2
03	250-03	Rear Sway Bar Bracket		2

FRONT HARDWARE				
Those items are included with each kit to install the front lift components.				
04	A-1058	M10 Flat Heavy Washer		4
05	A-1509	M10-1.50 Flange Lock Nut	36 to 38 ft-lbs	4
06	A-3023	M10-1.50 x 65mm Hex Flange Bolt	36 to 38 ft-lbs	4
07	B-5222	12mm ID. x 11/16" OD. x 1-3/8" Lg. Spacer		2

REAR HARDWARE				
Those items are included with each kit to install the rear lift components.				
08	A-1008	M10 Flat Washer		4
05	A-1509	M10-1.50 Flange Lock Nut	36 to 38 ft-lbs	4
09	A-3021	M10-1.50 x 60mm Hex Flange Bolt	36 to 38 ft-lbs	4
10	B-5217	12mm ID. x 11/16" OD. x 1-1/16" Lg. Spacer		4

PLEASE READ AND UNDERSTAND BEFORE THE INSTALLATION

CUSTOMER AND/OR END USER:

This product is designed for use on ATVs and/or UTVs to increase ground clearance and fender clearance. Purchasers should be aware that use of this product may increase the frequency of required maintenance, part wear...

Using a lift kit will raise the center of gravity on your ATV and/or UTV, increasing risk of roll-over, injury and death on ALL types of terrain. It's YOUR RESPONSIBILITY to always inform other operators and passengers of this vehicle about the added risks.

Our products are designed to best fit user's ATV/UTV under stock conditions. Adding, modifying, or fabricating any OEM or aftermarket parts will void warranty. PERFEX Industries products could interfere with other aftermarket accessories. If the user has aftermarket products on machine, please contact PERFEX Industries to verify that they will work together.

Adding aftermarket suspension components and/or more aggressive tires can cause breakage of other OEM driveline components such as differentials, axles or drive shafts.

We ALWAYS recommend that wider tires and/or wheel spacers be used to achieve a wider stance and to improve stability of the ATV and/or UTV. Riders should be advised that the handling characteristics of a taller ATV and/or UTV are different and require extra care when riding, particularly on side hills or off-camber situations. If you further raise the center of gravity by adding taller tires, heavy loads to racks or seats, or by any other means, the ATV and/or UTV must be operated with even more care, at slower speeds and on relatively flat ground. All turns should be done at a slow speed, even on level ground.

Operation of an ATV and/or UTV with or without modified suspension components, while or shortly after consuming alcohol or drugs, subjects the rider to the risk of serious bodily harm or possible death. This risk is compounded if the rider does not wear an approved helmet and other safety gear.

PERFEX Industries urges that all approved safety gear be worn when riding an ATV and/or UTV as a driver or passenger.

By purchasing and installing PERFEX Industries products, user agrees that should damages occur, PERFEX Industries will not be held responsible for loss of time, use, labor fees, replacement parts, or freight charges. WE (PERFEX Industries) will not be held responsible for any direct, indirect, incidental, special, or consequential damages that result from any product purchased from PERFEX Industries.

PLEASE TAKE NOTE: The total liability of seller to user for all damages, losses, and causes of action, will never exceed the total purchase price paid for the product that gives rise to the claim.

DEALER AND/OR OTHER INSTALLERS:

You are responsible for informing your customer and end user of the information contained above and the increased potential hazards of operating an ATV and/or UTV equipped with modified suspension components.

If you install any suspension modifying components, it is your responsibility to also install a warning label prominently in view of the driver and in prominent view of the driver and passenger on UTVs and multi-passenger ATVs.

They should also be instructed to notify anyone operating the vehicle, as well as any passengers, that said vehicle is modified.

As discussed above, it is critically important that they be instructed in the need for slower speed operation, regardless of terrain, after this lift kit is installed.

FRONT INSTALLATION INSTRUCTIONS

PREPARATION

- Using a jack under center of front end, lift until the front wheels leave the ground.
- Disconnect the bottom of the shocks from the suspension arms. Save factory hardware, you will need it for the rear installation.
- If it's necessary, clean both side of the shock mount. The brackets will need to be well leaning against the suspension arms, for a perfect installation.

INSTALLATION

1. Insert the front bracket in place on the suspension arm.
2. Install the bracket to the shock mount. Use M10-1.50 x 65mm bolt, 1-3/8" spacer and M10-1.50 lock nut.
3. Connect the bottom of the shock to the new shock location on the bracket. Use M10-1.50 x 65mm bolt, M10 heavy washers and M10-1.50 lock nut. Put one washer on each side of the shock eyelet.

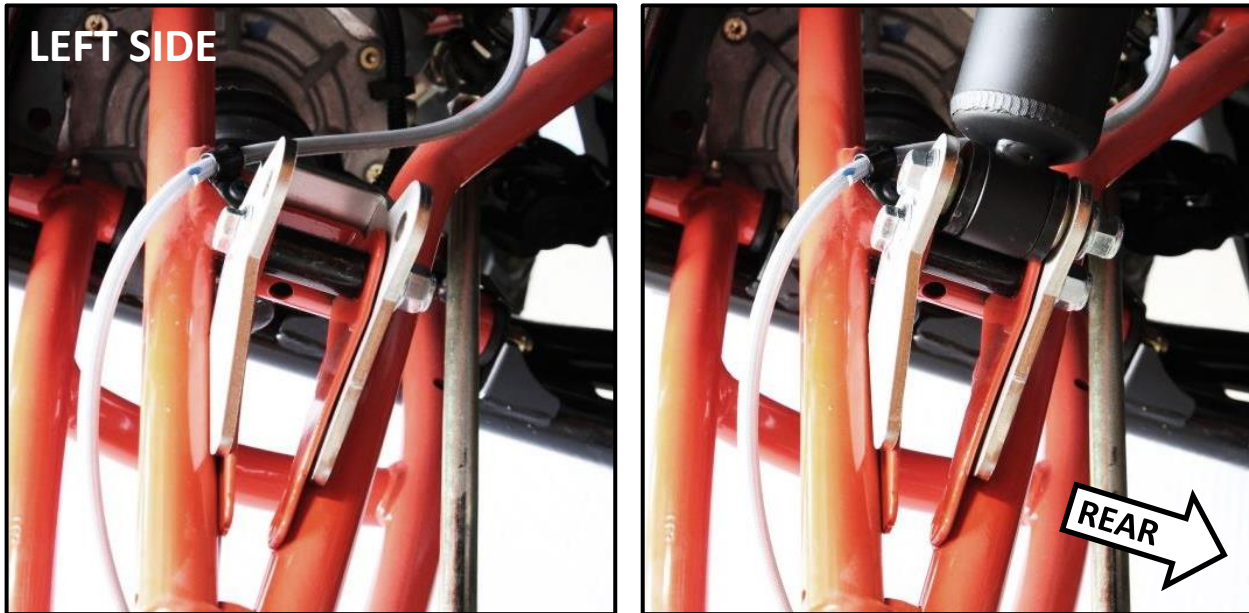

4. Repeat the same steps for the opposite side.
5. Once both brackets will be installed, lower back the ATV to the ground. Then, tight the hardware completely at this point. The brackets will be well leaning against the suspension arm using this way.

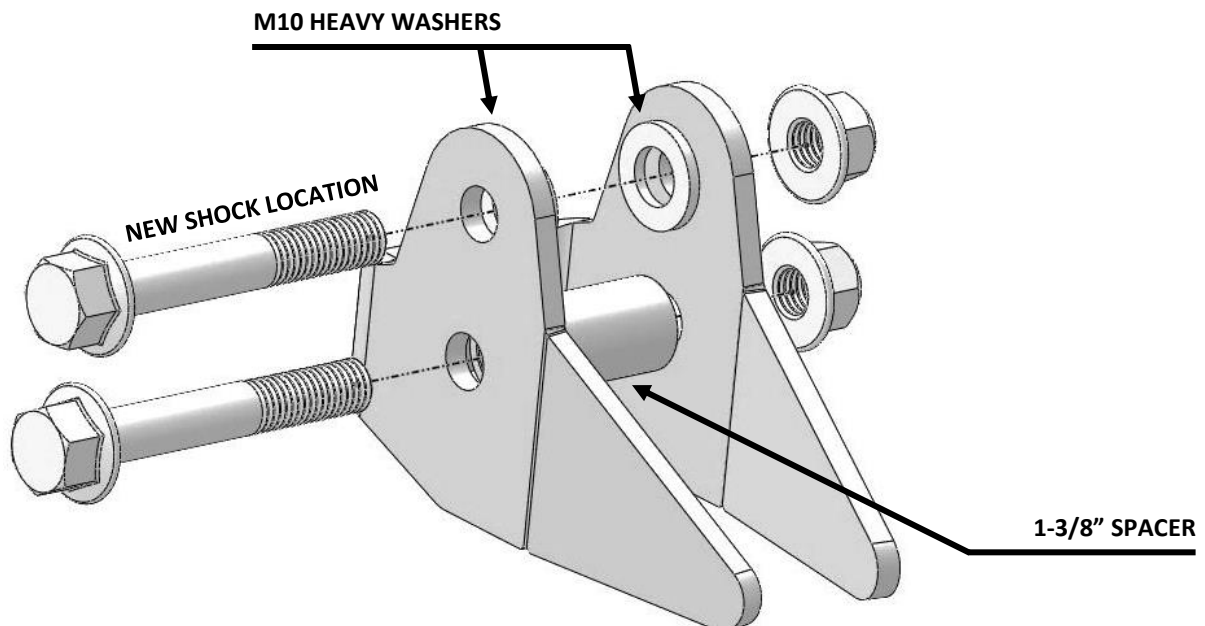

REAR INSTALLATION INSTRUCTIONS

PREPARATION

- Using a jack under center of rear end, lift until the rear wheels leave the ground.
- Remove the wheels.
- Disconnect and discard the sway bar links from the ATV, both sides. Save factory hardware.
- Disconnect the top of the shocks from the frame shock mount.

INSTALLATION

1. Install one rear bracket inside of the frame shock mount, face of the rear of the ATV. Use M10-1.50 x 60mm bolts and 1-1/16" spacers.

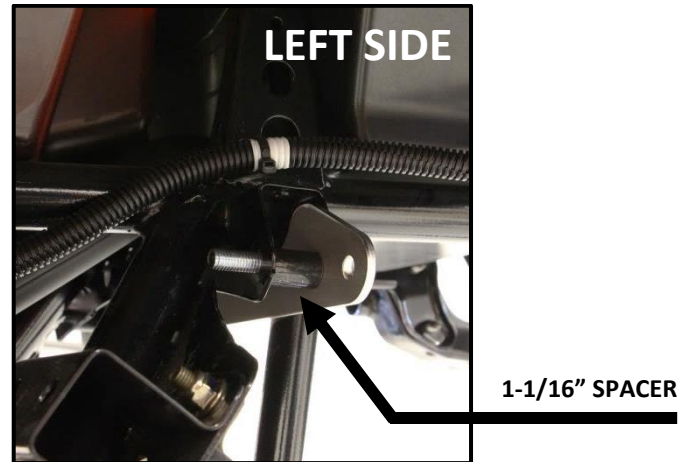
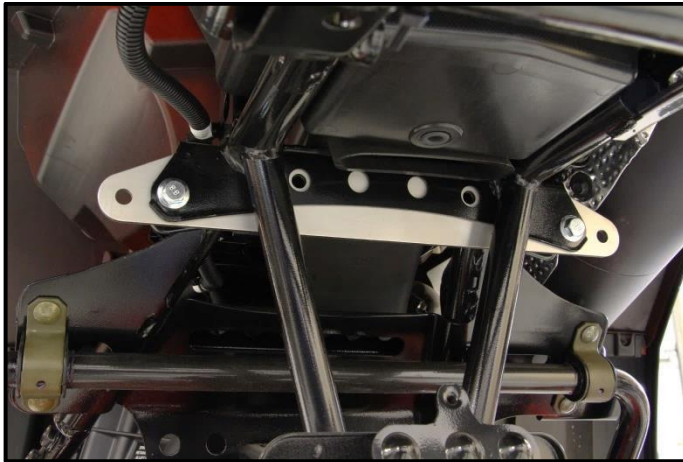

2. Secure the middle of the bracket to the frame. Use factory bolts of the bottom of the front shocks and 1-1/16" spacers.

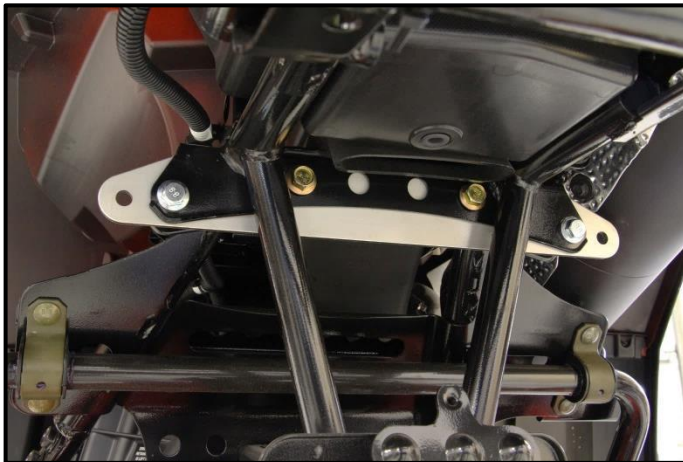

3. Put one M10 washer at the end of each bolts (4). Put the washers outside of the frame shocks mount, face of the front.

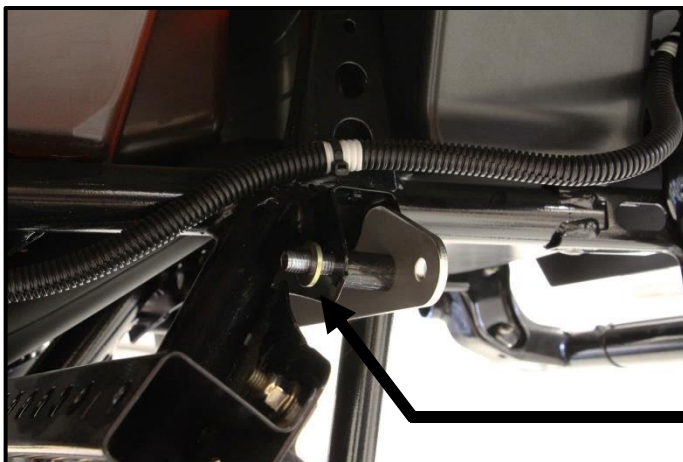

M10 WASHER

4. Insert the second rear bracket to the assembly, outside of the frame shock mount. Put the appropriated lock nut at the end of each bolts (4).



5. Connect the top of the shocks to the new shock location on the brackets. Use M10-1.50 x 60mm bolts and M10-1.50 lock nuts.
6. Tight all the hardware appropriately at this point.
7. Reconnect the sway bar to the suspension arms. Use the provided rear sway bar links with the factory hardware and rubbers.
8. Put the wheels back on the vehicle when the installation is finished. Torque all lugs to factory specification.

