

Owner's Manual

Safariland™ User's Guide

- 4) Push the outer locking forks under the first set of loops (loop row 2). It is critical that the inner tines go under the loops and not through them.

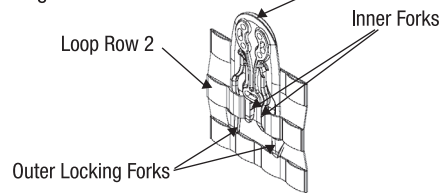

- 5) Push the outer locking forks and inner tines under the next set of loops (loop row 3). Make sure barbs of the outer locking tabs emerge under the bottom of the loops. This will ensure a positive lock-up with the vest.

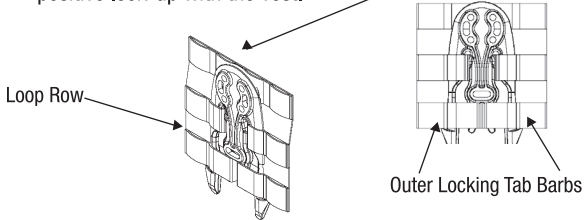

- 6) The MOLLE Accessory Mount is installed in the exact same manner, positive lock-up with the vest.

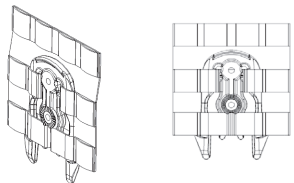

- 7) The MOLLE Holster Mount or the MOLLE Accessory Mount can be removed by squeezing the outer locking tabs together and pushing upward while pulling upward on the holster or other accessory.

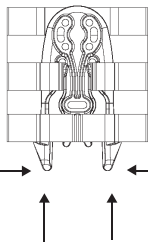

- 8) When the outer locking tabs push through loop row 3, only one of the outer locking tabs needs to be squeezed inward while pulling the holster upward to pull through loop row 2.

Owner's Manual

Safariland™ User's Guide

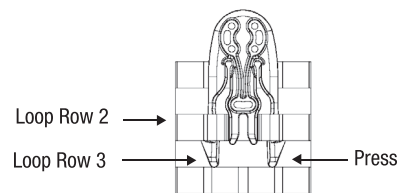

INSTALLING THE MOLLE RECEIVER PLATE WITH GUARD

- 1) The MOLLE Receiver Plate with Guard can be installed on any platform with a matching hole pattern, such as a Tactical Leg Shroud or Belt Loop Mount (UBL). The MOLLE Receiver Plate utilizes 3 T-nuts that need to be installed in order to fasten it to the desired mounting platform. The T-Nuts need to be installed from the front side with the barbs of the T-nut inserting into the matching hole patterns on the MOLLE Receiver Plate. The diagrams below indicate the T-nut installation locations. The non-serrated screws are then installed from the opposite side of the mounting platform and tightened.

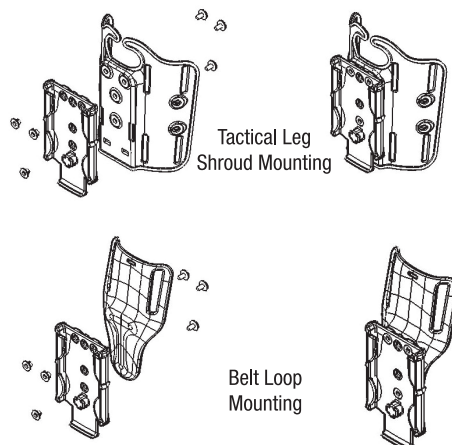

INSTALLING THE STANDARD MOLLE RECEIVER PLATE

- 1) The Standard MOLLE Receiver Plate can be mounted to any platform with a matching hole pattern, such as a MOLLE Adaptor Plate, however, it is recommended that it be mounted to the MOLLE Accessory Mount. The MOLLE Accessory Mount provides a much more secure and versatile mounting platform than most other adaptor plates. The MOLLE Accessory Mount also has the capability of allowing several other accessories to be mounted to it. The vertical 1-1/2", 2-hole pattern matches the mounting screw locations of many Safariland accessories such as Magazine Cases, Cuff-Cases, and Flashlight Cases. This allows for the quick arrangement and/or rearrangement of equipment on the MOLLE Vest with minimal effort.

Owner's Manual

Safariland™ User's Guide

- 2) The MOLLE Accessory Mount and the Standard MOLLE Receiver Plate have a locking spline ring that will allow for multiple orientation angles.

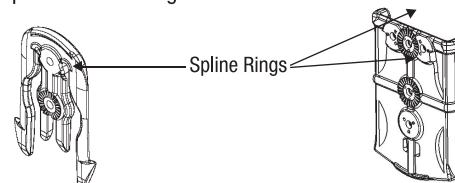

- 3) Insert a T-nut into the preferred spline ring hole pattern on the MOLLE Receiver Plate.

- 4) Align the spline ring on the MOLLE Accessory Mount with the desired spline ring on the Standard MOLLE Receiver Plate.

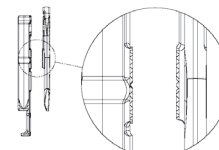

- 5) The spline allows the Standard MOLLE Receiver Plate to be mounted at 15° angle increments. Before tightening down the mounting screw, be sure you have the desired mounting angle correctly aligned. After the desired angle orientation is discovered, press the splines of both components together and tighten the screw. **Note: Do not use the serrated screws for this installation.**

The completed assembly can now be installed onto the MOLLE straps to accept equipment mounted on the accessory mount or the firearm mounted on the holster mount.

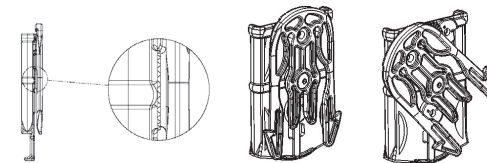

THE SAFARILAND GROUP

3120 East Mission Boulevard
Ontario, California 91761 U.S.A.
Tel (909) 923-7300 Fax (909) 923-7400
www.safariland.com www.holsters.com
©2014 Safariland, LLC

Owner's Manual

Safariland™ User's Guide

MOLLE LOCKING SYSTEM

Patents Pending

- 6004-15 MOLLE Holster Mount
6004-16 MOLLE Accessory Mount
6004-17 MOLLE Receiver Plate, Standard
6004-18 MOLLE Receiver Plate with Guard

PARTS LIST

Qty	Part	Qty
1	MOLLE Holster Mount	Qty = 1
2	MOLLE Accessory Mount	Qty = 1
3	MOLLE Receiver Plate, Standard	Qty = 1
4	MOLLE Receiver Plate with Guard	Qty = 1
5	1/2" Screw	Qty = 6
6	3/8" Screw	Qty = 3
7	3/8" Screw Serrated	Qty = 3
8	1/2" Screw Serrated	Qty = 3
9	T-Nut	Qty = 8
10	1/8" Hex Key	Qty = 1

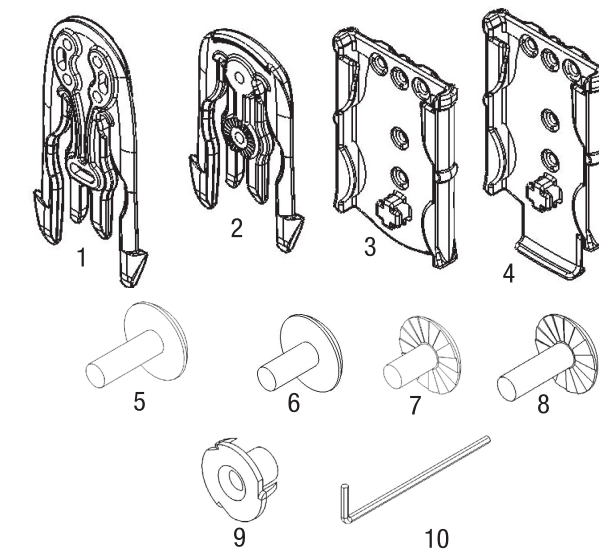

Read and understand entire manual before using product.

L/G 00000WHA-98 (09/14)

Owner's Manual

WARNING

Read and understand entire manual before using product.

Improper or careless use of a firearm or firearm and holster may result in serious injury or death. It is the user's responsibility to have a thorough knowledge of and be properly trained in all aspects of firearm and firearm accessory safety and use.

- ❑ Do not use a loaded handgun with any firearm accessory without first testing in the unloaded condition.
- ❑ Do not carry any handgun with a round in the chamber unless you have received professional training in use of the handgun and holster and are willing to assume responsibility and risk (including accidental discharge) of carrying a loaded handgun.
- ❑ If your handgun is equipped with a safety lever, be sure that safety is engaged when holstering the handgun.
- ❑ When drawing handgun from holster or replacing it in holster do not place finger in trigger guard, or near the trigger. Position trigger finger adjacent to but away from the trigger and, if possible, support tip of finger on the front of trigger guard.
- ❑ When putting handgun in holster always place thumb over the hammer or behind the slide.
- ❑ Always keep hammer strap and thumb break forward or clear of trigger guard when putting handgun in the holster. Do not allow strap or any other object to enter trigger guard.
- ❑ Always secure the retaining or safety strap(s) on holster after inserting handgun in holster.
- ❑ Never holster any semi-automatic handgun in a single-action mode (except handguns which are single action only; e.g.s., the Colt 1911 and the Browning Hi-Power style handgun).
- ❑ Do not attempt to cock a holstered handgun as this can cause severe damage to the handgun or holster or both and may contribute to an accidental discharge.
- ❑ Always place hand on the handgun and holster when running or performing other vigorous activity.
- ❑ Do not use customized, modified, worn or broken handguns or those that are not of original manufacturer's specifications in a Safariland holster.
- ❑ Do not, in any way, modify, disassemble or remove any part from this holster use.
- ❑ Do not expose accessories to extreme heat conditions.
- ❑ Do not leave accessories in trunk of vehicle during extremely hot weather.
- ❑ It is the user's responsibility to properly maintain accessories checking snaps, screws and other components for proper function.

Owner's Manual

Safariland™ User's Guide

WARNING! Never store your Safariland holster or accessories near a heat source. Space heaters, radiators, heating registers, fireplaces, or other heating sources emit high temperatures that can deform or destroy the polymer from which many Safariland products are manufactured. The non-reflective surface on Safariland products will efficiently absorb radiant heat and can reach temperatures in excess of 200 degrees Fahrenheit, even several feet away from certain heating sources. **Exposure to high heat can cause them to deform, and in some cases can cause the weapon to be locked in place.** If you have accidentally exposed your equipment to a heat source, you should immediately remove it from the area, allow it to cool to room temperature and then operate it to insure correct function.

Failure to heed these warnings or follow the operating instructions may result in accidental discharge of a handgun causing serious injury or death.

It is the user's responsibility to daily inspect the holster for signs of excessive wear, or loss of retention of the handgun, and tightness of all screws and hardware. If any possible problem is detected or any doubt exists, do not use. Call Safariland's Customer Care at (800) 347-1200 or (909) 923-7300.

EXPRESS LIMITED WARRANTY FOR HOLSTER AND ACCESSORY PRODUCTS

Safariland™ (the "Company") warrants its holster products to be free from defects in materials and workmanship for a period of two (2) years from date of purchase. This warranty is subject to the proper Care and Maintenance of the product and proper use of the product as detailed in the Consumer and Safety Information.

If you believe this product has any defects in materials or workmanship, cease use immediately and contact customer service for a remedy. If a product proves to be defective in material or workmanship, we will repair or replace the product and send it to you at the Company's expense. All returns must include the proof of purchase and documentation specifying the claimed defect.

This is a LIMITED WARRANTY, and is the sole and exclusive warranty of this product by the Company. It shall not be enlarged by any representations, descriptions, course of dealing, trade usage, rendering of technical advice, service or otherwise. Furthermore, it shall not be altered or expanded by any acts, statements, or agreements of any dealer, employee or agent of the Company (other than by a duly authorized officer of the Company).

THE COMPANY MAKES NO OTHER WARRANTIES EXPRESS, IMPLIED, OR STATUTORY, INCLUDING WITHOUT LIMITATION ANY IMPLIED WARRANTY OF FITNESS FOR A PARTICULAR PURPOSE

Owner's Manual

Safariland™ User's Guide

OR MERCHANTABILITY.

IN NO EVENT SHALL THE COMPANY BE LIABLE FOR ANY PUNITIVE, EXEMPLARY, OR CONSEQUENTIAL DAMAGES, ANTICIPATED OR LOST PROFITS, INCIDENTAL DAMAGES, LOSS OF TIME, OR OTHER INDIRECT LOSSES OR EXPENSES THAT ARISE FROM ANY CAUSE RELATING TO THE PRODUCT, REGARDLESS OF THE FORM OF THE ACTION, WHETHER IN TORT (INCLUDING NEGLIGENCE), CONTRACT, STRICT LIABILITY OR OTHERWISE, AND REGARDLESS OF WHETHER THE COMPANY HAS BEEN ADVISED OF THE POSSIBILITY OF SUCH CONSEQUENTIAL DAMAGES. SOME STATES DO NOT ALLOW THE EXCLUSION OR LIMITATION OF INCIDENTAL OR CONSEQUENTIAL DAMAGES, SO THE ABOVE LIMITATION OR EXCLUSION MAY NOT APPLY TO YOU. THIS WARRANTY GIVES YOU SPECIFIC LEGAL RIGHTS, AND YOU MAY ALSO HAVE OTHER RIGHTS WHICH VARY FROM STATE TO STATE.

For any warranty issue, please contact customer care for a prompt resolution to your concern at the number provided below

LOCKING THE MOLLE HOLSTER MOUNT INTO THE MOLLE RECEIVER PLATE (STANDARD OR WITH GUARD)

- 1) With the desired holster already installed on the MOLLE Holster Mount, align the outer locking tabs of the MOLLE Holster Mount with the vertical channels on the MOLLE Receiver Plate. **Note: MOLLE Holster Mount shown without holster for clarity.**

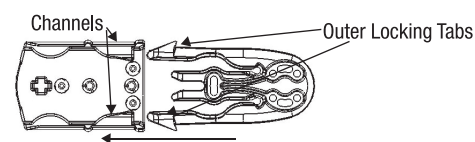

- 2) Slide the Holster with the MOLLE Holster Mount and the MOLLE Receiver Plate together until the outer locking tabs "click" into the locked position.

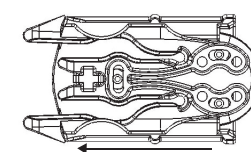

- 3) To remove the MOLLE Holster Mount from the MOLLE Receiver Plate, simply squeeze the outer locking tabs and pull the Holster with the MOLLE Holster Mount away.

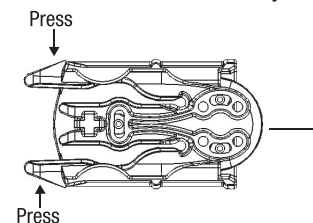

Owner's Manual

Safariland™ User's Guide

Operating Instructions

SETTING UP AND INSTALLING THE MOLLE HOLSTER MOUNT

- 1) Choose the orientation that is desired for your holster. The MOLLE Holster Mount is ambidextrous and can be mounted vertically or at 45°. Use the #8 Serrated Screws. There are 2 lengths of #8 serrated screws, 3/8" and 1/2". Choose the length that will provide the best securement without protruding through the inside of the holster. Because the mounting screws are serrated and cannot be easily removed once tightened, it is important to decide on the holster orientation before tightening the screws. The diagrams below show the 2 different mounting orientations for both right and left hand arrangements. **Note: Only the 2 upper screws are used for the 45° position.**

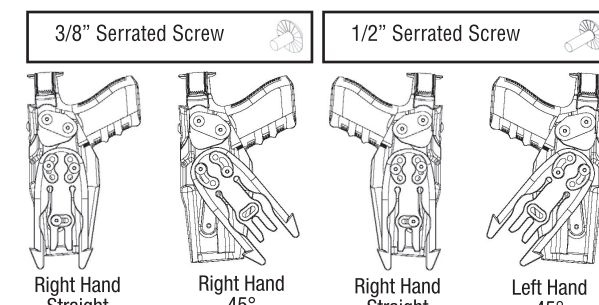

- 2) The MOLLE Holster Mount will occupy a space on the MOLLE Vest 2 columns wide by 3 rows high. The desired mounting location on the MOLLE Vest will need to be cleared of other equipment before a successful installation.

- 3) Align the outer locking forks with loop column 1 and 2 just above loop row 2 as shown in the diagram below. **Note: MOLLE Holster Mount shown without holster for clarity.**

