

WESTGATE

THE FUTURE IS HERE... AND IT'S QUITE BRIGHT!



Loving **Lighting!**



PRODUCTSHEET

2024 - SEASON 1



Westgatemfg.com | @westgatemfg    

CONTENTS

OUTDOOR LIGHTING	4	
INDUSTRIAL LIGHTING	59	
COMMERCIAL INDOOR LIGHTING	71	
RESIDENTIAL LIGHTING	121	
RIBBON LIGHTING	143	
LANDSCAPE LIGHTING	152	
UNDERCABINET LIGHTING	165	
EXIT & EMERGENCY LIGHTING	170	
ELECTRICAL PRODUCTS	177	
FINAL PRODUCTION DEALS	184	

WESTGATE

POLICIES

All transactions are subject to terms and conditions listed on Westgate website:



www.westgatemfg.com/terms-and-conditions

MCT₃ MCT₄ MCT₅ MP MCTP

MCT: Multi Color Temperature (Selectable), followed by 3 (3 CCT), 4 (4 CCT), 5 (5 CCT)

MP: Multi Power/Wattage (Selectable)

MCTP: Multi Color Temperature & Multi Power/Wattage (Selectable)

SR: Sensor Ready

EM: With presintalled Emergency

OPT: Customization Order-No Returnable

This season's New Arrivals



WPMX SERIES
PAGE 7



BKH SERIES
PAGE 8



CREA SERIES
PAGE 13



LRS-K SERIES
PAGE 21



LRS-MC SERIES
PAGE 22



LFXMAX SERIES
PAGE 26



VTA SERIES
PAGE 40



EXPF SERIES
PAGE 44



SOLN SERIES
PAGE 46



RMS SERIES
PAGE 62



SRPL SERIES
PAGE 62



LHXC SERIES
PAGE 63



LDL SERIES
PAGE 68



FEL SERIES
PAGE 73



LRP-HL SERIES
PAGE 75



LRT-HL SERIES
PAGE 75



SCXA2 SERIES
PAGE 76



CMC-RGBW SERIES
PAGE 108



WFL SERIES
PAGE 120



FDLS SERIES
PAGE 130



FMLS SERIES
PAGE 130

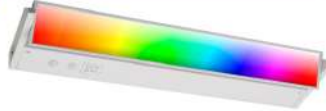

UCA-RGB SERIES
PAGE 166



UCE SERIES
PAGE 165

OUTDOOR LIGHTING

THUNDER SERIES
OUTDOOR LIGHTING



LWAX-SM
Dark Bronze



LWAX-MD
Dark Bronze



LWAX-LG
Dark Bronze



LWAX-SM
White



Shown with
Shroud

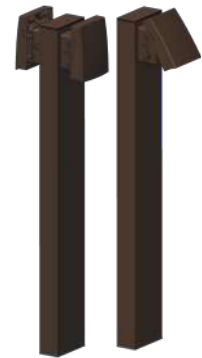

Mounting Options
Shown with LWAX-12W
(See page 55)

POWER & CCT-ADJUSTABLE CUTOFF WALL PACK, 120-277V TYPE 2 LENS

Dark Bronze & White



CATALOG NO.	DESCRIPTION	PKG. QTY.
LWAX-SM-12W-30K	12W 1500LM 3000K	12
LWAX-SM-12W-40K	12W 1500LM 4000K	12
LWAX-SM-12W-50K	12W 1500LM 5000K	12
LWAX-MD-30W-30K	30W 3900LM 3000K	4
LWAX-MD-30W-40K	30W 3900LM 4000K	4
LWAX-MD-30W-50K	30W 3900LM 5000K	4
LWAX-MD-20-50W-MCTP	20W/30W/40W/50W 125LM/W 30K/40K/50K/57K MCTP	4
LWAX-LG-50-120W-MCTP	50W/80W/100W/120W 130LM/W 30K/40K/50K/57K MCTP	2
LWAX-SM-12W-30K-WH	12W 1500LM 3000K	12
LWAX-SM-12W-50K-WH	12W 1500LM 5000K	12
LWA-SH1	Shroud For LWAX SM, Bronze	
LWA-SH2	Shroud For LWAX MD, Bronze	
LWA-SH3	Shroud For LWAX LG, Bronze	



FACTORY-INSTALLED OPTIONS, ENTER DESIRED OPTION CODE(S) AS LINE ITEMS ON YOUR PURCHASE ORDER UNDER THE PRODUCT CATALOG NUMBER

SIZE	EM OPTION	DESCRIPTION	PHOTOCELL	DESCRIPTION	PAINT	SENSOR	DESCRIPTION
SM	OPT-EM-LWAX-SM	EXTERNAL BACK BOX	OPT-PC-B	BUTTON	OPT-CLR-85(BK/GR/SR/WH)	OPT-SEN-3MRLV-5	PROGRAMMABLE MICROWAVE (BI-LEVEL)
MD	OPT-EM-LWAX-MD	INTERNAL	VANDAL.RES.	DESCRIPTION	OPT-CLR-85MC (260 SET UP FEE PER PROJECT)	WEC-8RC	OPTIONAL REMOTE
LG	OPT-EM-LWAX-LG	INTERNAL	OPT-TRS-T20	Tamper Resistant Screw			

FOR COLD-WEATHER EM OPTION SEE PAGE 176



LW360-25W-30K-G2
LW360-25W-40K-G2
LW360-25W-50K-G2
LW360-25W-MCT-G2
Bronze

LW360-40W-30K-G2
LW360-40W-40K-G2
LW360-40W-50K-G2
LW360-60W-30K-G2
LW360-60W-40K-G2
LW360-60W-50K-G2
LW360-60W-MCT-G2
LW360-80W-30K-G2
LW360-80W-40K-G2
LW360-80W-50K-G2
Bronze

LW360-120W-30K-G2
LW360-120W-40K-G2
LW360-120W-50K-G2
Bronze

LW360-25W-MCT-WH-G2
White

LW360-60W-MCT-WH-G2
White

Shown with
Extended EM Box
& Shroud

Rotatable Heads with set screw

LED 360° ROTATABLE WALL PACK, 120-277V
G2 SERIES OFFERS A LARGE, HINGED BACK BOX
ALSO, IN THIS SERIES, 25W & 60W AVAIL. WITH MULTI-COLOR-TEMP(MCT)

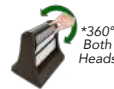

CATALOG NO.	DESCRIPTION	PKG. QTY.
LW360-25W-30K-G2	25W 3250LM 3000K Bronze	4
LW360-25W-40K-G2	25W 3250LM 4000K Bronze	4
LW360-25W-50K-G2	25W 3250LM 5000K Bronze	4
LW360-25W-MCT-G2	25W 3250LM 30K/40K/50K Bronze MCT	4
LW360-40W-30K-G2	40W 5200LM 3000K Bronze	4
LW360-40W-40K-G2	40W 5200LM 4000K Bronze	4
LW360-40W-50K-G2	40W 5200LM 5000K Bronze	4
LW360-60W-30K-G2	60W 7800LM 3000K Bronze	2
LW360-60W-40K-G2	60W 7800LM 4000K Bronze	2
LW360-60W-50K-G2	60W 7800LM 5000K Bronze	2
LW360-60W-MCT-G2	60W 7800LM 30K/40K/50K Bronze MCT	2
LW360-80W-30K-G2	80W 10400LM 3000K Bronze	2
LW360-80W-40K-G2	80W 10400LM 4000K Bronze	2
LW360-80W-50K-G2	80W 10400LM 5000K Bronze	2
LW360-120W-30K-G2	120W 15600LM 3000K Bronze	2
LW360-120W-40K-G2	120W 15600LM 4000K Bronze	2
LW360-120W-50K-G2	120W 15600LM 5000K Bronze	2
LW360-25W-MCT-WH-G2	25W 3250LM 30K/40K/50K White MCT	4
LW360-60W-MCT-WH-G2	60W 7800LM 30K/40K/50K White MCT	2
LW360-SH1	Shroud For LW360 Series, Bronze Finish	-

FOR FACTORY OPTION SEE LW360 BELOW
FOR COLD-WEATHER EM OPTION SEE PAGE 176

LED ROTATABLE WALL PACKS, 120-277V

Dark Bronze & White



CATALOG NO.	DESCRIPTION	REPLACEMENT RANGE	PKG. QTY.
LW360-60W-30K	60W 8100LM 3000K Bronze	200-300MH	2
LW360-80W-30K	80W 10800LM 3000K Bronze	250-400 MH	2
LW360-80W-40K	80W 10800LM 4000K Bronze	250-400 MH	2
LW360-25W-30K-WH	25W 3375LM 3000K White	100-150 MH	4
LW360-25W-50K-WH	25W 3375LM 5000K White	100-150 MH	4
LW360-40W-30K-WH	40W 5400LM 3000K White	100-200 MH	4
LW360-40W-50K-WH	40W 5400LM 5000K White	100-200 MH	4
LW360-SH1	Shroud For LW360 Series, Bronze Finish		-

FACTORY-INSTALLED OPTIONS, ENTER DESIRED OPTION CODE(S) AS LINE ITEMS ON YOUR PURCHASE ORDER UNDER THE PRODUCT CATALOG NUMBER

WATTS	EM OPTION	DESCRIP-	PHOTOCELL	DE-	PAINT	SENSOR	DESCRIPTION
25W, 40W, 60W, 80W	OPT-EM-LW360	INTERNAL	OPT-LW360-PC-B	BUTTON	OPT-CLR-85(BK/GR/SR/WH) OPT-CLR-95(BK/GR/SR/WH) OPT-CLR-35-SHR (BK/GR/SR/WH)	OPT-SEN-LW360-3MRLV-5	PROGRAMMABLE MICROWAVE
	OPT-EM-LW360-LG	INTERNAL				OPT-CLR-95MC (260 SET UP FEE PER PROJECT)	WEC-8RC

FOR COLD-WEATHER EM OPTION SEE PAGE 176



Shown Installed as Uplight



SPEC SERIES MODERN ADJUSTABLE WALL PACK FOR DOWN OR UP LIGHTING INSTALLATIONS WITH PHOTOCELL

OUTDOOR WALLPACKS

CATALOG NO.	DESCRIPTION	PKG. QTY.
WAX-20-40W-MCTP	20W/30W/40W 140LM/W 30K/40K/50K	1
WAX-50-80W-MCTP	50W/65W/80W 140LM/W 30K/40K/50K	1
WAX-90-120W-MCTP	90W/105W/120W 140LM/W 30K/40K/50K	1



FACTORY-INSTALLED OPTIONS, ENTER DESIRED OPTION CODE(S) AS LINE ITEMS ON YOUR PURCHASE ORDER UNDER THE PRODUCT CATALOG NUMBER

WATTS	EM OPTION	DESCRIPTION	PHOTOCELL	DESCRIPTION	PAINT	SENSOR	DESCRIPTION
40W	OPT-EM-WAX-40	INTERNAL	OPT-PC-B	BUTTON	OPT-CLR-85(BK/GR/SR/WH)	OPT-SEN-3MRLV-5	PROGRAMMABLE MICROWAVE (BI-LEVEL FOR 80W)
80W	OPT-EM-WAX-80	INTERNAL			OPT-CLR-85MC (260 SET UP FEE PER PROJECT)		
120W	OPT-EM-WAX-120	INTERNAL	480 V OPTION	DESCRIPTION		WEC-8RC	REMOTE CONTROL
	VANDAL RES.	DESCRIPTION	OPT-WP-480V	CHANGE VOLTAGE			
	OPT-TRS-T20	Tamper Resistant Screw					

FOR COLD-WEATHER EM OPTION SEE PAGE 176



20% Non-Cutoff Ambient Light

80% Full-Cutoff Light

SPEC SERIES MODERN POWER & CCT ADJUSTABLE CUT-OFF WALL PACK WITH 20% FRONT LIGHT & PHOTOCELL



CATALOG NO.	DESCRIPTION	PKG. QTY.
WPAX-100W-MCTP	60W/80W/100W 130LM/W 30K/40K/50K	2



FACTORY-INSTALLED OPTIONS, ENTER DESIRED OPTION CODE(S) AS LINE ITEMS ON YOUR PURCHASE ORDER UNDER THE PRODUCT CATALOG NUMBER

WATTS	EM OPTION	DESCRIPTION	PHOTOCELL	DESCRIPTION	PAINT	SENSOR	DESCRIPTION
All	OPT-EM-WPAX	INTERNAL	OPT-PC-B	BUTTON	OPT-CLR-85(BK/GR/SR/WH)	OPT-SEN-3MRLV-5	PROGRAMMABLE MICROWAVE (BI-LEVEL FOR 80W)
	VANDAL RES.	DESCRIPTION	480 V OPTION	DESCRIPTION	OPT-CLR-85MC (260 SET UP FEE PER PROJECT)		
	OPT-TRS-T20	Tamper Resistant Screw	OPT-WP-480V	CHANGE VOLTAGE		WEC-8RC	REMOTE CONTROL

FOR COLD-WEATHER EM OPTION SEE PAGE 176



WPFX-SM



WPFX-MD



WPFX-LG

BUILDER SERIES FLAT WALL PACK WITH PHOTOCELL, GLASS LENS AND VANDAL SCREWS



CATALOG NO.	DESCRIPTION	PKG. QTY.
WPFX-SM-15-40W-MCTP-P	15W/25W/40W 130LM/W 30K/40K/50K	1
WPFX-MD-20-40W-MCTP-P	20W/30W/40W 135LM/W 30K/40K/50K	1
WPFX-MD-40-80W-MCTP-P	40W/60W/80W 130LM/W 30K/40K/50K	1
WPFX-LG-80-120W-MCTP-P	80W/100W/120W 130LM/W 30K/40K/50K	1



FACTORY-INSTALLED OPTIONS, ENTER DESIRED OPTION CODE(S) AS LINE ITEMS ON YOUR PURCHASE ORDER UNDER THE PRODUCT CATALOG NUMBER

SIZE	EM OPTION	DESCRIPTION	PHOTOCELL	DESCRIPTION	PAINT	SENSOR	DESCRIPTION
SM	OPT-EM-WPFX-SM	INTERNAL	OPT-PC-B	BUTTON	OPT-CLR-85(BK/GR/SR/WH)	OPT-SEN-3MRLV-5	PROGRAMMABLE MICROWAVE (BI-LEVEL FOR 80W)
MD	OPT-EM-WPFX-MD	INTERNAL			OPT-CLR-85MC (260 SET UP FEE PER PROJECT)		
LG	OPT-EM-WPFX-LG	INTERNAL	480 V OPTION	DESCRIPTION		WEC-8RC	REMOTE CONTROL
	VANDAL RES.	DESCRIPTION	OPT-WP-480V	CHANGE VOLTAGE			
	OPT-TRS-T20	Tamper Resistant Screw					

FOR COLD-WEATHER EM OPTION SEE PAGE 176



Sensor-Ready
Plug & Play

HALF-MOON WALL PACK-POWER & CCT ADJUSTABLE, SENSOR READY



CATALOG NO.	DESCRIPTION	ARRIVES THIS SEASON CHECK & PRE-ORDER	PKG. QTY.
WPMX-24-40W-MCTP-SR	24W/32W/40W 135LM/W 30K/40K/50K		1
WPMX-48-80W-MCTP-SR	48W/64W/80W 135LM/W 30K/40K/50K		1
WEC-3MR-72-TLB-BK	600W Max, Zhaga 12-24VDC Microwave Sensor, Black, With Base (Optional Remote Control WEC-3RC)		
WEC-3MBT-72-TLB-BK	600W Max, Zhaga 12-24VDC Microwave Sensor, Bluetooth App Ready, Black, With Base (Optional Remote Control WEC-3RC)		
WEC-3PR-72-TLB-WH	600W Max, Zhaga 12-24VDC PIR Sensor, White, With Base (Optional Remote Control WEC-3RC)		

120-277V SPEC SERIES X-GEN CUT-OFF WALL PACK (POWER & COLOR TEMP. TUNABLE)

TYPE 3 LENS



CATALOG NO.	DESCRIPTION	PKG. QTY.
WPX-42W-MCTP	11W/21W/32W/42W 135LM/W 3000K/4000K/5000K 10"W	4
WPX-80W-MCTP	20W/40W/60W/80W 135LM/W 3000K/4000K/5000K 12"W	2

FACTORY-INSTALLED OPTIONS, ENTER DESIRED OPTION CODE(S) AS LINE ITEMS ON YOUR PURCHASE ORDER UNDER THE PRODUCT CATALOG NUMBER

WATTS	EM OPTION	DESCRIPTION	PHOTOCELL	DESCRIPTION	PAINT	SENSOR	DESCRIPTION
42W	OPT-EM-WPX-42	INTERNAL	OPT-PC-B	BUTTON	OPT-CLR-85(BK/GR/SR/WH)	OPT-SEN-3MRLV-5	PROGRAMMABLE MICROWAVE
80W	OPT-EM-WPX-80	INTERNAL			OPT-CLR-85MC (260 SET UP FEE PER PROJECT)		(BI-LEVEL FOR 80W)
	VANDAL RES.	DESCRIPTION	480 V OPTION	DESCRIPTION		WEC-8RC	REMOTE CONTROL
	OPT-TRS-T20	Tamper Resistant Screw	OPT-WP-480V	CHANGE VOLTAGE			

FOR COLD-WEATHER EM OPTION SEE PAGE 176

LED CUTOFF WALL PACK, 120-277V, 14" (W) x 9 1/4" (H) x 8 1/4" (D)

TYPE 2 LENS



CATALOG NO.	DESCRIPTION	PKG. QTY.
LWPX-30-80W-MCTP	30W/40W/60W/80W 125LM/W 30K/40K/50K/57K	1
LWPX-50W-30K	50W 6600LM 3000K	1
LWPX-50W-40K	50W 6600LM 4000K	1
LWPX-50W-50K	50W 6600LM 5000K	1

FACTORY-INSTALLED OPTIONS, ENTER DESIRED OPTION CODE(S) AS LINE ITEMS ON YOUR PURCHASE ORDER UNDER THE PRODUCT CATALOG NUMBER

WATTS	EM OPTION	DESCRIPTION	PHOTOCELL	DESCRIPTION	PAINT	SENSOR	DESCRIPTION
50W	OPT-EM-LWPX-50	INTERNAL	OPT-PC-B	BUTTON	OPT-CLR-85(BK/GR/SR/WH)	OPT-SEN-3MRLV-5	PROGRAMMABLE MICRO-WAVE (BI-LEVEL FOR 80W)
80W	OPT-EM-LWPX-80	INTERNAL			OPT-CLR-85MC (260 SET UP FEE PER PROJECT)		
	VANDAL RES.	DESCRIPTION	480 V OPTION	DESCRIPTION		WEC-8RC	REMOTE CONTROL
	OPT-TRS-T20	Tamper Resistant Screw	OPT-WP-480V	CHANGE VOLTAGE			

FOR COLD-WEATHER EM OPTION SEE PAGE 176

LED SEMI-CUTOFF VANDAL-PROOF WALL PACK, 120-277V

Dark Bronze



CATALOG NO.	DESCRIPTION	REPLACEMENT RANGE	PKG. QTY.
LTW-50CW	50W 4400LM 5000K	150-250 MH	1
LTW-50NW	50W 4400LM 4000K	150-250 MH	1
LTW-50WW	50W 4400LM 3000K	150-250 MH	1

FACTORY-INSTALLED OPTIONS, ENTER DESIRED OPTION CODE(S) AS LINE ITEMS ON YOUR PURCHASE ORDER UNDER THE PRODUCT CATALOG NUMBER

WATTS	EM OPTION	DESCRIPTION	PHOTOCELL	DESCRIPTION	PAINT	SENSOR	DESCRIPTION
ALL	OPT-EM-LTW	INTERNAL	OPT-PC-B	BUTTON	N/A	OPT-SEN-3MRLV-5	PROGRAMMABLE MICROWAVE BI-LEVEL
	480 V OPTION	DESCRIPTION	VANDAL RES.	DESCRIPTION		WEC-8RC	REMOTE CONTROL
	OPT-WP-480V	CHANGE VOLTAGE	OPT-TRS-T20	Tamper Resistant Screw			

OUTDOOR
WALLPACKS

LED VERSATILE WALL OR CEILING LIGHT, 120-277V



CATALOG NO.	DESCRIPTION	REPLACEMENT RANGE	PKG. QTY.
WMV-20W-50K	20W 2000LM 5000K 11.4"(L) X 4.5"(W) X 3.5"(H)	50-100 MH	6
WMV-20W-40K	20W 1900LM 4000K 11.4"(L) X 4.5"(W) X 3.5"(H)	50-100 MH	6
WMV-20W-30K	20W 1800LM 3000K 11.4"(L) X 4.5"(W) X 3.5"(H)	50-100 MH	6

FACTORY-INSTALLED OPTIONS, ENTER DESIRED OPTION CODE(S) AS LINE ITEMS ON YOUR PURCHASE ORDER UNDER THE PRODUCT CATALOG NUMBER

WATTS	EM OPTION	DESCRIPTION	PHOTOCELL DESCRIPTION	PAINT	SENSOR	DESCRIPTION
ALL	OPT-EM-WMV	INTERNAL	OPT-PC-B BUTTON	OPT-CLR-70(BK/GR/SR/WH)	OPT-SEN-3MRLV-5	PROGRAMMABLE MICROWAVE BI-LEVEL
	VANDAL RES.	DESCRIPTION		OPT-CLR-70MC (260 SET UP FEE PER PROJECT)	WEC-8RC	REMOTE CONTROL
	OPT-TRS-T20	Tamper Resistant Screw				

TRADITIONAL BULKHEADS, POWER & CCT SELECTABLE, WITH PHOTOCELL



CATALOG NO.	DESCRIPTION	REPLACEMENT RANGE	PKG. QTY.
BKH-10W-MCTP-BK-P	6W/8W/10W 85LM/W 30K/40K/50K		8
BKH-10W-MCTP-BR-P	6W/8W/10W 85LM/W 30K/40K/50K		8
BKH-20W-MCTP-BK-P	12W/18W/20W 85LM/W 30K/40K/50K		6
BKH-20W-MCTP-BR-P	12W/18W/20W 85LM/W 30K/40K/50K		6

FACTORY-INSTALLED OPTIONS, ENTER DESIRED OPTION CODE(S) AS LINE ITEMS ON YOUR PURCHASE ORDER UNDER THE PRODUCT CATALOG NUMBER

WATTS	EM OPTION	DESCRIPTION	VANDAL RES.	DESCRIPTION	PAINT	SENSOR	DESCRIPTION
20W	OPT-EM-BKH	INTERNAL		N/A	N/A	N/A	N/A



BUILDER SERIES TRADITIONAL GLASS LENS WALL PACK WITH PHOTOCELL (PHOTOCELL DISCONNECT SWITCH)



CATALOG NO.	DESCRIPTION	PKG. QTY.
-------------	-------------	-----------

POWER ADJUSTABLE BUILDER SERIES TRADITIONAL WALL PACK

WMXE-MD-25-65W-50K-P	25W/45W/65W 140LM/W 5000K	2
WMXE-MD-45-85W-50K-P	45W/65W/85W 140LM/W 5000K	2
WMXE-MD-80-120W-50K-P	80W/100W/120W 140LM/W 5000K	2

POWER & 3CCT ADJUSTABLE BUILDER SERIES TRADITIONAL WALL PACK

WMXE-MD-25-65W-MCTP-P	25W/45W/65W 140LM/W 3000K/4000K/5000K	2
WMXE-MD-45-85W-MCTP-P	45W/65W/85W 140LM/W 3000K/4000K/5000K	2
WMXE-MD-80-120W-MCTP-P	80W/100W/120W 140LM/W 3000K/4000K/5000K	2
WMXE-LG-100-150W-MCTP-P	100W/120W/150W 140LM/W 3000K/4000K/5000K	1
WMXE-MD-45-85W-MCTP-P-BK	45W/65W/85W 140LM/W 3000K/4000K/5000K	2
WMXE-LG-100-150W-MCTP-P-BK	100W/120W/150W 140LM/W 3000K/4000K/5000K	1

POWER & 3CCT ADJUSTABLE BUILDER SERIES TRADITIONAL WALL PACK WITH EMERGENCY BACKUP

WMXE-MD-25-65W-MCTP-P-EM	25W/45W/65W 140LM/W 30K/40K/50K	2
WMXE-MD-45-85W-MCTP-P-EM	45W/65W/85W 140LM/W 30K/40K/50K	2
WMXE-MD-80-120W-MCTP-P-EM	80W/100W/120W 140LM/W 30K/40K/50K	2
WMXE-LG-100-150W-MCTP-P-EM	100W/120W/150W 140LM/W 30K/40K/50K	1

FOR COLD-WEATHER EM OPTION SEE PAGE 176

LED NON-CUTOFF WALL PACKS, 120-277V

Dark Bronze



CATALOG NO.	DESCRIPTION	REPLACEMENT RANGE	PKG. QTY.
WML-HL-30W-30K	30W 4200LM 3000K	100-150 MH	4
WML-HL-60W-30K	60W 8700LM 3000K	175-250 MH	2
WML-HL-80W-30K	80W 11600LM 3000K	250-400 MH	2

FOR COLD-WEATHER EM OPTION SEE PAGE 176 FOR SHIELD SEE WMX BELOW

FACTORY-INSTALLED OPTIONS, ENTER DESIRED OPTION CODE(S) AS LINE ITEMS ON YOUR PURCHASE ORDER UNDER THE PRODUCT CATALOG NUMBER

WATTS	EM OPTION	DESCRIPTION	PHOTOCELL DESCRIPTION	PAINT	SENSOR	DESCRIPTION
30W	OPT-EM-OD1INT	EXTERNAL BOX			OPT-SEN-3MRLV-5	PROGRAMMABLE MICROWAVE BI-LEVEL
50W, 60W	OPT-EM-OD3INT	INTERNAL	OPT-PC-B BUTTON	N/A	WEC-8RC	REMOTE CONTROL
80W, 120W-LG	OPT-EM-OD3INT	INTERNAL			480 V OPTION	DESCRIPTION
	VANDAL RES.	DESCRIPTION			OPT-WP-480V	CHANGE VOLTAGE
	OPT-TRS-T20	Tamper Resistant Screw				

OUTDOOR WALLPACKS



WMX-SM
Dark Bronze



WMX-MD
Dark Bronze



WMX-LG
Dark Bronze



Shield
For WMX Series

SPEC SERIES TRADITIONAL WALL PACK, GLASS LENS



CATALOG NO.	DESCRIPTION					PKG. QTY.
SPEC SERIES TRADITIONAL WALL PACK, POWER ADJUSTABLE						
WMX-SM-15-30W-30K	15W/20W/25W/30W	130LM/W	3000K	Replaces WML-HL-30W		4
WMX-SM-15-30W-40K	15W/20W/25W/30W	130LM/W	4000K	Replaces WML-HL-30W		4
WMX-SM-15-30W-50K	15W/20W/25W/30W	130LM/W	5000K	Replaces WML-HL-30W		4
WMX-MD-20-50W-30K	20/30W/40W/50W	130LM/W	3000K	Replaces WML-HL-50W		2
WMX-MD-20-50W-40K	20/30W/40W/50W	130LM/W	4000K	Replaces WML-HL-50W		2
WMX-MD-20-50W-50K	20/30W/40W/50W	130LM/W	5000K	Replaces WML-HL-50W		2
WMX-MD-20-80W-30K	20W/40W/60W/80W	130LM/W	3000K	Replaces WML-HL-60W TO 80W		2
WMX-MD-20-80W-40K	20W/40W/60W/80W	130LM/W	4000K	Replaces WML-HL-60W TO 80W		2
WMX-MD-20-80W-50K	20W/40W/60W/80W	130LM/W	5000K	Replaces WML-HL-60W TO 80W		2
WMX-LG-50-120W-30K	50W/80W/100W/120W	130LM/W	5000K	Replaces WML-HL-100W TO 120W		1
WMX-LG-50-120W-40K	50W/80W/100W/120W	130LM/W	5000K	Replaces WML-HL-100W TO 120W		1
WMX-LG-50-120W-50K	50W/80W/100W/120W	130LM/W	5000K	Replaces WML-HL-100W TO 120W		1
SPEC SERIES TRADITIONAL WALL PACK, POWER & CCT ADJUSTABLE						
WMXPRO-SM-15-30W-MCTP	15W/20W/25W/30W	130LM/W	30K/40K/50K/57K			4
WMXPRO-MD-20-60W-MCTP	20W/30W/50W/60W	130LM/W	30K/40K/50K/57K			2
WMXPRO-MD-20-80W-MCTP	20W/40W/60W/80W	130LM/W	30K/40K/50K/57K			2
WMXPRO-LG-50-120W-MCTP	50W/80W/100W/120W	130LM/W	30K/40K/50K/57K			1
WMX-MCTP-D	80W Max	9000LM Max	3000K-5700K			2
WMX-MCTP-D-WH	80W Max	9000LM Max	3000K-5700K			2
MCTP-RC1	Remote Control for Multi-Color Temp. & Power Outdoor Fixture (Required & One per projects)					
WML-SH2	Shield For WML 50W, 60W, 80W, 100W, WMX					-
WML-SH3	Shield For FOR WML 120W					-



FOR COLD-WEATHER EM OPTION SEE PAGE 176

FACTORY-INSTALLED OPTIONS, ENTER DESIRED OPTION CODE(S) AS LINE ITEMS ON YOUR PURCHASE ORDER UNDER THE PRODUCT CATALOG NUMBER

SIZE	EM OPTION	DESCRIPTION	PHOTOCELL DESCRIPTION	PAINT	SENSOR	DESCRIPTION
SM	OPT-EM-WMX-SM	EXTERNAL BOX	OPT-PC-B BUTTON	OPT-CLR-85(BK/GR/SR/WH) OPT-CLR-95(BK/GR/SR/WH) OPT-CLR-95MC (260 SET UP FEE PER PROJECT)	OPT-SEN-3MRLV-5	PROGRAMMABLE MICRO-WAVE BI-LEVEL
MD	OPT-EM-WMX-MD	INTERNAL				
LG	OPT-EM-WMX-LG	INTERNAL				
	VANDAL RES.	DESCRIPTION			WEC-8RC	REMOTE CONTROL
	OPT-TRS-T20	Tamper Resistant Screw			480 V OPTION	DESCRIPTION
					OPT-WP-480V	CHANGE VOLTAGE

LED NON-CUTOFF WALL PACKS WITH DIRECTIONAL OPTIC LENS, 120-277V



CATALOG NO.	DESCRIPTION			REPLACEMENT RANGE	WHILE SUPPLIES LAST	PKG. QTY.
	WML2-28W-50K-HL-SM	28W	3780LM	5000K W:10"	100-150 MH	4
	WML2-28W-40K-HL-SM	28W	3640LM	4000K W:10"	100-150 MH	4
	WML2-50W-40K-SM	50W	5750LM	4000K W:10"	100-200 MH	4
	WML2-50W-30K-SM	50W	5500LM	3000K W:10"	100-200 MH	4
	WML2-50W-30K-HL	48W	6000LM	3000K W:14-1/4"	175-250 MH	1



FOR COLD-WEATHER EM OPTION SEE PAGE 176

FACTORY-INSTALLED OPTIONS, ENTER DESIRED OPTION CODE(S) AS LINE ITEMS ON YOUR PURCHASE ORDER UNDER THE PRODUCT CATALOG NUMBER

WATTS	EM OPTION	DESCRIPTION	PHOTOCELL DESCRIP-	PAINT	SENSOR	DESCRIPTION
28W-SM, 50W-SM	OPT-EM-LSW	INTERNAL	OPT-PC-B BUTTON	OPT-CLR-85(BK/GR/SR/WH) OPT-CLR-95(BK/GR/SR/WH) OPT-CLR-95MC (260 SET UP FEE PER PROJECT)	OPT-SEN-3MRLV-5	PROGRAMMABLE MICROWAVE (BI-LEVEL FOR 80W & UP)
50W-HL	OPT-EM-OD1INT	INTERNAL				
80W-HL, 120W-HL-LG, 150-LG	OPT-EM-OD2INT	INTERNAL				
	VANDAL RES.	DESCRIPTION			WEC-8RC	REMOTE CONTROL
	OPT-TRS-T20	Tamper Resistant Screw			480 V OPTION	DESCRIPTION
					OPT-WP-480V	CHANGE VOLTAGE



LMW
Bronze



LMW
White



Shown with EM



Shown with EM



Shown with Sensor



Shown with Sensor

LED MINI CUTOFF WALLPACK, 120-277V, 5" X 5"

See Below for bollard customization

Dark Bronze & White



CATALOG NO.	DESCRIPTION					PKG. QTY.
LMW-12W-30K	12W	1300LM	3000K	Bronze		12
LMW-12W-40K	12W	1300LM	4000K	Bronze		12
LMW-12W-50K	12W	1300LM	5000K	Bronze		12
LMW-12W-30K-WH	12W	1300LM	3000K	White		12
LMW-12W-40K-WH	12W	1300LM	4000K	White		12
LMW-12W-50K-WH	12W	1300LM	5000K	White		12
LMW-12W-30K-BK	12W	1320LM	3000K	Black		12
LMW-12W-40K-BK	12W	1320LM	4000K	Black		12
LMW-12W-50K-BK	12W	1320LM	5000K	Black		12

POWER & CTT - ADJUSTABLE LED MINI CUTOFF WALLPACK, 120-277V, 5" X 5"

LMW-10-24W-MCTP-P	10W/15W/24W	110LM/W	30K/40K/50K	Bronze		12
LMW-10-24W-MCTP-P-BK	10W/15W/24W	110LM/W	30K/40K/50K	White		12
LMW-10-24W-MCTP-P-WH	10W/15W/24W	110LM/W	30K/40K/50K	Black		12

FOR BOLLARD SETTINGS SEE PAGE 55



FACTORY-INSTALLED OPTIONS, ENTER DESIRED OPTION CODE(S) AS LINE ITEMS ON YOUR PURCHASE ORDER UNDER THE PRODUCT CATALOG NUMBER

WATTS	EM OPTION	DESCRIPTION	PHOTOCELL DESCRIP-	PAINT	SENSOR	DESCRIPTION	
ALL	OPT-EM-LMW	EXTERNAL BACK BOX	OPT-PC-BI	N/A	OPT-SEN-LMW	PROGRAMMABLE MICROWAVE BI-LEVEL (ONLY 2" & 3")	
	OPT-EM-LMW-WH	EXTERNAL BACK BOX				OPT-SEN-LMW-WH	PROGRAMMABLE MICROWAVE BI-LEVEL, WHITE (ONLY 2" & 3")
	0-10V DIM OPTION	DESCRIPTION					
	OPT-010DIM	0-10V Dimming					



WMS-S-50K-BR
WMS-S-30K-BR
Bronze



WMS-R-50K-BR
WMS-R-50K-BR
Bronze



WMS-S-50K-WH
WMS-S-30K-WH
White



WMS-R-50K-WH
WMS-R-50K-WH
White



Shown with EM



Shown with EM

LED WALL/STEP LIGHTS, 120-277V

Dark Bronze & White



CATALOG NO.	DESCRIPTION					PKG. QTY.
WMS-S-50K-BR	6W	660LM	5000K			24
WMS-S-30K-BR	6W	630LM	3000K			24
WMS-R-50K-BR	6W	660LM	5000K			24
WMS-R-30K-BR	6W	630LM	3000K			24
WMS-S-50K-WH	6W	660LM	5000K			24
WMS-S-30K-WH	6W	630LM	3000K			24
WMS-R-50K-WH	6W	660LM	5000K			24
WMS-R-30K-WH	6W	630LM	3000K			24

FOR BOLLARD SETTINGS SEE PAGE 55



FACTORY-INSTALLED OPTIONS, ENTER DESIRED OPTION CODE(S) AS LINE ITEMS ON YOUR PURCHASE ORDER UNDER THE PRODUCT CATALOG NUMBER

WATTS	EM OPTION	DESCRIPTION	PHOTOCELL DESCRIPTION	PAINT	SENSOR	DESCRIPTION	
6W	OPT-EM-WMS	EXTERNAL BACK BOX	N/A	OPT-CLR-65(BK/GR/SR/WH)	OPT-SEN-LMW	PROGRAMMABLE MICROWAVE	
6W	OPT-EM-WMS-WH	EXTERNAL BACK BOX				OPT-SEN-LMW-WH	PROGRAMMABLE MICROWAVE, WHITE
POST ALL MODELS	OPT-EM-WMS-POST	POST MOUNT					

LED SMALL (11") WALL PACK WITH PHOTOCELL 120-277V TYPE 2 LENS



120-277V



CATALOG NO.	DESCRIPTION	PKG. QTY.
POWER-ADJUSTABLE SMALL WALL PACK WITH PHOTOCELL MFP		
LSWX-5-30W-30K-PC	5W/10W/20W/30W 124LM/W 3000K	6
LSWX-5-30W-40K-PC	5W/10W/20W/30W 124LM/W 4000K	6
LSWX-5-30W-50K-PC	5W/10W/20W/30W 124LM/W 5000K	6
SINGLE POWER AND CCT SMALL WALL PACK WITH PHOTOCELL		
LSWX-20W-30K-PC	20W 2450LM 3000K	6
LSWX-20W-50K-PC	20W 2450LM 5000K	6



FACTORY-INSTALLED OPTIONS, ENTER DESIRED OPTION CODE(S) AS LINE ITEMS ON YOUR PURCHASE ORDER UNDER THE PRODUCT CATALOG NUMBER

WATTS	EM OPTION	DESCRIPTION	PHOTOCELL DESCRIPTION	PAINT	SENSOR	DESCRIPTION
ALL	OPT-EM-LSWX	INTERNAL	OPT-NOPC	N/A	OPT-SEN-SLPIR	EXTERNAL, SECURITY LIGHT TYPE
	VANDAL RES.	DESCRIPTION				
	OPT-TRS-T20	Tamper Resistant Screw				

MODERN LED SMALL (8.5") WALL PACK WITH PHOTOCELL, 120-277V

Dark Bronze & White



120-277V



CATALOG NO.	DESCRIPTION	PKG. QTY.
SINGLE POWER & CCT LED SMALL NON-CUTOFF WALL PACK WITH PHOTOCELL		
LESW-15W-30K-P	15W 1675LM 3000K Bronze	10
LESW-15W-50K-P	15W 1875LM 5000K Bronze	10
LESW-20W-30K-P	20W 2300LM 3000K Bronze	10
LESW-20W-50K-P	20W 2500LM 5000K Bronze	10
LESW-15W-30K-P-WH	15W 1675LM 3000K White	10
LESW-15W-50K-P-WH	15W 1875LM 5000K White	10
LESW-20W-30K-P-WH	20W 2300LM 3000K White	10
LESW-20W-50K-P-WH	20W 2500LM 5000K White	10

POWER & CCT - ADJUSTABLE LED SMALL NON-CUTOFF WALL PACK WITH PHOTOCELL MCTP

LESW-8-15W-MCTP-P	8W/12W/15W 135LM/W 30K/40K/50K Bronze	
LESW-8-15W-MCTP-WH	8W/12W/15W 135LM/W 30K/40K/50K White	
LESW-15-30W-MCTP-P	15W/20W/30W 135LM/W 3000K/4000K/5000K Bronze	10
LESW-15-30W-MCTP-P-WH	15W/20W/30W 135LM/W 3000K/4000K/5000K White	10



FACTORY-INSTALLED OPTIONS, ENTER DESIRED OPTION CODE(S) AS LINE ITEMS ON YOUR PURCHASE ORDER UNDER THE PRODUCT CATALOG NUMBER

WATTS	EM OPTION	DESCRIPTION	VANDAL RES.	DESCRIPTION	PAINT	SENSOR	DESCRIPTION
ALL	OPT-EM-LESW	INTERNAL	OPT-TRS-T20	Tamper Resistant Screw	N/A	OPT-SEN-3MRLV-6 WEC-3RC	PROGRAMMABLE MICROWAVE BI-LEVEL REMOTE CONTROL



SL-20W-BZ-P
Dark Bronze



SL-20W-WH-P
White



SL-20W-BZ-P
Dark Bronze



SL-20W-WH-P
White



SL-30W-BZ-P
Dark Bronze



SL-30W-WH-P
White

LED SECURITY LIGHTS WITH PIR SENSOR, 120VAC, 180° SENSOR, 100° BEAM ANGLE (120° 28W)
80% DIM (OR OFF) WHEN NO MOTION DETECTED.



WITH SENSOR

CATALOG NO.	DESCRIPTION	PKG. QTY.
SL-10W-MCT-BZ-P	10W 950LM 30K/40K/50K Bronze MCT	8
SL-10W-MCT-WH-P	10W 950LM 30K/40K/50K White MCT	8
SL-20W-50K-BZ-P	20W 1900LM 5000K Bronze	8
SL-20W-30K-BZ-P	20W 1900LM 3000K Bronze	8
SL-20W-MCT-BZ-P	20W 1900LM 3000K/4000K/5000K Bronze MCT	8
SL-20W-50K-WH-P	20W 1900LM 5000K White	8
SL-20W-30K-WH-P	20W 1900LM 3000K White	8
SL-20W-MCT-WH-P	20W 1900LM 3000K/4000K/5000K White MCT	8
SL-30W-50K-BZ-P	30W 2800LM 5000K Bronze	8
SL-30W-30K-BZ-P	30W 2800LM 3000K Bronze	8
SL-30W-MCT-BZ-P	30W 2800LM 3000K/4000K/5000K Bronze MCT	8
SL-30W-50K-WH-P	30W 2800LM 5000K White	8
SL-30W-30K-WH-P	30W 2800LM 3000K White	8
SL-30W-MCT-WH-P	30W 2800LM 3000K/4000K/5000K White MCT	8

OUTDOOR
WALLPACKS



SL-10W-50K-BZ-D
SL-10W-30K-BZ-D
SL-10W-MCT-BZ-D
Dark Bronze



SL-10W-50K-WH-D
SL-10W-30K-WH-D
SL-10W-MCT-WH-D
White



SL-20W-50K-BZ-D
SL-20W-30K-BZ-D
SL-20W-MCT-BZ-D
Dark Bronze



SL-20W-50K-WH-D
SL-20W-30K-WH-D
SL-20W-MCT-WH-D
White



SL-30W-50K-BZ-D
SL-30W-30K-BZ-D
SL-30W-MCT-BZ-D
Dark Bronze



SL-30W-50K-WH-D
SL-30W-30K-WH-D
SL-30W-MCT-WH-D
White

NO-SENSOR DIMMABLE LED FLOOD LIGHTS
(SEE BELOW FOR OPTIONAL MOTION SENSOR OR PHOTOCELL)



CATALOG NO.	DESCRIPTION	PKG. QTY.
SL-10W-50K-BZ-D	10W 950LM 5000K Bronze	8
SL-10W-30K-BZ-D	10W 950LM 3000K Bronze	8
SL-10W-MCT-BZ-D	10W 950LM 30K/40K/50K Bronze MCT_B	8
SL-10W-50K-WH-D	10W 950LM 5000K White	8
SL-10W-30K-WH-D	10W 950LM 3000K White	8
SL-10W-MCT-WH-D	10W 950LM 30K/40K/50K White MCT_B	8
SL-20W-50K-BZ-D	20W 1900LM 5000K Bronze	8
SL-20W-30K-BZ-D	20W 1900LM 3000K Bronze	8
SL-20W-MCT-BZ-D	20W 1900LM 3000K/4000K/5000K White MCT_B	8
SL-20W-MCT-WH-D	20W 1900LM 3000K/4000K/5000K White MCT_B	8
SL-30W-50K-BZ-D	30W 2800LM 5000K Bronze WHILE SUPPLIES LAST	8
SL-30W-30K-BZ-D	30W 2800LM 3000K Bronze WHILE SUPPLIES LAST	8
SL-30W-MCT-BZ-D	30W 2800LM 3000K/4000K/5000K Bronze MCT_B	8
SL-30W-50K-WH-D	30W 2800LM 5000K White WHILE SUPPLIES LAST	8
SL-30W-30K-WH-D	30W 2800LM 3000K White WHILE SUPPLIES LAST	8
SL-30W-MCT-WH-D	30W 2800LM 3000K/4000K/5000K White MCT_B	8



SL-20W-50K-BZ
SL-20W-30K-BZ
SL-20W-50K-WH
SL-20W-30K-WH
Bronze/White



SL-28W-50K-BZ-P
SL-28W-30K-BZ-P
SL-28W-50K-WH-P
SL-28W-30K-WH-P
Bronze/White



SL-28W-50K-BZ-D
SL-28W-30K-BZ-D
SL-28W-MCT-BZ-D
SL-28W-50K-WH-D
SL-28W-30K-WH-D
SL-28W-MCT-WH-D
Bronze/White



SL-40W-50K-BZ-D
SL-40W-30K-BZ-D
SL-40W-MCT-BZ-D
SL-40W-50K-WH-D
SL-40W-30K-WH-D
SL-40W-MCT-WH-D
Bronze/White

LED SQUARE HEAD SECURITY LIGHTS



CATALOG NO.	DESCRIPTION	PKG. QTY.
NON-DIMMABLE LED SECURITY LIGHTS WITHOUT SENSOR, BASE COMPATIBLE WITH 4" ROUND W/P BOXES		
SL-20W-30K-BZ	20W 2000LM 3000K Bronze	8
SL-20W-50K-BZ	20W 2000LM 5000K Bronze	8
SL-20W-30K-WH	20W 2000LM 3000K White	8
SL-20W-50K-WH	20W 2000LM 5000K White	8
LED SECURITY LIGHTS WITH PIR SENSOR, 180° SENSOR 80%, DIM (OR OFF) WHEN NO MOTION DETECTED		
SL-28W-50K-BZ-P	28W 3400LM 5000K Bronze WHILE SUPPLIES LAST	4
SL-28W-30K-BZ-P	28W 3400LM 3000K Bronze WHILE SUPPLIES LAST	4
SL-28W-50K-WH-P	28W 3400LM 5000K White WHILE SUPPLIES LAST	4
SL-28W-30K-WH-P	28W 3400LM 3000K White WHILE SUPPLIES LAST	4
DIMMABLE LED FLOOD LIGHTS WITH OPTIONAL MOTION SENSOR OR POTHOCCELL		
SL-28W-50K-BZ-D	28W 3400LM 5000K Bronze DIMMABLE	4
SL-28W-30K-BZ-D	28W 3400LM 3000K Bronze WHILE SUPPLIES LAST	4
SL-28W-MCT-BZ-D	28W 3400LM 3000K/4000K/5000K Bronze MCT_B	4
SL-28W-50K-WH-D	28W 3400LM 5000K White WHILE SUPPLIES LAST	4
SL-28W-30K-WH-D	28W 3400LM 3000K White WHILE SUPPLIES LAST	4
SL-28W-MCT-WH-D	28W 3400LM 3000K/4000K/5000K White MCT_B	4
SL-40W-50K-BZ-D	40W 4800LM 5000K Bronze WHILE SUPPLIES LAST	4
SL-40W-30K-BZ-D	40W 4800LM 3000K Bronze WHILE SUPPLIES LAST	4
SL-40W-MCT-BZ-D	40W 4800LM 3000K/4000K/5000K Bronze MCT_B	4
SL-40W-50K-WH-D	40W 4800LM 5000K White	4
SL-40W-30K-WH-D	40W 4800LM 3000K White	4
SL-40W-MCT-WH-D	40W 4800LM 3000K/4000K/5000K White MCT_B	4

FOR PHOTOCCELL & SENSOR SEE PAGES 56 & 57.

OUTDOOR SECURITY LIGHTS



Crest & Westgate

LED WALL SCONCES

ALL MODELS PROVIDE UP/DOWN LIGHT



10W

MP



10W

MP

CRES

CATALOG NO.	TRIM		COLOR TEMPERATURE		FINISH			
	CODE	DESCRIPTION	CODE	DESCRIPTION	CODE	DESCRIPTION		
CRE	10W	(900LM)	01	Lunette	30K	3000K (EXCEPT CRE)	BR	Bronze
CRE-MP	5W/10W/15W/20W		02	Aperture	40K	4000K (EXCEPT CRE-HL)	SIL	Silver
			03	Grasp	50K	5000K (EXCEPT CRE-HL)		
			04	Curve				
			05	Pen				
			06	Still				
			07	Passage				
			08	Crush				
			10	Burrow				
			51	Tunnel				
			52	Grille				



100-277V AC

Sample Ordering:

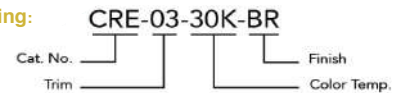

Light Engines and Trims
Can be purchased & stocked separately to readily offer all combinations of color temperatures, outputs, finishes, & trims - **Call for separate pricing**

FACTORY-INSTALLED OPTIONS, ENTER DESIRED OPTION CODE(S) AS LINE ITEMS ON YOUR PURCHASE ORDER UNDER THE PRODUCT CATALOG NUMBER

WATTS	EM OPTION	DESCRIPTION	PHOTOCELL	DESCRIPTION	PAINT	SENSOR
ALL	OPT-EM-CRE	INTERNAL	OPT-PC-B	120-277V	OPT-CLR-85(BK/GR/SR/WH)	DEPENDS ON MODEL-CALL

ADJUSTABLE BEAM ANGLE OUTDOOR/INDOOR DESIGNER WALL SCONCE, ENGINE AND TRIM



CATALOG NO.	DESCRIPTION	PKG. QTY.
CREA-EGN-14-24W-MCTP-BR	14W/18W/24W 80LM/W 30K/40K/50K	8
CREA-EGN-14-24W-MCTP-WH	14W/18W/24W 80LM/W 30K/40K/50K	8
CREA-56-BR	CREA Series Square Trim Model 56, Brz	
CREA-56-WH	CREA Series Square Trim Model 56, Wht	
CREA-57-BR	CREA Series Round Trim Model 57, Brz	
CREA-57-WH	CREA Series Round Trim Model 57, Wht	



OUTDOOR
DECORATIVE
WALL MOUNT

OUTDOOR WALLPACKS



WSX-20-40W-MCTP-HA
Horizontal Arm



WSX-20-40W-MCTP-HAD
Decorative Horizontal Arm



WSX-20-40W-MCTP-SCH
45" Suspended Chain, Canopy, Cord



WSX-20-40W-MCTP-45DA
45-Degree Arm



WSX-20-40W-MCTP-HLA
15" Long Horizontal Arm



Factory-Installed
Wire Guard Option
OPT-WSX-WG



WSX-20-40W-MCTP-SRK-218
WSX-20-40W-MCTP-SRK-224

SPEC SERIES POWER & CCT- ADJUSTABLE

X-GEN SEASIDE LIGHT, 120-277V, (DIA: 10-3/4") **7 DAYS LEAD TIME**



DESCRIPTION	PKG. QTY.
WSX-20-40W-MCTP-HA 20W/30W/40W 100LM/W 30K/40K/50K Horizontal Arm	4
WSX-20-40W-MCTP-45DA 20W/30W/40W 100LM/W 30K/40K/50K 45-Degree Arm	1
WSX-20-40W-MCTP-HAD 20W/30W/40W 100LM/W 30K/40K/50K Decorative Horizontal Arm	1
WSX-20-40W-MCTP-HLA 20W/30W/40W 100LM/W 30K/40K/50K 15" Long Horizontal Arm	1
WSX-20-40W-MCTP-SCH 20W/30W/40W 100LM/W 30K/40K/50K 45" Suspended Chain, Canopy, Cord	1
WSX-20-40W-MCTP-SRK-218 20W/30W/40W 100LM/W 30K/40K/50K 18" or 36" Swivel Rod Kit	1
WSX-20-40W-MCTP-SRK-224 20W/30W/40W 100LM/W 30K/40K/50K 24" or 48" Swivel Rod Kit	1
WSX-RL-WH WSX Original White Lens Replacement (Default Lens)	
WSX-RL-FR WSX Optional Frosted Lens	
WSX-RL-AB WSX Optional Alabaster Lens	

FACTORY-INSTALLED OPTIONS, ENTER DESIRED OPTION CODE(S) AS LINE ITEMS ON YOUR PURCHASE ORDER UNDER THE PRODUCT CATALOG NUMBER

WATTS	EM OPTION	DESCRIPTION	PHOTOCELL	DESCRIPTION	PAINT	SENSOR	DESCRIPTION
ALL MODELS	OPT-EM-WSX	BACK BOX	OPT-PC-B	BUTTON	N/A	OPT-SEN-WSX	back box
	WIREGUARD	DESCRIPTION					
	OPT-WSX-WG	WIREGUARD					



GNB-25W-MCT-BR-P
Bronze



GNB-40W-MCT-BR-P
Bronze



GNB-25W-MCT-WH-P
White



GNB-40W-MCT-WH-P
White

3CCT GOOSENECK BARN LIGHT WITH INTEGRATED PHOTOCELL



CATALOG NO.	DESCRIPTION	PKG. QTY.
GNB-25W-MCT-BR-P	25W 3000LM 3000K/4000K/5000K Bronze	2
GNB-25W-MCT-WH-P	25W 3000LM 3000K/4000K/5000K White	2
GNB-40W-MCT-BR-P	40W 4800LM 3000K/4000K/5000K Bronze	2
GNB-40W-MCT-WH-P	40W 4800LM 3000K/4000K/5000K White	2

FACTORY-INSTALLED OPTIONS, ENTER DESIRED OPTION CODE(S) AS LINE ITEMS ON YOUR PURCHASE ORDER UNDER THE PRODUCT CATALOG NUMBER

WATTS	EM OPTION	DESCRIPTION	PHOTOCELL	DESCRIPTION	PAINT	SENSOR	DESCRIPTION
ALL MODELS	OPT-EM-GNB	BACK BOX		N/A	N/A	N/A	N/A

CCT-ADJUSTABLE LED OUTDOOR CYLINDER LIGHTS, IP65



CATALOG NO.	DESCRIPTION	PKG. QTY.
2" LED CYLINDER LIGHTS, 120V (DOWN LIGHT) H: 8"		
WMC2-DL-MCT-BR-DT	6W 400LM 3000K/4000K/5000K 25° Bronze	12
WMC2-DL-MCT-BN-DT	6W 400LM 3000K/4000K/5000K 25° Brushed Nickel	12
WMC2-DL-MCT-WH-DT	6W 400LM 3000K/4000K/5000K 25° White	12
WMC2-DL-MCT-BK-DT	6W 400LM 3000K/4000K/5000K 25° Black	12
2" LED CYLINDER LIGHTS, 120V (UP/DOWN LIGHT) H: 10"		
WMC2-UDL-MCT-BR-DT	12W 800LM 3000K/4000K/5000K 25° Bronze	12
WMC2-UDL-MCT-BN-DT	12W 800LM 3000K/4000K/5000K 25° Brushed Nickel	12
WMC2-UDL-MCT-WH-DT	12W 800LM 3000K/4000K/5000K 25° White	12
WMC2-UDL-MCT-BK-DT	12W 800LM 3000K/4000K/5000K 25° Black	12
3" LED CYLINDER LIGHTS, 120V (DOWN LIGHT) H: 6"		
WMC3-DL-MCT-BR-DT	9W 650LM 3000K/4000K/5000K 30° Bronze	12
WMC3-DL-MCT-BN-DT	9W 650LM 3000K/4000K/5000K 30° Brushed Nickel	12
WMC3-DL-MCT-WH-DT	9W 650LM 3000K/4000K/5000K 30° White	12
WMC3-DL-MCT-BK-DT	9W 650LM 3000K/4000K/5000K 30° Black	12
3" LED CYLINDER LIGHTS, 120V (UP/DOWN LIGHT) H: 10"		
WMC3-UDL-MCT-BR-DT	18W 1300LM 3000K/4000K/5000K 30° Bronze	12
WMC3-UDL-MCT-BN-DT	18W 1300LM 3000K/4000K/5000K 30° Brushed Nickel	12
WMC3-UDL-MCT-WH-DT	18W 1300LM 3000K/4000K/5000K 30° White	12
WMC3-UDL-MCT-BK-DT	18W 1300LM 3000K/4000K/5000K 30° Black	12
4" LED CYLINDER LIGHTS, 120V (DOWN LIGHT) H: 8"		
WMC-DL-MCT-BR-DT	15W 1200LM 3000K/4000K/5000K 40° Bronze	6
WMC-DL-MCT-BN-DT	15W 1200LM 3000K/4000K/5000K 40° Brushed Nickel	6
WMC-DL-MCT-WH-DT	15W 1200LM 3000K/4000K/5000K 40° White	6
WMC-DL-MCT-BK-DT	15W 1200LM 3000K/4000K/5000K 40° Black	6
4" LED CYLINDER LIGHTS, 120V (UP/DOWN LIGHT) H: 12"		
WMC-UDL-MCT-BR-DT	30W 2400LM 3000K/4000K/5000K 40° Bronze	6
WMC-UDL-MCT-BN-DT	30W 2400LM 3000K/4000K/5000K 40° Brushed Nickel	6
WMC-UDL-MCT-WH-DT	30W 2400LM 3000K/4000K/5000K 40° White	6
WMC-UDL-MCT-BK-DT	30W 2400LM 3000K/4000K/5000K 40° Black	6
6" LED CYLINDER LIGHTS, 120-277V (DOWN LIGHT) H: 8"		
WMCL-DL-MCT-BR	20W 1600LM 3000K/4000K/5000K 45° Bronze	4
WMCL-DL-MCT-BN	20W 1600LM 3000K/4000K/5000K 45° Brushed Nickel	4
WMCL-DL-MCT-WH	20W 1600LM 3000K/4000K/5000K 45° White	4
WMCL-DL-MCT-BK	20W 1600LM 3000K/4000K/5000K 45° Black	4
6" LED CYLINDER LIGHTS, 120-277V (UP/DOWN LIGHT) H: 18"		
WMCL-UDL-MCT-BR	40W 3200LM 3000K/4000K/5000K 45° Bronze	4
WMCL-UDL-MCT-BN	40W 3200LM 3000K/4000K/5000K 45° Brushed Nickel	4
WMCL-UDL-MCT-WH	40W 3200LM 3000K/4000K/5000K 45° White	4
WMCL-UDL-MCT-BK	40W 3200LM 3000K/4000K/5000K 45° Black	4
8" LED CYLINDER LIGHTS, 120-277V (DOWN LIGHT) H: 10.1"		
WMC8-DL-MCT-BR-D	40W 3200LM 3000K/4000K/5000K 50° Bronze	4
WMC8-DL-MCT-BN-D	40W 3200LM 3000K/4000K/5000K 50° Brushed Nickel	4
WMC8-DL-MCT-WH-D	40W 3200LM 3000K/4000K/5000K 50° White	4
WMC8-DL-MCT-BK-D	40W 3200LM 3000K/4000K/5000K 50° Black	4
8" LED CYLINDER LIGHTS, 120-277V (UP/DOWN LIGHT) H: 10.1"		
WMC8-UDL-MCT-BR-D	40W 3200LM 3000K/4000K/5000K 50° Bronze	4
WMC8-UDL-MCT-BN-D	40W 3200LM 3000K/4000K/5000K 50° Brushed Nickel	4
WMC8-UDL-MCT-WH-D	40W 3200LM 3000K/4000K/5000K 50° White	4
WMC8-UDL-MCT-BK-D	40W 3200LM 3000K/4000K/5000K 50° Black	4
ACRYLIC DROP LENS FOR WMC		
CWMC2-DL32	CMC2 And WMC2 32mm Acrylic Drop Lens	
CWMC3-DL32	CMC3 And WMC3 32mm Acrylic Drop Lens	
CWMC4-DL32	WMC4 32mm Acrylic Drop Lens	
CWMC6-DL32	CMC6 And WMC6 32mm Acrylic Drop Lens	

OUTDOOR DECORATIVE WALL MOUNT

277V OPTION

277V OPTION

ALL MODELS ARE AVAILABLE IN BRONZE, BRUSHED NICKEL, BLACK, & WHITE Now avail. in WHT & BK
FACTORY-INSTALLED OPTIONS, ENTER DESIRED OPTION CODE(S) AS LINE ITEMS ON YOUR PURCHASE ORDER UNDER THE PRODUCT CATALOG NUMBER

SIZE	EM OPTION	DESCRIPTION	PHOTOCELL	DESCRIPTION	PAINT	SENSOR	DESCRIPTION
2" & 3"	OPT-EM-WMC-EXT-BR	EXTERNAL BACK BOX	OPT-PC-BUM	BUTTON	N/A	OPT-SEN-WMC WEC-8RC	ONLY FOR 4" & UP REMOTE CONTROL
2" & 3"	OPT-EM-WMC-EXT-BN	EXTERNAL BACK BOX	277V OPTION	DESCRIPTION			
2" & 3"	OPT-EM-WMC-EXT-WH	EXTERNAL BACK BOX	OPT-277V	INTERNAL (ONLY FOR WMC DL UDL)			
2" & 3"	OPT-EM-WMC-EXT-BK	EXTERNAL BACK BOX					
4" & UP	OPT-EM-WMC	INTERNAL					



ALL MODELS ARE AVAILABLE IN BRONZE, BRUSHED NICKEL, BLACK, & WHITE

4" & 5" CCT-ADJUSTABLE LED SQUARE OUTDOOR CYLINDER LIGHTS, IP65



CATALOG NO.	DESCRIPTION	PKG. QTY.
4" LED SQUARE CYLINDER LIGHTS, 120V (DOWN LIGHT) H: 8"		
WMCS-DL-MCT-BR-DT	12W 960LM 3000K/4000K/5000K 30° Bronze	6
WMCS-DL-MCT-BN-DT	12W 960LM 3000K/4000K/5000K 30° Brushed Nickel	6
WMCS-DL-MCT-WH-DT	12W 960LM 3000K/4000K/5000K 30° White	6
WMCS-DL-MCT-BK-DT	12W 960LM 3000K/4000K/5000K 30° Black	6
4" LED SQUARE CYLINDER LIGHTS, 120V (UP/DOWN LIGHT) H: 10-1/4"		
WMCS-UDL-MCT-BR-DT	24W 1920LM 3000K/4000K/5000K 30° Bronze	6
WMCS-UDL-MCT-BN-DT	24W 1920LM 3000K/4000K/5000K 30° Brushed Nickel	6
WMCS-UDL-MCT-WH-DT	24W 1920LM 3000K/4000K/5000K 30° White	6
WMCS-UDL-MCT-BK-DT	24W 1920LM 3000K/4000K/5000K 30° Black	6
5" LED SQUARE CYLINDER LIGHTS, 120-277V (DOWN LIGHT) H: 8"		
WMCS5-DL-MCT-BR-DD	20W 1600LM 30K/40K/50K 30° Bronze	6
WMCS5-DL-MCT-BN-DD	20W 1600LM 30K/40K/50K 30° Brushed Nickel	6
WMCS5-DL-MCT-WH-DD	20W 1600LM 30K/40K/50K 30° White	6
WMCS5-DL-MCT-BK-DD	20W 1600LM 30K/40K/50K 30° Black	6
5" LED SQUARE CYLINDER LIGHTS, 120-277V (UP/DOWN LIGHT) H: 12"		
WMCS5-UDL-MCT-BR-DD	40W 3200LM 30K/40K/50K 30° Bronze	6
WMCS5-UDL-MCT-BN-DD	40W 3200LM 30K/40K/50K 30° Brushed Nickel	6
WMCS5-UDL-MCT-WH-DD	40W 3200LM 30K/40K/50K 30° White	6
WMCS5-UDL-MCT-BK-DD	40W 3200LM 30K/40K/50K 30° Black	6



FACTORY-INSTALLED OPTIONS, ENTER DESIRED OPTION CODE(S) AS LINE ITEMS ON YOUR PURCHASE ORDER UNDER THE PRODUCT CATALOG NUMBER

SIZE	EM OPTION	DESCRIPTION	PHOTOCELL DESCRIPTION	PAINT	SENSOR	DESCRIPTION
4" & UP	OPT-EM-WMCS	INTERNAL	OPT-PC-B BUTTON	N/A	OPT-SEN-WMC WEC-BRC	PROGRAMMABLE MICROWAVE BI-LEVEL REMOTE CONTROL

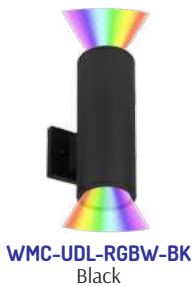

RGBW LED OUTDOOR CYLINDER LIGHTS, IP65



CATALOG NO.	DESCRIPTION	PKG. QTY.
4" LED ROUND CYLINDER LIGHTS, 120V (UP/DOWN LIGHT) H: 12"		
WMC-UDL-RGBW-BK	24W 1920LM RGBW 25° Black	6
WMC-UDL-RGBW-WH	24W 1920LM RGBW 25° White	6
4" LED SQUARE CYLINDER LIGHTS, 120V (UP/DOWN LIGHT) H: 10-1/4"		
WMCS-UDL-RGBW-BK	24W 1920LM RGBW 30° Black	6
WMCS-UDL-RGBW-WH	24W 1920LM RGBW 30° White	6

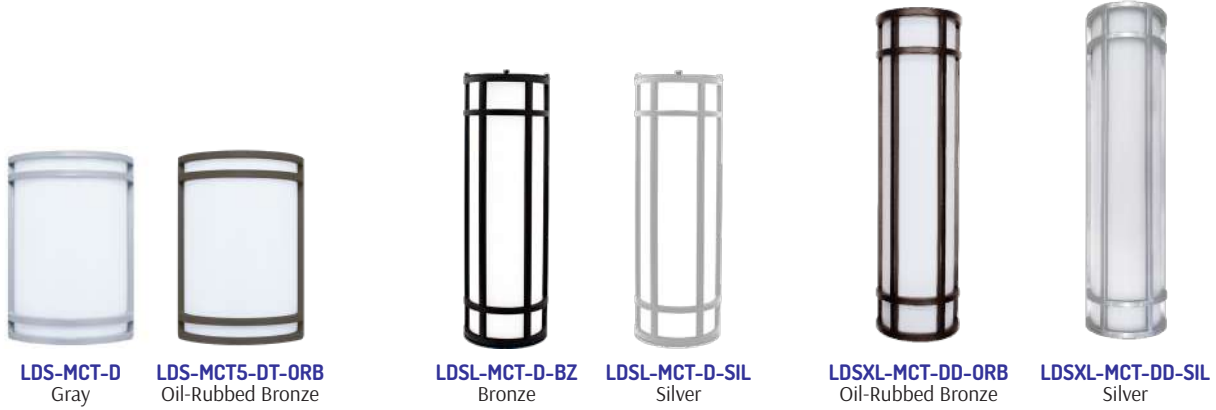

OUTDOOR
DECORATIVE
WALL MOUNT

OUTDOOR/INDOOR LED DECORATIVE WALL SCONCE



CATALOG NO.	DESCRIPTION					PKG. QTY.
10" OUTDOOR/INDOOR LED DECORATIVE WALL SCONCE, 120V (7" WIDE)						
LDS-MCT-D	12W	1200LM	30K/40K/50K	Gray		6
LDS-MCT5-DT-ORB	15W	980LM	27K/30K/35K/40K/50K	Oil-Rubbed Bronze		4
LDS-MCT5-DT-SIL	15W	980LM	27K/30K/35K/40K/50K	Silver		4
LDS-MCT5-DT-BK	15W	980LM	27K/30K/35K/40K/50K	Black		4
18" OUTDOOR/INDOOR LED DECORATIVE WALL SCONCE, 120-277V (6" WIDE)						
LDSL-MCT-D-BZ	20W	1500LM	3000K/4000K/5000K	Bronze		6
LDSL-MCT-D-SIL	20W	1500LM	3500K/4000K/5000K	Silver		6
24" OUTDOOR/INDOOR LED DECORATIVE WALL SCONCE, 120-277V (6" WIDE)						
LDSXL-MCT-DD-ORB	25W	1800LM	30K/40K/50K	Oil-Rubbed Bronze		4
LDSXL-MCT-DD-SIL	25W	1800LM	30K/40K/50K	Silver		4
LDSXL DIMMING: (DUAL FUNCTION) TRIAC DIMMABLE AT 120V & 0-10V DIMMING AT 120-277V						
10" OUTDOOR/INDOOR LED DECORATIVE WALL SCONCE, 120V (10" WIDE)						
LDSW-MCT5-ORB	12W	1200LM	27K/30K/35K/40K/50K	Oil-Rubbed Bronze		6
LDSW-MCT5-SIL	12W	1200LM	27K/30K/35K/40K/50K	Silver		6
10" OUTDOOR/INDOOR LED DECORATIVE WALL SCONCE, 120V (8.7" WIDE)						
LDSS-MCT5-ORB	12W	1200LM	27K/30K/35K/40K/50K	Oil-Rubbed Bronze		6
FULL-LENS WALL SCONCE, POWER & CCT-ADJUSTABLE						
LDSX-S-12-16W-MCTP-ORB	12W/14W/16W	100LM/W	30K/40K/50K	8" Oil-Rubbed Bronze		
LDSX-L-18-22W-MCTP-ORB	18W/20W/22W	100LM/W	30K/40K/50K	14" Oil-Rubbed Bronze		

FACTORY-INSTALLED OPTIONS, ENTER DESIRED OPTION CODE(S) AS LINE ITEMS ON YOUR PURCHASE ORDER UNDER THE PRODUCT CATALOG NUMBER

WATTS	EM OPTION	DESCRIPTION	PHOTOCELL	DESCRIPTION	PAINT	SENSOR	DESCRIPTION
LDS	OPT-EM-LDS		OPT-PC-B1	BUTTON	N/A	OPT-SEN-LDS-BR	PROGRAMMABLE MICROWAVE BI-LEVEL
LDSX-S	OPT-EM-LDSX-S		277V OPTION	DESCRIPTION		OPT-SEN-LDS-GY	PROGRAMMABLE MICROWAVE BI-LEVEL
LDSX-L	OPT-EM-LDSX-L		OPT-277V-LDS	EXTERNAL BOX		WEC-8RC	OPTIONAL REMOTE

FACTORY-INSTALLED OPTIONS, ENTER DESIRED OPTION CODE(S) AS LINE ITEMS ON YOUR PURCHASE ORDER UNDER THE PRODUCT CATALOG NUMBER

WATTS	EM OPTION	DESCRIPTION	PHOTOCELL	DESCRIPTION	PAINT	SENSOR	DESCRIPTION
LDSL, LDSXL	OPT-EM-LDSL	INTERNAL	OPT-PC-B	BUTTON	N/A	N/A	N/A

FACTORY-INSTALLED OPTIONS, ENTER DESIRED OPTION CODE(S) AS LINE ITEMS ON YOUR PURCHASE ORDER UNDER THE PRODUCT CATALOG NUMBER

WATTS	277V OPTION	DESCRIPTION	PHOTOCELL	DESCRIPTION	PAINT	SENSOR	DESCRIPTION
LDSW, LDSS	N/A	N/A	OPT-PC-B1	BUTTON	N/A	N/A	N/A



LRS-J1S-MCT-C90-BK
Black



LRS-J1S-MCT-C90-BN
Brushed-Nickel



LRS-J1S-MCT-C90-BR
Bronze



LRS-J-MCT-C90-BK
Black



LRS-J-MCT-C90-BN
Brushed-Nickel



LRS-J-MCT-C90-BR
Bronze

**MODEL J ARCHITECTURAL OUTDOOR/INDOOR LED WALL LIGHTS
120V, SOLID ACRYLIC LENS**



OUTDOOR
DECORATIVE
WALL MOUNT

CATALOG NO.	DESCRIPTION	PKG. QTY.
1-SIDE DECORATIVE OUTDOOR WALL LIGHT		
LRS-J1S-MCT-C90-BK	10W 700LM 3000K/4000K/5000K Black	10
LRS-J1S-MCT-C90-BR	10W 700LM 3000K/4000K/5000K Bronze	10
LRS-J1S-MCT-C90-BN	10W 700LM 3000K/4000K/5000K Brushed-Nickel	10
2-SIDES DECORATIVE OUTDOOR WALL LIGHT		
LRS-J-MCT-C90-BK	20W 1400LM 3000K/4000K/5000K Black	10
LRS-J-MCT-C90-BR	20W 1400LM 3000K/4000K/5000K Bronze	10
LRS-J-MCT-C90-BN	20W 1400LM 3000K/4000K/5000K Brushed-Nickel	10



LRS-E-MCT-C90-BK
Black



LRS-E-MCT-C90-MGBR
Marine Grade Bronze



LRS-E-MCT-C90-WH
White



LRS-F-MCT-C90-BK
Black



LRS-F-MCT-C90-MGBR
Marine Grade Bronze



LRS-F-MCT-C90-WH
White



LRS-G-MCT-C90-BK
Black



LRS-G-MCT-C90-MGBR
Marine Grade Bronze



LRS-G-MCT-C90-WH
White



LRS-H-MCT-C90-BK
Black



LRS-H-MCT-C90-MGBR
Marine Grade Bronze



LRS-H-MCT-C90-WH
White

ARCHITECTURAL OUTDOOR/INDOOR LED WALL LIGHTS, 120V



CATALOG NO.	DESCRIPTION	PKG. QTY.
ROUND MODEL E ARCHITECTURAL OUTDOOR/INDOOR LED WALL LIGHTS, 120V		
LRS-E-MCT-C90-BK	12W 650LM 3000K/4000K/5000K Black	12
LRS-E-MCT-C90-WH	12W 650LM 3000K/4000K/5000K White	12
LRS-E-MCT-C90-MGBR	12W 650LM 3000K/4000K/5000K Marine Grade Bronze	12
ROUND MODEL F ARCHITECTURAL OUTDOOR/INDOOR LED WALL LIGHTS, 120V		
LRS-F-MCT-C90-BK	12W 650LM 3000K/4000K/5000K Black	12
LRS-F-MCT-C90-WH	12W 650LM 3000K/4000K/5000K White	12
LRS-F-MCT-C90-MGBR	12W 650LM 3000K/4000K/5000K Marine Grade Bronze	12
SQUARE MODEL G ARCHITECTURAL OUTDOOR/INDOOR LED WALL LIGHTS, 120V		
LRS-G-MCT-C90-BK	12W 650LM 3000K/4000K/5000K Black	12
LRS-G-MCT-C90-WH	12W 650LM 3000K/4000K/5000K White	12
LRS-G-MCT-C90-MGBR	12W 650LM 3000K/4000K/5000K Marine Grade Bronze	12
SQUARE MODEL H ARCHITECTURAL OUTDOOR/INDOOR LED WALL LIGHTS, 120V		
LRS-H-MCT-C90-BK	12W 650LM 3000K/4000K/5000K Black	12
LRS-H-MCT-C90-WH	12W 650LM 3000K/4000K/5000K White	12
LRS-H-MCT-C90-MGBR	12W 650LM 3000K/4000K/5000K Marine Grade Bronze	12



FACTORY-INSTALLED OPTIONS, ENTER DESIRED OPTION CODE(S) AS LINE ITEMS ON YOUR PURCHASE ORDER UNDER THE PRODUCT CATALOG NUMBER

WATTS	EM OPTION	DESCRIPTION	PHOTOCELL	DESCRIPTION	PAINT	SENSOR	DESCRIPTION
LRS-E, LRS-F	OPT-EM-LRS-R-BK	BACK BOX	OPT-277V-LRS-R	EXTERNAL BOX	N/A	N/A	N/A
LRS-G, LRS-H, LRS-J, LRS-J1S	OPT-EM-LRS-S-BK	BACK BOX	OPT-277V-LRS-S	EXTERNAL BOX	N/A	N/A	N/A
LRS-E, LRS-F	OPT-EM-LRS-R-WH	BACK BOX					
LRS-G, LRS-H	OPT-EM-LRS-S-WH	BACK BOX					
LRS-E, LRS-F	OPT-EM-LRS-R-MGBR	BACK BOX					
LRS-G, LRS-H	OPT-EM-LRS-S-MGBR	BACK BOX					
LRS-J, LRS-J1S	OPT-EM-LRS-S-BR	BACK BOX					
LRS-J, LRS-J1S	OPT-EM-LRS-S-BN	BACK BOX					



LVW-100-MCT-ORB
5 1/4"(D) x 2 2/3"(H)



LVW-110-MCT-ORB
3 1/8"(W) x 3 2/5"(H) x 3 5/7"(D)



LVW-110-UD-MCT-ORB
3 5/7"(W) x 4 1/8"(H) x 5 1/5"(D)



LVW-115-MCT-ORB
5 1/4"(D) x 3 3/4"(H)



LVW-200-MCT-ORB
5 1/4"(SQ) x 2 2/3"(H)



LVW-210-MCT-ORB
3 3/4"(W) x 4 1/8"(H) x 3 2/5"(D)



LVW-210-UD-MCT-ORB
3 3/4"(W) x 4 1/8"(H) x 5 1/5"(D)



LVW-215-MCT-ORB
5 1/4"(SQ) x 4 1/3"(H)



LVW-250-MCT-ORB
5 3/4"(W) x 5 3/4"(H) x 2 1/4"(D)



LVW-300-MCT-ORB
LVW-300-MCT-WH
7"(W) x 5"(H) x 2 1/4"(D)



LVW-310-MCT-ORB
LVW-310-MCT-WH
7 1/2"(W) x 4 1/5"(H) x 2"(D)

OUTDOOR
DECORATIVE
WALL MOUNT

12V SELECTABLE CCT LED MINI WALL SCONCES



12V

CATALOG NO.	DESCRIPTION
LVW-100-MCT-ORB	3W 200LM 30K/40K/50K Oil-Rubbed Bronze
LVW-110-MCT-ORB	3W 200LM 30K/40K/50K Oil-Rubbed Bronze
LVW-110-UD-MCT-ORB	6W 400LM 30K/40K/50K Oil-Rubbed Bronze
LVW-115-MCT-ORB	3W 200LM 30K/40K/50K Oil-Rubbed Bronze
LVW-200-MCT-ORB	3W 200LM 30K/40K/50K Oil-Rubbed Bronze
LVW-210-MCT-ORB	3W 200LM 30K/40K/50K Oil-Rubbed Bronze
LVW-210-UD-MCT-ORB	6W 400LM 30K/40K/50K Oil-Rubbed Bronze
LVW-215-MCT-ORB	3W 200LM 30K/40K/50K Oil-Rubbed Bronze
LVW-250-MCT-ORB	6W 400LM 30K/40K/50K Oil-Rubbed Bronze
LVW-300-MCT-ORB	6W 400LM 30K/40K/50K Oil-Rubbed Bronze
LVW-300-MCT-WH	6W 400LM 30K/40K/50K White
LVW-310-MCT-ORB	6W 400LM 30K/40K/50K Oil-Rubbed Bronze
LVW-310-MCT-WH	6W 400LM 30K/40K/50K White

LED NON-CUTOFF (11") WALL PACK WITH PHOTOCELL, 120-277V (PHOTOCELL PREWIRED TO 120V)



CATALOG NO.	DESCRIPTION	REPLACEMENT RANGE	WHILE SUPPLIES LAST	PKG. QTY.
LSW-22NW-PC	20W 2050LM 4000K	50-100 MH		6

FACTORY-INSTALLED OPTIONS, ENTER DESIRED OPTION CODE(S) AS LINE ITEMS ON YOUR PURCHASE ORDER UNDER THE PRODUCT CATALOG NUMBER

WATTS	EM OPTION	DESCRIPTION	PHOTOCELL	DESCRIPTION	PAINT	SENSOR	DESCRIPTION
ALL	OPT-EM-LSW	INTERNAL	OPT-NOPC	REMOVE PHOTOCELL	N/A	OPT-SEN-SLPIR	EXTERNAL, SECURITY LIGHT TYPE
	VANDAL RES.	DESCRIPTION					
	OPT-TRS-T20	Tamper Resistant Screw					



LRS-A-40K-PC
LRS-A-MCT-PC
Dark Bronze



LRS-B-40K-PC
LRS-B-MCT-PC
Dark Bronze



LRS-C-MCT-D
Dark Bronze



LRS-PV-MCT-DD
Oil-Rubbed Bronze



LRS-D-30K-D
LRS-D-40K-D
Dark Bronze



LRS-L-MCT5-BK
Black



LRS-S-MCT5-ORB
Oil-Rubbed Bronze



LRS-SWG-MCT5-ORB
Oil-Rubbed Bronze



LED RESIDENTIAL LANTERNS, 120V

CATALOG NO.	DESCRIPTION	PKG. QTY.
12" OUTDOOR/INDOOR CEILING LIGHT, 120-277V	MCT5 DIMMABLE DIMMING 0-10V	
LRS-PV-MCT-DD	25W 1920LM 30K/40K/50K 12". Oil-Rubbed Bronze	4
LED RESIDENTIAL LANTERNS WITH PHOTOCELL, 120V		
LRS-A-40K-PC	12W 1150LM 4000K	6
LRS-A-MCT-PC	12W 1150LM 3000K/4000K/5000K MCT5	6
LRS-B-40K-PC	6W 550LM 4000K WHILE SUPPLIES LAST	12
LRS-B-MCT-PC	6W 550LM 3000K/4000K/5000K MCT5	12
LED DIMMABLE RESIDENTIAL LIGHTS, 120V		
LRS-C-MCT-D	12W 1100LM 3000K/4000K/5000K MCT5	6
LRS-D-30K-D	12W 1100LM 3000K WHILE SUPPLIES LAST	6
LRS-D-40K-D	12W 1100LM 4000K WHILE SUPPLIES LAST	6
LED OUTDOOR LARGE WALL LANTERN, 120V 5CCT (12.40 X 8.80 X 8.80)		
LRS-L-MCT5-BK	12W 1200LM 27K/30K/35K/40K/50K Black 12.4"X8.8"X8.8"	6
LED SEASIDE OUTDOOR WALL LANTERN, 120V 5CCT (10.50 X 8.70 X 8.70)		
LRS-S-MCT5-ORB	12W 1200LM 27K/30K/35K/40K/50K Oil-Rubbed Bronze	4
LED SEASIDE OUTDOOR WALL LANTERN WITH WIREGUARD., 120V 5CCT (11.00 X 8.75 X 10.35)		
LRS-SWG-MCT5-ORB	12W 1200LM 27K/30K/35K/40K/50K Oil-Rubbed Bronze	4

FACTORY-INSTALLED OPTIONS, ENTER DESIRED OPTION CODE(S) AS LINE ITEMS ON YOUR PURCHASE ORDER UNDER THE PRODUCT CATALOG NUMBER

WATTS	EM OPTION	DESCRIPTION	PHOTOCELL	DESCRIPTION	PAINT	SENSOR	DESCRIPTION
LRS-L, LRS-S, LRS-SWG	N/A	N/A	OPT-PC-B	BUTTON	N/A	N/A	N/A



LRS-R1-MCT5-DD-ORB
Oil-rubbed bronze



LRS-R2-MCT5-DD-ORB
Oil-rubbed bronze



LRS-T1-MCT5-DD-ORB
Oil-rubbed bronze



LRS-T2-MCT5-DD-ORB
Oil-rubbed bronze



LRS-S1-MCT5-DD-ORB
Oil-rubbed bronze



LRS-S2-MCT5-DD-ORB
Oil-rubbed bronze

DUAL-DIMMING MODERN RESIDENTIAL/COMMERCIAL WALL SCONCES



CATALOG NO.	DESCRIPTION
LRS R MODERN RESIDENTIAL/COMMERCIAL WALL SCONCES	
LRS-R1-MCT5-DD-ORB	20W 1500LM 27K/30K/35K/40K/50K
LRS-R2-MCT5-DD-ORB	25W 1875LM 27K/30K/35K/40K/50K
LRS T MODERN RESIDENTIAL/COMMERCIAL WALL SCONCES	
LRS-T1-MCT5-DD-ORB	20W 1500LM 27K/30K/35K/40K/50K
LRS-T2-MCT5-DD-ORB	25W 1875LM 27K/30K/35K/40K/50K
LRS S MODERN RESIDENTIAL/COMMERCIAL WALL SCONCES	
LRS-S1-MCT5-DD-ORB	20W 1500LM 27K/30K/35K/40K/50K
LRS-S2-MCT5-DD-ORB	25W 1875LM 27K/30K/35K/40K/50K

OUTDOOR
DECORATIVE
WALL MOUNT



LRS-N1-MCT-P-ORB
13" Oil-Rubbed Bronze



LRS-M1-MCT-P-ORB
10" Oil-Rubbed Bronze



LRS-M2-MCT-P-ORB
10" Oil-Rubbed Bronze



Shown with
Optional
Bubble Glass



Shown with
Optional
Crackled Glass



LRS-V
Oil-rubbed bronze

RESIDENTIAL LANTERNS WITH PHOTOCELL, CCT SELECTABLE



CATALOG NO.	DESCRIPTION	PKG. QTY.
10" MODEL M RESIDENTIAL LANTERNS WITH PHOTOCELL, CCT SELECTABLE		
LRS-M1-MCT-P-ORB	12W 500LM 30K/40K/50K With Frosted Lens & Ornament guard	6
LRS-M2-MCT-P-ORB	12W 500LM 30K/40K/50K With Frosted Lens & Outer Clear Glass	6
LRS-M-RL-FG	Replacement Default Frosted Lens For LRS-M Series	
LRS-M-RL-BG	Replacement Bubble Glass Lens For LRS-M Series	
LRS-M-RL-CG	Replacement Crackled Glass Lens For LRS-M Series	
13" MODEL N RESIDENTIAL LANTERNS WITH PHOTOCELL, CCT SELECTABLE		
LRS-N1-MCT-P-ORB	20W 850LM 30K/40K/50K With Frosted Lens & Outer Clear Glass	4
LRS-N-RL-FG	Replacement Default Frosted Lens For LRS-N Series	
LRS-N-RL-BG	Replacement Bubble Glass Lens For LRS-N Series	
LRS-N-RL-CG	Replacement Crackled Glass Lens For LRS-N Series	
MODEL V DIE-CAST MODERN WALL SCONCES		
LRS-V-MCT-P-ORB	12W 500LM 30K/40K/50K	



LRS-O
Bronze



Can be Installed
as Uplight



LRS-CR2-MCT-BR
Bronze



LRS-WS-12
Bronze



LRS-WS-18
Bronze



LRS-K-24-MCT5-BR
Bronze

DIE-CAST MODERN WALL SCONCES, SELECTABLE 3CCT



CATALOG NO.	DESCRIPTION	PKG. QTY.
MODEL O DIE-CAST MODERN WALL SCONCES - UP LIGHT OR DOWN LIGHT INSTALLATION		
LRS-O1-MCT-BR	6W 420LM 30K/40K/50K Bronze, 5" H	10
LRS-O2-MCT-BR	9W 630LM 30K/40K/50K Bronze, 6" H	10
LRS-O3-MCT-BR	12W 840LM 30K/40K/50K Bronze, 8" H	10
MODEL CR DIE-CAST MODERN WALL SCONCES		
LRS-CR2-MCT-BR	2x6W 840LM 30K/40K/50K Bronze, 6" H	8
MODEL WS DIE-CAST MODERN WALL SCONCES		
LRS-WS-12-MCT5-BR	20W 1000LM 27K/30K/35K/40K/50K Bronze, 12" H	10
LRS-WS-18-MCT5-BR	30W 1500LM 27K/30K/35K/40K/50K Bronze, 18" H	10
MODEL K DIE-CAST MODERN WALL SCONCES		
LRS-K-24-MCT5-BR	24W 700LM 27K/30K/35K/40K/50K Bronze, 24" H	8

OUTDOOR
DECORATIVE
WALL MOUNT

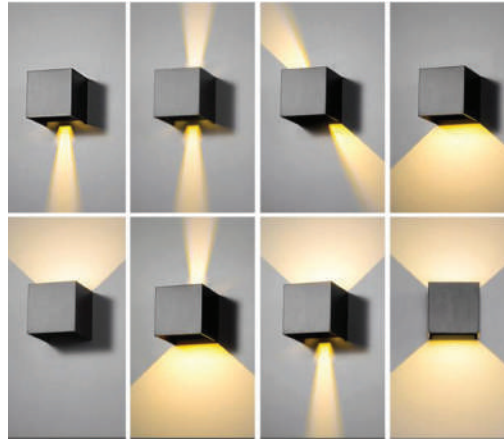

WALL CUBE WITH ADJ. BEAM ANGLE UP/DOWN LIGHTS, OUTDOOR, 5CCT



CATALOG NO.	DESCRIPTION	PKG. QTY.
LRS-Q-MCT5-BR	15w 800LM 27K/30K/35K/40K/50K	10
LRS-Q-MCT5-BK	15w 800LM 27K/30K/35K/40K/50K	10



DIE-CAST HIGH PERFORMANCE SELECTABLE 3CCT WALL PACK, PC LENS



CATALOG NO.	DESCRIPTION	PKG. QTY.
LRS-P1-MCT-BR	15w 975LM 30K/40K/50K Bronze, 10"H	8
LRS-P2-MCTP-BR	20w/25w/30w 70LM/w 30K/40K/50K Bronze, 15"H	4



MINI-CONE OUTDOOR WALL SCONCE WITH PHOTOCELL, 5" HEIGHT, 5CCT



CATALOG NO.	DESCRIPTION	ARRIVES THIS SEASON CHECK & PRE-ORDER	PKG. QTY.
LRS-MC-MCT5-P-BK	10w 700LM 27K/30K/35K/40K/50K Black		10
LRS-MC-MCT5-P-WH	10w 700LM 27K/30K/35K/40K/50K White		10
LRS-MC-MCT5-P-BN	10w 700LM 27K/30K/35K/40K/50K Brushed nickel		10
LRS-MC-MCT5-P-BR	10w 700LM 27K/30K/35K/40K/50K Bronze		10



FACTORY-INSTALLED OPTIONS, ENTER DESIRED OPTION CODE(S) AS LINE ITEMS ON YOUR PURCHASE ORDER UNDER THE PRODUCT CATALOG NUMBER

WATTS	EM OPTION	DESCRIPTION	VANDAL RES.	DESCRIPTION	PAINT	SENSOR	DESCRIPTION
ALL	OPT-EM-LRS-MC	EXTERNAL BACK BOX	N/A	N/A	N/A	N/A	N/A



TC-FL-36W-RGBW-BT-BR
Round Flood Light



TC-FL-72W-RGBW-BT-BK
Round Flood Light



TC-FLS-96W-RGBW-BT-BK
Square Flood Light



TC-WW-36W-RGBW-BT-BK
TC-WW-72W-RGBW-BT-BK
4' Wall Wash



DMX-FL-SH1
Shield only



DMX-FLS-SH1
Shield only



DMX-FLS-SHFG1
Shield only



DMX-WW-SH2
Shield only



WEC-2UGW-WIFI

WESTGATE SMART APP COMPATIBLE RGBW SERIES

CATALOG NO.	DESCRIPTION	PKG. QTY.
TC-FL-36W-RGBW-BT-BR	36W RGBW Bronze Round Flood Light	1
TC-FL-72W-RGBW-BT-BK	72W RGBW Black Round Flood Light	1
TC-WW-36W-RGBW-BT-BK	36W RGBW Black Linear Light	1
TC-WW-72W-RGBW-BT-BK	72W RGBW Black Linear Light	1
TC-FLS-96W-RGBW-BT-BK	96W RGBW Black Square Flood Light	1
DMX-FL-SH1	Half Glare Shield for TC-FL-72W & DMX-FL-72W	
DMX-WW-SH2	Half Glare Shield for TC-LIN-36W/72W & DMX-LIN-36W	
DMX-FLS-SH1	Half Glare Shield for TC-FLS-96W & DMX-FLS-36W/72W/96W	
DMX-FLS-SHFG1	Full Glare Shield for TC-FL-96W & DMX-FL-36W/72W/96W	
WEC-2UGW-WIFI	Bluetooth to WiFi Gateway for full remote access and programming, also needed for scheduling	



WMC-UDL-RGBW-BK
Black



WMC-UDL-RGBW-WH
White



WMCS-UDL-RGBW-BK
Black



WMCS-UDL-RGBW-WH
White

RGBW LED OUTDOOR CYLINDER LIGHTS, IP65



CATALOG NO.	DESCRIPTION	PKG. QTY.
4" LED ROUND CYLINDER LIGHTS, 120V (UP/DOWN LIGHT) H: 12"		
WMC-UDL-RGBW-BK	24W 1920LM RGBW 25° Black	6
WMC-UDL-RGBW-WH	24W 1920LM RGBW 25° White	6
4" LED SQUARE CYLINDER LIGHTS, 120V (UP/DOWN LIGHT) H: 10-1/4"		
WMCS-UDL-RGBW-BK	24W 1920LM RGBW 30° Black	6
WMCS-UDL-RGBW-WH	24W 1920LM RGBW 30° White	6



DMX 512 COMPATIBLE RGBW SERIES

SPECIAL ORDER FOR PROJECTS - MINIMUM 3 MONTHS LEAD TIME

DMX Controller & Cables Needed.

In a DMX lighting setup, Lights need to be connected with cables. The cables can be "daisy chained" so that each light can plug into the one before it instead of all lights plugging into the DMX board itself.



DMX-FL-72W-RGBW-BT-BK
Round Flood Light



DMX-FLS-96W-RGBW-BT-BK
Square Flood Light



DMX-WW-36W-RGBW-BT-BK
DMX-WW-72W-RGBW-BT-BK
Wall Wash



DMX-FL-SH1
Shield only



DMX-FLS-SHFG1
Shield only



DMX-WW-SH2
Shield only



DMX-FLS-SH2
Shield only

DMX 512 COMPATIBLE RGBW SERIES

CATALOG NO.	DESCRIPTION	PKG. QTY.
DMX-FL-72W-RGBW-BT-BK	72W RGBW Black Round Flood Light	1
DMX-FLS-96W-RGBW-BT-BK	96W RGBW Black Square Flood Light	1
DMX-WW-36W-RGBW-BT-BK	36W RGBW Black Linear Light	1
DMX-WW-72W-RGBW-BT-BK	72W RGBW Black Linear Light	1
DMX-FL-SH1	Half Glare Shield for TC-FL-72W & DMX-FL-72W	
DMX-WW-SH2	Half Glare Shield for TC-LIN-36W/72W & DMX-LIN-36W	
DMX-FLS-SH1	Half Glare Shield for TC-FLS-96W & DMX-FLS-36W/72W/96W	
DMX-FLS-SHFG1	Full Glare Shield for TC-FL-96W & DMX-FL-36W/72W/96W	



SPEC SERIES X GEN. RGB STADIUM LIGHTS, DMX512 CONTROLLED - SPECIAL ORDER



CATALOG NO.	DESCRIPTION	PKG. QTY.
SFX-G9-500W-45D-RGB	500W RGB	1
SFX-G9-800W-45D-RGB	800W RGB	1



OUTDOOR
DMX 512



BUILDER SERIES FLOOD/AREA LIGHTS WITH PHOTOCELL
TYPE 3 LENS (PHOTOCELL DISCONNECT SWITCH)



CATALOG NO.	DESCRIPTION	PKG. QTY.
-------------	-------------	-----------

POWER & CCT ADJUSTABLE BUILDER SERIES FLOOD/AREA LIGHTS WITH PHOTOCELL **MCTP**

LFXE-MD-50-100W-MCTP-KN-P	50W/80W/100W 135LM/W 30K/40K/50K	4
LFXE-MD-50-100W-MCTP-KN-P-BK	50W/80W/100W 135LM/W 30K/40K/50K	4
LFXE-MD-50-100W-MCTP-KN-P-WH	50W/80W/100W 135LM/W 30K/40K/50K	4
LFXE-MD-50-100W-MCTP-TR-P	50W/80W/100W 135LM/W 30K/40K/50K	4

POWER & 3CCT ADJUSTABLE BUILDER SERIES FLOOD/AREA LIGHTS WITH PHOTOCELL (COMPATIBLE WITH LFX MOUNTING OPTIONS)

LFXE-LG-80-150W-50K-P	80W/100W/150W 135LM/W 5000K	1
LFXE-LG-80-150W-MCTP-P	80W/100W/150W 135LM/W 30K/40K/50K	1

POWER & 3CCT ADJUSTABLE BUILDER SERIES FLOOD/AREA LIGHTS WITH PHOTOCELL (COMPATIBLE WITH LFX MOUNTING OPTIONS)

LFXE-XL-200-300W-50K-P	200W/240W/300W 135LM/W 5000K	1
LFXE-XL-200-300W-MCTP-P	200W/240W/300W 135LM/W 30K/40K/50K	1

FOR MOUNTING OPTIONS SEE PAGE 28. (LFX MOUNTING OPTIONS COMPATIBLE WITH LFXE-LG & LFXE-XL, LFXPRO, LFX, LF4PRO, LFXMAX)
FOR COLD-WEATHER EXTERNAL EM OPTION SEE PAGE 176



LFXPRO-LG
Dark Bronze



LFXPRO-LG
White



LFXPRO-LG
Black



LFXPRO-XL
Dark Bronze



LFXPRO-XL
White



LFXPRO-XL
Black

SPEC SERIES POWER & CCT ADJUSTABLE FLOOD/AREA LIGHT, 120-277V TYPE 3 LENS



CATALOG NO.	DESCRIPTION	PKG. QTY.
-------------	-------------	-----------

LFXPRO-LG-50-150W-MCTP	50W/80W/100W/150W 125LM/W 30K/40K/50K/57K	1
LFXPRO-LG-50-150W-MCTP-WH	50W/80W/100W/150W 125LM/W 30K/40K/50K/57K	1
LFXPRO-LG-50-150W-MCTP-BK	50W/80W/100W/150W 125LM/W 30K/40K/50K/57K	1
LFXPRO-XL-150-300W-MCTP	150W/200W/240W/300W 125LM/W 30K/40K/50K/57K	1
LFXPRO-XL-150-300W-MCTP-WH	150W/200W/240W/300W 125LM/W 30K/40K/50K/57K	1
LFXPRO-XL-150-300W-MCTP-BK	150W/200W/240W/300W 125LM/W 30K/40K/50K/57K	1

FOR MOUNTING OPTIONS SEE PAGE 28. (LFX MOUNTING OPTIONS COMPATIBLE WITH LFXE-LG & LFXE-XL, LFXPRO, LFX, LF4PRO, LFXMAX)
FOR COLD-WEATHER L EM OPTION SEE PAGE 176





LF4PRO
Dark Bronze



Shown with
LFX-SF Slip Fitter

SPEC SERIES POWER & CCT ADJUSTABLE ARCHITECTURAL ROUND-BACK FLOOD LIGHT, 120-277V



CATALOG NO.	DESCRIPTION	PKG. QTY.
-------------	-------------	-----------

LF4PRO-50-150W-MCTP 50W/80W/100W/150W **125LM/W** 30K/40K/50K/57K

FOR COLD-WEATHER EM OPTION SEE PAGE 176

FOR MOUNTING OPTIONS SEE PAGE 28. (LFX MOUNTING OPTIONS COMPATIBLE WITH LFXE-LG & LFXE-XL, LFXPRO, LFX, LF4PRO, LFXMAX)

1



LFXMAX SPEC SERIES MAXIMUM-FEATURE AREA/FLOOD LIGHT, SENSOR & PHOTOCELL READY, ROTATE LENS



CATALOG NO.	DESCRIPTION	ARRIVES THIS SEASON CHECK & PRE-ORDER	PKG. QTY.
-------------	-------------	--	-----------

LFXMAX-LG-70-150W-MCTP-PSR 70W/100W/150W **145LM/W** 30K/40K/50K

LFXMAX-XL-200-300W-MCTP-PSR 200W/250W/300W **145LM/W** 30K/40K/50K

LFXMAX-LG-70-150W-MCTP-PSR-480V 70W/100W/150W **145LM/W** 30K/40K/50K

LFXMAX-XL-200-300W-MCTP-PSR-480V 200W/250W/300W **145LM/W** 30K/40K/50K

LFXMAX-LG-LENS-T1S LFXMAX-LG Type T1S Lens

LFXMAX-LG-LENS-T2M LFXMAX-LG Type T2M Lens

LFXMAX-LG-LENS-T4M LFXMAX-LG Type T4M Lens

LFXMAX-LG-LENS-T5M LFXMAX-LG Type T5M Lens

LFXMAX-LG-LENS-TFTM LFXMAX-LG Type Tftm Lens

LFXMAX-LG-LENS-AFR LFXMAX-LG Type Afr Lens

LFXMAX-LG-LENS-T5W LFXMAX-LG Type T5W Lens

LFXMAX-XL-LENS-T1S LFXMAX-XI Type T1S Lens

LFXMAX-XL-LENS-T2M LFXMAX-XI Type T2M Lens

LFXMAX-XL-LENS-T4M LFXMAX-XI Type T4M Lens

LFXMAX-XL-LENS-T5M LFXMAX-XI Type T5M Lens

LFXMAX-XL-LENS-TFTM LFXMAX-XI Type TFTM Lens

LFXMAX-XL-LENS-AFR LFXMAX-XI Type AFR Lens

LFXMAX-XL-LENS-T5W LFXMAX-XI Type T5W Lens

LFXMAX-LG-SHROUD-H LFXMAX-LG Half Shroud

LFXMAX-XL-SHROUD-H LFXMAX-XI Half Shroud

FOR COLD-WEATHER EM OPTION SEE PAGE 176

FOR MOUNTING OPTIONS SEE PAGE 28. (LFX MOUNTING OPTIONS COMPATIBLE WITH LFXE-LG & LFXE-XL, LFXPRO, LFX, LF4PRO, LFXMAX)



LFX-LG
Dark Bronze

LFX-XL
Dark Bronze

LFX-XXL
Dark Bronze

SPEC SERIES POWER-ADJUSTABLE FLOOD/AREA LIGHT, TYPE 3 LENS

Dark Bronze



CATALOG NO.	DESCRIPTION	PKG. QTY.
SPEC SERIES POWER-ADJUSTABLE FLOOD/AREA LIGHT, 120-277V		
LFX-LG-50-150W-30K	50W/80W/100W/150W 140LM/W 3000K	1
LFX-LG-50-150W-40K	50W/80W/100W/150W 140LM/W 4000K	1
LFX-LG-50-150W-50K	50W/80W/100W/150W 140LM/W 5000K	1
LFX-XL-150-300W-30K	150W/200W/240W/300W 145LM/W 3000K	1
LFX-XL-150-300W-40K	150W/200W/240W/300W 145LM/W 4000K	1
LFX-XL-150-300W-50K	150W/200W/240W/300W 145LM/W 5000K	1
LFX-XXL-300-600W-50K	300W/400W/500W/600W 145LM/W 5000K	1
SPEC SERIES POWER-ADJUSTABLE FLOOD/AREA LIGHT, 480V		
LFX-LG-50-150W-50K-480V	50W/80W/100W/150W 140LM/W 5000K	1
LFX-XL-150-300W-50K-480V	150W/200W/240W/300W 145LM/W 5000K	1
LFX-XXL-300-600W-50K-480V	300W/400W/500W/600W 145LM/W 5000K	1
SPEC SERIES POWER & CCT -ADJUSTABLE FLOOD/AREA LIGHT, PHOTOCELL READY 480V		
LFX-LG-80-150W-MCTP- 480V-SC	80W/100W/150W 145LM/W 30K/40K/50K	2
LFX-XL-200-300W- MCTP-480V-SC	200W/240W/300W 145LM/W 30K/40K/50K	3



FOR COLD-WEATHER EM OPTION SEE PAGE 176

FOR MOUNTING OPTIONS SEE PAGE 28. (LFX MOUNTING OPTIONS COMPATIBLE WITH LFXE-LG & LFXE-XL, LFXPRO, LFX, LF4PRO, LFXMAX)



FACTORY-INSTALLED OPTIONS, ENTER DESIRED OPTION CODE(S) AS LINE ITEMS ON YOUR PURCHASE ORDER UNDER THE PRODUCT CATALOG NUMBER

WATTS	EM OPTION	DESCRIPTION	PHOTOCELL	DESCRIPTION	PAINT	SENSOR	DESCRIPTION
LFX-LG	OPT-EM-LFX-LG	EXTERNAL	OPT-3MPC	ELECTRONIC	OPT-CLR-95(BK/GR/SR/WH)	OPT-SEN-3MR-3	PROGRAMMABLE MICRO-WAVE BI-LEVEL
LFX-XL	OPT-EM-LFX-XL	EXTERNAL BOX	OPT-LF3-PCK	TWIST-LOCK		WEC-8RC	REMOTE CONTROL
	LENS OPTION	DESCRIPTION	OPT-LF3-PCK-480V	TWIST-LOCK	OPT-CLR-95MC (260 SET UP FEE PER PROJECT)		
	OPT-LFX-LG-TYPEIV	TYPE IV	WIRES PULLED OUT	DESCRIPTION			
	OPT-LFX-XL-TYPEIV	TYPE IV	OPT-010WPO	0-10V Dim. Wires Pulled Out			
	OPT-LFX-LG-TYPEV	TYPE V					
	OPT-LFX-XL-TYPEV	TYPE V					



SPEC SERIES POWER & CCT- ADJUSTABLE AREA/FLOOD LIGHT

W/ PRE-INSTALLED MOUNTINGS, 120-277V, TYPE 5 LENS 7 DAYS LEAD TIME



DESCRIPTION	MOUNTING	PKG. QTY.
GPX-18-60W-MCTP-PWM 18W/30W/45W/60W 150LM/W 30K/40K/50K Pole/Wall Mount		1
GPX-18-60W-MCTP-SF 18W/30W/45W/60W 150LM/W 30K/40K/50K Slip fitter for 2-3/8" Poles/Piles		1

FOR GPX OPTIONS & ACCESSORIES SEE PAGE 41.

MOUNTING OPTIONS FOR LFX, LFXPRO, LF4PRO, LFXE, LFXMAX SERIES

OUTDOOR AREA LIGHT



LFX-SF (Bronze)

LFX-SF-WH (White)

LFX-SF-BK (Black)

Slip Fitter for LFX & LFX-XXL & LFXPRO & LFXMAX & LF4PRO & LFXE Series



LFX-EXT (Bronze)

LFX-EXT-WH (White)

LFX-EXT-BK (Black)

Straight Arm for LFX & LFX-XXL & LFXPRO & LFXMAX & LF4PRO & LFXE Series



LFX-ASA (Bronze)

LFX-ASA-WH (White)

LFX-ASA-BK (Black)

Adjustable Straight Arm for LFX & LFX-XXL & LFXPRO & LFXMAX & LF4PRO & LFXE Series



LFX-AWB (Bronze)

LFX-AWB-WH (White)

LFX-AWB-BK (Black)

Adjustable Wall Junction Box for LFX & LFX-XXL & LFXMAX & LFXPRO & LF4PRO & LFXE Series



LFX-YK (Bronze)

LFX-YK-WH (White)

LFX-YK-BK (Black)

Yoke for LFX & LFX-XXL & LFXPRO & LFXMAX & LF4PRO & LFXE Series



LFX-TR-A (Bronze)

LFX-TR-A-WH (White)

LFX-TR-A-BK (Black)

U Bracket for LFX & LFXPRO "LG" & LF4PRO & LFXE Series



LFX-TR-B (Bronze)

LFX-TR-B-WH (White)

LFX-TR-B-BK (Black)

U Bracket for LFX "XL" & LFX-XXL & LFXPRO "XL" & LFXE Series



LFX-PASF (Bronze)

LFX-PASF-WH (White)

LFX-PASF-BK (Black)

Pole Adapter for Slip Fitter for LFX & LFX-XXL & LFXMAX & LFXPRO & LF4PRO & LFXE Series

PHOTOCELL FOR LFX SERIES

Microwave Photocell



OPT-3MPC

Twist-Lock Photocell Kit



OPT-LF3-PCK

OPT-LF3-PCK-480V

PHOTOCELL FOR LFXE SERIES



OPT-3MPC
COMPATIBLE WITH
EXT, ASA, SF MOUNTING

7-PIN SOCKET FOR SMART CONTROL RECEIVERS

RECEIVER NOT INCL.

SMART CONTROL RECEIVER SOCKET



OPT-TLS0C7P



LF-SHROUD-A
Dark Bronze
Reversible



LF-SHROUD-D
Dark Bronze



LF-SHROUD-B
Dark Bronze
Reversible



LF-SHROUD-E
Dark Bronze



LF-SHROUD-F
Dark Bronze



LF-SHROUD-G
Dark Bronze



LFX-WG-A
LFX-WG-B
LFXPRO-WG-A
LFXPRO-WG-B

SHROUD & WIRE GUARD FOR LFX, LFX PRO, LF4 PRO SERIES

CATALOG NO.	DESCRIPTION
LF-SHROUD-A	Half Shroud for LFX & LFXPRO "LG" & LF4PRO Series, Reversible (Back or Front)
LF-SHROUD-B	Half Shroud for LFX & LFXPRO "XL" Series, Reversible (Back or Front)
LF-SHROUD-F	Half Shroud for LFX "XXL" Series
LF-SHROUD-D	Full Shroud for LFX & LFXPRO "LG" & LF4PRO Series
LF-SHROUD-E	Full Shroud for LFX & LFXPRO "XL" Series
LF-SHROUD-G	Full Shroud for LFX "XXL" Series
LFX-WG-A	Wire Guard for LFX "LG" Series
LFX-WG-B	Wire Guard for LFX "XL" Series
LFXPRO-WG-A	Wire Guard for LFXPRO "LG" Series
LFXPRO-WG-B	Wire Guard for LFXPRO "XL" Series



LFE-15W
Dark Bronze



LFE-30W
Dark Bronze



LFE-50W
Dark Bronze

BUILDER SERIES COMPACT FLOOD LIGHTS, INCL. 3CCT VERSIONS WITH 1/2" KNUCKLE, 120V



CATALOG NO.	DESCRIPTION	PKG. QTY.
LFE-15W-30K-KN	15W 1600LM 3000K	48
LFE-15W-40K-KN	15W 1600LM 4000K	48
LFE-15W-50K-KN	15W 1600LM 5000K	48
3CCT VERSION COMPACT FLOOD LIGHTS MCT		
LFE-15W-MCT-KN	15W 1600LM 3000K/4000K/5000K	48
LFE-30W-MCT-KN	30W 3250LM 3000K/4000K/5000K	24
LFE-50W-MCT-KN	50W 5250LM 3000K/4000K/5000K	16
3CCT VERSION COMPACT FLOOD LIGHTS WITH PHOTOCELL MCTP		
LFE-15W-MCT-KN-P	15W 1600LM 30K/40K/50K	48
LFE-30W-MCT-KN-P	30W 3250LM 30K/40K/50K	24
LFE-50W-MCT-KN-P	50W 5250LM 30K/40K/50K	16

OUTDOOR
FLOOD LIGHTS



LFX-XS
Dark Bronze



LFX-SM
Dark Bronze



LFX-SM
White



LFX-SM
Black



LFX-SM
Silver



LFX-MD
Dark Bronze



LFX-MD
White



LFX-MD
Black



LFX-MD
Silver

SPEC SERIES X-GEN. SMALL FLOOD LIGHTS

0-10V DIM., INCL. MULTI POWER & MULTI POWER + 3CCT (WITH KNUCKLE) 120-277V



CATALOG NO.	DESCRIPTION	PKG. QTY.
EXTRA SMALL FLOOD LIGHT		
LFX-XS-15W-30K-KN	15W 1950LM 3000K	18
LFX-XS-15W-40K-KN	15W 1950LM 4000K	18
LFX-XS-15W-50K-KN	15W 1950LM 5000K	18
POWER-ADJUSTABLE SMALL FLOOD LIGHT MP		
LFX-SM-10-30W-30K-KN	10W/15W/20W/30W 130LM/W 3000K	10
LFX-SM-10-30W-40K-KN	10W/15W/20W/30W 130LM/W 4000K	10
LFX-SM-10-30W-50K-KN	10W/15W/20W/30W 130LM/W 5000K	10
LFX-MD-15-50W-30K-KN	15W/20W/30W/50W 130LM/W 3000K	6
LFX-MD-15-50W-40K-KN	15W/20W/30W/50W 130LM/W 4000K	6
LFX-MD-15-50W-50K-KN	15W/20W/30W/50W 130LM/W 5000K	6
POWER & CCT-ADJUSTABLE SMALL FLOOD LIGHT MCTP		
LFX-SM-10-30W-MCTP-KN	10W/15W/20W/30W 130LM/W 30K/40K/50K/57K	6
LFX-SM-10-30W-MCTP-KN-WH	10W/15W/20W/30W 130LM/W 30K/40K/50K/57K	6
LFX-SM-10-30W-MCTP-KN-BK	10W/15W/20W/30W 130LM/W 30K/40K/50K/57K	6
LFX-SM-10-30W-MCTP-KN-SV	10W/15W/20W/30W 130LM/W 30K/40K/50K/57K	6
LFX-MD-15-50W-MCTP-KN	15W/20W/30W/50W 130LM/W 30K/40K/50K/57K	6
LFX-MD-15-50W-MCTP-KN-WH	15W/20W/30W/50W 130LM/W 30K/40K/50K/57K	6
LFX-MD-15-50W-MCTP-KN-BK	15W/20W/30W/50W 130LM/W 30K/40K/50K/57K	6
LFX-MD-15-50W-MCTP-KN-SV	15W/20W/30W/50W 130LM/W 30K/40K/50K/57K	6

LED FLOOD LIGHTS LF3 SERIES WITH KNUCKLE, 120-277V (NOT DIMMABLE)



CATALOG NO.	DESCRIPTION	WHILE SUPPLIES LAST	REPLACEMENT RANGE	PKG. QTY.
 LF3-15NW-KN	15W 1700LM 4000K Bronze		50-70 MH	18
LF3-50NW-KN	50W 6100LM 4000K Bronze		100-175 MH	6
LF3-WH-15CW-KN	15W 1600LM 5000K White		50-70 MH	18

LED FLOOD LIGHTS LF3 SERIES, 120-277V (1-10V DIMMABLE)

Dark Bronze



CATALOG NO.	DESCRIPTION	WHILE SUPPLIES LAST	REPLACEMENT RANGE	PKG. QTY.
 LF3-HL-30W-40K-D-KN	30W 3600LM 4000K 0-10V dimming		70-100 MH	1
LF3-HL-50W-30K-D-KN	50W 6100LM 3000K 0-10V dimming		100-175 MH	1
LF3-HL-50W-40K-D-KN	50W 6100LM 4000K 0-10V dimming		100-175 MH	1



LF4-15W-50K-KN
LF4-15W-30K-KN
Dark Bronze



LF4-30W-50K-D-KN
LF4-30W-30K-D-KN
Dark Bronze



LF4-50W-50K-D-KN
LF4-50W-30K-D-KN
Dark Bronze

SPEC SERIES LED ARCHITECTURAL ROUND-BACK FLOOD LIGHTS, 0-10V DIMMING 120-277V



CATALOG NO.	DESCRIPTION	WHILE SUPPLIES LAST	REPLACEMENT RANGE	PKG. QTY.
LF4-15W-50K-KN	15W 1900LM 5000K		50-70 MH	12
LF4-15W-30K-KN	15W 1900LM 3000K		100-175 MH	12
LF4-30W-50K-D-KN	30W 4050LM 5000K		50-70 MH	6
LF4-30W-30K-D-KN	30W 4050LM 3000K		100-175 MH	6
LF4-50W-50K-D-KN	50W 6750LM 5000K		50-70 MH	6
LF4-50W-30K-D-KN	50W 6750LM 3000K		100-175 MH	6

LED ARCHITECTURAL ROUND-BACK FLOOD LIGHTS, 120V-277V



CATALOG NO.	DESCRIPTION	WHILE SUPPLIES LAST	REPLACEMENT RANGE	PKG. QTY.
 LF4-12CW-KN	12W 1300LM 5000K		50-70 MH	12
LF4-50CW-KN	50W 5600LM 5000K		100-175 MH	6



LFE-15W-30K-TR
LFE-15W-40K-TR
LFE-15W-50K-TR
Dark Bronze



LFE-15W-MCT-TR
LFE-30W-MCT-TR
Dark Bronze



LFE-50W-MCT-TR
Dark Bronze

BUILDER SERIES COMPACT FLOOD LIGHTS, INCL. 3CCT VERSIONS WITH U BRACKET, 120V



CATALOG NO.	DESCRIPTION	WHILE SUPPLIES LAST	REPLACEMENT RANGE	PKG. QTY.
LFE-15W-30K-TR	15W 1600LM 3000K		50-70 MH	48
LFE-15W-40K-TR	15W 1600LM 4000K		100-175 MH	48
LFE-15W-50K-TR	15W 1600LM 5000K		50-70 MH	48
3CCT VERSION COMPACT FLOOD LIGHTS		MCT		
LFE-15W-MCT-TR	15W 1600LM 3000K/4000K/5000K		50-70 MH	48
LFE-30W-MCT-TR	30W 3250LM 3000K/4000K/5000K		100-175 MH	24
LFE-50W-MCT-TR	50W 5250LM 3000K/4000K/5000K		50-70 MH	16

OUTDOOR
FLOOD LIGHTS



LFX-XS
Dark Bronze



LFX-SM
Dark Bronze



LFX-MD
Dark Bronze

SPEC SERIES X-GEN. SMALL FLOOD LIGHTS

0-10V DIM., INCL. MULTI POWER & MULTI POWER + 3CCT (WITH U BRACKET) 120-277V



CATALOG NO.	DESCRIPTION	PKG. QTY.
EXTRA SMALL FLOOD LIGHT		
LFX-XS-15W-30K-TR	15W 1950LM 3000K	18
LFX-XS-15W-40K-TR	15W 1950LM 4000K	18
LFX-XS-15W-50K-TR	15W 1950LM 5000K	18
POWER-ADJUSTABLE SMALL FLOOD LIGHT MP		
LFX-SM-10-30W-30K-TR	10W/15W/20W/30W 130LM/W 3000K	10
LFX-SM-10-30W-50K-TR	10W/15W/20W/30W 130LM/W 5000K	10
LFX-MD-15-50W-30K-TR	15W/20W/30W/50W 130LM/W 3000K	10
LFX-MD-15-50W-50K-TR	15W/20W/30W/50W 130LM/W 5000K	10
POWER & CCT-ADJUSTABLE SMALL FLOOD LIGHT MCTP		
LFX-SM-10-30W-MCTP-TR	10W/15W/20W/30W 130LM/W 30K/40K/50K/57K	6
LFX-MD-15-50W-MCTP-TR	15W/20W/30W/50W 130LM/W 30K/40K/50K/57K	6

LED FLOOD LIGHTS LF3 SERIES WITH U BRACKET, 120-277V (NOT DIMMABLE)



CATALOG NO.	DESCRIPTION	REPLACEMENT RANGE	PKG. QTY.
LF3-15NW-TR	15W 1700LM 4000K	50-70 MH	18
LF3-WH-30W-TR	30W 3600LM 3000K White	70-100 MH	10
LF3-30NW-TR	30W 3600LM 4000K	70-100 MH	10
LF3-50NW-TR	50W 6100LM 4000K	100-175 MH	6

FACTORY-INSTALLED OPTIONS, ENTER DESIRED OPTION CODE(S) AS LINE ITEMS ON YOUR PURCHASE ORDER UNDER THE PRODUCT CATALOG NUMBER

WATTS	EM OPTION	DESCRIPTION	PHOTOCELL	DESCRIPTION	PAINT	SENSOR	DESCRIPTION
LFX-MD-KN & LFX-MD-TR	N/A	N/A	OPT-PC-BUM	BUTTON	N/A	N/A	N/A



LF4 with Half Shroud



LF3-HL with Half Shroud



LF4 with Full-Glare Shroud



LF3-HL with Full-Glare Shroud

SHROUD FOR LFX, LF3 & LF4 SMALL SERIES

CATALOG NO.	DESCRIPTION
LF4-SH1	Fits LF4-12W & 15W, LF4-12V-6W & 12W (Polycarbonate)
LF4-SH2	Fits LF4-30W, LF4-12V-24W & 30W (Polycarbonate)
LF4-SH3	Fits LF4-50W, LF4-12V-50W (Polycarbonate)
LF4-SH4	Fits LF4-80W & 100W, (Aluminum)
LF4-SH5	Fits LF4-150W (Aluminum)
LF3-SH1	Shroud for LFX-SM* & LF3-30W & LF3-HL-30W, Reversible, Aluminum
LF3-SH2	Shroud for LFX-SM-MCTP & LFX-MD & LF3-50W & LF3-HL-50W, Reversible, Aluminum
LF3-SH1FG	Full-Glare Shroud for LF3-30W & LF3-HL-30W & LF4-12W & LF4-30W, Aluminum
LF3-SH2FG	Full-Glare Shroud for LF3-50W & LF3-HL-50W & LF4-50W, Aluminum



LFE-80W-MCT-D
LFE-100W-MCT-D
Dark Bronze



Shown with
1/2in knuckle mounting option,
fits 80w and larger



Shown with
slip fitter mounting option,
fits 80w and larger



Shown with
bottom bracket mounting
option, fits 80w and larger

COMPACT FLOOD LIGHTS
3CCT VERSIONS, 120~277V, MOUNTING OPT. SOLD SEPARATELY



CATALOG NO.	DESCRIPTION	PKG. QTY.
LFE-80W-MCT-D	80W 10500LM 3000K/4000K/5000K	1
LFE-100W-MCT-D	100W 13000LM 3000K/4000K/5000K	1
LFE-KN	LFE 1/2in knuckle mounting option, fits 80w and larger	
LFE-SF	LFE slip fitter mounting option, fits 80w and larger	
LFE-YK	LFE bottom bracket mounting option, fits 80w and larger	



LF4PRO
Dark Bronze



Shown with
LFX-SF Slip Fitter

SPEC SERIES POWER & CCT ADJUSTABLE
ARCHITECTURAL ROUND-BACK FLOOD LIGHT, 120~277V



CATALOG NO.	DESCRIPTION	PKG. QTY.
LF4PRO-50-150W-MCTP	50W/80W/100W/150W 125LM/W 30K/40K/50K/57K FOR MOUNTING OPTIONS SEE PAGE 28. (LFX MOUNTING OPTIONS COMPATIBLE WITH LFXE-LG & LFXE-XL, LFXPRO, LFX, LF4PRO, LFXMAX)	1



LFCO-50W-50K
Dark Bronze



LFCO-150W-40K
Dark Bronze



LFCO-SA
Straight Arm



LFCO-SF
Slip Fitter



LFCO-TRI
(For 50W, 80W, 100W, 150W)
"U" Bracket



LFCO-YK
Yoke

ECONOMY FLOOD/AREA LIGHT SERIES TYPE 3 LENSES

Dark Bronze



CATALOG NO.	DESCRIPTION	PKG. QTY.
LFCO-50W-50K	50W 6900LM 5000K	1
LFCO-150W-40K	150W 19900LM 4000K	1

WHILE SUPPLIES LAST



FACTORY-INSTALLED OPTIONS, ENTER DESIRED OPTION CODE(S) AS LINE ITEMS ON YOUR PURCHASE ORDER UNDER THE PRODUCT CATALOG NUMBER

WATTS	EM OPTION	DESCRIPTION	PHOTOCELL	DESCRIPTION	PAINT	SENSOR	DESCRIPTION
UP TO 230W 300W	OPT-EM-0D2EXT	EXTERNAL BOX	OPT-3MPC	ELECTRONIC	OPT-CLR-95(BK/GR/ SR/WHJ (300W Only)	OPT-SEN-3MR-3	PROGRAMMABLE MICROWAVE BI-LEVEL REMOTE CONTROL
	OPT-EM-0D2EXT	EXTERNAL	OPT-010WPO	0-10V Dim. Wires Pulled Out		WEC-8RC	

POLE / ADAPTER ACCESSORIES
BRONZE FINISH

- 3"** PSS3SVTZ
- 4"** PSS4SVTZ
- 5"** PSS5SVTZ



3", 4", 5" square pole vertical tenon, 3", 4", 5", bronze. Goes inside 3", 4", 5" pole to accept 2" slip fitter.

- 3"** PRPT3
- 4"** PRPT4
- 5"** PRPT5



Tenon adaptor, 3", 4", 5" round pole, to standard tenon, bronze



PSR4
Round to Square Adapter kit for 3", 4" and 5" round poles
Separate gasket provided for each size pole.



LF-AD-SF
Slip onto pole top 2" Dim. fixture mounts directly on the side or top of the fixture



LF-AD-KNU
Fits over a standard tenon or bullhorn to adapt it to a 1/2" NPT threaded hub for knuckle fixtures.



PSS4C
Pole cap polycarbonate



PSS3R
3" Center Bullhorn replacement cap

WALL MOUNT ACCESSORIES
BRONZE FINISH

LF3-WMA
Wall mount plate bronze



LFX-PASF (Bronze)



LFX-PASF-WH (White)

LFX-PASF-BK (Black)
Pole Adapter for Slip Fitter for LFX & LFX-XXL & LFXPRO & LF4PRO Series

ACC-WM2

Wall mount bracket 90° curve bronze with 2" tenon to be used with Westgate slip fitter fixtures(-SF)



ACC-WM3

Wall mount bracket 90° bronze with 2" tenon to be used with Westgate slip fitter fixtures(-SF)



ACC-WM4

Wall mount bracket bronze with 2" tenon to be used with Westgate slip fitter fixtures (-SF)



BULLHORNS
BRONZE FINISH

PT2-180-R
Double in-line at 180°, 1"(H), 3' between centers



PT3-120
Triple at 120°, 1"(H), 3'-5" between centers, slips on 2-3/8" tenon

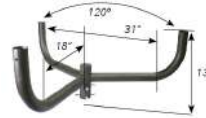

PT2-180-S
Square Pole Base Double in-line at 180°, 1"(H), 3' between centers, slips into 4" pole



PT4-090
Quad at 90° 1"(H), 2'-10" between centers, slips on 2-3/8" tenon



PT3-180
Double in-line at 180°, 1"(H), 2'-7" between centers, slips on 2-3/8" pole

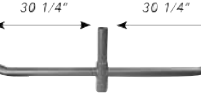

PT4-180
Quad in-line at 180° 1(H), 2'-7", between centers, slips on 2-3/8" pole

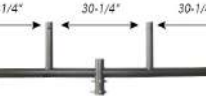

ACC-WMA-30-BR
Flood Light Wall-Mounting Arm 30In, Bronze



ACC-WMA-30-BK
Flood Light Wall-Mounting Arm 30In, Black



ACC-WPM20

20In Wall And Pole Mounting Arm For Flood Lights With A Slip Fitter

BULLHORNS
BRONZE FINISH



PTA-190
90 degree round pole tenon adapter for 1 fixture, slips into 2-3/8" pole



PTA-290
90 degree round pole tenon adapter for 2 fixture, slips into 2-3/8" pole

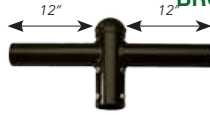

PTA-2180
180 degree round pole tenon adapter for 2 fixture, slips into 2-3/8" pole



PTA-390
90 degree round pole tenon adapter for 3 fixture, slips into 2-3/8" pole

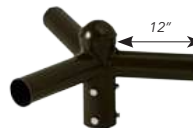

PTA-3120
120 degree round pole tenon adapter for 3 fixture, slips into 2-3/8" pole



PTA-490
90 degree round pole tenon adapter for 4 fixture, slips into 2-3/8" pole

TENONS
BRONZE FINISH



PSS4L1HTZ

Square (single) horizontal tenon, bronze. goes inside 4" pole. No adaptor needed



PSS4T180HTZ

Square (twin) horizontal tenon, 180°, bronze. goes inside 4" pole. No adaptor needed



PSS4T90HTZ

Square (twin) horizontal tenon, 90°, bronze. goes inside 4" pole. No adaptor needed



PSS4TR90HTZ

Square (triple) horizontal tenon, 90°, bronze. goes inside 4" pole. No adaptor needed



PSS4Q90HTZ

Square (quad) horizontal tenon, 90°, bronze. Slips on 4" pole. (fits inside pole top)



PSS4Q90VTZ

4" 90° quad square vertical tenon. (fits inside pole top)

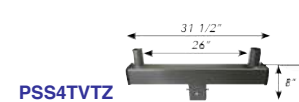

PSS4TVTZ

Twin square vertical tenon for 4" square pole. Two 2-3/8" vertical tenons. (fits inside pole top)

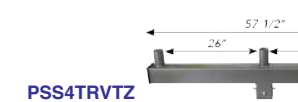

PSS4TRVTZ

Triple square vertical tenon for 4" square pole. Three 2-3/8" vertical tenons. (fits inside pole top)

FACTORY-INSTALLED OPTIONS, ENTER DESIRED OPTION CODE(S) AS LINE ITEMS ON YOUR PURCHASE ORDER UNDER THE PRODUCT CATALOG NUMBER

TYPE	CATALOG NO.	PAINT
WALL MOUNT/POLE/ADAPTER	LF3-WMA, ACC-WM2, ACC-WM3, ACC-WM4, PSS3SVTZ, PSS4SVTZ, PSS5SVTZ, PRPT3, PRPT4, PRPT5, PSR4, LF-AD-KNU, PSS4C	OPT-CLR-35(BK/GR/SR/WH) OPT-CLR-35(BK/GR/SR/WH)
BULLHORNS	PTA-190, PTA-290, PTA-2180, PTA-390, PTA-3120, PTA-490	OPT-CLR-60(BK/GR/SR/WH) OPT-CLR-40(BK/GR/SR/WH)
BULLHORNS	PT2-180-R, PT2-180-S, PT3-120, PT3-180, PT4-090, PT4-180	OPT-CLR-75(BK/GR/SR/WH)
TENONS	PSS4T180HTZ, PSS4T90HTZ, PSS4TR90HTZ, PSS4Q90HTZ	
TENONS	PSS4Q90VTZ, PSS4TVTZ, PSS4TRVTZ	



Can be used as **SIGN LIGHT**
Shown with ACC-WMA-30-BR
(See page 33)

Shown with optional
FLDVX-FS Flat Shroud



SPEC SERIES LED X-GEN BULLET FLOOD LIGHTS WITH LONG SHROUDS, 120-277V

CATALOG NO.	DESCRIPTION				PKG. QTY.
FLDX-SM-15W-30K-BR	15W	1800LM	3000K	60°	12
FLDX-SM-15W-30K-BK	15W	1800LM	3000K	60°	12
FLDX-SM-15W-40K-BR	15W	1800LM	4000K	60°	12
FLDX-SM-15W-40K-BK	15W	1800LM	4000K	60°	12
FLDX-SM-15W-50K-BR	15W	1800LM	5000K	60°	12
FLDX-SM-15W-50K-BK	15W	1800LM	5000K	60°	12
FLDX-MD-10-30W-30K-BR	10W/20W/30W	120LM/W	3000K	60°	8
FLDX-MD-10-30W-30K-BK	10W/20W/30W	120LM/W	3000K	60°	8
FLDX-MD-10-30W-40K-BR	10W/20W/30W	120LM/W	4000K	60°	8
FLDX-MD-10-30W-40K-BK	10W/20W/30W	120LM/W	4000K	60°	8
FLDX-MD-10-30W-50K-BR	10W/20W/30W	120LM/W	5000K	60°	8
FLDX-MD-10-30W-50K-BK	10W/20W/30W	120LM/W	5000K	60°	8
FLDX-LG-10-30W-MCTP-BR	10W/20W/30W	120LM/W	3000K/4000K/5000K	60°	4
FLDX-LG-10-30W-MCTP-BK	10W/20W/30W	120LM/W	3000K/4000K/5000K	60°	4
FLDX-LG-30-50W-MCTP-BR	30W/40W/50W	120LM/W	3000K/4000K/5000K	35°	4
FLDX-LG-30-50W-MCTP-BK	30W/40W/50W	120LM/W	3000K/4000K/5000K	35°	4
FLDVX-FS-SM-BR	Flat Shroud For Sm Size Housing, Bronze				
FLDVX-FS-SM-BK	Flat Shroud For Sm Size Housing, Black				
FLDVX-FS-MD-BR	Flat Shroud For Md Size Housing, Bronze				
FLDVX-FS-MD-BK	Flat Shroud For Md Size Housing, Black				
FLDVX-FS-LG-BR	Flat Shroud For Lg Size Housing, Bronze				
FLDVX-FS-LG-BK	Flat Shroud For Lg Size Housing, Black				
FLDVX-SM-RL35	35-Degree Repl. Lens For Sm Size Housing				
FLDVX-MD-RL35	35-Degree Repl. Lens For Md Size Housing				
FLDVX-LG-RL35	35-Degree Repl. Lens For Lg Size Housing				
FLDVX-LG-RL60	60-Degree Repl. Lens For Lg Size Housing				

120-277V



SPEC SERIES POWER, CCT & BEAM ANGLE- ADJUSTABLE LED X-GEN BULLET FLOOD LIGHTS WITH INTEGRATED PHOTOCELL, 120-277V



CATALOG NO.	DESCRIPTION				PKG. QTY.
FLDXPRO-SM-5-15W-MCTPB-BR	5W/10W/15W	95LM/W	30K/40K/50K	Bronze	4
FLDXPRO-SM-5-15W-MCTPB-BK	5W/10W/15W	95LM/W	30K/40K/50K	Black	4
FLDXPRO-SM-5-15W-MCTPB-WH-P	5W/10W/15W	95LM/W	30K/40K/50K	White	4
FLDXPRO-MD-10-30W-MCTPB-BR	10W/20W/30W	95LM/W	30K/40K/50K	Bronze	4
FLDXPRO-MD-10-30W-MCTPB-BK	10W/20W/30W	95LM/W	30K/40K/50K	Black	4
FLDXPRO-MD-10-30W-MCTPB-WH-P	10W/20W/30W	95LM/W	30K/40K/50K	White	4

120-277V

OUTDOOR

GARDEN LIGHTS



BLUETOOTH WG APP COMPATIBLE RGBW FLOOD LIGHT, 60D LENS, 120-277V



120-277V

CATALOG NO.	DESCRIPTION	PKG. QTY.
TC-FL-36W-RGBW-BT-BR	36W 824LM RGBW	4

OUTDOOR
GARDEN LIGHTS



LED GARDEN FLOOD LIGHTS, 120-277V



120-277V

CATALOG NO.	DESCRIPTION	PKG. QTY.
GL-12W-30K-BR	12W 960LM 3000K Bronze	6
GL-12W-40K-BR	12W 960LM 4000K Bronze	6
GL-12W-50K-BR	12W 960LM 5000K Bronze	6
GL-24W-30K-BR	24W 1920LM 3000K Bronze	6
GL-24W-40K-BR	24W 1920LM 4000K Bronze	6
GL-24W-50K-BR	24W 1920LM 5000K Bronze	6



GL-MCTP-BR
Bronze



GL-MCTP-BK
Black



GL-MCTP-WH
White



MCTP-RC1
Required & One per projects

LED WHITE TUNABLE GARDEN FLOOD REMOTE SOLD SEPARATELY, 120-277V



120-277V

CATALOG NO.	DESCRIPTION	PKG. QTY.
GL-MCTP-BK	20W MAX. 1400LM MAX. 3000K-5700K Black	6
GL-MCTP-BR	20W MAX. 1400LM MAX. 3000K-5700K Bronze	6
GL-MCTP-WH	20W MAX. 1400LM MAX. 3000K-5700K White	6
MCTP-RC1	Remote Control for Multi-Color Temp. & Power Outdoor Fixture (Required & One per projects)	-



Flat

AD120-017-MCT-ORB
Oil-Rubbed Bronze



Flat

AD120-017-MCT-BK
Black



Flat

AD120-017-MCT-WH
White



Shroud

AD120-018-MCT-ORB
Oil-Rubbed Bronze



Shroud

AD120-018-MCT-BK
Black

120V GARDEN BULLET WITHOUT OR WITH SHROUD, INTEGRATED 3CCT

CATALOG NO.	DESCRIPTION
AD120-017-MCT-ORB	8W 700LM 30K/40K/50K 17"
AD120-017-MCT-BK	8W 700LM 30K/40K/50K 17"
AD120-017-MCT-WH	8W 700LM 30K/40K/50K 17"
AD120-018-MCT-ORB	8W 700LM 30K/40K/50K 18"
AD120-018-MCT-BK	8W 700LM 30K/40K/50K 18"



3RD GENERATION 3CCT FLOOD HEAD, 120-277V



CATALOG NO.	DESCRIPTION	PKG. QTY.
FLD3-13W-MCT-D-KN	13W 1820LM 3000K/4000K/5000K	12
FLD3-25W-MCT-D-KN	25W 3500LM 3000K/4000K/5000K	12



FLD2-15W
Bronze



FLD2-28W
Bronze



FLD2-42W
Bronze



SHOWN WITH SHROUD

GARDEN AND FLAG BULLET LIGHT, 120-277V



CATALOG NO.	DESCRIPTION	REPLACEMENT RANGE	PKG. QTY.
FLD2-15W-30K-D-KN	15W 1900LM 3000K	50-70 MH	12
FLD2-15W-50K-D-KN	15W 1900LM 5000K	50-70 MH	12
FLD2-28W-30K-D-KN	28W 3500LM 3000K	70-100 MH	8
FLD2-28W-50K-D-KN	28W 3500LM 5000K	70-100 MH	8
FLD2-42W-30K-D-KN	42W 5200LM 3000K	100-175 MH	6
FLD2-42W-50K-D-KN	42W 5200LM 5000K	100-175 MH	6

FOR SHROUDS SEE PAGE 36.

FACTORY-INSTALLED OPTIONS, ENTER DESIRED OPTION CODE(S) AS LINE ITEMS ON YOUR PURCHASE ORDER UNDER THE PRODUCT CATALOG NUMBER

WATTS	WIRES PULLED OUT	DESCRIPTION	PHOTOCELL	DESCRIPTION	PAINT	SENSOR	DESCRIPTION
ALL MODELS	OPT-010WPO	0-10V Dim. Wires Pulled Out		N/A	N/A	N/A	N/A

12-VOLT AC/DC LED GARDEN FLOOD LIGHTS



CATALOG NO.	DESCRIPTION	PKG. QTY.
GL-12V-12W-30K-BR	12W 960LM 3000K bronze Spike Incl.	6
GL-12V-12W-40K-BR	12W 960LM 4000K bronze Spike Incl.	6
GL-12V-12W-50K-BR	12W 960LM 5000K bronze Spike Incl.	6
GL-12V-24W-30K-BR	24W 1920LM 3000K bronze Spike Incl.	6
GL-12V-24W-40K-BR	24W 1920LM 4000K bronze Spike Incl.	6
GL-12V-24W-50K-BR	24W 1920LM 5000K bronze Spike Incl.	6



12V



FLVX-SM
Bronze

FLVX-SM
Black

FLVX-MD
Bronze

FLVX-MD
Black

FLVX-LG
Bronze

FLVX-LG
Black

Shown with optional
FLDVX-FS Flat Shroud



12V SPEC SERIES LED X-GEN BULLET FLOOD LIGHTS WITH LONG SHROUDS

CATALOG NO.	DESCRIPTION					PKG. QTY.
FLVX-SM-6W-30K-BR	6W	700LM	3000K	60°	Bronze	12
FLVX-SM-6W-30K-BK	6W	700LM	3000K	60°	Black	12
FLVX-SM-6W-40K-BR	6W	700LM	4000K	60°	Bronze	12
FLVX-SM-6W-40K-BK	6W	700LM	4000K	60°	Black	12
FLVX-SM-12W-30K-BR	12W	1400LM	3000K	60°	Bronze	12
FLVX-SM-12W-30K-BK	12W	1400LM	3000K	60°	Black	12
FLVX-SM-12W-40K-BR	12W	1400LM	4000K	60°	Bronze	12
FLVX-SM-12W-40K-BK	12W	1400LM	4000K	60°	Black	12
FLVX-MD-24W-30K-BR	24W	2900LM	3000K	60°	Bronze	8
FLVX-MD-24W-30K-BK	24W	2900LM	3000K	60°	Black	8
FLVX-MD-24W-40K-BR	24W	2900LM	4000K	60°	Bronze	8
FLVX-MD-24W-40K-BK	24W	2900LM	4000K	60°	Black	8
FLVX-LG-30-50W-MCTP-BR	30W/40W/50W	95LM/W	30K/40K/50K	35°	Bronze	4
FLVX-LG-30-50W-MCTP-BK	30W/40W/50W	95LM/W	30K/40K/50K	35°	Black	4
FLDVX-FS-SM-BR	Flat Shroud For Sm Size Housing, Bronze					
FLDVX-FS-SM-BK	Flat Shroud For Sm Size Housing, Black					
FLDVX-FS-MD-BR	Flat Shroud For Md Size Housing, Bronze					
FLDVX-FS-MD-BK	Flat Shroud For Md Size Housing, Black					
FLDVX-SM-RL35	35-Degree Repl. Lens For Sm Size Housing					
FLDVX-MD-RL35	35-Degree Repl. Lens For Md Size Housing					
FLDVX-LG-RL60	60-Degree Repl. Lens For LG Size Housing					

12V



FLVXPRO-SM
Bronze

FLVXPRO-SM
Black

FLVXPRO-MD
Bronze

FLVXPRO-MD
Black

12V SPEC SERIES POWER, CCT & BEAM ANGLE- ADJUSTABLE LED X-GEN BULLET FLOOD LIGHTS WITH INTEGRATED PHOTOCELL

CATALOG NO.	DESCRIPTION					PKG. QTY.
FLVXPRO-SM-6-12W-MCTPB-BR	3W/6W/12W	90LM/W	30K/40K/50K			4
FLVXPRO-SM-6-12W-MCTPB-BK	3W/6W/12W	90LM/W	30K/40K/50K			4
FLVXPRO-MD-10-30W-MCTPB-BR	10W/20W/30W	90LM/W	30K/40K/50K			4
FLVXPRO-MD-10-30W-MCTPB-BK	10W/20W/30W	90LM/W	30K/40K/50K			4

12V



BLUETOOTH WG APP COMPATIBLE RGBW FLOOD LIGHT, 40D LENS, 12V



12V

CATALOG NO.	DESCRIPTION	PKG. QTY.
TC-GL-12V-15W-RGBW-BT-BR	15W 405LM RGBW	6



BLUETOOTH WG APP COMPATIBLE RGBW FLOOD LIGHT, 60D LENS, 12V



OUTDOOR

CATALOG NO.	DESCRIPTION	PKG. QTY.
TC-FL-12V-36W-RGBW-BT-BR	36W 824LM RGBW	4



12-VOLT AC (AC/DC ON 6W&12W) LED BULLET LANDSCAPE FLOOD LIGHT



12V

CATALOG NO.	DESCRIPTION	REPLACEMENT RANGE	PKG. QTY.
FLV12-6W-30K	6W 500LM 3000K SPIKE Incl. 35°	35-50 MR16	12
FLV12-6W-50K	6W 550LM 5000K SPIKE Incl. 35°	35-50 MR16	12
FLV12-12W-30K	12W 1200LM 3000K SPIKE Incl. 35°		12
FLV12-12W-50K	12W 1300LM 5000K SPIKE Incl. 35°		12
FLV12-24W-30K	24W 2200LM 3000K SPIKE Incl. 35°		12
FLV12-24W-50K	24W 2500LM 5000K SPIKE Incl. 35°		12
FLV12-32W-30K	32W 3200LM 3000K SPIKE Incl. 35°		12
FLV12-32W-50K	32W 3500LM 5000K SPIKE Incl. 35°		12



SHOWN WITH SHROUD FOR SHROUDS SEE PAGE 56.

12-VOLT AC (AC/DC ON 6W&12W) INTEGRATED LED WALL WASH LIGHTS



12V

CATALOG NO.	DESCRIPTION	PKG. QTY.
LF4-12V-6W-30K	6W 440LM 3000K BRONZE SPIKE Incl.	12
LF4-12V-6W-50K	6W 500LM 5000K BRONZE SPIKE Incl.	12
LF4-12V-12W-30K	12W 1080LM 3000K BRONZE SPIKE Incl.	12
LF4-12V-12W-50K	12W 1260LM 5000K BRONZE SPIKE Incl.	12
LF4-12V-24W-30K	24W 2155LM 3000K BRONZE SPIKE Incl.	6
LF4-12V-24W-50K	24W 2500LM 5000K BRONZE SPIKE Incl.	6
LF4-12V-30W-30K	30W 2700LM 3000K BRONZE SPIKE Incl.	6
LF4-12V-30W-50K	30W 3150LM 5000K BRONZE SPIKE Incl.	6
LF4-12V-50W-30K	50W 4500LM 3000K BRONZE SPIKE Incl.	6
LF4-12V-50W-50K	50W 5250LM 5000K BRONZE SPIKE Incl.	6



SHOWN WITH SHROUD FOR SHROUDS SEE PAGE 56.

12-VOLT AC/DC INTEGRATED LED LANDSCAPE UPLIGHTS



12V

CATALOG NO.	DESCRIPTION	PKG. QTY.
LFLV-7W-27K	7W 500LM 2700K BRONZE 40° ADJUSTABLE HOOD	12
LFLV-7W-30K	7W 500LM 3000K BRONZE 40° ADJUSTABLE HOOD	12
LFLV-7W-40K	7W 550LM 4000K BRONZE 40° ADJUSTABLE HOOD	12
LFLV-7W-50K	7W 550LM 5000K BRONZE 40° ADJUSTABLE HOOD	12
LFLV-12W-27K	12W 800LM 2700K BRONZE 60° ADJUSTABLE HOOD	12
LFLV-12W-30K	12W 800LM 3000K BRONZE 60° ADJUSTABLE HOOD	12
LFLV-12W-40K	12W 900LM 4000K BRONZE 60° ADJUSTABLE HOOD	12
LFLV-12W-50K	12W 900LM 5000K BRONZE 60° ADJUSTABLE HOOD	12



12-VOLT AC/DC LED GARDEN LIGHT



12V

CATALOG NO.	DESCRIPTION	PKG. QTY.
LF12-6W-27K-KN	6W 400LM 2700K KNUCKLE , SPIKE INCL. 45° COB WITH ALUM REFL.	40
LF12-6W-30K-KN	6W 400LM 3000K KNUCKLE , SPIKE INCL. 45° COB WITH ALUM REFL.	40
LF12-6W-40K-KN	6W 450LM 4000K KNUCKLE , SPIKE INCL. 45° COB WITH ALUM REFL.	40
LF12-6W-50K-KN	6W 450LM 5000K KNUCKLE , SPIKE INCL. 45° COB WITH ALUM REFL.	40
LF12-6W-RGBW-KN	6W 450LM RGB + 3000K KNUCKLE , SPIKE INCL. 45° COB WITH ALUM REFL. NEEDS RGBW CONTROLLER SEE PAGE 158.	40



WEATHERPROOF LED SQUARE FLOOD HEADS, 120V

Dark Bronze & White



120V



CATALOG NO.	DESCRIPTION	PKG. QTY.
FLH-10W-30K-BR	10W 1000LM 3000K Bronze	12
FLH-10W-50K-BR	10W 1000LM 5000K Bronze	12
FLH-10W-30K-WH	10W 1000LM 3000K White	12
FLH-10W-50K-WH	10W 1000LM 5000K White	12

WEATHERPROOF LED ROUND FLOOD HEADS, 120V

Dark Bronze & White



120V



CATALOG NO.	DESCRIPTION	PKG. QTY.
FLS-10W-30K-BR	10W 950LM 3000K BRONZE 100°	12
FLS-10W-50K-BR	10W 950LM 5000K BRONZE 100°	12
FLS-10W-30K-WH	10W 950LM 3000K WHITE 100°	12
FLS-10W-50K-WH	10W 950LM 5000K WHITE 100°	12

LED WORK LIGHT S-HOOK, USB CABLE & ADAPTOR INCL.



CATALOG NO.	DESCRIPTION
WL-EZCG-10W-50K	10W 300-600LM 5000K
WL-EZCG-SOLP	Solar panel 10 ft. cord & magnetic base



3IN1 LED WORK LIGHT(WORK LIGHT/SOS LIGHT/POWER BANK) USB CABLE INCL.

CATALOG NO.	DESCRIPTION
WL-3IN1-10W	10W 400LM 6000K



Retail Packaging - MOQ 1 Master Carton of 10



SPEC SERIES SOLAR SIGN AND BILLBOARD LIGHTS



CATALOG NO.	DESCRIPTION	PKG. QTY.
SOLS-1FT-MCT	5W 500LM 3000K/6000K 1FT	18
SOLS-2FT-60K	10W 1000LM 6000K 2FT	9
SOLS-4FT-60K	20W 2000LM 6000K 4FT	4

LED OUTDOOR SIGN LIGHTS WITH 1/2" ADJUSTABLE KNUCKLES, 120-277V



CATALOG NO.	DESCRIPTION	REPLACEMENT RANGE	PKG. QTY.
LOHB-2FT-50W-30K	50W 6500LM 3000K	150-250MH	4
LOHB-2FT-50W-50K	50W 6700LM 5000K	150-250MH	4
LOHB-4FT-120W-30K	120W 15300LM 3000K	200-400MH	1
LOHB-4FT-120W-50K	120W 15600LM 5000K	200-400MH	1
LOHB-4FT-120W-30K-WH	120W 15300LM 3000K	200-400MH White	1
LOHB-4FT-120W-50K-WH	120W 15600LM 5000K	200-400MH White	1



LOHB-C
Surface/Ceiling Mounting conversion Bracket w/screw holes in base, (set of 2)



LOHB-H-2FT
2Ft. Surface Mounting conversion yoke, Steel
(Also need LOHB-G)



LOHB-G
Side by side fixture coupling
Also used with LOHB-G Surf. Mt. Bracket (set of 2)



**BUILDER SERIES POWER & COLOR-TEMP. SELECTABLE
DUSK-TO-DAWN BARN/AREA LIGHT, 120-277V (Photocell & Arm Incl.)**



CATALOG NO.	DESCRIPTION	PKG. QTY.
LRX-36-60W-MCTP-P	36W/42W/60W 130LM/W 3000K/4000K/5000K	4
LRX-72-120W-MCTP-TL	72W/96W/120W 130LM/W 3000K/4000K/5000K	4

**SPEC SERIES POWER & CCT DUSK-TO-DAWN BARN/AREA LIGHT
120-277V (NEMA Photocell & Arm Incl.)**



CATALOG NO.	DESCRIPTION	PKG. QTY.
LRX-20-50W-MCTP	20W/30W/40W/50W 130LM/W 30K/40K/50K/57K	2
LRX-50-120W-MCTP	50W/80W/100W/120W 130LM/W 30K/40K/50K/57K	1

**DUSK-TO-DAWN AREA LIGHT
WITH NEMA TWIST-LOCK PHOTOCELL, 120-277V (Arm & Mounting Strap Incl.)**



CATALOG NO.	DESCRIPTION	PKG. QTY.
LR2-50NW-P	50W 5050LM 4000K 103° 100-175 MH	2

LED DUSK-TO-DAWN BARN LIGHTS WITH PHOTOCELL (Arm Optional)



CATALOG NO.	DESCRIPTION	REPLACEMENT RANGE	PKG. QTY.
LR-ECO-20W-30K-P	20W 2400LM 3000K	70-100MH	1
LR-ECO-ARM	90° Arm for LR-ECO Series,(Mounting Strap Incl.)		-

HIGH-OUTPUT DUAL-SELECTABLE VAPOR-TIGHT WITH ADJ. ANGLE



CATALOG NO.	DESCRIPTION	PKG. QTY.
VTA-15-30W-MCTP	15W/20W/30W 110LM/W 30K/40K/50K	6

LED UNIVERSAL VAPOR LIGHTS, (ALL MOUNTING OPTIONS IN ONE BOX) 120-277V, IP65 NEMA 3R



CATALOG NO.	DESCRIPTION	PKG. QTY.
VTU-12W-30K	12W 840LM 3000K	2
VTU-12W-50K	12W 900LM 5000K	2
VTU-20W-30K	20W 1685LM 3000K	2
VTU-20W-50K	20W 1785LM 5000K	2

FACTORY-INSTALLED OPTIONS, ENTER DESIRED OPTION CODE(S) AS LINE ITEMS ON YOUR PURCHASE ORDER UNDER THE PRODUCT CATALOG NUMBER

WATTS	EM OPTION	DESCRIPTION	PHOTOCELL DESCRIPTION	PAINT	SENSOR	DESCRIPTION
ALL	OPT-EM-VTU	INTERNAL	OPT-PC-B BUTTON	OPT-CLR-85(BK/GR/SR/WH)	OPT-SEN-3MRLV-5 WEC-BRC	PROGRAMMABLE MICROWAVE BI-LEVEL REMOTE CONTROL

OUTDOOR
PATH
LIGHTS



GPX-18-60W-MCTP-A1 Single Arm for 2-3/8" Poles "POLE IS NOT INCL."
 GPX-18-60W-MCTP-A2 Twin Arm for 2-3/8" Poles "POLE IS NOT INCL."
 GPX-18-60W-MCTP-PWM Pole/Wall Mount
 GPX-18-60W-MCTP-SF Slip fitter for 2-3/8" Poles "POLE IS NOT INCL."
 GPX-18-60W-MCTP-BM Bell Mount for 2-3/8" Poles "POLE IS NOT INCL."
 GPX-18-60W-MCTP-CM Ceiling Mount
 GPX-18-60W-MCTP-PM75 Pipe Mount with 3/4" Hub "STEM IS NOT INCL."
 GPX-18-60W-MCTP-CAT Catenary Suspension Mount "SUSP. CABLE IS NOT INCL."

SPEC SERIES POWER & CCT- ADJUSTABLE AREA/FLOOD LIGHT Bronze Finish
 120-277V, TYPE 5 LENS (TYPE 2 & TYPE 3 LENS ALSO AVAILABLE) 7 DAYS LEAD TIME



	DESCRIPTION	MOUNTING	PKG. QTY.
GPX-18-60W-MCTP-A1	18W/30W/45W/60W 150LM/W 30K/40K/50K	Single Arm for 2-3/8" Poles/Piles	1
GPX-18-60W-MCTP-A2	18W/30W/45W/60W 150LM/W 30K/40K/50K	Twin Arm for 2-3/8" Poles/Piles	1
GPX-18-60W-MCTP-PWM	18W/30W/45W/60W 150LM/W 30K/40K/50K	Pole/Wall Mount	1
GPX-18-60W-MCTP-SF	18W/30W/45W/60W 150LM/W 30K/40K/50K	Slip fitter for 2-3/8" Poles/Piles	1
GPX-18-60W-MCTP-BM	18W/30W/45W/60W 150LM/W 30K/40K/50K	Bell Mount for 2-3/8" Poles/Piles	1
GPX-18-60W-MCTP-CM	18W/30W/45W/60W 150LM/W 30K/40K/50K	Ceiling Mount	1
GPX-18-60W-MCTP-PM75	18W/30W/45W/60W 150LM/W 30K/40K/50K	Pipe Mount with 3/4" Hub	1
GPX-18-60W-MCTP-CAT	18W/30W/45W/60W 150LM/W 35K/40K/50K	Catenary Suspension Mount	1
GPX-22-75W-MCTP-A1	22W/37W/56W/75W 137LM/W 40K/50K	Single Arm for 2-3/8" Poles/Piles	1
GPX-22-75W-MCTP-A2	22W/37W/56W/75W 137LM/W 40K/50K	Twin Arm for 2-3/8" Poles/Piles	1
GPX-22-75W-MCTP-PWM	22W/37W/56W/75W 137LM/W 40K/50K	Pole/Wall Mount	1
GPX-22-75W-MCTP-SF	22W/37W/56W/75W 137LM/W 40K/50K	Slip fitter for 2-3/8" Poles/Piles	1
GPX-22-75W-MCTP-BM	22W/37W/56W/75W 137LM/W 40K/50K	Bell Mount for 2-3/8" Poles/Piles	1
GPX-22-75W-MCTP-CM	22W/37W/56W/75W 137LM/W 40K/50K	Ceiling Mount	1
GPX-22-75W-MCTP-PM75	22W/37W/56W/75W 137LM/W 40K/50K	Pipe Mount with 3/4" Hub	1
GPX-22-75W-MCTP-CAT	22W/37W/56W/75W 137LM/W 40K/50K	Catenary Suspension Mount	1

FACTORY-INSTALLED OPTIONS, ENTER DESIRED OPTION CODE(S) AS LINE ITEMS ON YOUR PURCHASE ORDER UNDER THE PRODUCT CATALOG NUMBER

WATTS	EM OPTION	DESCRIPTION	PHOTOCELL	DESCRIPTION	PAINT	SENSOR	DESCRIPTION
ALL	OPT-EM-GPX	INTERNAL	OPT-3MPC	ELECTRONIC	OPT-CLR-95(BK/GR/SR/WH)	OPT-SEN-3MR-3	BI-LEVEL MICROWAVE
	LENS OPTION	DESCRIPTION	480V OPTION	DESCRIPTION		WEC-8RC	REMOTE CONTROL
	OPT-GPX-LENS-TYPE2S	TYPE 2S	OPT-WP-480V	CHANGE VOLTAGE			
	OPT-GPX-LENS-TYPE3S	TYPE 3S					
	OPT-GPX-LENS-FL	FROSTED GLASS LENS					



GPE-30-60W-MCTP
GPE-60-100W-MCTP



GPE
Folds For Shipment



GPET-30-60W-MCTP
GPET-60-100W-MCTP
Pole is not Incl.

POWER & CCT- ADJUSTABLE GARDEN POST-TOP LIGHTS, 120-277V Bronze Finish



CATALOG NO.	DESCRIPTION	PKG. QTY.
POWER & CCT- ADJUSTABLE GARDEN POST-TOP LIGHTS, 120-277V (FITS ON 3" OD PIPES/POLES)		
GPE-40-60W-MCTP	40W/50W/60W 130LM/W 30K/40K/50K	
GPE-60-100W-MCTP	60W/80W/100W 130LM/W 30K/40K/50K	
GPE-30-25-REDUCER	GPE Neck Reducer from 3" Inner Diameter to 2.5"	
POWER & CCT- ADJUSTABLE GARDEN POST-TOP LIGHTS, 120-277V, (FITS ON 2-3/8" OD PIPES/POLES) 7 DAYS LEAD TIME		
GPET-30-60W-MCTP	30W/50W/60W 130LM/W 30K/40K/50K	
GPET-60-100W-MCTP	60W/80W/100W 130LM/W 30K/40K/50K	

FACTORY-INSTALLED OPTIONS, ENTER DESIRED OPTION CODE(S) AS LINE ITEMS ON YOUR PURCHASE ORDER UNDER THE PRODUCT CATALOG NUMBER

WATTS	EM OPTION	DESCRIPTION	PHOTOCELL	DESCRIPTION	PAINT	SENSOR	DESCRIPTION
GPE	OPT-EM-GPE	INTERNAL	OPT-3MPC	ELECTRONIC	OPT-CLR-95(BK/GR/SR/WH)	OPT-SEN-3MR-3	BI-LEVEL MICROWAVE
GPET	OPT-EM-GPET	INTERNAL				WEC-8RC	REMOTE CONTROL



SPEC SERIES 17" MODERN LUCITE POST TOP, POWER & CCT- ADJUSTABLE



CATALOG NO.	DESCRIPTION	PKG. QTY.
GPL-18-60W-MCTP	18W/30W/45W/60W 140LM/W 30K/40K/50K	1

FOR FACTORY OPTION SEE GPC BELOW
FACTORY-INSTALLED OPTIONS, ENTER DESIRED OPTION CODE(S) AS LINE ITEMS ON YOUR PURCHASE ORDER UNDER THE PRODUCT CATALOG NUMBER

WATTS	EM OPTION	DESCRIPTION	PHOTOCELL	DESCRIPTION	PAINT	SENSOR	DESCRIPTION
ALL	OPT-EM-GPL	INTERNAL	OPT-LF3-PCK	BUTTON	N/A	OPT-SEN-3MRLV-5	PROGRAMMABLE MICROWAVE BI-LEVEL

SPEC SERIES 24" X 14" SQ COACH POST TOP, POWER & CCT- ADJUSTABLE

(FITS ON 3" OD PIPES/POLES) Black Finish



CATALOG NO.	DESCRIPTION	PKG. QTY.
GPC-60-100W-MCTP	60W/80W/100W 90LM/W 3000K/4000K/5000K (Open Design)	1
GPC-SH	GPC House-Side Glare Shield	



Shown With Frosted Lens

FACTORY-INSTALLED OPTIONS, ENTER DESIRED OPTION CODE(S) AS LINE ITEMS ON YOUR PURCHASE ORDER UNDER THE PRODUCT CATALOG NUMBER

WATTS	EM OPTION	DESCRIPTION	PHOTOCELL	DESCRIPTION	PAINT	SENSOR	DESCRIPTION
ALL	OPT-EM-GPC	INTERNAL	OPT-LF3-PCK	BUTTON	N/A	OPT-SEN-3MRLV-5	PROGRAMMABLE MICROWAVE BI-LEVEL
	OPT-GPC-GSF	4 SIDE	OPT-GPC-PCLF	FROSTED		WEC-8RC	REMOTE CONTROL
	OPT-GPC-GBF	BOTTOM ONLY	OPT-GPC-PCLC	CLEAR			



DESIGNER AREA BELL LIGHT SYSTEM (PHOTOCELL DISCONNECT SWITCH)



CATALOG NO.	DESCRIPTION	PKG. QTY.
DAB-A16-50-100W-MCTP-SR	50W/80W/100W 130LM/W 30K/40K/50K 16"	1
DAB-B20-50-100W-MCTP-SR	50W/80W/100W 130LM/W 30K/40K/50K 20"	1
DAB-B23-80-150W-MCTP-SR	80W/100W/150W 130LM/W 30K/40K/50K 23" 3 MONTHS LEAD TIME	1
DAB-BA	DAB Bell Arm For Mounting On Single Or Double Pole Adapters, Black	
DAB-PB-B	DAB Decorative Straight Pole Bracket Model B, For Flat Or Round Poles, Black	
DAB-WB-A	DAB Straight Wall Bracket Model A, Black	
DAB-PA2-1	DAB 2In Pole Adapter For 1 Bell Arm, Black	
DAB-PA2-2	DAB 2In Pole Adapter For 2 Bell Arms, Black	
DAB-PA3-1	DAB 3In Pole Adapter For 1 Bell Arm, Black	
DAB-PA3-2	DAB 3In Pole Adapter For 2 Bell Arms, Black	
DAB-PA4-1	DAB 4In Pole Adapter For 1 Bell Arm, Black	
DAB-PA4-2	DAB 4In Pole Adapter For 2 Bell Arms, Black	
DAB-WB-C	DAB Bent Decorative Wall Bracket Model C, Black	

FACTORY-INSTALLED OPTIONS, ENTER DESIRED OPTION CODE(S) AS LINE ITEMS ON YOUR PURCHASE ORDER UNDER THE PRODUCT CATALOG NUMBER

WATTS	EM OPTION	DESCRIPTION	PHOTOCELL	DESCRIPTION	PAINT	SENSOR	DESCRIPTION
ALL	OPT-EM-DAB	INTERNAL	OPT-LF3-PCK	BUTTON	N/A	OPT-SEN-3MRLV-5	PROGRAMMABLE MICROWAVE BI-LEVEL

OUTDOOR
PEDESTRIAN LIGHTS



PML-S-MCT-ORB
Oil-Rubbed Bronze



PML-M-MCT-ORB
Oil-Rubbed Bronze

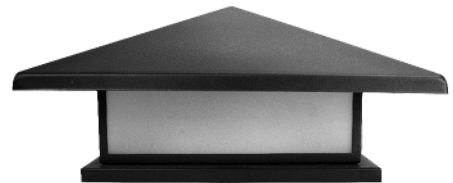

PML-L-MCT-ORB
Oil-Rubbed Bronze



Shown with optional Honey Color Glass Lens (Field-installed)



PML-R-MCT-BR
Bronze



PML-V-MCT-ORB
Oil-Rubbed Bronze



PML-MCT-BK
Black



PML-BASE-BK
Black

SELECTABLE CCT PIER-MOUNT LIGHTS, 120-277V



CATALOG NO.	DESCRIPTION	PKG. QTY.
SELECTABLE CCT PIER-MOUNT LIGHTS, 120-277V		
PML-S-MCT-ORB	12W 345LM 30K/40K/50K Oil-Rubbed Bronze, 8"W	6
PML-M-MCT-ORB	15W 430LM 30K/40K/50K Oil-Rubbed Bronze, 12"W	4
PML-L-MCT-ORB	18W 460LM 30K/40K/50K Oil-Rubbed Bronze, 16"W	4
PML-S-HGLK	PML-S Honey Color Glass Replacement Lens Kit	
PML-M-HGLK	PML-M Honey Color Glass Replacement Lens Kit	
PML-L-HGLK	PML-L Honey Color Glass Replacement Lens Kit	
SELECTABLE CCT PIER-MOUNT LIGHTS, 120-277V		
PML-R-MCT-BR	12W 840LM 30K/40K/50K Bronze, 9"Dia	4
SELECTABLE CCT PIER-MOUNT LIGHTS, 120-277V		
PML-V-MCT-ORB	12W 1500LM 30K/40K/50K	
SELECTABLE CCT PIER-MOUNT LIGHTS, 120-277V		
PML-MCT-BK	12W 1200LM 3000K/4000K/5000K Black	
PML-BASE-BK	Decorative Pier Mount Base For Post Top Lights - Black	



MODERN TOP-HAT POST-TOP AREA LIGHT WITH INDIRECT LIGHT SOURCE, CCT & WATTAGE SELECT

CATALOG NO.	DESCRIPTION	PKG. QTY.
GPH-12-40W-MCTP-BK	12W/20W/30W/40W 100LM/W 30K/40K/50K 22" Dia X 20" H	1
GPH-12-40W-MCTP-BR	12W/20W/30W/40W 100LM/W 30K/40K/50K 22" Dia X 20" H	1
GPH-12-40W-MCTP-GY	12W/20W/30W/40W 100LM/W 30K/40K/50K 22" Dia X 20" H	1



FACTORY-INSTALLED OPTIONS, ENTER DESIRED OPTION CODE(S) AS LINE ITEMS ON YOUR PURCHASE ORDER UNDER THE PRODUCT CATALOG NUMBER

WATTS	3IN POLE ENTRY OPTION	DESCRIPTION	PHOTOCELL	DESCRIPTION	PAINT	SENSOR	DESCRIPTION
ALL MODELS	OPT-GPH-3IN-BK	3IN POLE ENTRY Black		N/A	N/A	N/A	N/A
	OPT-GPH-3IN-BR	3IN POLE ENTRY Bronze					
	OPT-GPH-3IN-GY	3IN POLE ENTRY Gray					



Standard(s) for Safety: ANSI/UL 844, "Luminaires for Use in Hazardous (Classified) Locations."

Shown with Flat Wire Guard

Shown with DomeGlass & Dome Wire Guard

Shown with U Shape Lens & Wireguard



HAZARDOUS LOCATION FLOOD/HIGHBAY LIGHTS, CLASS 1, DIV. 2

	CATALOG NO.	DESCRIPTION	PKG. QTY.
120-277V	HAZARDOUS LOCATION FLOOD/HIGHBAY LIGHTS, 120-277V CLASS 1, DIV. 2		
	EXPF-30W-60K	30W 3450LM 6000K	1
	EXPF-30W-50K	30W 4200LM 5000K	1
	EXPF-60W-50K	60W 8400LM 5000K	1
	EXPF-100W-50K	100W 14000LM 5000K	1
	EXPF-180W-60K	180W 20700LM 6000K	1
	EXPF-240W-50K	150W 21000LM 5000K	1
	LF-AD-SF-GY	Slips Onto Pole Top 2" Dim. Fixture Mounts Directly On The Side Or	-
	ROUND HAZARDOUS LOCATION FLOOD/HIGHBAY LIGHTS, 120-277V CLASS 1, DIV. 2		
	EXPR-30W-50K	30W 146 LM/W 5000K	2
EXPR-60W-50K	60W 143 LM/W 5000K	2	
EXPR-100W-50K	100W 153 LM/W 5000K	1	
EXPR-150W-50K	150W 155 LM/W 5000K	1	
EXPR-30-60W-WGF	Flat Wire Guard For EXPR 30W To 60W		
EXPR-100-150W-WGF	Flat Wire Guard For EXPR 100W To 150W		
EXPR-30-60W-LD	Dome Lens For EXPR 30W To 60W		
EXPR-100-150W-LD	Dome Lens For EXPR 100W To 150W		
EXPR-30-60W-WGD	Dome Wire Guard For EXPR 30W To 60W		
EXPR-100-150W-WGD	Dome Wire Guard For EXPR 100W To 150W		
EXPR-30-60W-LU	U- shape Jelly-Jar Lens For EXPR 30W To 60W		
EXPR-30-60W-WGU	U- shape Jelly-Jar Wire Guard For EXPR 30W To 60W		
480V 120-277V	HAZARDOUS LOCATION FLOOD/HIGHBAY LIGHTS, 120-277V CLASS 1, DIV. 2		
	EXPL-40W-50K	40W 135 LM/W 5000K	1
	EXPL-80W-50K	80W 135 LM/W 5000K	1
	EXPL-120W-50K	120W 130 LM/W 5000K	1
	HAZARDOUS LOCATION ROUND FLOOD/HIGHBAY LIGHTS, 480V CLASS 1, DIV. 2		
	EXPR-150W-50K-480V	150W 150 LM/W 5000K	1
	HAZARDOUS LOCATION LINEAR FLOOD/HIGHBAY LIGHTS, 480V CLASS 1, DIV. 2		
	EXPL-80W-50K-480V	80W 135 LM/W 5000K	1

GENERATION 7 STADIUM LIGHTS, 120-277V OR 277-480V



CATALOG NO.	DESCRIPTION	PKG. QTY.
GENERATION 7 STADIUM LIGHTS, 120-277V		
SFX-G7-200-500W-45D-50K	200W/300W/400W/500W 150LM/W 5000K	1
SFX-G7-700-1000W-45D-50K	700W/800W/900W/1000W 150LM/W 5000K	1
GENERATION 7 STADIUM LIGHTS, 277-480V		
SFX-G7-200-500W-45D-50K-480V	200W/300W/400W/500W 150LM/W 5000K	1
SFX-G7-700-1000W-45D-50K-480V	700W/800W/900W/1000W 150LM/W 5000K	1
SFX-G7-1400-1700W-45D-50K-480V	1400W/1500W/1600W/1700W 150LM/W 5000K	1
SFX-G7-2100-2400W-45D-50K-480V	2100/2200/2300/2400W 140LM/W 5000K	1
SFX-G7-SF	Slip Fitter/Pole Adapter For SFX-G7	

SPEC SERIES NEW GEN. LED STADIUM FLOOD LIGHTS - ALSO SUITABLE FOR BUILDING FACADES



CATALOG NO.	DESCRIPTION	PKG. QTY.
SFX-G9-600W-30D-50K	600W 150LM/W 5000K	1
SFX-G9-SH1	Shroud for 600W	
SFX-POINTER	LED Laser Aiming Device	



SHOWN WITH OPTIONAL SLIP FITTER



SHOWN WITH OPTIONAL SHROUD

SPEC SERIES X GEN. RGB STADIUM LIGHTS, DMX512 CONTROLLED - SPECIAL ORDER



CATALOG NO.	DESCRIPTION	PKG. QTY.
SFX-G9-500W-45D-RGB	500W RGB	1
SFX-G9-800W-45D-RGB	800W RGB	1

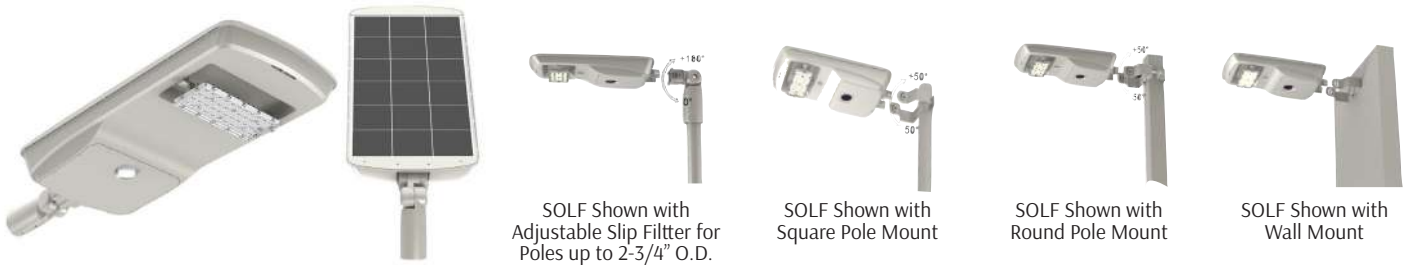

SOLF Shown with Adjustable Slip Filter for Poles up to 2-3/4" O.D.

SOLF Shown with Square Pole Mount

SOLF Shown with Round Pole Mount

SOLF Shown with Wall Mount

LED SOLAR ROADWAY/FLOOD LIGHTS **PROGRAMMABLE- Default Settings**
15 second after the zone is cleared the light goes down to 40%
NO WIRING, INCL. INTELLIGENT CONTROLS, 1 DAY CHARGE 3 DAY OPR., LiFePo4 5YR. BATTERY



CATALOG NO.	DESCRIPTION	PKG. QTY.
SOLF-17W-50K	8W LED 200LM/W LED 17W 1600LM 5000K	1
SOLF-36W-50K	20W LED 200LM/W LED 36W 4000LM 5000K	1
SOLF-54W-50K	30W LED 200LM/W LED 54W 6000LM 5000K	1
SOLF-SFA	Adjustable Slip Filter for Poles up to 2-3/4" O.D.	-
SOLF-WM-17W	Wall Mount for SOLF-17W	-
SOLF-WM-36W/54W	Wall Mount for SOLF-36W & 54W	-
SOLF-PMR-17W	Round Pole Mount for SOLF-17W	-
SOLF-PMR-36W/54W	Round Pole Mount for SOLF-36W & 54W	-
SOLF-PMS-17W	Square Pole Mount for SOLF-17W	-
SOLF-PMS-36W/54W	Square Pole Mount for SOLF-36W & 54W	-
SOLF-RC	Remote Control for SOLF Series	-



Shown with Pole/Wall Mount Arm, Sold Separately



Shown with Pole-Top Mount (2" Poles), Sold Separately

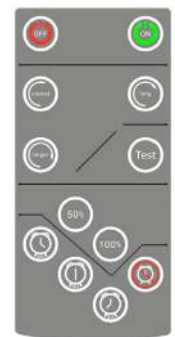

SOLA-RC

ROADWAY AND AREA SPLIT SOLAR LIGHTS, WITH ADVANCED CONTROLLER
REMOTE SOLAR PANEL INCL. WITH FIXTURE (WALL & POLE MOUNTING OPTIONS AVAIL. SOLD SEPARATELY)



CATALOG NO.	DESCRIPTION	PKG. QTY.
SOLA-SPLT-15W-50K	15W 2250LM 5000K	1
SOLA-SPLT-30W-50K	30W 4500LM 5000K	1
SOLA-SPLT-PM	Pole Mounting Arm For Split Solar Lights	-
SOLA-SPLT-WM	Wall Mounting Arm For Split Solar Lights	-
SOLA-RC	Sola Solar Light Remote Control Unit - One Per Project	-



SOLA-5W-50K-WA
20" Pole/Wall Mount Arm Included

Shown Back Side



SOLA-RC

ROADWAY AND AREA SOLAR LIGHTS, WITH ADVANCED CONTROLLER
INTEGRATED SOLAR PANEL, 20" WALL/POLE MOUNT ARM INCL.



CATALOG NO.	DESCRIPTION	PKG. QTY.
SOLA-5W-50K-WA	5W 750LM 5000K	1
SOLA-RC	Sola Solar Light Remote Control Unit - One Per Project	



AVAIL. IN 3000K



SOLN Shown with **SOLN-PMRS** Round & Square Pole Mounting Accessory



SOLN Shown with **SOLN-SFA** Slip Fitter Mounting Accessory

SOLN Shown with **SOLN-WM** Wall Mounting Arm

POWERFUL HIGH-LUMEN SMART INTEGRATED SOLAR STREET AND FLOOD LIGHT



CATALOG NO.	DESCRIPTION	ARRIVES THIS SEASON CHECK & PRE-ORDER	PKG. QTY.
SOLN-30W-50K	30W 6000LM 3000K		1
SOLN-30W-30K	30W 6000LM 5000K		1
SOLN-50W-50K	50W 10000LM 3000K		1
SOLN-50W-30K	50W 10000LM 5000K		1
SOLN-70W-50K	70W 14000LM 3000K		1
SOLN-70W-30K	70W 14000LM 5000K		1
SOLN-WM-15-30W	SOLN 15-30W Wall Mounting Accessory		
SOLN-WM-50-70W	SOLN 50-70W Wall Mounting Accessory		
SOLN-SFA	SOLN Series Slip Fitter Mounting Accessory		
SOLN-PMRS-15-30W	SOLN 15-30W Round And Square Pole Mounting Accessory		
SOLN-PMRS-50-70W	SOLN 50-70W Round And Square Pole Mounting Accessory		
SOLF-RC	Remote Control for SOLN Series (One Per Project)		



STL4 Shown with Slip Fitter



STL4 Shown with Half Shroud (Reversible)



STL4 Shown with Full Shroud

LED STREET/ROADWAY LIGHTS

w/NEMA TWIST-LOCK PHOTOCELL SOCKET, (SHORTING CAP INCL.) FOR PHOTOCELL SEE PAGE 56



CATALOG NO.	DESCRIPTION	PKG. QTY.
STL4-15-50W-30K	15W/20W/30W/50W 145LM/W 3000K	1
STL4-15-50W-50K	15W/20W/30W/50W 145LM/W 5000K	1
STL4-30-100W-30K	30W/50W/80W/100W 145LM/W 3000K	1
STL4-30-100W-50K	30W/50W/80W/100W 145LM/W 5000K	1
STL4-50-150W-30K	50W/80W/100W/150W 140LM/W 3000K	1
STL4-50-150W-50K	50W/80W/100W/150W 140LM/W 5000K	1
STL4-80-200W-30K	80W/100W/150W/200W 140LM/W 3000K	1
STL4-80-200W-50K	80W/100W/150W/200W 140LM/W 5000K	1
STL4-30-100W-30K-480V	30W/50W/80W/100W 140LM/W 3000K	1
STL4-30-100W-50K-480V	30W/50W/80W/100W 140LM/W 5000K	1
STL4-50-150W-30K-480V	50W/80W/100W/150W 140LM/W 3000K	1
STL4-50-150W-50K-480V	50W/80W/100W/150W 140LM/W 5000K	1
STL4-80-200W-30K-480V	80W/100W/150W/200W 140LM/W 3000K	1
STL4-80-200W-50K-480V	80W/100W/150W/200W 140LM/W 5000K	1

STL4-SF

STL4 Series Street Light Slip Fitter



STL3 Shown with Wall Mounting Arm - 12-3/4" Length for 50W & above



STL3 Shown with Half Shroud (Reversible)



STL3 Shown with Full Shroud

LED STREET/ROADWAY LIGHTS

w/NEMA TWIST-LOCK PHOTOCELL SOCKET, (SHORTING CAP INCL.) FOR PHOTOCELL SEE PAGE 56



CATALOG NO.	DESCRIPTION	REPLACEMENT RANGE	PKG. QTY.
STL2-30W-30K	30W 3900LM 3000K	100-277V WHILE SUPPLIES LAST	5
STL2-30W-50K	30W 3900LM 5000K	100-277V WHILE SUPPLIES LAST	5
STL3-50W-50K	50W 6750LM 5000K	100-277V	1
STL3-50W-30K-L	50W 6750LM 3000K 18.2"(L) x 9"(W) x 4.5"(H)	100-277V WHILE SUPPLIES LAST	1
STL3-50W-50K-L	50W 6750LM 5000K 18.2"(L) x 9"(W) x 4.5"(H)	100-277V	1
STL2-80W-30K	80W 10800LM 3000K	100-277V WHILE SUPPLIES LAST	1
STL2-80W-50K	80W 10800LM 5000K	100-277V WHILE SUPPLIES LAST	1
STL2-100W-30K	100W 13500LM 3000K	100-277V	1
STL3-100W-50K	100W 13500LM 5000K	100-277V	1
STL2-150W-30K	150W 21000LM 3000K	100-277V WHILE SUPPLIES LAST	1
STL3-150W-50K	150W 21000LM 5000K	100-277V	1
STL3-200W-30K	200W 27000LM 3000K	100-277V	1
STL3-200W-50K	200W 27000LM 5000K	100-277V	1
STL3-90W-50K-480V	90W 13500LM 5000K	277-480V	1
STL3-150W-50K-480V	150W 21000LM 5000K	277-480V	1
STL3-200W-50K-480V	200W 27000LM 5000K	277-480V	1
STL2-WMA	Wall Mounting Arm - 12-3/4" Length for 50W & above	-	-

FACTORY-INSTALLED OPTIONS, ENTER DESIRED OPTION CODE(S) AS LINE ITEMS ON YOUR PURCHASE ORDER UNDER THE PRODUCT CATALOG NUMBER

WATTS	SHROUD	DESCRIPTION	PHOTOCELL	DESCRIPTION	PAINT	SENSOR	DESCRIPTION
ALL MODEL	OPT-STL-SH-CW OPT-STL-SH-FG	HALF SHROUD FULL SHROUD		N/A	N/A	N/A	N/A



SPEC SERIES LED ADJUSTABLE CANOPY/PARKING LIGHTS, 120-277V

Bronze & White



OUTDOOR
CANOPY &
GARAGE

CATALOG NO.	DESCRIPTION						PKG. QTY.
SPEC SERIES LED ADJUSTABLE CANOPY/PARKING LIGHTS, 120-277V							
CDX-35W-35K-BR	35W	4600LM	3500K	Bronze	10.6" (L) x 10.6" (W) x 4-1/2" (H)		2
CDX-35W-35K-WH	35W	4600LM	3500K	White	10.6" (L) x 10.6" (W) x 4-1/2" (H)		2
CDX-35W-40K-BR	35W	4600LM	4000K	Bronze	10.6" (L) x 10.6" (W) x 4-1/2" (H)		2
CDX-35W-40K-WH	35W	4600LM	4000K	White	10.6" (L) x 10.6" (W) x 4-1/2" (H)		2
CDX-35W-50K-BR	35W	4600LM	5000K	Bronze	10.6" (L) x 10.6" (W) x 4-1/2" (H)		2
CDX-35W-50K-WH	35W	4600LM	5000K	White	10.6" (L) x 10.6" (W) x 4-1/2" (H)		2
CDX-55W-35K-BR	55W	7250LM	3500K	Bronze	10.6" (L) x 10.6" (W) x 4-1/2" (H)		2
CDX-55W-35K-WH	55W	7250LM	3500K	White	10.6" (L) x 10.6" (W) x 4-1/2" (H)		2
CDX-55W-40K-BR	55W	7250LM	4000K	Bronze	10.6" (L) x 10.6" (W) x 4-1/2" (H)		2
CDX-55W-40K-WH	55W	7250LM	4000K	White	10.6" (L) x 10.6" (W) x 4-1/2" (H)		2
CDX-55W-50K-BR	55W	7250LM	5000K	Bronze	10.6" (L) x 10.6" (W) x 4-1/2" (H)		2
CDX-55W-50K-WH	55W	7250LM	5000K	White	10.6" (L) x 10.6" (W) x 4-1/2" (H)		2
SPEC SERIES POWER & CCT- ADJUSTABLE LED ADJUSTABLE CANOPY/PARKING LIGHTS, 120-277V							
CDX-35-55W-MCTP-BR	35W/45W/55W	120LM/W	30K/40K/50K				
CDX-35-55W-MCTP-WH	35W/45W/55W	120LM/W	30K/40K/50K				

FACTORY-INSTALLED OPTIONS, ENTER DESIRED OPTION CODE(S) AS LINE ITEMS ON YOUR PURCHASE ORDER UNDER THE PRODUCT CATALOG NUMBER

WATTS	EM OPTION	DESCRIPTION	PHOTOCELL DESCRIPTION	PAINT	SENSOR	DESCRIPTION	
35W	OPT-EM-CDX-35	INTERNAL	OPT-PC-B BUTTON	OPT-CLR-95(BK/GR/SR/WH)	OPT-SEN-2MDR-36	PROGRAMMABLE MICROWAVE BI-LEVEL	
55W	OPT-EM-CDX-55	INTERNAL				WEC-3RC	OPTIONAL REMOTE CONTROL
	VANDAL RES.	DESCRIPTION					
	OPT-TRS-T20	Tamper Resistant Screw					



POWER-ADJUSTABLE CANOPY LIGHT, 120-277V (WET LOCATION)

Dark Bronze



CATALOG NO.	DESCRIPTION						PKG. QTY.
CDLX-SM-5-25W-30K	5W/10W/15W/25W	120LM/W	3000K	8"X8"X3"			6
CDLX-SM-5-25W-40K	5W/10W/15W/25W	120LM/W	4000K	8"X8"X3"			6
CDLX-SM-5-25W-50K	5W/10W/15W/25W	120LM/W	5000K	8"X8"X3"			6
CDLX-MD-15-45W-30K	15W/25W/35W/45W	120LM/W	3000K	10"X10"X3.63"			4
CDLX-MD-15-45W-40K	15W/25W/35W/45W	120LM/W	4000K	10"X10"X3.63"			4
CDLX-MD-15-45W-50K	15W/25W/35W/45W	120LM/W	5000K	10"X10"X3.63"			4
CDLX-LG-30-80W-30K	30W/40W/60W/80W	120LM/W	3000K	14"X14"X4"			2
CDLX-LG-30-80W-40K	30W/40W/60W/80W	120LM/W	4000K	14"X14"X4"			2
CDLX-LG-30-80W-50K	30W/40W/60W/80W	120LM/W	5000K	14"X14"X4"			2

FACTORY-INSTALLED OPTIONS, ENTER DESIRED OPTION CODE(S) AS LINE ITEMS ON YOUR PURCHASE ORDER UNDER THE PRODUCT CATALOG NUMBER

SIZE	EM OPTION	DESCRIPTION	PHOTOCELL DESCRIPTION	PAINT	SENSOR	DESCRIPTION	
SM	OPT-EM-CDLX-SM	INTERNAL	OPT-PC-B BUTTON	OPT-CLR-95(BK/GR/SR/WH)	OPT-SEN-2MD-35	PROGRAMMABLE MICROWAVE BI-LEVEL	
MD	OPT-EM-CDLX-MD	INTERNAL				WEC-3RC	OPTIONAL REMOTE CONTROL
LG	OPT-EM-CDLX-LG	INTERNAL					
	VANDAL RES.	DESCRIPTION					
	OPT-TRS-T20	Tamper Resistant Screw					



Sensor-Ready
Plug & Play For CAX

ANGLED-BEAM GARAGE CANOPY, CCT AND WATTAGE SELECTABLE, SENSOR READY

CATALOG NO.	DESCRIPTION	PKG. QTY.
CAX-20-45W-MCTP-SR	20W/30W/45W 140LM/W 30K/40K/50K	8
CAX-30-60W-MCTP-SR	30W/45W/60W 140LM/W 30K/40K/50K	8
CAX-40-75W-MCTP-SR	40W/60W/75W 140LM/W 30K/40K/50K	8
CAX-60-90W-MCTP-SR	60W/75W/90W 140LM/W 30K/40K/50K	8
WEC-3MR-72-TLB-BK	600W Max, Zhaga 12-24VDC Microwave Sensor, Black, With Base (Optional Remote Control WEC-3RC)	
WEC-3MBT-72-TLB-BK	600W Max, Zhaga 12-24VDC Microwave Sensor, Bluetooth App Ready, Black, With Base (Optional Remote Control WEC-3RC)	
WEC-3PR-72-TLB-WH	600W Max, Zhaga 12-24VDC PIR Sensor, White, With Base (Optional Remote Control WEC-3RC)	

FACTORY-INSTALLED OPTIONS, ENTER DESIRED OPTION CODE(S) AS LINE ITEMS ON YOUR PURCHASE ORDER UNDER THE PRODUCT CATALOG NUMBER

WATTS	EM OPTION	DESCRIPTION	PHOTOCELL DESCRIPTION	PAINT	SENSOR	DESCRIPTION
45W & 60W	OPT-EM-CAX-40-60	INTERNAL	OPT-PC-B BUTTON	OPT-CLR-95(BK/GR/SR/WH)	OPT-SEN-2MDR-36	PROGRAMMABLE MICROWAVE BI-LEVEL
75W & 90W	OPT-EM-CAX-75-90	INTERNAL				
	VANDAL RES. OPT-TRS-T20	DESCRIPTION Tamper Resistant Screw				
					WEC-3RC	OPTIONAL REMOTE CONTROL



OPTIONAL FROSTED LENS, FIELD REPLACE

LED GARAGE/CANOPY LIGHTS, 120-277V (WET LOCATION)



CATALOG NO.	DESCRIPTION	REPLACEMENT RANGE	PKG. QTY.
CGL-40W-50K-D	40W 5200LM 5000K 9" (L) x 9" (W) x 4-1/2" (H) 100-150 MH		4
CGL-40W-40K-D	40W 5200LM 4000K 9" (L) x 9" (W) x 4-1/2" (H) 100-150 MH		4
CGL-55W-50K-D	55W 7100LM 5000K 9" (L) x 9" (W) x 4-1/2" (H) 150-200 MH		4
CGL-55W-40K-D	55W 7100LM 4000K 9" (L) x 9" (W) x 4-1/2" (H) 150-200 MH		4
CGL-75W-50K-D	75W 9700LM 5000K 10" (L) x 10" (W) x 5" (H) 250-320 MH		2
CGL-75W-40K-D	75W 9700LM 4000K 10" (L) x 10" (W) x 5" (H) 250-320 MH		2
CGL-100W-50K-D	100W 13000LM 5000K 10" (L) x 10" (W) x 5" (H) 350-400 MH		2
CGL-100W-40K-D	100W 13000LM 4000K 10" (L) x 10" (W) x 5" (H) 350-400 MH		2
CGL-FL1	Frosted Replacement Lens for CGL-40W & 55W		
CGL-FL2	Frosted Replacement Lens for CGL-75W & 100W		

FACTORY-INSTALLED OPTIONS, ENTER DESIRED OPTION CODE(S) AS LINE ITEMS ON YOUR PURCHASE ORDER UNDER THE PRODUCT CATALOG NUMBER

WATTS	EM OPTION	DESCRIPTION	PHOTOCELL DESCRIPTION	PAINT	SENSOR	DESCRIPTION
40W & 55W	OPT-EM-CGL-40-55	INTERNAL	OPT-PC-B BUTTON	OPT-CLR-95(BK/GR/SR/WH)	OPT-SEN-2MDR-36	PROGRAMMABLE MICROWAVE BI-LEVEL
75W & 100W	OPT-EM-CGL-75-100	INTERNAL				
	VANDAL RES. OPT-TRS-T20	DESCRIPTION Tamper Resistant Screw				
					WEC-3RC	OPTIONAL REMOTE CONTROL



CXES-10-30W
Bronze



CXES-30-60W
Bronze



CXES-40-80W
Bronze



CXES-10-30W-WH
CXES-30-60W-WH
CXES-40-80W-WH
White



CXER-40-80W
Bronze



CXER-30-50W
Bronze



CXER-40-80W-WH
White



CXER-30-50W-WH
White



Sensor-Ready
Plug & Play For CXER Only

BUILDER SERIES NEW CONCEPT GARAGE AND CEILING LIGHTS
POWER & CCT ADJUSTABLE, DAMP LOCATION



CATALOG NO.

DESCRIPTION

PKG. QTY.

SQUARE NEW CONCEPT GARAGE AND CEILING LIGHTS, POWER & CCT ADJUSTABLE, DAMP LOCATION

	CXES-10-30W-MCTP	10W/20W/30W	130LM/W	30K/40K/50K		4
	CXES-30-60W-MCTP	30W/45W/60W	130LM/W	30K/40K/50K		2
	CXES-40-80W-MCTP	40W/60W/80W	130LM/W	30K/40K/50K		2
	CXES-10-30W-MCTP-WH	10W/20W/30W	130LM/W	30K/40K/50K		4
	CXES-30-60W-MCTP-WH	30W/45W/60W	130LM/W	30K/40K/50K		2
	CXES-40-80W-MCTP-WH	40W/60W/80W	130LM/W	30K/40K/50K		2
withEM	CXES-10-30W-MCTP-EM	10W/20W/30W	130LM/W	30K/40K/50K		4
withEM	CXES-30-60W-MCTP-EM	30W/45W/60W	130LM/W	30K/40K/50K		2
withEM	CXES-40-80W-MCTP-EM	40W/60W/80W	130LM/W	30K/40K/50K		2

ROUND NEW CONCEPT GARAGE AND CEILING LIGHTS, POWER & CCT ADJUSTABLE, DAMP LOCATION

	CXER-30-50W-MCTP-SR	30W/40W/50W	135LM/W	30K/40K/50K	(SENSOR-READY)	4
	CXER-40-80W-MCTP-SR	40W/60W/80W	135LM/W	30K/40K/50K	(SENSOR-READY)	2
	CXER-30-50W-MCTP-SR-WH	30W/40W/50W	135LM/W	30K/40K/50K	(SENSOR-READY)	4
	CXER-40-80W-MCTP-SR-WH	40W/60W/80W	135LM/W	30K/40K/50K	(SENSOR-READY)	2
withEM	CXER-30-50W-MCTP-SR-EM	30W/40W/50W	135LM/W	30K/40K/50K	(SENSOR-READY)	4
withEM	CXER-40-80W-MCTP-SR-EM	40W/60W/80W	135LM/W	30K/40K/50K	(SENSOR-READY)	2
withEM	CXER-30-50W-MCTP-SR-EM-WH	30W/40W/50W	135LM/W	30K/40K/50K	(SENSOR-READY)	4
withEM	CXER-40-80W-MCTP-SR-EM-WH	40W/60W/80W	135LM/W	30K/40K/50K	(SENSOR-READY)	2

WEC-3MR-72-TLB-BK 600W Max, Zhaga 12-24VDC Microwave Sensor, Black, With Base (Optional Remote Control WEC-3RC)

WEC-3MBT-72-TLB-BK 600W Max, Zhaga 12-24VDC Microwave Sensor, Bluetooth App Ready, Black, With Base (Optional Remote Control WEC-3RC)

WEC-3PR-72-TLB-WH 600W Max, Zhaga 12-24VDC PIR Sensor, White, With Base (Optional Remote Control WEC-3RC)

OUTDOOR
CANOPY &
GARAGE



POWER-ADJUSTABLE SURFACE-MOUNT CANOPY LIGHT, 120-277V



CATALOG NO.	DESCRIPTION	PKG. QTY.
GSX-SRFC-80-150W-50K	80W/100W/120W/150W 140LM/W 5000K	1



POWER-ADJUSTABLE RECESSED GAS STATION CANOPY LIGHT, 120-277V



CATALOG NO.	DESCRIPTION	PKG. QTY.
GSX-RECS-80-150W-50K	80W/100W/120W/150W 140LM/W 5000K	1

FACTORY-INSTALLED OPTIONS, ENTER DESIRED OPTION CODE(S) AS LINE ITEMS ON YOUR PURCHASE ORDER UNDER THE PRODUCT CATALOG NUMBER

WATTS	EM OPTION	DESCRIPTION	PHOTOCELL	DESCRIPTION	PAINT	SENSOR	DESCRIPTION
ALL MODELS	OPT-EM-GSX	MUST MOUNT ABOVE		N/A	N/A	OPT-3PDR-52 WEC-3RC	BI-LEVEL MICROWAVE REMOTE CONTROL



SPEC SERIES POWER & CCT- ADJUSTABLE GARAGE LIGHT, 120-277V, TYPE 5 LENS

7 DAYS LEAD TIME



DESCRIPTION	MOUNTING	PKG. QTY.
GPX-18-60W-MCTP-CM 18W/30W/45W/60W 150LM/W 30K/40K/50K	Ceiling Mount	1
GPX-18-60W-MCTP-PM75 18W/30W/45W/60W 150LM/W 30K/40K/50K	Pipe Mount with 3/4" Hub	1

FOR GPX OPTIONS & ACCESSORIES SEE PAGE 41.



BOLLARD POST SYSTEM FOR FLOOD LIGHTS

CATALOG NO.	DESCRIPTION	PKG. QTY.
BPS-BASE-2FT	Bollard Pole System 2Ft Base	2
BPS-BASE-3FT	Bollard Pole System 3Ft Base	2
BPS-BASE-5FT	Bollard Pole System 5Ft Base	2
BPS-LH1	Bollard Pole System Single Lamp Holder Section 1Ft With 1/2" Hub	4
BPS-LH2	Bollard Pole System Double Lamp Holder Section 1Ft With 1/2" Hubs	4
BPS-EP-1FT	Bollard Pole System 1Ft Extension Pole	4
BPS-EP-2FT	Bollard Pole System 2Ft Extension Pole	4
BPS-LHT	Bollard Pole System Top Cap Lamp Holder With 1/2" Hub	50



SOLAR G4 MODULAR BOLLARD SYSTEM

CATALOG NO.	DESCRIPTION	PKG. QTY.
BOL-G4-301-SOLAR-40K-BK	3W 130LM/W 4000K Head	1
BOL-G4-301-SOLAR-40K-BR	3W 130LM/W 4000K Head	1
BOL-G4-SHAFT-14-BK	G4 Bollard Shaft 14 Inch, Black	
BOL-G4-SHAFT-14-BR	G4 Bollard Shaft 14 Inch, Bronze	
BOL-G4-SHAFT-30-BK	G4 Bollard Shaft 30 Inch, Black	
BOL-G4-SHAFT-30-BR	G4 Bollard Shaft 30 Inch, Bronze	
BOL-G4-SOLAR-RC	Remote Control, Required 1 Per Projects	



BOL-G4-201
+
BOL-G4-SHAFT



Anchor Bolts
& Mounting Plate



**HEAD, SHAFT, &
ANCHOR BOLTS SET**
SOLD SEPARATELY

G4 MODULAR BOLLARD SYSTEM



CATALOG NO.	DESCRIPTION	PKG. QTY.
BOL-G4-201-MCTP-BK	7W/14W/22W 110LM/W 30K/40K/50K Head	1
BOL-G4-201-MCTP-BR	7W/14W/22W 110LM/W 30K/40K/50K Head	1
BOL-G4-SHAFT-14-BK	G5 Bollard Shaft 14 Inch, Black	
BOL-G4-SHAFT-14-BR	G5 Bollard Shaft 14 Inch, Bronze	
BOL-G4-SHAFT-30-BK	G5 Bollard Shaft 33 Inch, Black	
BOL-G4-SHAFT-30-BR	G5 Bollard Shaft 33 Inch, Bronze	
BOL-G4-ABK-R	G4 Bollard Round Anchor Bolts & Mounting Plate	
BOL-G4-GSH-01-BK	G4 Bollard Round Anchor Bolts & Mounting Plate	



BOL-G5-101
+
BOL-G5-SHAFT

BOL-G5-401
+
BOL-G5-SHAFT



Anchor Bolts
& Mounting Plate



**HEAD, SHAFT, &
ANCHOR BOLTS SET**
SOLD SEPARATELY

WESTGATE MODERN MODULAR BOLLARD SYSTEM G5



CATALOG NO.	DESCRIPTION	PKG. QTY.
BOL-G5-101-MCTP-BK	8W/13W/18W/25W 130LM/W 30K/40K/50K Head	1
BOL-G5-101-MCTP-BR	8W/13W/18W/25W 130LM/W 30K/40K/50K Head	1
BOL-G5-401-MCTP-BK	5W/8W/12W/15W 130LM/W 30K/40K/50K Head	1
BOL-G5-401-MCTP-BR	5W/8W/12W/15W 130LM/W 30K/40K/50K Head	1
BOL-G5-SHAFT-14-BK	G5 Bollard Shaft 14 Inch, Black	
BOL-G5-SHAFT-14-BR	G5 Bollard Shaft 14 Inch, Bronze	
BOL-G5-SHAFT-33-BK	G5 Bollard Shaft 33 Inch, Black	
BOL-G5-SHAFT-33-BR	G5 Bollard Shaft 33 Inch, Bronze	
BOL-G5-ABK-R	G5 Bollard Round Anchor Bolts & Mounting Plate	
BOL-G5-GSH-01	G5 Bollard 180-Degree Glare Shield	

BOL-G2-140 BOL-G2-135 BOL-G2-118 BOL-G2-107D BOL-G2-103D BOL-G2-107F BOL-G2-103F BOL-G2-102F

HEAD
SOLD SEPARATELY

SHAFT
Avail.in:
9" / 14"
19" / 31"
SOLD SEPARATELY

ANCHOR BOLTS & MOUNTING PLATE
SOLD SEPARATELY



BOL-G2-103
Shown with Optional
Field-Installed Frosted
Lens Accessory
BOL-R-ACC-FL

BOL-G2-102F
Shown with Optional
Field-Installed White
Refl. Accessory
BOL-G2-102F-CR-WH

BOL-G2-103
Shown with Optional
Field-Installed External
Louver Kit Accessory
BOL-G2-102F-CR-WH



WESTGATE MODULAR BOLLARD SYSTEM G2

CATALOG NO.	DESCRIPTION	PKG. QTY.
BOL-G2-102F-MCTP-BK	14w/19w/24w 125LM/W 30K/40K/50K Head	4
BOL-G2-102F-MCTP-BR	14w/19w/24w 125LM/W 30K/40K/50K Head	4
BOL-G2-103F-MCTP-BK	14w/19w/24w 125LM/W 30K/40K/50K Head	4
BOL-G2-103F-MCTP-BR	14w/19w/24w 125LM/W 30K/40K/50K Head	4
BOL-G2-107F-MCTP-BK	14w/19w/24w 125LM/W 30K/40K/50K Head	4
BOL-G2-107F-MCTP-BR	14w/19w/24w 125LM/W 30K/40K/50K Head	4
BOL-G2-103D-MCTP-BK	14w/19w/24w 125LM/W 30K/40K/50K Head	4
BOL-G2-103D-MCTP-BR	14w/19w/24w 125LM/W 30K/40K/50K Head	4
BOL-G2-107D-MCTP-BK	14w/19w/24w 125LM/W 30K/40K/50K Head	4
BOL-G2-107D-MCTP-BR	14w/19w/24w 125LM/W 30K/40K/50K Head	4
BOL-G2-118-MCTP-BK	14w/19w/24w 125LM/W 30K/40K/50K Head	4
BOL-G2-118-MCTP-BR	14w/19w/24w 125LM/W 30K/40K/50K Head	4
BOL-G2-135-MCTP-BK	12w/18w/20w 125LM/W 30K/40K/50K Head	4
BOL-G2-135-MCTP-BR	14w/19w/24w 125LM/W 30K/40K/50K Head	4
BOL-G2-140-MCTP-BK	14w/19w/24w 125LM/W 30K/40K/50K Head	4
BOL-G2-140-MCTP-BR	14w/19w/24w 125LM/W 30K/40K/50K Head	4
BOL-G2-SHAFT-31-BK	G2 Bollard Shaft 31 Inch, Black	
BOL-G2-SHAFT-31-BR	G2 Bollard Shaft 31 Inch, Bronze	
BOL-G2-SHAFT-19-BK	G2 Bollard Shaft 19 Inch, Black	
BOL-G2-SHAFT-19-BR	G2 Bollard Shaft 19 Inch, Bronze	
BOL-G2-SHAFT-14-BK	G2 Bollard Shaft 14 Inch, Black	
BOL-G2-SHAFT-14-BR	G2 Bollard Shaft 14 Inch, Bronze	
BOL-G2-SHAFT-9-BK	G2 Bollard Shaft 9 Inch, Black	
BOL-G2-SHAFT-9-BR	G2 Bollard Shaft 9 Inch, Bronze	
BOL-G2-ABK-R	G2 Bollard Round Replacement Anchor Bolts & Mounting Plate	
BOL-G2-102F-CR-WH	G2 Bollard Head 102F Replacement Cone Reflector, White	
BOL-G2-103-LAK-BK	G2 Bollard Louver Kit For Model 103, Black	
BOL-G2-103-LAK-BR	G2 Bollard Louver Kit For Model 103, Bronze	
BOL-R-ACC-FL	Field-installed replacement frosted lens	

POST FOR WMS, LMW, LWA-12W, LWAX-12W SERIES

CATALOG NO.	DESCRIPTION
WMS-POST1-18	18" One side optional Post, Bronze Finish
WMS-POST2-18	18" Two side optional Post, Bronze Finish
WMS-POST1-36	36" One side optional Post, Bronze Finish
WMS-POST2-36	36" Two side optional Post, Bronze Finish

BOLLARD CUSTOMIZATION

CATALOG NO.	POST SIZE		FIXTURES PER POLE		COLOR TEMPERATURE		FINISH	
	CODE	DESCRIPTION	CODE	DESCRIPTION	CODE	DESCRIPTION	CODE	DESCRIPTION
WMS-S	18	18 Inch	1	1 Sided	30K	3000K	BR	Bronze
WMS-R	36	36 Inch	2	2 Sided	40K	4000K	WH	White
LMW					50K	5000K		

LWA-12 For more information on each fixture model, refer to: LWA-12 page 4, LMW page 10, WMS page 10.



OUTDOOR GARDEN LIGHTS



BOL-44-R-L-C-MCTP-BK
Black



BOL-42-R-L-C-MCTP-BK
Black



BOL-42-S-C-C-MCTP-BK
Black

7 DAYS LEAD TIME ALL MODELS ARE AVAILABLE IN BRONZE & BLACK

ROUND AND SQUARE BOLLARD, 120-277VAC, (ADJUSTABLE POWER 12-22W & CCT 30K/40K/50K)



CATALOG NO.	DESCRIPTION	WHILE SUPPLIES LAST	PKG. QTY.
BOL-44-R-L-C-MCTP-BK	Bollard 44In Round Dome Top Louver Clear Lens, Black,, 6" Dia		1
BOL-42-R-L-C-MCTP-BK	Bollard 42In Round Flat Top Louver Clear Lens, Black,, 6" Dia		1
BOL-42-S-C-C-MCTP-BK	Bollard 42In Square Flat Top Cone Clear Lens, Black,, 6" SQ		1
BOL-42-S-C-C-MCTP-BR	Bollard 42In Square Flat Top Cone Clear Lens, Bronz,, 6" SQ		1



FACTORY-INSTALLED OPTIONS, ENTER DESIRED OPTION CODE(S) AS LINE ITEMS ON YOUR PURCHASE ORDER UNDER THE PRODUCT CATALOG NUMBER

WATTS	EM OPTION	DESCRIPTION	PHOTOCELL	DESCRIPTION	PAINT	SENSOR	DESCRIPTION
ALL MODELS	OPT-EM-BOL	INTERNAL SHIELD OPTION DESCRIPTION	OPT-PC-B	BUTTON	OPT-CRL-95(BK/GR/SR/WH)	OPT-SEN-WMC	MICROWAVE BI-LEVEL
	OPT-BOL-SHI	Shield					

FIXTURE
ACCESSORIES



LF-THREAD

1/2" hub adaptor for fixtures with trunnion bracket (on fixtures up to 50W)



WRC-3-BRZ

Weatherproof cover with three (3) 1/2" hubs



SPS-75

4" SQ. Swivel-type cover & 3/4" hub with 1/2" reducer



HB-HOOK

High Bay 2-1/2" heavy-duty Zinc Alloy hook with 1/2" steel locknut, set screw, cable bushing

SHROUDS

REVERSIBLE



LF4-SH1

Fits LF4-12W & 15W, LF4-12V-6W & 12W (Polycarbonate)

LF4-SH2

Fits LF4-30W, LF4-12V-24W & 30W (Polycarbonate)

LF4-SH3

Fits LF4-50W, LF4-12V-50W (Polycarbonate)

LF4-SH4

Fits LF4-80W & 100W, (Aluminum)

LF4-SH5

Fits LF4-150W (Aluminum)



LF3-SH1FG

Full-Glare Shrouds for LF4 12W, 30W

LF3-SH2FG

Full-Glare Shrouds for LF4 50W

LF3 Full-Glare Shrouds compatible with LF4 Series



FL-SH1

Fits FLD2-15W, FLV12-6W

FL-SH2

Fits FLD2-28W, FLV12-12W & 24W

FL-SH3

Fits FLD2-42W, FLV12-32W

FL-SH4

Fits FLD2-50W

PHOTOCONTROLS



PC-1
PC-1H



PC-1S



PC-2S



PC-B
PC-BU



PC-BP



PC-BUM



PC-TLSC



PC-TLSOC-3PIN



PC-TLSOC-7PIN



PC-TWIST
PC-TWIST-480V



LF3-PCK
LF3-PCK-480V



SL-PC



WEC-3MPC-GY



WEC-3MPCN

PHOTOCONTROLS FOR OUTDOOR

CATALOG NO.	DESCRIPTION
PC-1	120V Stem Mount 1800W Photocell
PC-1H	277V Stem Mount 1800W Photocell
PC-1S	Photocell Swivel Arm 120V , 1000W
PC-2S	Swivel Photocell , 120Vac , 1800W
PC-B	Button Photocell , 120Vac , 500W
PC-BU	Button Photocell, 120-277Vac , 500W
PC-BP	Photocell With 1-Gauge Stainless Steel Plate And Gasket , 120Vac , 500W
PC-BUM	Mini Button Photocell, 120-277Vac , 500W
PC-TLSC	Twist Lock Shorting Cap For Photocell Socket
PC-TLSOC-3PIN	3-Pin Socket Twist Lock For Smart Control Systems
PC-TLSOC-7PIN	7-Pin Socket Twist Lock For Smart Control Systems
PC-TWIST	Twist Lock Photocell 1800W Tungston 120-277V Ac /1800W
PC-TWIST-480V	Twist Lock Photocell 1800W Tungston 490V
LF3-PCK	Twist-Lock Photocell Kit, 120-277V
LF3-PCK-480V	Twist-Lock Photocell Kit, 480V
SL-PC	Micro Button Photocell, 120/277V, 40W
WEC-3MPC-GY	Microwave IP67 Photocell With 1/2" Thread, Gray
WEC-3MPCN	Ultra-Violet Photocell, 120-277V 1/2in NPT Size

SURGE PROTECTOR



FACTORY-INSTALLED OPTIONS, ENTER DESIRED OPTION CODE(S) AS LINE ITEMS ON YOUR PURCHASE ORDER UNDER THE PRODUCT CATALOG NUMBER

TYPE	CATALOG NO.	DESCRIPTION
OUTDOOR FIXTURES	OPT-SP-10KV	Factory Installed, 10KV surge protector



MOTION SENSORS FOR OUTDOOR See Compatible Sensor list in Description

OUTDOOR

SENSORS
MOTTO



CATALOG NO.	DESCRIPTION
WEC-3MRLV-5-BR	600W Max, 0-10V Microwave, 120-277V - Bronze (Optional Remote Control WEC-8RC)
WEC-3MRLV-5-GY	600W Max, 0-10V Microwave, 120-277V - Gray (Optional Remote Control WEC-8RC)
WEC-3MRLV-5-WH	600W Max, 0-10V Microwave, 120-277V - White (Optional Remote Control WEC-8RC)
WEC-3MRLV-5-CLR	600W Max, 0-10V Microwave, 120-277V - Clear (Optional Remote Control WEC-8RC)
WEC-3MR-3-BR	600W Max, Microwave IP67 Sensor, 1/2" Thread, Bronze (Optional Remote Control WEC-8RC)
WEC-3MR-3-WH	600W Max, Microwave IP67 Sensor, 1/2" Thread, White (Optional Remote Control WEC-8RC)
WEC-3MDR-42	600W Max, 0-10V Mw 120-277V Sensor Dip & Rc (Optional Remote Control WEC-3RC)
WEC-3PDR-52	600W Max, 0-10V PIR 120-277V Sensor Dip & Rc (Optional Remote Control WEC-3RC)
WEC-3PDR-48-480V	120V-480V Pir Ip65 Bi-Level Motion Sensor, Remote Capable (Optional Remote Control WEC-3RC)
WEC-3MR-48	600W Max, 0-10V Mw 120-277V IP66 Metal Knuckle Sensor Dip & Rc (Optional Remote Control WEC-3RC)
WEC-3PR-60	600W Max, 0-10V PIR 120-277V Ip66 Knuckle Sensor Dip & Rc (Optional Remote Control WEC-3RC)
WEC-3PR-78-AJ-WH	PIR Sensor 1-Pin Audio Jack Contact 600W 40Ft 120-277V 0-10V Bi-Level & RC (Optional RC WEC-3RC)
WEC-3PBT-78-AJ-WH	PIR Sensor 1-Pin Audio Jack Contact 600W 40Ft 120-277V 0-10V Bi-Level Bluetooth App * Ready
WEC-AJ-SOCKET	12-24Vdc 1-Pin Audio Jack Sensor Receptacle Socket 1/2In Npt
WEC-3MR-4-BR	600W Max, 90-Degree IP67 Microwave Sensor, Bronze (Optional Remote Control WEC-8RC)
WEC-3MR-4-WH	600W Max, 90-Degree IP67 Microwave Sensor, White (Optional Remote Control WEC-8RC)
WEC-3PDR-58-BR	600W Max, 0-10V PIR IP65 120-277V Sensor Dip And Rc , Bronze (Optional Remote Control WEC-3RC)
WEC-3PDR-58-WH	600W Max, 0-10V PIR IP65 120-277V Sensor Dip And Rc , Bronze (Optional Remote Control WEC-3RC)
WEC-2MRHB2	600W Max, 0-10V Microwave Highbays Sensor Kit (Optional Remote Control WEC-7RC)
WEC-3MR-45	600W Max, 0-10V Mw 120-277V IP66 Highbay Sensor & Rc (Optional Remote Control WEC-3RC)
WEC-2MD-35	600W Max, 0-10V Mw 120-277V Sensor Dip, White
WEC-2MD-33	600W Max, 0-10V Mw 120-277V Low-Ceiling Sensor Dip
WEC-2MDR-36	600W Max, 0-10V Mw 120-277V Sensor + Sensor Head Dip & Rc, White (Optional Remote Control WEC-2RC)
WEC-2MDR-33	600W Max, Microwave Sensor For Linear Strip Lights With Dip (Optional Remote Control WEC-2RC-33)
WEC-2P-44	600W Max, 0-10V PIR 6-24Vdc Troffer Sensor Dip
WEC-2ADP	Ac To Dc Adapter Module For Ant-4
SL-PIR-WH	White 180°, 350W Max Load
SL-PIR-BZ	Bronze 180°, 350W Max Load
SL-HPIR-WH	White 240°, 350W Max Load
SL-HPIR-BZ	Bronze 240°, 350W Max Load
WEC-2CPDR-3	600W Max, 0-10V PIR 120-277V Ceiling Sensor Dip & Rc (Optional Remote Control WEC-3RC)
WEC-2P-58	600W Max, On/Off PIR 120-277V Highbay Sensor
WEC-2DLH-22	600W Max, 0-10V Daylight Harvesting Module, White
WEC-3MBT-72-TLB-BK	600W Max, Zhaga 12-24VDC Microwave Sensor, Bluetooth App * Ready, Black, With Base
WEC-3MBT-72-WH	Microwave Sensor Zhaga Base Bluetooth Mesh, Bluetooth App * Ready
WEC-3PBT-72-WH	Pir Sensor Zhaga Base Bluetooth Mesh, , Bluetooth App * Ready
WEC-3MDBTH-36	Split Microwave Sensor For Outdoor Bluetooth Mesh, , Bluetooth App * Ready
WEC-2MDBTH-36	Split Microwave Sensor For Indoor Bluetooth Mesh, , Bluetooth App * Ready
WEC-2UGW-WIFI	Industrial Gateway With Multi-Signal Input - Wifi Output
WEC-ON50-BR	Sensor Mounting Offset Nipple, 1/2 Inch Size , Bronze
WEC-ON50-WH	Sensor Mounting Offset Nipple, 1/2 Inch Size , White
LLHB-SE	Highbay Sensor Extender Module
LLHB-SMB	Motion Sensor Mounting Box For Linear High Bay Fixtures
LLHB-SENB	Galvanized Steel Sensor Mounting Bracket
YM183-W	Occupancy Pir Sensor, 180°, 30Ft (720Ft), 120V 800/1200W Max, Single Pole, Neutral Req.
YM2108-W	Vacancy & Occupancy Pir Sensor, 180°, 30Ft (720Ft), 120V 800/1200W Max, Single Pole, Neutral Req.
YM2108-T-W	Vacancy & Occupancy Pir Sensor, 180°, 25Ft (600Ft), 120V 600/1000W Max, 3-Way, Neutral Req.





WEC-2RC



WEC-3RC



WEC-8RC



WEC-2RC-33

REMOTE CONTROL FOR MOTION SENSORS (FOR COMPATIBILITY, SEE PREVIOUS PAGE)

CATALOG NO.	DESCRIPTION
WEC-8RC	Remote Control For WEC-3MR-4 & WEC-3MR-3
WEC-2RC	Remote Control For WEC-2MD-36, Silver
WEC-3RC	Remote Control For Motion Sensors
WEC-2RC-33	Remote Control For WEC-2MDR-33 Motion Sensor



WEC-MOD-010V-BT
WEC-MOD-010V-WIFI
WEC-MOD-TR-WIFI

WEC-MOD-WIFI-RC
(WORKS WITH WIFI MODULES ONLY)
NOT WITH BLUETOOTH MODULE OR SWITCHES

The WEC-MOD installed on a 0~10V or Triac fixture to control the luminaries via WIFI, BT or a remote control.



WESTGATE SMART LIGHTING CONTROL MODULES - 1/2" KNUCKLE

CATALOG NO.	DESCRIPTION
WEC-MOD-010V-BT	WG Smart Lighting Control Module 1000W 0-10V Bluetooth IP65
WEC-MOD-010V-WIFI	WG Smart Lighting Control Module 1000W 0-10V Wifi IP65
WEC-MOD-TR-WIFI	WG Smart Lighting Control Module 300W Triac Wifi IP65
WEC-MOD-WIFI-RC	WG Smart Remote Control Compatible With Wifi Lighting Modules



WEC-SW-PBI-010V-BT
WEC-SW-PBI-TR-WIFI

This stand-alone "wall dimmer" functions similarly to traditional wall switches by directly wiring to the fixture.



WESTGATE SMART LIGHTING CONTROL SWITCHES SWITCHES WORK AS STAND ALONE OR WITH WESTGATE APP.

CATALOG NO.	DESCRIPTION
WEC-SW-PBI-010V-BT	WG Smart Push Button Wall Switch 1000W 0-10V Bluetooth + Wall Plate
WEC-SW-PBI-TR-WIFI	WG Smart Push Button Wall Switch 300W Triac Wifi + Wall Plate



FACTORY-INSTALLED OPTIONS, ENTER DESIRED OPTION CODE(S) AS LINE ITEMS ON YOUR PURCHASE ORDER UNDER THE PRODUCT CATALOG NUMBER

CATALOG NO.	DESCRIPTION
OPT-EM-CW2EXT	COLD-WEATHER EXTERNAL EMERGENCY POWER SUPPLY 27W FACTORY OPTION
OPT-EM-CW2INT	COLD-WEATHER INTERNAL EMERGENCY POWER SUPPLY 27W FACTORY OPTION
OPT-EM-CW1INT	COLD-WEATHER INTERNAL EMERGENCY POWER SUPPLY 18W FACTORY OPTION

10KV SURGE PROTECTION MODULE UL1449

CATALOG NO.	DESCRIPTION
SPI0KV	100-300V 10Kv 8A Surge Protection Module UL1449
SPI0KV-480V	480V 10Kv Surge Protection Device UL1449



OUTDOOR
SMART CONTROL

INDUSTRIAL LIGHTING



UHX
Black



UHX
White



HB-RING



HB-EB-50/75



UHX-SMB

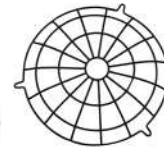

UHX-WG



UHX-SA-5075



UHX-ALR
UHX-ALRW



UHX-PCR



UHX-PCPD



UHX-PCC



UHX-FL



UHX-SC



SCL-GS210
SCL-GS220

SPEC SERIES NEW GENERATION - UFO HIGHBAY, 120-277V



CATALOG NO.	DESCRIPTION	PKG. QTY.
UHX-150W-MP-50K	50W/80W/100W/150W 140LM/W 5000K Black MP	1
UHX-150W-MP-40K	50W/80W/100W/150W 140LM/W 4000K Black MP	1
UHX-230W-MP-50K	100W/150W/200W/230W 140LM/W 5000K Black MP	1
UHX-230W-MP-40K	100W/150W/200W/230W 140LM/W 4000K Black MP	1
UHX-300W-MP-50K	150W/200W/240W/300W 140LM/W 5000K Black MP	1
UHX-150W-MCTP	50W/80W/100W/150W 125LM/W 30K/40K/50K/57K Black MCTP	1
UHX-230W-MCTP	100W/150W/200W/230W 125LM/W 30K/40K/50K/57K Black MCTP	1
UHX-150W-MCTP-WH	50W/80W/100W/150W 125LM/W 30K/40K/50K/57K White MCTP	1
UHX-230W-MCTP-WH	100W/150W/200W/230W 125LM/W 30K/40K/50K/57K White MCTP	1
HB-RING	Highbay top ring adapter, 1/2in	
HB-EB-50/75	UFO top threaded hub expansion bushing from 1/2" to 3/4"	
UHX-SMB	Surface Mounting Yoke Bracket For 100W To 300W	
UHX-WG-A	Wire Guard, Fits On Fixtures 150W (MP & MCTP) & 230W (MP Only)	
UHX-WG-B	Wire Guard, Fits On Fixtures 230W (MCTP Only) & 300W MP	
UHX-ALR-A	60° Alum. Reflector For 150W (MP & MCTP) & 230W (MP Only)	
UHX-ALR-B	60° Alum. Reflector For 230W (MCTP Only) & 300W MP	
UHX-ALRW-A	90° Alum. Reflector For 150W (MP & MCTP) & 230W (MP Only)	
UHX-ALRW-B	90° Alum. Reflector For 230W (MCTP Only) & 300W MP	
UHX-PCR-A	Prismatic PC Reflector For 150W (MP & MCTP) & 230W (MP Only)	
UHX-PCR-B	Prismatic PC Reflector For 230W (MCTP Only) & 300W MP	
UHX-PCDC	PC Drop Lens Cover For PC Reflectors (Not for Alum. Reflectors), Fits All Sizes	
UHX-PCC	PC Bottom Cover For PC Reflectors (Not for Alum. Reflectors), Fits All Sizes	
UHX-SC	Safety Cable	
SCL-GS210	Heavy-Duty Adjustable 5/64" 10 Ft. Suspension Kit With Loop Gripper & Hook(1)	
SCL-GS220	Heavy-Duty Adjustable 5/64" 20 Ft. Suspension Kit With Loop Gripper & Hook(1)	
UHX-FL-A	Replacement Frosted PC Lens For UHX-150W-MP only	
UHX-FL-B	Replacement Frosted PC Lens For UHX-150W-MCTP & UHX-230W-MP only	
UHX-FL-C	Replacement Frosted PC Lens For 230W-MCTP & 300W	
UHX-CL-A	Replacement Clear Lens For Up To 150W	
UHX-CL-B	Replacement Clear Lens For 230W-MP (NOT FOR 230W-MCTP)	
UHX-CL-C	Replacement Clear Lens For 230W-MCTP & 300W	
UHX-SA-5075	1/2in Stem-mounting adapter with cable passage with 3/4in bushing	

FACTORY-INSTALLED OPTIONS, ENTER DESIRED OPTION CODE(S) AS LINE ITEMS ON YOUR PURCHASE ORDER UNDER THE PRODUCT CATALOG NUMBER

WATTS	EM OPTION	DESCRIPTION	PLUG IN CORD	DESCRIPTION	PAINT	SENSOR	DESCRIPTION
ALL	OPT-EM-UHX	ON TOP	OPT-HBC-125TL-BK	8FT, 15A, 125V,16/3TL,BLK	N/A	OPT-SEN-UHX	MICROWAVE
	WIRE CABLE OPTION	DESCRIPTION	OPT-HBC-125TL-WH	8FT, 15A, 125V,16/3TL,WHT			
	OPT-HBC-5WR-20FT-BK	5-WIRE CABLE	OPT-HBC-277TL-BK	8FT, 15A, 277V,16/3TL,BLK			
			OPT-HBC-277TL-WH	8FT, 15A, 277V,16/3TL,WHT			
			OPT-HBC-125SB-BK	10FT, 15A, 125V,18/3STR,BLK			
			OPT-HBC-125SB-WH	10FT, 15A, 125V,18/3STR,WHT			



INDUSTRIAL

HIGH BAY

480V

SPEC SERIES NEW GENERATION - UFO HIGHBAY, 480V 7 DAYS LEAD TIME



CATALOG NO.	DESCRIPTION	PKG. QTY.
UHX-150W-MP-50K-480V	50W/80W/100W/150W 160LM/W 5000K Black	1
UHX-230W-MP-50K-480V	100W/150W/200W/230W 160LM/W 5000K Black	1
UHX-300W-MP-50K-480V	150W/200W/240W/300W 160LM/W 5000K Black	1
UHX-150W-MCTP-480V	50W/80W/100W/150W 125LM/W 30K/40K/50K/57K Black	1
UHX-230W-MCTP-480V	100W/150W/200W/230W 125LM/W 30K/40K/50K/57K Black	1
UHX-150W-MCTP-WH-480V	50W/80W/100W/150W 125LM/W 30K/40K/50K/57K White	1
UHX-230W-MCTP-WH-480V	100W/150W/200W/230W 125LM/W 30K/40K/50K/57K White	1

FOR FACTORY-INSTALLED OPTIONS AND ACCESSORIES SEE UHX BELOW PAGE 59



UHX-SR
Black



UHX-SR
White



Sensor-Ready
Plug & Play

SPEC SERIES UFO HIGHBAY - SENSOR READY SERIES



CATALOG NO.	DESCRIPTION	ARRIVES THIS SEASON CHECK & PRE-ORDER	PKG. QTY.
UHX-150W-MP-40K-SR	50W/80W/100W/150W 140LM/W 4000K Black		1
UHX-150W-MP-50K-SR	50W/80W/100W/150W 140LM/W 5000K Black		1
UHX-230W-MP-40K-SR	100W/150W/200W/230W 140LM/W 4000K Black		1
UHX-230W-MP-50K-SR	100W/150W/200W/230W 140LM/W 5000K Black		1
UHX-300W-MP-50K-SR	150W/200W/230W/300W 140LM/W 5000K Black		1
UHX-150W-MCTP-SR	50W/80W/100W/150W 125LM/W 30K/40K/50K/57K Black		1
UHX-150W-MCTP-WH-SR	50W/80W/100W/150W 125LM/W 30K/40K/50K/57K White		1
UHX-230W-MCTP-SR	100W/150W/200W/230W 130LM/W 30K/40K/50K/57K Black		1
UHX-230W-MCTP-WH-SR	100W/150W/200W/230W 130LM/W 30K/40K/50K/57K White		1
WEC-3MR-72-TLB-BK	600W Max, Zhaga 12-24VDC Microwave Sensor, Black, With Base (Optional Remote Control WEC-3RC)		

WEC-3MBT-72-TLB-BK 600W Max, Zhaga 12-24VDC Microwave Sensor, Bluetooth App Ready, Black, With Base (Optional Remote Control WEC-3RC)

WEC-3PR-72-TLB-WH 600W Max, Zhaga 12-24VDC PIR Sensor, White, With Base (Optional Remote Control WEC-3RC)

FOR FACTORY-INSTALLED OPTIONS AND ACCESSORIES SEE UHX BELOW PAGE 59



UHXE-80-150W-MCTP4-SR
UHXE-165-220W-MCTP4-SR
Black



UHXE-80-150W-MCTP4-SR-WH
UHXE-165-220W-MCTP4-SR-WH
Bronze



HB-RING



HB-EB-50/75



UHX-SA-5075



UHX-SC



SHOWN WITH
UHXE-RPMB



SHOWN WITH
UHXE-PCR-A-90D
UHXE-PCR-B-90D



SHOWN WITH
UHXE-SMB



SHOWN WITH
UHXE-PCR-A-60D
UHXE-PCR-B-60D



Sensor-Ready
Plug & Play



UHXE-PCC-A
UHXE-PCC-B

BUILDER SERIES POWER AND CCT- ADJUSTABLE
UFO HIGHBAY, 120-277V (SENSOR-READY)



CATALOG NO.	DESCRIPTION	PKG. QTY.
UHXE-80-150W-MCTP4-SR	80W/110W/150W 140LM/W 30K/35K/40K/50K Black	1
UHXE-165-220W-MCTP4-SR	165W/190W/220W 140LM/W 30K/35K/40K/50K Black	1
UHXE-80-150W-MCTP4-SR-WH	80W/110W/150W 140LM/W 30K/35K/40K/50K White	1
UHXE-165-220W-MCTP4-SR-WH	165W/190W/220W 140LM/W 30K/35K/40K/50K White	1
UHXE-SMB	UHXE Surface Mounting U Bracket, Black	
UHXE-RPMB	UHXE 1-FT Rigid Pipe Stand with Canopy for Hard Surface (not Swivel)	
UHXE-PCR-A-90D	UHXE-80-150W 90-Degree PC Reflector	
UHXE-PCR-A-60D	UHXE-80-150W 60-Degree PC Reflector	
UHXE-PCR-B-90D	UHXE-165-220W 90-Degree PC Reflector	
UHXE-PCR-B-60D	UHXE-165-220W 60-Degree PC Reflector	
UHXE-PCC-A	UHXE-80-150W Bottom Cover For Pc Reflector, Fits Both 60D 90D	
UHXE-PCC-B	UHXE-165-220W Bottom Cover For Pc Reflector, Fits Both 60D 90D	
HB-RING	Highbay top ring adapter, 1/2in	
HB-EB-50/75	UFO top threaded hub expansion bushing from 1/2" to 3/4"	
UHX-SC	Safety Cable	
UHX-SA-5075	1/2in Stem-mounting adapter with cable passage with 3/4in bushing	
WEC-3MR-72-TLB-BK	600W Max, Zhaga 12-24VDC Microwave Sensor, Black, With Base (Optional Remote Control WEC-3RC)	
WEC-3MBT-72-TLB-BK	600W Max, Zhaga 12-24VDC Microwave Sensor, Bluetooth App Ready, Black, With Base (Optional Remote Control WEC-3RC)	
WEC-3PR-72-TLB-WH	600W Max, Zhaga 12-24VDC PIR Sensor, White, With Base (Optional Remote Control WEC-3RC)	



FACTORY-INSTALLED OPTIONS, ENTER DESIRED OPTION CODE(S) AS LINE ITEMS ON YOUR PURCHASE ORDER UNDER THE PRODUCT CATALOG NUMBER

WATTS	EM OPTION	DESCRIPTION	PLUG IN CORD	DESCRIPTION	PAINT	SENSOR	DESCRIPTION
ALL 120-277V	OPT-EM-UHXE	ON TOP	OPT-HBC-125TL-BK	8FT, 15A, 125V,16/3TL,BLK	N/A	SENSOR READY	SEE ABOVE TABLE
			OPT-HBC-125TL-WH	8FT, 15A, 125V,16/3TL,WHT			
			OPT-HBC-277TL-BK	8FT, 15A, 277V,16/3TL,BLK			
			OPT-HBC-277TL-WH	8FT, 15A, 277V,16/3TL,WHT			
			OPT-HBC-125SB-BK	10FT, 15A, 125V,18/3STR,BLK			
			OPT-HBC-125SB-WH	10FT, 15A, 125V,18/3STR,WHT			

ECONOMY HIGH BAY LAMP & SOCKET, ADJUSTABLE ANGLE (UFO ALTERNATIVE)



CATALOG NO.	DESCRIPTION	PKG. QTY.
UHL-100W-50K	100W 12000LM 5000K Black	18
UHL-150W-50K	150W 18000LM 5000K Black	8
ELB-18150-B	20W MAX, 175VDC, LI-ION 4000MAH BATTERY	



HIGH LUMEN LED MINI HIGH BAY, 120-277 VAC, PC REFLECTOR INCLUDED



CATALOG NO.	DESCRIPTION	PKG. QTY.
LHB2-50W-50K	50W 6750LM 5000K 8-1/4" Dia X 5-1/2"(H), Black	1
LHB2-50W-40K	50W 6750LM 4000K 8-1/4" Dia X 5-1/2"(H), Black	1
LHB2-50W-30K	50W 6750LM 3000K 8-1/4" Dia X 5-1/2"(H), Black	1
LHB2-50W-50K-WH	50W 6750LM 5000K 8-1/4" Dia X 5-1/2"(H), White	1
LHB2-50W-40K-WH	50W 6750LM 4000K 8-1/4" Dia X 5-1/2"(H), White	1
LHB2-50W-30K-WH	50W 6750LM 3000K 8-1/4" Dia X 5-1/2"(H), White	1

INDUSTRIAL

HIGH BAY

120-277V



FACTORY-INSTALLED OPTIONS, ENTER DESIRED OPTION CODE(S) AS LINE ITEMS ON YOUR PURCHASE ORDER UNDER THE PRODUCT CATALOG NUMBER

WATTS	EM OPTION	DESCRIPTION	PLUG IN CORD	DESCRIPTION	PAINT	SENSOR	DESCRIPTION
ALL 120-277V	OPT-EM-LHB2	ULHB-HBMK	OPT-HBC-125TL-BK	8FT, 15A, 125V,16/3TL,BLK	N/A	OPT-SEN-ULHB	ULHB-SK
			OPT-HBC-125TL-WH	8FT, 15A, 125V,16/3TL,WHT			
			OPT-HBC-277TL-BK	8FT, 15A, 277V,16/3TL,BLK			
			OPT-HBC-277TL-WH	8FT, 15A, 277V,16/3TL,WHT			
			OPT-HBC-125SB-BK	10FT, 15A, 125V,18/3STR,BLK			
			OPT-HBC-125SB-WH	10FT, 15A, 125V,18/3STR,WHT			



4FT X 2 MAGNETIC RETROFIT STRIP KIT WITH EXT. DRIVER- POWER & CCT ADJUSTABLE



CATALOG NO.	DESCRIPTION	ARRIVES THIS SEASON CHECK & PRE-ORDER	PKG. QTY.
RMS-4FT-35W-MCTP	20W/28W/35W 140LM/W 27K/30K/35K/40K/50K		10
RMS-4FT-LENS	4FT X 2 Frosted Lens Kit For 4FT RMS Magnetic Retrofit Kit		



PREMIUM STRIP-LIGHT LED RETROFIT KIT WITH LENS



CATALOG NO.	DESCRIPTION	ARRIVES THIS SEASON CHECK & PRE-ORDER	PKG. QTY.
SLRP-4FT-20-40W-MCTP	20W/30W/40W 127LM/W 35K/40K/50K		4
SLRP-8FT-40-80W-MCTP	40W/60W/80W 127LM/W 35K/40K/50K		4

LED T5 RETROFIT LAMPS WITH INTERNAL DRIVER (SURFACE MOUNTING BRACKETS & SCREWS INCLUDED), FOR DIMMABLES SEE PAGE 168



CATALOG NO.	DESCRIPTION	WHILE SUPPLIES LAST	MAX RUN	PKG. QTY.
T5-22IN-9W-40K	9W 1035LM 4000K 2FT		24'	24
T5-22IN-9W-50K	9W 1125LM 5000K 2FT		24'	24
T5-47IN-16W-40K	16W 1840LM 4000K 4FT		31'	24
T5-47IN-16W-50K	16W 2000LM 5000K 4FT		31'	24
T5-6FT-PC	6 FT. Plug-in Power Cord			-
T5-6FT-PCS	7 FT. Plug-in Power Cord			-
T5-8IN-JUMP	8" Linking Cable			-
T5-6FT-PT	6' AC Input Wire (PIGTAIL)			-
T5-COUPLER	Coupler			-
T5-MAGSET	Clip-on Secure Magnet Set			-

120-277V





LLHC-80-150W-MCTP
White

LLHC-165-220W-MCTP
White



ADJUSTABLE LENSES

BUILDER SERIES POWER & CCT- ADJUSTABLE COMPACT LINEAR HIGHBAY

DESCRIPTION	PKG. QTY.
LLHC-80-150W-MCTP 80W/110W/150W 150LM/W 30K/35K/40K/50K 10"(H) X 14 2/3"(W) X 1 8/9"(D)	1
LLHC-165-220W-MCTP 165W/190W/220W 150LM/W 30K/35K/40K/50K 10"(H) X 23"(W) X 1 8/9"(D)	1
LLHC-WG1 LLHC Wireguard for 150W	
LLHC-WG2 LLHC Wireguard for 220W	

FACTORY-INSTALLED OPTIONS, ENTER DESIRED OPTION CODE(S) AS LINE ITEMS ON YOUR PURCHASE ORDER UNDER THE PRODUCT CATALOG NUMBER

WATTS	EM OPTION	DESCRIPTION	PLUG IN CORD	DESCRIPTION	PAINT	SENSOR	DESCRIPTION
ALL	OPT-EM-LLHC	EXTERNAL	OPT-HBC-125TL-WH	8FT, 15A, 125V, WHITE	N/A	OPT-SEN-3MR-3-WH	PROGRAMMABLE MICROWAVE BI-LEVEL
			OPT-HBC-277TL-WH	8FT, 15A, 277V, WHITE		WEC-3RC	REMOTE CONTROL
			OPT-HBC-125SB-WH	10FT, 15A, 125V, 18/35TR, WHT			

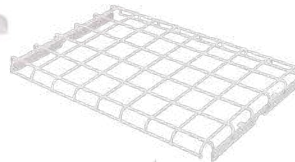

Wireguard



Sensor-Ready
Plug & Play

X-GENERATION COMPACT LINEAR HIGHBAY, SENSOR READY
POWER & CCT SELECT, 90DX90D LENS



CATALOG NO.	DESCRIPTION
LHCX-110-150W-MCTP-SR	110W/130W/150W 140LM/W 30K/40K/50K 14.17" X 11.00" X 1.77"
LHCX-165-215W-MCTP-SR	165W/180W/215W 140LM/W 30K/40K/50K 18.11" X 11.81" X 1.77"
LHCX-255-320W-MCTP-SR	255W/290W/320W 140LM/W 30K/40K/50K 23.03" X 11.81" X 1.77"
LHCX-SMK	Surface-mounting Kit
LHCX-WG1	Wireguard For 150W Max Model
LHCX-WG2	Wireguard For 215W Max Model
LHCX-WG3	Wireguard For 320W Max Model
LHCX-PM75	LHCX Pendant Mounting Accessory, 3/4in Hole On Top And Two 1/2in KO
LHCX-LENS-150W-45X90	LHCX 110-150W Size Special Narrow-Aisle Lens Kit 45Dx90D
LHCX-LENS-215W-45X90	LHCX 165-215W Size Special Narrow-Aisle Lens Kit 45Dx90D
LHCX-LENS-320W-45X90	LHCX 255-320W Size Special Narrow-Aisle Lens Kit 45Dx90D
LHCX-LENS-150W-110X110	LHCX 110-150W Size Special Wide-Angle Lens Kit 110Dx110D
LHCX-LENS-215W-110X110	LHCX 165-215W Size Special Wide-Angle Lens Kit 110Dx110D
LHCX-LENS-320W-110X110	LHCX 255-320W Size Special Wide-Angle Lens Kit 110Dx110D
LHCX-LENS-150W-65X65	LHCX 110-150W Size Special Medium-Angle Lens Kit 65Dx65D
LHCX-LENS-215W-65X65	LHCX 165-215W Size Special Medium-Angle Lens Kit 65Dx65D
LHCX-LENS-320W-65X65	LHCX 255-320W Size Special Medium-Angle Lens Kit 65Dx65D
WEC-3MR-72-TLB-BK	600W Max, Zhaga 12-24VDC Microwave Sensor, Black, With Base (Optional Remote Control WEC-3RC)
WEC-3MBT-72-TLB-BK	600W Max, Zhaga 12-24VDC Microwave Sensor, Bluetooth App Ready, Black, With Base (Optional Remote Control WEC-3RC)
WEC-3PR-72-TLB-WH	600W Max, Zhaga 12-24VDC PIR Sensor, White, With Base (Optional Remote Control WEC-3RC)

LED LINEAR HIGH BAY ACCESSORIES

CATALOG NO.	DESCRIPTION
 ELB-2048-EXTR	Field-installed emergency driver, Input voltage: 100-277AC, Output voltage: 12V-48VDC, Output power: 20W (Max), Emergency operation: ≥90 mins., Recharge: 24 Hrs.
CH-1212	Steel jack chain, 100ft., 12GA, (Meets weight requirements for Linear High Bays)
CH-1010	Steel jack chain, 100ft., 10GA
SCL-GSY10	Adjustable 10 Ft. 1/16", 1.5mm SusPension Kit With Y-Connector & Loop Grip & Hooks(2)
SCL-GSY20	Adjustable 20 Ft. 1/16", 1.5mm SusPension Kit With Y-Connector & Loop Grip & Hooks(2)
LH-SCREW	Steel flat hanger screw with single hole, 1/4" x 3"

SPEC SERIES 4TH GENERATION OF LINEAR HIGH BAYS, 120-277V

CATALOG NO.	DESCRIPTION	WHILE SUPPLIES LAST	PKG. QTY.
LLHB4-50W-40K-D	50W 7750LM 4000K	1FT. X 13.75	1
LLHB4-50W-50K-D	50W 7750LM 5000K	1FT. X 13.75	1
LLHB4-100W-50K-D	100W 15500LM 5000K	2FT. X 13.77	1
LLHB4-150W-40K-D	150W 23250LM 4000K	2FT. X 17.75	1
LLHB4-150W-50K-D	150W 23250LM 5000K	2FT. X 17.75	1
LLHB4-410W-50K-D	410W 53300LM 5000K	4FT. X 23.20	1
LLHB4-500W-50K-D	500W 62500LM 5000K	4FT. X 23.20	1

FOR SUSPENSION ACCESSORIES SEE PAGES 100 TO 103

FACTORY-INSTALLED OPTIONS, ENTER DESIRED OPTION CODE(S) AS LINE ITEMS ON YOUR PURCHASE ORDER UNDER THE PRODUCT CATALOG NUMBER

WATTS	EM OPTION	DESCRIP-	SURF. OPTION	DESCRIPTION	PAINT	SENSOR	DESCRIPTION
50W, 100W, 150W	OPT-EM-LLHB4-50-150	EXTERNAL	OPT-LLHB4-SMK	SURFACE MOUNTING OPTION	N/A	OPT-SEN-LLHB4	MICROWAVE BI-LEVEL
200W, 300W, 410W, 500W	OPT-EM-LLHB4-200-500	INTERNAL	FLEX WHIP	DESCRIPTION		PLUG IN CORD	DESCRIPTION
	SURGE PROTECTOR	DESCRIP-	OPT-FWH-63	6FT 3-Wire Whip		OPT-HBC-125TL-WH	8FT, 15A, 125V,WHITE
	OPT-SP-10KV	120V	OPT-FWH-65	6FT 5-Wire Whip		OPT-HBC-277TL-WH	8FT, 15A, 277V,WHITE
	OPT-SP-10KV-480V	480V	OPT-FWH-66	6FT 6-Wire Whip		OPT-HBC-125SB-WH	10FT, 15A, 125V,18/3STR,WHT

LED LINEAR HIGH BAY, FIXTURE HANGERS INCL., SUSPENSION CABLE NOT INCL.

CATALOG NO.	DESCRIPTION	PKG. QTY.
LED LINEAR HIGH BAY, 120-277V		
LLHB-120W-50K-D	100W 15500LM 5000K Frosted lens, 4FTx11-1/4"	1
LLHB-120W-40K-D	100W 15500LM 4000K Frosted lens, 4FTx11-1/4"	1
LLHB-180W-50K-D	150W 23250LM 5000K Frosted lens, 4FTx15-7/8"	1
LLHB-180W-40K-D	150W 23250LM 4000K Frosted lens, 4FTx15-7/8"	1
LLHB-240W-50K-D	220W 33000LM 5000K Frosted lens, 4FTx20-1/2"	1
LLHB-240W-40K-D	220W 30000LM 4000K Frosted lens, 4FTx20-1/2"	1
LED LINEAR HIGH BAY, 480V (7DAYS LEAD TIME)		
LLHB-120W-50K-D-480V	100W 15500LM 5000K Frosted lens, 4FTx11-1/4"	1
LLHB-120W-40K-D-480V	100W 15500LM 4000K Frosted lens, 4FTx11-1/4"	1
LLHB-180W-50K-D-480V	150W 23250LM 5000K Frosted lens, 4FTx15-7/8"	1
LLHB-180W-40K-D-480V	150W 23250LM 4000K Frosted lens, 4FTx15-7/8"	1
LLHB-240W-50K-D-480V	220W 33000LM 5000K Frosted lens, 4FTx20-1/2"	1
LLHB-240W-40K-D-480V	220W 30000LM 4000K Frosted lens, 4FTx20-1/2"	1

Updated higher lumens at lower wattages. Per industry standards, Lumens are reported without frosted lens (Removable).
FOR SUSPENSION ACCESSORIES SEE PAGES 100 TO 103

FACTORY-INSTALLED OPTIONS, ENTER DESIRED OPTION CODE(S) AS LINE ITEMS ON YOUR PURCHASE ORDER UNDER THE PRODUCT CATALOG NUMBER

WATTS	EM OPTION	DESCRIPTION	LENS	DESCRIPTION	PAINT	SENSOR	DESCRIPTION
ALL	OPT-EM-LLHB	MOUNTED ON TOP	OPT-LLHB-CL-120/180	CLEAR LENS FOR 120W & 180W	OPT-CLR-95(BK/GR/SR/WH)	OPT-2P-58	PIR SENSOR (Not remote capable)
	FLEX WHIP	DESCRIPTION	OPT-LLHB-CL-240	CLEAR LENS FOR 240W		OPT-SEN-3MR-4-WH	PROGRAMMABLE MICROWAVE
	OPT-FWH-63	6FT 3-Wire Whip	SURF. OPTION	DESCRIPTION		WEC-8RC	OPTIONAL REMOTE
	OPT-FWH-65	6FT 5-Wire Whip	OPT-LLHB-SMK	SURFACE MOUNTING OPTION		PLUG IN CORD	DESCRIPTION
	OPT-FWH-66	6FT 6-Wire Whip	SURGE PROTECTOR	DESCRIPTION		OPT-HBC-125TL-WH	8FT, 15A, 125V,WHITE
			OPT-SP-10KV	10KV surge protector		OPT-HBC-277TL-WH	8FT, 15A, 277V,WHITE
						OPT-HBC-125SB-WH	10FT, 15A, 125V,18/3STR,WHT



4Ft
LLHB4-MCTP
LLHB4-MP (200W TO 500W)
White



2Ft
LLHB4-MP (100W TO 150W)
White



OPT-LLHB4-SMK



2Ft
LLHB4-MCTP-BK
Black



LLHB4-100W-WG
LLHB4-150W-WG

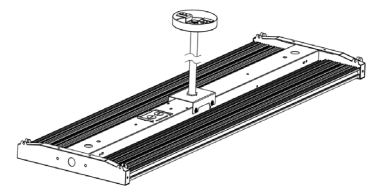

LLHB4-RODKIT

SPEC SERIES 4TH GENERATION OF LINEAR HIGH BAYS, 120-277V



INDUSTRIAL
LINEAR
HIGH BAY

CATALOG NO.	DESCRIPTION	PKG. QTY.
POWER & CCT ADJUSTABLE 4TH GENERATION OF LINEAR HIGH BAYS, 120-277V		
LLHB4-80-150W-MCTP	80W/110W/150W 125LM/W 35K/40K/50K	1
LLHB4-80-150W-MCTP-BK	80W/110W/150W 125LM/W 35K/40K/50K	1
POWER ADJUSTABLE 4TH GENERATION OF LINEAR HIGH BAYS, 120-277V		
LLHB4-100W-MP-40K-D	50W/80W/100W 155LM/W 4000K 2FT. X 13.77	1
LLHB4-100W-MP-50K-D	50W/80W/100W 155LM/W 5000K 2FT. X 13.77	1
LLHB4-150W-MP-40K-D	80W/110W/150W 155LM/W 4000K 2FT. X 17.75	1
LLHB4-150W-MP-50K-D	80W/110W/150W 155LM/W 5000K 2FT. X 17.75	1
LLHB4-200W-MP-40K-D	100W/150W/200W 155LM/W 4000K 4FT. X 13.75	1
LLHB4-200W-MP-50K-D	100W/150W/200W 155LM/W 5000K 4FT. X 13.75	1
LLHB4-300W-MP-40K-D	200W/225W/300W 155LM/W 4000K 4FT. X 17.75	1
LLHB4-300W-MP-50K-D	200W/225W/300W 155LM/W 5000K 4FT. X 17.75	1
LLHB4-410W-MP-50K-D	200W/300W/400W 130LM/W 5000K 4FT. X 23.20	1
LLHB4-500W-MP-50K-D	250W/400W/500W 120LM/W 5000K 4FT. X 23.20	1
POWER & CCT ADJUSTABLE 4TH GENERATION OF LINEAR HIGH BAYS, 480V (7DAYS LEAD TIME)		
LLHB4-80-150W-MCTP-480V	80W/110W/150W 125LM/W 35K/40K/50K	1
LLHB4-80-150W-MCTP-BK-480V	80W/110W/150W 125LM/W 35K/40K/50K	1
POWER ADJUSTABLE 4TH GENERATION OF LINEAR HIGH BAYS, 480V (7DAYS LEAD TIME)		
LLHB4-100W-MP-40K-D-480V	50W/80W/100W 155LM/W 4000K 2FT. X 13.77	1
LLHB4-100W-MP-50K-D-480V	50W/80W/100W 155LM/W 5000K 2FT. X 13.77	1
LLHB4-150W-MP-40K-D-480V	80W/110W/150W 155LM/W 4000K 2FT. X 17.75	1
LLHB4-150W-MP-50K-D-480V	80W/110W/150W 155LM/W 5000K 2FT. X 17.75	1
LLHB4-200W-MP-40K-D-480V	100W/150W/200W 155LM/W 4000K 4FT. X 13.75	1
LLHB4-200W-MP-50K-D-480V	100W/150W/200W 155LM/W 5000K 4FT. X 13.75	1
LLHB4-300W-MP-40K-D-480V	200W/225W/300W 155LM/W 4000K 4FT. X 17.75	1
LLHB4-300W-MP-50K-D-480V	200W/225W/300W 155LM/W 5000K 4FT. X 17.75	1
LLHB4-410W-MP-50K-D-480V	200W/300W/400W 130LM/W 5000K 4FT. X 23.20	1
LLHB4-500W-MP-50K-D-480V	250W/400W/500W 120LM/W 5000K 4FT. X 23.20	1
LLHB4-100W-WG	Wire Guard for 100W	-
LLHB4-150W-WG	Wire Guard for 150W	-
LLHB4-RODKIT	Rod kit 3-1/4" Dia X 40" H and 1/2" Thread	-

FOR FACTORY-INSTALLED OPTIONS SEE LLHB4 ABOVE, FOR SUSPENSION ACCESSORIES SEE PAGES 100 TO 103
Per industry standards, Lumens are reported without frosted lens (Removable).



FACTORY-INSTALLED OPTIONS, ENTER DESIRED OPTION CODE(S) AS LINE ITEMS ON YOUR PURCHASE ORDER UNDER THE PRODUCT CATALOG NUMBER

WATTS	EM OPTION	DESCRIP-	SURF. OPTION	DESCRIPTION	PAINT	SENSOR	DESCRIPTION
50W, 100W, 150W	OPT-EM-LLHB4-50-150	EXTERNAL	OPT-LLHB4-SMK	SURFACE MOUNTING OPTION	N/A	OPT-SEN-LLHB4	MICROWAVE BI-LEVEL
200W, 300W, 410W, 500W	OPT-EM-LLHB4-200-500	INTERNAL	FLEX WHIP	DESCRIPTION		PLUG IN CORD	
	SURGE PROTECTOR	DESCRIP-	OPT-FWH-63	6FT 3-Wire Whip		OPT-HBC-125TL-WH	8FT, 15A, 125V, WHITE
	OPT-SP-10KV	120V	OPT-FWH-65	6FT 5-Wire Whip		OPT-HBC-277TL-WH	8FT, 15A, 277V, WHITE
	OPT-SP-10KV-480V	480V	OPT-FWH-66	6FT 6-Wire Whip		OPT-HBC-125SB-WH	10FT, 15A, 125V, 18/3STR, WHT

120-277V

480V

480V



LTPV-SLC-SR

LTPV-EC-SR

LTPV-SLC-SR



Sensor-Ready Plug & Play see page 54
(one Sensor per Fixture)

BUILDER SERIES MODULAR LINEAR VAPOR TIGHT,
QUICK CONNECT, TRI-PROOF: WATER, DUST & IMPACT RESISTANCE



CATALOG NO.	DESCRIPTION	PKG. QTY.
LTPV-2FT-18W-MCTP-D	10W/15W/18W 130LM/W 30K/40K/50K	9
LTPV-4FT-36W-MCTP-D	20W/28W/36W 130LM/W 30K/40K/50K	9
LTPV-8FT-70W-MCTP-D	55W/60W/70W 140LM/W 30K/40K/50K	9
LTPV-SLC	LLPV Seamless Coupling Channel With Connection Cable	10
LTPV-SLC-SR	LLPV Seamless Coupling Channel Sensor-Ready	10
LTPV-EC-SR	LLPV Sensor-Ready Endcap	10



LVTE-2FT

LVTE-4FT

LVTE-8FT

LVTE-4FT-100-155W-MCTP-HL

LLVT-8FT-65W-40K-D
LLVT-8FT-65W-50K-D
LLVT-8FT-100W-40K-D
LLVT-8FT-100W-50K-D

BUILDER SERIES LINEAR VAPOR-TIGHT FIXTURES, CCT & WATTAGE SELECTABLE



CATALOG NO.	DESCRIPTION	PKG. QTY.
LVTE-2FT-15-25W-MCTP	15W/17W/20W/25W 140LM/W 35K/40K/50K	4
LVTE-4FT-20-35W-MCTP	20W/28W/36W 140LM/W 35K/40K/50K	4
LVTE-4FT-30-46W-MCTP	30W/38W/46W 140LM/W 35K/40K/50K	4
LVTE-4FT-30-60W-MCTP	30W/45W/60W 140LM/W 35K/40K/50K	4
LVTE-8FT-65-110W-MCTP	65W/75W/90W/110W 140LM/W 35K/40K/50K	1
LVTE-4FT-100-155W-MCTP	100W/120W/135W/150W 150LM/W 35K/40K/50K	1
LVTE-4FT-150-200W-MCTP	150W/175W/200W 150LM/W 35K/40K/50K	1
LVTE-4FT-200-245W-MCTP	200W/230W/245W 150LM/W 35K/40K/50K	1
3" WIDE LED LINEAR VAPOR LIGHT		
LLVT-8FT-65W-40K-D	65W 8450LM 4000K	1
LLVT-8FT-65W-50K-D	65W 8450LM 5000K	1
LLVT-8FT-100W-40K-D	100W 13000LM 4000K	1
LLVT-8FT-100W-50K-D	100W 13000LM 5000K	1

3" WIDE

2Ft



LLVT-2FT-25W-MCT-D



6-1/4" WIDE
POLYCARBONATE IP65

4Ft



LLVT-4FT-40W-MCT-D
LLVT-4FT-75W-MCT-D

LED TRADITIONAL LINEAR VAPOR LIGHT, 120-277V

OPAL PC LENS, SS CLAMPS



120-277V

CATALOG NO.	DESCRIPTION	PKG. QTY.
6-1/4" WIDE POLYCARBONATE LED LINEAR VAPOR LIGHT		
LLVT-2FT-25W-MCT-D	25W 3125LM 3500K/4000K/5000K MCT	6
LLVT-2FT-25W-MCTP-D	15W/20W/25W 130LM/W 35K/40K/50K	6
LLVT-2FT-RL	2FT REPLACEMENT LENS	-
6-3/4" WIDE POLYCARBONATE LED LINEAR VAPOR LIGHT		
LLVT-4FT-40W-MCT-D	40W 5000LM 3500K/4000K/5000K MCT	6
LLVT-4FT-40W-MCTP-D	20W/30W/40W 130LM/W 3500K/4000K/5000K	6
LLVT-4FT-75W-MCT-D	75W 9375LM 3500K/4000K/5000K MCT	6
LLVT-4FT-75W-MCTP-D	40W/60W/75W 130LM/W 3500K/4000K/5000K	6
LLVT-4FT-RL	4FT REPLACEMENT LENS	-

FOR FACTORY-INSTALLED OPTIONS SEE LLVT OPTIONS, FOR SUSPENSION ACCESSORIES SEE PAGES 100 TO 103

4Ft



LLVT-4FT



14-1/2" WIDE
POLYCARBONATE IP65

***LED LINEAR VAPOR LIGHT (100-150W)**

CLEAR PC LENS, SS CLAMPS

*SHOWN WITH CLEAR LENS (INCLUDED)



120-277V

CATALOG NO.	DESCRIPTION	PKG. QTY.
LLVT-4FT-100W-MCTP-D	50W/80W/100W 130LM/W 35K/40K/50K 52" X 14.5"	1
LLVT-4FT-150W-MCTP-D	80/110/150W 130LM/W 35K/40K/50K 52" X 14.5"	1
LLVT-4FT-200W-MCTP-D	100W/150W/200W 130LM/W 35K/40K/50K 52" X 14.5"	1
LLVT-4FT-RL2T	OPTIONAL REPLACEMENT FROSTED LENS FOR LLVT	-

FOR SUSPENSION ACCESSORIES SEE PAGES 100 TO 103



FACTORY-INSTALLED OPTIONS, ENTER DESIRED OPTION CODE(S) AS LINE ITEMS ON YOUR PURCHASE ORDER UNDER THE PRODUCT CATALOG NUMBER

WATTS	EM OPTION	DES	PLUG IN CORD	DESCRIPTION	PAINT	SENSOR	DESCRIPTION
25W to 46W	OPT-EM-LLVT-25-46	INTERNAL	OPT-HBC-125TL-WH	8FT, 15A, 125V, WHITE	N/A	OPT-SEN-2MDR-36	PROGRAMMABLE MICROWAVE BI-LEVEL
65W to 155W	OPT-EM-LLVT-65-155	INTERNAL	OPT-HBC-277TL-WH	8FT, 15A, 277V, WHITE	N/A	WEC-3RC	OPTIONAL RC
	SURGE PROTECTOR	DES	OPT-HBC-125SB-WH	10FT, 15A, 125V/18/3STR, WHT			
	OPT-SP-10KV	120V	PHOTOCELL	DESCRIPTION			
	OPT-SP-10KV-480V	480V	OPT-PC-B	BUTTON			



4ft

LLVT-4FT-100W-MCT-D-480V
LLVT-4FT-150W-MCT-D-480V

4ft



LLVT-4FT-40W-MCT-D-480V
LLVT-4FT-75W-MCT-D-480V

8ft



LLVT-8FT-65W-50K-D-480V
LLVT-8FT-65W-40K-D-480V
LLVT-8FT-100W-50K-D-480V
LLVT-8FT-100W-40K-D-480V



LED LINEAR VAPOR LIGHT, 480V 7 DAYS LEAD TIME

INDUSTRIAL

VAPOR & LAMPS

480V

CATALOG NO.	DESCRIPTION	PKG. QTY.
4ft	6-3/4" WIDE POLYCARBONATE LED LINEAR VAPOR LIGHT, 480V	
LLVT-4FT-40W-MCT-D-480V	40W 5000LM 35K/40K/50K	6
LLVT-4FT-75W-MCT-D-480V	75W 9375LM 35K/40K/50K	6
4ft	14-1/2" WIDE POLYCARBONATE LED LINEAR VAPOR LIGHT, 480V	
LLVT-4FT-100W-MCT-D-480V	100W 13500LM 35K/40K/50K	1
LLVT-4FT-150W-MCT-D-480V	150W 20250LM 35K/40K/50K	1
8ft	3" WIDE LED LINEAR VAPOR LIGHT, 480V	
LLVT-8FT-65W-50K-D-480V	65W 8450LM 5000K	1
LLVT-8FT-65W-40K-D-480V	65W 8450LM 4000K	1
LLVT-8FT-100W-50K-D-480V	100W 13000LM 5000K	1
LLVT-8FT-100W-40K-D-480V	100W 13000LM 4000K	1



FOR SUSPENSION ACCESSORIES SEE PAGES 100 TO 103

FACTORY-INSTALLED OPTIONS, ENTER DESIRED OPTION CODE(S) AS LINE ITEMS ON YOUR PURCHASE ORDER UNDER THE PRODUCT CATALOG NUMBER

WATTS	EM OPTION	DES	PLUG IN CORD	DESCRIPTION	PAINT	SENSOR	DESCRIPTION
25w to 46w	OPT-EM-LLVT-25-46	INTERNAL	OPT-HBC-125TL-WH	8FT, 15A, 125V,WHITE	N/A	OPT-SEN-2MDR-36	PROGRAMMABLE MICROWAVE BI-LEVEL
65w to 155w	OPT-EM-LLVT-65-155	INTERNAL	OPT-HBC-277TL-WH	8FT, 15A, 277V,WHITE	N/A	WEC-3RC	OPTIONAL RC
	SURGE PROTECTOR	DES	OPT-HBC-125SB-WH	10FT, 15A, 125V/18/3STR,WHT			
	OPT-SP-10KV	120V	PHOTOCELL	DESCRIPTION			
	OPT-SP-10KV-480V	480V	OPT-PC-B	BUTTON			



LDL-R-30W-60K-A40



LDL-R-60W-60K-A40



LDL-S-50W-60K-B40R



LDL-R-E26-A40

LOADING DOCK LIGHTS



CATALOG NO.	DESCRIPTION	ARRIVES THIS SEASON CHECK & PRE-ORDER	PKG. QTY.
LDL-R-30W-60K-A40	30W 3300LM 6000K		2
LDL-R-60W-60K-A40	60W 6600LM 6000K		2
LDL-S-50W-60K-B40R	50W 7000LM 6000K		2
LDL-R-E26-A40	Loading Dock For Par Lamps With 1ft Wp Connector And 40In Bracket		



LED 180 DEGREE FLAT HID RETROFIT LAMP



CATALOG NO.	DESCRIPTION	REPLACEMENT RANGE	PKG. QTY.
CL-FLT-54W-50K-E39	54W WHILE SUPPLIES LAST 5940LM 5000K 9.6"(L) x 4.5"(W) x 3.2"(H)	70-150 MH	8
CL-FLT-75W-50K-E39	75W WHILE SUPPLIES LAST 9000LM 5000K 11.7"(L) x 5.5"(W) x 3.4"(H)	150-320 MH	8
CL-FLT-115W-50K-E39	115W WHILE SUPPLIES LAST 13570LM 5000K 11.7"(L) x 5.5"(W) x 3.4"(H)	320-400 MH	8
POWER & CTT - ADJUSTABLE LED 180 DEGREE FLAT HID RETROFIT LAMP			
CL-FLT-54-75W-50K-E39	54W/63W/75W 150LM/W 5000K 11.7"(L) x 5.5"(W) x 3.4"(H)	150-320 MH	8
CL-FLT-75-115W-50K-E39	75W/97W/110W 150LM/W 5000K 11.7"(L) x 5.5"(W) x 3.4"(H)	320-400 MH	8



POWER & CCT SWITCHES

CL-EHL-12-27W-MCTP-E26
CL-EHL-36-54W-MCTP-E39
CL-EHL-80-120W-MCTP-E39

CL-EHL
(12W TO 27W)

CL-EHL
(36W TO 54W)

CL-EHL
(75W TO 120W)

Internal Driver
CL-HL
(200W TO 300W)

External Driver
CL-HL-200W-EXTR
CL-HL-200W-480W



HIGH-LUMEN LED CORN LAMP, 100-277V AC

CATALOG NO.	DESCRIPTION	PKG. QTY.
POWER & CCT ADJUSTABLE HIGH-LUMEN LED CORN LAMP, 100-277V AC		
CL-EHL-12-27W-MCTP-E26	27MAX 150LM/W 30K/40K/50K E26 H: 6.69" X D: 2.36"	24
CL-EHL-36-54W-MCTP-E39	54MAX 150LM/W 30K/40K/50K E39 H: 9.84" X D: 3.34"	12
CL-EHL-80-120W-MCTP-E39	120MAX 150LM/W 30K/40K/50K E39 H: 11.14" X D: 5.11"	6
HIGH-LUMEN LED CORN LAMP, 100-277V AC, DLC EXCEPT E26		
CL-EHL-12W-30K-E26	12W 1500LM 3000K E26 H: 4.90" X D: 2.36" 30-50MH	24
CL-EHL-12W-50K-E26	12W 1860LM 5000K E26 H: 4.90" X D: 2.36" 30-50MH	24
CL-EHL-18W-30K-E26	18W 2250LM 3000K E26 H: 5.70" X D: 2.36" 50-60MH	24
CL-EHL-18W-50K-E26	18W 2610LM 5000K E26 H: 5.70" X D: 2.36" 50-60MH	24
CL-EHL-27W-30K-E26	27W 3375LM 3000K E26 H: 6.69" X D: 2.36" 50-70MH	24
CL-EHL-27W-50K-E26	27W 4185LM 5000K E26 H: 6.69" X D: 2.36" 50-70MH	24
CL-EHL-36W-30K-E26	36W 4500LM 3000K E26 H: 7.55" X D: 3.34" 50-100MH	12
CL-EHL-36W-50K-E26	36W 5580LM 5000K E26 H: 7.55" X D: 3.34" 50-100MH	12
CL-EHL-36W-30K-E39	36W 4500LM 3000K E39 H: 8.30" X D: 3.34" 50-100MH	12
CL-EHL-36W-50K-E39	36W 5580LM 5000K E39 H: 8.30" X D: 3.34" 50-100MH	12
CL-EHL-45W-30K-E39	45W 5625LM 3000K E39 H: 9.84" X D: 3.34" 70-100MH	12
CL-EHL-45W-50K-E39	45W 6975LM 5000K E39 H: 9.84" X D: 3.34" 70-100MH	12
CL-EHL-54W-30K-E39	54W 6750LM 3000K E39 H: 9.84" X D: 3.34" 70-125MH	12
CL-EHL-54W-50K-E39	54W 8370LM 5000K E39 H: 9.84" X D: 3.34" 70-125MH	12
CL-EHL-75W-30K-E39	75W 9375LM 3000K E39 H: 9.84" X D: 5.11" 70-125MH	6
CL-EHL-75W-50K-E39	75W 11625LM 5000K E39 H: 9.84" X D: 5.11" 70-125MH	6
CL-EHL-100W-30K-E39	100W 12500LM 3000K E39 H: 10.31" X D: 5.11" 70-175MH	6
CL-EHL-100W-50K-E39	100W 15500LM 5000K E39 H: 10.31" X D: 5.11" 70-175MH	6
CL-EHL-120W-30K-E39	120W 15600LM 3000K E39 H: 11.14" X D: 5.11" 200-400MH	6
CL-EHL-120W-50K-E39	120W 17400LM 5000K E39 H: 11.14" X D: 5.11" 200-400MH	6
CL-HL-200W-50K-E39	200W 28000LM 5000K E39 H: 14.25" X D: 5.75" 600MH	6
CL-HL-240W-50K-E39	240W 34800LM 5000K E39 H: 13.15" X D: 5.50" 800W HID	6
CL-HL-300W-50K-E39	300W 43500LM 5000K E39 H: 13.15" X D: 5.50" 800W HID	6
CL-HL-200W-50K-E39-EXTR	200W 28000LM 5000K E39 H: 14.25" X D: 5.75" 600MH	4
480V CL-HL-200W-50K-E39-480V	200W 28000LM 5000K E39 H: 14.25" X D: 5.75" 600MH	4
E26-ENLARGER	ENLARGES E26 (MED.), BASE TO BE USED IN E39 (MOGUL) SOCKET	6
E39-REDUCER	REDUCES E39 (MOGUL), BASE TO BE USED IN E26 (MED.) SOCKET	6

NOTE: FOR 125W OR BELOW: IF USED IN ENCLOSED FIXTURE, CHECK SPEC SHEET FOR MINIMUM SPACE REQUIRED
FOR 200W OR ABOVE: DO NOT USE THE LAMPS IN ENCLOSED FIXTURES
THE DIMENSION OF THE EXTERNAL DRIVER FOR 200-EXTR & 480V LAMPS IS 9.5"X2.5"X1.5"

HIGH-LUMEN LED CORN LAMP WITH UP LIGHT, 100-277V AC



CATALOG NO.	DESCRIPTION	WHILE SUPPLIES LAST	REPLACEMENT RANGE	PKG. QTY.
CL-HL-27W-30K-E26	27W 3510LM 3000K E26 H: 7.13" X D: 3.74"		50-70MH	12
CL-HL-45W-30K-E39	45W 5850LM 3000K E39 H: 10.20" X D: 3.74"		70-100MH	12
CL-HL-75W-30K-E39	75W 9750LM 3000K E39 H: 12.17" X D: 3.74"		70-125MH	12
CL-HL-100W-30K-E39	100W 13000LM 3000K E39 H: 9.88" X D: 5.75"		70-175MH	6
E26-ENLARGER	ENLARGES E26 (MED.), BASE TO BE USED IN E39 (MOGUL) SOCKET			6
E39-REDUCER	REDUCES E39 (MOGUL), BASE TO BE USED IN E26 (MED.) SOCKET			6

LED 180 DEGREE FLAT HID RETROFIT LAMP



CATALOG NO.	DESCRIPTION	PKG. QTY.
CL-FLT-36-54W-50K-E39	36W/45W/54W 150LM/W 5000K Flat	6
CL-FLTW-54-75W-50K-E39	54W/63W/75W 150LM/W 5000K Adjustable	6
CL-FLTW-75-110W-50K-E39	75W/97W/110W 150LM/W 5000K Adjustable	6



HIGH-PERFORMANCE HIGH BAY LAMP, POWER & CCT ADJUSTABLE



CATALOG NO.	DESCRIPTION	PKG. QTY.
HBL-80-120W-MCT-E39	80W/100W/120W 150LM/W 30K/40K/50K E39 Mogul Base	4
HBL-120-160W-MCT-E39	120W/140W/160W 150LM/W 30K/40K/50K E39 Mogul Base	4



LED HIGH POWER LAMPS, 120-277V



CATALOG NO.	DESCRIPTION	PKG. QTY.
HPL-16W-30K-E26	16W 2000LM 3000K E26 Medium Base WHILE SUPPLIES LAST	20
HPL-16W-50K-E26	16W 2000LM 5000K E26 Medium Base WHILE SUPPLIES LAST	20
HPL-20W-30K-E26	20W 2500LM 3000K E26 Medium Base	20
HPL-20W-50K-E26	20W 2500LM 5000K E26 Medium Base	20
HPL-24W-30K-E26	24W 3000LM 3000K E26 Medium Base WHILE SUPPLIES LAST	20
HPL-32W-30K-E26	32W 4000LM 3000K E26 Medium Base	20
HPL-32W-50K-E26	32W 4000LM 5000K E26 Medium Base	20
HPL-34W-30K-E26	34W 4250LM 3000K E26 Medium Base	12
HPL-34W-50K-E26	34W 4250LM 5000K E26 Medium Base	12
HPL-HB-60W-50K-E39	60W 6480LM 5000K E39 Mogul Base WHILE SUPPLIES LAST	4
HPL-HB-75W-50K-E39	75W 8100LM 5000K E39 Mogul Base WHILE SUPPLIES LAST	4
HPL-HB-100W-50K-E39	100W 12500LM 5000K E39 Mogul Base WHILE SUPPLIES LAST	4
HPL-HB-140W-50K-E39	140W 15120LM 5000K E39 Mogul Base WHILE SUPPLIES LAST	4
HPL-HB-R1	Optional PC Reflector for HPL-HB-60W	12
HPL-HB-R2	Optional PC Reflector for HPL-HB-75W	8
HPL-HB-R3	Optional PC Reflector for HPL-HB-120W & HPL-HB-140W	8

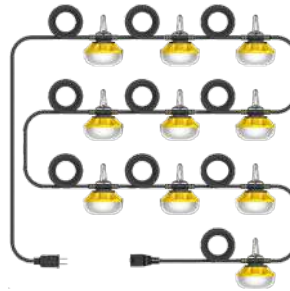

2WIRE ECONOMY CONSTRUCTION STRING LIGHT



CATALOG NO.	DESCRIPTION	ARRIVES THIS SEASON CHECK & PRE-ORDER	PKG. QTY.
CL-CONST-50FT-50W-2WIRE	5X10W 6000LM 5000K 50FT		1
CL-CONST-100FT-50W-2WIRE	10X10W 12000LM 5000K 100FT		1

LED CONSTRUCTION / TEMPORARY LIGHT WITH SOCKET FOR LINKING MULTIPLE UNITS



CATALOG NO.	DESCRIPTION	EQUIVALENCY	PKG. QTY.
CL-CONST-40W-50K	40W 4800LM 5000K 6FT CORD WITH 15A 3 PRONG STRAIGHT BLADE PLUG	400 MH	1
CL-CONST-100W-50K	100W 12000LM 5000K 6FT CORD WITH 15A 3 PRONG STRAIGHT BLADE PLUG	400 MH	1





COMMERCIAL INDOOR LIGHTING







LED BACKLIT PANEL LIGHT, 100-277VAC

**NO PARTIAL
MUST BUY IN QTY OF FOUR**

MCTP: MULTI COLOR TEMPERATURE
& MULTI POWER



	CATALOG NO.	DESCRIPTION	PKG. QTY.
2X2	 LPNG-2X2-4KLM-40K-D	40W 4400LM 4000K	4
	LPNG-2X2-4KLM-35K-D	40W 4200LM 3500K WHILE SUPPLIES LAST	4
	LPNG-2X2-4KLM-27K-D	40W 3800LM 2700K	4
	LPNG-2X2-MCTP4 MCTP	20/30/40W 3000K/3500K/4000K/5000K	4
2X4	 LPNG-2X4-4KLM-50K-D	40W 4200LM 5000K WHILE SUPPLIES LAST	4
	LPNG-2X4-4KLM-40K-D	40W 4200LM 4000K	4
	LPNG-2X4-5KLM-50K-D	50W 5250LM 5000K WHILE SUPPLIES LAST	4
	LPNG-2X4-5KLM-40K-D	50W 5200LM 4000K WHILE SUPPLIES LAST	4
	LPNG-2X4-5KLM-35K-D	50W 5140LM 3500K WHILE SUPPLIES LAST	4
	LPNG-2X4-5KLM-27K-D	50W 4800LM 2700K WHILE SUPPLIES LAST	4
	LPNG-2X4-MCTP4 MCTP	30/40/50W 3000K/3500K/4000K/5000K	4
2X4	 LPNG-2X4-6KLM-50K-D	60W 6600LM 5000K	4
	LPNG-2X4-6KLM-40K-D	60W 6600LM 4000K	4
	LPNG-2X4-6KLM-35K-D	60W 6300LM 3500K	4
	LPNG-2X4-6KLM-27K-D	60W 5700LM 2700K	4
2X4	 LPNG-2X4-7KLM-50K-D	60W 7920LM 5000K	4
	LPNG-2X4-7KLM-40K-D	60W 7920LM 4000K	4
	LPNG-2X4-7KLM-35K-D	60W 7560LM 3500K	4
	LPNG-2X4-7KLM-27K-D	60W 6500LM 2700K WHILE SUPPLIES LAST	4
1X4	 LPNG-1X4-4KLM-50K-D	40W 4400LM 5000K	4
	LPNG-1X4-4KLM-27K-D	40W 3800LM 2700K WHILE SUPPLIES LAST	4
	LPNG-1X4-MCTP MCTP	20/30/40W 3500K/4000K/5000K	4
	LPNG-1X4-MCTP4 MCTP	20/30/40W 3000K/3500K/4000K/5000K	4

COMMERCIAL
FLAT
PANELS



FACTORY-INSTALLED OPTIONS, ENTER DESIRED OPTION CODE(S) AS LINE ITEMS ON YOUR PURCHASE ORDER UNDER THE PRODUCT CATALOG NUMBER















WATTS	EM OPTION	DESCRIPTION	FLEX WHIP	DESCRIPTION	PAINT	SENSOR	DESCRIPTION
ALL	OPT-EM-LPNG	EXTERNAL	OPT-FWH-63	6FT 3-Wire Whip	OPT-CLR-LPNG	OPT-SEN-2MDR-36	PROGRAMMABLE MICROWAVE BI-LEVEL
	PLUG IN CORD	DESCRIPTION	OPT-FWH-65	6FT 5-Wire Whip		WEC-3RC	REMOTE CONTROL
	OPT-HBC-125TL-BK	8FT, 15A, 125V, BLACK	OPT-FWH-66	6FT 6-Wire Whip			
	OPT-HBC-277TL-BK	8FT, 15A, 277V, BLACK					
	OPT-HBC-125SB-BK	10FT, 15A, 125V, 18/3STR, BLCK					

PREMIUM FLAT PANELS, 125 LM/W, POWER AND WATTAGE SELECTABLE

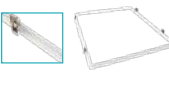

CATALOG NO.	DESCRIPTION
 LPNP-2X2-4KLM-MCTP	20W/30W/35W 125LM/W 35K/40K/50K
LPNP-1X4-4KLM-MCTP	20W/30W/35W 125LM/W 35K/40K/50K
LPNP-2X4-5KLM-MCTP	30W/35W/40W 125LM/W 35K/40K/50K

ACCESSORIES FOR PANEL LIGHTS

CATALOG NO.	DESCRIPTION
 LPNG-SRFC-2X2	Surface mounting kit for 2X2 panel EXCLUSIVE SCREWLESS DESIGN
 LPNG-SRFC-2X4	Surface mounting kit for 2X4 panel EXCLUSIVE SCREWLESS DESIGN
 LPNG-SRFC-1X4	Surface mounting kit for 1X4 panel EXCLUSIVE SCREWLESS DESIGN
 LTRE-2X2-SMK	Designer Surface mounting kit for 2X2 panel
 LTRE-2X4-SMK	Designer Surface mounting kit for 2X4 panel
 LTRE-1X4-SMK	Designer Surface mounting kit for 1X4 panel
 SCL-GSY10	Adj. 10FT 1/16" double suspension kit with Y end and heavy-duty locking hook, loop gripper on top
 SCL-GSY20	Adj. 20FT 1/16" double suspension kit with Y end and heavy-duty locking hook, loop gripper on top
 LPNG-RMK-1X4	1x4' Recessed Mounting Flange Kit for installation in hard ceilings and surfaces
 LPNG-RMK-2X2	2x2' Recessed Mounting Flange Kit for installation in hard ceilings and surfaces
 LPNG-RMK-2X4	2x4' Recessed Mounting Flange Kit for installation in hard ceilings and surfaces
 ELB-2048-EXTR	Field-installed emergency ballast; Input voltage: 100-277VAC, 50-60Hz; Input power: 4.8W (max); Output voltage: 12V-48VDC; Output power: 20W (max) Emergency operation: >90 mins.; Use w/ up to 60W LED fixtures; 20% lumens required by UL in power failure for FACTORY-INSTALLED OPTION see above.
 LPNG-EMMB	Emergency Battery Mounting Bracket for 2x2 & 2x4 Panels-Allows backup unit installation on top of panel(Recommended for EM Installations on 2X2 & 2X4)
 LPNG-EMMB-1X4	Emergency Battery Mounting Bracket for 1X4 Panels-Allows backup unit installation on top of panel

T-BAR GRID LIGHT (FRAME LIGHT) REMOTE DRIVER

MCTP: MULTI COLOR TEMPERATURE & MULTI POWER



CATALOG NO.	DESCRIPTION	PKG. QTY.
 TGL-2X2-MCTP	27W/35W/40W 150LM/W 3500K/4000K/5000K	10
 TGL-2X4-MCTP	35W/45W/54W 150LM/W 3500K/4000K/5000K	10
 ELB-TBAR1	T-BAR BRACKET FOR MOUNTING THE REMOTE DRIVER	-

SINGLE CCT T-BAR GRID LIGHTS



CATALOG NO.	DESCRIPTION	PKG. QTY.
 TGL-2X4-30K	60W 6000LM 3000K	10

WHILE SUPPLIES LAST



FACTORY-INSTALLED OPTIONS, ENTER DESIRED OPTION CODE(S) AS LINE ITEMS ON YOUR PURCHASE ORDER UNDER THE PRODUCT CATALOG NUMBER

WATTS	FLEX WHIP	DESCRIPTION	PAINT	SENSOR	DESCRIPTION
ALL MODELS	OPT-EM-TGL EXTERNAL	OPT-FWH-63 6FT 3-Wire Whip	N/A	N/A	N/A

PREMIUM HIGH-OUTPUT LED PANELS, 125LM/W



2X4

CATALOG NO.	DESCRIPTION	PKG. QTY.
 LP-2X4-50W-50K-D-HL	50W 6260LM 5000K	2
 LP-2X4-50W-40K-D-HL	50W 6260LM 4000K	2

WHILE SUPPLIES LAST

FACTORY-INSTALLED OPTIONS, ENTER DESIRED OPTION CODE(S) AS LINE ITEMS ON YOUR PURCHASE ORDER UNDER THE PRODUCT CATALOG NUMBER

WATTS	EM OPTION	DESCRIPTION	FLEX WHIP	DESCRIPTION	PAINT	SENSOR	DESCRIPTION
ALL MODELS	OPT-EM-LP	EXTERNAL	OPT-FWH-63	6FT 3-Wire Whip	N/A	N/A	N/A
			OPT-FWH-65	6FT 5-Wire Whip			
			OPT-FWH-66	6FT 6-Wire Whip			



5CCT EDGE-LESS ARCHITECTURAL FLUSH MOUNT



		ARRIVES THIS SEASON CHECK & PRE-ORDER			PKG. QTY.
CATALOG NO.	DESCRIPTION				
 FEL-R6-MCT5	10W 700LM 27K/30K/35K/40K/50K				20
 FEL-R8-MCT5	15W 1050LM 27K/30K/35K/40K/50K				10
 FEL-R10-MCT5	20W 1400LM 27K/30K/35K/40K/50K				10
 FEL-R12-MCT5	25W 1750LM 27K/30K/35K/40K/50K				5
 FEL-R14-MCT5	30W 2100LM 27K/30K/35K/40K/50K				5
 FEL-1X2-MCT5	30W 2100LM 27K/30K/35K/40K/50K				3
 FEL-1X4-MCT5	60W 4200LM 27K/30K/35K/40K/50K				3

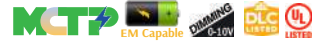























POWER & CCT ADJUSTABLE INTERNAL-DRIVER LED SURFACE/RECESSED MOUNT PANELS



CATALOG NO.	DESCRIPTION	PKG. QTY.
 LPS-2X2-20-40W-MCTP-D	20W/33W/40W 100LM/W 30K/40K/50K	1
 LPS-2X4-30-50W-MCTP-D	30W/40W/50W 100LM/W 30K/40K/50K	1
 LPS-1X4-20-40W-MCTP-D	20W/33W/40W 100LM/W 30K/40K/50K	1

INTERNAL-DRIVER LED SURFACE MOUNT PANELS, (1X4 & LARGER CAN BE RECESS MOUNT)



CATALOG NO.	DESCRIPTION	PKG. QTY.
 LPS-S4-50K-D	10W 700LM 5000K 4" Square 120VAC	20
 LPS-S4-40K-D	10W 700LM 4000K 4" Square 120VAC	20
 LPS-S4-30K-D	10W 700LM 3000K 4" Square 120VAC	20
 LPS-S6-50K-D	12W 900LM 5000K 6" Square 120VAC	20
 LPS-S6-40K-D	12W 900LM 4000K 6" Square 120VAC	20
 LPS-S6-30K-D	12W 900LM 3000K 6" Square 120VAC	20
 LPS-S8-50K-D	16W 1280LM 5000K 8" Square 120VAC	20
 LPS-S8-40K-D	16W 1280LM 4000K 8" Square 120VAC	20
 LPS-S8-30K-D	16W 1280LM 3000K 8" Square 120VAC	20
 LPS-1X1-50K-D	18W 1700LM 5000K 1' X 1' 120-277VAC	16
 LPS-1X1-40K-D	18W 1700LM 4000K 1' X 1' 120-277VAC	16
 LPS-1X1-30K-D	18W 1700LM 3000K 1' X 1' 120-277VAC	16
 LPS-1X2-50K-D	25W 2500LM 5000K 1' X 2' 120-277VAC	8
 LPS-1X2-40K-D	25W 2500LM 4000K 1' X 2' 120-277VAC	8
 LPS-1X2-30K-D	25W 2500LM 3000K 1' X 2' 120-277VAC	8
 LPS-1X4-50K-D	40W 4000LM 5000K 1' X 4' 120-277VAC WHILE SUPPLIES LAST	1
 LPS-1X4-40K-D	40W 4000LM 4000K 1' X 4' 120-277VAC WHILE SUPPLIES LAST	1
 LPS-2X2-50K-D	40W 4400LM 5000K 2' X 2' 120-277VAC WHILE SUPPLIES LAST	1
 LPS-2X2-40K-D	40W 4400LM 4000K 2' X 2' 120-277VAC	1
 LPS-2X2-30K-D	40W 4400LM 3000K 2' X 2' 120-277VAC	1
 LPS-2X4-50K-D	50W 5500LM 5000K 2' X 4' 120-277VAC WHILE SUPPLIES LAST	1
 LPS-2X4-40K-D	50W 5500LM 4000K 2' X 4' 120-277VAC WHILE SUPPLIES LAST	1
 LPS-2X4-30K-D	50W 5500LM 3000K 2' X 4' 120-277VAC	1
 LPS-JBOX	Junction Box for 1 X 4, 2 X 2, 2 X 4 LPS T-Bar installation	

1X1
1X2
1X4
2X2
2X4

COMMERCIAL
FLAT
PANELS



FACTORY-INSTALLED OPTIONS, ENTER DESIRED OPTION CODE(S) AS LINE ITEMS ON YOUR PURCHASE ORDER UNDER THE PRODUCT CATALOG NUMBER

WATTS	FLEX WHIP	DESCRIPTION	EM OPTION	DESCRIPTION	PAINT	SENSOR	DESCRIPTION
ALL MODELS	OPT-FWH-63	6FT 3-Wire Whip	OPT-EM-LPS	EXTERNAL	N/A	N/A	N/A
	OPT-FWH-65	6FT 5-Wire Whip					
	OPT-FWH-66	6FT 6-Wire Whip					



BUILDER SERIES POWER & CCT- ADJUSTABLE STACK TROFFER REQUIRES 1 MINUTE ASSEMBLY

NO PARTIAL
MUST BUY IN PKG. QTY.



CATALOG NO.	DESCRIPTION	PKG. QTY.
LTRS-2X2-MCTP	25W/35W/36W/40W 125LM/W 3500K/4000K/5000K	6
LTRS-2X4-MCTP	30W/40W//45W/50W 125LM/W 3500K/4000K/5000K	6
LTRS-1X4-MCTP	25W/35W/36W/40W 125LM/W 3500K/4000K/5000K	4
ELB-18150-B	Field-Installed Battery Back Up: 20W MAX, 175VDC, Li-ion 4000mAh	



SPEC SERIES LED SELECTABLE COLOR TEMP. & WATTAGE TROFFERS, AC 100-277V

NO PARTIAL
MUST BUY IN QTY OF TWO



CATALOG NO.	DESCRIPTION	PKG. QTY.
LTRE-2X2-MCTP	26W, 32W, 40W 125LM/W 3500K, 4000K, 5000K	2
LTRE-2X4-MCTP	32W, 40W, 50W 125LM/W 3500K, 4000K, 5000K	2
LTRE-1X4-MCTP	26W, 32W, 40W 125LM/W 3500K, 4000K, 5000K	2
LTRE-2X2-SMK	Surface mounting kit for LTRE-2X2	-
LTRE-2X4-SMK	Surface mounting kit for LTRE-2X4	-
LTRE-1X4-SMK	Surface mounting kit for LTRE-1X4	-

FOR RECESSED MOUNTING FLANGE KIT (LPNG-RMK) SEE PAGE NO. 72

FACTORY-INSTALLED OPTIONS, ENTER DESIRED OPTION CODE(S) AS LINE ITEMS ON YOUR PURCHASE ORDER UNDER THE PRODUCT CATALOG NUMBER

WATTS	EM OPTION	DESCRIPTION	FLEX WHIP	DESCRIPTION	PAINT	SENSOR	DESCRIPTION
ALL MODELS	OPT-EM-LTRE	MOUNTED ON TOP	OPT-FWH-63	6FT 3-Wire Whip	N/A	OPT-SEN-2MDR-36	PROGRAMMABLE MICROWAVE BI-LEVEL
	Ribbed LENS OPTION	DESCRIPTION	OPT-FWH-65	6FT 5-Wire Whip		WEC-3RC	REMOTE CONTROL
	OPT-2X2-RL	Ribbed LENS FOR 2X2	OPT-FWH-66	6FT 6-Wire Whip			
	OPT-2X4-RL	Ribbed LENS FOR 2X4					



SPEC SERIES ARCHITECTURAL TROFFER, BACK-LIT LED DESIGN POWER & CCT SELECTABLE

NO PARTIAL
MUST BUY IN QTY OF FOUR



CATALOG NO.	DESCRIPTION	PKG. QTY.
LTRB-2X2-MCTP	25W/30W/35W 110LM/W 35K/40K/50K	4
LTRB-2X4-MCTP	30W/40W/50W 110LM/W 35K/40K/50K	4
LTRB-1X4-MCTP	25W/30W/35W 110LM/W 35K/40K/50K	4

FACTORY-INSTALLED OPTIONS, ENTER DESIRED OPTION CODE(S) AS LINE ITEMS ON YOUR PURCHASE ORDER UNDER THE PRODUCT CATALOG NUMBER

WATTS	EM OPTION	DESCRIPTION	FLEX WHIP	DESCRIPTION	PAINT	SENSOR	DESCRIPTION
ALL MODELS	OPT-EM-LTRB	EXTERNAL	OPT-FWH-63	6FT 3-Wire Whip	OPT-CLR-LPNG	OPT-SEN-2MDR-36	MICROWAVE BI-LEVEL
	PLUG IN CORD	DESCRIPTION	OPT-FWH-65	6FT 5-Wire Whip		WEC-3RC	REMOTE CONTROL
	OPT-HBC-125TL-BK	8FT, 15A, 125V, BLACK	OPT-FWH-66	6FT 6-Wire Whip			
	OPT-HBC-277TL-BK	8FT, 15A, 277V, BLACK					
	OPT-HBC-125SB-BK	10FT, 15A, 125V, 18/3STR, BLCK					

PREMIUM HIGH-LUMEN RETROFIT FLAT PANEL

NO PARTIAL
MUST BUY IN PKG. QTY.



CATALOG NO.	DESCRIPTION	ARRIVES THIS SEASON CHECK & PRE-ORDER		PKG. QTY.
LRP-HL-2X2-MCTP	16W/20W/24W	125LM/W	35K/40K/50K	2
LRP-HL-2X4-MCTP	24W/30W/40W	125LM/W	35K/40K/50K	2



PREMIUM HIGH-LUMEN RETROFIT TROFFER-POWER & CCT ADJUSTABLE



CATALOG NO.	DESCRIPTION	ARRIVES THIS SEASON CHECK & PRE-ORDER		PKG. QTY.
LRT-HL-2X2-MCTP	15W/20W/25W	125LM/W	35K/40K/50K	2
LRT-HL-2X4-MCTP	30W/40W/50W	125LM/W	35K/40K/50K	2



SPEC SERIES LED SELECTABLE COLOR TEMP. & WATTAGE DUAL LENS TROFFER LIGHTS



CATALOG NO.	DESCRIPTION	PKG. QTY.
LTRD-2X2-MCTP	25W/30W/35W 125LM/W 3500K/4000K/5000K	1
LTRD-2X4-MCTP	30W/40W/50W 125LM/W 3500K/4000K/5000K	1

TO SURFACE MOUNT, SELECT LTRD-SMK KITS FROM THE LTRD SERIES ABOVE



FACTORY-INSTALLED OPTIONS, ENTER DESIRED OPTION CODE(S) AS LINE ITEMS ON YOUR PURCHASE ORDER UNDER THE PRODUCT CATALOG NUMBER

WATTS	EM OPTION	DESCRIPTION	FLEX WHIP	DESCRIPTION	PAINT	SENSOR	DESCRIPTION
ALL MODELS	OPT-EM-LTRD	MOUNTED ON TOP	OPT-FWH-63	6FT 3-Wire Whip	N/A	OPT-SEN-2MDR-36	PROGRAMMABLE MICROWAVE BI-LEVEL
			OPT-FWH-65	6FT 5-Wire Whip		WEC-3RC	REMOTE CONTROL
			OPT-FWH-66	6FT 6-Wire Whip			



Perforated fixture

LED DIRECT-INDIRECT (METAL HOUSING+PC LENS) TROFFERS, AC 100-277V, 110LM/W PERFORATED BASKET & SURFACE MOUNTING OPTIONS AVAILABLE



CATALOG NO.	DESCRIPTION	PKG. QTY.
LTR-2X2-40W-40K-D	40W 428LM 4000K 24" x 24" x 3-1/8"	1
LTR-2X4-50W-35K-D	50W 5590LM 3500K 24" x 48" x 3-1/5"	1
LTR-2X4-50W-40K-D	50W 5590LM 4000K 24" x 48" x 3-1/5"	1
LTR-2X4-50W-50K-D	50W 5702LM 5000K 24" x 48" x 3-1/5"	1
LTR-2X2-40W-40K-D-PERF	40W 428LM 4000K 24" x 24" x 3-1/8" Perforated Basket Incl.	1
LTR-2X4-50W-35K-D-PERF	50W 5590LM 3500K 24" x 48" x 3-1/5" Perforated Basket Incl.	1
LTR-2X4-50W-40K-D-PERF	50W 5590LM 4000K 24" x 48" x 3-1/5" Perforated Basket Incl.	1
LTR-2X4-50W-50K-D-PERF	50W 5702LM 5000K 24" x 48" x 3-1/5" Perforated Basket Incl.	1



FACTORY-INSTALLED OPTIONS, ENTER DESIRED OPTION CODE(S) AS LINE ITEMS ON YOUR PURCHASE ORDER UNDER THE PRODUCT CATALOG NUMBER

WATTS	EM OPTION	DESCRIPTION	FLEX WHIP	DESCRIPTION	PAINT	SENSOR	DESCRIPTION
ALL MODELS	OPT-EM-LTR	MOUNTED ON TOP	OPT-FWH-63	6FT 3-Wire Whip	N/A	OPT-SEN-2MDR-36	PROGRAMMABLE MICROWAVE BI-LEVEL
			OPT-FWH-65	6FT 5-Wire Whip		WEC-3RC	REMOTE CONTROL
			OPT-FWH-66	6FT 6-Wire Whip			

DURABLE (PC BODY) TROFFER LIGHTS, 140LM/W



2X2

CATALOG NO.	DESCRIPTION	WHILE SUPPLIES LAST	PKG. QTY.
LTRP-2X2-35W-50K-D	35W 4900LM 5000K		1



FACTORY-INSTALLED OPTIONS, ENTER DESIRED OPTION CODE(S) AS LINE ITEMS ON YOUR PURCHASE ORDER UNDER THE PRODUCT CATALOG NUMBER

WATTS	EM OPTION	DESCRIPTION	FLEX WHIP	DESCRIPTION	PAINT	SENSOR	DESCRIPTION
ALL MODELS	OPT-EM-LTRP	MOUNTED ON TOP	OPT-FWH-63	6FT 3-Wire Whip	N/A	OPT-SEN-2MDR-36	PROGRAMMABLE MICROWAVE BI-LEVEL
			OPT-FWH-65	6FT 5-Wire Whip		WEC-3RC	REMOTE CONTROL
			OPT-FWH-66	6FT 6-Wire Whip			



SCXA2-4FT-40W-MCTP-BB
UGR25 50D FULL OPTIC



SCXA2-4FT-40W-MCTP-CD-BB
UGR25 50D COMBINED DISTRIBUTION
OPTIC + PC LENS

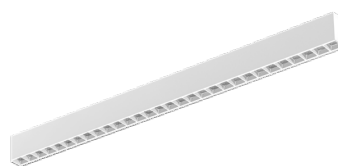

SCXA2-4FT-40W-MCTP-WW
UGR25 50D FULL OPTIC

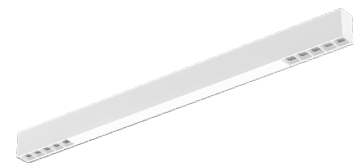

SCXA2-4FT-40W-MCTP-CD-WW
UGR25 50D COMBINED DISTRIBUTION
OPTIC + PC LENS

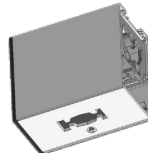

SCX2-TRACK-H

ARCHITECTURAL 2" OPTIC & COMBINED-DISTRIBUTION LINEAR

CATALOG NO.	DESCRIPTION	ARRIVES THIS SEASON CHECK & PRE-ORDER	PKG. QTY.
SCXA2-4FT-40W-MCTP-CD-BB	20W/30W/40W 100LM/W 30K/35K/40K 7.5" Optic Ends		6
SCXA2-4FT-40W-MCTP-CD-WW	20W/30W/40W 100LM/W 30K/35K/40K 7.5" Optic Ends		6
SCXA2-6FT-60W-MCTP-CD-BB	40W/50W/60W 100LM/W 30K/35K/40K 15" Optic Ends		4
SCXA2-6FT-60W-MCTP-CD-WW	40W/50W/60W 100LM/W 30K/35K/40K 15" Optic Ends		4
SCXA2-8FT-80W-MCTP-CD-BB	60W/70W/80W 100LM/W 30K/35K/40K 23" Optic Ends		4
SCXA2-8FT-80W-MCTP-CD-WW	60W/70W/80W 100LM/W 30K/35K/40K 23" Optic Ends		4
SCXA2-4FT-40W-MCTP-BB	20W/30W/40W 100LM/W 30K/35K/40K		6
SCXA2-4FT-40W-MCTP-WW	20W/30W/40W 100LM/W 30K/35K/40K		6
SCXA2-6FT-60W-MCTP-BB	40W/50W/60W 100LM/W 30K/35K/40K		4
SCXA2-6FT-60W-MCTP-WW	40W/50W/60W 100LM/W 30K/35K/40K		4
SCXA2-8FT-80W-MCTP-BB	60W/70W/80W 100LM/W 30K/35K/40K		4
SCXA2-8FT-80W-MCTP-WW	60W/70W/80W 100LM/W 30K/35K/40K		4
SCX2-TRACK-H-BK	SCXA2 Tack Light Socket End Extension H-Type Black		
SCX2-TRACK-H-WH	SCXA2 Tack Light Socket End Extension H-Type White		
SCXA2-BCP-4FT-WH	SCXA2 4Ft Blank Cover-Plate Accessory White		
SCXA2-BCP-6FT-WH	SCXA2 6Ft Blank Cover-Plate Accessory White		
SCXA2-BCP-8FT-WH	SCXA2 8Ft Blank Cover-Plate Accessory Wh		
SCXA2-RLS-UGR10-50D-WH	SCXA2 UGR10 50D Reflector Accessory White		
SCXA2-RLS-UGR10-70D-WH	SCXA2 UGR10 70D Reflector Accessory White		

UGR OPTIC LENS

CATALOG NO.	DESCRIPTION
OPT-SCXA2-4FT-WH-50D	UGR Less Than 10, 50D Optic, White
OPT-SCXA2-4FT-WH-70D	UGR Less Than 10, 70D Optic, White
OPT-SCXA2-4FT-BK-50D	UGR Less Than 10, 50D Optic, Black
OPT-SCXA2-4FT-BK-70D	UGR Less Than 10, 70D Optic, Black
OPT-SCXA2-6FT-WH-50D	UGR Less Than 10, 50D Optic, White
OPT-SCXA2-6FT-WH-70D	UGR Less Than 10, 70D Optic, White
OPT-SCXA2-6FT-BK-50D	UGR Less Than 10, 50D Optic, Black
OPT-SCXA2-6FT-BK-70D	UGR Less Than 10, 70D Optic, Black
OPT-SCXA2-8FT-WH-50D	UGR Less Than 10, 50D Optic, White
OPT-SCXA2-8FT-WH-70D	UGR Less Than 10, 70D Optic, White
OPT-SCXA2-8FT-BK-50D	UGR Less Than 10, 50D Optic, Black
OPT-SCXA2-8FT-BK-70D	UGR Less Than 10, 70D Optic, Black



COMMERCIAL
LINEAR
LIGHTS

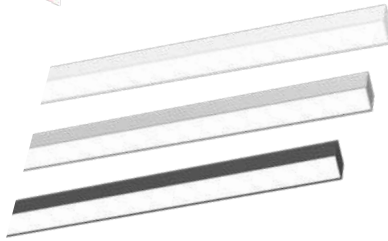

SCE-SB

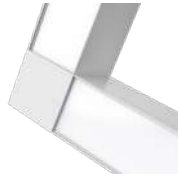

SCE-LB



SCE-TB

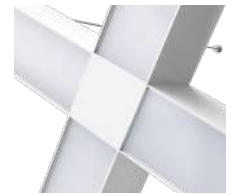

SCE-XB

BUILDER SERIES POWER & CCT- ADJUSTABLE LINEAR LIGHT



DESCRIPTION	PKG. QTY.
SCE-4FT-40W-MCTP-D 30W/35W/40W 110LM/W 3500K/4000K/5000K White	8
SCE-4FT-40W-MCTP-D-BK 30W/35W/40W 110LM/W 3500K/4000K/5000K Black	8
SCE-4FT-40W-MCTP-D-SIL 30W/35W/40W 110LM/W 3500K/4000K/5000K Silver	8
SCE-6FT-50W-MCTP-D 40W/45W/50W 110LM/W 3500K/4000K/5000K White	6
SCE-6FT-50W-MCTP-D-BK 40W/45W/50W 110LM/W 3500K/4000K/5000K Black	6
SCE-6FT-50W-MCTP-D-SIL 40W/45W/50W 110LM/W 3500K/4000K/5000K Silver	6
SCE-ULM-4FT-MCTP-D 4Ft SCE Series Uplight Module 35/40/50K Transfers 30% Power To Top	
SCE-ULM-6FT-MCTP-D 6Ft SCE Series Uplight Module 35/40/50K Transfers 30% Power To Top	
SCE-SB SCE Series Straight Linking Bracket - Creates a Seamless Connection	
SCE-TB SCE Series T Linking Bracket	
SCE-LB SCE Series L Linking Bracket	
SCE-XB SCE Series X Linking Bracket	
SCE-SB-BK SCE Series Straight Linking Bracket - Creates a Seamless Connection, Black	
SCE-TB-BK SCE Series T Linking Bracket, Black	
SCE-LB-BK SCE Series L Linking Bracket, Black	
SCE-XB-BK SCE Series X Linking Bracket, Black	
SCE-SB-SIL SCE Series Straight Linking Bracket - Creates a Seamless Connection, Silver	
SCE-TB-SIL SCE Series T Linking Bracket, Silver	
SCE-LB-SIL SCE Series L Linking Bracket, Silver	
SCE-XB-SIL SCE Series X Linking Bracket, Silver	
SCE-4FT-PCLENS SCE 4FT Series PC Lens	
SCE-6FT-PCLENS SCE 6FT Series PC Lens	

FOR SUSPENSION KIT SEE PAGES 90 TO 93

FACTORY-INSTALLED OPTIONS, ENTER DESIRED OPTION CODE(S) AS LINE ITEMS ON YOUR PURCHASE ORDER UNDER THE PRODUCT CATALOG NUMBER

WATTS	EM OPTION	DESCRIPTION	PHOTOCELL	DESCRIPTION	PAINT	SENSOR	DESCRIPTION
ALL MODELS	OPT-EM-SCE	INTERNAL		N/A	N/A	N/A	N/A



POWER & CCT- ADJUSTABLE LINEAR LIGHT, 120-277V, IP66 WET LOCATION



CATALOG NO.	DESCRIPTION	PKG. QTY.
SCX4-IP66-SUR-4FT-40-80W-MCTP	40W/60W/80W 105LM/W 35K/40K/50K Surface Mounted	4
SCX4-IP66-SUR-8FT-80-160W-MCTP	80W/120W/160W 105LM/W 35K/40K/50K Surface Mounted	2
SCX4-IP66-SUS-4FT-40-80W-MCTP	40W/60W/80W 105LM/W 35K/40K/50K Suspended	4
SCX4-IP66-SUS-8FT-80-160W-MCTP	80W/120W/160W 105LM/W 35K/40K/50K Suspended	2
SCX4-IP66-ACPT-6FT	SCX4-IP66 6Ft Ac Pigtail With Female Wet Loc. Connector	
SCX4-IP66-ACPT-10FT	SCX4-IP66 10Ft Ac Pigtail With Female Wet Loc. Connector	
SCX4-IP66-JUMP-6IN	SCX4-IP66 6In Ac Jump Cable With Male And Female Wet Loc. Connector	
SCX4-IP66-JUMP-12IN	SCX4-IP66 12In Ac Jump Cable With Male And Female Wet Loc. Connector	
SCX4-IP66-CB	SCX4-IP66 Coupling Bracket	
SCX4-IP66-RODKIT-18IN	SCX4-IP66 18In Suspension Rod Kit	
SCX4-IP66-RODKIT-24IN	SCX4-IP66 24In Suspension Rod Kit	
SCX4-IP66-SCBK	SCX4-IP66 Bracket Set For Suspension With Aircraft Cable	

FOR SUSPENSION KIT (SCL-GS210 & SCL-GS220) SEE PAGES 100











*MCT4: MULTI COLOR TEMPERATURE
(3000K, 3500K, 4000K, 5000K)





SCX-1FT-10W-MCT4-D	N/A	N/A	N/A	N/A
SCX-2FT-20W-MCT4-D	SCX-2FT-20W-MCT4-D-REG	SCX-2FT-20W-MCT4-D-LUV	SCX-2FT-20W-MCT4-D-LUV-WH	SCX-2FT-20W-MCT4-D-DL
SCX-3FT-30W-MCT4-D	SCX-3FT-30W-MCT4-D-REG	SCX-3FT-30W-MCT4-D-LUV	SCX-3FT-30W-MCT4-D-LUV-WH	SCX-3FT-30W-MCT4-D-DL
SCX-4FT-40W-MCT4-D	SCX-4FT-40W-MCT4-D-REG	SCX-4FT-40W-MCT4-D-LUV	SCX-4FT-40W-MCT4-D-LUV-WH	SCX-4FT-40W-MCT4-D-DL
SCX-6FT-60W-MCT4-D	SCX-6FT-60W-MCT4-D-REG	SCX-6FT-60W-MCT4-D-LUV	SCX-6FT-60W-MCT4-D-LUV-WH	SCX-6FT-60W-MCT4-D-DL
SCX-8FT-80W-MCT4-D	SCX-8FT-80W-MCT4-D-REG	SCX-8FT-80W-MCT4-D-LUV	SCX-8FT-80W-MCT4-D-LUV-WH	SCX-8FT-80W-MCT4-D-DL

COMMERCIAL
LINEAR
LIGHTS

 UPLIGHT FOR SCX SERIES AND THEIR VARIANTS				
2FT	3FT	4FT	6FT	8FT
OPT-SCX-ULM-2FT-8W-MCT4	OPT-SCX-ULM-3FT-12W-MCT4	OPT-SCX-ULM-4FT-16W-MCT4	OPT-SCX-ULM-6FT-24W-MCT4	OPT-SCX-ULM-8FT-32W-MCT4

MODULES FOR SCX SERIES				
6in Module  SCX-6IN-MCT4	9in Module  SCX-9IN-MCT4	L Module  SCX-L-MCT4	T Module  SCX-T-MCT4	X Module  SCX-X-MCT4
Inside Corner Module  SCX-IC-MCT4	Outside Corner Module  SCX-OC-MCT4	Y Module  SCX-Y-MCT4	120° Corner  SCX-C120-MCT4	C60 Module  SCX-C60-MCT4



SCX-2FT-20W-MCT4-D-DLP	SCX-2FT-20W-MCT4-D-IND	SCX-2FT-20W-MCT4-D-IDL	SCX-L1FT-20W-MCT4	SCX-Y2FT-60W-MCT4-D
N/A	SCX-3FT-30W-MCT4-D-IND	SCX-3FT-30W-MCT4-D-IDL	SCX-L2FT-40W-MCT4	 UPLIGHT OPT-SCX-ULM-Y2FT-24W-MCT4
SCX-4FT-40W-MCT4-D-DLP	SCX-4FT-40W-MCT4-D-IND	SCX-4FT-40W-MCT4-D-IDL	 UPLIGHT OPT-SCX-ULM-L2FT-16W-MCT4	
N/A	SCX-6FT-60W-MCT4-D-IND	SCX-6FT-60W-MCT4-D-IDL		
N/A	SCX-8FT-80W-MCT4-D-IND	SCX-8FT-80W-MCT4-D-IDL		
 UPLIGHT OPT-SCX-ULM-2FT-8W-MCT4				
N/A				
OPT-SCX-ULM-4FT-16W-MCT4				
N/A				
N/A				

COMMERCIAL
LINEAR
LIGHTS

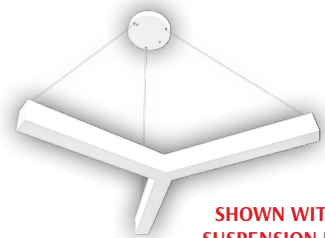

SHOWN WITH
SUSPENSION KIT

SCL-3CS10

ADJ. 10FT 1/16in TRIPLE-CABLE
SUSPENSION CANOPY KIT WITH
KEYHOLE END CONNECTORS
(NO CORD INCL.)

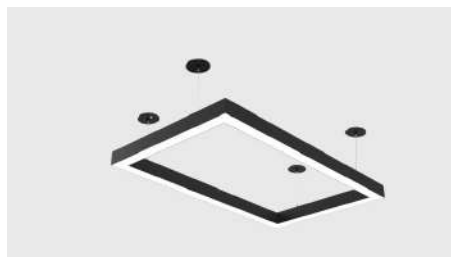

MADE USING
SCX + L CORNERS

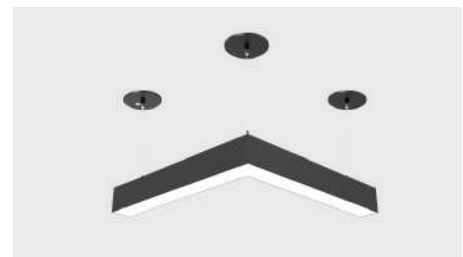

SCX-L2FT-40W-MCT4
INSTALLED

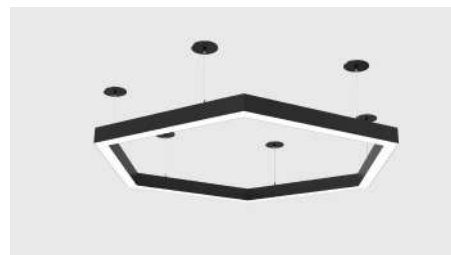

MADE USING
SCX + C120 CORNERS



SCX-Y2FT-60W-MCT4
INSTALLED

*MCT4: MULTI COLOR TEMPERATURE
(3000K, 3500K, 4000K, 5000K)



SCX

SUPERIOR ARCHITECTURAL
SEAMLESS LINKABLE LINEAR LIGHTING SYSTEM

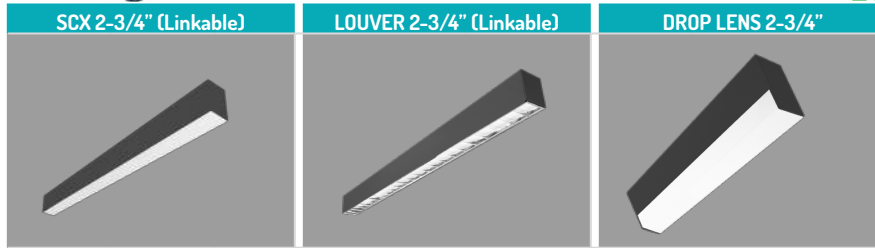

SCX MODELS	SCX 2-3/4" (Linkable)	LOUVER 2-3/4" (Linkable)	DROP LENS 2-3/4"
1FT BLACK 10W & 110LM/W	SCX-1FT-10W-MCT4-D-BK	N/A	N/A
2FT BLACK 20W & 110LM/W	SCX-2FT-20W-MCT4-D-BK	SCX-2FT-20W-MCT4-D-LUV-BK	SCX-2FT-20W-MCT4-D-DL-BK
3FT BLACK 30W & 110LM/W	SCX-3FT-30W-MCT4-D-BK	SCX-3FT-30W-MCT4-D-LUV-BK	SCX-3FT-30W-MCT4-D-DL-BK
4FT BLACK 40W & 110LM/W	SCX-4FT-40W-MCT4-D-BK	SCX-4FT-40W-MCT4-D-LUV-BK	SCX-4FT-40W-MCT4-D-DL-BK
6FT BLACK 60W & 110LM/W	SCX-6FT-60W-MCT4-D-BK	SCX-6FT-60W-MCT4-D-LUV-BK	SCX-6FT-60W-MCT4-D-DL-BK
8FT BLACK 80W & 110LM/W	SCX-8FT-80W-MCT4-D-BK	SCX-8FT-80W-MCT4-D-LUV-BK	SCX-8FT-80W-MCT4-D-DL-BK

COMMERCIAL
LINEAR
LIGHTS

UPLIGHT FOR SCX BLACK SERIES AND THEIR VARIANTS				
2FT	3FT	4FT	6FT	8FT
OPT-SCX-U LM-2FT-8W-MCT4-BK	OPT-SCX-U LM-3FT-12W-MCT4-BK	OPT-SCX-U LM-4FT-16W-MCT4-BK	OPT-SCX-U LM-6FT-24W-MCT4-BK	OPT-SCX-U LM-8FT-32W-MCT4-BK

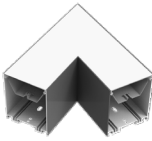
MODULES FOR SCX BLACK SERIES				
<p>6in Module</p>  <p>SCX-6IN-MCT4-BK</p>	<p>9in Module</p>  <p>SCX-9IN-MCT4-BK</p>	<p>L Module</p>  <p>SCX-L-MCT4-BK</p>	<p>T Module</p>  <p>SCX-T-MCT4-BK</p>	<p>X Module</p>  <p>SCX-X-MCT4-BK</p>
<p>Inside Corner Module</p>  <p>SCX-IC-MCT4-BK</p>	<p>Y Module</p>  <p>SCX-Y-MCT4-BK</p>	<p>120° Corner</p>  <p>SCX-C120-MCT4-BK</p>	<p>C60 Module</p>  <p>SCX-C60-MCT4-BK</p>	

*MCT4: MULTI COLOR TEMPERATURE
(3000K, 3500K, 4000K, 5000K)



SCX

SUPERIOR ARCHITECTURAL
SEAMLESS LINKABLE LINEAR LIGHTING SYSTEM



SCX 4FT. Only



1FT 10W & 110LM/W	SCX4-1FT-10W-MCT4-D	SCX4-1FT-10W-MCT4-D-LUV-WH	N/A	N/A
2FT 20W & 110LM/W	SCX4-2FT-20W-MCT4-D	SCX4-2FT-20W-MCT4-D-LUV-WH	SCX4-2FT-20W-MCT-D-IDL	SCX4-2FT-20W-MCT4-WSH
3FT 30W & 110LM/W	SCX4-3FT-30W-MCT4-D	SCX4-3FT-30W-MCT4-D-LUV-WH	SCX4-3FT-30W-MCT-D-IDL	SCX4-3FT-30W-MCT4-WSH
4FT 40W & 110LM/W	SCX4-4FT-40W-MCT4-D	SCX4-4FT-40W-MCT4-D-LUV-WH	SCX4-4FT-40W-MCT-D-IDL	SCX4-4FT-40W-MCT4-WSH
6FT 60W & 110LM/W	SCX4-6FT-60W-MCT4-D	SCX4-6FT-60W-MCT4-D-LUV-WH	SCX4-6FT-60W-MCT-D-IDL	N/A
8FT 80W & 110LM/W	SCX4-8FT-80W-MCT4-D	SCX4-8FT-80W-MCT4-D-LUV-WH	SCX4-8FT-80W-MCT-D-IDL	N/A

COMMERCIAL
LINEAR
LIGHTS

UPLIGHT FOR SCX4 SERIES AND THEIR VARIANTS				
2FT	3FT	4FT	6FT	8FT
OPT-SCX-ULM-2FT-8W-MCT4	OPT-SCX-ULM-3FT-12W-MCT4	OPT-SCX-ULM-4FT-16W-MCT4	OPT-SCX-ULM-6FT-24W-MCT4	OPT-SCX-ULM-8FT-32W-MCT4

MODULES FOR SCX4 SERIES				
<p>L Module</p> <p>SCX4-L-MCT4</p>	<p>T Module</p> <p>SCX4-T-MCT4</p>	<p>X Module</p> <p>SCX4-X-MCT4</p>	<p>Inside Corner</p> <p>SCX4-IC-MCT4</p>	

SCX

SUPERIOR ARCHITECTURAL

SEAMLESS LINKABLE LINEAR LIGHTING SYSTEM



COMMERCIAL
LINEAR LIGHTS

1FT 10W & 110LM/W	SCX2-1FT-10W-MCT4-D	SCX2-1FT-10W-MCT4-D-TR	N/A	N/A
2FT 20W & 110LM/W	SCX2-2FT-20W-MCT4-D	SCX2-2FT-20W-MCT4-D-TR	SCX6-2FT-20- 30W-MCTP	SCX6-2FT-20- 30W-MCTP-LUV-WH
3FT 30W & 110LM/W	SCX2-3FT-30W-MCT4-D	SCX2-3FT-30W-MCT4-D-TR	SCX6-3FT-30- 45W-MCTP	SCX6-3FT-30- 45W-MCTP-LUV-WH
4FT 40W & 110LM/W	SCX2-4FT-40W-MCT4-D	SCX2-4FT-40W-MCT4-D-TR	SCX6-4FT-40- 60W-MCTP	SCX6-4FT-40- 60W-MCTP-LUV-WH
6FT 60W & 110LM/W	SCX2-6FT-60W-MCT4-D	SCX2-6FT-60W-MCT4-D-TR	SCX6-6FT-60- 90W-MCTP	SCX6-6FT-60- 90W-MCTP-LUV-WH
8FT 80W & 110LM/W	SCX2-8FT-80W-MCT4-D	SCX2-8FT-80W-MCT4-D-TR	SCX6-8FT-80- 120W-MCTP	SCX6-8FT-80- 120W-MCTP-LUV-WH

⚙️ UPLIGHT FOR SCX2 SERIES AND THEIR VARIANTS				
2FT	3FT	4FT	6FT	8FT
OPT-SCX-ULM-2FT-8W-MCT4	OPT-SCX-ULM-3FT-12W-MCT4	OPT-SCX-ULM-4FT-16W-MCT4	OPT-SCX-ULM-6FT-24W-MCT4	OPT-SCX-ULM-8FT-32W-MCT4

⚙️ UPLIGHT FOR SCX6 SERIES AND THEIR VARIANTS				
2FT	3FT	4FT	6FT	8FT
OPT-SCX6-ULM-2FT-8W-MCT4	OPT-SCX6-ULM-3FT-12W-MCT4	OPT-SCX6-ULM-4FT-16W-MCT4	OPT-SCX6-ULM-6FT-24W-MCT4	OPT-SCX6-ULM-8FT-32W-MCT4

MODULES FOR SCX2 & SCX6 SERIES









<p>L Module</p> <p>SCX2-L-MCT4</p>	<p>T Module</p> <p>SCX2-T-MCT4</p>	<p>X Module</p> <p>SCX2-X-MCT4</p>	<p>Inside Corner Module</p> <p>SCX2-IC-MCT4</p>	<p>Outside Corner Module</p> <p>SCX2-OC-MCT4</p>
<p>C60 Module</p> <p>SCX2-C60-MCT4</p>	<p>T Module</p> <p>SCX6-L-MCTP</p>	<p>X Module</p> <p>SCX6-T-MCTP</p>	<p>Inside Corner Module</p> <p>SCX6-X-MCTP</p>	<p>Outside Corner Module</p> <p>SCX6-IC-MCTP</p>

SCX

SUPERIOR ARCHITECTURAL

SEAMLESS LINKABLE LINEAR LIGHTING SYSTEM

SCO SERIES	SCXT-DL	SCXT-FL	SCXR (Linkable)
 <p>4ft MCT</p> <p>MCT: MULTI COLOR TEMPERATURE (3500K, 4000K, 5000K)</p>	 <p>See Next Page for More Info</p> <p><small>ORDER ONE DRIVER PER FIXTURE (NOT INCLUDED)</small></p>	 <p>See Next Page for More Info</p> <p><small>ORDER ONE DRIVER PER FIXTURE (NOT INCLUDED)</small></p>	

SCO-4FT-40W-MCT-BB	SCXT-2FT-10-20W-MCTP-D-DL	SCXT-2FT-10-20W-MCTP-D-FL	N/A
	SCXT-4FT-20-40W-MCTP-D-DL	SCXT-4FT-20-40W-MCTP-D-FL	SCXR-4FT-40W-MCT4-D
SCO-4FT-40W-MCT-WB	SCXT-8FT-40-80W-MCTP-D-DL	SCXT-8FT-40-80W-MCTP-D-FL	SCXR-8FT-80W-MCT4-D
<p>7 DAYS LEAD TIME</p> 	 UPLIGHT FOR SCXT-DL OPT-SCXT-ULM-2FT-MCTP	 UPLIGHT FOR SCXT-FL OPT-SCXT-ULM-2FT-MCTP	 UPLIGHT FOR SCXR N/A
SCO-4FT-40W-MCT-WW	OPT-SCXT-ULM-4FT-MCTP	OPT-SCXT-ULM-4FT-MCTP	OPT-SCX-ULM-4FT-16W-MCT4
<p>7 DAYS LEAD TIME</p> 	OPT-SCXT-ULM-8FT-MCTP	OPT-SCXT-ULM-8FT-MCTP	OPT-SCX-ULM-8FT-32W-MCT4
	SCXT-DL 2FT L FIXTURE	SCXT-FL 2FT L FIXTURE	CORNER OPTION
SCO-4FT-40W-MCT-BW	 <p><small>ORDER ONE DRIVER PER FIXTURE (NOT INCLUDED)</small></p>	 <p><small>ORDER ONE DRIVER PER FIXTURE (NOT INCLUDED)</small></p>	
	SCXT-L2FT-20-40W-MCTP-D-DL	SCXT-L2FT-20-40W-MCTP-D-FL	SCXR-LNL

COMMERCIAL
LINEAR LIGHTS

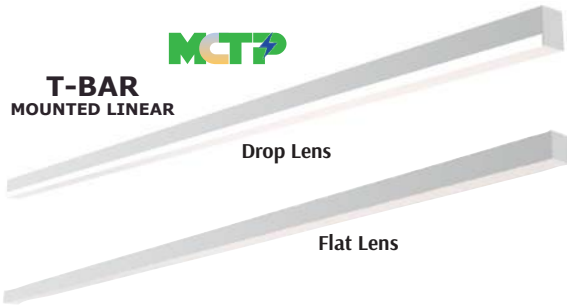

SCXT INSTALLED ON T-BAR CEILING
DRIVER MOUNTED ON TOP



SCXT SUSPENDED



2 SCXT-L2FT INSTALLED
ON T-BAR CEILING

With T-BAR clips, ready to install on the grid
Can also be suspended or surface mounted
Can be linked (with endcaps on, not seamless) coupling bracket incl.
With remote driver box, avail. 40W & 80W (sold separately) do not exceed max wattage of driver
Each fixture supplied with 6FT RJ11 cable, which plugs into the driver box
Driver box has 4 RJ11 Female sockets

EXTERNAL DRIVER (ORDER SEPARATELY)

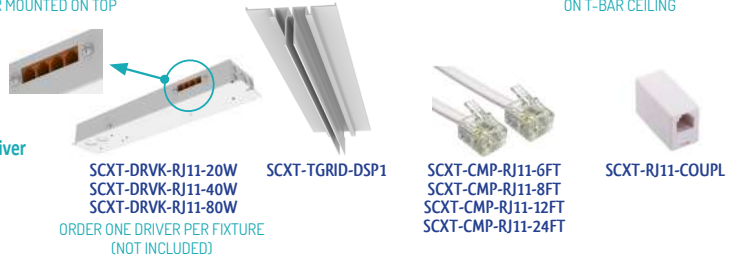

ORDER ONE DRIVER PER FIXTURE
(NOT INCLUDED)

1" WIDE LINEAR SERIES FOR DIRECT T-GRID MOUNTING OR SUSPENSION, POWER & CCT ADJ.



CATALOG NO.	DESCRIPTION
SCXT-2FT-10-20W-MCTP-D-DL	20W 110LM/W 30K/35K/40K 2FT, Drop Lens, Can Adj. to 75% or 50%
SCXT-4FT-20-40W-MCTP-D-DL	40W 110LM/W 30K/35K/40K 4FT, Drop Lens, Can Adj. to 75% or 50%
SCXT-8FT-40-80W-MCTP-D-DL	80W 110LM/W 30K/35K/40K 8FT, Drop Lens, Can Adj. to 75% or 50%
SCXT-L2FT-20-40W-MCTP-D-DL	40W 110LM/W 30K/35K/40K 2FT, L-Shape, Drop Lens, Can Adj. to 75% or 50%
SCXT-2FT-10-20W-MCTP-D-FL	20W 110LM/W 30K/35K/40K 2FT, Flat Lens, Can Adj. to 75% or 50%
SCXT-4FT-20-40W-MCTP-D-FL	40W 110LM/W 30K/35K/40K 4FT, Flat Lens, Can Adj. to 75% or 50%
SCXT-8FT-40-80W-MCTP-D-FL	80W 110LM/W 30K/35K/40K 8FT, Flat Lens, Can Adj. to 75% or 50%
SCXT-L2FT-20-40W-MCTP-D-FL	40W 110LM/W 30K/35K/40K 2FT, L-Shape, Flat Lens, Can Adj. to 75% or 50%
OPT-SCXT-ULM-2FT-MCTP	2Ft Uplighting Factory-Installed Adder Option - Directs 30% Of Power To Up
OPT-SCXT-ULM-4FT-MCTP	4Ft Uplighting Factory-Installed Adder Option - Directs 30% Of Power To Up
OPT-SCXT-ULM-8FT-MCTP	8Ft Uplighting Factory-Installed Adder Option - Directs 30% Of Power To Up
SCXT-DRVK-RJ11-20W	SCXT Series 20W Driver Kit With Power & CCT Selection Switches
SCXT-DRVK-RJ11-40W	SCXT Series 40W Driver Kit With Power & CCT Selection Switches
SCXT-DRVK-RJ11-80W	SCXT Series 80W Driver Kit With Power & CCT Selection Switches
SCXT-TGRID-DSP1	SCXT Series T-Grid Driver Support Platform For Up To 80W Driver Kit
SCXT-CMP-RJ11-6FT	Comm. Multi-Purp. Extension Cable With RJ11 Ends - 6Ft
SCXT-CMP-RJ11-8FT	Comm. Multi-Purp. Extension Cable With RJ11 Ends - 8Ft
SCXT-CMP-RJ11-12FT	Comm. Multi-Purp. Extension Cable With RJ11 Ends - 12Ft
SCXT-CMP-RJ11-24FT	Comm. Multi-Purp. Extension Cable With RJ11 Ends - 24Ft
SCXT-RJ11-COUP	RJ11 Coupling Female To Female

FACTORY-INSTALLED OPTIONS, ENTER DESIRED OPTION CODE(S) AS LINE ITEMS ON YOUR PURCHASE ORDER UNDER THE PRODUCT CATALOG NUMBER

WATTS	EM OPTION	DESCRIPTION	PHOTOCELL	DESCRIPTION	PAINT	SENSOR	DESCRIPTION
SCXT	OPT-EM-SCXT	EXTERNAL		N/A	OPT-CLR-SCXT-2FT(BK/GR/SR/WH) OPT-CLR-SCXT-4FT(BK/GR/SR/WH) OPT-CLR-SCXT-8FT(BK/GR/SR/WH) OPT-CLR-SCXT-L2FT(BK/GR/SR/WH)	N/A	N/A



**SHOWN WITH
RECESSED MOUNTING FLANGES
SEE OPTION ON PAGE 88**



**SHOWN WITH
SUSPENSION KIT**



SCL-4CS10

ADJ. 10FT 1/16in QUAD CABLE SUSP.
CANOPY KIT, KEYHOLE CONNECTORS
(NO CORD INCL.)

2.75IN SCX 2X2 & 2X4 LINEAR LIGHT



CATALOG NO.	DESCRIPTION	PKG. QTY.
SCX-2X2-40-80W-MCTP	40W/60W/80W 110LM/W 30K/35K/40K/50K	1
SCX-2X4-60-120W-MCTP	60W/90W/120W 110LM/W 30K/35K/40K/50K	1



**1 QUARTER CIRCLE
SHOWN WITH SUSPENSION KITS**



CREATED WITH 4 QUARTER CIRCLES



**CREATED WITH 4 QUARTER CIRCLES
SHOWN WITH SUSPENSION KIT**



SCL-3CS10

ADJ. 10FT 1/16in TRIPLE-CABLE
SUSPENSION CANOPY KIT WITH
KEYHOLE END CONNECTORS
(NO CORD INCL.)

SCX QUARTER OF CIRCLE 4CCT



CATALOG NO.	DESCRIPTION	PKG. QTY.
SCXC-Q24-10W-MCT4	10W 1100LM 30K/35K/40K/50K 24"	1
SCXC-Q36-20W-MCT4	20W 2200LM 30K/35K/40K/50K 36"	1
SCXC-Q48-25W-MCT4	25W 2750LM 30K/35K/40K/50K 48"	1



SCX-2X2-20W-MCT4-D-DIP
White



SCX-2X2-20W-MCT4-D-DIP-LUV
White



SCX-2X4-20W-MCT4-D-DIP
White



SCX-2X4-20W-MCT4-D-DIP-LUV
White

ARCHITECTURAL DROP IN T-BAR LIGHTS, 120-277V



CATALOG NO.	DESCRIPTION
SCX-2X2-20W-MCT4-D-DIP	20W 110LM/W 30K/35K/40K/50K 2X2
SCX-2X2-20W-MCT4-D-DIP-LUV	20W 110LM/W 30K/35K/40K/50K 2X2 Louver version
SCX-2X4-60W-MCT4-D-DIP	60W 110LM/W 30K/35K/40K/50K 2X4
SCX-2X4-60W-MCT4-D-DIP-LUV	60W 110LM/W 30K/35K/40K/50K 2X4 Louver version

SCXR ACCESSORIES

CATALOG NO.	DESCRIPTION
SCXR-LK-1FT-GRILL	SCXR 1Ft Section PC Louver Kit Without Lens
SCXR-LK-1FT-LENSONROLL	SCXR 1Ft Film On Roll Of 853Ft, Must Use With SCXR-LK



WALL MOUNTING ARMS (ADD-ON OPTION, DOES NOT INCLUDE FIXTURE)

CATALOG NO.	DESCRIPTION
-------------	-------------

ADD THIS OPTION TO THE FIXTURE AND WALL MOUNTING ARMS WITH WALL CANOPY WILL BE INSTALLED ON BACK OF FIXTURE. THE LENGTH OF EACH ARM IS 5'. CONNECTION CABLES WILL ENTER THE FIXTURE THROUGH ONE OF THE ARMS. ON YOUR PURCHASE ORDER SPECIFY THE POSITION OF YOUR WIRE ENTRY FROM THE WALL AND THE ARM WILL BE INSTALLED ON THE BACK ACCORDINGLY.

OPT-SCX-WMA-1FT	1FT
OPT-SCX-WMA-2FT	2FT
OPT-SCX-WMA-3FT	3FT
OPT-SCX-WMA-4FT	4FT
OPT-SCX-WMA-6FT	6FT
OPT-SCX-WMA-8FT	8FT



WALL MOUNTING (ADD-ON OPTION, DOES NOT INCLUDE FIXTURE)

CATALOG NO.	DESCRIPTION
-------------	-------------

ADD THIS OPTION TO THE FIXTURE AND WALL MOUNTING BRACKETS WILL BE INSTALLED ON BACK OF FIXTURE. CONNECTION CABLES WILL ENTER THE FIXTURE THROUGH ONE OF THESE WALL-MOUNTING BRACKETS. ON YOUR PURCHASE ORDER SPECIFY THE POSITION OF YOUR WIRE ENTRY FROM THE WALL AND THE BRACKETS WILL BE INSTALLED ON THE BACK ACCORDINGLY.

OPT-SCX-WM-1FT	1FT
OPT-SCX-WM-2FT	2FT
OPT-SCX-WM-3FT	3FT
OPT-SCX-WM-4FT	4FT
OPT-SCX-WM-6FT	6FT
OPT-SCX-WM-8FT	8FT
OPT-SCXR-WM-4FT	4FT
OPT-SCXR-WM-8FT	8FT

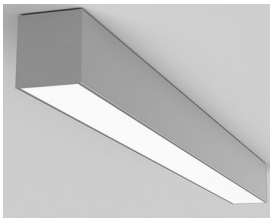

SURFACE MOUNTING

DESCRIPTION

YOU DO NOT NEED TO ORDER ANY ACCESSORIES.
SCREW AND ANCHOR KIT PROVIDED WITH EACH FIXTURE CAN BE USED TO FASTEN THE FIXTURE DIRECTLY TO THE HARD SURFACE THROUGH THE HOLES ON TOP OF THE FIXTURE.

NOT APPLICABLE TO INDIRECT SERIES



SCX CONTINUOUS FLEXIBLE LENS 25FT OR 100FT

CATALOG NO.	DESCRIPTION
-------------	-------------

SCX-FLEXLENS-25FT	25FT
SCX-FLEXLENS-100FT	100FT
SCX2-FLEXLENS-25FT	25FT
SCX2-FLEXLENS-100FT	100FT
SCX4-FLEXLENS-25FT	25FT
SCX4-FLEXLENS-100FT	100FT

SUSPENSION ROD KITS

CATALOG NO.	DESCRIPTION
-------------	-------------



SCL-RS-12	12 INCH	Set of 2
SCL-RS-18	18 INCH	Set of 2
SCL-RS-24	24 INCH	Set of 2
SCL-RS-36	36 INCH	Set of 2
SCL-RS-48	48 INCH	Set of 2

NOT APPLICABLE TO INDIRECT, SCXR SERIES

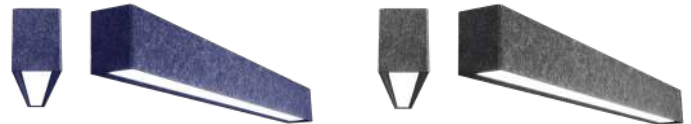

SCX INSTALLED ACOUSTIC OPTIONS

CATALOG NO.	DESCRIPTION
-------------	-------------

OPT-SCX-AK-2FT-9MM-HY2204	2FT
OPT-SCX-AK-4FT-9MM-HY2204	4FT
OPT-SCX-AK-6FT-9MM-HY2204	6FT
OPT-SCX-AK-8FT-9MM-HY2204	8FT
OPT-SCX-AK-2FT-9MM-HY2210	2FT
OPT-SCX-AK-4FT-9MM-HY2210	4FT
OPT-SCX-AK-6FT-9MM-HY2210	6FT
OPT-SCX-AK-8FT-9MM-HY2210	8FT
OPT-SCX4-AK-2FT-9MM-HY2204	2FT
OPT-SCX4-AK-4FT-9MM-HY2204	4FT
OPT-SCX4-AK-6FT-9MM-HY2204	6FT
OPT-SCX4-AK-8FT-9MM-HY2204	8FT
OPT-SCX4-AK-2FT-9MM-HY2210	2FT
OPT-SCX4-AK-4FT-9MM-HY2210	4FT
OPT-SCX4-AK-6FT-9MM-HY2210	6FT
OPT-SCX4-AK-8FT-9MM-HY2210	8FT



SCX-WK01



SCX2-WK02



MAPLE



WALNUT



FRENCH
OAK



EBONY



WOOD TRIMS

CATALOG NO.	DESCRIPTION
OPT-SCX2-WK02-2FT-MAPLE	2FT -MAPLE FINISH
OPT-SCX2-WK02-4FT-MAPLE	4FT -MAPLE FINISH
OPT-SCX2-WK02-6FT-MAPLE	6FT -MAPLE FINISH
OPT-SCX2-WK02-8FT-MAPLE	8FT -MAPLE FINISH
OPT-SCX2-WK02-2FT-WALNUT	2FT -WALNUT FINISH
OPT-SCX2-WK02-4FT-WALNUT	4FT -WALNUT FINISH
OPT-SCX2-WK02-6FT-WALNUT	6FT -WALNUT FINISH
OPT-SCX2-WK02-8FT-WALNUT	8FT -WALNUT FINISH
OPT-SCX2-WK02-2FT-FREOAK	2FT -FRENCH OAK FINISH
OPT-SCX2-WK02-4FT-FREOAK	4FT -FRENCH OAK FINISH
OPT-SCX2-WK02-6FT-FREOAK	6FT -FRENCH OAK FINISH
OPT-SCX2-WK02-8FT-FREOAK	8FT -FRENCH OAK FINISH
OPT-SCX2-WK02-2FT-EBONY	2FT -EBONY FINISH
OPT-SCX2-WK02-4FT-EBONY	4FT -EBONY FINISH
OPT-SCX2-WK02-6FT-EBONY	6FT -EBONY FINISH
OPT-SCX2-WK02-8FT-EBONY	8FT -EBONY FINISH
OPT-SCX-WK01-2FT-MAPLE	2FT -MAPLE FINISH
OPT-SCX-WK01-4FT-MAPLE	4FT -MAPLE FINISH
OPT-SCX-WK01-6FT-MAPLE	6FT -MAPLE FINISH
OPT-SCX-WK01-8FT-MAPLE	8FT -MAPLE FINISH
OPT-SCX-WK01-2FT-WALNUT	2FT -WALNUT FINISH
OPT-SCX-WK01-4FT-WALNUT	4FT -WALNUT FINISH
OPT-SCX-WK01-6FT-WALNUT	6FT -WALNUT FINISH
OPT-SCX-WK01-8FT-WALNUT	8FT -WALNUT FINISH
OPT-SCX-WK01-2FT-FREOAK	2FT -FRENCH OAK FINISH
OPT-SCX-WK01-4FT-FREOAK	4FT -FRENCH OAK FINISH
OPT-SCX-WK01-6FT-FREOAK	6FT -FRENCH OAK FINISH
OPT-SCX-WK01-8FT-FREOAK	8FT -FRENCH OAK FINISH
OPT-SCX-WK01-2FT-EBONY	2FT -EBONY FINISH
OPT-SCX-WK01-4FT-EBONY	4FT -EBONY FINISH
OPT-SCX-WK01-6FT-EBONY	6FT -EBONY FINISH
OPT-SCX-WK01-8FT-EBONY	8FT -EBONY FINISH

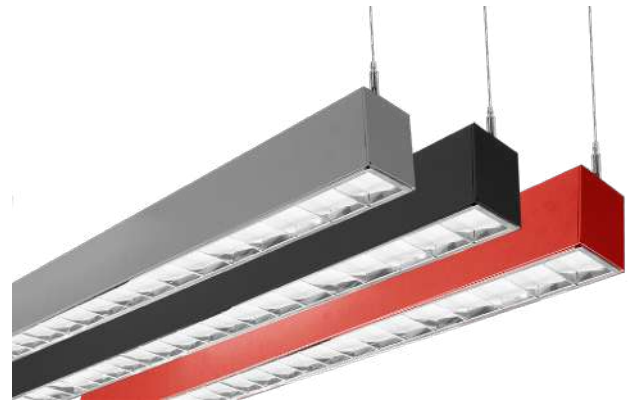

COLOR OF YOUR CHOICE

CATALOG NO.

ADD THIS OPTION TO THE FIXTURE AND SPECIFY YOUR DESIRED COLOR ON YOUR PURCHASE ORDER OR PROVIDE A SWATCH TO MATCH. FOR PAINTED FLANGED FIXTURES OR OPTIONAL ROD MOUNTING SET PLEASE ALSO ADD THE RELEVANT OPTION BELOW FOR EACH FIXTURE.

- OPT-CLR-SCX-1FT(BK/GR/SR/WH)
- OPT-CLR-SCX-2FT(BK/GR/SR/WH)
- OPT-CLR-SCX-3FT(BK/GR/SR/WH)
- OPT-CLR-SCX-4FT(BK/GR/SR/WH)
- OPT-CLR-SCX-6FT(BK/GR/SR/WH)
- OPT-CLR-SCX-8FT(BK/GR/SR/WH)
- OPT-CLR-SCX-FMR(BK/GR/SR/WH)
- OPT-CLR-SCX-RODSET(BK/GR/SR/WH)
- OPT-CLR-SCX-CORNERS(BK/GR/SR/WH)
- OPT-CLR-SCL-RS(BK/GR/SR/WH)

WALL MOUNTING ARMS (ADD-ON OPTION, DOES NOT INCLUDE FIXTURE)

CATALOG NO.

DESCRIPTION

ADD THIS OPTION TO THE FIXTURE AND WALL MOUNTING ARMS WITH WALL CANOPY WILL BE INSTALLED ON BACK OF FIXTURE. THE LENGTH OF EACH ARM IS 5". CONNECTION CABLES WILL ENTER THE FIXTURE THROUGH ONE OF THE ARMS. ON YOUR PURCHASE ORDER SPECIFY THE POSITION OF YOUR WIRE ENTRY FROM THE WALL AND THE ARM WILL BE INSTALLED ON THE BACK ACCORDINGLY.

- | | |
|-----------------|-----|
| OPT-SCX-WMA-1FT | 1FT |
| OPT-SCX-WMA-2FT | 2FT |
| OPT-SCX-WMA-3FT | 3FT |
| OPT-SCX-WMA-4FT | 4FT |
| OPT-SCX-WMA-6FT | 6FT |
| OPT-SCX-WMA-8FT | 8FT |

DEDICATED WIRING FOR UPLIGHT CONTROL

CATALOG NO.

DESCRIPTION

- | | |
|----------------------|-----|
| OPT-SCX-ULC-2FT-MCT4 | 2FT |
| OPT-SCX-ULC-3FT-MCT4 | 3FT |
| OPT-SCX-ULC-4FT-MCT4 | 4FT |
| OPT-SCX-ULC-6FT-MCT4 | 6FT |
| OPT-SCX-ULC-8FT-MCT4 | 8FT |

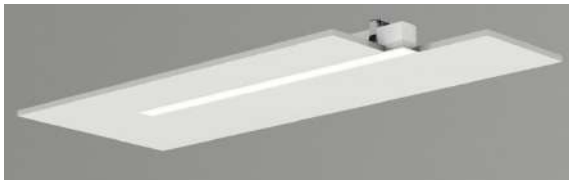

RECESSED MOUNT WITH FLANGE (ADD-ON OPTION, DOES NOT INCLUDE FIXTURE)

CATALOG NO. DESCRIPTION

ADD THIS OPTION TO THE FIXTURE AND THE FIXTURE WILL BE EQUIPPED WITH A 1/2" WIDE FLANGE ON FOUR SIDES. ADVANCED DESIGN TOGGLE STYLE BRACKETS WILL ALSO BE PROVIDED, TO ADJUST AND HOLD THE FIXTURE AGAINST DRYWALL OR OTHER HARD CEILING FROM THE TOP.
WHEN LINKING TO ANOTHER FIXTURE OR CORNER MODULE, CALL US OR SEND A COPY OF YOUR PLAN ALONG WITH YOUR PO AND FLANGES WILL BE REMOVED ON THOSE ENDS THAT NEED TO MAKE A SEAMLESS CONNECTIONS.

OPT-SCX-FMR-1FT	1FT
OPT-SCX-FMR-2FT	2FT
OPT-SCX-FMR-3FT	3FT
OPT-SCX-FMR-4FT	4FT
OPT-SCX-FMR-6FT	6FT
OPT-SCX-FMR-8FT	8FT
OPT-SCX-FMR-L	L
OPT-SCX-FMR-T	T
OPT-SCX-FMR-X	X
OPT-SCX-FMR-Y	Y
OPT-SCX-FMR-IC	INSIDE CORNER
OPT-SCX2-FMR-1FT	1FT
OPT-SCX2-FMR-2FT	2FT
OPT-SCX2-FMR-3FT	3FT
OPT-SCX2-FMR-4FT	4FT
OPT-SCX2-FMR-6FT	6FT
OPT-SCX2-FMR-8FT	8FT
OPT-SCX2-FMR-L	L
OPT-SCX2-FMR-T	T
OPT-SCX2-FMR-X	X
OPT-SCX2-FMR-Y	Y
OPT-SCX2-FMR-IC	INSIDE CORNER
OPT-SCX4-FMR-1FT	1FT
OPT-SCX4-FMR-2FT	2FT
OPT-SCX4-FMR-3FT	3FT
OPT-SCX4-FMR-4FT	4FT
OPT-SCX4-FMR-6FT	6FT
OPT-SCX4-FMR-8FT	8FT
OPT-SCX4-FMR-L	L
OPT-SCX4-FMR-T	T
OPT-SCX4-FMR-X	X
OPT-SCX4-FMR-Y	Y
OPT-SCX4-FMR-IC	INSIDE CORNER
OPT-SCX6-FMR-1FT	1FT
OPT-SCX6-FMR-2FT	2FT
OPT-SCX6-FMR-3FT	3FT
OPT-SCX6-FMR-4FT	4FT
OPT-SCX6-FMR-6FT	6FT
OPT-SCX6-FMR-8FT	8FT
OPT-SCX6-FMR-L	L
OPT-SCX6-FMR-T	T
OPT-SCX6-FMR-X	X
OPT-SCX6-FMR-Y	Y
OPT-SCX6-FMR-IC	INSIDE CORNER
OPT-SCX-FMR-2X2	2X2
OPT-SCX-FMR-2X4	2X4

NOT APPLICABLE TO INDIRECT, SCXR SERIES

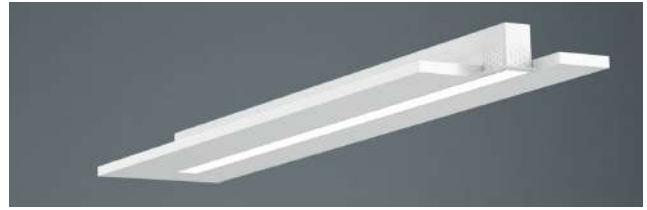

FLANGELESS RECESS MOUNT IN DRYWALL (MUD-IN) (ADD-ON OPTION, DOES NOT INCLUDE FIXTURE)

CATALOG NO. DESCRIPTION

ORDER THIS OPTION AND THE FIXTURE WILL BE EQUIPPED WITH MUD-IN BRACKETS ON ALL FOUR SIDES, MOUNTED AT 1/16" FROM THE LENS SURFACE (SPECIFY IF OTHER SPACING IS NEEDED).
WHEN LINKING TO ANOTHER FIXTURE OR CORNER FIXTURE MODULE CALL US OR SEND A COPY OF YOUR PLAN ALONG WITH YOUR PO AND FLANGES WILL BE REMOVED ON THOSE ENDS THAT NEED TO MAKE A SEAMLESS CONNECTION.

OPT-SCX-MIF-1FT	1FT
OPT-SCX-MIF-2FT	2FT
OPT-SCX-MIF-3FT	3FT
OPT-SCX-MIF-4FT	4FT
OPT-SCX-MIF-6FT	6FT
OPT-SCX-MIF-8FT	8FT
OPT-SCX-MIF-2X2	2X2
OPT-SCX-MIF-2X4	2X4
OPT-SCX-MIF-L	L
OPT-SCX-MIF-T	T
OPT-SCX-MIF-X	X

NOT APPLICABLE TO INDIRECT, SCXR SERIES



FLANGELESS RECESSED INSTALLATION IN WOOD CEILING

DESCRIPTION

YOU DO NOT NEED TO ORDER ANY ACCESSORIES.

MAKE RECESSED PREPARATIONS BY INSTALLING A HORIZONTAL PLANK OF WOOD ON TOP OF THE WOOD CEILING AT RECESSED HEIGHT OF 3-3/8".

SCREW AND ANCHOR KIT PROVIDED WITH EACH FIXTURE CAN BE USED TO FASTEN THE TOP OF THE FIXTURE TO THE WOOD PLANK THROUGH THE HOLES ON TOP OF THE FIXTURE.

YOU CAN ALSO INSTALL VERTICAL WOOD BOARDS ON TOP OF THE CEILING AT THE EDGE OF THE OPENING AND OPEN THE FIXTURE AND PUT SCREWS THROUGH THE SIDES OF THE FIXTURE HOUSING TO FASTEN IT TO THE WOOD BOARDS.

NOT APPLICABLE TO INDIRECT, SCXR SERIES



NOT APPLICABLE TO INDIRECT, SCXR SERIES

T-BAR INSTALLATION (ADD-ON OPTION, DOES NOT INCLUDE FIXTURE)

CATALOG NO.	DESCRIPTION
-------------	-------------

ADD THIS OPTION TO THE FIXTURE AND 1/2" WIDE FLANGES WILL BE INSTALLED ON THE TWO LONG SIDES OF THE FIXTURE.

THE TWO ENDS OF THE FIXTURE WILL FALL ONTO THE T-BAR GRIDS AND WILL BE SUPPORTED THIS WAY. THE T-BAR TILES ON THE TWO SIDES OF THE FIXTURE MUST BE CUT TO ALLOW FOR THE WIDTH OF THE FIXTURE. THE TILES WILL FALL ONTO AND BE SUPPORTED BY THE FLANGES ON BOTH SIDES OF THE FIXTURE. IF YOU PLAN TO SUPPORT THE FIXTURE BY THE GRIDS ON THREE SIDES AND TILE ON ONE SIDE, CALL US OR SPECIFY ON YOUR PO AND FLANGE WILL BE INSTALLED ONLY ON ONE SIDE OF THE FIXTURE.

TO PROVIDE SAFETY AND SUPPORT FROM THE BEAMS ABOVE THE T-BAR CEILING ORDER 10FT OR 20FT AIRCRAFT SUSPENSION KITS BELOW.

OPT-SCX-TBAR-1FT	1FT
OPT-SCX-TBAR-2FT	2FT
OPT-SCX-TBAR-4FT	4FT
OPT-SCX-TBAR-6FT	6FT
OPT-SCX-TBAR-8FT	8FT
OPT-SCX-TBAR-2X2	2X2
OPT-SCX-TBAR-2X4	2X4
OPT-FWH-63	6FT 3-WIRE FLEX WHIP
OPT-FWH-65	6FT 5-WIRE FLEX WHIP
OPT-FWH-66	6FT 6-WIRE FLEX WHIP

SCL-GS10	ADJ. 10FT 1/16in DOUBLE SUSPENSION CABLE WITH SINGLE KEYHOLE CONN., LOOP GRIPPER ON TOP
-----------------	---

SCL-GS20	ADJ. 20FT 1/16in DOUBLE SUSPENSION CABLE WITH SINGLE KEYHOLE CONN., LOOP GRIPPER ON TOP
-----------------	---

SCL-GSY110	ADJ. 10FT 1/16IN SINGLE SUSPENSION CABLE WITH Y HOOK ENDS, LOOP GRIPPER ON TOP
-------------------	--

SCL-GSY120	ADJ. 20FT 1/16IN SINGLE SUSPENSION CABLE WITH Y HOOK ENDS, LOOP GRIPPER ON TOP
-------------------	--



EMERGENCY BATTERY BACKUP

CATALOG NO.	DESCRIPTION
-------------	-------------

ADD THIS OPTION FOR 90-MINUTE BATTERY BACKUP INSTALLATION. IF ORDERING A SERIES OF THIS FIXTURE TO LINK, CALL US OR SPECIFY ON YOUR PURCHASE ORDER, ON WHICH FIXTURES TO INSTALL THE BACKUP AND WHERE YOU WOULD LIKE THE TEST BUTTONS.

OPT-EM-SCX	2FT, 3FT, 4FT, 6FT
OPT-EM-SCX-8FT	8FT
OPT-EM-SCX2	2FT, 3FT, 4FT, 6FT
OPT-EM-SCX2-8FT	8FT
OPT-EM-SCX4	2FT, 3FT, 4FT, 6FT
OPT-EM-SCX4-8FT	8FT
OPT-EM-SCX6	2FT, 3FT, 4FT, 6FT
OPT-EM-SCX6-8FT	8FT
OPT-EM-SCX-2X2-2X4	2X2, 2X4

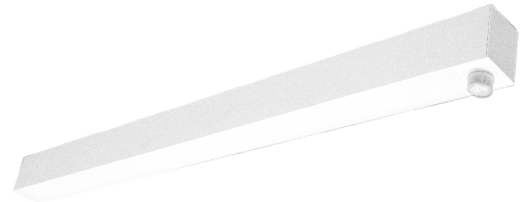

MICROWAVE BI-LEVEL MOTION SENSORS

CATALOG NO.	DESCRIPTION
-------------	-------------

THIS OPTION INSTALLS AN ADVANCED MOTION SENSOR THAT WILL TURN THE LIGHTS ON WHEN THE AREA IS OCCUPIED. WHEN THE AREA IS CLEARED, AFTER A PRESET HOLD TIME OF 5 SECONDS OR MORE, THE LIGHTS ARE DIMMED TO A STANDBY LEVEL OF 30% OR MORE. IF STILL NO MOTION IS DETECTED, AFTER THE STANDBY PERIOD, THE LIGHTS ARE TURNED OFF. ALL SETTINGS ARE PROGRAMMABLE WITH A REMOTE CONTROL.

OPT-SEN-SCX-3MRLV-5	PROGRAMMABLE MICROWAVE BI-LEVEL
OPT-SEN-SCXR	PROGRAMMABLE MICROWAVE BI-LEVEL FOR SCXR
WEC-8RC	OPTIONAL REMOTE CONTROL FOR SENSOR
OPT-SEN-2US-DAYLIGHT INTERNAL FOR ALL MODELS	ULTRASONIC BI-LEVEL DIMMING (REMOTE NOT NEEDED) DAYLIGHT SENSOR
OPT-SEN-SCX2	PROGRAMMABLE MICROWAVE BI-LEVEL
OPT-SEN-SCX4	PROGRAMMABLE MICROWAVE BI-LEVEL
OPT-SEN-SCX6	PROGRAMMABLE MICROWAVE BI-LEVEL
SCX-UVC-12W	SCX ANTIVIRUS UVC SECTION 12w 280nm UV LIGHT WITH REVERSE-LOGIC SENSOR
WEC-3RC	OPTIONAL REMOTE CONTROL FOR SENSOR



SLOT RECESSED COMMERCIAL LINEAR LIGHTS, 6" WIDE, CCT & WATTAGE SELECT

CATALOG NO.	DESCRIPTION	ARRIVES THIS SEASON CHECK & PRE-ORDER	PKG. QTY.
SRL6-2FT-MCTP	10W/15W/20W 110LM/W 35K/40K/50K		6
SRL6-4FT-MCTP	20W/30W/40W 110LM/W 35K/40K/50K		6
SRL6-8FT-MCTP	40W/60W/80W 110LM/W 35K/40K/50K		6

FACTORY-INSTALLED OPTIONS, ENTER DESIRED OPTION CODE(S) AS LINE ITEMS ON YOUR PURCHASE ORDER UNDER THE PRODUCT CATALOG NUMBER

SIZE	EM OPTION	DESCRIPTION	VANDAL RES.	DESCRIPTION	PAINT	SENSOR	DESCRIPTION
2FT, 4FT	OPT-EM-SRL6 OPT-EM-SRL6-8FT	EXTERNAL EXTERNAL		N/A	N/A	N/A	N/A

COMMERCIAL
SUSPENDED
LIGHTS

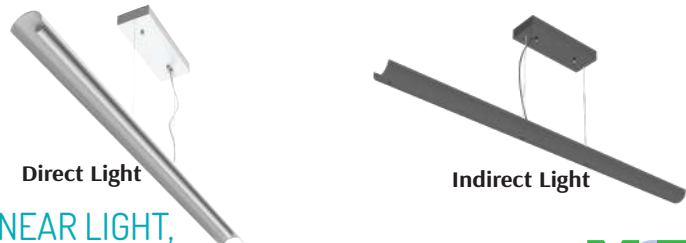

EURO-DESIGN SUSPENDED LINEAR LIGHT, POWER & CCT SELECTABLE DIRECT OR INDIRECT - REVERSIBLE



CATALOG NO.	DESCRIPTION	PKG. QTY.
SCP-4FT-20-30W-MCTP	20W/25W/30W 80LM/W 3000K/3500K/4000K	12
SCP-8FT-40-60W-MCTP	40W/50W/60W 80LM/W 3000K/3500K/4000K	12
SCP-4FT-20-30W-MCTP-BK	20W/25W/30W 80LM/W 3000K/3500K/4000K	12
SCP-8FT-40-60W-MCTP-BK	40W/50W/60W 80LM/W 3000K/3500K/4000K	12

FOR FACTORY-INSTALLED OPTIONS SEE BELOW



POWER & CCT- ADJUSTABLE LINEAR TUBE DECORATIVE SUSP. LIGHT



CATALOG NO.	DESCRIPTION	PKG. QTY.
SDTL-4FT-20-30W-MCTP	20W/25W/30W 105LM/W 30K/35K/40K White	4
SDTL-6FT-25-50W-MCTP	25W/40W/50W 105LM/W 30K/35K/40K White	4
SDTL-8FT-40-60W-MCTP	40W/50W/60W 105LM/W 30K/35K/40K White	4
SDTL-4FT-20-30W-MCTP-BK	20W/25W/30W 105LM/W 30K/35K/40K Black	4
SDTL-6FT-25-50W-MCTP-BK	25W/40W/50W 105LM/W 30K/35K/40K Black	4
SDTL-8FT-40-60W-MCTP-BK	40W/50W/60W 105LM/W 30K/35K/40K Black	4



POWER & CCT-ADJUSTABLE LED SUSPENDED FRAME FIXTURES, 120-277V



CATALOG NO.	DESCRIPTION	PKG. QTY.
SFL-4FT-60W-MCTP	40W/50W/60W 7000LM 30K/35K/40K White	4
SFL-4FT-60W-MCTP-BK	40W/50W/60W 7000LM 30K/35K/40K Black	4
SFL-4FT-60W-MCTP-GD	40W/50W/60W 7000LM 30K/35K/40K Gold	4



4Ft



SCLP-CB



SCLT-4FT

LED PARABOLIC SUSPENDED DOWN LIGHT, 120~277V

Aluminum Finish



CATALOG NO.	DESCRIPTION	PKG. QTY.
SCLP-4FT-40W-50K-D	40W 4600LM 5000K WHILE SUPPLIES LAST	2
SCLP-4FT-40W-35K-D	40W 4600LM 3500K WHILE SUPPLIES LAST	2
SCLP-4FT-40W-MCT-D	40W 4600LM 3500K/4000K/5000K MCT	2
SCLT-4FT-40W-50K-D	40W 4600LM 5000K WHILE SUPPLIES LAST	2
SCLT-4FT-40W-40K-D	40W 4600LM 4000K WHILE SUPPLIES LAST	2
SCLT-4FT-40W-35K-D	40W 4600LM 3500K WHILE SUPPLIES LAST	2
SCLT-4FT-40W-MCT-D	40W 4600LM 3500K/4000K/5000K MCT	2
SCLP-CB	COUPLING BRACKET	-



FACTORY-INSTALLED OPTIONS, ENTER DESIRED OPTION CODE(S) AS LINE ITEMS ON YOUR PURCHASE ORDER UNDER THE PRODUCT CATALOG NUMBER

WATTS	EM OPTION	DESCRIPTION	UP LIGHT	DESCRIPTION	PAINT	SENSOR	DESCRIPTION
ALL MODELS	OPT-EM-AC2EXT	EXTERNAL	OPT-SLCP-ULK	UP LIGHT 20W, MCT	N/A	OPT-SLCP-SURF	SURFACE-MOUNT



SCLP-UD-CB

LED PARABOLIC SUSPENDED PERH. BASKET & LOUVER UP/DOWN LIGHT, 120~277V

White



CATALOG NO.	DESCRIPTION	PKG. QTY.
SCLP-UD-4FT-60W-50K-D	40W/20W 4400LM/2100LM 5000K WHILE SUPPLIES LAST	1
SCLP-UD-4FT-60W-40K-D	40W/20W 4400LM/2100LM 4000K WHILE SUPPLIES LAST	1
SCLP-UD-4FT-60W-35K-D	40W/20W 4400LM/2100LM 3500K WHILE SUPPLIES LAST	1
SCLP-UD-4FT-60W-MCT-D	40W/20W 4400LM/2100LM 3500K/4000K/5000K MCT	1
SCLP-UD-CB	COUPLING BRACKET	-

SUSPENSION KIT & CABLE NOT INCLUDED SEE PAGES 100 TO 103, FOR FACTORY-INSTALLED OPTIONS SEE BELOW

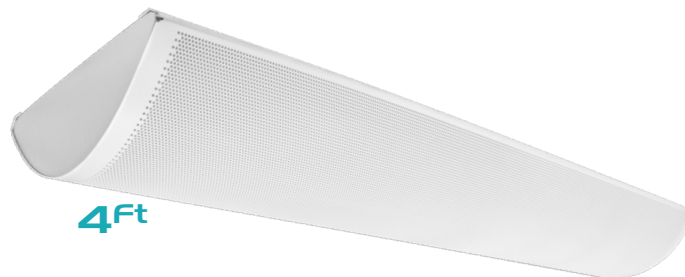

4Ft



SCLL-CB

LED LINEAR SUSPENDED PERFORATED BASKET LIGHT (UP/DOWN)

White



CATALOG NO.	DESCRIPTION	PKG. QTY.
SCLL-UD-4FT-60W-50K-D	40W/20W OR 60W 4400LM/2100LM 5000K	1
SCLL-UD-4FT-60W-40K-D	40W/20W OR 60W 4400LM/2100LM 4000K	1
SCLL-UD-4FT-60W-35K-D	40W/20W OR 60W 4400LM/2100LM 3500K	1
SCLL-CB	COUPLING BRACKET	-

SUSPENSION KIT & CABLE NOT INCLUDED SEE PAGES 100 TO 103, FOR FACTORY-INSTALLED OPTIONS SEE BELOW

COMMERCIAL
SUSPENDED
LIGHTS

4Ft

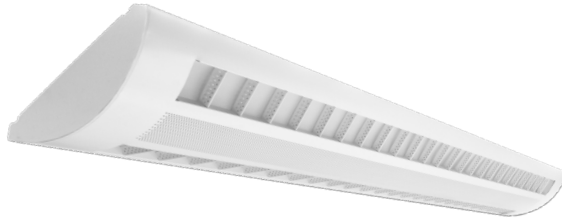

SCPP-DEC

LED SUSPENDED 2/3 LOUVER & PERF. CENTER BASKET LIGHT (UP/DOWN)



CATALOG NO.	DESCRIPTION	PKG. QTY.
SCPP-UD-4FT-60W-50K-D	40W/20W OR 60W 4400LM/2100LM 5000K	1
SCPP-UD-4FT-60W-40K-D	40W/20W OR 60W 4400LM/2100LM 4000K	1
SCPP-UD-4FT-60W-35K-D	40W/20W OR 60W 4400LM/2100LM 3500K	1
SCPP-DEC	DECORATIVE END CAP FOR SCPP	-

SUSPENSION KIT & CABLE NOT INCLUDED SEE PAGES 100 TO 103, FOR FACTORY-INSTALLED OPTIONS SEE SCPL-UD BELOW
COUPLING CLIPS INCLUDED

COMMERCIAL
SUSPENDED
LIGHTS

4Ft



SCLP-UD-CB

LED SUSPENDED 2/3 PERFORATED BASKETLIGHT (UP/DOWN)

White



CATALOG NO.	DESCRIPTION	PKG. QTY.
SCPL-UD-4FT-60W-50K-D	40W/20W OR 60W 4400LM/2100LM 5000K	1
SCPL-UD-4FT-60W-40K-D	40W/20W OR 60W 4400LM/2100LM 4000K	1
SCPL-UD-4FT-60W-35K-D	40W/20W OR 60W 4400LM/2100LM 3500K	1
SCLP-UD-CB	COUPLING BRACKET	-

SUSPENSION KIT & CABLE NOT INCLUDED SEE PAGES 100 TO 103, FOR FACTORY-INSTALLED OPTIONS SEE BELOW



FACTORY-INSTALLED OPTIONS, ENTER DESIRED OPTION CODE(S) AS LINE ITEMS ON YOUR PURCHASE ORDER UNDER THE PRODUCT CATALOG NUMBER

WATTS	EM OPTION	DESCRIPTION	UP/DOWN LIGHT	DESCRIPTION	PAINT	SENSOR	DESCRIPTION
All	OPT-EM-SLIINT	INTERNAL	OPT-SCL-LMT-35K OPT-SCL-LMT-40K OPT-SCL-LMT-50K	UP/DOWN LIGHT MODULE	OPT-CLR-100 (BK/GR/SR/WH)	OPT-SEN-2US INTERNAL FOR ALL MODELS BI-LEVEL DIMMING (REMOTE NOT NEEDED) WEC-3RC	ULTRASONIC REMOTE CONTROL



4Ft

LED SUSPENDED UP/DOWN CLEAR PANEL LIGHT, 120-277V (SUSPENSION & CORD NOT INCL.)



CATALOG NO.	DESCRIPTION	PKG. QTY.
SPL-4FT-40W-50K-D	40W 2100LM/2100LM 5000K WHILE SUPPLIES LAST	2
SPL-4FT-40W-40K-D	40W 2100LM/2100LM 4000K WHILE SUPPLIES LAST	2
SPL-4FT-40W-35K-D	40W 2100LM/2100LM 3500K WHILE SUPPLIES LAST	2
SPL-4FT-40W-MCT-D	40W 2100LM/2100LM 3500K/4000K/5000K MCT	2

SEE PAGES 100 TO 103 FOR SUSPENSION & CORD



FACTORY-INSTALLED OPTIONS, ENTER DESIRED OPTION CODE(S) AS LINE ITEMS ON YOUR PURCHASE ORDER UNDER THE PRODUCT CATALOG NUMBER

WATTS	EM OPTION	DESCRIPTION	PHOTOCELL	DESCRIPTION	PAINT	SENSOR	DESCRIPTION
ALL MODELS	OPT-EM-SPL	EXTERNAL		N/A	N/A	N/A	N/A

LED ARCHITECTURAL ROUND SUSPENDED DOWN LIGHT, (WITH UP LIGHT OPTION, SEE FACTORY-INSTALLED OPTIONS BELOW)



CATALOG NO.	DESCRIPTION	PKG. QTY.
	LED ARCHITECTURAL ROUND SUSPENDED DOWN LIGHT, 24" DIA, 6FT HEIGHT	
SCR-24D-50K-D	50W 5267LM 5000K WHILE SUPPLIES LAST	1
SCR-24D-40K-D	50W 5197LM 4000K WHILE SUPPLIES LAST	1
MCTP SCR-24D-MCTP-D	30W/40W/50W 60LM/W 3000K/3500K/4000K	1
SCR-24D-MCTP-SMB	Surface Mounting Bracket For SCR-24D-MCTP-D	
	LED ARCHITECTURAL ROUND SUSPENDED DOWN LIGHT, 32" DIA,	
MCTP SCR-32D-MCTP-D	40W/60W/80W 110LM/W 30K/35K/40K	1
	LED ARCHITECTURAL ROUND SUSPENDED DOWN LIGHT, 48" DIA,	
MCTP SCR-48D-MCTP-D	60W/80W/100W 110LM/W 30K/35K/40K	1



FACTORY-INSTALLED OPTIONS, ENTER DESIRED OPTION CODE(S) AS LINE ITEMS ON YOUR PURCHASE ORDER UNDER THE PRODUCT CATALOG NUMBER

WATTS	UPLIGHT OPTION	DESCRIPTION	EM OPTION	DESCRIPTION	PAINT	SENSOR	DESCRIPTION
ALL MODELS	OPT-SCR-ULK	120V Installation Only		N/A	N/A	OPT-SEN-2MDR-36 WEC-3RC	PROGRAMMABLE MICROWAVE BI-LEVEL REMOTE CONTROL

LED SUSPENDED UP/DOWN CLEAR ROUND PANEL LIGHT, 22" DIA., 6FT HEIGHT



CATALOG NO.	DESCRIPTION	PKG. QTY.
SRPL-40W-35K-D	40W 2100LM/2100LM 3500K WHILE SUPPLIES LAST	1
SRPL-40W-40K-D	40W 2100LM/2100LM 4000K WHILE SUPPLIES LAST	1
SRPL-40W-50K-D	40W 2100LM/2100LM 5000K WHILE SUPPLIES LAST	1
SRPL-40W-MCT-D	40W 2100LM/2100LM 3500K/4000K/5000K MCTP	1



FACTORY-INSTALLED OPTIONS, ENTER DESIRED OPTION CODE(S) AS LINE ITEMS ON YOUR PURCHASE ORDER UNDER THE PRODUCT CATALOG NUMBER

WATTS	EM OPTION	DESCRIPTION	PHOTOCELL	DESCRIPTION	PAINT	SENSOR	DESCRIPTION
ALL MODELS	OPT-EM-SRPL	INTERNAL		N/A	N/A	OPT-SEN-2MDR-36 WEC-3RC	PROGRAMMABLE MICROWAVE BI-LEVEL REMOTE CONTROL

PATIENT OVERBED HEALTHCARE LIGHT WITH PULL CHAIN AND INDICATOR LIGHT, 40W DOWN & 20W UP LIGHT FOR FACTORY-INSTALLED EM OPTIONS SEE PAGE 92



CATALOG NO.	DESCRIPTION	PKG. QTY.
POB-UD-4FT-60W-40K-D	60W 6900LM 4000K	4

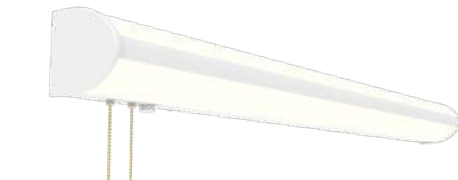

LED LOUVER WALL LIGHTS (UP/DOWN) FOR FACTORY-INSTALLED EM OPTIONS SEE PAGE 92



CATALOG NO.	DESCRIPTION	PKG. QTY.
WCLP-UD-2FT-25W-MCT-D	25W 2750LM 3000K/4000K/5000K 2FT	1
WCLP-UD-4FT-50W-MCT-D	50W 5500LM 3000K/4000K/5000K 4FT	1



LED PERFORATED WALL LIGHTS (UP/DOWN) FOR FACTORY-INSTALLED EM OPTIONS SEE PAGE 92



CATALOG NO.	DESCRIPTION	PKG. QTY.
WCPL-UD-2FT-25W-MCT-D	25W 2750LM 3000K/4000K/5000K 2FT	1
WCPL-UD-4FT-50W-MCT-D	50W 5500LM 3000K/4000K/5000K 4FT	1





COMMERCIAL
STRIP
LIGHTS

SPEC SERIES HIGH-LUMEN CCT & POWER ADJUSTABLE LINEAR STRIP



CATALOG NO.	DESCRIPTION	PKG. QTY.
LSS-2FT-25W-MCTP	15W/17W/20W/25W 130LM/W 35K/40K/50K	6
LSS-4FT-34W-MCTP	24W/27W/30W/34W 130LM/W 35K/40K/50K	6
LSS-4FT-46W-MCTP	29W/34W/39W/46W 130LM/W 35K/40K/50K	6
LSS-8FT-65W-MCT	65W 8800LM 35K/40K/50K	6
LSS-8FT-90W-MCTP	85W/75W/65W/55W 130LM/W 35K/40K/50K	6
LSS-2FT-25W-MCTP-BK	15W/17W/20W/25W 130LM/W 35K/40K/50K Black	6
LSS-4FT-46W-MCTP-BK	29W/34W/39W/46W 130LM/W 35K/40K/50K Black	6
LSS-8FT-90W-MCTP-BK	85W/75W/65W/55W 130LM/W 35K/40K/50K Black	6
LSS-CB2	Alignment Bracket	MCTP
LSS-CB2-BK	Alignment Bracket, Black Finish	MCTP
SCL-CSY1-6FT	Adj. 6Ft 1/16In, 1.5mm Single Suspension 5In Canopy Set With Y Double Keyhole End Connectors, Non Power Side	MCTP
SCL-CSY1P-6FT	Adj. 6Ft 1/16In, 1.5mm Single Suspension 5In Canopy Set With Y Double Keyhole End Connectors, Power Side With SjtW18/5 White Cord	MCTP
SCL-CSY1P-6FT-NC	Adj. 6Ft 1/16In, 1.5mm Single Suspension 5In Canopy Set With Y Double Keyhole End Connector	MCTP
SCL-GSY10	Adjustable 10 Ft. 1/16", 1.5mm Suspension Kit With Y-Connector & Loop Grip & Hooks(2)	MCTP
SCL-GSY20	Adjustable 20 Ft. 1/16", 1.5mm Suspension Kit With Y-Connector & Loop Grip & Hooks(2)	MCTP



SCL-TBTC-WN T-Bar Track Clip With Washer And Wing Nut
FACTORY-INSTALLED OPTIONS, ENTER DESIRED OPTION CODE(S) AS LINE ITEMS ON YOUR PURCHASE ORDER UNDER THE PRODUCT CATALOG NUMBER

WATTS	EM OPTION	DESCRIPTION	PLUG IN CORD	DESCRIPTION	PAINT	SENSOR	DESCRIPTION
2FT & 3FT	OPT-EM-LSS-23	INTERNAL	OPT-HBC-125TL-WH	8FT, 15A, 125V, WHITE	N/A	OPT-SEN-2US	ULTRASONIC
4FT	OPT-EM-LSS-4	INTERNAL	OPT-HBC-277TL-WH	8FT, 15A, 277V, WHITE		INTERNAL FOR ALL MODELS	BI-LEVEL DIMMING
8FT	OPT-EM-LSS-8	INTERNAL	OPT-HBC-125SB-WH	10FT, 15A, 125V, 18/3STR, WHT		WEC-3RC	(REMOTE NOT NEEDED)
	FLEX WHIP	DESCRIPTION				OPT-2P-58	OPTIONAL RC PIR SENSOR (Not remote capable)
	OPT-FWH-63	6FT 3-Wire Whip					
	OPT-FWH-65	6FT 5-Wire Whip					



LSN-2FT-WG
LSN-4FT-WG

WEC-3RC

BUILDER SERIES NARROW STRIP, 120-277VAC



COMMERCIAL
STRIP
LIGHTS

CATALOG NO.	DESCRIPTION	PKG. QTY.
NARROW STRIP, 120-277VAC		
LSN-2FT-20W-MCT-D	20W 2600LM 3500K/4000K/5000K	8
LSN-4FT-32W-35K-D	32W 4160LM 3500K	8
LSN-4FT-32W-40K-D	32W 4160LM 4000K	8
LSN-4FT-32W-50K-D	32W 4160LM 5000K	8
LSN-4FT-40W-35K-D	40W 5200LM 3500K	8
LSN-4FT-40W-40K-D	40W 5200LM 4000K	8
LSN-4FT-40W-50K-D	40W 5200LM 5000K	8
LSN-4FT-40W-MCTP-D	25W/30W/40W 130LM/W 3500K/4000K/5000K	8
LSN-8FT-64W-40K-D	64W 8320LM 4000K	4
LSN-8FT-64W-50K-D	64W 8320LM 5000K	4
LSN-8FT-50W-MCTP-D	30W/40W/50W 130LM/W 3500K/4000K/5000K	4
LSN-8FT-80W-MCTP-D	50W/64W/80W 130LM/W 3500K/4000K/5000K	4
NARROW STRIP WITH SENSOR (SENSOR CAN BE DISCONNECTED), 120-277VAC 		
LSN-2FT-20W-MCT-D-SEN	20W 2600LM 3500K/4000K/5000K	8
LSN-4FT-40W-MCTP-D-SEN	25W/30W/40W 130LM/W 3500K/4000K/5000K	8
LSN-8FT-80W-MCTP-D-SEN	50W/64W/80W 130LM/W 3500K/4000K/5000K	4
NARROW STRIP WITH SENSOR (SENSOR CAN BE DISCONNECTED) & EMERGENCY BACKUP, 120-277VAC 		
LSN-2FT-20W-MCT-D-EM-SEN	20W 2600LM 3500K/4000K/5000K	8
LSN-4FT-40W-MCTP-D-EM-SEN	25W/30W/40W 130LM/W 3500K/4000K/5000K	8
LSN-8FT-80W-MCTP-D-EM-SEN	50W/64W/80W 130LM/W 3000K/4000K/5000K	4
LSN-CB	Coupling Bracket for LSN Series	
LSN-2FT-WG	Wire Guard Kit For 2ft LSN Strip Light	
LSN-4FT-WG	Wire Guard Kit For 4ft OR Set of 2 For 8 ft LSN Strip Light	
SCL-TBTC-WN	T-Bar Track Clip With Washer And Wing Nut	
WEC-3RC	Remote Control For Motion Sensors (For Sensor Fixtures)	



FACTORY-INSTALLED OPTIONS, ENTER DESIRED OPTION CODE(S) AS LINE ITEMS ON YOUR PURCHASE ORDER UNDER THE PRODUCT CATALOG NUMBER

WATTS	EM OPTION	DESCRIPTION	PLUG IN CORD	DESCRIPTION	PAINT	SENSOR	DESCRIPTION
2FT & 3FT	OPT-EM-LSN-23	INTERNAL	OPT-HBC-125TL-WH	8FT, 15A, 125V, WHITE	N/A	OPT-SEN-2US	ULTRASONIC
4FT	OPT-EM-LSN-4	INTERNAL	OPT-HBC-277TL-WH	8FT, 15A, 277V, WHITE		INTERNAL FOR	BI-LEVEL DIMMING
8FT	OPT-EM-LSN-8	INTERNAL	OPT-HBC-125SB-WH	10FT, 15A, 125V, 18/3STR, WHT		ALL MODELS	
	FLEX WHIP	DESCRIPTION				WEC-3RC	(REMOTE NOT NEEDED)
	OPT-FWH-63	6FT 3-Wire Whip				OPT-2P-58	OPTIONAL RC
	OPT-FWH-65	6FT 5-Wire Whip					PIR SENSOR (Not remote capable)



2Ft



4Ft



Split Version,
Req. 5min Assembly

8Ft

LSL-8FT-80W-40K-D-A
LSL-8FT-80W-50K-D-A



8Ft



WEC-3RC



LSL-CB



LSL-4FT-WK
Shown with fixture



SCL-CSY1-6FT

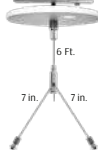

SCL-CSY1P-6FT



SCL-CSY1P-6FT-NC

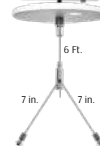

SCL-GSY10

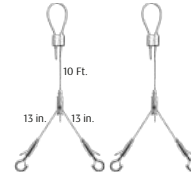

SCL-GSY20

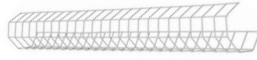

LSL-2FT-WG
LSL-4FT-WG

SPEC SERIES LED STRIP LIGHT, 120-277V, (FOR SENSOR MODELS: SENSOR CAN BE DISCONNECTED)



CATALOG NO.	DESCRIPTION	PKG. QTY.
2Ft	LSL-2FT-20W-35K-D 20W 2100LM 3500K 2FT	1
2Ft	LSL-2FT-20W-40K-D 20W 2100LM 4000K 2FT	1
2Ft	LSL-2FT-20W-50K-D 20W 2100LM 5000K 2FT	1
2Ft	LSL-2FT-20W-MCT-D 20W 2270LM 35K/40K/50K 2FT	1
3Ft	LSL-3FT-30W-MCT-D 30W 3150LM 35K/40K/50K 3FT	1
4Ft	LSL-4FT-40W-35K-D 40W 4200LM 3500K 4FT	1
4Ft	LSL-4FT-40W-40K-D 40W 4200LM 4000K 4FT	1
4Ft	LSL-4FT-40W-50K-D 40W 4200LM 5000K 4FT	1
4Ft	LSL-4FT-40W-MCT-D 40W 4200LM 35K/40K/50K 4FT	1
6Ft	LSL-6FT-60W-MCT-D 60W 7300LM 35K/40K/50K 6FT	1
8Ft	LSL-8FT-80W-40K-D-A 80W 8400LM 4000K 8FT Split Version,	1
8Ft	LSL-8FT-80W-50K-D-A 80W 8400LM 5000K 8FT Split Version	1
8Ft	LSL-8FT-80W-40K-D 80W 8400LM 4000K 8FT	1
8Ft	LSL-8FT-80W-50K-D 80W 8400LM 5000K 8FT	1
8Ft	LSL-8FT-80W-MCT-D 80W 8400LM 35K/40K/50K 8FT	1
8Ft	LSL-8FT-84W-40K-D-HL 84W 11000LM 4000K 8FT High-Lumen	1
8Ft	LSL-8FT-84W-50K-D-HL 84W 11000LM 5000K 8FT High-Lumen	1
8Ft	LSL-8FT-84W-MCT-D-HL 84W 11000LM 35K/40K/50K 8FT High-Lumen	1
QUICK SHIP	LSL-2FT-20W-MCT-D-SEN 20W 2100LM 35K/40K/50K 2FT With Sensor	1
QUICK SHIP	LSL-4FT-40W-MCT-D-SEN 40W 4200LM 35K/40K/50K 4FT With Sensor	1
QUICK SHIP	LSL-8FT-80W-MCT-D-SEN 80W 8400LM 35K/40K/50K 8FT With Sensor	1
QUICK SHIP	LSL-2FT-20W-MCT-D-EM-SEN 20W 2100LM 35K/40K/50K 2FT With Sensor & EM	1
QUICK SHIP	LSL-4FT-40W-MCT-D-EM-SEN 40W 4200LM 35K/40K/50K 4FT With Sensor & EM	1
QUICK SHIP	LSL-8FT-80W-MCT-D-EM-SEN 80W 8400LM 35K/40K/50K 8FT With Sensor & EM	1
	LSL-2FT-WG Wire Guard Kit For 2Ft. Strip Light	
	LSL-4FT-WG Wire Guard Kit For 4Ft. Strip Light	
	LSL-4FT-WK Shop Wings For 4Ft. Strip Light, Use 2 Kits For Lsl-8Ft	
	SCL-TBTC-WN T-Bar Track Clip With Washer And Wing Nut	
	LSL-CB Alignment Bracket	
	SCL-CSY1-6FT Adj. 6Ft 1/16In, 1.5mm Single Suspension 5In Canopy Set With Y Double Keyhole End Connectors, Non Power Side	
	SCL-CSY1P-6FT Adj. 6Ft 1/16In, 1.5mm Single Suspension 5In Canopy Set With Y Double Keyhole End Connectors, Power Side With 5/16" White Cord	
	SCL-CSY1P-6FT-NC Adj. 6Ft 1/16In, 1.5mm Single Suspension 5In Canopy Set With Y Double Keyhole End Connector	
	SCL-GSY10 Adjustable 10 Ft. 1/16", 1.5mm Suspension Kit With Y-Connector & Loop Grip & Hooks(2)	
	SCL-GSY20 Adjustable 20 Ft. 1/16", 1.5mm Suspension Kit With Y-Connector & Loop Grip & Hooks(2)	
	WEC-3RC Remote Control For Motion Sensors (For Sensor Fixtures)	

FOR FACTORY-INSTALLED OPTIONS SEE NEXT PAGE

(SAME FOOTPRINT AS STANDARD 4' 2L FLUOR. STRIPS)

COMMERCIAL STRIP LIGHTS



FACTORY-INSTALLED OPTIONS, ENTER DESIRED OPTION CODE(S) AS LINE ITEMS ON YOUR PURCHASE ORDER UNDER THE PRODUCT CATALOG NUMBER

WATTS	EM OPTION	DESCRIPTION	PLUG IN CORD	DESCRIPTION	PAINT	SENSOR	DESCRIPTION
2FT & 3FT	OPT-EM-LSL-23	INTERNAL	OPT-HBC-125TL-WH	8FT, 15A, 125V, WHITE	N/A	OPT-SEN-2US	ULTRASONIC
4FT	OPT-EM-LSL-4	INTERNAL	OPT-HBC-277TL-WH	8FT, 15A, 277V, WHITE		INTERNAL FOR ALL MODELS	BI-LEVEL DIMMING
8FT	OPT-EM-LSL-8	INTERNAL	OPT-HBC-125SB-WH	10FT, 15A, 125V, 18/3STR, WHT		WEC-3RC	(REMOTE NOT NEEDED)
	OPT-FWH-63	6FT 3-Wire Whip				OPT-2P-58	OPTIONAL RC PIR SENSOR (Not remote capable)
	OPT-FWH-65	6FT 5-Wire Whip					

2Ft



4Ft



Add EM and/or Sensor Options to use as Stairwell Fixtures



2FT & 4FT ADJUSTABLE LINEAR CORNER CORRIDOR

CATALOG NO.	DESCRIPTION	PKG. QTY.
LCL-2FT-20W-MCTP	10W/15W/20W 115LM/W 3500K/4000K/5000K	6
LCL-4FT-40W-MCTP	20W/30W/40W 115LM/W 3500K/4000K/5000K	6



FACTORY-INSTALLED OPTIONS, ENTER DESIRED OPTION CODE(S) AS LINE ITEMS ON YOUR PURCHASE ORDER UNDER THE PRODUCT CATALOG NUMBER

WATTS	EM OPTION	DESCRIPTION	PLUG IN CORD	DESCRIPTION	PAINT	SENSOR	DESCRIPTION
ALL MODELS	OPT-EM-LCL	INTERNAL	OPT-HBC-125TL-WH	8FT, 15A, 125V, WHITE	N/A	OPT-SEN-2US	ULTRASONIC
			OPT-HBC-277TL-WH	8FT, 15A, 277V, WHITE		INTERNAL FOR ALL MODELS	BI-LEVEL DIMMING
			OPT-HBC-125SB-WH	10FT, 15A, 125V, 18/3STR, WHT		WEC-3RC	(REMOTE NOT NEEDED)
						OPT-2P-58	OPTIONAL RC

LED 4FT. 2-LAMP STRIP RETROFIT KIT



CATALOG NO.	DESCRIPTION	PKG. QTY.
SLR-4FT-40W-50K-D	40W 4400LM 5000K 4FT.	12

4Ft



FACTORY-INSTALLED OPTIONS, ENTER DESIRED OPTION CODE(S) AS LINE ITEMS ON YOUR PURCHASE ORDER UNDER THE PRODUCT CATALOG NUMBER

WATTS	EM OPTION	DESCRIPTION	PHOTOCELL	DESCRIPTION	PAINT	SENSOR	DESCRIPTION
ALL MODELS	OPT-EM-SLR	INTERNAL		N/A	N/A	OPT-SEN-2MDR-36	PROGRAMMABLE MICROWAVE BI-LEVEL
						WEC-3RC	REMOTE CONTROL

4Ft



8Ft



4FT. & 8FT. LED-READY STRIP LIGHTS - DIRECT AC INPUT 120-277V FOR TYPE B (AC) T8 (CAN ALSO BE USED AS 4FT 1L OR 8FT 2L) WITHOUT LAMP



CATALOG NO.	DESCRIPTION	PKG. QTY.
LRS-4FT-2L-6PK	4FT 2 LAMPS (Not Included)	6
LRS-8FT-4L-6PK	8FT 4 LAMPS (Not Included)	6



LRLS SERIES WITH CLEAR OR FROSTED LED T8 LAMPS



CATALOG NO.	DESCRIPTION	PKG. QTY.
LRLS-4FT-2L-6PK-40K-C	18W 2200LM 4000K per lamp 4FT 2 LAMPS (Inc)	6
LRLS-8FT-T4L-6PK-40K-C	18W 2200LM 4000K per lamp 8FT 4 LAMPS (Inc)	6
LRLS-4FT-2L-6PK-50K-C	18W 2200LM 5000K per lamp 4FT 2 LAMPS (Inc)	6
LRLS-8FT-T4L-6PK-50K-C	18W 2200LM 5000K per lamp 8FT 4 LAMPS (Inc)	6
LRLS-4FT-2L-6PK-40K-F	18W 2200LM 4000K per lamp 4FT 2 LAMPS (Inc)	6
LRLS-8FT-T4L-6PK-40K-F	18W 2200LM 4000K per lamp 8FT 4 LAMPS (Inc)	6
LRLS-4FT-2L-6PK-50K-F	18W 2200LM 5000K per lamp 4FT 2 LAMPS (Inc)	6
LRLS-8FT-T4L-6PK-50K-F	18W 2200LM 5000K per lamp 8FT 4 LAMPS (Inc)	6

LED SHOP LIGHT, 120V WITH PLUG-IN CORD



CATALOG NO.	DESCRIPTION	PKG. QTY.
LSP-4FT-40W-40K	40W 4400LM 4000K WITH ADJUSTABLE SUSPENSION CABLE	4

LED STANDARD WRAP-AROUND FIXTURE, 120-277V



CATALOG NO.	DESCRIPTION	PKG. QTY.
WAS-4FT-42W-35K-D	42W 4400LM 3500K 4FT	1
WAS-4FT-42W-40K-D	42W 4400LM 4000K 4FT	1
WAS-4FT-42W-50K-D	42W 4400LM 5000K 4FT	1

FOR FACTORY-INSTALLED OPTIONS SEE WA BELOW



SPEC SERIES LED ARCHITECTURAL WRAP-AROUND LIGHT

CATALOG NO.	DESCRIPTION	PKG. QTY.
SPEC SERIES LED ARCHITECTURAL WRAP-AROUND LIGHT		
WA-2FT-25W-35K-D	25W WHILE SUPPLIES LAST 2750LM 3500K 2FTx8.2"	5
WA-2FT-25W-50K-D	25W WHILE SUPPLIES LAST 2750LM 5000K 2FTx8.2"	5
WA-2FT-25W-MCT-D	25W WHILE SUPPLIES LAST 2800LM 35K/40K/50K MCT 2FTx8.2"	
SPEC SERIES CCT ADJUSTABLE LED ARCHITECTURAL WRAP-AROUND LIGHT MCT		
WA-4FT-30W-MCT-D	30W WHILE SUPPLIES LAST 3200LM 3500K/4000K/5000K 4FTx8.2"	
SPEC SERIES POWER & CCT ADJUSTABLE LED ARCHITECTURAL WRAP-AROUND LIGHT MCTP		
WA-2FT-10-20W-MCTP	10W/15W/20W 110LM/W 35K/40K/50K 4FTx8.2"	
WA-4FT-20-40W-MCTP	20W/30W/40W 110LM/W 35K/40K/50K 4FTx8.2"	



FACTORY-INSTALLED OPTIONS, ENTER DESIRED OPTION CODE(S) AS LINE ITEMS ON YOUR PURCHASE ORDER UNDER THE PRODUCT CATALOG NUMBER

WATTS	EM OPTION	DESCRIPTION	PHOTOCELL	DESCRIPTION	PAINT	SENSOR	DESCRIPTION
ALL MODELS	OPT-EM-WA	INTERNAL		N/A	N/A	OPT-2P-58 OPT-SEN-2MDR-36 WEC-3RC	PIR SENSOR (Not remote capable) PROGRAMMABLE MICROWAVE BI-LEVEL REMOTE CONTROL

COMMERCIAL
STRIP & WRAP
AROUND



BUILDER SERIES LED ECONOMY WRAP-AROUND FIXTURES

MCTP*: MULTI COLOR TEMPERATURE & MULTI POWER



	CATALOG NO.	DESCRIPTION	PKG. QTY.
	LED ECONOMY WRAP-AROUND FIXTURES, 0-10V DIMMING		
4Ft	WAE-4FT-30K-D	40W 3000K	6
	WAE-4FT-40K-D	40W 4000K	6
	WAE-4FT-50K-D	40W 5000K	6
	CCT ADJUSTABLE LED ECONOMY WRAP-AROUND FIXTURES, 0-10V & TRIAC DIMMING		
2Ft	WAE-2FT-MCT-DD	20W 3000K/4000K/5000K	6
	WAE-4FT-MCT-DD	40W 3000K/4000K/5000K	6
	POWER & CCT ADJUSTABLE LED ECONOMY WRAP-AROUND FIXTURE		
4Ft	WAE-4FT-40-65W-MCTP-DD	40W/50W/65W 30K/40K/50K	
4Ft	POWER & CCT ADJUSTABLE LED ECONOMY WRAP-AROUND FIXTURE WITH REMOTE CONTROL		
	WAE-4FT-MCTP	40W Max. 2700K-5000K Remote Control incl.	6
	CCT ADJUSTABLE LED ECONOMY WRAP-AROUND FIXTURES WITH SENSOR (SENSOR CAN BE DISCONNECTED), 0-10V & TRIAC DIMMING		
	WAE-2FT-MCT-DD-SEN	20W 3000K/4000K/5000K	
	WAE-4FT-MCT-DD-SEN	40W 3000K/4000K/5000K	
	WEC-3RC	Remote Control For Motion Sensors (For Sensor Fixtures)	
	CCT ADJUSTABLE LED ECONOMY WRAP-AROUND FIXTURES WITH SENSOR (SENSOR CAN BE DISCONNECTED) & EMERGENCY BACKUP, 0-10V & TRIAC DIMMING		
	WAE-2FT-MCT-DD-EM-SEN	20W 3000K/4000K/5000K	
	WAE-4FT-MCT-DD-EM-SEN	40W 3000K/4000K/5000K	
	WEC-3RC	Remote Control For Motion Sensors (For Sensor Fixtures)	
2Ft	CCT ADJUSTABLE LED ECONOMY WRAP-AROUND FIXTURES, TRIAC DIMMING WHILE SUPPLIES LAST		
	WAE-2FT-MCT-DT	20W 3000K/4000K/5000K	6

COMMERCIAL
WRAP AROUND



LINEAR PUFF FIXTURE, SELECTABLE POWER & CCT, DUAL DIMMING TRIAC & 0-10V



CATALOG NO.	DESCRIPTION
LPF-2FT-MCT-DD	25W 2250LM 30K/40K/50K 2FT
LPF-4FT-MCT-DD	40W 3600LM 30K/40K/50K 4FT

GRIP & SUSPENSION ACCESSORIES



SCL-CSK-6FT

ADJ. 6FT 1/16in SUSPENSION CANOPY COMPLETE KIT FOR BOTH SIDES WITH KEYHOLE END CONNECTORS



SCL-CS1-6FT

ADJ. 6FT 1/16in, 1.5mm SINGLE SUSPENSION 5in CANOPY SET WITH KEYHOLE END CONNECTOR, NON-POWER SIDE



SCL-CS1P-6FT

ADJ. 6FT 1/16in, 1.5mm SINGLE SUSPENSION 5in CANOPY SET WITH KEYHOLE END CONNECTOR, POWER SIDE WITH SJTW18/5 WHITE CORD



SCL-CS1P-6FT-NC

ADJ. 6FT 1/16in, 1.5mm SINGLE SUSPENSION 5in CANOPY SET WITH KEYHOLE END CONNECTOR, POWER SIDE WITHOUT CORD

COMPATIBLE SERIES

- SCX (SINGLE KEYHOLE)
LSL, LSS ("Y" END & HOOK OR "Y" END & TOGGLE)
SCLP, SCPL-UD, SCLL, SCPP ("Y" END & KEYHOLE)
- 2FT, 3FT, 4FT FIXTURES NEED 2 SUSPENSION CABLES (2 ON ENDS)
 - 6FT & 8FT FIXTURES NEED 3 SUSPENSION CABLES (1 IN CENTER, 2 ON ENDS)



SCL-CS1-6FT-BK

BLACK ADJ. 6FT 1/16in, 1.5mm SINGLE SUSPENSION 5in CANOPY SET WITH KEYHOLE END CONNECTOR, NON-POWER SIDE



SCL-CS1P-6FT-BK

BLACK ADJ. 6FT 1/16in, 1.5mm SINGLE SUSPENSION 5in CANOPY SET WITH KEYHOLE END CONNECTOR, POWER SIDE WITH SJTW18/5 BLACK CORD



SCL-CS1P-6FT-NC-BK

BLACK ADJ. 6FT 1/16in, 1.5mm SINGLE SUSPENSION 5in CANOPY SET WITH KEYHOLE END CONNECTOR, POWER SIDE WITHOUT CORD



SCL-CS1-12FT

ADJ. 12FT 1/16in, 1.5mm SINGLE SUSPENSION 5in CANOPY SET WITH KEYHOLE END CONNECTOR, NON-POWER SIDE



SCL-CS1P-12FT-NC

ADJ. 12FT 1/16in, 1.5mm SINGLE SUSPENSION 5in CANOPY SET WITH KEYHOLE END CONNECTOR, POWER SIDE WITHOUT CORD



SCL-CS1P-12FT-NC-BK

BLACK ADJ. 12FT 1/16in, 1.5mm SINGLE SUSPENSION 5in CANOPY SET WITH KEYHOLE END CONNECTOR



SCL-CS1-12FT-BK

BLACK ADJ. 12FT 1/16in, 1.5mm SINGLE SUSPENSION 5in CANOPY SET WITH KEYHOLE END CONNECTOR, NON-POWER SIDE



SCL-CSQ1-6FT

ADJ. 6FT 1/16in, 1.5mm SINGLE SQUARE SUSPENSION 5in CANOPY SET WITH KEYHOLE END CONNECTOR, NON-POWER SIDE



SCL-CSQ1P-6FT-NC

ADJ. 6FT 1/16in, 1.5mm SINGLE SQUARE SUSPENSION 5in CANOPY SET WITH KEYHOLE END CONNECTOR, POWER SIDE, WITHOUT CORD



SCL-CSQ1-12FT

ADJ. 12FT 1/16in, 1.5mm SINGLE SQUARE SUSPENSION 5in CANOPY SET WITH KEYHOLE END CONNECTOR, NON-POWER SIDE



SCL-CSQ1P-12FT-NC

ADJ. 12FT 1/16in, 1.5mm SINGLE SQUARE SUSPENSION 5in CANOPY SET WITH KEYHOLE END CONNECTOR, POWER SIDE, WITHOUT CORD



SCL-CSQ1-6FT-BK

ADJ. 6FT 1/16in, 1.5mm SINGLE SQUARE SUSPENSION 5in CANOPY SET WITH KEYHOLE END CONNECTOR, NON-POWER SIDE, BLACK



SCL-CSQ1P-6FT-NC-BK

ADJ. 6FT 1/16in, 1.5mm SINGLE SQUARE SUSPENSION 5in CANOPY SET WITH KEYHOLE END CONNECTOR, POWER SIDE, WITHOUT CORD, BLACK



SCL-CSQ1-12FT-BK

ADJ. 12FT 1/16in, 1.5mm SINGLE SQUARE SUSPENSION 5in CANOPY SET WITH KEYHOLE END CONNECTOR, NON-POWER SIDE, BLACK



SCL-CSQ1P-12FT-NC-BK

ADJ. 12FT 1/16in, 1.5mm SINGLE SQUARE SUSPENSION 5in CANOPY SET WITH KEYHOLE END CONNECTOR, POWER SIDE, WITHOUT CORD, BLACK



SCL-CS1M-6FT

ADJ. 6FT 1/16in, 1.5mm SINGLE SUSPENSION 2in CANOPY SET WITH KEYHOLE END CONNECTOR, NON-POWER SIDE



SCL-CS1MP-6FT

ADJ. 6FT 1/16in, 1.5mm SINGLE SUSPENSION 2in CANOPY SET WITH KEYHOLE END CONNECTOR, POWER SIDE WITH SJTW18/5 WHITE CORD



SCL-CS1M-6FT-BK

ADJ. 6FT 1/16in, 1.5mm SINGLE SUSPENSION 2in CANOPY SET WITH KEYHOLE END CONNECTOR, NON-POWER SIDE, BLACK



SCL-CS1MP-6FT-BK

ADJ. 6FT 1/16in, 1.5mm SINGLE SUSPENSION 2in CANOPY SET WITH KEYHOLE END CONNECTOR, POWER SIDE WITH SJTW18/5 WHITE CORD, BLACK



OPT-SCL-XLENGTH

LABOR CHARGE FOR CUSTOM CABLE LENGTH, SPECIFY DESIRED LENGTH IN PO. MUST PURCHASE SUFFICIENT ROLLS OF AIRCRAFT CABLE SEE PAGE 102

COMMERCIAL
SUSPENSION
ACCESSORIES

GRIP & SUSPENSION ACCESSORIES



SCL-CSY1-6FT

ADJ. 6FT 1/16in, 1.5mm SINGLE SUSPENSION 5in CANOPY SET WITH Y DOUBLE KEYHOLE END CONNECTORS, NON-POWER SIDE



SCL-CSY1P-6FT

ADJ. 6FT 1/16in, 1.5mm SINGLE SUSPENSION 5in CANOPY SET WITH Y DOUBLE KEYHOLE END CONNECTORS, POWER SIDE WITH SJTW18/5 WHITE CORD



SCL-CSY1P-6FT-NC

ADJ. 6FT 1/16in, 1.5mm SINGLE SUSPENSION 5in CANOPY SET WITH Y DOUBLE KEYHOLE END CONNECTORS



SCL-3CS10

ADJ. 10FT 1/16in, 1.5mm TRIPLE-CABLE SUSPENSION 5in CANOPY KIT WITH KEYHOLE END & CONNECTORS, CABLE BUSHING, 9" DIA., NO CORD INCL.

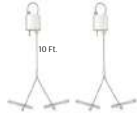

SCL-GTY10

ADJUSTABLE 1/16" 10 FT., 1.5mm SUSPENSION KIT WITH LOOP GRIPPER & TOGGLE ENDS(2)



SCL-GTY20

ADJUSTABLE 1/16" 20 FT., 1.5mm SUSPENSION KIT WITH LOOP GRIPPER & TOGGLE ENDS(2)



SCL-GTY210

HEAVY-DUTY ADJUSTABLE 5/64" 10 FT., 2mm SUSPENSION KIT WITH LOOP GRIPPER & TOGGLE ENDS(2)



SCL-GTY220

HEAVY-DUTY ADJUSTABLE 5/64" 20 FT., 2mm SUSPENSION KIT WITH LOOP GRIPPER & TOGGLE ENDS(2)



SCL-GSY10

ADJUSTABLE 10 FT. 1/16", 1.5mm SUSPENSION KIT WITH Y-CONNECTOR & LOOP GRIP & HOOKS(2)

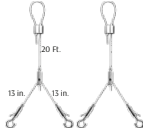

SCL-GSY20

ADJUSTABLE 20 FT. 1/16", 1.5mm SUSPENSION KIT WITH Y-CONNECTOR & LOOP GRIP & HOOKS(2)



SCL-GSY210

ADJ. 10FT 1/16IN, 1.5mm SINGLE SUSPENSION CABLE WITH Y HOOK ENDS, LOOP GRIPPER ON TOP (ORDER 3 FOR 8FT.)(1)



SCL-GSY220

ADJ. 20FT 1/16IN, 1.5mm SINGLE SUSPENSION CABLE WITH Y HOOK ENDS, LOOP GRIPPER ON TOP (ORDER 3 FOR 8FT.)(1)

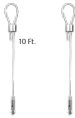

SCL-GS10

ADJ. 10FT 1/16IN, 1.5mm DOUBLE SUSPENSION CABLE WITH SINGLE KEYHOLE CONN., LOOP GRIPPER ON TOP(2)



SCL-GS20

ADJ. 20FT 1/16IN, 1.5mm DOUBLE SUSPENSION CABLE WITH SINGLE KEYHOLE CONN., LOOP GRIPPER ON TOP(2)



SCL-GS210

HEAVY-DUTY ADJUSTABLE 5/64" 10 FT., 2mm SUSPENSION KIT WITH LOOP GRIPPER & HOOK(1)



SCL-GS220

HEAVY-DUTY ADJUSTABLE 5/64" 20 FT., 2mm SUSPENSION KIT WITH LOOP GRIPPER & HOOK(1)



CMC-SRK-218-5C-WH

Universal Swivel W/ Rod Kit, 18 Or 26 Inches, 5-Wire, White



CMC-SRK-218-5C-BK

Universal Swivel W/ Rod Kit, 18 Or 26 Inches, 5-Wire, Black



CMC-SRK-224-5C-WH

Universal Swivel W/ Rod Kit, 24 Or 48 Inches, 5-Wire, White



CMC-SRK-224-5C-BK

Universal Swivel W/ Rod Kit, 24 Or 48 Inches, 5-Wire, Black



SCL-CSR-12FT

Adj. 12Ft Rectangular Canopy With Two Aircraft Cables For Linear Fixtures Up To 6Ft Long



SCL-CSR-12FT-BK

Adj. 12Ft Rectangular Canopy With Two Aircraft Cables For Linear Fixtures Up To 6Ft Long, Black



SCL-WRCL-14

1/4in GALVANIZED MALLEABLE IRON WIRE ROPE CLIP



SCL-TBJJ-14-4

1/4 X 4 INCH JAW TO JAW TURN-BUCKLE GALVANIZED STEEL



SCL-WRCL-DUPLEX

5/32in 4mm DUPLEX 2-POST WIRE ROPE CLIP CABLE CLAMP



SCL-PEP-M8

PAD EYE PLATE STAPLE HOOK, SIZE M8, 2in X 1.5in STAINLESS



SCL-ASC-4MM-250FT

5/32in 4mm DIA. EXTRA DUTY GALVANIZED AIRCRAFT CABLE / WIRE ROPE 250FT ROLL



SCL-WRTH-14

1/4in GALVANIZED WIRE ROPE THIMBLE

GRIP & SUSPENSION ACCESSORIES



SCL-6FT-SJTW18/5

WHITE 6 FT. CORD, SJTW 18 AWG
5-CONDUCT (WH/BK/GN/PU/GY)



SCL-6FT-SJTW18/6

WHITE 6 FT. CORD, SJTW 18 AWG
6-CONDUCT (WH/BK/GN/PU/GY + RED
FOR EMERGENCY))



SCL-6FT-SJTW18/5-BK

BLACK 12 FT. CORD, SJTW 18 AWG
5-CONDUCT (WH/BK/GN/PU/GY)



SCL-6FT-SJTW18/6-BK

BLACK 12 FT. CORD, SJTW 18 AWG
6-CONDUCT (WH/BK/GN/PU/GY +
RED FOR EMERGENCY)



SCL-12FT-SJTW18/5

WHITE 12 FT. CORD, SJTW 18 AWG
5-CONDUCT (WH/BK/GN/PU/GY)



SCL-12FT-SJTW18/6

WHITE 12 FT. CORD, SJTW 18 AWG
6-CONDUCT (WH/BK/GN/PU/GY +
RED FOR EMERGENCY)



SCL-12FT-SJTW18/5-BK

BLACK 12 FT. CORD, SJTW 18 AWG
5-CONDUCT (WH/BK/GN/PU/GY)



SCL-12FT-SJTW18/6-BK

BLACK 12 FT. CORD, SJTW 18 AWG
6-CONDUCT (WH/BK/GN/PU/GY +
RED FOR EMERGENCY)



SCL-100FT-SJTW18/5

WHITE 100 FT. CORD, SJTW 18 AWG
5-CONDUCT (WH/BK/GN/PU/GY)



SCL-100FT-SJTW18/6

WHITE 100 FT. CORD, SJTW 18 AWG
6-CONDUCT (WH/BK/GN/PU/GY +
RED FOR EMERGENCY)



SCL-100FT-SJTW18/5-BK

BLACK 100 FT. CORD, SJTW 18 AWG
5-CONDUCT (WH/BK/GN/PU/GY)



SCL-100FT-SJTW18/6-BK

BLACK 100 FT. CORD, SJTW 18 AWG
6-CONDUCT (WH/BK/GN/PU/GY +
RED FOR EMERGENCY)



SCL-6FT-AWM18/5-CLR

6FT CORD, SJTW 18 AWM
5-CONDUCTOR, CLEAR



SCL-12FT-AWM18/5-CLR

12FT CORD, SJTW 18 AWM
5-CONDUCTOR, CLEAR



SCL-100FT-AWM18/5-CLR

100FT CORD, SJTW 18 AWM
5-CONDUCTOR, CLEAR



SCL-ASC-50FT

1/16IN 50FT ROLL STEEL AIRCRAFT
SUSPENSION CABLE



SCL-ASC-100FT

1/16IN 100FT ROLL STEEL AIRCRAFT
SUSPENSION CABLE



SCL-ASC-500FT

1/16" 500 FT. STEEL AIRCRAFT SUS-
PENSION CABLE



SCL-ASC-1000FT

1/16" 1000 FT. STEEL AIRCRAFT
SUSPENSION CABLE



FWH-6FT-16/3

6FT 16AWG 3-WIRE FLEX FIXTURE
WHIP, STR. & 90D 1/2" CONN.



FWH-6FT-16/5

6FT 16AWG 5-WIRE FLEX FIXTURE
WHIP, STR. & 90D 1/2" CONN.



FWH-6FT-16/6

6FT 16AWG 6-WIRE FLEX FIXTURE
WHIP, STR. & 90D 1/2" CONN.



SCL-LCB-BK

LOCKING 3/8": DIA. CABLE BUSHING
FOR CANOPY SETS, BLACK



SCL-LCB

LOCKING 3/8": DIA. CABLE BUSHING
FOR CANOPY SETS

COMMERCIAL
SUSPENSION
ACCESSORIES

GRIP & SUSPENSION ACCESSORIES



FML-SK6

6FT ADJUSTABLE SUSPENSION KIT, 2-WIRE CLEAR CABLE INCL.



LFCF-SK10-BR

10FT 4-LINE CANOPY SUSPENSION KIT FOR DECORATIVE LIGHTS, 2-WIRE CLEAR CABLE INCL., BRONZE



LFCF-SK10-BN

10FT 4-LINE CANOPY SUSPENSION KIT FOR DECORATIVE LIGHTS, 2-WIRE CLEAR CABLE INCL., BRUSHED NICKEL



SCL-4CS10

ADJ. 10FT 1/16in QUAD CABLE SUSP. CANOPY KIT, KEYHOLE CONNECTORS (NO CORD INCL.)



SCL-ABCQ2K

2in SQUARE NON-POWERFEED SIDE CANOPY CONVERSION KIT



SCL-ABCQ2K-BK

2in SQUARE NON-POWERFEED SIDE CANOPY CONVERSION KIT - BLACK



SCL-ABC2K

2IN NON-POWERFEED SIDE CANOPY CONVERSION KIT



SCL-ABC2K-BK

2IN NON-POWERFEED SIDE CANOPY CONVERSION KIT - BLACK



SCL-ABCH

5IN AUXILIARY BLANK CANOPY WITH CORD GRIP



SCL-ABC

5IN AUXILIARY BLANK CANOPY FOR SUSPENSION CABLES



SCL-ABCH-BK

5IN AUXILIARY BLANK CANOPY WITH CORD GRIP - BLACK



SCL-ABC-BK

5IN AUXILIARY BLANK CANOPY FOR SUSPENSION CABLES - BLACK



SCL-ABCQ

AUXILIARY SQUARE BLANK CANOPY FOR SUSPENSION CABLES



SCL-ABCQH

AUXILIARY SQUARE BLANK CANOPY FOR SUSPENSION CABLES WITH CABLE HOLE AND CORD GRIP



SCL-ACSE

AIRCRAFT CABLE STOPPER END



SCL-AH

HEAVY-DUTY AUXILIARY HOOK FOR UP TO 1/16" AIRCRAFT CABLES



SCL-TG1420

AUXILIARY TOP GRIPPER SIDE EXIT WITH 1/4-20 THREAD FOR 1/16IN AIRCRAFT CABLE



SCL-AYC

AUXILIARY Y CONNECTOR FOR AIRCRAFT SUSPENSION CABLE, 1/16"



SCL-AKHC

AUXILIARY KEYHOLE CONNECTOR FOR AIRCRAFT SUSPENSION CABLE, 1/16"



SCL-CTB

CANOPY SET TOP BRACKET FOR MOUNTING ON JUNCTION BOX OR CEILING



SCL-TBC-WN

T-BAR CLIP WITH SUSPENSION HOLE ON TOP, WING NUT AND WASHER INCL



SCL-TBTC-WN

T-BAR TRACK CLIP WITH WASHER AND WING NUT



SCL-AUC

AUXILIARY UNIVERSAL SURFACE CONNECTOR FOR 1/6 IN AIRCRAFT SUSPENSION CABLE



SCL-CMC

AUXILIARY CEILING-MOUNT CONNECTOR FOR 1/16in AIRCRAFT SUSPENSION CABLES



SCL-YCK

ADJ. 1/16in Y CONVERSION SUSPENSION CABLE WITH TOGGLE ENDS



SCL-TGS1420

ADJ. SWIVEL TOP GRIP REPLACEMENT CONNECTOR TO ADAPT SCL-CS SERIES TO SLOPE CEILINGS



SCL-ALG

AUXILIARY LOOP GRIP FOR AIRCRAFT SUSPENSION CABLE, 1/16"



Shown with Drop Lens

1.6" ARCHITECTURAL CEILING CYLINDERS WITH INTERNAL DRIVERS INCL. CLEAR & FORSTED LENSES

COMMERCIAL
CYLINDER
LIGHTS

CATALOG NO.	DESCRIPTION
CMC1L-MCT-WH	10W 700LM 30K/40K/50K 12" H
CMC1L-MCT-BK	10W 700LM 30K/40K/50K 12" H
CMC1XL-MCT-WH	10W 700LM 30K/40K/50K 18" H
CMC1XL-MCT-BK	10W 700LM 30K/40K/50K 18" H
CMCS1XL-MCT-DT-WH	9W 630LM 30K/40K/50K 18" H SQUARE
CMCS1XL-MCT-DT-BK	9W 630LM 30K/40K/50K 18" H SQUARE
CMC1-TRM-BN	1in Cylinder Trim, Anodized Gold
CMC1-TRM-AG	1in Cylinder Trim, Brushed Nickel
CMC1-DL15	CMC1 15mm Acrylic Drop Lens
SUSPENSION ACCESSORIES FOR CMC SERIES	
CMC-CS-8FT-WH	Suspension Cable & Canopy Set For CMC Series, 8Ft, 5-Wire, White
CMC-CS-8FT-BK	Suspension Cable & Canopy Set For CMC Series, 8Ft, 5-Wire, Black
CMC-SRK-218-5C-WH	Universal Swivel W/ Rod Kit, 18 Or 36 Inches, 5-Wire, White
CMC-SRK-218-5C-BK	Universal Swivel W/ Rod Kit, 18 Or 36 Inches, 5-Wire, Black
CMC-SRK-224-5C-WH	Universal Swivel W/ Rod Kit, 24 Or 48 Inches, 5-Wire, White
CMC-SRK-224-5C-BK	Universal Swivel W/ Rod Kit, 24 Or 48 Inches, 5-Wire, Black
CMC-SRK-340-5C-WH	Universal Swivel W/ Rod Kit, 40 Or 80 Or 120 Inches, 5-Wire, White
CMC-SRK-340-5C-BK	Universal Swivel W/ Rod Kit, 40 Or 80 Or 120 Inches, 5-Wire, Black



Shown with Drop Lens

INCL. CLEAR & FORSTED LENSES

3" ARCHITECTURAL CEILING CYLINDERS

CATALOG NO.	DESCRIPTION
CMC3-MCTP-DD-WH	5W/7W/9W 75LM/W 30K/40K/50K 3"D X 9.7"H 120-277V, 25°
CMC3-MCTP-DD-BK	5W/7W/9W 75LM/W 30K/40K/50K 3"D X 9.7"H 120-277V, 25°
CMC3-TRM-AG	3in Cylinder Trim, Anodized Gold
CMC3-TRM-BN	3in Cylinder Trim, Brushed Nickel
CMC3-HCDK-BK	3in Cylinder Honeycomb Diffuser Kit, Black
CMC3-HCDK-AG	3in Cylinder Honeycomb Diffuser Kit, Anodized Gold
CWMC3-DL32	CMC3 And WMC3 32Mm Acrylic Drop Lens
SUSPENSION ACCESSORIES FOR CMC SERIES	
CMC-CS-8FT-WH	Suspension Cable & Canopy Set For CMC Series, 8Ft, 5-Wire, White
CMC-CS-8FT-BK	Suspension Cable & Canopy Set For CMC Series, 8Ft, 5-Wire, Black
CMC-SRK-218-5C-WH	Universal Swivel W/ Rod Kit, 18 Or 36 Inches, 5-Wire, White
CMC-SRK-218-5C-BK	Universal Swivel W/ Rod Kit, 18 Or 36 Inches, 5-Wire, Black
CMC-SRK-224-5C-WH	Universal Swivel W/ Rod Kit, 24 Or 48 Inches, 5-Wire, White
CMC-SRK-224-5C-BK	Universal Swivel W/ Rod Kit, 24 Or 48 Inches, 5-Wire, Black
CMC-SRK-340-5C-WH	Universal Swivel W/ Rod Kit, 40 Or 80 Or 120 Inches, 5-Wire, White
CMC-SRK-340-5C-BK	Universal Swivel W/ Rod Kit, 40 Or 80 Or 120 Inches, 5-Wire, Black



2" ARCHITECTURAL CEILING CYLINDERS WITH INTERNAL DRIVERS

INCL. CLEAR & FORSTED LENSES

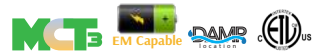

CATALOG NO.	DESCRIPTION	REF.
CMC2-MCT-DT-WH	6W 450LM 30K/40K/50K 9"H 120V, 40°	1
CMC2-MCT-DT-BK	6W 450LM 30K/40K/50K 9"H 120V, 40°	2
CMC2L-MCT-DT-WH	6W 450LM 30K/40K/50K 12"H 120V, 40°	3
CMC2L-MCT-DT-BK	6W 450LM 30K/40K/50K 12"H 120V, 40°	4
CMC2XL-MCT-DD-BK	20W 1500LM 30K/40K/50K 18"H 120-277V	5
CMC2XL-MCT-DD-WH	20W 1500LM 30K/40K/50K 18"H 120-277V	6
CMCS2L-MCT-DT-WH	6W 450LM 30K/40K/50K 12"H SQUARE	7
CMCS2L-MCT-DT-BK	6W 450LM 30K/40K/50K 12"H SQUARE	8
CMCS2XL-MCT-DT-WH	20W 1500LM 30K/40K/50K 18"H SQUARE	9
CMCS2XL-MCT-DT-BK	20W 1500LM 30K/40K/50K 18"H SQUARE	10
CMCS2XXL-MCT-DT-WH	20W 1500LM 30K/40K/50K 24"H SQUARE	11
CMCS2XXL-MCT-DT-BK	20W 1500LM 30K/40K/50K 24"H SQUARE	12
CMC2-TRM-AG	2in Cylinder Trim, Anodized Gold	13
CMC2-TRM-BN	2in Cylinder Trim, Brushed Nickel	14
CMC2-TRMWM-AG	Decorative Wide-Mouth Replacement Lens Cap for CMC2, Anodized Gold	15
CMC2-TRMWM-BN	Decorative Wide-Mouth Replacement Lens Cap for CMC2, Brushed Nickel	16
CMC2-HCDK-BK	2in Cylinder Honeycomb Diffuser Kit, Black	17
CMC2-HCDK-AG	2in Cylinder Honeycomb Diffuser Kit, Anodized Gold	18
CMC2-DS-BG	Decorative Shield Reflector Replacement For Lens Cap Of CMC2, Black Gold	19
CMC2-DS-WG	Decorative Shield Reflector Replacement For Lens Cap Of CMC2, White Gold	20
CMC2-DCR-BG	Decorative Cone Reflector Kit for CMC2, Black Gold	21
CMC2-DCR-WG	Decorative Cone Reflector Kit for CMC2, White Gold	22
CMC2-PS12-WG-KIT	CMC2 12in Pan Shade, White/Gold	23
CMC2-PS12-BG-KIT	CMC2 12in Pan Shade, Black/Gold	24
CMC2-PS14-WG-KIT	CMC2 14in Pan Shade, White/Gold	25
CMC2-PS14-BG-KIT	CMC2 14in Pan Shade, Black/Gold	26
CWMC2-DL32	CMC2 And WMC2 32Mm Acrylic Drop Lens	29
SUSPENSION ACCESSORIES FOR CMC SERIES		
CMC-CS-8FT-WH	Suspension Cable & Canopy Set For CMC Series, 8Ft, 5-Wire, White	30
CMC-CS-8FT-BK	Suspension Cable & Canopy Set For CMC Series, 8Ft, 5-Wire, Black	31
CMC-SRK-218-5C-WH	Universal Swivel W/ Rod Kit, 18 Or 36 Inches, 5-Wire, White	32
CMC-SRK-218-5C-BK	Universal Swivel W/ Rod Kit, 18 Or 36 Inches, 5-Wire, Black	33
CMC-SRK-224-5C-WH	Universal Swivel W/ Rod Kit, 24 Or 48 Inches, 5-Wire, White	34
CMC-SRK-224-5C-BK	Universal Swivel W/ Rod Kit, 24 Or 48 Inches, 5-Wire, Black	35
CMC-SRK-340-5C-WH	Universal Swivel W/ Rod Kit, 40 Or 80 Or 120 Inches, 5-Wire, White	36
CMC-SRK-340-5C-BK	Universal Swivel W/ Rod Kit, 40 Or 80 Or 120 Inches, 5-Wire, Black	37

COMMERCIAL
CYLINDER
LIGHTS



4" ARCHITECTURAL CEILING CYLINDERS

INCL. CLEAR & FORSTED LENSES



COMMERCIAL
CYLINDER
LIGHTS

CATALOG NO.	DESCRIPTION	REF.
4" ROUND ARCHITECTURAL CEILING CYLINDERS		
CMC4-MCTP-DD-WH	9W/12W/15W 75LM/W 30K/40K/50K 9.6"H 120-277V, 40°	1
CMC4-MCTP-DD-BK	9W/12W/15W 75LM/W 30K/40K/50K 9.6"H 120-277V, 40°	2
CMC4HL-MCTP-DD-WH	24W/32W/40W 80LM/W 30K/40K/50K 10"H HIGH-LUMEN	3
CMC4HL-MCTP-DD-BK	24W/32W/40W 80LM/W 30K/40K/50K 10"H HIGH-LUMEN	4
CMC4S-MCTP-DD-WH	9W/12W/15W 76LM/W 30K/40K/50K 5"H	5
CMC4S-MCTP-DD-BK	9W/12W/15W 76LM/W 30K/40K/50K 5"H	6
4" SQUARE ARCHITECTURAL CEILING CYLINDERS		
CMCS4-MCTP-DD-WH	21W/28W/35W 80LM/W 30K/40K/50K 10"H	7
CMCS4-MCTP-DD-BK	21W/28W/35W 80LM/W 30K/40K/50K 10"H	8
CMCS4S-MCTP-DD-WH	9W/12W/15W 76LM/W 30K/40K/50K 5"H	9
CMCS4S-MCTP-DD-BK	9W/12W/15W 76LM/W 30K/40K/50K 5"H	10
CMC46-ULK	5W 400LM 30K/40K/50K UP LIGHT KIT	11
CMC-JBCK-WH	Cylinder And Pendant Lighting J-Box Cover Canopy For Up To 4 Pipe Entries, Wh	12
CMC-JBCK-BK	Cylinder And Pendant Lighting J-Box Cover Canopy For Up To 4 Pipe Entries, Bk	13
CMC4-TRM-AG	4in Cylinder Trim, Anodized Gold	14
CMC4-TRM-BN	4in Cylinder Trim, Brushed Nickel	15
CMC4-HCDK-BK	4in Cylinder Honeycomb Diffuser Kit, Black	16
CMC4-HCDK-AG	4in Cylinder Honeycomb Diffuser Kit, Anodized Gold	17
CMC4-FS14-WG-KIT	CMC4 14in Flat Shade, White/Gold	18
CMC4-FS14-BG-KIT	CMC4 14in Flat Shade, Black/Gold	19
CMC4-FS14-WS-KIT	CMC4 14in Flat Shade, White/Silver	20
CMC4-FS14-BS-KIT	CMC4 14in Flat Shade, Black/Silver	21
CMC4-DS14-WG-KIT	CMC4 14in Dome Shade, White/Gold	22
CMC4-DS14-BG-KIT	CMC4 14in Dome Shade, Black/Gold	23
CMC4-DS14-WS-KIT	CMC4 14in Dome Shade, White/Silver	24
CMC4-DS14-BS-KIT	CMC4 14in Dome Shade, Black/Silver	25
CMC4-PCR-KIT	12in Dia. Prismatic Pc Highbay Reflector Kit For CMC4	26
CMC4-WPCK-WH	CMC4 Weatherproof Conversion Kit For Cord Or Down-Rod, White	27
CMC4-WPCK-BK	CMC4 Weatherproof Conversion Kit For Cord Or Down-Rod, Black	28
CMCS4-WPCK-WH	CMCS4 Weatherproof Conversion Kit For Cord Or Down-Rod, White	29
CMCS4-WPCK-BK	CMCS4 Weatherproof Conversion Kit For Cord Or Down-Rod, Black	30
CMC4-DL32	WMC 4in 32Mm Acrylic Drop Lens	31
SUSPENSION ACCESSORIES FOR CMC SERIES		
CMC-CS-8FT-WH	Suspension Cable & Canopy Set For CMC Series, 8Ft, 5-Wire, White	32
CMC-CS-8FT-BK	Suspension Cable & Canopy Set For CMC Series, 8Ft, 5-Wire, Black	33
CMC-SRK-218-5C-WH	Universal Swivel W/ Rod Kit, 18 Or 36 Inches, 5-Wire, White	34
CMC-SRK-218-5C-BK	Universal Swivel W/ Rod Kit, 18 Or 36 Inches, 5-Wire, Black	35
CMC-SRK-224-5C-WH	Universal Swivel W/ Rod Kit, 24 Or 48 Inches, 5-Wire, White	36
CMC-SRK-224-5C-BK	Universal Swivel W/ Rod Kit, 24 Or 48 Inches, 5-Wire, Black	37
CMC-SRK-340-5C-WH	Universal Swivel W/ Rod Kit, 40 Or 80 Or 120 Inches, 5-Wire, White	38
CMC-SRK-340-5C-BK	Universal Swivel W/ Rod Kit, 40 Or 80 Or 120 Inches, 5-Wire, Black	39





CMC6S
SHORT MODELS



CMC-JBCK-BK BLACK
CMC-JBCK-WH WHITE

Shown with
Drop Lens



Shown with
Up Light Kit

6" ARCHITECTURAL CEILING CYLINDERS

INCL. CLEAR &
FORSTED LENSES



CATALOG NO.	DESCRIPTION
6" ROUND ARCHITECTURAL CEILING CYLINDERS	
CMC6-MCTP-DD-WH	21W/28W/35W 75LM/W 30K/40K/50K 8.74"H 120-277V, 25°
CMC6-MCTP-DD-BK	21W/28W/35W 75LM/W 30K/40K/50K 8.74"H 120-277V, 25°
CMC6S-MCTP-DD-WH	18W/24W/30W 80LM/W 30K/40K/50K 6.75"H
CMC6S-MCTP-DD-BK	18W/24W/30W 80LM/W 30K/40K/50K 6.75"H
CMC46-ULK	5W 400LM 30K/40K/50K UP LIGHT KIT
CMC-JBCK-WH	Cylinder And Pendant Lighting J-Box Cover Canopy For Up To 4 Pipe Entries, Wh
CMC-JBCK-BK	Cylinder And Pendant Lighting J-Box Cover Canopy For Up To 4 Pipe Entries, Bk
CMC6-TRM-AG	6in Cylinder Trim, Anodized Gold
CMC6-TRM-BN	6in Cylinder Trim, Brushed Nickel
CMC6-WPCK-WH	CMC6 Weatherproof Conversion Kit For Cord Or Down-Rod, White
CMC6-WPCK-BK	CMC6 Weatherproof Conversion Kit For Cord Or Down-Rod, Black
CMC6-HCDK-AG	6in Cylinder Honeycomb Diffuser Kit, Anodized Gold
CMC6-HCDK-BK	6in Cylinder Honeycomb Diffuser Kit, Black
CWMC6-DL32	CMC6 And WMC6 32Mm Acrylic Drop Lens
SUSPENSION ACCESSORIES FOR CMC SERIES	
CMC-CS-8FT-WH	Suspension Cable & Canopy Set For CMC Series, 8Ft, 5-Wire, White
CMC-CS-8FT-BK	Suspension Cable & Canopy Set For CMC Series, 8Ft, 5-Wire, Black
CMC-SRK-218-5C-WH	Universal Swivel W/ Rod Kit, 18 Or 36 Inches, 5-Wire, White
CMC-SRK-218-5C-BK	Universal Swivel W/ Rod Kit, 18 Or 36 Inches, 5-Wire, Black
CMC-SRK-224-5C-WH	Universal Swivel W/ Rod Kit, 24 Or 48 Inches, 5-Wire, White
CMC-SRK-224-5C-BK	Universal Swivel W/ Rod Kit, 24 Or 48 Inches, 5-Wire, Black
CMC-SRK-340-5C-WH	Universal Swivel W/ Rod Kit, 40 Or 80 Or 120 Inches, 5-Wire, White
CMC-SRK-340-5C-BK	Universal Swivel W/ Rod Kit, 40 Or 80 Or 120 Inches, 5-Wire, Black





Shown with
Ext. Cyl.



Shown with
Ext. Cyl.



9" ARCHITECTURAL CEILING CYLINDERS

INCL. CLEAR & FORSTED LENSES

CATALOG NO.	DESCRIPTION
CMC9-MCTP-D-BK	60W/70W/80W 80LM/W 30K/40K/50K 10"H 120-277V, 60°
CMC9-MCTP-D-WH	60W/70W/80W 80LM/W 30K/40K/50K 10"H 120-277V, 60°
CMC9-EC-BK	Decorative Extension Cylinder Black, Adds 5"H
CMC9-EC-WH	Decorative Extension Cylinder White, Adds 5"H
CMC9-HCDK-BK	9in Cylinder Honeycomb Diffuser Kit, Black
CMC9-REFL-BK	Inside-Black Reflector
CMC9-REFL-WH	Inside-White Reflector
SUSPENSION ACCESSORIES FOR CMC SERIES	
CMC-CS-8FT-WH	Suspension Cable & Canopy Set For CMC Series, 8Ft, 5-Wire, White
CMC-CS-8FT-BK	Suspension Cable & Canopy Set For CMC Series, 8Ft, 5-Wire, Black
CMC-SRK-218-5C-WH	Universal Swivel W/ Rod Kit, 18 Or 36 Inches, 5-Wire, White
CMC-SRK-218-5C-BK	Universal Swivel W/ Rod Kit, 18 Or 36 Inches, 5-Wire, Black
CMC-SRK-224-5C-WH	Universal Swivel W/ Rod Kit, 24 Or 48 Inches, 5-Wire, White
CMC-SRK-224-5C-BK	Universal Swivel W/ Rod Kit, 24 Or 48 Inches, 5-Wire, Black
CMC-SRK-340-5C-WH	Universal Swivel W/ Rod Kit, 40 Or 80 Or 120 Inches, 5-Wire, White
CMC-SRK-340-5C-BK	Universal Swivel W/ Rod Kit, 40 Or 80 Or 120 Inches, 5-Wire, Black

FACTORY-INSTALLED OPTIONS, ENTER DESIRED OPTION CODE(S) AS LINE ITEMS ON YOUR PURCHASE ORDER UNDER THE PRODUCT CATALOG NUMBER

WATTS	EM OPTION	DESCRIPTION	PHOTOCELL	DESCRIPTION	PAINT	SENSOR	DESCRIPTION
4" & 6"	OPT-EM-CMC46	INTERNAL		N/A	N/A	N/A	N/A
9" white	OPT-EM-CMC9-WH	Extension Cylinder - White					
9" black	OPT-EM-CMC9-BK	Extension Cylinder - Black					

CMC RGBW CYLINDER LIGHTS, PENDANT OR SURFACE MOUNT, APP CONTROLLED





CATALOG NO.	DESCRIPTION	ARRIVES THIS SEASON CHECK & PRE-ORDER	PKG. QTY.
CMC2L-RGBW-BK	6W 300LM 27K-50K + RGB		6
CMC2L-RGBW-WH	6W 300LM 27K-50K + RGB		6
CMC3-RGBW-BK	9W 550LM 27K-50K + RGB		6
CMC3-RGBW-WH	9W 550LM 27K-50K + RGB		6
CMC4-RGBW-BK	15W 900LM 27K-50K + RGB		6
CMC4-RGBW-WH	15W 900LM 27K-50K + RGB		6
CMC6-RGBW-BK	20W 1200LM 27K-50K + RGB		8
CMC6-RGBW-WH	20W 1200LM 27K-50K + RGB		8



**X-GEN LED T8 PC+ALUM. SHATTER-PROOF LAMPS,
TYPE A+B FOR A/C OR BALLAST**

NO PARTIAL/MUST SHIP CASE QTY.



CATALOG NO.	DESCRIPTION	PKG. QTY.
2FT 	T8-EZX-PRO-2FT-10W-40K-C 10W 1300LM 4000K Clear, G13, Type A & B	25
	T8-EZX-PRO-2FT-10W-40K-F 10W 1300LM 4000K Frosted, G13, Type A & B	25
4FT 	T8-EZX-PRO-2FT-10W-50K-C 10W 1300LM 5000K Clear, G13, Type A & B	25
	T8-EZX-PRO-2FT-10W-50K-F 10W 1300LM 5000K Frosted, G13, Type A & B	25
4FT 	T8-EZX-PRO-4FT-12W-40K-F 12W 1560LM 4000K Frosted, G13, Type A & B	25
	T8-EZX-PRO-4FT-12W-50K-F 12W 1560LM 5000K Frosted, G13, Type A & B	25
	T8-EZX-PRO-4FT-18W-40K-C 18W 2340LM 4000K Clear, G13, Type A & B	25
	T8-EZX-PRO-4FT-18W-40K-F 18W 2340LM 4000K Frosted, G13, Type A & B	25
	T8-EZX-PRO-4FT-18W-50K-C 18W 2340LM 5000K Clear, G13, Type A & B	25
	T8-EZX-PRO-4FT-18W-50K-F 18W 2340LM 5000K Frosted, G13, Type A & B	25

X-GEN 3CCT LED T8 GLASS LAMPS

3 COLOR-TEMPERATURES IN ONE LAMP TYPE A+B (A/C OR BALLAST)

NO PARTIAL/MUST SHIP CASE QTY.



CATALOG NO.	DESCRIPTION	PKG. QTY.
2FT 3FT 4FT 	T8-EZX-MCT-GS-2FT-8W-C 8W 1216LM 35K/40K/50K Clear, G13, Type A & B	12
	T8-EZX-MCT-GS-2FT-8W-F 8W 1216LM 35K/40K/50K Frosted, G13, Type A & B	12
	T8-EZX-MCT-GS-3FT-12W-C 12W 1500LM 35K/40K/50K Clear, G13, Type A & B	12
	T8-EZX-MCT-GS-3FT-12W-F 12W 1500LM 35K/40K/50K Frosted, G13, Type A & B	12
	T8-EZX-MCT-GS-4FT-15W-C 15W 1875LM 35K/40K/50K Clear, G13, Type A & B	12
	T8-EZX-MCT-GS-4FT-15W-F 15W 1875LM 35K/40K/50K Frosted, G13, Type A & B	12

X-GEN SELECTABLE-POWER LED T8 GLASS LAMPS,

TYPE B FOR DIRECT A/C (BALLAST OVERRIDE)

NO PARTIAL/MUST SHIP CASE QTY.



CATALOG NO.	DESCRIPTION	PKG. QTY.
4FT 	T8-EZX-TB-4FT-12-18W-50K-F 12W/15W/18W 120LM/W 5000K Frosted, G13, Type B	12
	T8-EZX-TB-4FT-12-18W-50K-C 12W/15W/18W 120LM/W 5000K Clear, G13, Type B	12
	T8-EZX-TB-4FT-12-18W-40K-F 12W/15W/18W 120LM/W 4000K Frosted, G13, Type B	12
	T8-EZX-TB-4FT-12-18W-40K-C 12W/15W/18W 120LM/W 4000K Clear, G13, Type B	12

U-SHAPED T8 EZ6 LED GLASS LAMPS

NO PARTIAL/MUST SHIP CASE QTY.



CATALOG NO.	DESCRIPTION	PKG. QTY.
Lamp 	T8-EZ6-U2F-15W-41K-C 15W 2100LM 4100K Ballast Compatible Or 100-277 Ac	10
	T8-EZ6-U2F-15W-41K-F 15W 2000LM 4100K Ballast Compatible Or 100-277 Ac	10
	T8-EZ6-U2F-15W-50K-C 15W 2100LM 5000K Ballast Compatible Or 100-277 Ac	10
	T8-EZ6-U2F-15W-50K-F 15W 2000LM 5000K Ballast Compatible Or 100-277 Ac	10

U-SHAPED T8 LED PLASTIC/ALUMINUM LAMPS

Works 3 ways: 1) With existing electronic ballast 2) A/C direct one end 3) A/C direct 2 ends

NO PARTIAL/MUST SHIP CASE QTY.



CATALOG NO.	DESCRIPTION	PKG. QTY.
	T8-U2F-EZ3-15W-41K-C 15W 1450LM 4100K BALLAST COMPATIBLE OR 100-277 AC	10
	T8-U2F-EZ3-15W-50K-C 15W 1500LM 5000K BALLAST COMPATIBLE OR 100-277 AC	10

WHILE SUPPLIES LAST

NEW GEN. - TYPE A + B (DOUBLE UL) 2FT. 3FT. & 4FT. LED T8-EZ6 **GLASS LAMPS, 180°(CLEAR) & 240° (FROSTED) Beam Angle, ELECTRONIC BALLASTS (TYPE A), ALSO WORK WITH A/C DIRECT (120-277V) ONE END OR BOTH ENDS (TYPE B)**

NO PARTIAL/MUST SHIP CASE QTY.



CATALOG NO.	DESCRIPTION	PKG. QTY.
2FT 	T8-EZ6-GS-2FT-10W-30K-C 10W 1250LM 3000K Clear, G13, Type A & B	12 & 36
	T8-EZ6-GS-2FT-10W-30K-F 10W 1200LM 3000K Frosted, G13, Type A & B	12 & 36
	T8-EZ6-GS-2FT-10W-35K-C 10W 1250LM 3500K Clear, G13, Type A & B	12 & 36
	T8-EZ6-GS-2FT-10W-35K-F 10W 1200LM 3500K Frosted, G13, Type A & B	12 & 36
	T8-EZ6-GS-2FT-10W-40K-C 10W 1250LM 4000K Clear, G13, Type A & B	12 & 36
	T8-EZ6-GS-2FT-10W-40K-F 10W 1200LM 4000K Frosted, G13, Type A & B	12 & 36
	T8-EZ6-GS-2FT-10W-50K-C 10W 1250LM 5000K Clear, G13, Type A & B	12 & 36
	T8-EZ6-GS-2FT-10W-50K-F 10W 1200LM 5000K Frosted, G13, Type A & B	12 & 36
3FT 	T8-EZ6-GS-3FT-12W-40K-C 12W 1600LM 4000K Clear, G13, Type A & B	12 & 36
	T8-EZ6-GS-3FT-12W-40K-F 12W 1560LM 4000K Frosted, G13, Type A & B	12 & 36
	T8-EZ6-GS-3FT-12W-50K-C 12W 1600LM 5000K Clear, G13, Type A & B	12 & 36
	T8-EZ6-GS-3FT-12W-50K-F 12W 1560LM 5000K Frosted, G13, Type A & B	12 & 36
	T8-EZ6-GS-4FT-15W-30K-C 15W 1875LM 3000K Clear, G13, Type A & B	12 & 36
	T8-EZ6-GS-4FT-15W-30K-F 15W 1800LM 3000K Frosted, G13, Type A & B	12 & 36
4FT 	T8-EZ6-GS-4FT-15W-35K-C 15W 1875LM 3500K Clear, G13, Type A & B	12 & 36
	T8-EZ6-GS-4FT-15W-35K-F 15W 1800LM 3500K Frosted, G13, Type A & B	12 & 36
	T8-EZ6-GS-4FT-15W-40K-C 15W 1875LM 4000K Clear, G13, Type A & B	12 & 36
	T8-EZ6-GS-4FT-15W-40K-F 15W 1800LM 4000K Frosted, G13, Type A & B	12 & 36
	T8-EZ6-GS-4FT-15W-50K-C 15W 1875LM 5000K Clear, G13, Type A & B	12 & 36
	T8-EZ6-GS-4FT-15W-50K-F 15W 1800LM 5000K Frosted, G13, Type A & B	12 & 36
	T8-EZ6-GS-4FT-18W-30K-C 18W 2250LM 3000K Clear, G13, Type A & B	12 & 36
	T8-EZ6-GS-4FT-18W-30K-F 18W 2160LM 3000K Frosted, G13, Type A & B	12 & 36
	T8-EZ6-GS-4FT-18W-35K-C 18W 2250LM 3500K Clear, G13, Type A & B	12 & 36
	T8-EZ6-GS-4FT-18W-35K-F 18W 2160LM 3500K Frosted, G13, Type A & B	12 & 36
4FT 	T8-EZ6-GS-4FT-18W-40K-C 18W 2250LM 4000K Clear, G13, Type A & B	12 & 36
	T8-EZ6-GS-4FT-18W-40K-F 18W 2160LM 4000K Frosted, G13, Type A & B	12 & 36
	T8-EZ6-GS-4FT-18W-50K-C 18W 2250LM 5000K Clear, G13, Type A & B	12 & 36
	T8-EZ6-GS-4FT-18W-50K-F 18W 2160LM 5000K Frosted, G13, Type A & B	12 & 36

4FT. T8 GLASS LAMPS

WORKS WITH A/C DIRECT (120-277V) ONE END OR BOTH ENDS (TYPE B) NO PARTIAL/MUST SHIP CASE QTY.



CATALOG NO.	DESCRIPTION	PKG. QTY.
4FT 	T8-4FT-TYPB-17W-40K-F 17W 2200LM 4000K FROSTED	12 & 36
	T8-4FT-TYPB-17W-40K-C 17W 2200LM 4000K CLEAR	12 & 36
	T8-4FT-TYPB-17W-50K-F 17W 2200LM 5000K FROSTED	12 & 36
	T8-4FT-TYPB-17W-50K-C 17W 2200LM 5000K CLEAR	12 & 36
	T8-4FT-TYPB-14W-40K-F 14W 1800LM 4000K FROSTED	13 & 36
	T8-4FT-TYPB-10.5WHL-40K-F 10.5W 1700LM 4000K FROSTED	12 & 36
	T8-4FT-TYPB-10.5WHL-40K-C 10.5W 1700LM 4000K CLEAR	12 & 36

4FT. T8 LED GLASS LAMPS DIMMABLE DIRECT A/C (one end N+L)

NO PARTIAL/MUST SHIP CASE QTY.



CATALOG NO.	DESCRIPTION	PKG. QTY.
4FT 	WHILE SUPPLIES LAST T8-4FT-DIM-18W-35K-C 18W 1900LM 3500K 90-140VAC, CLEAR	12 & 36
	T8-4FT-DIM-18W-35K-F 18W 1900LM 3500K 90-140VAC, FROSTED	12 & 36
	T8-4FT-DIM-18W-40K-C 18W 2150LM 4000K 90-140VAC, CLEAR	12 & 36
	T8-4FT-DIM-18W-50K-F 18W 2150LM 5000K 90-140VAC, FROSTED	12 & 36

NEW GEN HIGH LUMEN 4FT. LED T8 GLASS LAMPS DIMMABLE DIRECT A/C (ONE END N+L)

NO PARTIAL/MUST SHIP CASE QTY.



CATALOG NO.	DESCRIPTION	PKG. QTY.
4FT T8-HL-4FT-DIM-18W-40K-C	18W 2250LM 4000K Clear	12 & 36
T8-HL-4FT-DIM-18W-40K-F	18W 2160LM 4000K Frosted	12 & 36
T8-HL-4FT-DIM-18W-50K-C	18W 2250LM 5000K Clear	12 & 36
T8-HL-4FT-DIM-18W-50K-F	18W 2160LM 5000K Frosted	12 & 36

8FT. SPLIT VERSION LED T8 LAMPS, TYPE B

NO PARTIAL/MUST SHIP CASE QTY.



CATALOG NO.	DESCRIPTION	PKG. QTY.
8FT T8-HL-8FT-SPLIT-42W-40K-C	42W 6000LM 4000K Clear	18
T8-HL-8FT-SPLIT-42W-40K-F	42W 5500LM 4000K Frosted	18
T8-HL-8FT-SPLIT-42W-50K-C	42W 6000LM 5000K Clear	18
T8-HL-8FT-SPLIT-42W-50K-F	42W 5500LM 5000K Frosted	18
T8-R17D-CONV	R17D Conversion kit	

8FT. LED T8 LAMPS, TYPE B DIRECT A/C 100-277V (TWO ENDS)

NO PARTIAL/MUST SHIP CASE QTY.



CATALOG NO.	DESCRIPTION	PKG. QTY.
8FT T8-HL-8FT-40W-40K-C	40W 4600LM 4000K Clear	20
T8-HL-8FT-40W-40K-F	40W 4400LM 4000K Frosted	20
T8-HL-8FT-40W-50K-C	40W 4600LM 5000K Clear	20
T8-HL-8FT-40W-50K-F	40W 4400LM 5000K Frosted	20

T12 X-GEN SELECTABLE-CCT LED LAMPS, TYPE A+B FOR A/C OR BALLAST

NO PARTIAL/MUST SHIP CASE QTY.



CATALOG NO.	DESCRIPTION	PKG. QTY.
T12-EZX-MCT-GS-4FT-16W-F	16W 2000LM 30K/40K/50K/65K Frosted, G13, Type B	20

4FT. LED T5 GLASS LAMPS, TYPE A+B, WORK WITH DIRECT A/C OR BALLAST



CATALOG NO.	DESCRIPTION	PKG. QTY.
4FT T5-EZ6-GS-4FT-24W-40K-F	24W 3000LM 4000K Frosted	12 & 36
T5-EZ6-GS-4FT-24W-50K-F	24W 3000LM 4000K Frosted	12 & 36

4FT. LED T5 GLASS LAMPS

NO PARTIAL/MUST SHIP CASE QTY.

CATALOG NO.	DESCRIPTION	PKG. QTY.
4FT T5-TYPA-27W-40K-F	27W 3200LM 4000K FROSTED	40
T5-TYPA-27W-50K-F	27W 3200LM 5000K FROSTED	40
T5-TYPB-25W-40K-F	25W 3200LM 4000K FROSTED	40

5FT. & 6FT. LED REFRIGERATOR LAMPS

NO PARTIAL/MUST SHIP CASE QTY.



CATALOG NO.	DESCRIPTION	PKG. QTY.
5FT T-RFG-5FT-22W-50K-C	22W 3100LM 5000K CLEAR	25
6FT T-RFG-6FT-30W-50K-C	30W 4200LM 5000K CLEAR	25

LED EMERGENCY DRIVER FOR ALL T8 LAMPS



CATALOG NO.	DESCRIPTION
ELB-18150-B	Field-installed emergency ballast for all T8 Lamps; Input voltage: 100-277VAC, 50-60Hz; Output: 18W Maximum for 90 minutes

COMMERCIAL
T8
LAMPS

LED COMMERCIAL RECESSED LIGHT
(CLIP-ON/SNAP-IN) WITH OR WITHOUT HOUSING



WATTS	LUMENS
15W	1200-1275LM
20W	1600-1720LM









15W ENGINE

20W ENGINE

40W MAX ENGINE

 CRLC-EGN-15W-30K-D CRLC-EGN-15W-40K-D CRLC-EGN-15W-50K-D CRLC-EGN-15W-MCT-D	 CRLC-EGN-20W-50K-D CRLC-EGN-20W-MCT-D CRLC-EGN-20W-MCTP-D	 CRLC-EGN-40W-MCTP-D
15W RECESSED LIGHT	20W RECESSED LIGHT	40W RECESSED LIGHT

COMMERCIAL
COMMERCIAL
RECESSED

4" ROUND TRIM		4" ROUND RECESSED LIGHT	15W ENGINE			20W ENGINE			40W MAX ENGINE		
HAZE FINISH & WHITE RING	OPEN		 CRLC-TRM-4	→	CRLC4-15W-MCT-D	CRLC4-20W-MCT-D CRLC4-20W-MCTP-D	CRLC4-40W-MCTP-D				
	WALL WASH		 CRLC-TRM-4A	→	CRLC4-15W-30K-A-D CRLC4-15W-40K-A-D CRLC4-15W-50K-A-D CRLC4-15W-MCT-A-D	CRLC4-20W-50K-A-D CRLC4-20W-MCT-A-D CRLC4-20W-MCTP-A-D	CRLC4-40W-MCTP-A-D				
WHITE FINISH & WHITE RING	OPEN		 CRLC-TRM-4-WH	→	CRLC4-15W-30K-D-WH CRLC4-15W-50K-D-WH CRLC4-15W-MCT-D-WH	CRLC4-20W-50K-D-WH CRLC4-20W-MCT-D-WH CRLC4-20W-MCTP-D-WH	CRLC4-40W-MCTP-D-WH				
	WALL WASH		 CRLC-TRM-4A-WH	→	CRLC4-15W-30K-A-D-WH CRLC4-15W-40K-A-D-WH CRLC4-15W-50K-A-D-WH CRLC4-15W-MCT-A-D-WH	CRLC4-20W-50K-A-D-WH CRLC4-20W-MCT-A-D-WH CRLC4-20W-MCTP-A-D-WH	CRLC4-40W-MCTP-A-D-WH				
4" SQUARE TRIM	HAZE FINISH & WHITE RING		OPEN	 CRLC-TRM-4S	→	CRLC4-15W-30K-S-D CRLC4-15W-40K-S-D CRLC4-15W-50K-S-D CRLC4-15W-MCT-S-D	CRLC4-20W-50K-S-D CRLC4-20W-MCT-S-D CRLC4-20W-MCTP-S-D	CRLC4-40W-MCTP-S-D			
			WALL WASH	 CRLC-TRM-4SA	→	CRLC4-15W-30K-SA-D CRLC4-15W-40K-SA-D CRLC4-15W-50K-SA-D CRLC4-15W-MCT-SA-D	CRLC4-20W-50K-SA-D CRLC4-20W-MCT-SA-D CRLC4-20W-MCTP-SA-D	CRLC4-40W-MCTP-SA-D			
	WHITE FINISH & WHITE RING		OPEN	 CRLC-TRM-4S-WH	→	CRLC4-15W-30K-S-D-WH CRLC4-15W-40K-S-D-WH CRLC4-15W-50K-S-D-WH CRLC4-15W-MCT-S-D-WH	CRLC4-20W-50K-S-D-WH CRLC4-20W-MCT-S-D-WH CRLC4-20W-MCTP-S-D-WH	CRLC4-40W-MCTP-S-D-WH			
		WALL WASH	 CRLC-TRM-4SA-WH	→	CRLC4-15W-30K-SA-D-WH CRLC4-15W-40K-SA-D-WH CRLC4-15W-50K-SA-D-WH CRLC4-15W-MCT-SA-D-WH	CRLC4-20W-50K-SA-D-WH CRLC4-20W-MCT-SA-D-WH CRLC4-20W-MCTP-SA-D-WH	CRLC4-40W-MCTP-SA-D-WH				



ROUND & OPEN RECESSED LIGHT



SQUARE & OPEN RECESSED LIGHT



ROUND & WALL WASH RECESSED LIGHT



SQUARE & WALL WASH RECESSED LIGHT

LED COMMERCIAL RECESSED LIGHT
(CLIP-ON/SNAP-IN) WITH OR WITHOUT HOUSING













WATTS	LUMENS
15W	1200-1275LM
20W	1600-1720LM

15W ENGINE

20W ENGINE

40W MAX ENGINE

 MCT₃ CRLC-EGN-15W-30K-D CRLC-EGN-15W-40K-D CRLC-EGN-15W-50K-D CRLC-EGN-15W-MCT-D	 MCT₃ MCTP₃ CRLC-EGN-20W-50K-D CRLC-EGN-20W-MCT-D CRLC-EGN-20W-MCTP-D	 MCTP₃ 27W/34W/40W & 30K/35K/40K CRLC-EGN-40W-MCTP-D
15W RECESSED LIGHT	20W RECESSED LIGHT	40W RECESSED LIGHT

6" ROUND TRIM	HAZE FINISH & WHITE RING	OPEN	 CRLC-TRM-6	6" ROUND RECESSED LIGHT	CRLC6-15W-MCT-D	CRLC6-20W-MCT-D CRLC6-20W-MCTP-D	CRLC6-40W-MCTP-D	
		WALL WASH	 CRLC-TRM-6A		CRLC6-15W-30K-A-D CRLC6-15W-40K-A-D CRLC6-15W-50K-A-D CRLC6-15W-MCT-A-D	CRLC6-20W-50K-A-D CRLC6-20W-MCT-A-D CRLC6-20W-MCTP-A-D	CRLC6-40W-MCTP-A-D	
	WHITE FINISH & WHITE RING	OPEN	 CRLC-TRM-6-WH		CRLC6-15W-MCT-D-WH	CRLC6-20W-MCT-D-WH CRLC6-20W-MCTP-D-WH	CRLC6-40W-MCTP-D-WH	
		WALL WASH	 CRLC-TRM-6A-WH		CRLC6-15W-30K-A-D-WH CRLC6-15W-40K-A-D-WH CRLC6-15W-50K-A-D-WH CRLC6-15W-MCT-A-D-WH	CRLC6-20W-50K-A-D-WH CRLC6-20W-MCT-A-D-WH CRLC6-20W-MCTP-A-D-WH	CRLC6-40W-MCTP-A-D-WH	
	6" SQUARE TRIM	HAZE FINISH & WHITE RING	OPEN		 CRLC-TRM-6S	CRLC6-15W-30K-S-D CRLC6-15W-40K-S-D CRLC6-15W-50K-S-D CRLC6-15W-MCT-S-D	CRLC6-20W-50K-S-D CRLC6-20W-MCT-S-D CRLC6-20W-MCTP-S-D	CRLC6-40W-MCTP-S-D
			WALL WASH		 CRLC-TRM-6SA	CRLC6-15W-30K-SA-D CRLC6-15W-40K-SA-D CRLC6-15W-50K-SA-D CRLC6-15W-MCT-SA-D	CRLC6-20W-50K-SA-D CRLC6-20W-MCT-SA-D CRLC6-20W-MCTP-SA-D	CRLC6-40W-MCTP-SA-D
		WHITE FINISH & WHITE RING	OPEN		 CRLC-TRM-6S-WH	CRLC6-15W-30K-S-D-WH CRLC6-15W-40K-S-D-WH CRLC6-15W-50K-S-D-WH CRLC6-15W-MCT-S-D-WH	CRLC6-20W-50K-S-D-WH CRLC6-20W-MCT-S-D-WH CRLC6-20W-MCTP-S-D-WH	CRLC6-40W-MCTP-S-D-WH
			WALL WASH		 CRLC-TRM-6SA-WH	CRLC6-15W-30K-SA-D-WH CRLC6-15W-40K-SA-D-WH CRLC6-15W-50K-SA-D-WH CRLC6-15W-MCT-SA-D-WH	CRLC6-20W-50K-SA-D-WH CRLC6-20W-MCT-SA-D-WH CRLC6-20W-MCTP-SA-D-WH	CRLC6-40W-MCTP-SA-D-WH
8" ROUND TRIM	HAZE FINISH & WHITE RING	OPEN	 CRLC-TRM-8	CRLC8-15W-30K-D CRLC8-15W-MCT-D	CRLC8-20W-MCT-D CRLC8-20W-MCTP-D	CRLC8-40W-MCTP-D		
	WHITE FINISH & WHITE RING	OPEN	 CRLC-TRM-8-WH	CRLC8-15W-MCT-D-WH	CRLC8-20W-MCT-D-WH CRLC8-20W-MCTP-D-WH	CRLC8-40W-MCTP-D-WH		

COMMERCIAL
COMMERCIAL
RECESSED



FACTORY-INSTALLED OPTIONS, ENTER DESIRED OPTION CODE(S) AS LINE ITEMS ON YOUR PURCHASE ORDER UNDER THE PRODUCT CATALOG NUMBER

WATTS	EM OPTION	DESCRIPTION	PHOTOCELL	DESCRIPTION	PAINT	SENSOR	DESCRIPTION
ALL MODELS	OPT-EM-CRLC	EXTERNAL		N/A	N/A	N/A	N/A

LED COMMERCIAL RECESSED LIGHT, 120-277V

HAZE



CODE	TRIM DESCRIPTION	WATTS		COLOR TEMP		WATT
		CODE	DESCRIPTION	CODE	DESCRIPTION	
CRL4	4" LED Commercial trim only, 4 inches	27W	1950LM	30K	3000K	27W:
		40W	2387LM	40K	4000K	
		54W	4500LM	50K	5000K	
CRL6	6" LED Commercial trim only, 6 inches	18W	1639LM	30K	3000K	18W: 27W: 40W: 54W:
		27W	2387LM	40K	4000K	
		40W	3447LM	50K	5000K	
CRL8	8" LED Commercial trim only, 8 inches	18W	1639LM	30K	3000K	18W: 27W: 40W: 54W:
		27W	2387LM	40K	4000K	
		40W	3447LM	50K	5000K	
CRL10	10" LED Commercial trim only, 10 inches	18W	1639LM	30K	3000K	18W: 27W: 40W: 54W:
		27W	2387LM	40K	4000K	
		40W	3447LM	50K	5000K	



Shown with Housing (Not Incl., See Below)

SEE PAGE 115 FOR HOUSING

Sample Order:

CRL6-27W-40K



FACTORY-INSTALLED OPTIONS, ENTER DESIRED OPTION CODE(S) AS LINE ITEMS ON YOUR PURCHASE ORDER UNDER THE PRODUCT CATALOG NUMBER

WATTS	EM OPTION	DESCRIPTION	PHOTOCELL	DESCRIPTION	PAINT	SENSOR	DESCRIPTION
ALL MODELS	OPT-EM-CRL	EXTERNAL		N/A	N/A	N/A	N/A

BUILDER SERIES COMMERCIAL RECESS LIGHT, POWER AND CCT ADJUSTABLE



CATALOG NO.	DESCRIPTION
CRLX4-14-27W-MCTP	14W/20W/27W 80LM/W 30K/35K/40K 4" MCTP
CRLX6-18-40W-MCTP	18W/27W/40W 85LM/W 30K/35K/40K 6" MCTP
CRLX6-50-80W-MP-30K	50W/65W/80W 85LM/W 3000K 6" MP
CRLX6-50-80W-MP-40K	50W/65W/80W 85LM/W 4000K 6" MP
CRLX6-50-80W-MP-50K	50W/65W/80W 85LM/W 5000K 6" MP
CRLX8-18-40W-MCTP	18W/27W/40W 85LM/W 30K/35K/40K 8" MCTP
CRLX8-50-80W-MP-30K	50W/65W/80W 85LM/W 3000K 8" MP
CRLX8-50-80W-MP-40K	50W/65W/80W 85LM/W 4000K 8" MP
CRLX8-50-80W-MP-50K	50W/65W/80W 85LM/W 5000K 8" MP
CRLX10-18-40W-MCTP	18W/27W/40W 85LM/W 30K/35K/40K 10" MCTP
CRLX10-50-80W-MP-30K	50W/65W/80W 85LM/W 3000K 10" MP
CRLX10-50-80W-MP-40K	50W/65W/80W 85LM/W 4000K 10" MP
CRLX10-50-80W-MP-50K	50W/65W/80W 85LM/W 5000K 10" MP

SEE PAGE 115 FOR HOUSING











Back View ENGINE + TRIM

LED COMMERCIAL RECESSED LIGHT HOUSINGS

CATALOG NO.	DESCRIPTION	PKG. QTY.
 CRL-HSG-4	Commercial Recessed Light Housings, 4"	2
CRL-HSG-6	Commercial Recessed Light Housings, 6"	2
CRL-HSG-8	Commercial Recessed Light Housings, 8"	2
CRL-HSG-10	Commercial Recessed Light Housings, 10"	2
CRL-BH	Bar Hanger For Commercial Recessed Housings	

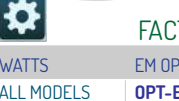
BUILDER SERIES COMMERCIAL RECESS LIGHT, POWER AND CCT ADJUSTABLE **MCTP**

CATALOG NO.	DESCRIPTION
 CRLE4-5-12W-MCTP-WH	5W/7W/12W 100LM/W 30K/40K/50K 4"
CRLE6-7-18W-MCTP-WH	7W/10W/18W 100LM/W 30K/40K/50K 6"
CRLE6-H0-25-40W-MCTP-WH	25W/30W/40W 100LM/W 30K/40K/50K 6", High-Output
 CRLE8-10-22W-MCTP-WH	10W/15W/22W 100LM/W 30K/40K/50K 8"
CRLE8-H0-34-52W-MCTP-WH	34W/42W/52W 100LM/W 30K/40K/50K 8", High-Output
 CRLE10-20-32W-MCTP-WH	20W/25W/32W 100LM/W 30K/40K/50K 10"
CRLE10-H0-26-40W-MCTP-WH	26W/32W/40W 100LM/W 30K/40K/50K 10", High-Output
 CRLE-RI-TBAR-UNV	Snap-In Comm. Recessed Light Universal TBAR Plate
CRLE-RI-UNV	Snap-In Comm. Recessed Light Universal Rough-In Plate
 CRLE4-TRM-BK	4" Snap-In Comm. Recessed Light 4In Black Trim + Ring Set
CRLE4-TRM-BN	4" Snap-In Comm. Recessed Light 4In Brushed Nickel Trim + Ring Set
 CRLE6-TRM-BK	6" Snap-In Comm. Recessed Light 6In Black Trim + Ring Set
CRLE6-TRM-BN	6" Snap-In Comm. Recessed Light 6In Brushed Nickel Trim + Ring Set
 CRLE8-TRM-BK	8" Snap-In Comm. Recessed Light 8In Black Trim + Ring Set
CRLE8-TRM-BN	8" Snap-In Comm. Recessed Light 8In Brushed Nickel Trim + Ring Set
 CRLE10-TRM-BK	10" Snap-In Comm. Recessed Light 10In Black Trim + Ring Set
CRLE10-TRM-BN	10" Snap-In Comm. Recessed Light 10In Brushed Nickel Trim + Ring Set

 **FACTORY-INSTALLED OPTIONS, ENTER DESIRED OPTION CODE(S) AS LINE ITEMS ON YOUR PURCHASE ORDER UNDER THE PRODUCT CATALOG NUMBER**

WATTS	EM OPTION	DESCRIPTION	PHOTOCELL	DESCRIPTION	PAINT	SENSOR	DESCRIPTION
ALL MODELS	OPT-EM-CRLE	EXTERNAL		N/A	N/A	N/A	N/A

LED COMMERCIAL SLIM RECESSED REGRESSED BAFFLE LIGHTS 120-277V, 0-10V DIMMING

 With External J-Box. Included. No need for Housing



CATALOG NO.	DESCRIPTION	PKG. QTY.
 RSLC6-BF-30K	12W 900LM 3000K 6"	12
RSLC6-BF-40K	12W 900LM 4000K 6"	12
RSLC8-BF-30K	24W 1900LM 3000K 8"	12
RSLC8-BF-40K	24W 1900LM 4000K 8"	12
RSLC8-BF-50K	24W 1900LM 5000K 8"	12
RSLC6-BF-MCT5	12W 900LM 27K/30K/35K/40K/50K 6"	
RSLC8-BF-MCT5	24W 1900LM 27K/30K/35K/40K/50K 8"	
RSL-BF-EXT-6FT	RSL-BF 6FT. DC extension cord	-
RSL-BF-EXT-10FT	RSL-BF 10FT. DC extension cord	-
RSL-BF-EXT-20FT	RSL-BF 20FT. DC extension cord	-

LED VANITY LIGHT, 120-277VAC



CATALOG NO.	DESCRIPTION	PKG. QTY.
2 Ft 	LVL-2FT-MCT-DD 20W 2200LM 30K/40K/50K	
	LVL-2FT-17W-30K 17W 1900LM 3000K	3
	LVL-2FT-17W-40K 17W 1900LM 4000K	3

 **FACTORY-INSTALLED OPTIONS, ENTER DESIRED OPTION CODE(S) AS LINE ITEMS ON YOUR PURCHASE ORDER UNDER THE PRODUCT CATALOG NUMBER**

WATTS	EM OPTION	DESCRIPTION	BOX OPTION	DESCRIPTION	PAINT	SENSOR	DESCRIPTION
ALL MODELS	OPT-EM-LVL	INTERNAL	OPT-VL-RS-BK	BOX	N/A	OPT-SEN-2MDR-36 WEC-3RC	PROGRAMMABLE MICROWAVE BI-LEVEL REMOTE CONTROL



LVF-WS-MCT5-BN

BULDER SERIES VANITY LIGHTS WITH SLIDE-TO-CENTER WALL CANOPY



CATALOG NO.	DESCRIPTION	PKG. QTY.
LVF-18-MCT5-BN	12W 1020LM 27K/30K/35K/40K/50K 18" Brushed Nickel	
LVF-24-MCT5-BN	16W 1360LM 27K/30K/35K/40K/50K 24" Brushed Nickel	
LVF-30-MCT5-BN	20W 1600LM 27K/30K/35K/40K/50K 30" Brushed Nickel	
LVF-36-MCT5-BN	24W 2000LM 27K/30K/35K/40K/50K 36" Brushed Nickel	
LVF-48-MCT5-BN	32W 2700LM 27K/30K/35K/40K/50K 48" Brushed Nickel	
LVF-WS-MCT5-BN	16W 1360LM 27K/30K/35K/40K/50K Brushed Nickel	



MODEL LVB LED SEMI-FLUSH VANITY LIGHT, 3CCT, PC LENS, 120V

FOR FACTORY OPTION BOX SEE LVE BELOW



CATALOG NO.	DESCRIPTION
LVB-12-MCT-BN	8W 560LM 30K/40K/50K Brushed-Nickel, 12"
LVB-12-MCT-PC	8W 560LM 30K/40K/50K Polished-Chrome, 12"
LVB-18-MCT-BN	12W 840LM 30K/40K/50K Brushed-Nickel, 18"
LVB-18-MCT-PC	12W 840LM 30K/40K/50K Polished-Chrome, 18"
LVB-24-MCT-BN	16W 1440LM 30K/40K/50K Brushed-Nickel, 24"
LVB-24-MCT-PC	16W 1440LM 30K/40K/50K Polished-Chrome, 24"
LVB-36-MCT-BN	24W 1680LM 30K/40K/50K Brushed-Nickel, 36"
LVB-36-MCT-PC	24W 1680LM 30K/40K/50K Polished-Chrome, 36"
LVB-48-MCT-BN	32W 2240LM 30K/40K/50K Brushed-Nickel, 48"
LVB-48-MCT-PC	32W 2240LM 30K/40K/50K Polished-Chrome, 48"

COMMERCIAL
VANITY
LIGHTS



MODEL LVC ARCHITECTURAL LED MULTI COLOR-TEMPERATURE VANITY LIGHT WITH CUBE PC LENS, 120V

FOR FACTORY OPTION BOX SEE LVE BELOW



CATALOG NO.	DESCRIPTION	PKG. QTY.
LVC-24-MCT5-BN	16W 1120LM 27K/30K/35K/40K/50K Brushed Nickel 24"	10
LVC-36-MCT5-BN	24W 1680LM 27K/30K/35K/40K/50K Brushed Nickel 36"	10



LVD-WS-MCT5-BN

MODEL LVD ARCHITECTURAL LED MULTI COLOR-TEMPERATURE VANITY LIGHT WITH TUBE PC, 120V

FOR FACTORY OPTION BOX SEE LVE BELOW



CATALOG NO.	DESCRIPTION	PKG. QTY.
LVD-24-MCT5-BN	16W 1300LM 27K/30K/35K/40K/50K Brushed Nickel 24"	10
LVD-36-MCT5-BN	24W 2000LM 27K/30K/35K/40K/50K Brushed Nickel 36"	10
LVD-48-MCT5-BN	32W 2700LM 27K/30K/35K/40K/50K Brushed Nickel 48"	10
LVD-WS-MCT5-BN	16W 1360LM 27K/30K/35K/40K/50K Brushed Nickel	



MODEL LVE MULTI COLOR-TEMPERATURE VANITY LIGHT (3CCT), WITH PC LENS AND METAL RINGS, 120V



CATALOG NO.	DESCRIPTION	PKG. QTY.
LVE-24-MCT-BN	17W 1760LM 3000K/3500K/4000K Brushed Nickel 24"	1
LVE-36-MCT-BN	25W 2560LM 3000K/3500K/4000K Brushed Nickel 36"	1
LVE-48-MCT-BN	34W 3500LM 3000K/3500K/4000K Brushed Nickel 48"	1



FACTORY-INSTALLED OPTIONS, ENTER DESIRED OPTION CODE(S) AS LINE ITEMS ON YOUR PURCHASE ORDER UNDER THE PRODUCT CATALOG NUMBER

WATTS	277V OPTION	DESCRIPTION	OPTION BOX	DESCRIPTION	PAINT	SENSOR	DESCRIPTION
ALL	OPT-277V	INTERNAL	OPT-VL-RS-BK	BOX	N/A	N/A	N/A



MODEL LVA ARCHITECTURAL LED DUAL GLASS MULTI COLOR-TEMPERATURE VANITY LIGHT, 120V

FOR FACTORY OPTION BOX SEE LVE BELOW



CATALOG NO.	DESCRIPTION	PKG. QTY.
LVA-24-MCT5-BN	20W 1400LM 27K/30K/35K/40K/50K Brushed Nickel 24"	1
LVA-36-MCT5-BN	30W 2100LM 27K/30K/35K/40K/50K Brushed Nickel 36"	1



MODEL LVG ARCHITECTURAL LED MULTI COLOR-TEMPERATURE VANITY LIGHT WITH SQUARE PC LENS, 120V

FOR FACTORY OPTION BOX SEE LVE BELOW



CATALOG NO.	DESCRIPTION	PKG. QTY.
LVG-24-MCT5-BN	18W 1300LM 27K/30K/35K/40K/50K Brushed Nickel 24"	10
LVG-36-MCT5-BN	30W 2000LM 27K/30K/35K/40K/50K Brushed Nickel 36"	10

COMMERCIAL
VANITY LIGHTS



LVS-24
LVS-36
LVS-48



LVS-WS-21

SPEC SERIES SLIM ROTATABLE VANITY LIGHTS AND SCONCES, 120V



CATALOG NO.	DESCRIPTION	PKG. QTY.
LVS-24-MCT5-BN	20W 1400LM 27K/30K/35K/40K/50K 24" Brushed Nickel	10
LVS-24-MCT5-BK	20W 1400LM 27K/30K/35K/40K/50K 24" Black	10
LVS-24-MCT5-BB	20W 1400LM 27K/30K/35K/40K/50K 24" Brushed Brass	10
LVS-36-MCT5-BN	30W 2100LM 27K/30K/35K/40K/50K 36" Brushed Nickel	10
LVS-36-MCT5-BK	30W 2100LM 27K/30K/35K/40K/50K 36" Black	10
LVS-36-MCT5-BB	30W 2100LM 27K/30K/35K/40K/50K 36" Brushed Brass	10
LVS-48-MCT5-BN	40W 2800LM 27K/30K/35K/40K/50K 48" Brushed Nickel	10
LVS-48-MCT5-BK	40W 2800LM 27K/30K/35K/40K/50K 48" Black	10
LVS-48-MCT5-BB	40W 2800LM 27K/30K/35K/40K/50K 48" Brushed Brass	10
LVS-WS-21-MCT5-BN	14W 980LM 27K/30K/35K/40K/50K 21" Brushed Nickel	10
LVS-WS-21-MCT5-BK	14W 980LM 27K/30K/35K/40K/50K 21" Black	10
LVS-WS-21-MCT5-BB	14W 980LM 27K/30K/35K/40K/50K 21" Brushed Brass	10

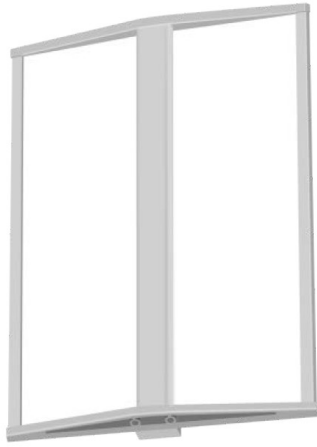

CWS-48-MCTP

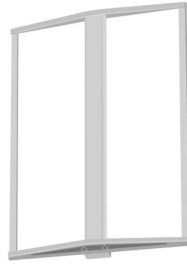

CWS-18-MCTP



CWS-12-MCTP



COMMERCIAL AND WAITING-ROOM INDOOR WALL SCONCE AND SUSPENDED LIGHTS

CATALOG NO.	DESCRIPTION	PKG. QTY.
CWS-12-MCTP	10W/15W/20W 85LM/W 30K/35K/40K	1
CWS-18-MCTP	10W/15W/20W 85LM/W 30K/35K/40K	1
CWS-48-MCTP	20W/30W/40W 85LM/W 30K/35K/40K	1
CWS-48-MCTP-DWA	Optional Drywall Mounting Accessory For CWS-48in	

COMMERCIAL
VANITY &
MIRRORS



LMIR-18-2028-MCT-DF
LMIR-18-2436-MCT-DF



LMIR-36-2028-MCT-DF
LMIR-36-2436-MCT-DF



LMIR-54-2840-MCT-DF



LMIR-MC18-2432-MCT-DF

SPEC SERIES LED MIRRORS AND CABINET, ADJUSTABLE COLOR TEMP., DIMMING, WITH DEFOGGER FEATURE



CATALOG NO.	DESCRIPTION	W X H	PKG. QTY.
LMIR-18-2028-MCT-DF	35W 3000K/4500K/6500K	20" X 28"	1
LMIR-18-2436-MCT-DF	44W 3000K/4500K/6500K	24" X 36"	1
LMIR-36-2028-MCT-DF	31W 3000K/4500K/6500K	20" X 28"	1
LMIR-36-2436-MCT-DF	39W 3000K/4500K/6500K	24" X 36"	1
LMIR-54-2840-MCT-DF	48W 3000K/4500K/6500K	28" X 40"	1
LMIR-MC18-2432-MCT-DF	35W 2700K-6500K	24" X 32"	1

LED TRACK LIGHTS, 120V (Fit Halo® and compatible tracks and accessories)



CATALOG NO.	DESCRIPTION	WHILE SUPPLIES LAST
TRI-R-10W-WH-40K	10W 691LM 4000K WHITE 25° LED ADJ. CYLINDER	
TRI-R-10W-WH-50K	10W 702LM 5000K WHITE 25° LED ADJ. CYLINDER	
TRI-S-10W-WH-30K	10W 681LM 3000K WHITE 25° LED ADJ. SQUARE	
TRI-S-10W-WH-40K	10W 706LM 4000K WHITE 25° LED ADJ. SQUARE	
TRI-S-10W-WH-50K	10W 732LM 5000K WHITE 25° LED ADJ. SQUARE	
TRI-R-10W-BK-40K	10W 691LM 4000K BLACK 25° LED ADJ. CYLINDER	
TRI-S-10W-BK-30K	10W 681LM 3000K BLACK 25° LED ADJ. SQUARE	
TRI-S-10W-BK-40K	10W 706LM 4000K BLACK 25° LED ADJ. SQUARE	
TRI-REFL-38D	Optional Reflector For Tr1 Series Track Lights—38° Beam Angle	





WFL-112-PC-3B-52-MCT-WH-WH
White and White blades



WFL-112-PC-3B-52-MCT-BK-BK
Black and Black blades



WFL-112-PC-3B-52-MCT-BN-RWS
Brush Nickel and Reversible
Rosewood/Silver blades



WFL-113-PC-5B-52-MCT-WH-WH
White and White blades



WFL-113-PC-5B-52-MCT-BN-RWBK
Brush Nickel and Reversible
Black/Rosewood blades



WFL-115-PC-5B-52-MCT-WH-WH
White and White blades



WFL-115-PC-3B-52-MCT-BK-BK
Black and Black blades



WFL-115-PC-3B-52-MCT-BN-RWS
Brush Nickel and Reversible
Rosewood/Silver blades



WFL-116-WS-3B-52-30K-WH-WH
White and White blades



WFL-116-WS-3B-52-30K-BK-BK
Black and Black blades



WFL-116-WS-3B-52-30K-BN-RWS
Brush Nickel and Reversible
Rosewood/Silver blades



WFL-107-PC-5B-52-WH-WH
White and White blades



WFL-107-PC-5B-52-BN-RWSO
Brush Nickel and Reversible
Rosewood/Silver oak



WFL-105-PC-5B-52-WH-WH
White and White blades



WFL-105-PC-5B-52-SN-RWSO
Satin Nickel and Reversible
Rosewood /Silver oak



WFL-103-PC-5B-52-WH-WH
White and White blades



WFL-103-PC-5B-52-BN-RWSO
Brush Nickel and Reversible
Rosewood/Silver oak



WFL-118-WS-4B-52-30K-WH-WH
White and White blades



WFL-118-WS-4B-52-30K-BK-BK
Black and Black blades



WFL-118-WS-4B-52-30K-BN-S
Brush Nickel/Silver Blades



WF-318WP-RC-3B-52-BR-WA
Bronze And Walnut Blades



WFL-117DL-WS-4B-52-30K-BK-BK
Black and Black blades

WESTGATE CEILING FANS



CATALOG NO.	DESCRIPTION	PKG. QTY.
WFL-112-PC-3B-52-MCT-WH-WH	20w 1750LM 30K/40K/50K White and White blades	1
WFL-112-PC-3B-52-MCT-BK-BK	20w 1750LM 30K/40K/50K Black and Black blades	1
WFL-112-PC-3B-52-MCT-BN-RWS	20w 1750LM 30K/40K/50K Brush Nickel and Reversible Rosewood/Silver blades	1
WFL-113-PC-5B-52-MCT-WH-WH	20w 1750LM 30K/40K/50K White and White blades	1
WFL-113-PC-5B-52-MCT-BN-RWBK	20w 1750LM 30K/40K/50K Brush Nickel and Reversible Black/Rosewood blades	1
WFL-115-PC-5B-52-MCT-WH-WH	20w 1750LM 30K/40K/50K White and White blades	1
WFL-115-PC-3B-52-MCT-BK-BK	20w 1750LM 30K/40K/50K Black and Black blades	1
WFL-115-PC-3B-52-MCT-BN-RWS	20w 1750LM 30K/40K/50K Brush Nickel and Reversible Rosewood/Silver blades	1
WFL-116-WS-3B-52-30K-WH-WH	19w 1600LM 3000K White and White blades	1
WFL-116-WS-3B-52-30K-BK-BK	19w 1600LM 3000K Black and Black blades	1
WFL-116-WS-3B-52-30K-BN-RWS	19w 1600LM 3000K Brush Nickel and Reversible Rosewood/Silver blades	1
WFL-107-PC-5B-52-WH-WH	9w*2 800LM*2 3000K White and White blades	1
WFL-107-PC-5B-52-BN-RWSO	9w*2 800LM*2 3000K Brush Nickel and Reversible Rosewood/Silver oak	1
WFL-105-PC-5B-52-WH-WH	7w*3 600LM*3 3000K White and White blades	1
WFL-105-PC-5B-52-SN-RWSO	7w*3 600LM*3 3000K Satin Nickel and Reversible Rosewood /Silver oak	1
WFL-103-PC-5B-52-WH-WH	7w*3 600LM*3 3000K White and White blades	1
WFL-103-PC-5B-52-BN-RWSO	7w*3 600LM*3 3000K Brush Nickel and Reversible Rosewood/Silver oak	1
WFL-118-WS-4B-52-30K-WH-WH	19w 1600LM 3000K White and White blades	1
WFL-118-WS-4B-52-30K-BK-BK	19w 1600LM 3000K Black and Black blades	1
WFL-118-WS-4B-52-30K-BN-S	19w 1600LM 3000K Brush Nickel/Silver Blades	1
WF-318WP-RC-3B-52-BR-WA	- - - Bronze And Walnut Blades	1
WFL-117DL-WS-4B-52-30K-BK-BK	19w 1600LM 3000K Black and Black blades	1



COMMERCIAL
CEILING
FANS

RESIDENTIAL LIGHTING

BAFFLE PC DOB RECESS TRIM, 5CCT



CATALOG NO.	DESCRIPTION	PKG. QTY.
 RDDF4-MCT5	6.5W 650LM 27K/30K/40K/50K/60K 4"	12
 RDDF6-MCT5	10W 1000LM 27K/30K/40K/50K/60K 6"	8

BUILDER SERIES ENVIRONMENTAL 5CCT SELECTABLE LED RECESSED LIGHT TRIM- COMPOSITE SERIES



CATALOG NO.	DESCRIPTION	PKG. QTY.
 RDPF4-MCT5	10W 800LM 27K/30K/35K/40K/50K 4" BAFFLE	12
 RDPF6-MCT5	13W 1040LM 27K/30K/35K/40K/50K 6" BAFFLE	8
 RDPS4-MCT5	10W 800LM 27K/30K/35K/40K/50K 4" SMOOTH	12
 RDPS6-MCT5	13W 1040LM 27K/30K/35K/40K/50K 6" SMOOTH	8

BUILDER SERIES ENVIRONMENTAL 5CCT+3 POWER-LEVEL SELECTABLE LED RECESSED LIGHT TRIM- COMPOSITE SERIES



CATALOG NO.	DESCRIPTION	PKG. QTY.
 RDPF4-MCTP	8W/10W/13W 80LM/W 27K/30K/35K/40K/50K 4"	12
 RDPF6-MCTP	10W/13W/17W 80LM/W 27K/30K/35K/40K/50K 6"	8
 RDPS4-MCTP	8W/10W/13W 80LM/W 27K/30K/35K/40K/50K 4"	12
 RDPS6-MCTP	10W/13W/17W 80LM/W 27K/30K/35K/40K/50K 6"	8

















ADJUSTABLE-HEAD ENVIRONMENTAL 5CCT SELECTABLE LED RECESSED LIGHT TRIMS

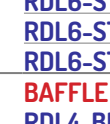

CATALOG NO.	DESCRIPTION	PKG. QTY.
 RDPF4-ADJ-MCT5	10W 800LM 27K/30K/35K/40K/50K 4"	12
 RDPF6-ADJ-MCT5	11W 880LM 27K/30K/35K/40K/50K 6"	8

LED RECESSED TRIM SERIES 3", 4", 5/6" 5CCT SELECTABLE

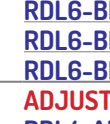







CATALOG NO.	DESCRIPTION	PKG. QTY.
 SPEC SERIES WESTGATE SIGNATURE LED RECESSED TRIM SERIES 3", 4", 5/6" SELECTABLE 5CCT [JA8]	7W 560LM 27K/30K/35K/40K/50K 3" WET	20
 RDL4-MCT5-WP	8W 650LM 27K/30K/35K/40K/50K 4" WET	20
 RDL6-MCT5-WP	14W 1140LM 27K/30K/35K/40K/50K 5/6" WET	20
 SMOOTH LED RECESSED TRIM SERIES 4" & 5/6" SELECTABLE 5CCT [JA8]	10W 700LM 27K/30K/35K/40K/50K 4"	24
 RDL4-ST-MCT5-ORB	10W 700LM 27K/30K/35K/40K/50K 4"	24
 RDL4-ST-MCT5-BK	10W 700LM 27K/30K/35K/40K/50K 4"	24
 RDL6-ST-MCT5	15W 1275LM 27K/30K/35K/40K/50K 5/6"	16
 RDL6-ST-MCT5-ORB	15W 1275LM 27K/30K/35K/40K/50K 5/6"	16
 RDL6-ST-MCT5-BK	15W 1275LM 27K/30K/35K/40K/50K 5/6"	16
 BAFFLE LED RECESSED TRIM SERIES 4" & 5/6" SELECTABLE 5CCT [JA8]	10W 700LM 27K/30K/35K/40K/50K 4"	24
 RDL4-BF-MCT5-ORB	10W 700LM 27K/30K/35K/40K/50K 4"	24
 RDL4-BF-MCT5-BK	10W 700LM 27K/30K/35K/40K/50K 4"	24
 RDL6-BF-MCT5	15W 1275LM 27K/30K/35K/40K/50K 5/6"	16
 RDL6-BF-MCT5-ORB	15W 1275LM 27K/30K/35K/40K/50K 5/6"	16
 RDL6-BF-MCT5-BK	15W 1275LM 27K/30K/35K/40K/50K 5/6"	16
 ADJUSTABLE BAFFLE LED RECESSED TRIM SERIES 4" & 5/6" SELECTABLE 5CCT [JA8]	8W 650LM 27K/30K/35K/40K/50K 4"	12
 RDL6-ADJ-MCT5	11W 900LM 27K/30K/35K/40K/50K 5/6"	8

FACTORY-INSTALLED OPTIONS, ENTER DESIRED OPTION CODE(S) AS LINE ITEMS ON YOUR PURCHASE ORDER UNDER THE PRODUCT CATALOG NUMBER

WATTS	EM OPTION	DESCRIPTION	PHOTOCELL	DESCRIPTION	PAINT	SENSOR	DESCRIPTION
UP TO 19W	OPT-EM-RDL	EXTERNAL		N/A	N/A	N/A	N/A



RESIDENTIAL RECESSED TRIMS

LED BAFFLE AND SMOOTH RECESSED TRIMS (CLIP-ON RDL-BF & RDL-ST)

CATALOG NO.	DESCRIPTION
 RDL4-BF-TRMB-BK	RDL4-BF series color trim, baffle, black finish
 RDL4-BF-TRMB-BN	RDL4-BF series color trim, baffle, brushed nickel finish
 RDL4-BF-TRMB-ORB	RDL4-BF series color trim, baffle, oil-rubbed bronze finish
 RDL4-BF-TRMB-GD	RDL4-BF series color trim, baffle, Specular Gold
 RDL6-BF-TRMB-BK	RDL6-BF series color trim, baffle, black finish
 RDL6-BF-TRMB-BN	RDL6-BF series color trim, baffle, brushed nickel
 RDL6-BF-TRMB-ORB	RDL6-BF series color trim, baffle, oil-rubbed bronze finish
 RDL6-BF-TRMB-GD	RDL6-BF series color trim, baffle, Specular Gold
 RDL4-BF-TRMS-BK	RDL4-BF series color trim, smooth, black finish
 RDL4-BF-TRMS-BN	RDL4-BF series color trim, smooth, brushed nickel
 RDL4-BF-TRMS-WH	RDL4-BF series color trim, smooth, white finish
 RDL4-BF-TRMS-ORB	RDL4-BF series color trim, smooth, oil-rubbed bronze finish
 RDL4-BF-TRMS-GD	RDL4-BF series color trim, smooth, Specular Gold
 RDL6-BF-TRMS-BK	RDL6-BF series color trim, smooth, black finish
RDL6-BF-TRMS-BN	RDL6-BF series color trim, smooth, brushed nickel
RDL6-BF-TRMS-WH	RDL6-BF series color trim, smooth, white finish
RDL6-BF-TRMS-ORB	RDL6-BF series color trim, smooth, oil-rubbed bronze finish
RDL6-BF-TRMS-GD	RDL6-BF series color trim, smooth, Specular Gold

LED SQUARE TRIMS 4", 5/6"



CATALOG NO.	DESCRIPTION	PKG. QTY.
SMOOTH LED SQUARE TRIMS 4", 5/6"		
 SDL4-MCT5	10W 650LM 27K/30K/35K/40K/50K 4"	24
 SDL6-MCT5	15W 1155LM 27K/30K/35K/40K/50K 5/6"	16
BAFFLE LED SQUARE TRIMS 4", 5/6"		
 SDL4-BF-27K	10W 600LM 2700K 4" WHILE SUPPLIES LAST	24
 SDL4-BF-30K	10W 650LM 3000K 4" WHILE SUPPLIES LAST	24
 SDL4-BF-41K	10W 700LM 4100K 4" WHILE SUPPLIES LAST	24
 SDL4-BF-50K	10W 700LM 5000K 4" WHILE SUPPLIES LAST	24
 SDL4-BF-MCT5	10W 700LM 27K/30K/35K/40K/50K 4" MCT5	24
 SDL6-BF-27K	16.5W 1073LM 2700K 5/6"	16
 SDL6-BF-30K	16.5W 1100LM 3000K 5/6"	16
 SDL6-BF-41K	16.5W 1150LM 4100K 5/6"	16
SDL6-BF-50K	16.5W 1200LM 5000K 5/6"	16
SDL6-BF-MCT5	15W 1155LM 27K/30K/35K/40K/50K 5/6" MCT5	16

FACTORY-INSTALLED OPTIONS, ENTER DESIRED OPTION CODE(S) AS LINE ITEMS ON YOUR PURCHASE ORDER UNDER THE PRODUCT CATALOG NUMBER

WATTS	EM OPTION	DESCRIPTION	PHOTOCELL	DESCRIPTION	PAINT	SENSOR	DESCRIPTION
UP TO 19W	OPT-EM-SDL	EXTERNAL		N/A	N/A	N/A	N/A

WG SMART APP COMPATIBLE RGBW SMOOTH RECESSED LIGHT TRIM - ROUND, 120V



CATALOG NO.	DESCRIPTION	PKG. QTY.
 TC-RDPS4-10W-RGBW-WIFI	10W 650LM RGBW 4" E26 Base	12
 TC-RDPS6-13W-RGBW-WIFI	13W 850LM RGBW 6" E26 Base	8



12V LOW-VOLTAGE LED REPLACEMENT TRIMS FOR MR16 HOUSINGS



CATALOG NO.	DESCRIPTION	PKG. QTY.
 RDL4-BF-MCT5-12V	11W 77LM 27K/30K/35K/40K/50K 4"	24
 RDL4-ST-MCT5-12V	11W 77LM 27K/30K/35K/40K/50K 4"	24







J-BOX DIRECT-MOUNT RECESSED LIGHT, FITS 3-0 AND 4-0 OCTAGON BOXES



CATALOG NO.	DESCRIPTION	PKG. QTY.
 RDJ4-MCT5	10W 700LM 27K/30K/35K/40K/50K 4"	20
 RDJ4-TRM-BK	4 inch trim for RDJ4, Black	

SINGLE CCT LED TRIMS 3", 4", 5/6" E26 included in the box
(JA8-E-2016 COMPLIANT)



	CATALOG NO.	DESCRIPTION	WHILE SUPPLIES LAST	PKG. QTY.	
SMOOTH		RDL3-27K-WP	9W 540LM 2700K 3"	20	
		RDL3-30K-WP	9W 540LM 3000K 3"	20	
		RDL3-41K-WP	9W 540LM 4100K 3"	20	
		RDL3-50K-WP	9W 540LM 5000K 3"	20	
		RDL4-27K-WP	12W 650LM 2700K 4"	12	
		RDL4-30K-WP	12W 700LM 3000K 4"	12	
		RDL4-35K-WP	12W 725LM 3500K 4"	12	
		RDL4-41K-WP	12W 750LM 4100K 4"	12	
		RDL4-50K-WP	12W 800LM 5000K 4"	12	
		RDL4-65K-WP	12W 850LM 6500K 4"	12	
		RDL6-27K-WP	19W 1200LM 2700K 5/6"	8	
		RDL6-30K-WP	19W 1250LM 3000K 5/6"	8	
RDL6-35K-WP		19W 1275LM 3500K 5/6"	8		
RDL6-41K-WP		19W 1300LM 4100K 5/6"	8		
RDL6-50K-WP		19W 1350LM 5000K 5/6"	8		
RDL6-65K-WP		19W 1400LM 6500K 5/6"	8		
BAFFLE		RDL4-BF-27K	10W 650LM 2700K 4"	24	
		RDL4-BF-30K	10W 680LM 3000K 4"	24	
		RDL4-BF-30K-ORB	10W 680LM 3000K 4" Oil-Rubbed Bronze	24	
		RDL4-BF-35K	10W 720LM 3500K 4"	24	
		RDL4-BF-41K	10W 746LM 4100K 4"	24	
		RDL4-BF-50K	10W 761LM 5000K 4"	24	
		RDL6-BF-27K	18W 1102LM 2700K 5/6"	16	
		RDL6-BF-30K	18W 1204LM 3000K 5/6"	16	
		RDL6-BF-30K-ORB	18W 1204LM 3000K 5/6" Oil-Rubbed Bronze	16	
		RDL6-BF-35K	18W 1280LM 3500K 5/6"	16	
		RDL6-BF-41K	18W 1300LM 4100K 5/6"	16	
		RDL6-BF-50K	18W 1350LM 5000K 5/6"	16	
	ADJUSTABLE EYEBALL		RDL4-ADJ-27K	10W 650LM 2700K 4"	12
			RDL4-ADJ-30K	10W 650LM 3000K 4"	12
			RDL4-ADJ-41K	10W 650LM 4100K 4"	12
			RDL4-ADJ-50K	10W 650LM 5000K 4"	12
			RDL6-ADJ-27K	13W 900LM 2700K 5/6"	8
			RDL6-ADJ-30K	13W 900LM 3000K 5/6"	8
RDL6-ADJ-41K			13W 900LM 4100K 5/6"	8	
RDL6-ADJ-50K			13W 900LM 5000K 5/6"	8	

RESIDENTIAL RECESSED TRIMS

AIRTIGHT LED RECESSED LIGHT HOUSING

NO PARTIAL/MUST SHIP CASE QTY.

	CATALOG NO.	DESCRIPTION	PKG. QTY.
	ICF4SJBB	4" Fire-Rated Junction Box With Bar Hangers For Surface Mount Down Lights	24
	ICF4SJBP	4" Fire-Rated Junction Box Housing For Led Surface Mount Down Lights & J-Box Recessed Lights	6
	ICFAL-4	4" Fire-Rated Ic New Construction Led Recessed Housing	4
	ICFAL-6	6" Fire-Rated Ic New Construction Led Recessed Housing	4

FOR FACTORY-INSTALLED OPTIONS SEE SDL4 & 6 BELOW

RSL G2 SECOND GENERATION SLIM WAFER LIGHTS, 5CCT







	CATALOG NO.	DESCRIPTION	ARRIVES THIS SEASON CHECK & PRE-ORDER	PKG. QTY.
	RSL4-G2-MCT5	10W 700LM 27K/30K/35K/40K/50K 4" White	20	
	RSL4-G2-MCT5-BK	10W 700LM 27K/30K/35K/40K/50K 4" Black	20	
	RSL4-G2-MCT5-ORB	10W 700LM 27K/30K/35K/40K/50K 4" Oil-Rubbed Bronze	20	
	RSL6-G2-MCT5	12W 1000W 27K/30K/35K/40K/50K 6" White	20	
	RSL6-G2-MCT5-BK	12W 1000W 27K/30K/35K/40K/50K 6" Black	20	
	RSL6-G2-MCT5-ORB	12W 1000W 27K/30K/35K/40K/50K 6" Oil-Rubbed Bronze	20	

With External J-Box. Included. No need for Housing

LED 5CCT ULTRA SLIM RECESSED LIGHTS 3", 4", 6", 8" & 12", 120V

With External J-Box Included, No need for Housing



CATALOG NO.	DESCRIPTION	PKG. QTY.
 RSL3-MCT5	6W 400LM 27K/30K/35K/40K/50K 3"	24
RSL3-MCT5-BN	6W 400LM 27K/30K/35K/40K/50K 3"	24
RSL3-MCT5-ORB	6W 400LM 27K/30K/35K/40K/50K 3"	24
RSL4-MCT5	9W 630LM 27K/30K/35K/40K/50K 4"	24
RSL4-MCT5-ORB	9W 630LM 27K/30K/35K/40K/50K 4"	24
 RSL6-MCT5	15W 1125LM 27K/30K/35K/40K/50K 6"	24
RSL6-MCT5-ORB	15W 1125LM 27K/30K/35K/40K/50K 6"	24
RSL8-MCT5	18W 1350LM 27K/30K/35K/40K/50K 8"	24
RSL10-MCT5	20W 1500LM 27K/30K/35K/40K/50K 10"	24
RSL12-MCT5	24W 1800LM 27K/30K/35K/40K/50K 12"	24
 RSL4-BF-MCT5	9W 650LM 27K/30K/35K/40K/50K 4"	12
RSL6-BF-MCT5	12W 900LM 27K/30K/35K/40K/50K 6"	12
RSL-BF-EXT-6FT-MCT5	6 FT Extension Cord for RSL-BF	-
RSL-BF-EXT-10FT-MCT5	10 FT Extension Cord for RSL-BF	-
RSL-BF-EXT-20FT-MCT5	20 FT Extension Cord for RSL-BF	-
 SSL4-MCT5	9W 630LM 27K/30K/35K/40K/50K 4"	24
 SSL6-MCT5	15W 1125LM 27K/30K/35K/40K/50K 6"	24
SSL12-MCT5	24W 1800LM 27K/30K/35K/40K/50K 12"	24
RSL-EXT-10FT-MCT	10 Ft. Extension Cable for use with all MCT Slim Lights	

RESIDENTIAL

RECESSED TRIMS



FACTORY-INSTALLED OPTIONS, ENTER DESIRED OPTION CODE(S) AS LINE ITEMS ON YOUR PURCHASE ORDER UNDER THE PRODUCT CATALOG NUMBER

WATTS	EM OPTION	DESCRIPTION	PHOTOCELL	DESCRIPTION	PAINT	SENSOR	DESCRIPTION
UP TO 19W	OPT-EM-RSL	EXTERNAL		N/A	N/A	N/A	N/A

LED 5CCT ADJUSTABLE ULTRA SLIM RECESSED LIGHTS

With External J-Box Included No need for Housing



CATALOG NO.	DESCRIPTION	PKG. QTY.
 RSL4-ADJ-MCT5	9W 700LM 27K/30K/35K/40K/50K 4"	24
RSL6-ADJ-MCT5	12W 900LM 27K/30K/35K/40K/50K 6"	24

4" LED 5CCT ADJUSTABLE PULL-DOWN ULTRA SLIM RECESSED LIGHTS



CATALOG NO.	DESCRIPTION	PKG. QTY.
 RSL4-APD-MCT5	10W 700LM 27K/30K/35K/40K/50K 4"	12

With External J-Box Included, No need for Housing

WET LOCATION ADJUSTABLE LED 5CCT SLIM RECESSED LIGHTS, 120V



CATALOG NO.	DESCRIPTION	PKG. QTY.
 RSL4-ADJ-MCT5-WP	9W 630LM 27K/30K/35K/40K/50K 4"	24
RSL6-ADJ-MCT5-WP	15W 1125LM 27K/30K/35K/40K/50K 6"	24

















WET LOCATION LED 5CCT SLIM RECESSED LIGHTS, 120V



CATALOG NO.	DESCRIPTION	PKG. QTY.
 RSL3-MCT5-WP	6W 400LM 27K/30K/35K/40K/50K 3"	24
RSL4-MCT5-WP	9W 630LM 27K/30K/35K/40K/50K 4"	24
RSL6-MCT5-WP	15W 1125LM 27K/30K/35K/40K/50K 6"	24
RSL8-MCT5-WP	18W 1350LM 27K/30K/35K/40K/50K 8"	24
RSL10-MCT5-WP	20W 1500LM 27K/30K/35K/40K/50K 10"	24
RSL12-MCT5-WP	24W 1800LM 27K/30K/35K/40K/50K 12"	24

With External J-Box Included, No need for Housing

LED ULTRA SLIM RECESSED LIGHT ACCESSORIES

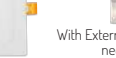
CATALOG NO.	DESCRIPTION
 RSL3-RI	3" Round Rough-in Plate, 26" Long
 RSL4-RI	4" Round Rough-in Plate, 26" Long
 RSL4-RI-13	4" Round Rough-in Plate, 13" Long
 RSL6-RI	6" Round Rough-in Plate, 26" Long
 RSL6-RI-13	6" Round Rough-in Plate, 13" Long
 RSL8-RI	8" Round Rough-in Plate, 26" Long
 RSL12-RI	12" Round Rough-in Plate, 26" Long
 SSL4-RI	4" Square Rough-in Plate, 26" Long
 SSL6-RI	6" Square Rough-in Plate, 26" Long
 SSL12-RI	12" Square Rough-in Plate, 26" Long
 RSL-EXT-10FT	10 Ft. Extension Cable for use with all Slim Lights
 RSL-346-RIBH	3", 4", 6" (Adjustable) Round Galvanized plate with Bar Hangers
 SSL-346-RIBH	3", 4", 6" (Adjustable) Square Galvanized plate with Bar Hangers
 RSL4-GR	Goof ring for 4in lights with butterfly wings
 RSL6-GR	Goof ring for 6in lights with butterfly wings
 RSL8-GR	Goof ring for 8in lights with butterfly wings
 RSL10-GR	Goof ring for 10in lights with butterfly wings
 RSL12-GR	Goof ring for 12in lights with butterfly wings

LED ULTRA SLIM RECESSED TRIMS (CLIP ON RSL & SSL SLIM LIGHTS)





CATALOG NO.	DESCRIPTION
 RSL4-TRM-BK	4" Black Clip-on Trim
 RSL4-TRM-ORB	4" Oil-rubbed Bronze Clip-on Trim
 RSL4-TRM-CU	4" Copper Clip-on Trim
 RSL4-TRM-BZ	4" Bronze Clip-on Trim
 RSL4-TRM-BN	4" Brushed Nickel Clip-on Trim
 RSL4-TRM-CH	4" Chrome Clip-on Trim
 SSL4-TRM-BK	4" Black Clip-on Trim
 SSL4-TRM-ORB	4" Oil-rubbed Bronze Clip-on Trim
SSL4-TRM-CU	4" Copper Clip-on Trim
SSL4-TRM-BZ	4" Bronze Clip-on Trim
SSL4-TRM-BN	4" Brushed Nickel Clip-on Trim
SSL4-TRM-CH	4" Chrome Clip-on Trim
RSL6-TRM-BK	6" Black Clip-on Trim
RSL6-TRM-ORB	6" Oil-rubbed Bronze Clip-on Trim
RSL6-TRM-CU	6" Copper Clip-on Trim
RSL6-TRM-BZ	6" Bronze Clip-on Trim
RSL6-TRM-BN	6" Brushed Nickel Clip-on Trim
RSL6-TRM-CH	6" Chrome Clip-on Trim
SSL6-TRM-BK	6" Black Clip-on Trim
SSL6-TRM-ORB	6" Oil-rubbed Bronze Clip-on Trim
SSL6-TRM-CU	6" Copper Clip-on Trim
SSL6-TRM-BZ	6" Bronze Clip-on Trim
SSL6-TRM-BN	6" Brushed Nickel Clip-on Trim
SSL6-TRM-CH	6" Chrome Clip-on Trim

LED 5CCT ADJUSTABLE ULTRA SLIM ROUND-BACK RECESSED LIGHTS

CATALOG NO.	DESCRIPTION	PKG. QTY.
 SSLRB4-MCT5	9W 630LM 27K/30K/35K/40K/50K 4"	24
 SSLRB6-MCT5	15W 1125LM 27K/30K/35K/40K/50K 6"	24

With External J-Box. Included. No need for Housing

LED ROUND BACK RECESSED TRIMS (COMPATIBLE WITH SSLRB SERIES ONLY)

CATALOG NO.	DESCRIPTION
 SSLRB4-TRM-BK	4 inch square trim for SSLRB4, black
 SSLRB4-TRM-BN	4 inch square trim for SSLRB4, brushed nickel
 SSLRB4-TRM-ORB	4 inch square trim for SSLRB4, oil-rubbed bronze
 SSLRB6-TRM-BK	6 inch square trim for SSLRB6, black
 SSLRB6-TRM-BN	6 inch square trim for SSLRB6, brushed nickel
SSLRB6-TRM-ORB	6 inch square trim for SSLRB6, oil-rubbed bronze

RESIDENTIAL RECESSED TRIMS

SLIM SNAP-IN RECESSED LIGHTS WITH J-BOX, 5CCT



CATALOG NO.	DESCRIPTION	PKG. QTY.
 RSL4-JB-MCT5	10W 650LM 27K/30K/35K/40K/50K 4"	24
RSL6-JB-MCT5	12W 1000LM 27K/30K/35K/40K/50K 6"	24



3" LED GIMBAL (EYEBALL) ROUND RECESSED SNAP-IN LIGHT



CATALOG NO.	DESCRIPTION	PKG. QTY.
 RSL4-GIM-MCT5	10W 800LM 27K/30K/35K/40K/50K 4"	24

FIRE-RATED (2 HR) SLIM WAFER RECESSED LIGHT



CATALOG NO.	DESCRIPTION	PKG. QTY.
 RSL4-MCT5-FR	9W 630LM 27K/30K/35K/40K/50K 4"	24
SSL4-MCT5-FR	9W 630LM 27K/30K/35K/40K/50K 4"	24
 RSL6-MCT5-FR	12W 840LM 27K/30K/35K/40K/50K 6"	24
SSL6-MCT5-FR	12W 840LM 27K/30K/35K/40K/50K 6"	24

LED COMMERCIAL SLIM RECESSED REGRESSED BAFFLE LIGHTS 120-277V, 0~10V DIMMING

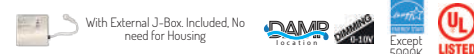





CATALOG NO.	DESCRIPTION	PKG. QTY.
 RSLC6-BF-30K	12W 900LM 3000K 6"	12
RSLC6-BF-40K	12W 900LM 4000K 6"	12
RSLC8-BF-30K	24W 1900LM 3000K 8"	12
RSLC8-BF-40K	24W 1900LM 4000K 8"	12
RSLC8-BF-50K	24W 1900LM 5000K 8"	12
RSLC6-BF-MCT5	12W 900LM 27K/30K/35K/40K/50K 6"	
RSLC8-BF-MCT5	24W 1900LM 27K/30K/35K/40K/50K 8"	
RSL-BF-EXT-6FT	RSL-BF 6FT. DC extension cord	-
RSL-BF-EXT-10FT	RSL-BF 10FT. DC extension cord	-
RSL-BF-EXT-20FT	RSL-BF 20FT. DC extension cord	-

SINGLE CCT LED ULTRA SLIM RECESSED LIGHTS

3", 4", 6", 8" & 12" 120V



CATALOG NO.	DESCRIPTION	WHILE SUPPLIES LAST	PKG. QTY.
 RSL3-27K	6W 400LM 2700K 3"		24
 RSL4-30K-BN	9W 630LM 3000K 4" Brushed Nickel		24
 RSL6-30K-BN	15W 1125LM 3000K 6" Brushed Nickel		24
 RSL6-30K-ORB	15W 1125LM 3000K 6" Oil-Rubbed Bronze		24
SSL6-27K	15W 1125LM 2700K 6"		24
SSL6-30K	15W 1125LM 3000K 6"		24
SSL6-40K	15W 1125LM 4000K 6"		24

FOR FACTORY OPTION SEE RSL-MCT5 ABOVE



LED ADJUSTABLE ULTRA SLIM RECESSED LIGHTS

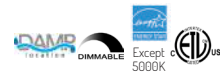

CATALOG NO.	DESCRIPTION	WHILE SUPPLIES LAST	PKG. QTY.
 RSL4-ADJ-30K	9W 700LM 3000K 4"		24
RSL4-ADJ-40K	9W 700LM 4000K 4"		24
RSL4-ADJ-50K	9W 700LM 5000K 4"		24
RSL6-ADJ-27K	12W 900LM 2700K 6"		24
RSL6-ADJ-30K	12W 900LM 3000K 6"		24
RSL6-ADJ-40K	12W 900LM 4000K 6"		24

4" SINGLE CCT LED ADJUSTABLE PULL-DOWN ULTRA SLIM RECESSED LIGHTS



CATALOG NO.	DESCRIPTION	WHILE SUPPLIES LAST	PKG. QTY.
 RSL4-APD-27K	12W 700LM 2700K 4"		12
 RSL4-APD-40K	12W 700LM 4000K 4"		12
RSL4-APD-50K	12W 700LM 5000K 4"		12

With External J-Box. Included. No need for Housing

RESIDENTIAL
RECESSED TRIMS

MINI LINEAR OPTIC-LIGHT FIXTURES, SNAP IN 5CCT



CATALOG NO.	DESCRIPTION	PKG. QTY.
 DLDS-6-MCT5	11W 600LM 27K/30K/35K/40K/50K	20
 DLDS-12-MCT5	18W 1200LM 27K/30K/35K/40K/50K	20



4" LED SNAP-IN RECESSED LIGHTS, SMOOTH AND BAFFLE TRIMS INCL.



CATALOG NO.	DESCRIPTION	PKG. QTY.
 RDL4S-SB-MCT5-WH	15W 1350LM 27K/30K/35K/40K/50K Round, White	20
 RDL4S-SB-MCT5-BK	15W 1350LM 27K/30K/35K/40K/50K Round, Black	20
 SDL4S-SB-MCT5-WH	15W 1350LM 27K/30K/35K/40K/50K Square, White	20
 SDL4S-SB-MCT5-BK	15W 1350LM 27K/30K/35K/40K/50K Square, Black	20



2" LED RECESSED LIGHTS (Baffle)(JA8-E-2016 COMPLIANT)



CATALOG NO.	DESCRIPTION	PKG. QTY.
 RDL2S-BF-40K-WH	8W 600LM 4000K Round WHILE SUPPLIES LAST	18
RDL2S-BF-50K-WH	8W 600LM 5000K Round WHILE SUPPLIES LAST	18
RDL2S-BF-MCT-WH	8W 600LM 3000K/4000K/5000K Round MCT3	18
 SDL2S-BF-27K-WH	8W 600LM 2700K Square WHILE SUPPLIES LAST	18
SDL2S-BF-40K-WH	8W 600LM 4000K Square WHILE SUPPLIES LAST	18
SDL2S-BF-50K-WH	8W 600LM 5000K Square WHILE SUPPLIES LAST	18
SDL2S-BF-MCT-WH	8W 600LM 3000K/4000K/5000K Square MCT3	18
RSL-346-RIBH	3", 4", 6" (Adjustable) Galvanized plate with Bar Hangers	

3" LED ADJUSTABLE (EYEBALL) RECESSED LIGHTS (JA8-E-2016 COMPLIANT)



CATALOG NO.	DESCRIPTION	PKG. QTY.
 RDL3S-ADJ-27K-WH	8W 600LM 2700K Round	18
RDL3S-ADJ-40K-WH	8W 600LM 4000K Round	18
 SDL3S-ADJ-27K-WH	8W 600LM 2700K Square WHILE SUPPLIES LAST	18
SDL3S-ADJ-30K-WH	8W 600LM 3000K Square WHILE SUPPLIES LAST	18
SDL3S-ADJ-40K-WH	8W 600LM 4000K Square WHILE SUPPLIES LAST	18
SDL3S-ADJ-50K-WH	8W 600LM 5000K Square	18
RSL-346-RIBH	3", 4", 6" (Adjustable) Galvanized plate with Bar Hangers	

3" LED ADJUSTABLE (EYEBALL) ROUND RECESSED LIGHT



CATALOG NO.	DESCRIPTION	PKG. QTY.
 RDL3S-ADJ-MCT5-WH	7W 700LM 27K/30K/35K/40K/50K Round	20

LED EMERGENCY DRIVER FOR ALL RECESSED TRIMS



CATALOG NO.	DESCRIPTION
 ELB-0895	Field-installed emergency ballast for all LED recessed trims; Input voltage: 100-277VAC, 50-60Hz; Output: 8W Maximum for 90 minutes



LED ARCHITECTURAL TRIMLESS RECESSED LIGHTS - 4"



CATALOG NO.	WATTAGE	COLOR TEMPERATURES	SHAPE	TRIM FINISH
LRD-TL	10W 10W	MCT5 27K/30K/35K/40K/50K	4R 4S ROUND SQUARE	WH WHITE BK BLACK C CLEAR MG MATTE GOLD HZ MATTE SILVER

SAMPLE ORDERING:

LRD-TL-10W-MCT5-4S-BK
FOR SEPARATE LIGHT ENGINE & TRIM PART NUMBERS, PLEASE SEE THE SPEC SHEETS

4"(3-1/4" Actual)
COMPLETE ITEM CODE



WHITE

ENGINE

ONLY 10W ENGINE



Junction box included with fixtures

HOUSING



ROUND TRIMS



MATTE SILVER MATTE GOLD WHITE

COMPLETE ITEM CODE



WHITE

ENGINE

ONLY 10W ENGINE



Junction box included with fixtures

HOUSING



SQUARE TRIMS



MATTE SILVER MATTE GOLD WHITE

RESIDENTIAL RECESSED TRIMS



LED ARCHITECTURAL WINGED RECESSED LIGHTS - 3" & 4"



CATALOG NO.	WATTAGE	COLOR TEMPERATURES	TRIM (ADJUSTBLE)	TRIM FINISH
LRD	7W 7W 10W 10W	MCT5 27K/30K/35K/40K/50K	3WTR 3" OPEN TRIM 3WTRPH 3" PIN HOLE TRIM 3WTRSL 3" SLOT TRIM 4WTR 4" OPEN TRIM 4WTRPH 4" PIN HOLE TRIM 4WTRSL 4" SLOT TRIM	WH WHITE (ALL TRIMS) BK BLACK (ALL TRIMS) C CLEAR (OPEN TRIMS ONLY) MG MATTE GOLD (OPEN TRIMS ONLY) HZ MATTE SILVER (OPEN TRIMS ONLY) ABK BLACK ON BLACK (OPEN TRIMS ONLY)

SAMPLE ORDERING:

LRD-7W-MCT5-3WTR-MG

FOR SEPARATE LIGHT ENGINE & TRIM PART NUMBERS, PLEASE SEE THE SPEC SHEETS

4" Open



4" Pin Hole

4" Slot

3"(2-1/8" Actual) Open

3"(2-1/8" Actual) Slot



White

Black

Clear

White

Black

Matte Gold

Matte Silver

Black on Black

White

Black



LED ARCHITECTURAL MULTIPLE-TRIM RECESSED LIGHTS



CATALOG NO.	WATTAGE	COLOR TEMPERATURES	TRIM (ADJUSTBLE)	TRIM FINISH
LRD	10W 10W	MCT5 27K/30K/35K/40K/50K	WTM1 SINGLE SLOT TRIM WTM2 DOUBLE SLOT TRIM WTM3 TRIPLE SLOT TRIM	WH WHITE

SAMPLE ORDERING:

LRD-10W-MCT5-WTM1-WH

FOR SEPARATE LIGHT ENGINE & TRIM PART NUMBERS, PLEASE SEE THE SPEC SHEETS

LRD-FGL

Frosted Glass Lens For LRD Series



Junction box included with fixtures



SINGLE TRIM



DOUBLE TRIM



TRIPLE TRIM

LED 5CCT DOUBLE RING FLUSH MOUNT, 120V



CATALOG NO.	DESCRIPTION	PKG. QTY.
 FDL-10-MCT5	12W 900LM 27K/30K/35K/40K/50K 10"	8
FDL-12-MCT5	16W 1200LM 27K/30K/35K/40K/50K 12"	8
FDL-12-MCT5-BK	16W 1200LM 27K/30K/35K/40K/50K 12"	8
FDL-14-MCT5	20W 1500LM 27K/30K/35K/40K/50K 14" WHILE SUPPLIES LAST	8
FDL-14-MCT5-BK	20W 1500LM 27K/30K/35K/40K/50K 14"	8
FDL-16-MCT5	24W 1800LM 27K/30K/35K/40K/50K 16" WHILE SUPPLIES LAST	8
FDL-18-MCT	30W 2200LM 3000K/4000K/5000K 18"	5
FDL-SFK	Semi-Flush Accessory Kit For Fdl Flush-Mount Series	
FDL-SFK-BK	Semi-Flush Accessory Kit For Fdl Flush-Mount Series, Bk	

SHOWN WITH EM



FACTORY-INSTALLED OPTIONS, ENTER DESIRED OPTION CODE(S) AS LINE ITEMS ON YOUR PURCHASE ORDER UNDER THE PRODUCT CATALOG NUMBER

WATTS	EM OPTION	DESCRIPTION	PHOTOCELL	DESCRIPTION	PAINT	SENSOR	DESCRIPTION
FDL-12-MCT5	OPT-EM-FDL	MOUNT IN EXTENDED BASE	OPT-PC-FM	BUTTON WITH AUXILIARY BASE	N/A	OPT-SEN-2US	ULTRASONIC
	277V OPTION	DESCRIPTION				INTERNAL FOR	BI-LEVEL DIMMING
	OPT-277V-FDL-12	EXTERNAL BOX				ALL MODELS	(REMOTE NOT NEEDED)
						WEC-3RC	REMOTE CONTROL

LED 5CCT SINGLE RING FLUSH MOUNT



CATALOG NO.	DESCRIPTION	PKG. QTY.
 FSL-11-MCT5	16W 1200LM 27K/30K/35K/40K/50K 11"	8
FSL-11-MCT5-GD	16W 1200LM 27K/30K/35K/40K/50K 11"	8
FSL-13-MCT5	20W 1500LM 27K/30K/35K/40K/50K 13"	8
FSL-13-MCT5-GD	20W 1500LM 27K/30K/35K/40K/50K 13"	8
FSL-15-MCT5	24W 1800LM 27K/30K/35K/40K/50K 15"	8
FSL-15-MCT5-GD	24W 1800LM 27K/30K/35K/40K/50K 15"	8

LED 5CCT CLOUD FIXTURES, 120V



CATALOG NO.	DESCRIPTION	PKG. QTY.
 FCR-11-MCT5	16W 1200LM 27K/30K/35K/40K/50K 11" DIA	8
FCR-14-MCT5	24W 1800LM 27K/30K/35K/40K/50K 14" DIA	8

LED 5CCT CLOUD FIXTURES, 120V



CATALOG NO.	DESCRIPTION	PKG. QTY.
 FCRB-11HL-MCT5	20W 1500LM 27K/30K/35K/40K/50K 11" DIA	8
FCRB-14-MCT5	20W 1500LM 27K/30K/35K/40K/50K 14" DIA	8

LED 5CCT CLOUD FIXTURE WITH PRE-INSTALLED SENSOR, 120V



CATALOG NO.	DESCRIPTION	PKG. QTY.
 FCRB-16-MCT5-SEN	20W 1400LM 27K/30K/35K/40K/50K 16" DIA	8

LED 5CCT CLOUD FIXTURES, 120V



CATALOG NO.	DESCRIPTION	PKG. QTY.
 FCS-11HL-MCT5	20W 1500LM 27K/30K/35K/40K/50K 11" DIA	8
FCS-13-MCT5	20W 1800LM 27K/30K/35K/40K/50K 13" DIA	8

LED CLOUD FIXTURES, 120V



CATALOG NO.	DESCRIPTION	PKG. QTY.
 FCS-11-12W-40K	15W 1100LM 4000K 11" DIA	2
FCS-14-18W-40K	22W 1800LM 4000K 14" DIA	2

SHOWN WITH EM

SHOWN WITH EM



FACTORY-INSTALLED OPTIONS, ENTER DESIRED OPTION CODE(S) AS LINE ITEMS ON YOUR PURCHASE ORDER UNDER THE PRODUCT CATALOG NUMBER

WATTS	EM OPTION	DESCRIPTION	PHOTOCELL	DESCRIPTION	PAINT	SENSOR	DESCRIPTION
FCR-11	OPT-EM-FCR11	INTERNAL	OPT-PC-FM	BUTTON WITH AUXILIARY BASE	N/A	OPT-SEN-2US	ULTRASONIC
FCR-14	OPT-EM-FCR14	INTERNAL	277V OPTION	DESCRIPTION		INTERNAL FOR ALL MODELS	BI-LEVEL DIMMING (REMOTE NOT NEEDED)
FCS11, FCS11HL	OPT-EM-FCS11	INTERNAL	OPT-277V-FCR-11	EXTERNAL BOX		OPT-SEN-2USRC	OPTIONAL RC
FCS14	OPT-EM-FCS14	INTERNAL	OPT-277V-FCS-11	EXTERNAL BOX			
FCS13	OPT-EM-FCS13	INTERNAL	OPT-277V-FCS-11HL	EXTERNAL BOX			
			OPT-277V-FCS-13	EXTERNAL BOX			



SLIM DOUBLE-RING FLUSH MOUNT, 5CCT

CATALOG NO.	DESCRIPTION	ARRIVES THIS SEASON CHECK & PRE-ORDER	PKG. QTY.
FDLS-12-MCT5	20W 1500LM 27K/30K/35K/40K/50K		8
FDLS-14-MCT5	24W 1800LM 27K/30K/35K/40K/50K		8



CONTRACTOR-FRIENDLY SNAP-IN FLUSH MOUNT SERIES, 5CCT



CATALOG NO.	DESCRIPTION	ARRIVES THIS SEASON CHECK & PRE-ORDER	PKG. QTY.
FMLS-R5-MCT5-DT	11W 680LM 27K/30K/35K/40K/50K		12
FMLS-R7-MCT5-DT	14W 900LM 27K/30K/35K/40K/50K		12
FMLS-R9-MCT5-DT	20W 1300LM 27K/30K/35K/40K/50K		8
FMLS-R11-MCT5-DT	25W 1650LM 27K/30K/35K/40K/50K		8
FMLS-R7-MCT5-DD	14W 1000LM 27K/30K/35K/40K/50K		12
FMLS-R9-MCT5-DD	20W 1600LM 27K/30K/35K/40K/50K		8
FMLS-R7-MCT5-DD-EM	14W 1000LM 27K/30K/35K/40K/50K		8
FMLS-R9-MCT5-DD-EM	20W 1600LM 27K/30K/35K/40K/50K		8



BUILDER COMPOSITE SERIES DECORATIVE FLUSH MOUNT FIXTURES

120V 5CCT E26 VER. INCL. (EXCEPT R12) RECESS ACCESSORIES



CATALOG NO.	DESCRIPTION	PKG. QTY.
FMLE-R5-MCT5-E26	9W 650LM 27K/30K/35K/40K/50K 5"	20
FMLE-R7-MCT5-E26	14W 1100LM 27K/30K/35K/40K/50K 7"	20
FMLE-R9-MCT5-E26	17W 1300LM 27K/30K/35K/40K/50K 9"	10
FMLE-R12-MCT5	21W 1500LM 27K/30K/35K/40K/50K 12"	5



ARCHITECTURAL FLUSH MOUNT SURFACE FIXTURES, 120V



CATALOG NO.	DESCRIPTION	WHILE SUPPLIES LAST	PKG. QTY.
FML-R6-11W-30K	11W 550LM 3000K 6" DIAMETER		20
FML-R6-11W-50K	11W 550LM 5000K 6" DIAMETER		20
FML-R8-14W-50K	14W 750LM 5000K 8" DIAMETER		10
FML-S6-11W-30K	11W 550LM 3000K 6" X 6"		20
FML-S6-11W-50K	11W 550LM 5000K 6" X 6"		20
FML-S8-14W-30K	14W 750LM 3000K 8" X 8"		20
FML-S10-17W-30K	17W 950LM 3000K 10" X 10"		20



WG SMART APP COMPATIBLE RGBW FLUSH MOUNT FIXTURES, 120V



CATALOG NO.	DESCRIPTION	PKG. QTY.
TC-FML-8-14W-RGBW-WIFI	14W 980LM RGBW	20
TC-FML-10-17W-RGBW-WIFI	17W 1190LM RGBW	20
TC-FML-12-22W-RGBW-WIFI	22W 1540LM RGBW	20
TC-FML-14-26W-RGBW-WIFI	26W 1820LM RGBW	20



FLUSH MOUNT SERIES, UGR<19 LOW-GLARE



CATALOG NO.	DESCRIPTION	ARRIVES THIS SEASON CHECK & PRE-ORDER	PKG. QTY.
FML-R6-MCT5-UGR	11W 700LM 27K/30K/35K/40K/50K 6"		20
FML-R8-MCT5-UGR	14W 980LM 27K/30K/35K/40K/50K 8"		10
FML-R10-MCT5-UGR	17W 1190LM 27K/30K/35K/40K/50K 10"		10
FML-R12-MCT5-UGR	22W 1540LM 27K/30K/35K/40K/50K 12"		10
FML-R14-MCT5-UGR	26W 1820LM 27K/30K/35K/40K/50K 14"		5
FML-R16-MCT5-UGR	30W 2100LM 27K/30K/35K/40K/50K 16"		5
FML-R18-MCT5-UGR	35W 2450LM 27K/30K/35K/40K/50K 18"		3
FML-R20-MCT5-UGR	40W 2800LM 27K/30K/35K/40K/50K 20"		3
FML-R22-MCT5-UGR	45W 3150LM 27K/30K/35K/40K/50K 22"		3



SPEC SERIES ARCHITECTURAL DIE-CAST FLUSH MOUNT FIXTURES, 120V, 3CCT



CATALOG NO.	DESCRIPTION	PKG. QTY.
FML-R6-MCT	11W 660LM 30K/40K/50K 6"	20
FML-R8-MCT	14W 840LM 30K/40K/50K 8"	10
FML-R10-MCT	17W 1020LM 30K/40K/50K 10"	10
FML-R14-MCT	26W 1560LM 30K/40K/50K 14"	5
FML-R18-MCT	30W 2100LM 30K/40K/50K 18"	5
FML-R22-MCT	45W 2700LM 30K/40K/50K 22"	5
FML-ULK-MCT	15W 850LM 30K/40K/50K UP LIGHT KIT FOR 18" & 22" FML SERIES	
FML-RK-712	7" OR 12" ROD KIT FOR FML FOR 18" & 22" FML SERIES	
FML-SK6	6FT ADJUSTABLE SUSPENSION KIT FOR 18" & 22" FML SERIES	



SHOWN WITH EM BASE



SHOWN WITH FML-SK6



SHOWN WITH FML-RK-712



SHOWN WITH FML-ULK-MCT

FML COLOR TRIMS (CLIP ON)

CATALOG NO.	DESCRIPTION
FML-R6-TRM-BK	6" ROUND TRIM FOR FML-R6 SERIES, BLACK FINISH
FML-R6-TRM-BN	6" ROUND TRIM FOR FML-R6 SERIES, BRUSHED NICKEL FINISH
FML-R6-TRM-BR	6" ROUND TRIM FOR FML-R6 SERIES, BRONZE FINISH
FML-R8-TRM-BK	8" ROUND TRIM FOR FML-R6 SERIES, BLACK FINISH
FML-R8-TRM-BN	8" ROUND TRIM FOR FML-R6 SERIES, BRUSHED NICKEL FINISH
FML-R8-TRM-BR	8" ROUND TRIM FOR FML-R6 SERIES, BRONZE FINISH
FML-R10-TRM-BK	10" ROUND TRIM FOR FML-R6 SERIES, BLACK FINISH
FML-R10-TRM-BN	10" ROUND TRIM FOR FML-R6 SERIES, BRUSHED NICKEL FINISH
FML-R10-TRM-BR	10" ROUND TRIM FOR FML-R6 SERIES, BRONZE FINISH



FACTORY-INSTALLED OPTIONS, ENTER DESIRED OPTION CODE(S) AS LINE ITEMS ON YOUR PURCHASE ORDER UNDER THE PRODUCT CATALOG NUMBER

WATTS	EM OPTION	DESCRIPTION	PHOTOCELL	DESCRIPTION	PAINT	SENSOR	DESCRIPTION
FML-R6	OPT-EM-FML-R6	MOUNT IN EXTENDED BASE	OPT-PC-FML8	BUTTON	N/A	N/A	N/A
FML-R8	OPT-EM-FML-R8	MOUNT IN EXTENDED BASE	OPT-PC-FML10	BUTTON			
FML-R10	OPT-EM-FML-R10	MOUNT IN EXTENDED BASE	277V OPTION	DESCRIPTION			
FML-R14	OPT-EM-FML-R14	MOUNT IN EXTENDED BASE	OPT-277V-FML-R8	EXTERNAL BOX			
			OPT-277V-FML-R10	EXTERNAL BOX			

MODERN 3CCT FLUSH MOUNT DRUM



CATALOG NO.	DESCRIPTION	PKG. QTY.
FCD-13-MCT-BG	25W 2350LM 3000K/4000K/5000K 13" Black/Gold	5
FCD-16-MCT-BG	30W 2800LM 3000K/4000K/5000K 16" Black/Gold	5



RESIDENTIAL
SURFACE MOUNT

LED 5CCT INTEGRATED LED FABRIC DRUM



CATALOG NO.	DESCRIPTION	PKG. QTY.
LCFF-15-MCT5-BR	25W 1400LM 27K/30K/35K/40K/50K 15" Bronze	2
LCFF-18-MCT5-BR	35W 1800LM 27K/30K/35K/40K/50K 18" Bronze	2
LCFF-22-MCT5-BR	45W 2100LM 27K/30K/35K/40K/50K 22" Bronze	2
LCFF-15-MCT5-BN	25W 1400LM 27K/30K/35K/40K/50K 15" Brushed Nickel	2
LCFF-18-MCT5-BN	35W 1800LM 27K/30K/35K/40K/50K 18" Brushed Nickel	2
LCFF-22-MCT5-BN	45W 2100LM 27K/30K/35K/40K/50K 22" Brushed Nickel	2
LCF-ROD-5-BR	5In Suspension Rod For Ceiling Fixture Swivel Canopy, Bronze	
LCF-ROD-12-BR	12In Suspension Rod For Ceiling Fixture Swivel Canopy, Bronze	
LCF-ROD-24-BR	24In Suspension Rod For Ceiling Fixture Swivel Canopy, Bronze	
LCF-ROD-36-BR	36In Suspension Rod For Ceiling Fixture Swivel Canopy, Bronze	
LCF-ROD-48-BR	48In Suspension Rod For Ceiling Fixture Swivel Canopy, Bronze	
LCF-ROD-5-BN	5In Suspension Rod For Ceiling Fixture Swivel Canopy, Brushed Nickel	
LCF-ROD-12-BN	12In Suspension Rod For Ceiling Fixture Swivel Canopy, Brushed Nickel	
LCF-ROD-24-BN	24In Suspension Rod For Ceiling Fixture Swivel Canopy, Brushed Nickel	
LCF-ROD-36-BN	36In Suspension Rod For Ceiling Fixture Swivel Canopy, Brushed Nickel	
LCF-ROD-48-BN	48In Suspension Rod For Ceiling Fixture Swivel Canopy, Brushed Nickel	
LCF-CANOPY-S-BR	Swivel Ceiling Canopy For Ceiling Fixtures, Bronze	
LCF-CANOPY-S-BN	Swivel Ceiling Canopy For Ceiling Fixtures, Brushed Nickel	
LFCF-SK10-BR	10Ft 4Line Canopy Suspension Kit For Decorative Lights, Bronze	
LFCF-SK10-BN	10Ft 4Line Canopy Suspension Kit For Decorative Lights, Brushed Nickel	
FML-ULK-MCT	15W, 850Lm, 30K/40K/50K Up Light Kit	



SHOWN WITH ROD & CANOPY



SHOWN WITH SUSPENSION KIT & CANOPY

RESIDENTIAL

PENDANT LIGHTS



NORDIC DESIGN PENDANT WITH LEATHER STRAP, INTEGRATED 5CCT LED

CATALOG NO.	DESCRIPTION	PKG. QTY.
LCFN-MCT5-WH	25W 1400LM 27K/30K/35K/40K/50K White	2
LCFN-MCT5-BK	25W 1400LM 27K/30K/35K/40K/50K Black	2

WINE BOTTLE PENDANT, COMMERCIAL/RESIDENTIAL 10FT ADJ. CORD, 9" DIA.



CATALOG NO.	DESCRIPTION	ARRIVES THIS SEASON CHECK & PRE-ORDER	PKG. QTY.
LCFW-MCTP-BK	6W/9W/12W 960LM Max. 30K/40K/50K		4
LCFW-MCTP-WH	6W/9W/12W 960LM Max. 30K/40K/50K		4



MODERN 3CCT FLUSH MOUNT DRUM



CATALOG NO.	DESCRIPTION	PKG. QTY.
LDAP-10-MCT5	12W 700LM 27K/30K/35K/40K/50K BLACK, 10" Dia.	4
LDAP-14-MCT5	18W 900LM 27K/30K/35K/40K/50K BLACK, 14" Dia.	4



5CCT INTEGRATED LED MODERN CONE PENDANT LIGHTS, 11-4/5" DAI.



CATALOG NO.	DESCRIPTION	PKG. QTY.
LCFC-MCT5-BK	25W 1300LM 27K/30K/35K/40K/50K Black	2
LCFC-MCT5-WH	25W 1300LM 27K/30K/35K/40K/50K White	2
LCFC-BF-ACC-GD	LCFC Pendant Modification Accessory, Electroplated Gold	
LCFC-BF-ACC-BN	LCFC Pendant Modification Accessory, Brushed Nickel	



SHOWN WITH MODIFICATION ACCESSORY



24" INTEGRATED LED PAN PENDANT WITH 6FT ADJ. ROD DOWN, 5CCT



CATALOG NO.	DESCRIPTION	PKG. QTY.
LCFP-MCT5-WG	40W 2800LM 27K/30K/35K/40K/50K	1
LCFP-MCT5-BG	40W 2800LM 27K/30K/35K/40K/50K	1



12" LARGE INTEGRATED LED DOME PENDANT WITH 6FT CORD, 5CCT



CATALOG NO.	DESCRIPTION	PKG. QTY.
LCFR-MCT5-WG	24W 820LM 27K/30K/35K/40K/50K	2
LCFR-MCT5-BG	24W 820LM 27K/30K/35K/40K/50K	2

12" INTEGRATED LED VINTAGE PENDANT LIGHTS, 5CCT



CATALOG NO.	DESCRIPTION	PKG. QTY.
LCFA-MCT5-BK	25W 1300LM 27K/30K/35K/40K/50K Black (Copper Inside)	2
LCFA-MCT5-WH	25W 1300LM 27K/30K/35K/40K/50K White Gloss (Copper Inside)	2



RESIDENTIAL
PENDANT
LIGHTS



LCFS-MCT-BK
LCFS-MCT-WH



LCFQ-MCT-BK
All Black



Shown with
Brushed Nickel or
Anodized Gold



LCFQ-MCT-WH
All White



Shown with
Brushed Nickel or
Anodized Gold



LCFT-MCTP-BK
Black



LCFT-MCTP-BK
Black



LCFT-MCTP-BK
Black



Shown with
Acrylic Drop Lens

POWER & CCT-ADJUSTABLE CONE PENDANT



CATALOG NO.	DESCRIPTION	PKG. QTY.
3CCT CONE PENDANT WITH 5FT ADJ. DOWNROD, 7" Dia.		
LCFS-MCT-BK	6W/9W/12W 600LM Max. 30K/40K/50K Black	4
LCFS-MCT-WH	6W/9W/12W 600LM Max. 30K/40K/50K White	4
3CCT CONE PENDANT WITH 6FT ADJ. CORD, 6" Dia.		
LCFQ-MCT-BK	6W/9W/12W 600LM Max. 30K/40K/50K Black	12
LCFQ-MCT-WH	6W/9W/12W 600LM Max. 30K/40K/50K White	12
CMC2-TRMWM-AG	Replacement Trim Accessory, Anodized Gold	
CMC2-TRMWM-BN	Replacement Trim Accessory, Brushed Nickel	
POWER & CCT ADJUSTABLE TAPERED PENDANT WITH 6FT ADJ. CORD, 2" Dia.		
LCFT-MCTP-BK	3W/6W/9W 720LM Max. 30K/40K/50K Black	8
LCFT-MCTP-WH	3W/6W/9W 720LM Max. 30K/40K/50K White	8
LCFT-MCTP-BN	3W/6W/9W 720LM Max. 30K/40K/50K Brushed Nickel	8
LCFT-DL25	LCFT 2in 25mm Acrylic Drop Lens	

RESIDENTIAL

PENDANT LIGHTS



LCFD-MCT-BK
Black



LCFD-MCT-WH
White



LCFD-MCT-WS
White/Silver



LCFD-MCT-BG
Black/Gold



LCFD-20-MCT-WS
White/Silver



LCFD-20-MCT-BG
Black/Gold

5CCT INTEGRATED LED MODERN DOME PENDANT LIGHTS



CATALOG NO.	DESCRIPTION	PKG. QTY.
12" INTEGRATED LED MODERN DOME PENDANT LIGHTS, 5CCT		
LCFD-MCT5-BK	25W 1300LM 27K/30K/35K/40K/50K Black 12"	2
LCFD-MCT5-WH	25W 1300LM 27K/30K/35K/40K/50K White 12"	2
LCFD-MCT5-WS	25W 1300LM 27K/30K/35K/40K/50K White/Silver 12"	2
LCFD-MCT5-BG	25W 1300LM 27K/30K/35K/40K/50K Black/Gold 12"	2
20" INTEGRATED LED MODERN DOME PENDANT LIGHTS		
LCFD-20-MCT5-WS	40W 2250LM 27K/30K/35K/40K/50K White/Silver 20"	2
LCFD-20-MCT5-BG	40W 2250LM 27K/30K/35K/40K/50K Black/Gold 20"	2

5CCT INTEGRATED LED PENDANT LIGHTS xFT Adjustable



CATALOG NO.	DESCRIPTION	PKG. QTY.
LCFB-1L-MCT5	12W 810LM 27K/30K/35K/40K/50K Single	4
LCFB-3LR-MCT5	36W 2430LM 27K/30K/35K/40K/50K Triple w/ Square Canopy	2
LCFB-3LS-MCT5	36W 2430LM 27K/30K/35K/40K/50K Triple w/ Straight Bar	1

5CCT INTEGRATED LED HOLOGRAM PENDANT LIGHTS

xFT Adjustable



CATALOG NO.	DESCRIPTION	PKG. QTY.
LCFH-1L-MCT5	12W 810LM 27K/30K/35K/40K/50K Single	4
LCFH-3LR-MCT5	36W 2430LM 27K/30K/35K/40K/50K Triple w/ Round Canopy	2
LCFH-3LS-MCT5	36W 2430LM 27K/30K/35K/40K/50K Triple w/ Straight Bar	1

4" GLASS LENS PENDANT WITH 6FT ADJ. ROD, 5CCT



CATALOG NO.	DESCRIPTION	PKG. QTY.
LCFE-MCT5-BN	12W 720LM 27K/30K/35K/40K/50K Brushed Nickel	4
LCFE-MCT5-BK	12W 720LM 27K/30K/35K/40K/50K Black	4



FACTORY-INSTALLED OPTIONS, ENTER DESIRED OPTION CODE(S) AS LINE ITEMS ON YOUR PURCHASE ORDER UNDER THE PRODUCT CATALOG NUMBER

WATTS	EM OPTION	DESCRIPTION	PHOTOCELL	DESCRIPTION	PAINT	SENSOR	DESCRIPTION
LCFF, LCFN, LDAP, LCFFD LCFC, LCFP, LCFR, LCFB LCFS, LCFQ, LCFA, LCFH LCFS, LCFQ, LCFA, LCFE	OPT-EM-LCFX-WH OPT-EM-LCFX-BK OPT-EM-LCFX-BN	INTERNAL White INTERNAL Black INTERNAL Brushed Nickel		N/A	N/A	N/A	N/A



BEDSIDE READING LAMPS WITH BACKLIT, WIRELESS CHARGING, & USB OPTIONS



CATALOG NO.	DESCRIPTION	PKG. QTY.
BRL-RH-WH	3W 120LM 3000K Horizontal Recessed, White	20
BRL-RH-BK	3W 120LM 3000K Horizontal Recessed, Black	20
BRL-RH-BN	3W 120LM 3000K Horizontal Recessed, Brushed Nickel	20
BRL-RV-WH	3W 120LM 3000K Vertical Recessed, White	20
BRL-RV-BK	3W 120LM 3000K Vertical Recessed, Black	20
BRL-RV-BN	3W 120LM 3000K Vertical Recessed, Brushed Nickel	20
BRL-SHR-WCH-WH	10W 500LM 3000K Horiz. Surf. Backlit + USB & W/L CHG., Right Side, White	5
BRL-SHR-WCH-BK	10W 500LM 3000K Horiz. Surf. Backlit + USB & W/L CHG., Right Side, Black	5
BRL-SHL-WCH-WH	10W 500LM 3000K Horiz. Surf. Backlit + USB & W/L CHG., Left Side, White	5
BRL-SHL-WCH-BK	10W 500LM 3000K Horiz. Surf. Backlit + USB & W/L CHG., Left Side, Black	5
BRL-SV-WH	10W 500LM 3000K Vert. Surf. Backlit + USB, White	5
BRL-SV-BK	10W 500LM 3000K Vert. Surf. Backlit + USB, Black	5

RESIDENTIAL PENDANT LIGHTS

BUILDER SERIES 6" LED ECONOMY DISC LIGHT, 120V



CATALOG NO.	DESCRIPTION	PKG. QTY.
DLSE6-30K	15W 900LM 3000K	20
DLSE6-40K	15W 900LM 4000K	20
DLSE6-50K	15W 900LM 5000K	20

BUILDER SERIES 4" & 6" LED 5CCT DISK LIGHT ECONOMY DISC LIGHT (JA8-E-2019 COMPLIANT)



CATALOG NO.	DESCRIPTION	ARRIVES THIS SEASON CHECK & PRE-ORDER	PKG. QTY.
DLSE4-MCT5	9W 540LM 27K/30K/35K/40K/50K	4" White	20
DLSE6-MCT5	15W 1000LM 27K/30K/35K/40K/50K	6" White	20
DLSE6-MCT5-BR	15W 1000LM 27K/30K/35K/40K/50K	6" Bronze	20
DLSE6-MCT5-BN	15W 1000LM 27K/30K/35K/40K/50K	6" Brushed Nickel	20

BUILDER SERIES 4" & 6" LED MULTI-CCT ECONOMY DISC LIGHT (JA8-E-2019 COMPLIANT)



CATALOG NO.	DESCRIPTION	WHILE SUPPLIES LAST	PKG. QTY.
DLSE4-MCT	9W 540LM 3000K/4000K/5000K	4" White	20
DLSE6-MCT	15W 1000LM 3000K/4000K/5000K	6" White	20
DLSE6-MCT-BR	15W 1000LM 3000K/4000K/5000K	6" Bronze	20
DLSE6-MCT-BN	15W 1000LM 3000K/4000K/5000K	6" Brushed Nickel	20

LED DISC LIGHT 4" & 6" 120V (J-BOX MOUNTING)(JA8-E-2016 COMPLIANT)



CATALOG NO.	DESCRIPTION	WHILE SUPPLIES LAST	PKG. QTY.
DLSN4-27K	10W 600LM 2700K		20
DLSN4-30K	10W 600LM 3000K		20
DLSN4-41K	10W 600LM 4000K		20
DLSN4-50K	10W 600LM 5000K		20
DLSN6-27K	15W 1000LM 2700K		20
DLSN6-30K	15W 1000LM 3000K		20
DLSN6-41K	15W 1000LM 4000K		20
DLSN6-50K	15W 1000LM 5000K		20
DLSN6-30K-BR	15W 1000LM 3000K	BRONZE	20
DLSN6-30K-BN	15W 1000LM 3000K	BRUSHED NICKEL	20

SPEC SERIES 3CCT HIGH-PERFORMANCE DISC LIGHTS, 120V DIE CAST ALUMINUM, ALL MOUNTING OPTIONS INCL.



CATALOG NO.	DESCRIPTION	PKG. QTY.
DLS4-MCT	9W 540LM 3000K/4000K/5000K 4"	20
DLS6-MCT	15W 900LM 3000K/4000K/5000K 6"	20
DLS6-MCT-BN	15W 900LM 3000K/4000K/5000K 6" BRUSHED NICKEL	20
DLS6-MCT-BR	15W 900LM 3000K/4000K/5000K 6" BRONZE	20
DLS8-MCT	20W 1200LM 3000K/4000K/5000K 8"	10
DLS10-MCT	25W 1500LM 3000K/4000K/5000K 10"	10
DLS12-MCT	30W 1800LM 3000K/4000K/5000K 12"	5



FACTORY-INSTALLED OPTIONS, ENTER DESIRED OPTION CODE(S) AS LINE ITEMS ON YOUR PURCHASE ORDER UNDER THE PRODUCT CATALOG NUMBER

WATTS	EM OPTION	DESCRIPTION	PHOTOCELL	DESCRIPTION	PAINT	SENSOR	DESCRIPTION
DLS6, DLSE6, DLSN6	OPT-EM-DLS6	MOUNT IN EXTENDED BASE	OPT-PC-DLS6	Photocell	N/A	N/A	N/A
DLS8	OPT-EM-DLS8	MOUNT IN EXTENDED BASE					
DLS10	OPT-EM-DLS10	MOUNT IN EXTENDED BASE					
DLS12	OPT-EM-DLS12	MOUNT IN EXTENDED BASE					

RESIDENTIAL
DISC LIGHTS

SPEC SERIES HIGH-PERFORMANCE DISC LIGHTS, 120V

DIE CAST ALUMINUM, ALL MOUNTING OPTIONS INCL.



SPEC SERIES		CATALOG NO.	DESCRIPTION	WHILE SUPPLIES LAST		PKG. QTY.
		DLS4-27K	9W 550-600LM 2700K	4"		20
		DLS4-30K	9W 550-600LM 3000K	4"		20
		DLS4-41K	9W 550-600LM 4000K	4"		20
		DLS4-50K	9W 550-600LM 5000K	4"		20
		DLS6-27K	15W 950-1000LM 2700K	6"		20
		DLS6-30K	15W 950-1000LM 3000K	6"		20
		DLS6-41K	15W 950-1000LM 4000K	6"		20
		DLS6-50K	15W 950-1000LM 5000K	6"		20
		DLS6-30K-BR	15W 950-1000LM 3000K BRONZE	6"		20
		DLS6-30K-BN	15W 950-1000LM 3000K BRUSHED NICKEL	6"		20

FACTORY-INSTALLED OPTIONS, ENTER DESIRED OPTION CODE(S) AS LINE ITEMS ON YOUR PURCHASE ORDER UNDER THE PRODUCT CATALOG NUMBER

WATTS	EM OPTION	DESCRIPTION	PHOTOCELL	DESCRIPTION	PAINT	SENSOR	DESCRIPTION
DLS6, DLS6E, DLSN6 DLS8 DLS10 DLS12	OPT-EM-DLS6 OPT-EM-DLS8 OPT-EM-DLS10 OPT-EM-DLS12	MOUNT IN EXTENDED BASE MOUNT IN EXTENDED BASE MOUNT IN EXTENDED BASE MOUNT IN EXTENDED BASE	OPT-PC-DLS6	Photocell	N/A	N/A	N/A

SPECS SERIES HIGH-PERFORMANCE DIE-CAST DISK LIGHTS, 277V



SPEC SERIES		CATALOG NO.	DESCRIPTION	PKG. QTY.
		DLS6-MCT-277V	15W 900LM 3000K/4000K/5000K 6"	20
		DLS12-MCT-277V	30W 1800LM 3000K/4000K/5000K 12"	5

SPECS SERIES HIGH-PERFORMANCE DIE-CAST DISK LIGHTS WITH PIR MOTION SENSOR



SPEC SERIES		CATALOG NO.	DESCRIPTION	PKG. QTY.
		DLS4-MCT-PIR	9W 540LM 3000K/4000K/5000K 4"	20
		DLS6-MCT-PIR	15W 900LM 3000K/4000K/5000K 6"	20
		DLS8-MCT-PIR	20W 1200LM 3000K/4000K/5000K 8"	10
		DLS10-MCT-PIR	25W 1500LM 3000K/4000K/5000K 10"	10
		DLS12-MCT-PIR	30W 1800LM 3000K/4000K/5000K 12"	5

LED 5CCT DOME FLUSH MOUNT



CATALOG NO.	DESCRIPTION	PKG. QTY.
FMD-11-MCT5-BN	20W 1500LM 27K/30K/35K/40K/50K Brushed Nickel 11"	8
FMD-11-MCT5-ORB	20W 1500LM 27K/30K/35K/40K/50K Oil-Rubbed Bronze 11"	8
FMD-11-MCT5-WH	20W 1500LM 27K/30K/35K/40K/50K White 11"	8
FMD-13-MCT5-BN	24W 1800LM 27K/30K/35K/40K/50K Brushed Nickel 13"	8
FMD-13-MCT5-ORB	24W 1800LM 27K/30K/35K/40K/50K Oil-Rubbed Bronze 13"	8
FMD-13-MCT5-WH	24W 1800LM 27K/30K/35K/40K/50K White 13"	8

FACTORY-INSTALLED OPTIONS, ENTER DESIRED OPTION CODE(S) AS LINE ITEMS ON YOUR PURCHASE ORDER UNDER THE PRODUCT CATALOG NUMBER

WATTS	EM OPTION	DESCRIPTION	PHOTOCELL	DESCRIPTION	PAINT	SENSOR	DESCRIPTION
FMD-11 FMD-13	OPT-EM-FMD11 OPT-EM-FMD13	INTERNAL INTERNAL		N/A	N/A	OPT-SEN-2US INTERNAL FOR ALL MODELS OPT-SEN-2USRC	ULTRASONIC BI-LEVEL DIMMING (REMOTE NOT NEEDED) OPTIONAL RC

RESIDENTIAL DISC LIGHTS



LED PL LAMPS



CATALOG NO.	DESCRIPTION	POSITION	ROTATABLE	BALLAST	WHILE SUPPLIES LAST
 LPL-EB-9W-H-40K	9W 800LM 4000K	Horizontal	90°	Electronic Ballast	

LED TYPE A+B PL LAMPS



CATALOG NO.	DESCRIPTION	PKG. QTY.
 LPL-G24-AB-11W	11W 1300LM 4000K	1
 LPL-GX23-AB-8W	8W 800LM 4000K	1

12 LED LAMPS /24FT. STG



CATALOG NO.	DESCRIPTION	TOTAL LED
 STG-2412-27K	1W per bulb 75LM per S14 bulb 2700K 1W PER BULB	12

RESIDENTIAL

53FT 15-BULB ST14 RGB STRING LIGHT



CATALOG NO.	DESCRIPTION
 STG-5315-RGB-BT	53Ft 15-Bulb ST14 Rgb String Light 1M Appart With 11 Fairy Lights In Between Bluetooth

LAMPS

LANTERN DESIGN STRING LIGHT RGB BLUETOOTH APP CONTROLLED



CATALOG NO.	DESCRIPTION
 STG-2415-LANT-RGBIC-BT	24Ft 15-Lamp Lantern Design String Light Rgb Bluetooth App Controlled
STG-4830-LANT-RGBIC-BT	48Ft 30-Lamp Lantern Design String Light Rgb Bluetooth App Controlled

A19 LED LAMPS



CATALOG NO.	DESCRIPTION	PKG. QTY.
 A19-9W-MCT5-D	9W 800LM 27K/30K/35K/40K/50K	1

A19 LED LAMPS (Medium Base) 240° 15K Hours



CATALOG NO.	DESCRIPTION	MASTER QTY.
 A19-8PK-9W-30K-D	9W 700LM 3000K 8-PACK	64
A19-8PK-9W-40K-D	9W 810LM 4000K 8-PACK	64
A19-8PK-9W-50K-D	9W 810LM 5000K 8-PACK	64
A19-40PK-9W-30K-D	9W 700LM 3000K 40-PACK	40
A19-40PK-9W-40K-D	9W 810LM 4000K 40-PACK	40
A19-40PK-9W-50K-D	9W 810LM 5000K 40-PACK	40

WG SMART APP COMPATIBLE RGBW A19 LAMP, 120V



CATALOG NO.	DESCRIPTION	PKG. QTY.
 TC-A19-9W-RGBW-WIFI	9W 800LM RGBW E26 Base	50

MR16 LED LAMPS, 12V AC/DC GU5.3 BASE 36°

*Dimmable with magnetic ballast only



CATALOG NO.	DESCRIPTION	PKG. QTY.
 MR16-400L-27K-D	5W 380LM 2700K 80CRI	200
MR16-400L-30K-D	5W 380LM 3000K 80CRI	200
MR16-400L-41K-D	5W 390LM 4100K 80CRI	200
MR16-400L-50K-D	5W 400LM 5000K 80CRI	200
 MR16-500L-C90-30K-D	7W 500LM 3000K 90CRI	100
MR16-500L-C90-40K-D	7W 560LM 4000K 90CRI	100
MR16-500L-C90-50K-D	7W 560LM 5000K 90CRI	100

MR11 LED LAMPS, 12V AC/DC GU5.3 BASE 36°

CATALOG NO.	DESCRIPTION	PKG. QTY.
 MR11-250L-27K	3W 250LM 2700K	
MR11-250L-30K	3W 250LM 3000K	

BR30 LED LAMPS



CATALOG NO.	DESCRIPTION	PKG. QTY.
 BR30-9W-MCT5-D	9W 800LM 27K/30K/35K/40K/50K	1

PAR38 LED LAMPS



CATALOG NO.	DESCRIPTION	PKG. QTY.
 PAR38-12W-MCT5-D-WP	12W 1200LM 27K/30K/35K/40K/50K	1

PAR36 12V AC/DC G53 Terminal Base, IP65, WET LOCATION

















CATALOG NO.	DESCRIPTION	PKG. QTY.
 PAR36-12W-30K	12W 1000LM 3000K	20
PAR36-12W-40K	12W 1000LM 4000K	20
PAR36-12W-50K	12W 1000LM 5000K	20

WG SMART APP COMPATIBLE RGBW PAR20/PAR30/PAR38, 120V



CATALOG NO.	DESCRIPTION	PKG. QTY.
 TC-PAR20-5W-RGBW-WIFI	5W 400LM RGBW E26 Base	50
 TC-PAR30-11W-RGBW-WIFI	11W 850LM RGBW E26 Base	50
 TC-PAR38-13W-RGBW-WIFI	13W 1050LM RGBW E26 Base	50

12-VOLT LED REPLACEMENT LAMPS

CATALOG NO.	DESCRIPTION	PKG. QTY.
 GZ-JC-39L-27K	3W 250LM 2700K 12VAC/DC	1000
 GZ-JC-39L-30K	 3W 250LM 3000K 12VAC/DC	1000
 GZ-JC-18L-27K	3W 250LM 2700K 12VAC/DC	1000
 GZ-JC-18L-32K	3W 250LM 3200K 12VAC/DC	1000
 GZ-JC-WP-3W-32K	 3W 180LM 3200K 12VAC/DC	1000
 GZ-S8-32K-G2	2.2W 230LM 3200K 12V	500
 GZ-S8-32K	1.4W 70LM 3200K 12V	500
 GZ-G4-9L-32K	2W 120LM 3200K 12V	1000
 GZ-JC-60L-TFL	3W 60LM TURTLE FRIENDLY CCT	1000
 GZ-JC-300L-27K	 3W 300LM 2700K 360° Beam Angle	1000
 GZ-JC-300L-30K	 3W 300LM 3000K 360° Beam Angle	1000

LED REPLACEMENT LAMPS, 120V

CATALOG NO.	DESCRIPTION	PKG. QTY.
 GZ-G9-3W-32K	3W 240LM 3200K G9	500
GZ-G9-3W-55K	3W 250LM 5500K G9	500

HIGH POWER GU10, 120V



CATALOG NO.	DESCRIPTION	PKG. QTY.
 G10-600L-30K-D	7.5W 500LM 3000K SMD CRI80 30° ANGLE	60
G10-600L-50K-D	7.5W 600LM 5000K SMD CRI80 30° ANGLE	60

LED FILAMENT CANDELABRA, 120V



CATALOG NO.	DESCRIPTION	PKG. QTY.
 E12-FLA-5W-27K-D	4W 400LM 2700K CLEAR TORPEDO	48
E12-FLA-5W-40K-D	4W 400LM 4000K CLEAR TORPEDO	48
E12-FLA-5W-27K-D-F-BT	4W 300LM 2700K FROSTED BENT TIP	48
E12-FLA-5W-40K-D-F-BT	4W 300LM 4000K FROSTED BENT TIP	48

WG SMART APP COMPATIBLE RGBW CANDELABRA, 120V



CATALOG NO.	DESCRIPTION	PKG. QTY.
 TC-E12-4.5W-RGBW-WIFI	4.5W 325LM RGBW E12 Base	50

LED FILAMENT A19 BULB, 120V



CATALOG NO.	DESCRIPTION	PKG. QTY.
 A19-FLA-7W-27K-D	7W 800LM 2700K CLEAR	100
A19-FLA-7W-40K-D	7W 800LM 4000K CLEAR	100

LED FILAMENT ST19 BULB, 120V

CATALOG NO.	DESCRIPTION	PKG. QTY.
 ST19-FLA-5W-27K-D-CL	5W 430LM 2700K	24
ST19-FLA-5W-22K-D-AM	5W 380LM 2200K (LED Component 2700K)	24

RGB BULBS

CATALOG NO.	DESCRIPTION
 MR16-5W-RGB	5W 280LM RGB 12V 30° REMOTE CONTROL



WESTGATE SMART APP COMPATIBLE RGBW SERIES



WG SMART APP COMPATIBLE RGBW SMOOTH RECESSED LIGHT TRIM - ROUND, 120V



CATALOG NO.	DESCRIPTION	PKG. QTY.
 TC-RDPS4-10W-RGBW-WIFI	10W 650LM RGBW 4" E26 Base	12
TC-RDPS6-13W-RGBW-WIFI	13W 850LM RGBW 6" E26 Base	8

WG SMART APP COMPATIBLE RGBW PAR20/PAR30/PAR38, 120V



CATALOG NO.	DESCRIPTION	PKG. QTY.
 TC-PAR20-5W-RGBW-WIFI	5W 400LM RGBW E26 Base	50
TC-PAR30-11W-RGBW-WIFI	11W 850LM RGBW E26 Base	50
TC-PAR38-13W-RGBW-WIFI	13W 1050LM RGBW E26 Base	50

WG SMART APP COMPATIBLE RGBW G25 LAMP, 120V



CATALOG NO.	DESCRIPTION	PKG. QTY.
 TC-G25-5W-RGBW-WIFI	5W 450LM RGBW E26 Base	50

WG SMART APP COMPATIBLE RGBW CANDELABRA, 120V



CATALOG NO.	DESCRIPTION	PKG. QTY.
 TC-E12-4.5W-RGBW-WIFI	4.5W 325LM RGBW E12 Base	50

WG SMART APP COMPATIBLE RGBW A19 LAMP, 120V



CATALOG NO.	DESCRIPTION	PKG. QTY.
 TC-A19-9W-RGBW-WIFI	9W 800LM RGBW E26 Base	50

WG SMART APP COMPATIBLE RGBW FLUSH MOUNT FIXTURES, 120V

CATALOG NO.	DESCRIPTION	PKG. QTY.
 TC-FML-8-14W-RGBW-WIFI	14W 980LM RGBW	20
TC-FML-10-17W-RGBW-WIFI	17W 1190LM RGBW	20
TC-FML-12-22W-RGBW-WIFI	22W 1540LM RGBW	20
TC-FML-14-26W-RGBW-WIFI	26W 1820LM RGBW	20

BLUETOOTH WG APP COMPATIBLE RGBW FLOOD LIGHT, 40D LENS, 12V



CATALOG NO.	DESCRIPTION	PKG. QTY.
 TC-GL-12V-15W-RGBW-BT-BR	15W 405LM RGBW	6

BLUETOOTH WG APP COMPATIBLE RGBW FLOOD LIGHT, 60D LENS, 12V



CATALOG NO.	DESCRIPTION	PKG. QTY.
 TC-FL-12V-36W-RGBW-BT-BR	36W 824LM RGBW	4

BLUETOOTH WG APP COMPATIBLE RGBW FLOOD LIGHT, 60D LENS, 120-277V



CATALOG NO.	DESCRIPTION	PKG. QTY.
 TC-FL-36W-RGBW-BT-BR	36W 824LM RGBW	4

RESIDENTIAL
SMART SERIES



WESTGATE SMART APP COMPATIBLE RGBW SERIES



53FT 15-BULB ST14 RGB STRING LIGHT



CATALOG NO. DESCRIPTION



STG-5315-RGB-BT 53Ft 15-Bulb ST14 Rgb String Light 1M Appart With 11 Fairy Lights In Between Bluetooth

LANTERN DESIGN STRING LIGHT RGB BLUETOOTH APP CONTROLLED



CATALOG NO. DESCRIPTION



STG-2415-LANT-RGBIC-BT 24Ft 15-Lamp Lantern Design String Light Rgb Bluetooth App Controlled

STG-4830-LANT-RGBIC-BT 48Ft 30-Lamp Lantern Design String Light Rgb Bluetooth App Controlled

SPEC SERIES X GEN. RGB STADIUM LIGHTS, DMX512 CONTROLLED - SPECIAL ORDER



CATALOG NO. DESCRIPTION

PKG. QTY.



SFX-G9-500W-45D-RGB 500W RGB

1

SFX-G9-800W-45D-RGB 800W RGB

1

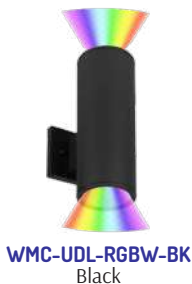

WMC-UDL-RGBW-BK
Black



WMC-UDL-RGBW-WH
White



WMC-UDL-RGBW-BK
Black



WMC-UDL-RGBW-WH
White

RGBW LED OUTDOOR CYLINDER LIGHTS, IP65

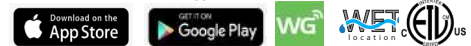

CATALOG NO.	DESCRIPTION	PKG. QTY.
4" LED ROUND CYLINDER LIGHTS, 120V (UP/DOWN LIGH) H: 12"		
WMC-UDL-RGBW-BK	24W 1920LM RGBW 25° Black	6
WMC-UDL-RGBW-WH	24W 1920LM RGBW 25° White	6
4" LED SQUARE CYLINDER LIGHTS, 120V (UP/DOWN LIGHT) H: 10-1/4"		
WMCS-UDL-RGBW-BK	24W 1920LM RGBW 30° Black	6
WMCS-UDL-RGBW-WH	24W 1920LM RGBW 30° White	6

CMC RGBW CYLINDER LIGHTS, PENDANT OR SURFACE MOUNT, APP CONTROLLED

CATALOG NO.	DESCRIPTION	ARRIVES THIS SEASON CHECK & PRE-ORDER	PKG. QTY.
CMC2L-RGBW-BK	6W 300LM 27K-50K + RGB		6
CMC2L-RGBW-WH	6W 300LM 27K-50K + RGB		6
CMC3-RGBW-BK	9W 550LM 27K-50K + RGB		6
CMC3-RGBW-WH	9W 550LM 27K-50K + RGB		6
CMC4-RGBW-BK	15W 900LM 27K-50K + RGB		6
CMC4-RGBW-WH	15W 900LM 27K-50K + RGB		6
CMC6-RGBW-BK	20W 1200LM 27K-50K + RGB		8
CMC6-RGBW-WH	20W 1200LM 27K-50K + RGB		8







RIBBON LIGHTING



24-VOLT INDOOR LED RIBBON LIGHTS - STANDARD OUTPUT



Standard
OUTPUT

CATALOG NO.	DESCRIPTION	REEL LENGTH
STANDARD OUTPUT LED RIBBON—INDOOR (16.4FT ROLLS) (Max Run 49ft)		
 ULR-IN-16F-SO-27K	1.5W/FT 100LM/FT 2700K 8mm Width	16.4FT
ULR-IN-16F-SO-30K	1.5W/FT 100LM/FT 3000K 8mm Width	16.4FT
ULR-IN-16F-SO-35K	1.5W/FT 100LM/W 3500K 8mm Width	16.4FT
ULR-IN-16F-SO-40K	1.5W/FT 100LM/FT 4000K 8mm Width	16.4FT
ULR-IN-16F-SO-50K	1.5W/FT 100LM/FT 5000K 8mm Width	16.4FT
STANDARD OUTPUT LED RIBBON—INDOOR (98.4FT ROLLS) (Max Run 49ft)		
 ULR-IN-98F-SO-27K	1.5W/FT 100LM/FT 2700K 8mm Width	98.4FT
ULR-IN-98F-SO-30K	1.5W/FT 100LM/FT 3000K 8mm Width	98.4FT
ULR-IN-98F-SO-35K	1.5W/FT 100LM/W 3500K 8mm Width	98.4FT
ULR-IN-98F-SO-40K	1.5W/FT 100LM/FT 4000K 8mm Width	98.4FT
ULR-IN-98F-SO-50K	1.5W/FT 100LM/FT 5000K 8mm Width	98.4FT
INDOOR TANDEM COUPLINGS		
 ULR-IN-SO-COUP-6I-WR	Coupling to connect 2 standard output ribbons, 6"	
ULR-IN-SO-COUP-3F-WR	Coupling to connect 2 standard output ribbons, 3ft	
ULR-IN-SO-COUP-NO-WR	Coupling to connect 2 standard output ribbons, no wire	
INDOOR POWER FEED CABLES		
 ULR-IN-SO-CONN-6I-WR	1 side ribbon connector, 1 side female socket to driver, 6"	
ULR-IN-SO-CONN-3F-WR	1 side ribbon connector, 1 side female socket to driver, 3ft	
ULR-IN-SO-CONN-3F-PT	1 side ribbon connector, 1 side open end, 3ft	
ULR-IN-SO-CONN-10F-PT	1 side ribbon connector, 1 side open end, 10ft	

RIBBON





24-VOLT INDOOR LED RIBBON LIGHTS - HIGH OUTPUT



High
OUTPUT

High
OUTPUT

High
OUTPUT

CATALOG NO.	DESCRIPTION	REEL LENGTH
HIGH OUTPUT LED RIBBON—INDOOR (16.4FT ROLLS) (Max Run 20ft)		
 ULR-IN-16F-HO-27K	4.4W/FT 310LM/FT 2700K 10mm Width	16.4FT
ULR-IN-16F-HO-30K	4.4W/FT 310LM/FT 3000K 10mm Width	16.4FT
ULR-IN-16F-HO-35K	4.4W/FT 310LM/FT 3500K 10mm Width	16.4FT
ULR-IN-16F-HO-40K	4.4W/FT 330LM/FT 4000K 10mm Width	16.4FT
ULR-IN-16F-HO-50K	4.4W/FT 350LM/FT 5000K 10mm Width	16.4FT
HIGH OUTPUT LED BLACK RIBBON—INDOOR (16.4FT ROLLS) (Max Run 20ft)		
 ULR-IN-16F-HO-27K-BK	4.4W/FT 310LM/FT 2700K 10mm Width	16.4FT
ULR-IN-16F-HO-30K-BK	4.4W/FT 310LM/FT 3000K 10mm Width	16.4FT
ULR-IN-16F-HO-35K-BK	4.4W/FT 310LM/FT 3500K 10mm Width	16.4FT
ULR-IN-16F-HO-40K-BK	4.4W/FT 330LM/FT 4000K 10mm Width	16.4FT
ULR-IN-16F-HO-50K-BK	4.4W/FT 350LM/FT 5000K 10mm Width	16.4FT
HIGH OUTPUT LED RIBBON—INDOOR (98.4FT ROLLS) (Max Run 20ft)		
 ULR-IN-98F-HO-27K	4.4W/FT 310LM/FT 2700K 10mm Width	98.4FT
ULR-IN-98F-HO-30K	4.4W/FT 310LM/FT 3000K 10mm Width	98.4FT
ULR-IN-98F-HO-35K	4.4W/FT 310LM/FT 3500K 10mm Width	98.4FT
ULR-IN-98F-HO-40K	4.4W/FT 330LM/FT 4000K 10mm Width	98.4FT
ULR-IN-98F-HO-50K	4.4W/FT 350LM/FT 5000K 10mm Width	98.4FT
INDOOR TANDEM COUPLINGS		
 ULR-IN-HO-COUP-6I-WR	Coupling to connect 2 high & Extra output ribbons, 6"	
ULR-IN-HO-COUP-3F-WR	Coupling to connect 2 high & Extra output ribbons, 3ft	
ULR-IN-HO-COUP-NO-WR	Coupling to connect 2 high & Extra output ribbons, no wire	
INDOOR POWER FEED CABLES		
 ULR-IN-HO-CONN-6I-WR	1 side ribbon connector, 1 side female socket to driver, 6"	
ULR-IN-HO-CONN-3F-WR	1 side ribbon connector, 1 side female socket to driver, 3ft	
ULR-IN-HO-CONN-3F-PT	1 side ribbon connector, 1 side open end, 3ft	
ULR-IN-HO-CONN-10F-PT	1 side ribbon connector, 1 side open end, 10ft	

Extra High
OUTPUT





Ultra High
OUTPUT

RIBBON

CATALOG NO.	DESCRIPTION	REEL LENGTH
EXTRA HIGH OUTPUT LED RIBBON—INDOOR (16.4FT ROLLS) (Max Run 11ft)		
 ULR-IN-16F-XHO-27K	8.8W/FT 620LM/FT 2700K 10mm Width	16.4FT
ULR-IN-16F-XHO-30K	8.8W/FT 620LM/FT 3000K 10mm Width	16.4FT
ULR-IN-16F-XHO-35K	8.8W/FT 620LM/FT 3500K 10mm Width	16.4FT
ULR-IN-16F-XHO-40K	8.8W/FT 680LM/FT 4000K 10mm Width	16.4FT
ULR-IN-16F-XHO-50K	8.8W/FT 700LM/FT 5000K 10mm Width	16.4FT
EXTRA HIGH OUTPUT LED RIBBON—INDOOR (98.4FT ROLLS) (Max Run 11ft)		
 ULR-IN-98F-XHO-27K	8.8W/FT 620LM/FT 2700K 10mm Width	98.4FT
ULR-IN-98F-XHO-30K	8.8W/FT 620LM/FT 3000K 10mm Width	98.4FT
ULR-IN-98F-XHO-35K	8.8W/FT 620LM/FT 3500K 10mm Width	98.4FT
ULR-IN-98F-XHO-40K	8.8W/FT 680LM/FT 4000K 10mm Width	98.4FT
ULR-IN-98F-XHO-50K	8.8W/FT 700LM/FT 5000K 10mm Width	98.4FT
ULTRA HIGH OUTPUT LED RIBBON—INDOOR (16.4FT ROLLS) (Max Run 14ft)		
 ULR-IN-16F-YHO-27K	6.7W/FT 820LM/FT 2700K 10mm Width	16.4FT
ULR-IN-16F-YHO-30K	6.7W/FT 820LM/FT 3000K 10mm Width	16.4FT
ULR-IN-16F-YHO-35K	6.7W/FT 820LM/FT 3500K 10mm Width	16.4FT
ULR-IN-16F-YHO-40K	6.7W/FT 880LM/FT 4000K 10mm Width	16.4FT
ULR-IN-16F-YHO-50K	6.7W/FT 900LM/FT 5000K 10mm Width	16.4FT
INDOOR TANDEM COUPLINGS		
 ULR-IN-HO-COUP-6I-WR	Coupling to connect 2 high & Extra output ribbons, 6"	
ULR-IN-HO-COUP-3F-WR	Coupling to connect 2 high & Extra output ribbons, 3ft	
ULR-IN-HO-COUP-NO-WR	Coupling to connect 2 high & Extra output ribbons, no wire	
INDOOR POWER FEED CABLES		
 ULR-IN-HO-CONN-6I-WR	1 side ribbon connector, 1 side female socket to driver, 6"	
ULR-IN-HO-CONN-3F-WR	1 side ribbon connector, 1 side female socket to driver, 3ft	
 ULR-IN-HO-CONN-3F-PT	1 side ribbon connector, 1 side open end, 3ft	

24-VOLT INDOOR COB RIBBON LIGHTS - HIGH OUTPUT



CATALOG NO.	DESCRIPTION	REEL LENGTH
HIGH OUTPUT COB RIBBON—INDOOR (16.4FT ROLLS) (Max Run 20ft)		
 ULR-IN-16F-HO-COB-27K	3W/FT 290LM/FT 2700K 10mm Width	16.4FT
ULR-IN-16F-HO-COB-30K	3W/FT 304LM/FT 3000K 10mm Width	16.4FT
ULR-IN-16F-HO-COB-35K	3W/FT 304LM/FT 3500K 10mm Width	16.4FT
ULR-IN-16F-HO-COB-40K	3W/FT 337LM/FT 4000K 10mm Width	16.4FT
ULR-IN-16F-HO-COB-50K	3W/FT 340LM/FT 5000K 10mm Width	16.4FT
ULR-IN-16F-HO-COB-65K	3W/FT 340LM/FT 6500K 10mm Width	16.4FT
HIGH OUTPUT COB RIBBON—INDOOR (98.4FT ROLLS) (Max Run 20ft)		
 ULR-IN-98F-HO-COB-27K	3W/FT 290LM/FT 2700K 10mm Width	98.4FT
ULR-IN-98F-HO-COB-30K	3W/FT 304LM/FT 3000K 10mm Width	98.4FT
ULR-IN-98F-HO-COB-35K	3W/FT 304LM/FT 3500K 10mm Width	98.4FT
ULR-IN-98F-HO-COB-40K	3W/FT 337LM/FT 4000K 10mm Width	98.4FT
ULR-IN-98F-HO-COB-50K	3W/FT 340LM/FT 5000K 10mm Width	98.4FT
ULR-IN-98F-HO-COB-65K	3W/FT 340LM/FT 6500K 10mm Width	98.4FT
INDOOR TANDEM COUPLINGS		
 ULR-IN-HO-COB-COUP-6I-WR	Coupling to connect 2 COB ribbons, 6"	
ULR-IN-HO-COB-COUP-3F-WR	Coupling to connect 2 COB ribbons, 3ft	
ULR-IN-HO-COB-COUP-NO-WR	Coupling to connect 2 COB ribbons, no wire	
INDOOR POWER FEED CABLES		
 ULR-IN-HO-COB-CONN-6I-WR	1 side ribbon connector, 1 side female socket to driver, 6"	
ULR-IN-HO-COB-CONN-3F-WR	1 side ribbon connector, 1 side female socket to driver, 3ft	
 ULR-IN-HO-COB-CONN-3F-PT	1 side ribbon connector, 1 side open end, 3ft	
ULR-IN-HO-COB-CONN-10F-PT	1 side ribbon connector, 1 side open end, 10ft	



24-VOLT INDOOR WHITE-TUNING COB RIBBON LIGHTS, WHITE-TUNING WITH CONTROLLER -HIGH OUTPUT

INSTALL WITH ELECTRONIC DRIVERS ONLY



CATALOG NO.	DESCRIPTION	REEL LENGTH
 ULR-IN-16F-HO-COB-WT	3W/FT 340LM/FT White Tuning 10mm Width	16.4FT
ULR-M2-M3-3A	White-Tuning Ribbon Light Controller With Remote	
ULR-LTECH-E2	White-Tuning Ribbon Light Wall-Mount Controller	
ULR-T86-JB	86X86mm PVC Junction Box For Wall-Mount Controllers	



ULR-M2-M3-3A



ULR-LTECH-E2



ULR-T86-JB

24-VOLT IP54 DAMP LOCATION LED RIBBON LIGHTS - HIGH OUTPUT



CATALOG NO.	DESCRIPTION	REEL LENGTH
 HIGH OUTPUT LED RIBBON— DAMP LOCATION (16.4FT ROLLS) (Max Run 20ft)		
ULR-IP54-16F-HO-27K	4.4W/FT 310LM/FT 2700K 10mm Width	16.4FT
ULR-IP54-16F-HO-30K	4.4W/FT 310LM/FT 3000K 10mm Width	16.4FT
ULR-IP54-16F-HO-35K	4.4W/FT 310LM/FT 3500K 10mm Width	16.4FT
ULR-IP54-16F-HO-40K	4.4W/FT 330LM/FT 4000K 10mm Width	16.4FT
ULR-IP54-16F-HO-50K	4.4W/FT 350LM/FT 5000K 10mm Width	16.4FT

INDOOR TANDEM COUPLINGS



- ULR-IP54-HO-COUP-6I-WR** Coupling to connect 2 high & Extra output ribbons, 6"
- ULR-IP54-HO-COUP-3F-WR** Coupling to connect 2 high & Extra output ribbons, 3ft
- ULR-IP54-HO-COUP-NO-WR** Coupling to connect 2 high & Extra output ribbons, no wire





INDOOR POWER FEED CABLES



- ULR-IP54-HO-CONN-6I-WR** 1 side ribbon connector, 1 side female socket to driver, 6"
- ULR-IP54-HO-CONN-3F-WR** 1 side ribbon connector, 1 side female socket to driver, 3ft
- ULR-IP54-HO-CONN-3F-PT** 1 side ribbon connector, 1 side open end, 3ft
- ULR-IP54-HO-CONN-10F-PT** 1 side ribbon connector, 1 side open end, 10ft

24-VOLT LED RGBW RIBBON LIGHTS, Max Run 16.4ft INDOOR & OUTDOOR VERSIONS INSTALL WITH ELECTRONIC DRIVERS ONLY



CATALOG NO.	DESCRIPTION	REEL LENGTH
 ULR-IN-16F-HO-RGBW	INDOOR 5.8W/FT 225LM/FT RGB 20FT. Max Run 10mm Width	16.4FT IP20
ULR-OT-16F-HO-RGBW	OUTDOOR 5.8W/FT 225LM/FT RGB 20FT. Max Run 10mm Width	16.4FT IP67
RGBW-CONTROLLER	RGBW Controller (Remote incl.), 192W Max, 12-24 VDC	
RGBW-WIFI-CONTROLLER	RGBW lighting controller with integrated WI-FI and app, RC incl.	
 ULR-IN-HO-RGBW-COUP-6I-WR	Coupling to connect 2 RGBW ribbons, 6"	
ULR-IN-HO-RGBW-COUP-3F-WR	Coupling to connect 2 RGBW ribbons, 3ft.	
ULR-IN-HO-RGBW-COUP-NO-WR	Coupling to connect 2 RGBW ribbons, no wire	
 ULR-IN-HO-RGBW-CONN-6I-WR	1 side ribbon connector, 1 side open end, 6"	
ULR-IN-HO-RGBW-CONN-3F-WR	1 side ribbon connector, 1 side open end, 3ft	
 ULR-OT-HO-RGBW-CONN-3F-WR	3ft RGBW 5C wire both side's open with 1 rubber jacket silicone, page 149)	

RGBW CONTROLLERS REQUIRES 24V ELECTRONIC DRIVER

CATALOG NO.	DESCRIPTION
RGBW-CONTROLLER	RGBW Controller (Remote incl.), 192W Max, 12-24 VDC
RGBW-WIFI-CONTROLLER	RGBW lighting controller with integrated WI-FI and app, RC incl.
ULR-LTECH-E5S	RGBW-Tuning Ribbon Light Wall-Mount Controller
ULR-M4-M4-3A	RGBW-Tuning Ribbon Light Controller With Remote
ULR-T86-JB	86X86mm PVC Junction Box For Wall-Mount Controllers



RGBW-CONTROLLER



RGBW-WIFI-CONTROLLER



ULR-LTECH-E5S



ULR-M4-M4-3A



ULR-T86-JB

24-VOLT IP67 OUTDOOR LED RIBBON LIGHTS - HIGH OUTPUT



High
OUTPUT

High
OUTPUT

RIBBON

CATALOG NO. DESCRIPTION REEL LENGTH

HIGH OUTPUT LED RIBBON—OUTDOOR (16.4FT ROLLS) (Max Run 20ft)

	ULR-OT-16F-HO-27K 4.4W/FT 310LM/FT 2700K 10mm Width	16.4FT
	ULR-OT-16F-HO-30K 4.4W/FT 310LM/FT 3000K 10mm Width	16.4FT
	ULR-OT-16F-HO-35K 4.4W/FT 310LM/FT 3500K 10mm Width	16.4FT
	ULR-OT-16F-HO-40K 4.4W/FT 330LM/FT 4000K 10mm Width	16.4FT
	ULR-OT-16F-HO-50K 4.4W/FT 350LM/FT 5000K 10mm Width	16.4FT

HIGH OUTPUT LED RIBBON—OUTDOOR (49FT ROLLS) (Max Run 20ft)

	ULR-OT-49F-HO-27K 4.4W/FT 350LM/FT 2700K 10mm Width	49FT
	ULR-OT-49F-HO-30K 4.4W/FT 310LM/FT 3000K 10mm Width	49FT
	ULR-OT-49F-HO-35K 4.4W/FT 310LM/FT 3500K 10mm Width	49FT
	ULR-OT-49F-HO-40K 4.4W/FT 330LM/FT 4000K 10mm Width	49FT
	ULR-OT-49F-HO-50K 4.4W/FT 350LM/FT 5000K 10mm Width	49FT

OUTDOOR TANDEM COUPLINGS

	ULR-OT-HO-COUP-6I-WR Coupling to connect 2 high & Extra output ribbons, 6"
	ULR-OT-HO-COUP-3F-WR Coupling to connect 2 high & Extra output ribbons, 3ft
	ULR-OT-HO-COUP-NO-WR Coupling to connect 2 high & Extra output ribbons, no wire

OUTDOOR POWER FEED CABLES

	ULR-OT-HO-CONN-6I-WR 1 side ribbon connector, 1 side female socket to driver, 6"
	ULR-OT-HO-CONN-3F-WR 1 side ribbon connector, 1 side female socket to driver, 3ft
	ULR-OT-HO-CONN-3F-PT 1 side ribbon connector, 1 side open end, 3ft
	ULR-OT-HO-CONN-10F-PT 1 side ribbon connector, 1 side open end, 10ft

24-VOLT IP67 OUTDOOR LED RIBBON LIGHTS - EXTRA HIGH OUTPUT



Extra High
OUTPUT

CATALOG NO. DESCRIPTION REEL LENGTH

EXTRA HIGH OUTPUT LED RIBBON—OUTDOOR (16.4FT ROLLS) (Max Run 16.4ft)

	ULR-OT-16F-XHO-27K 5.8W/FT 440LM/FT 2700K 10mm Width	16.4FT
	ULR-OT-16F-XHO-30K 5.8W/FT 440LM/FT 3000K 10mm Width	16.4FT
	ULR-OT-16F-XHO-35K 5.8W/FT 440LM/FT 3500K 10mm Width	16.4FT
	ULR-OT-16F-XHO-40K 5.8W/FT 450LM/FT 4000K 10mm Width	16.4FT
	ULR-OT-16F-XHO-50K 5.8W/FT 450LM/FT 5000K 10mm Width	16.4FT

EXTRA HIGH OUTPUT LED RIBBON—OUTDOOR (49FT ROLLS) (Max Run 16.4ft)

	ULR-OT-49F-XHO-27K 5.8W/FT 450LM/FT 2700K 10mm Width	49FT
	ULR-OT-49F-XHO-30K 5.8W/FT 440LM/FT 3000K 10mm Width	49FT
	ULR-OT-49F-XHO-35K 5.8W/FT 440LM/FT 3500K 10mm Width	49FT
	ULR-OT-49F-XHO-40K 5.8W/FT 450LM/FT 4000K 10mm Width	49FT
	ULR-OT-49F-XHO-50K 5.8W/FT 450LM/FT 5000K 10mm Width	49FT

OUTDOOR TANDEM COUPLINGS

	ULR-OT-HO-COUP-6I-WR Coupling to connect 2 high & Extra output ribbons, 6"
	ULR-OT-HO-COUP-3F-WR Coupling to connect 2 high & Extra output ribbons, 3ft
	ULR-OT-HO-COUP-NO-WR Coupling to connect 2 high & Extra output ribbons, no wire

OUTDOOR POWER FEED CABLES

	ULR-OT-HO-CONN-6I-WR 1 side ribbon connector, 1 side female socket to driver, 6"
	ULR-OT-HO-CONN-3F-WR 1 side ribbon connector, 1 side female socket to driver, 3ft
	ULR-OT-HO-CONN-3F-PT 1 side ribbon connector, 1 side open end, 3ft
	ULR-OT-HO-CONN-10F-PT 1 side ribbon connector, 1 side open end, 10ft

CATALOG NO.	DESCRIPTION	REEL LENGTH
HIGH OUTPUT COB RIBBON—OUTDOOR (16.4FT ROLLS) (Max Run 20ft)		
 ULR-0T-16F-HO-COB-27K	3W/FT 290LM/FT 2700K 10mm Width	16.4FT
ULR-0T-16F-HO-COB-30K	3W/FT 304LM/FT 3000K 10mm Width	16.4FT
ULR-0T-16F-HO-COB-35K	3W/FT 304LM/FT 3500K 10mm Width	16.4FT
ULR-0T-16F-HO-COB-40K	3W/FT 337LM/FT 4000K 10mm Width	16.4FT
ULR-0T-16F-HO-COB-50K	3W/FT 340LM/FT 5000K 10mm Width	16.4FT
ULR-0T-16F-HO-COB-65K	3W/FT 340LM/FT 6500K 10mm Width	16.4FT
HIGH OUTPUT COB RIBBON—OUTDOOR (98.4FT ROLLS) (Max Run 20ft)		
 ULR-0T-98F-HO-COB-27K	3W/FT 290LM/FT 2700K 10mm Width	98.4FT
ULR-0T-98F-HO-COB-30K	3W/FT 304LM/FT 3000K 10mm Width	98.4FT
ULR-0T-98F-HO-COB-35K	3W/FT 304LM/FT 3500K 10mm Width	98.4FT
ULR-0T-98F-HO-COB-40K	3W/FT 337LM/FT 4000K 10mm Width	98.4FT
ULR-0T-98F-HO-COB-50K	3W/FT 340LM/FT 5000K 10mm Width	98.4FT
ULR-0T-98F-HO-COB-65K	3W/FT 340LM/FT 6500K 10mm Width	98.4FT
INDOOR TANDEM COUPLINGS		
 ULR-0T-HO-COB-COUP-6I-WR	6In Ribbon-To-Ribbon Coupling For COB IP65 Creates IP20 Ends	
ULR-0T-HO-COB-COUP-3F-WR	3Ft Ribbon-To-Ribbon Coupling For COB IP65 Creates IP20 Ends	
INDOOR POWER FEED CABLES		
 ULR-0T-HO-COB-CONN-3F-PT	3Ft Ribbon Pigtail Snap Connector To Female End For COB IP65 Creates IP20 End	
 ULR-0T-HO-COB-CONN-10F-PT	10Ft Ribbon Pigtail Snap Connector To Female End For COB IP65 Creates IP20 End	
ULR-0T-HO-COB-CONN-6I-WR	6In Ribbon Pigtail Snap Connector To Stripped End For COB IP65 Creates IP20 End	
ULR-0T-HO-COB-CONN-3F-WR	3Ft Ribbon Pigtail Snap Connector To Stripped End For COB IP65 Creates IP20 End	
ULR-0T-HO-COB-CONN-6I-WR-IP65	COB Ribbon Wet Loc IP65 Cap With Pigtail For Solder And Silicone Bag Of 5, Creates IP65 End	
ULR-0T-HO-COB-UCLIP-5PC	COB Ribbon Wet Loc IP65 Mounting Clips And Screws Bag Of 5	
ULR-0T-HO-COB-ENDC-5PC	COB Ribbon Wet Loc IP65 Closed End Cap Bag Of 5, Use With Silicone For IP65 Results	

RIBBON

LED INDOOR ELECTRONIC RIBBON LIGHT PLUG-IN DRIVERS (FOR DIMMABLE DRIVERS SEE PAGE 167)

CATALOG NO.	DESCRIPTION
 ULR-IN-PIDR-48W	48W MAX, 2A, 100-240V INPUT, 15A Plug & Male 24V Connector
ULR-IN-PIDR-72W	72W MAX, 3A, 100-240V INPUT Plug & Male 24V Connector

LED INDOOR ELECTRONIC RIBBON LIGHT HARDWIRE DRIVERS, NON-DIMMABLE



CATALOG NO.	DESCRIPTION
 ULR-IN-HWDR-75W	75W MAX, 3.2A, 85-264V INPUT, 15A, 24V
ULR-IN-HWDR-100W	100W MAX, 4.5A, 85-264V INPUT, 15A, 24V
ULR-IN-HWDR-150W	150W MAX, 6.5A, 85-132V INPUT, 15A, 24V
ULR-IN-HWDR-200W	200W MAX, 8.8A, 90-132V INPUT, 15A, 24V
ULR-IN-HWDR-350W	350W MAX, 14.6A, 90-132V INPUT, 15A, 24V
ULR-IN-HWDR-450W	450W MAX, 18.8A, 90-132V INPUT, 15A, 24V
ULR-IN-HWDR-600W	600W MAX, 25A, 90-132V INPUT, 15A, 24V

5-IN-1 DIMMABLE ELECTRONIC LED DRIVER WITH JUNCTION BOX, 120-277V



CATALOG NO.	DESCRIPTION
LEDDR-24V-60W-UNIV	5-In-1 Dimmable Electronic Led Driver With Junction Box, 120-277V To 24V 60W
LEDDR-24V-96W-UNIV	5-In-1 Dimmable Electronic Led Driver With Junction Box, 120-277V To 24V 96W
LEDDR-24V-120W-UNIV	5-In-1 Dimmable Electronic Led Driver With Junction Box, 120-277V To 24V 120W
LEDDR-24V-150W-UNIV	5-In-1 Dimmable Electronic Led Driver With Junction Box, 120-277V To 24V 150W
LEDDR-24V-192W-UNIV	5-In-1 Dimmable Electronic Led Driver With Junction Box, 120-277V To 24V 192W
LEDDR-24V-288W-UNIV	5-In-1 Dimmable Electronic Led Driver With Junction Box, 120-277V To 24V 288W
LEDDR-24V-384W-UNIV	5-In-1 Dimmable Electronic Led Driver With Junction Box, 120-277V To 24V 384W



**ARRIVES THIS SEASON
CHECK & PRE-ORDER**

24-VOLT LED OUTDOOR ELECTRONIC **NON-DIMMABLE** DRIVERS 120V INPUT

(FOR MAG. DIMMABLE DRIVERS SEE PAGE 167)



CATALOG NO.	DESCRIPTION
LEDDR-24V-WP-200W	200W 120V INPUT



SURFACE MOUNT CHANNELS & LENSES

CATALOG NO.	DESCRIPTION
ULR-CH-SURF-SHALLOW	12X6 mm Surface mount channel, 4ft.
ULR-CH-SURF-DEEP	12X12 mm Surface mount channel, 4ft.
ULR-LENS-SURF-F	Frosted Lens for 12X6 mm & 12X12 mm Channels
ULR-LENS-SURF-C	Clear Lens for 12X6 mm & 12X12 mm Channels
ULR-CH-SURF-SHALLOW-CAP	End Cap for 12X6 mm Channels
ULR-CH-SURF-DEEP-CAP	End Cap for 12X12 mm Channels
ULR-CH-SURF-16X14	16X14 mm Surface mount channel, 4ft.
ULR-LENS-SURF-16X14-F	Frosted Lens for 16X14 mm Channels
ULR-LENS-SURF-16X14-C	Clear Lens for 16X14 mm Channels
ULR-LENS-SURF-16X14-CAP	End Cap for 16X14 mm Channels

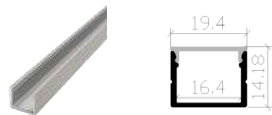
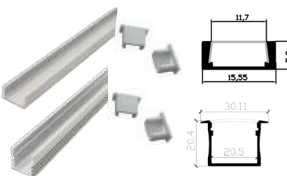

MUD-IN RECESSED MOUNT CHANNELS & LENSES

CATALOG NO.	DESCRIPTION
ULR-CH-MUD-13X15	13X15 mm Mud-In Recessed mount channel, 4ft.
ULR-LENS-MUD-13X15-F	Frosted Lens for 13X15 mm Channels
ULR-LENS-MUD-13X15-C	Clear Lens for 13X15 mm Channels
ULR-CH-MUD-13X15-CAP	End Cap for 13X15 mm Channels
ULR-CH-MUD-37X15	37X15 mm Mud-In Recessed mount channel (Can fit 2 Ribbons), 4ft.
ULR-LENS-MUD-37X15-F	Frosted Lens for 37X15 mm Channels
ULR-LENS-MUD-37X15-C	Clear Lens for 37X15 mm Channels
ULR-LENS-MUD-37X15-CAP	End Cap for 37X15 mm Channels

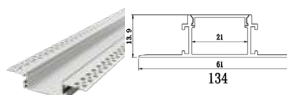
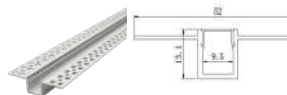

45 DEGREE CHANNEL & LENSES

CATALOG NO.	DESCRIPTION
ULR-CH-45D	12X18 mm 45° Channel, 4ft.
ULR-LENS-45D-F	Frosted Lens for 45° Channels
ULR-CH-45D-CAP	End Cap for 45° Channels



RECESSED MOUNT CHANNELS & LENSES

	CATALOG NO.	DESCRIPTION
	ULR-CH-REC-SHALLOW	20X10 mm Recessed mount channel, 4ft.
	ULR-CH-REC-DEEP	20X20 mm Recessed mount channel (Can fit 2 Ribbons), 4ft.
	ULR-LENS-REC-F	Frosted Lens for 20X10 mm & 20X20 mm Channels
	ULR-LENS-REC-C	Clear Lens for 20X10 mm & 20X20 mm Channels
	ULR-CH-REC-SHALLOW-CAP	End Cap for 20X10 mm Channels
	ULR-CH-REC-DEEP-CAP	End Cap for 20X20 mm Channels
	ULR-CH-REC-12X7	12X7 mm Recessed mount channel, 4ft.
	ULR-LENS-REC-12X7-F	Frosted Lens for 12X7 mm Channels
	ULR-LENS-REC-12X7-C	Clear Lens for 12X7 mm Channels
	ULR-CH-REC-12X7-CAP	End Cap for 12X7 mm Channels
	ULR-CH-REC-12X12	12X12 mm Recessed mount channel, 4ft.
	ULR-LENS-REC-12X12-F	Frosted Lens for 12X12 mm Channels
	ULR-LENS-REC-12X12-C	Clear Lens for 12X12 mm Channels
	ULR-CH-REC-12X12-CAP	End Cap for 12X12 mm Channels

ACCESSORIES

	CATALOG NO.	DESCRIPTION
	ULR-OUT-ENDC-5PC	End cap for IP67 ribbons, Pack of 5
	ULR-OUT-UCLIP-10PC	Mounting Clip, Pack of 10
	ULR-OUT-SGLUE	Silicone glue for sealing compound
	ULR-2HSTRP	2-hole rubber strap, Pack of 10

EXTENSION CORDS FOR SECONDARY-SIDE OF DRIVERS

	CATALOG NO.	DESCRIPTION
	ULR-DCJ-2ML-1FT	DC Jumper cable, Both sides male, 1ft.
	ULR-DCJ-2ML-3FT	DC Jumper cable, Both sides male, 3ft.
	ULR-DCJ-2ML-10FT	DC Jumper cable, Both sides male, 10ft.
	ULR-DCJ-1MIF-1FT	DC Jumper cable, one side male one side female, 1ft.
	ULR-DCJ-1MIF-3FT	DC Jumper cable, one side male one side female, 3ft.
	ULR-DCJ-1MIF-10FT	DC Jumper cable, one side male one side female, 10ft.
	ULR-DCJ-2FM-1FT	DC Jumper cable, Both sides female, 1ft.
	ULR-DCJ-2FM-3FT	DC Jumper cable, Both sides female, 3ft.
	ULR-DCJ-2FM-10FT	DC Jumper cable, Both sides female, 10ft.
	ULR-DCJ-1S1F-3FT	DC Jumper cable, one side female one side striped, 3ft
	ULR-DCJ-1S1F-10FT	DC Jumper cable, one side female one side striped, 10ft
	ULR-DCJ-1S1M-3FT	DC Jumper cable, one side male one side striped, 3ft
	ULR-DCJ-1S1M-10FT	DC Jumper cable, one side male one side striped, 10ft

WIRES

	CATALOG NO.	DESCRIPTION
	ULR-2WRE-50FT-18	50' Roll of 18/2 AWG wire
	ULR-2WRE-100FT-18	100' Roll of 18/2 AWG wire
	ULR-2WRE-50FT-22	50' Roll of 22/2 AWG wire
	ULR-2WRE-100FT-22	100' Roll of 22/2 AWG wire
	ULR-5WRE-50FT-22	50' Roll of 22/5 AWG wire
	ULR-5WRE-100FT-22	100' Roll of 22/5 AWG wire



CUSTOM LENGTHS/ORDER BY FOOT

We Cut & Solder Each Section With Your Desired Sizes

24-VOLT INDOOR LED RIBBON LIGHTS - STANDARD OUTPUT IP20

CATALOG NO.	DESCRIPTION	MAX ORDER LENGTH PER CONNECTION
STANDARD OUTPUT LED RIBBON—INDOOR		
STANDARD OUTPUT	ULR-IN-1FT-S0-27K	1.5W/FT 100LM/FT 2700K 8mm Width 49FT
	ULR-IN-1FT-S0-30K	1.5W/FT 100LM/FT 3000K 8mm Width 49FT
	ULR-IN-1FT-S0-40K	1.5W/FT 100LM/FT 4000K 8mm Width 49FT
	ULR-IN-1FT-S0-50K	1.5W/FT 100LM/FT 5000K 8mm Width 49FT

24-VOLT INDOOR LED RIBBON LIGHTS - HIGH OUTPUT IP20

CATALOG NO.	DESCRIPTION	MAX ORDER LENGTH PER CONNECTION
HIGH OUTPUT LED RIBBON—INDOOR		
HIGH OUTPUT	ULR-IN-1FT-H0-27K	4.4W/FT 310LM/FT 2700K 10mm Width 20FT
	ULR-IN-1FT-H0-30K	4.4W/FT 310LM/FT 3000K 10mm Width 20FT
	ULR-IN-1FT-H0-40K	4.4W/FT 330LM/FT 4000K 10mm Width 20FT
	ULR-IN-1FT-H0-50K	4.4W/FT 350LM/FT 5000K 10mm Width 20FT
HIGH OUTPUT LED BLACK RIBBON—INDOOR		
HIGH OUTPUT	ULR-IN-1FT-H0-27K-BK	4.4W/FT 310LM/FT 2700K 10mm Width 20FT
	ULR-IN-1FT-H0-30K-BK	4.4W/FT 310LM/FT 3000K 10mm Width 20FT
	ULR-IN-1FT-H0-40K-BK	4.4W/FT 330LM/FT 4000K 10mm Width 20FT
	ULR-IN-1FT-H0-50K-BK	4.4W/FT 350LM/FT 5000K 10mm Width 20FT

24-VOLT INDOOR LED RIBBON LIGHTS - EXTRA HIGH OUTPUT IP20

CATALOG NO.	DESCRIPTION	MAX ORDER LENGTH PER CONNECTION
EXTRA HIGH OUTPUT LED RIBBON—INDOOR		
EXTRA HIGH OUTPUT	ULR-IN-1FT-XH0-27K	8.8W/FT 620LM/FT 2700K 10mm Width 11FT
	ULR-IN-1FT-XH0-30K	8.8W/FT 620LM/FT 3000K 10mm Width 11FT
	ULR-IN-1FT-XH0-40K	8.8W/FT 680LM/FT 4000K 10mm Width 11FT
	ULR-IN-1FT-XH0-50K	8.8W/FT 700LM/FT 5000K 10mm Width 11FT
ULTRA HIGH OUTPUT LED RIBBON—INDOOR		
ULTRA HIGH OUTPUT	ULR-IN-1FT-YH0-27K	6.7W/FT 820LM/FT 2700K 10mm Width 14FT
	ULR-IN-1FT-YH0-30K	6.7W/FT 820LM/FT 3000K 10mm Width 14FT
	ULR-IN-1FT-YH0-40K	6.7W/FT 880LM/FT 4000K 10mm Width 14FT
	ULR-IN-1FT-YH0-50K	6.7W/FT 900LM/FT 5000K 10mm Width 14FT

24-VOLT INDOOR COB RIBBON LIGHTS - HIGH OUTPUT IP20

CATALOG NO.	DESCRIPTION	MAX ORDER LENGTH PER CONNECTION
EXTRA HIGH OUTPUT COB RIBBON—INDOOR		
HIGH OUTPUT	ULR-IN-1FT-H0-COB-27K	3W/FT 290LM/FT 2700K 10mm Width 20FT
	ULR-IN-1FT-H0-COB-30K	3W/FT 304LM/FT 3000K 10mm Width 20FT
	ULR-IN-1FT-H0-COB-40K	3W/FT 337LM/FT 4000K 10mm Width 20FT
	ULR-IN-1FT-H0-COB-50K	3W/FT 340LM/FT 5000K 10mm Width 20FT
	ULR-IN-1FT-H0-COB-65K	3W/FT 340LM/FT 6500K 10mm Width 20FT

24-VOLT INDOOR WHITE-TUNING COB RIBBON LIGHTS, WHITE-TUNING WITH CONTROLLER -HIGH OUTPUT INSTALL WITH ELECTRONIC DRIVERS ONLY

CATALOG NO.	DESCRIPTION	MAX ORDER LENGTH PER CONNECTION
HIGH OUTPUT	ULR-IN-1FT-H0-COB-WT	3W/FT 340LM/FT White Tuning 10mm Width 20FT
	OPT-CONNECT-WTUNE-CTRL	Connect Ribbon With White Tuning Controller and Driver



24-VOLT IP54 DAMP LOCATION LED RIBBON LIGHTS - HIGH OUTPUT IP54

CATALOG NO.	DESCRIPTION	MAX ORDER LENGTH PER CONNECTION
HIGH OUTPUT LED RIBBON— DAMP LOCATION		
HIGH OUTPUT	ULR-IP54-1FT-H0-27K	4.4W/FT 310LM/FT 2700K 10mm Width 20FT
	ULR-IP54-1FT-H0-30K	4.4W/FT 310LM/FT 3000K 10mm Width 20FT
	ULR-IP54-1FT-H0-40K	4.4W/FT 330LM/FT 4000K 10mm Width 20FT
	ULR-IP54-1FT-H0-50K	4.4W/FT 350LM/FT 5000K 10mm Width 20FT

24-VOLT LED RGBW RIBBON LIGHTS

CATALOG NO.	DESCRIPTION	MAX ORDER LENGTH PER CONNECTION
HIGH OUTPUT	ULR-IN-1FT-H0-RGBW	5.8W/FT 225LM/FT RGB 10mm Width IP20 20FT
	ULR-OT-1FT-H0-RGBW	5.8W/FT 225LM/FT RGB 10mm Width IP67 20FT
	OPT-CONNECT-RGBW-CTRL	Connect RGBW With Controller and Driver

24-VOLT IP67 OUTDOOR LED RIBBON LIGHTS - HIGH OUTPUT IP67

CATALOG NO.	DESCRIPTION	MAX ORDER LENGTH PER CONNECTION
HIGH OUTPUT LED RIBBON—OUTDOOR		
HIGH OUTPUT	ULR-OT-1FT-H0-27K	4.4W/FT 310LM/FT 2700K 10mm Width 20FT
	ULR-OT-1FT-H0-30K	4.4W/FT 310LM/FT 3000K 10mm Width 20FT
	ULR-OT-1FT-H0-40K	4.4W/FT 330LM/FT 4000K 10mm Width 20FT
	ULR-OT-1FT-H0-50K	4.4W/FT 350LM/FT 5000K 10mm Width 20FT

24-VOLT IP67 OUTDOOR LED RIBBON LIGHTS - EXTRA HIGH OUTPUT IP67

CATALOG NO.	DESCRIPTION	MAX ORDER LENGTH PER CONNECTION
EXTRA HIGH OUTPUT LED RIBBON—OUTDOOR		
EXTRA HIGH OUTPUT	ULR-OT-1FT-XH0-27K	5.8W/FT 440LM/FT 2700K 10mm Width 16.4FT
	ULR-OT-1FT-XH0-30K	5.8W/FT 440LM/FT 3000K 10mm Width 16.4FT
	ULR-OT-1FT-XH0-40K	5.8W/FT 450LM/FT 4000K 10mm Width 16.4FT
	ULR-OT-1FT-XH0-50K	5.8W/FT 450LM/FT 5000K 10mm Width 16.4FT

FACTORY-INSTALLED OPTIONS FOR ULR 1FT

CATALOG NO.	DESCRIPTION
OPT-PT-2HW-6I	Solder 6" 2 Wire Pigtail To Ribbon
OPT-PT-2HW-36I	Solder 36" 2 Wire Pigtail To Ribbon
OPT-PT-2HW-120I	Solder 120" 2 Wire Pigtail To Ribbon
OPT-PT-2HW-240I	Solder 240" 2 Wire Pigtail To Ribbon
OPTF-PTF-2W-6I	Solder 6" 2 Wire Pigtail To Ribbon With Female DC
OPTF-PTF-2W-36I	Solder 36" 2 Wire Pigtail To Ribbon With Female DC
OPTF-PTF-2W-120I	Solder 120" 2 Wire Pigtail To Ribbon With Female DC
OPTF-PTF-2W-240I	Solder 240" 2 Wire Pigtail To Ribbon With Female DC
OPT-PT-5HW-6I	Solder 6" 5 Wire Pigtail To Ribbon
OPT-PT-5HW-36I	Solder 36" 5 Wire RGBW Pigtail To Ribbon
OPT-PT-5HW-120I	Solder 120" 5 Wire RGBW Pigtail To Ribbon
OPT-PT-5HW-240I	Solder 240" 5 Wire RGBW Pigtail To Ribbon
OPT-COUP-2HW	Couple Two Ribbons No Wire
OPT-COUP-2HW-XXI	Couple Two Ribbons W. Specified Length 2 Wire
OPT-COUP-2HW-6I	Couple Two Ribbons W. 6" 2 Wire
OPT-COUP-2HW-36I	Couple Two Ribbons W. 36" 2 Wire
OPT-COUP-2HW-120I	Couple Two Ribbons W. 120" 2 Wire
OPT-COUP-2HW-240I	Couple Two Ribbons W. 240" 2 Wire
OPT-COUP-5HW-XXI	Couple Two Ribbons W. Specified Length 5 Wire
OPT-COUP-5HW-6I	Couple Two RGBW Ribbons W. 6" 5 Wire
OPT-COUP-5HW-36I	Couple Two RGBW Ribbons W. 36" 5 Wire
OPT-COUP-5HW-120I	Couple Two RGBW Ribbons W. 120" 5 Wire
OPT-COUP-5HW-240I	Couple Two RGBW Ribbons W. 240" 5 Wire

RIBBON

ALL LED
DIRECTIONAL LIGHTS
ARCHITECTURAL



Black Brass Simulation Oil-Rubbed Bronze



12V



RGBW MCT

12V 7W LED NEW GENERATION ALUMINUM SPOT LIGHT
Aluminum, Black & Metallic Oil-Rubbed Bronze & Brass Simulation Finishes

CATALOG NO.	DESCRIPTION
AD-018-MCT-BK	7W 600LM 30K/40K/50K
AD-018-MCT-ORB	7W 600LM 30K/40K/50K
AD-018-MCT-AZ	7W 600LM 30K/40K/50K
AD-018-RGBW-PB-ORB	7W 600LM RGBW PUSH BUTTON
AD-018-RGBW-W-BT-ORB	7W 600LM RGBW APP CONTROL



AD120-017



AD120-018

120V GARDEN BULLET WITHOUT OR WITH SHROUD, INTE-

CATALOG NO.	DESCRIPTION
AD120-017-MCT-ORB	8W 700LM 30K/40K/50K 17"
AD120-017-MCT-BK	8W 700LM 30K/40K/50K 17"
AD120-017-MCT-WH	8W 700LM 30K/40K/50K 17"
AD120-018-MCT-ORB	8W 700LM 30K/40K/50K 18"
AD120-018-MCT-BK	8W 700LM 30K/40K/50K 18"



12-VOLT AC/DC LED GARDEN FLOOD LIGHTS

CATALOG NO.	DESCRIPTION
GL-12V-12W-30K-BR	12W 960LM 3000K
GL-12V-12W-40K-BR	12W 960LM 4000K
GL-12V-12W-50K-BR	12W 960LM 5000K
GL-12V-24W-30K-BR	24W 1920LM 3000K
GL-12V-24W-40K-BR	24W 1920LM 4000K
GL-12V-24W-50K-BR	24W 1920LM 5000K



LFLD-5W-30K-BZ BRONZE



LFLD-5W-30K-BZB BRONZED BRASS



LD-180-BZ BRONZE

12V LED DIRECTIONAL LIGHT - SOLID BRASS

CATALOG NO.	DESCRIPTION
LFLD-5W-30K-BZB	5W 400LM 3000K Bronzed Brass
LFLD-5W-30K-BZ	5W 400LM 3000K Bronze
LD-180-BZ	6W 300LM 3000K Bronze



LFLD2-6W-30K-BZ



LFLD3-8W-30K-BZ

12V LED DIRECTIONAL LIGHT - SOLID BRASS

CATALOG NO.	DESCRIPTION
LFLD2-6W-30K-BZ	6W 280LM 3000K
LFLD3-8W-30K-BZ	8W 430LM 3000K



12V LED 35° LIGHTS



FLV12-6W



FLV12-12W FLV12-24W

Shrouds on Page 56



FLV12-32W

12V INTEGRATED LED LANDSCAPE FLOOD LIGHTS

CATALOG NO.	DESCRIPTION
FLV12-6W-30K	6W 500LM 3000K
FLV12-6W-50K	6W 550LM 5000K
FLV12-12W-30K	12W 1200LM 3000K
FLV12-12W-50K	12W 1300LM 5000K
FLV12-24W-30K	24W 2200LM 3000K
FLV12-24W-50K	24W 2500LM 5000K
FLV12-32W-30K	32W 3200LM 3000K
FLV12-32W-50K	32W 3500LM 5000K

12V (COB) INTEGRATED LED



12-VOLT AC/DC LED GARDEN LIGHT

CATALOG NO.	DESCRIPTION
LF12-6W-27K-KN	6W 400LM 2700K
LF12-6W-30K-KN	6W 400LM 3000K
LF12-6W-40K-KN	6W 450LM 4000K
LF12-6W-50K-KN	6W 450LM 5000K
LF12-6W-RGBW-KN	6W 450LM RGB + 3000K

NEEDS RGBW CONTROLLER SEE PAGE 158.



12V Wall Wash (INTEGRATED) LED FLOODLIGHTS



LF4-12V-6W LF4-12V-12W



LF4-12V-24W LF4-12V-30W

Shrouds on Page 56



LF4-12V-50W

12V INTEGRATED LED WALL WASH LIGHTS

CATALOG NO.	DESCRIPTION
LF4-12V-6W-30K	6W 440LM 3000K
LF4-12V-6W-50K	6W 500LM 5000K
LF4-12V-12W-30K	12W 1080LM 3000K
LF4-12V-12W-50K	12W 1260LM 5000K
LF4-12V-24W-30K	24W 2155LM 3000K
LF4-12V-24W-50K	24W 2500LM 5000K
LF4-12V-30W-30K	30W 2700LM 3000K
LF4-12V-30W-50K	30W 3150LM 5000K
LF4-12V-50W-30K	50W 4500LM 3000K
LF4-12V-50W-50K	50W 5250LM 5000K



LD-098-CR LD-176-CR LD-009-BZ LD-009-BZB LD-176-BZ LD-176-BZB
12V LED DIRECTIONAL LIGHTS – SOLID COPPER & SOLID BRASS

CATALOG NO.	DESCRIPTION
LD-098-CR	5W 400LM 3000K Cast Copper
LD-176-CR	5W 400LM 3000K Cast Copper
LD-009-BZ	5W 400LM 3000K Bronze
LD-009-BZB	5W 400LM 3000K Bronzed Brass
LD-176-BZ	5W 400LM 3000K Bronze
LD-176-BZB	5W 400LM 3000K Bronzed Brass



LD-006-BZ LD-103-BZB LD-103-AN LD-099-BZ LD-099-BZB LD-174-BZ LD-110-BZ
12V LED DIRECTIONAL LIGHTS

CATALOG NO.	DESCRIPTION
LD-006-BZB	5W 400LM 3000K Bronzed Brass
LD-103-BZB	5W 400LM 3000K Bronzed Brass
LD-103-AN	5W 400LM 3000K Aged Nickel
LD-099-BZ	5W 400LM 3000K Bronze
LD-099-BZB	5W 400LM 3000K Bronzed Brass
LD-174-BZ	5W 400LM 3000K Bronze
LD-110-BZ	5W 400LM 3000K Bronze



AD-102-BK AD-102-BR AD-003-BK AD-003-BR AD-003-SIL AD-131-BR
12V LED DIRECTIONAL LIGHTS – ALUMINUM

CATALOG NO.	DESCRIPTION
AD-102-BK	5W 400LM 3000K Black
AD-102-BR	5W 400LM 3000K Bronze
AD-003-BK	5W 400LM 3000K Black
AD-003-BR	5W 400LM 3000K Bronze
AD-003-SIL	5W 400LM 3000K Silver
AD-131-BR	5W 400LM 3000K Bronze



LD-192-BZ LD-192-BZB AD-192-BK AD-192-BR LD-192-FBK
12V LED DIRECTIONAL LIGHTS – SOLID BRASS, CAST

CATALOG NO.	DESCRIPTION
LD-192-BZ	5W 400LM 3000K Bronze
LD-192-BZB	5W 400LM 3000K Bronzed Brass
AD-192-BR	5W 400LM 3000K Bronze



LVW-100-MCT-ORB
5 1/4"(D) x 2 2/3"(H)



LVW-110-MCT-ORB
3 1/8"(W) x 3 2/5"(H) x 3 5/7"(D)



LVW-110-UD-MCT-ORB
3 5/7"(W) x 4 1/8"(H) x 5 1/5"(D)



LVW-115-MCT-ORB
5 1/4"(D) x 3 3/4"(H)

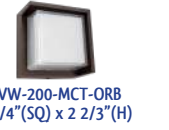

LVW-200-MCT-ORB
5 1/4"(SQ) x 2 2/3"(H)



LVW-210-MCT-ORB
3 3/4"(W) x 4 1/8"(H) x 3 2/5"(D)



LVW-210-UD-MCT-ORB
3 3/4"(W) x 4 1/8"(H) x 5 1/5"(D)

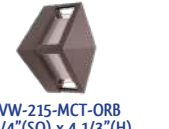

LVW-215-MCT-ORB
5 1/4"(SQ) x 4 1/3"(H)



LVW-250-MCT-ORB
5 3/4"(W) x 5 3/4"(H) x 2 1/4"(D)



LVW-300-MCT-ORB
LVW-300-MCT-WH
7"(W) x 5"(H) x 2 1/4"(D)



LVW-310-MCT-ORB
LVW-310-MCT-WH
7 1/2"(W) x 4 1/5"(H) x 2"(D)

12V SELECTABLE CCT LED MINI WALL SCONCES

CATALOG NO.	DESCRIPTION
LVW-100-MCT-ORB	3W 200LM 30K/40K/50K
LVW-110-MCT-ORB	3W 200LM 30K/40K/50K
LVW-110-UD-MCT-ORB	6W 400LM 30K/40K/50K
LVW-115-MCT-ORB	3W 200LM 30K/40K/50K
LVW-200-MCT-ORB	3W 200LM 30K/40K/50K
LVW-210-MCT-ORB	3W 200LM 30K/40K/50K
LVW-210-UD-MCT-ORB	6W 400LM 30K/40K/50K
LVW-215-MCT-ORB	3W 200LM 30K/40K/50K
LVW-250-MCT-ORB	6W 400LM 30K/40K/50K
LVW-300-MCT-ORB	6W 400LM 30K/40K/50K
LVW-300-MCT-WH	6W 400LM 30K/40K/50K
LVW-310-MCT-ORB	6W 400LM 30K/40K/50K
LVW-310-MCT-WH	6W 400LM 30K/40K/50K

12V OIL-RUBBED BRONZE & BRUSHED NICKEL FINISH



12V LED WALL CYLINDERS



CATALOG NO.	DESCRIPTION
12V 1IN LED WALL CYLINDERS, 25°	
WMC1-12V-DL-MCT-ORB	3W 300LM 30K/40K/50K
WMC1-12V-DL-MCT-BN	3W 300LM 30K/40K/50K
WMC1-12V-UDL-MCT-ORB	2X3W 600LM 30K/40K/50K
WMC1-12V-UDL-MCT-BN	2X3W 600LM 30K/40K/50K
12V 2IN LED WALL CYLINDERS, 25°	
WMC2-12V-DL-MCT-ORB	5W 500LM 30K/40K/50K
WMC2-12V-DL-MCT-BN	5W 500LM 30K/40K/50K
WMC2-12V-UDL-MCT-ORB	10W 1000LM 30K/40K/50K
WMC2-12V-UDL-MCT-BN	10W 1000LM 30K/40K/50K

AA SERIES NEW GENERATION OF PATH LIGHTS

LANDSCAPE



AA-18L-ORB

- + AA-STEM-22-MCT-ORB
- + AA-STEM-15-MCT-ORB
- + AA-STEM-22-RGBW-PB-ORB
- + AA-STEM-15-RGBW-PB-ORB
- + AA-STEM-22-RGBWW-BT-ORB
- + AA-STEM-15-RGBWW-BT-ORB



AA-18L-BK

- + AA-STEM-22-MCT-BK
- + AA-STEM-15-MCT-BK
- + AA-STEM-22-RGBW-PB-BK
- + AA-STEM-15-RGBW-PB-BK
- + AA-STEM-22-RGBWW-BT-BK
- + AA-STEM-15-RGBWW-BT-BK



AA-18L-AZ

- + AA-STEM-22-MCT-AZ
- + AA-STEM-15-MCT-AZ
- + AA-STEM-22-RGBW-PB-AZ
- + AA-STEM-15-RGBW-PB-AZ
- + AA-STEM-22-RGBWW-BT-AZ
- + AA-STEM-15-RGBWW-BT-AZ



AA-19L-ORB

- + AA-STEM-22-MCT-ORB
- + AA-STEM-15-MCT-ORB
- + AA-STEM-22-RGBW-PB-ORB
- + AA-STEM-15-RGBW-PB-ORB
- + AA-STEM-22-RGBWW-BT-ORB
- + AA-STEM-15-RGBWW-BT-ORB



AA-19L-BK

- + AA-STEM-22-MCT-BK
- + AA-STEM-15-MCT-BK
- + AA-STEM-22-RGBW-PB-BK
- + AA-STEM-15-RGBW-PB-BK
- + AA-STEM-22-RGBWW-BT-BK
- + AA-STEM-15-RGBWW-BT-BK



AA-19L-AZ

- + AA-STEM-22-MCT-AZ
- + AA-STEM-15-MCT-AZ
- + AA-STEM-22-RGBW-PB-AZ
- + AA-STEM-15-RGBW-PB-AZ
- + AA-STEM-22-RGBWW-BT-AZ
- + AA-STEM-15-RGBWW-BT-AZ



AA-20L-ORB

- + AA-STEM-22-MCT-ORB
- + AA-STEM-15-MCT-ORB
- + AA-STEM-22-RGBW-PB-ORB
- + AA-STEM-15-RGBW-PB-ORB
- + AA-STEM-22-RGBWW-BT-ORB
- + AA-STEM-15-RGBWW-BT-ORB



AA-20L-BK

- + AA-STEM-22-MCT-BK
- + AA-STEM-15-MCT-BK
- + AA-STEM-22-RGBW-PB-BK
- + AA-STEM-15-RGBW-PB-BK
- + AA-STEM-22-RGBWW-BT-BK
- + AA-STEM-15-RGBWW-BT-BK



AA-20L-AZ

- + AA-STEM-22-MCT-AZ
- + AA-STEM-15-MCT-AZ
- + AA-STEM-22-RGBW-PB-AZ
- + AA-STEM-15-RGBW-PB-AZ
- + AA-STEM-22-RGBWW-BT-AZ
- + AA-STEM-15-RGBWW-BT-AZ



AA-21L-ORB

- + AA-STEM-22-MCT-ORB
- + AA-STEM-15-MCT-ORB
- + AA-STEM-22-RGBW-PB-ORB
- + AA-STEM-15-RGBW-PB-ORB
- + AA-STEM-22-RGBWW-BT-ORB
- + AA-STEM-15-RGBWW-BT-ORB



AA-21L-BK

- + AA-STEM-22-MCT-BK
- + AA-STEM-15-MCT-BK
- + AA-STEM-22-RGBW-PB-BK
- + AA-STEM-15-RGBW-PB-BK
- + AA-STEM-22-RGBWW-BT-BK
- + AA-STEM-15-RGBWW-BT-BK



AA-21L-AZ

- + AA-STEM-22-MCT-AZ
- + AA-STEM-15-MCT-AZ
- + AA-STEM-22-RGBW-PB-AZ
- + AA-STEM-15-RGBW-PB-AZ
- + AA-STEM-22-RGBWW-BT-AZ
- + AA-STEM-15-RGBWW-BT-AZ



AA-22L-ORB

- + AA-STEM-22-MCT-ORB
- + AA-STEM-15-MCT-ORB
- + AA-STEM-22-RGBW-PB-ORB
- + AA-STEM-15-RGBW-PB-ORB
- + AA-STEM-22-RGBWW-BT-ORB
- + AA-STEM-15-RGBWW-BT-ORB



AA-22L-BK

- + AA-STEM-22-MCT-BK
- + AA-STEM-15-MCT-BK
- + AA-STEM-22-RGBW-PB-BK
- + AA-STEM-15-RGBW-PB-BK
- + AA-STEM-22-RGBWW-BT-BK
- + AA-STEM-15-RGBWW-BT-BK



AA-22L-AZ

- + AA-STEM-22-MCT-AZ
- + AA-STEM-15-MCT-AZ
- + AA-STEM-22-RGBW-PB-AZ
- + AA-STEM-15-RGBW-PB-AZ
- + AA-STEM-22-RGBWW-BT-AZ
- + AA-STEM-15-RGBWW-BT-AZ



AA-23L-ORB

- + AA-STEM-22-MCT-ORB
- + AA-STEM-15-MCT-ORB
- + AA-STEM-22-RGBW-PB-ORB
- + AA-STEM-15-RGBW-PB-ORB
- + AA-STEM-22-RGBWW-BT-ORB
- + AA-STEM-15-RGBWW-BT-ORB



AA-23L-BK

- + AA-STEM-22-MCT-BK
- + AA-STEM-15-MCT-BK
- + AA-STEM-22-RGBW-PB-BK
- + AA-STEM-15-RGBW-PB-BK
- + AA-STEM-22-RGBWW-BT-BK
- + AA-STEM-15-RGBWW-BT-BK



AA-23L-AZ

- + AA-STEM-22-MCT-AZ
- + AA-STEM-15-MCT-AZ
- + AA-STEM-22-RGBW-PB-AZ
- + AA-STEM-15-RGBW-PB-AZ
- + AA-STEM-22-RGBWW-BT-AZ
- + AA-STEM-15-RGBWW-BT-AZ

LED PATH LIGHTS

CATALOG NO.	DESCRIPTION
3CCT LED PATH LIGHTS	
AA-STEM-22-MCT-ORB	5W 200LM 30K/40K/50K 22" Oil-Rubbed Bronze
AA-STEM-22-MCT-BK	5W 200LM 30K/40K/50K 22" Black
AA-STEM-22-MCT-AZ	5W 200LM 30K/40K/50K 22" Antique Brass
AA-STEM-15-MCT-ORB	5W 200LM 30K/40K/50K 15" Oil-Rubbed Bronze
AA-STEM-15-MCT-BK	5W 200LM 30K/40K/50K 15" Black
AA-STEM-15-MCT-AZ	5W 200LM 30K/40K/50K 15" Antique Brass
PUSH BUTTON RGBW LED PATH LIGHTS	
AA-STEM-22-RGBW-PB-ORB	5W 200LM RGBW 22" Oil-Rubbed Bronze
AA-STEM-22-RGBW-PB-BK	5W 200LM RGBW 22" Black
AA-STEM-22-RGBW-PB-AZ	5W 200LM RGBW 22" Antique Brass
AA-STEM-15-RGBW-PB-ORB	5W 200LM RGBW 15" Oil-Rubbed Bronze
AA-STEM-15-RGBW-PB-BK	5W 200LM RGBW 15" Black
AA-STEM-15-RGBW-PB-AZ	5W 200LM RGBW 15" Antique Brass
RGBW/W BLUETOOTH WG APP LED PATH LIGHTS	
AA-STEM-22-RGBW-W-BT-ORB	5W 200LM RGBW 22" Oil-Rubbed Bronze
AA-STEM-22-RGBW-W-BT-BK	5W 200LM RGBW 22" Black
AA-STEM-22-RGBW-W-BT-AZ	5W 200LM RGBW 22" Antique Brass
AA-STEM-15-RGBW-W-BT-ORB	5W 200LM RGBW 15" Oil-Rubbed Bronze
AA-STEM-15-RGBW-W-BT-BK	5W 200LM RGBW 15" Black
AA-STEM-15-RGBW-W-BT-AZ	5W 200LM RGBW 15" Antique Brass

ALUMINUM PATH LIGHT CAP

CATALOG NO.	DESCRIPTION
AA-18L-ORB	Model 18 Aluminum Path Light Cap, Oil-Rubbed Bronze
AA-18L-BK	Model 18 Aluminum Path Light Cap, Black
AA-18L-AZ	Model 18 Aluminum Path Light Cap, Antique Bras
AA-19L-ORB	Model 19 Aluminum Path Light Cap, Oil-Rubbed Bronze
AA-19L-BK	Model 19 Aluminum Path Light Cap, Black
AA-19L-AZ	Model 19 Aluminum Path Light Cap, Antique Bras
AA-20L-ORB	Model 20 Aluminum Path Light Cap, Oil-Rubbed Bronze
AA-20L-BK	Model 20 Aluminum Path Light Cap, Black
AA-20L-AZ	Model 20 Aluminum Path Light Cap, Antique Bras
AA-21L-ORB	Model 21 Aluminum Path Light Cap, Oil-Rubbed Bronze
AA-21L-BK	Model 21 Aluminum Path Light Cap, Black
AA-21L-AZ	Model 21 Aluminum Path Light Cap, Antique Bras
AA-22L-ORB	Model 22 Aluminum Path Light Cap, Oil-Rubbed Bronze
AA-22L-BK	Model 22 Aluminum Path Light Cap, Black
AA-22L-AZ	Model 22 Aluminum Path Light Cap, Antique Bras
AA-23L-ORB	Model 23 Aluminum Path Light Cap, Oil-Rubbed Bronze
AA-23L-BK	Model 23 Aluminum Path Light Cap, Black
AA-23L-AZ	Model 23 Aluminum Path Light Cap, Antique Bras

**NEW GENERATION OF INTEGRATED LED PATH LIGHTS, ALUM. ALLOY
 SELECTABLE COLOR TEMPERATURE OR PUSH-BUTTON RGBW WITH SCENES, APP-CONTROLLED RGBW
 IN 3 FINISHES, SIMULATED DARK BRASS, BLACK, METALLIC OIL-RUBBED BRONZE
 2 DIFFERENT HEIGHTS: 15" OR 22"
 STEMS AND CAPS SOLD SEPARATELY**

LANDSCAPE

23"
12V AREA LIGHTS
SOLID BRASS
TOTAL LENGTH: 23"
BUILT-IN INTEGRATED LED



12V LED AREA LIGHTS - SOLID BRASS

CATALOG NO.	DESCRIPTION
LA-112-BZ	3W 200LM 3000K
LA-115-BZ	3W 200LM 3000K
LA-117-BZ	3W 200LM 3000K
LA-116-BZ	3W 200LM 3000K
LA-120-BZ	3W 200LM 3000K

12V AREA LIGHTS
SOLID BRASS

BUILT-IN INTEGRATED LED



12V LED AREA LIGHTS - SOLID BRASS

CATALOG NO.	DESCRIPTION
LA-118-BZ	3W 200LM 3000K
LA-111-BZ	3W 200LM 3000K
LA-008-BZ	3W 200LM 3000K
LA-010-BZ	3W 200LM 3000K
LA-002-BZ	3W 200LM 3000K

12"
12V AREA LIGHTS
SOLID BRASS
TOTAL LENGTH: 12"
BUILT-IN INTEGRATED LED



12V LED AREA LIGHTS

CATALOG NO.	DESCRIPTION
LA-112-BZ-12IN	3W 200LM 3000K
LA-115-BZ-12IN	3W 200LM 3000K
LA-117-BZ-12IN	3W 200LM 3000K
LA-116-BZ-12IN	3W 200LM 3000K
LA-118-BZ-12IN	3W 200LM 3000K
LA-111-BZ-12IN	3W 200LM 3000K
LA-111-CR-12IN	3W 200LM 3000K
LA-116-CR-12IN	3W 200LM 3000K
LA-117-CR-12IN	3W 200LM 3000K

12V AGED NICKEL COLLECTION
Cast Brass, Aged Nickel Finish
TOTAL LENGTH: 23"
BUILT-IN INTEGRATED LED



AGED NICKEL COLLECTION

CATALOG NO.	DESCRIPTION
LA-112-AN	3W 200LM 3000K
LA-117-AN	3W 200LM 3000K
LA-116-AN	3W 200LM 3000K
LA-111-AN	3W 200LM 3000K

12V AREA LIGHTS
SOLID COPPER
TOTAL LENGTH: 23"
BUILT-IN INTEGRATED LED

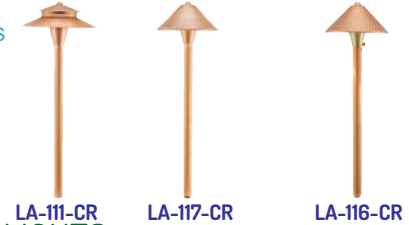

12V LED AREA LIGHTS - SOLID COPPER

CATALOG NO.	DESCRIPTION
LA-111-CR	3W 200LM 3000K
LA-116-CR	3W 200LM 3000K
LA-117-CR	3W 200LM 3000K

12V AREA LIGHTS
SOLID COPPER



12V LED AREA LIGHTS - SOLID COPPER

CATALOG NO.	DESCRIPTION
LA-010-CR	3W 200LM 3000K
LA-112-CR	3W 200LM 3000K
LA-118-CR	3W 200LM 3000K

12V PAGODA LIGHTS
BLACK OR BRONZE



12V LED PAGODA LIGHTS

CATALOG NO.	DESCRIPTION
AA-146-BK	3W 200LM 3000K
AA-146-BR	3W 200LM 3000K

12V AREA LIGHTS For 120V installations, add a mini transformer inside the LAL fixtures. see page 160

POWDER-COATED
BRONZE OR BLACK



12V LED AREA LIGHTS—GROUND OR SURFACE MOUNT Custom Design Aluminum Spike & Surface Mounting Base Inc.



CATALOG NO.	DESCRIPTION
LAL-12V-117-31-30K-BR	10W 720LM 3000K 31"
LAL-12V-117-31-30K-BK	10W 720LM 3000K 31"
LAL-12V-118-31-30K-BR	10W 720LM 3000K 31"
LAL-12V-118-31-30K-BK	10W 720LM 3000K 31"
LAL-12V-120-23-30K-BR	10W 720LM 3000K 23"
LAL-12V-120-23-30K-BK	10W 720LM 3000K 23"
LAL-12V-122-31-30K-BR	10W 720LM 3000K 31"
LAL-12V-122-31-30K-BK	10W 720LM 3000K 31"
LAL-12V-124-15-30K-BR	10W 720LM 3000K 15"
LAL-12V-124-15-30K-BK	10W 720LM 3000K 15"
LAL-12V-124-31-30K-BR	10W 720LM 3000K 31"
LAL-12V-124-31-30K-BK	10W 720LM 3000K 31"
LAL-12V-127-23-30K-BR	10W 720LM 3000K 23"
LAL-12V-127-23-30K-BK	10W 720LM 3000K 23"
LAL-12V-128-31-30K-BR	10W 720LM 3000K 31"
LAL-12V-128-31-30K-BK	10W 720LM 3000K 31"
LAL-12V-130-31-30K-BR	10W 720LM 3000K 31"
LAL-12V-130-31-30K-BK	10W 720LM 3000K 31"

12V PATH LIGHTS

POWDER-COATED
BRONZE OR BLACK OR SILVER
TOTAL LENGTH: 23"



12V LED PATH LIGHTS

CATALOG NO.	DESCRIPTION
LAL-136-MCT-ORB	5W 300LM 30K/40K/50K
LAL-136-MCT-BK	5W 300LM 30K/40K/50K
LAL-136-RGBWW-BT-ORB	5W 200LM RGBW
LAL-136-RGBWW-BT-BK	5W 200LM RGBW
LAL-136-RGBWW-PB-ORB	5W 200LM RGBWW
LAL-131-30K-ORB	5W 200LM 3000K
LAL-131-30K-BK	5W 200LM 3000K
LAL-126-BR	3W 200LM 3000K
LAL-126-BK	3W 200LM 3000K
LAL-126-SIL	3W 200LM 3000K



12V INTEGRATED LED LANDSCAPE UPLIGHTS

CATALOG NO.	DESCRIPTION
LFLV-7W-27K	7W 500LM 2700K
LFLV-7W-30K	7W 500LM 3000K
LFLV-7W-40K	7W 550LM 4000K
LFLV-7W-50K	7W 550LM 5000K
LFLV-12W-27K	12W 800LM 2700K
LFLV-12W-30K	12W 800LM 3000K
LFLV-12W-40K	12W 900LM 4000K
LFLV-12W-50K	12W 900LM 5000K

12V
ALUMINUM



AS-158-BK
AS-158-BR
AS-158-30K-ORB

STEP LIGHTS WITH LED LAMPS- ALUMINUM

CATALOG NO.	DESCRIPTION
AS-158-BR	3W 200LM 3000K
AS-158-BK	3W 200LM 3000K
AS-158-30K-ORB	2.5W 80LM 3000K

LED 3W, 30K JC
ARCHITECTURAL
SOLID BRASS



LS-185-BZ LS-158-BZ LS-159-BZ

STEP LIGHTS WITH LED LAMPS

CATALOG NO.	DESCRIPTION
LS-185-BZ	3W 200LM 3000K
LS-158-BZ	3W 200LM 3000K
LS-158-SS	3W 200LM 3000K
LS-159-BZ	3W 200LM 3000K

12V STEP LIGHTS WITH INTEGRATED SMD LED MODULE



LS-124-AN LS-155-BZ LS-160-BZ LS-160-AN LS-172-BZ (NO HOUSING)

LED STEP LIGHTS

CATALOG NO.	DESCRIPTION
LS-124-AN	3W 200LM 3000K
LS-160-BZ	3W 200LM 3000K
LS-160-AN	3W 200LM 3000K
LS-155-BZ	3W 200LM 3000K
LS-172-BZ-LEDI	3W 200LM 3000K



12V INTEGRATED LED (IN GROUND) LIGHTS

DESCRIPTION	DESCRIPTION
IGL-1W-30K	1W 100LM 3000K
IGL-1W-40K	1W 100LM 4000K
IGL-1W-TWLN	1W in ground light lock nut for thin wall
IGL-3W-30K	3W 290LM 3000K
IGL-3W-40K	3W 290LM 4000K
IGL-3W-RGBW	3W 290LM RGB+3000K <small>NEEDS CONTROLLER</small>
IGL-7W-30K	7W 620LM 3000K
IGL-7W-40K	7W 620LM 4000K
IGL-10W-RGBW	10W 620LM RGB+3000K <small>NEEDS CONTROLLER</small>
RGBW-CONTROLLER	RGBW Controller (Remote incl.), 192W Max, 12-24 VDC
RGBW-WIFI-CONTROLLER	RGBW lighting controller with integrated WI-FI and app, RC incl.



OPTIONAL TRIMS FOR 1W IN-GROUND FIXTURES

CATALOG NO.	DESCRIPTION
IGL-1W-TRM-AL-RBK	1.8" DIAMETER
IGL-1W-TRM-AL-RWH	1.8" DIAMETER
IGL-1W-TRM-AL-RBN	1.8" DIAMETER
IGL-1W-TRM-AL-RLBN	2.75" DIAMETER
IGL-1W-TRM-AL-SCP	1.8" DIAMETER
IGL-1W-TRM-SS-1WY	1.8" DIAMETER
IGL-1W-TRM-SS-2WY	1.8" DIAMETER
IGL-1W-TRM-SS-SQR	1.8" DIAMETER
IGL-1W-TRM-SS-SQSQ	1.8" DIAMETER
IGL-1W-TRM-AL-RAZ	1.8" DIAMETER
IGL-1W-TRM-AL-SCP-AZ	1.8" DIAMETER



OPTIONAL TRIMS FOR 3W IN-GROUND FIXTURES

CATALOG NO.	DESCRIPTION
IGL-3W-TRM-SS-1WY	2.3" DIAMETER
IGL-3W-TRM-SS-2WY	2.3" DIAMETER
IGL-3W-TRM-SS-SQR	2.3" DIAMETER
IGL-3W-TRM-SS-SQSQ	2.3" DIAMETER
IGL-3W-TRM-SS-R	2.3" DIAMETER
IGL-3W-TRM-AL-RBN	2.75" DIAMETER
IGL-3W-TRM-SS-SCP	2.3" DIAMETER
IGL-3W-TRM-SS-SCP-AZ	2.3" DIAMETER, BRONZE
IGL-3W-TRM-AL-AZ	2.3" DIAMETER

PVC SLEEVES
BRUSHED NICKEL FINISH



IGLA-3W-30K-BN



IGLA-7W-30K-BN

12V ALUM. INTEGRATED LED INGROUND LIGHTS

CATALOG NO.	DESCRIPTION
IGLA-3W-30K-BN	3W 320LM 3000K
IGLA-7W-30K-BN	7W 720LM 3000K

12V HARDSCAPE AREA LIGHTS 8 FT Cable



HSL-3-30K



HSL-7-30K
HSL-7-MCT
HSL-7-RGBCW



HSL-13-30K
HSL-12MCT
HSL-12-RGBCW

LED HARDSCAPE LIGHTS WITH FRONT TRIM

CATALOG NO.	DESCRIPTION
HSL-3-30K	1W 30LM 3000K
HSL-7-30K	2W 100LM 3000K
HSL-13-30K	3W 160LM 3000K
HSL-7-MCT	5W 200LM 30K/40K/50K
HSL-12-MCT	7W 280LM 30K/40K/50K
HSL-7-RGBCW	5W 200LM RGBCW
HSL-12-RGBCW	7W 280LM RGBCW



WL-140-FBK
FIBER GLASS
FOR PAR36
No Lamp



LD-001-BZ
CAST BRASS
FOR PAR36
No Lamp

CATALOG NO.	DESCRIPTION
WL-140-FBK	Fiber Glass, Black
LD-001-BZ	Die-cast Brass, Antique Bronze Finish

UNDERWATER LIGHTS

INCL. 5W 30K MR16 LED



UW-125-SS



UW-125-BS



UW-126-BZ

LED UNDERWATER LIGHTS 30FT CABLE

CATALOG NO.	DESCRIPTION
UW-125-SS	5W 400LM 3000K
UW-125-BS	5W 400LM 3000K
UW-126-BZ	5W 400LM 3000K

4" DIA. & PVC SLEEVES



WLL-105-30K-BK
WLL-105-RGBWW-BT-ORB



WLL-106-30K-BK



WLL-152-30K-BK
WLL-152-30K-ORB



WLL-157-30K-BK
WLL-157-RGBWW-BT-ORB



WLL-159-30K-BK



WLL-181-30K-BK
WLL-181-RGBWW-BT-ORB

INTEGRATED ALUMINUM LED WELL/PATH LIGHTS

CATALOG NO.	DESCRIPTION
WLL-105-30K-BK	6W 580LM 3000K
WLL-105-RGBWW-BT-ORB	6W 580LM RGBW
WLL-106-30K-BK	6W 500LM 3000K
WLL-152-30K-BK	6W 200LM 3000K
WLL-152-30K-ORB	6W 200LM 3000K Oil-Rubbed Bronze
WLL-157-30K-BK	6W 500LM 3000K
WLL-157-RGBWW-BT-ORB	6W 180LM RGBW
WLL-159-30K-BK	6W 400LM 3000K
WLL-181-30K-BK	6W 580LM 3000K
WLL-181-RGBWW-BT-ORB	6W 420LM RGBW

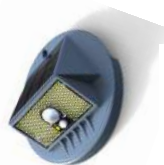

SOLR-SL1-60K-SEN
14/5"(H) X 4 2/5"(W)



SOLRW-30K
4 1/7"(H) X 3 5/6"(W)



SOLR-WL2-MCT-SEN
4 1/2"(H) X 12"(W) X 2 1/2"(D)



SOLR-WL1-30K-SEN-BK
5"(H) X 6 1/3"(W) X 2 3/7"(D)



SOLR-PL1-30K
20 8/9"(H) X 4 2/7"(W) X 4 1/2"(D)

SPEC SERIES SOLAR LIGHT COLLECTION



CATALOG NO.	DESCRIPTION
SOLRW-30K	0.2W 50LM 3000K
SOLR-SL1-60K-SEN	0.5W+0.2W 100LM 6000K/3000K
SOLR-WL1-30K-SEN-BK	5W 500LM 3000K
SOLR-WL2-MCT-SEN	8W 1000LM 3000K/6000K
SOLR-PL1-30K	3W 300LM 3000K

12V WELL LIGHTS MR16 LED INCL. 5W 30K



WL-105-1-BK WL-105-BK WL-181-BK WL-181-BZ WL-157-FGBZ

WELL LIGHTS WITH SLEEVE & LED LAMPS

CATALOG NO.	DESCRIPTION
WL-105-1-BK	5W 400LM 3000K
WL-105-BK	5W 400LM 3000K
WL-181-BK	5W 400LM 3000K
WL-181-BZ	5W 400LM 3000K
WL-181-BR	5W 400LM 3000K
WL-157-FGBZ	5W 400LM 3000K

12V WELL LIGHTS MR16 LED INCL. 5W 30K



WL-137-BK WL-137-BZ Solid Brass WL-138-BK WL-138-BZ Solid Brass WL-138-SS

WELL LIGHTS WITH SLEEVE & LED LAMPS

CATALOG NO.	DESCRIPTION
WL-137-BK	5W 400LM 3000K
WL-137-BZ	5W 400LM 3000K
WL-138-BK	5W 400LM 3000K
WL-138-BZ	5W 400LM 3000K
WL-138-SS	5W 400LM 3000K

12V WELL LIGHTS MR16 LED WITH DIRECTIONAL LAMP BRACKET INCL. 5W 30K, 400LM



WL-701-FGBZ WL-705-FGBZ WL-707-FGBZ WL-708-FGBZ

SOLID BRASS WELL LIGHTS WITH DIRECTIONAL LAMP BRACKET

CATALOG NO.	DESCRIPTION
WL-701-FGBZ	5W 400LM 3000K
WL-705-FGBZ	5W 400LM 3000K
WL-707-FGBZ	5W 400LM 3000K
WL-708-FGBZ	5W 400LM 3000K

DUAL-TAP WITH TIMER & PHOTOCELL SLIDE DOOR WET LISTED ETL



TR-40W-DT-TPC-SS TR-75W-DT-TPC-SS TR-100W-DT-TPC-SS TR-200W-DT-TPC-SS

DUAL-TAP (12V/15V AC) LANDSCAPE TRANSFORMERS WITH TIMER & PHOTOCELL SLIDE

CATALOG NO.	DESCRIPTION
TR-40W-DT-TPC-SS	40W
TR-75W-DT-TPC-SS	75W
TR-100W-DT-TPC-SS	100W
TR-200W-DT-TPC-SS	200W

PROFESSIONAL SERIES TRANSFORMERS WET LISTED ETL MULTI-TAP WITH TIMER & PHOTOCELL READY STAINLESS STEEL SPEC SERIES



TR-150W-MT-SS TR-300W-MT-SS TR-600W-MT-SS TR-900W-MT-SS

MULTI-TAP (12V/13V/14V/15V AC) LANDSCAPE TRANSFORMERS
TIMER & PHOTOCELL READY (NOT INCLUDED)
HINGE DOOR

CATALOG NO.	DESCRIPTION
TR-150W-MT-SS	150W
TR-300W-MT-SS	300W
TR-600W-MT-SS	600W
TR-900W-MT-SS	900W



TR-MTMR TR-DTMR TR-PC

MULTI-TAP LANDSCAPE TRANSFORMERS PLUG-IN OPTIONS

CATALOG NO.	DESCRIPTION
TR-MTMR	MECHANICAL TIMER
TR-DTMR	DIGITAL TIMER
TR-PC	PHOTOCELL



LVT-60 LVT-100

DRY LOCATION AC TRANSFORMERS, 12V

CATALOG NO.	DESCRIPTION
LVT-60	60W
LVT-100	100W



MR16

CATALOG NO.	DESCRIPTION
MR16-400L-27K-D	5W 380LM 2700K
MR16-400L-30K-D	5W 380LM 3000K
MR16-400L-41K-D	5W 390LM 4100K
MR16-400L-50K-D	5W 400LM 5000K
MR16-500L-C90-30K-D	7W 500LM 3000K
MR16-500L-C90-40K-D	7W 560LM 4000K
MR16-500L-C90-50K-D	7W 560LM 5000K



PVC POST

CATALOG NO.	DESCRIPTION
WE167	Extra-long 18-1/2" PVC mounting post for ground mounted landscape fixtures
WE167-25	Extra-long 25" PVC mounting post for ground mounted landscape fixtures
WE167-CAP	Cap only for WE167
WE167-CAP-BZ	Brass with bronze finish Cap only for WE167



TREE BASE

CATALOG NO.	DESCRIPTION
A-41-S	Tree mounting base
LG-SMB-BZ	12V brass landscape tree or surface bracket, antique bronze finish



BUNGEE CORDS

CATALOG NO.	DESCRIPTION
BC-10	10" Bungee cords with hooks
BC-15	15" Bungee cords with hooks
BC-18	18" Bungee cords with hooks
BC-21	21" Bungee cords with hooks
BC-32	32" Bungee cords with hooks



PATH LIGHTING ACCESSORIES

CATALOG NO.	DESCRIPTION
LA-T-BZ	Fixture mounting "T" Attachment
LA-90-BZ	Fixture mounting 90° elbow Attachment
LA-FMS21-BZ	21" Solid brass fixture mounting stem Antique bronze finish

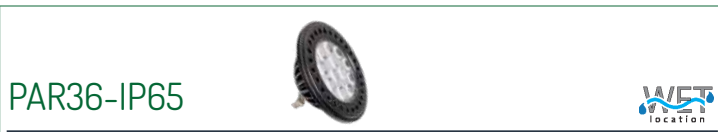

PAR36-IP65

CATALOG NO.	DESCRIPTION
PAR36-12W-30K	12W 1000LM 3000K
PAR36-12W-40K	12W 1000LM 4000K
PAR36-12W-50K	12W 1000LM 5000K



12V AC/DC REPLACEMENT LAMPS

CATALOG NO.	DESCRIPTION
GZ-JC-39L-27K	3W 250LM 2700K
GZ-JC-39L-30K	3W 250LM 3000K
GZ-JC-18L-27K	3W 250LM 2700K
GZ-JC-18L-32K	3W 250LM 3200K
GZ-JC-WP-3W-32K	3W 180LM 3200K
GZ-S8-32K-G2	2.2W 230LM 3200K
GZ-S8-32K	1.4W 70LM 3200K
GZ-G4-9L-32K	2W 120LM 3200K
GZ-JC-60L-TFL	3W 60LM TURTLE FRIENDLY CCT
GZ-JC-300L-27K	3W 300LM 2700K
GZ-JC-300L-30K	3W 300LM 3000K



BRASS BASE

CATALOG NO.	DESCRIPTION
B-41	1/2" NPT hub, Solid Brass, Antique Bronze finish
B-41-AN	1/2" NPT hub, Solid Brass, Aged Nickel finish



ALUMINUM BASE

CATALOG NO.	DESCRIPTION
A-41-BR	1/2" NPT hub, Cast aluminum, Bronze Powder coat finish
A-41-BK	1/2" NPT hub, Cast aluminum, Black Powder coat finish

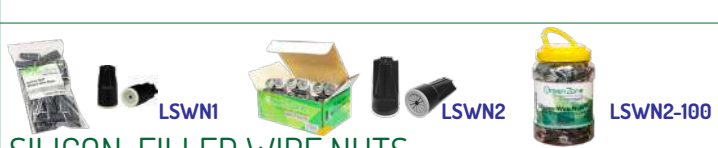

SILICON-FILLED WIRE NUTS

CATALOG NO.	DESCRIPTION
LSWN1	Bag of 24, Waterproof wire connectors, for up to two 14-2 + one 16-2 cables
LSWN2	Box of 24, Waterproof wire connectors, for up to three 12-2 cables
LSWN2-100	Jar of 100, Waterproof wire connectors, for up to three 12-2 cables

LANDSCAPE



WL-SLEEVE



SPIKE-BG



SPIKE-10

SPIKES

CATALOG NO.	DESCRIPTION
WL-SLEEVE	PVC sleeve Kit for 4" well lights
SPIKE-BG	8.5" PVC spike
SPIKE-10	10" PVC spike



LA-STEM-REPL-LED



LA-STEM-RL



LA-STEM-KNOB

AREA LIGHTING REPLACEMENT PARTS

CATALOG NO.	DESCRIPTION
LA-STEM-RL	Replacement Glass Lens for Path Light stem
LA-STEM-KNOB	Replacement Knob
LA-STEM-REPL-LED	3000K Replacement LED Tower for path lights Also fits Pagoda Lights
LA-STEM-REPL-LED-27K	2700K Replacement LED Tower for path lights Also fits Pagoda Lights
LA-STEM-REPL-LED-40K	4000K Replacement LED Tower for path lights Also fits Pagoda Lights
LA-STEM-REPL-LED-50K	5000K Replacement LED Tower for path lights Also fits Pagoda Lights



PAGODA LIGHTS REPLACEMENT GLASS

CATALOG NO.	DESCRIPTION
AA-145-RG	Replacement Glass for 2-Tier pagodas
AA-146-RG	Replacement Glass for 3-Tier pagodas
AA-147-RG	Replacement Glass for 4-Tier pagodas



WE-CONN

12V SNAP CONNECTOR



LSFLC-20

CATALOG NO.	DESCRIPTION
WE-CONN	black color
LSFLC-20	20 Fast-Lock In-Line Landscape Connectors



LOW-VOLTAGE CABLE

CATALOG NO.	DESCRIPTION	STD. PKG.
LOV-14	#14 AWG (41 Strands)	500
LOV-12	#12 AWG (65 Strands)	FT. per
LOV-10	#10 AWG (104 Strands)	Reel/
LOV-8	#8 AWG (168 Strands)	Box



LOW-VOLTAGE CABLE

CATALOG NO.	DESCRIPTION	STD. PKG.
LOV-14-100FT	#14 AWG (41 Strands)	100
LOV-12-100FT	#12 AWG (65 Strands)	FT. per
LOV-10-100FT	#10 AWG (104 Strands)	Reel/
LOV-8-100FT	#8 AWG (168 Strands)	Box



STEP LIGHTING REPLACEMENT LED MODULE

CATALOG NO.	DESCRIPTION
LS-REPL-LED	3000K Replacement LED Module
LS-REPL-LED-27K	2700K Replacement LED Module



LANDSCAPE-DISPLAY



LANDSCAPE-DISPLAY2-UBR



LANDSCAPE-DISPLAY2-UBK

LANDSCAPE DISPLAY

CATALOG NO.	DESCRIPTION
LANDSCAPE-DISPLAY	Display for Landscape
LANDSCAPE-DISPLAY2-UBK	Display for Landscape
LANDSCAPE-DISPLAY2-UBR	Display for Landscape

BOLLARD CUSTOMIZATION

CATALOG NO.	POST SIZE		FIXTURES PER POLE		COLOR TEMPERATURE		FINISH DESCRIPTION	
	CODE	DESCRIPTION	CODE	DESCRIPTION	CODE	DESCRIPTION	CODE	DESCRIPTION
WMS-S	18	18 Inch	1	1 Sided	30K	3000K	BR	Bronze
WMS-R	36	36 Inch	2	2 Sided	40K	4000K	WH	White
LMW					50K	5000K		

For more information on each fixture model, refer to: LWA-12 page 4, LMW page 10, WMS page 10.



Mounting Options Shown with LMW series



Mounting Options Shown with LWA-12W



Mounting Options Shown with WMS series



SLE-A-120V-MCT-WH
SLE-A-12V-MCT-WH
White



SLE-A-120V-MCT-ORB
SLE-A-12V-MCT-ORB
Oil-Rubbed Bronze



SLE-A-120V-MCT-BN
SLE-A-12V-MCT-BN
Brushed Nickel



SLE-A-120V-MCT-PIR-WH
SLE-A-12V-MCT-PIR-WH
White



SLE-A-120V-MCT-PIR-ORB
SLE-A-12V-MCT-PIR-ORB
SLE-A-120V-RGBWW-PB-ORB
SLE-A-12V-RGBWW-PB-ORB
Oil-Rubbed Bronze



SLE-F-120V-MCT-WH
SLE-F-12V-MCT-WH
White



SLE-F-120V-MCT-ORB
SLE-F-12V-MCT-ORB
Oil-Rubbed Bronze



SLE-F-120V-MCT-BN
SLE-F-12V-MCT-BN
Brushed Nickel

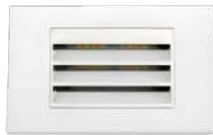

SLE-LH-120V-MCT-WH
SLE-LH-12V-MCT-WH
White



SLE-LH-120V-MCT-ORB
SLE-LH-12V-MCT-ORB
Oil-Rubbed Bronze



SLE-LH-120V-MCT-BN
SLE-LH-12V-MCT-BN
Brushed Nickel

SELECTABLE CCT LED INTEGRATED STEP LIGHTS



CATALOG NO.

DESCRIPTION

MODEL A - 120V SELECTABLE CCT LED INTEGRATED STEP LIGHTS

SLE-A-120V-MCT-WH	3.5W	100LM	30K/40K/50K	White
SLE-A-120V-MCT-ORB	3.5W	50LM	30K/40K/50K	Oil-Rubbed Bronze
SLE-A-120V-RGBWW-PB-ORB	3.5W	50LM	RGBWW	Oil-Rubbed Bronze
SLE-A-120V-MCT-BN	3.5W	50LM	30K/40K/50K	Brushed Nickel

MODEL A - 120V SELECTABLE CCT LED INTEGRATED STEP LIGHTS WITH PIR MOTION SENSOR & PHOTOCCELL

SLE-A-120V-MCT-PIR-WH	3W	150LM	30K/40K/50K	White
SLE-A-120V-MCT-PIR-ORB	3W	75LM	30K/40K/50K	Oil-Rubbed Bronze

MODEL LH - 120V SELECTABLE CCT LED INTEGRATED STEP LIGHTS

SLE-LH-120V-MCT-WH	5W	150LM	30K/40K/50K	White
SLE-LH-120V-MCT-ORB	5W	75LM	30K/40K/50K	Oil-Rubbed Bronze
SLE-LH-120V-MCT-BN	5W	75LM	30K/40K/50K	Brushed Nickel

MODEL F - 120V SELECTABLE CCT LED INTEGRATED STEP LIGHTS

SLE-F-120V-MCT-WH	3.5W	200LM	30K/40K/50K	White
SLE-F-120V-MCT-ORB	3.5W	100LM	30K/40K/50K	Oil-Rubbed Bronze
SLE-F-120V-MCT-BN	3.5W	75LM	30K/40K/50K	Brushed Nickel

MODEL A - 12V SELECTABLE CCT LED INTEGRATED STEP LIGHTS

SLE-A-12V-MCT-WH	3.5W	100LM	30K/40K/50K	White
SLE-A-12V-MCT-ORB	3.5W	50LM	30K/40K/50K	Oil-Rubbed Bronze
SLE-A-12V-RGBWW-PB-ORB	3.5W	50LM	RGBWW	Oil-Rubbed Bronze
SLE-A-12V-MCT-BN	3.5W	50LM	30K/40K/50K	Brushed Nickel

MODEL A - 12V SELECTABLE CCT LED INTEGRATED STEP LIGHTS WITH PIR MOTION SENSOR & PHOTOCCELL

SLE-A-12V-MCT-PIR-WH	3W	150LM	30K/40K/50K	White
SLE-A-12V-MCT-PIR-ORB	3W	75LM	30K/40K/50K	Oil-Rubbed Bronze

MODEL LH - 12V SELECTABLE CCT LED INTEGRATED STEP LIGHTS

SLE-LH-12V-MCT-WH	5W	150LM	30K/40K/50K	White
SLE-LH-12V-MCT-ORB	5W	75LM	30K/40K/50K	Oil-Rubbed Bronze
SLE-LH-12V-MCT-BN	5W	75LM	30K/40K/50K	Brushed Nickel

MODEL F - 12V SELECTABLE CCT LED INTEGRATED STEP LIGHTS

SLE-F-12V-MCT-WH	3.5W	200LM	30K/40K/50K	White
SLE-F-12V-MCT-ORB	3.5W	100LM	30K/40K/50K	Oil-Rubbed Bronze
SLE-F-12V-MCT-BN	3.5W	75LM	30K/40K/50K	Brushed Nickel

MODERN LED TREE LIGHTS

CATALOG NO.

DESCRIPTION



TL-118-MCT-ORB	4.5W	300LM	30K/40K/50K
TL-118-MCT-AZ	4.5W	300LM	30K/40K/50K



STEP LIGHT ENGINES Polycarbonate

	DESCRIPTION
120V 12V	SLEA-12V-27K 2W 86LM 2700K
	SLEA-12V-30K 2W 86LM 3000K
	SLEA-12V-40K 2W 86LM 4000K
	SLEA-12V-50K 2W 86LM 5000K
	SLEA-120V-27K 2W 86LM 2700K
	SLEA-120V-30K 2W 86LM 3000K
	SLEA-120V-40K 2W 86LM 4000K
	SLEA-120V-50K 2W 86LM 5000K

FACE For SLEA PLATES (Order Separately)

PRECISION-CAST ALUMINUM



SLT-A-WH (WHITE FINISH)



SLT-A-BN (BRUSHED NICKEL FINISH)



SLT-A-AZ (ANTIQUe BRONZE FINISH)



SLT-A-ORB (OIL-RUBBED BRONZE FINISH)



STEP LIGHT ENGINES Polycarbonate

	DESCRIPTION
120V 12V	SLEB-12V-27K 2W 86LM 2700K
	SLEB-12V-30K 2W 86LM 3000K
	SLEB-12V-40K 2W 86LM 4000K
	SLEB-12V-50K 2W 86LM 5000K
	SLEB-120V-27K 2W 86LM 2700K
	SLEB-120V-30K 2W 86LM 3000K
	SLEB-120V-40K 2W 86LM 4000K
	SLEB-120V-50K 2W 86LM 5000K

FACE For SLEB PLATES (Order Separately)

PRECISION-CAST ALUMINUM



SLT-B-WH (WHITE FINISH)



SLT-B-BN (BRUSHED NICKEL FINISH)



SLT-B-AZ (ANTIQUe BRONZE FINISH)



SLT-B-ORB (OIL-RUBBED BRONZE FINISH)



STEP LIGHT ENGINES Polycarbonate

	CATALOG NO.	DESCRIPTION
120V 12V	SLE-12V-27K	2W 100LM 2700K
	SLE-12V-30K	2W 100LM 3000K
	SLE-12V-40K	2W 100LM 4000K
	SLE-12V-50K	2W 118LM 5000K
	SLE-120V-27K	2W 90LM 2700K
	SLE-120V-30K	2W 90LM 3000K
	SLE-120V-40K	2W 90LM 4000K
	SLE-120V-50K	2W 104LM 5000K

FACE For SLE PLATES (Order Separately)

PRECISION-CAST ALUMINUM



SLT-LH-ORB (OIL-RUBBED BRONZE FINISH)



SLT-LH-BN (BRUSHED NICKEL FINISH)



SLT-LH-WH (WHITE FINISH)



SLT-LH-AZ (ANTIQUe BRONZE FINISH)



SLT-F-ORB (OIL-RUBBED BRONZE FINISH)



SLT-F-BN (BRUSHED NICKEL FINISH)



SLT-F-WH (WHITE FINISH)



SLT-F-AZ (ANTIQUe BRONZE FINISH)



SLT-S-ORB (OIL-RUBBED BRONZE FINISH)

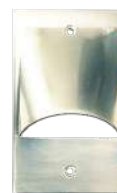

SLT-S-BN (BRUSHED NICKEL FINISH)



SLT-S-WH (WHITE FINISH)



SLT-S-AZ (ANTIQUe BRONZE FINISH)



SLT-LV-ORB (OIL-RUBBED BRONZE FINISH)



SLT-LV-BN (BRUSHED NICKEL FINISH)



SLT-LV-WH (WHITE FINISH)



SLT-LV-AZ (ANTIQUe BRONZE FINISH)



Clear PVC Gasket Set Included with Light Engine for J-box or weatherproof box mounting

LANDSCAPE

UNDERCABINET LIGHTING



UCE-9-WHT
White



UCE-12-WHT
White



UCE-18-WHT
White



UCE-21-WHT
White



UCE-24-WHT
White



UCE-32-WHT
White



UCE-40-WHT
White

BUILDER SERIES 5CCT HARD-WIRE UNDER CABINET LIGHT, OPTIONAL CORD



CATALOG NO.	DESCRIPTION	ARRIVES THIS SEASON CHECK & PRE-ORDER	PKG. QTY.
UCE-9-WHT	3W 180LM	27K/30K/35K/40K/50K White	10
UCE-12-WHT	5W 300LM	27K/30K/35K/40K/50K White	10
UCE-18-WHT	8W 480LM	27K/30K/35K/40K/50K White	10
UCE-21-WHT	10W 600LM	27K/30K/35K/40K/50K White	10
UCE-24-WHT	12W 720LM	27K/30K/35K/40K/50K White	10
UCE-32-WHT	16W 960LM	27K/30K/35K/40K/50K White	10
UCE-40-WHT	20W 1200LM	27K/30K/35K/40K/50K White	10
UCA-LC8-WHT	8in Linking Cord For Uce And UCE Series, White		
UCA-PC-6FT-WHT	6Ft Power Cord Cord For Uce And UCE Series, White		

ADJUSTABLE ANGLE MULTI COLOR-TEMPERATURE UNDERCABINET LIGHTS



CATALOG NO.	DESCRIPTION	PKG. QTY.
UCA-8-WHT	3W 150LM 2700K/3000K/4000K 8"L WHITE	10
UCA-12-WHT	5W 275LM 2700K/3000K/4000K 12"L WHITE	10
UCA-16-WHT	6.5W 390LM 2700K/3000K/4000K 16" WHITE	10
UCA-21-WHT	8W 450LM 2700K/3000K/4000K 21"L WHITE	10
UCA-24-WHT	12W 650LM 2700K/3000K/4000K 24"L WHITE	10
UCA-33-WHT	16W 900LM 2700K/3000K/4000K 33"L WHITE	10
UCA-42-WHT	20W 1100LM 2700K/3000K/4000K 42"L WHITE	10
UCA-LC12-WHT	12" Linking Cable for White UCA Series - White color	
UCA-LC8-WHT	8in Linking Cord For Uce And UCE Series, White	
UCA-PC-6FT-WHT	6Ft Power Cord Cord For Uce And UCE Series, White	
UCA-8-BRZ	3W 150LM 2700K/3000K/4000K 8"L BRONZE	10
UCA-12-BRZ	5W 275LM 2700K/3000K/4000K 12"L BRONZE	10
UCA-16-BRZ	6.5W 390LM 2700K/3000K/4000K 16"L BRONZE	10
UCA-21-BRZ	8W 450LM 2700K/3000K/4000K 21"L BRONZE	10
UCA-24-BRZ	12W 650LM 2700K/3000K/4000K 24"L BRONZE	10
UCA-33-BRZ	16W 900LM 2700K/3000K/4000K 33"L BRONZE	10
UCA-42-BRZ	20W 1100LM 2700K/3000K/4000K 42"L BRONZE	10
UCA-LC12-BLK	12" Linking Cable for Bronze UCA Series - Black color (Matches the color of included cables)	
UCA-LC8-BLK	8in Linking Cord For Uce And UCE Series, Black	
UCA-PC-6FT-BLK	6Ft Power Cord Cord For Uce And UCE Series, Black	
UCA-DISPLAY	Display Board for UCA Series	

120V 120V



MULTI COLOR-TEMPERATURE LIGHTS Accessories Included



- 6' Power Cord
- 8" Interconnect Cable
- End-to-End Coupling
- Mounting Screws



On/Off Switch with
100% /50% Dimming.
Color Temp. selection
Switch: 2700K/ 3000K/ 4000k



1/2" KOs
Cable Connector
included

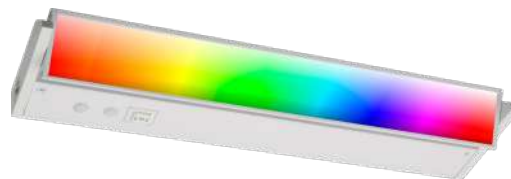
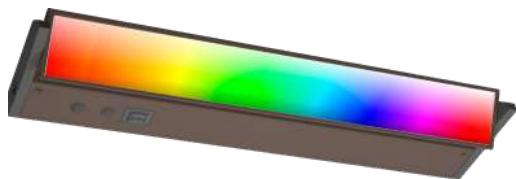

RGBW (9 MODES) & 3 CCT UNDER CABINET LIGHT, PUSH-BUTTON COLOR CONTROL



CATALOG NO.	DESCRIPTION	ARRIVES THIS SEASON CHECK & PRE-ORDER	PKG. QTY.
UCA-RGBW-PB-12-BR	5W 275LM 30K/40K/50K + RGB Bronze		10
UCA-RGBW-PB-12-WH	5W 275LM 30K/40K/50K + RGB White		10
UCA-RGBW-PB-18-BR	8W 440LM 30K/40K/50K + RGB Bronze		10
UCA-RGBW-PB-18-WH	8W 440LM 30K/40K/50K + RGB White		10
UCA-RGBW-PB-24-BR	12W 660LM 30K/40K/50K + RGB Bronze		10
UCA-RGBW-PB-24-WH	12W 660LM 30K/40K/50K + RGB White		10
UCA-RGBW-PB-32-BR	16W 880LM 30K/40K/50K + RGB Bronze		10
UCA-RGBW-PB-32-WH	16W 880LM 30K/40K/50K + RGB White		10
UCA-RGBW-PB-40-BR	20W 1100LM 30K/40K/50K + RGB Bronze		10
UCA-RGBW-PB-40-WH	20W 1100LM 30K/40K/50K + RGB White		10

LED LINEAR UNDERCABINET LIGHTS (Use External Drivers)



CATALOG NO.	DESCRIPTION	PKG. QTY.
UCW6WW	2W 140LM 3000K 6"	30
UCW6W	2W 168LM 6000K 6"	30
UCW12WW	3W 250LM 3000K 12"	30
UCW12W	3W 280LM 6000K 12"	30
UCW20WW	5W 420LM 3000K 20"	30
UCW20W	5W 462LM 6000K 20"	30
UCW32WW	8W 590LM 3000K 32"	30
UCW32W	8W 640LM 6000K 32"	30
UCW40WW	11W 820LM 3000K 40"	30
UCW40W	11W 880LM 6000K 40"	30
UC6WW	2W 140LM 3000K 6"	30
UC6W	2W 168LM 6000K 6"	30
UC12WW	3W 250LM 3000K 12"	30
UC12W	3W 280LM 6000K 12"	30
UC20WW	5W 420LM 3000K 20"	30
UC20W	5W 462LM 6000K 20"	30
UC32WW	8W 590LM 3000K 32"	30
UC32W	8W 640LM 6000K 32"	30
UC40WW	11W 820LM 3000K 40"	30
UC40W	11W 880LM 6000K 40"	30
UC-DISPLAY	Display Board for UC Series	-

UNDERCABINET

12V

24V



PLUG-IN DRIVERS (Non-Dimming)

CATALOG NO.	DESCRIPTION
UC12PS6W	6W, 12V, POWER SUPPLY WITH CABLE
UC12PS12W	12W, 12V, POWER SUPPLY W/ SWITCH & 1.5 POWER CABLE
UCPS6W	6W, 24V, POWER SUPPLY W/ CABLE
UCPS12W	12W, 24V, POWER SUPPLY W/ 1.5 POWER CABLE
UCPS24W	24W, 24V, 1A, POWER SUPPLY W/ 1.5 POWER CABLE
UCPS48W	48W, 24V, 1A, POWER SUPPLY W/ 1.5 POWER CABLE

MAGNETIC DIMMABLE DRIVERS* (Use Magnetic Low-Voltage Dimmers)



CATALOG NO.	DESCRIPTION
UCM-20L-12DC	DIMMABLE, 20W, 12V, 5" X 2-1/8" X 2"
UCM-40L-12DC	DIMMABLE, 40W, 12V, 5" X 2-1/8" X 2"
UCM-50L-12DC	DIMMABLE, 50W, 12V, 5" X 2-1/8" X 2"
UCM-100L-12DC	DIMMABLE, 100W, 12V, 5" X 4-1/8" X 2"
UCM-150L-12DC	DIMMABLE, 150W, 12V, 5" X 4-1/8" X 4"
UCM-300L-12DC	DIMMABLE, 300W, 12V, 5" X 4-1/8" X 4"
UCM-20L-24DC	DIMMABLE, 20W, 24V, 5" X 2-1/8" X 2"
UCM-40L-24DC	DIMMABLE, 40W, 24V, 5" X 2-1/8" X 2"
UCM-50L-24DC	DIMMABLE, 50W, 24V, 5" X 2-1/8" X 2"
UCM-60L-24DC	DIMMABLE, 60W, 24V, 5" X 2-1/8" X 2"
UCM-96L-24DC	DIMMABLE, 96W, 24V, 5" X 4-1/8" X 2"
UCM-150L-24DC	DIMMABLE, 150W, 24V, 5" X 4-1/8" X 4"
UCM-300L-24DC	DIMMABLE, 300W, 24V, 5" X 4-1/8" X 4"

*Not dimmable with RGB products (use the dimming feature of your RGB controller)

UNDER CABINET LIGHTING PARTS & ACCESSORIES

CATALOG NO.	DESCRIPTION
UCDIMMER	LED UNDER CABINET LIGHTS DIMMER
UCDIMMER-TOUCH	LINEAR UNDER CABINET TOUCH DIMMER TO CONNECT TO FIXTURES END, BLACK
UCDIMMER-TOUCH-WH	LINEAR UNDER CABINET TOUCH DIMMER TO CONNECT TO FIXTURES END, WHITE
UCJUNCTION-B	HARD WIRE POWER FEED IN / OUT, BLACK
UCJUNCTION-W	HARD WIRE POWER FEED IN / OUT, WHITE
UCSENS-PIR-1	PIR SENSOR, AUTO ON/OFF WHEN MOVEMENT, MAX 72W, 4" (10CM) RANGE, 120D, -20°C TO 40°C
UCSENS-PIR	PIR SENSOR, AUTO ON/OFF WHEN MOVEMENT, MAX 72W, 4" (10CM) RANGE, 120D, -20°C TO 40°C
UCCONCABLE	3.25 FT. CONNECTOR CABLE, BLACK
UCCONCABLE-WH	3.25 FT. CONNECTOR CABLE, WHITE
UCCONCABLE-10	10 FT. UNDER CABINET LIGHT CONNECTOR CABLE, BOTH SIDE MALE, BLACK
UCCONCABLE-10-WH	10 FT. UNDER CABINET LIGHT CONNECTOR CABLE, BOTH SIDE MALE, WHITE
UCCOP-3F	3 FT. UNDER CABINET LIGHT COUPLING, BOTH SIDE FEMALE, BLACK
UCCOP-3F-WH	3 FT. UNDER CABINET LIGHT COUPLING, BOTH SIDE FEMALE, WHITE
UCPOWERC-10F	10 FT. UNDER CABINET LIGHT POWER CONNECTOR, 1 SIDE MALE, 1 SIDE FEMALE, BLACK
UCPOWERC-10F-WH	10 FT. UNDER CABINET LIGHT POWER CONNECTOR, 1 SIDE MALE, 1 SIDE FEMALE, WHITE
UCRE04	4 OUTPUT EASY RECEPTACLE
UCRE08	8 OUTPUT EASY RECEPTACLE
UCAC01	CORNER CONNECTOR, BLACK
UCAC01-WH	CORNER CONNECTOR, WHITE
UCPLASCONN	PLASTIC CONNECTOR, BLACK
UCPLASCONN-WH	PLASTIC CONNECTOR, WHITE
UCMAGNET+3M	2 PCS OF MAGNET AND 2 PCS OF 3M TAPE FOR LED UNDER CABINET LIGHTS

LED ADJUSTABLE UNDERCABINET, 24V

CATALOG NO.	DESCRIPTION	PKG. QTY.
UC-ADJ-12WW	5W 380LM 3000K 11.81"	30
UC-ADJ-12W	5W 400LM 6000K 11.81"	30
UC-ADJ-20WW	8W 600LM 3000K 19.68"	30
UC-ADJ-20W	8W 640LM 6000K 19.68"	30
UC-ADJ-40WW	16W 1200LM 3000K 39.37"	30
UC-ADJ-40W	16W 1280LM 6000K 39.37"	30
UC-ADJ-PIR	PIR SENSOR FOR U/C ADJUSTABLE SERIES	-
UC-ADJ-DMR	TOUCH DIMMER WITH MEMORY FOR U/C ADJUSTABLE SERIES	-
UC-ADJ-JUNCTION	JUNCTION CONNECTOR FOR U/C ADJUSTABLE SERIES	-

LED T5 RETROFIT BAR WITH INTERNAL DRIVER (SURFACE MOUNTING BRACKETS & SCREWS INCLUDED)



CATALOG NO.	DESCRIPTION	WHILE SUPPLIES LAST	MAX RUN	PKG. QTY.
T5-12IN-5W-30K-D	5W 575LM 3000K 1FT.		15'	24
T5-12IN-5W-40K-D	5W 575LM 4000K 1FT.		15'	24
T5-12IN-5W-50K-D	5W 625LM 5000K 1FT.		15'	24
T5-22IN-9W-30K-D	9W 1035LM 3000K 2FT.		24'	24
T5-22IN-9W-40K-D	9W 1035LM 4000K 2FT.		24'	24
T5-22IN-9W-50K-D	9W 1125LM 5000K 2FT.		24'	24
T5-47IN-16W-30K-D	16W 1840LM 3000K 4FT.		31'	24
T5-47IN-16W-50K-D	16W 2000LM 5000K 4FT.		31'	24
T5-6FT-PC	6 FT. Plug-in Power Cord			-
T5-6FT-PCS	6 FT. Plug-in Power Cord with Switch			-
T5-8IN-JUMP	8" Linking Cable			-
T5-6FT-PT	6' AC Input Wire (PIGTAIL)			-
T5-COUPLER	Coupler			-
T5-MAGSET	Clip-on Secure Magnet Set			-



LED ADJUSTABLE PUCK LIGHTS, 120V

6Ft. Power Cord with In-Line switch



CATALOG NO.	DESCRIPTION
3" ROUND ADJUSTABLE PUCK LIGHT	
PL120ADJ-30K-WH	4.5W 250LM 3000K White
PL120ADJ-40K-WH	4.5W 250LM 4000K White
PL120ADJ-50K-WH	4.5W 250LM 5000K White
PL120ADJ-30K-BK	4.5W 250LM 3000K Black
PL120ADJ-40K-BK	4.5W 250LM 4000K Black
PL120ADJ-50K-BK	4.5W 250LM 5000K Black
PL120ADJ-30K-BN	4.5W 250LM 3000K Brushed-Nickel
PL120ADJ-40K-BN	4.5W 250LM 4000K Brushed-Nickel
PL120ADJ-50K-BN	4.5W 250LM 5000K Brushed-Nickel
3-PACK 3" ROUND ADJUSTABLE PUCK LIGHT	
PL120ADJ-3KIT-30K-WH	4.5W 250LM 3000K White
PL120ADJ-3KIT-40K-WH	4.5W 250LM 4000K White
PL120ADJ-3KIT-50K-WH	4.5W 250LM 5000K White
PL120ADJ-3KIT-30K-BK	4.5W 250LM 3000K Black
PL120ADJ-3KIT-40K-BK	4.5W 250LM 4000K Black
PL120ADJ-3KIT-50K-BK	4.5W 250LM 5000K Black
PL120ADJ-3KIT-30K-BN	4.5W 250LM 3000K Brushed-Nickel
PL120ADJ-3KIT-40K-BN	4.5W 250LM 4000K Brushed-Nickel
PL120ADJ-3KIT-50K-BN	4.5W 250LM 5000K Brushed-Nickel



NO21

UNDERCABINET

LED PUCK LIGHTS (3.3 FT. CORD WITH MALE SOCKET, MOUNTING HARDWARE, SCREWLESS TRIM)



CATALOG NO.	DESCRIPTION
4" ROUND & SQUARE SLIM PUCK LIGHT	
PL12R-30K-WH	3.5W 230LM 3000K White
PL12R-40K-WH	3.5W 230LM 4000K White
PL12R-50K-WH	3.5W 230LM 5000K White
PL12S-30K-WH	3.5W 230LM 3000K White
PL12S-40K-WH	3.5W 230LM 4000K White
PL12S-50K-WH	3.5W 230LM 5000K White
PL12R & PL12S SERIES COLOR TRIMS	
PL12R-TRM-BK	PL12R series replacement color trim-Black
PL12R-TRM-BN	PL12R series replacement color trim-Brushed-Nickel
PL12R-TRM-BR	PL12R series replacement color trim-Bronze
PL12S-TRM-BK	PL12S series replacement color trim-Black
PL12S-TRM-BN	PL12S series replacement color trim-Brushed-Nickel
PL12S-TRM-BR	PL12S series replacement color trim-Bronze



NO21

LED PUCK LIGHTS (3.3 FT. CORD WITH MALE SOCKET, MOUNTING HARDWARE, SCREWLESS TRIM)



12V



3" ROUND SLIM PUCK LIGHT - 1/8" H (1/16" WHEN RECESSED)

CATALOG NO.	DESCRIPTION
PL12-30K-WH	2W 120LM 3000K White
PL12-40K-WH	2W 120LM 4000K White
PL12-50K-WH	2W 120LM 5000K White
PL12-30K-BK	2W 120LM 3000K Black
PL12-40K-BK	2W 120LM 4000K Black
PL12-50K-BK	2W 120LM 5000K Black
PL12-30K-BN	2W 120LM 3000K Brushed-Nickel
PL12-40K-BN	2W 120LM 4000K Brushed-Nickel
PL12-50K-BN	2W 120LM 5000K Brushed-Nickel

12V



3-PACK 3" ROUND SLIM PUCK LIGHT - 1/8" H (1/16" WHEN RECESSED)

PL12-3KIT-30K-WH	2W 120LM 3000K White
PL12-3KIT-40K-WH	2W 120LM 4000K White
PL12-3KIT-50K-WH	2W 120LM 5000K White
PL12-3KIT-30K-BK	2W 120LM 3000K Black
PL12-3KIT-40K-BK	2W 120LM 4000K Black
PL12-3KIT-50K-BK	2W 120LM 5000K Black
PL12-3KIT-30K-BN	2W 120LM 3000K Brushed-Nickel
PL12-3KIT-40K-BN	2W 120LM 4000K Brushed-Nickel
PL12-3KIT-50K-BN	2W 120LM 5000K Brushed-Nickel



PL12 SERIES COLOR TRIMS

PL12-TRM-BK	PL12 series replacement color trim-Black
PL12-TRM-BN	PL12 series replacement color trim-Brushed-Nickel
PL12-TRM-BR	PL12 series replacement color trim-Bronze

12V



3" ROUND ADJUSTABLE PUCK LIGHT - DRIVER NOT INCL.

PL12ADJ-30K-WH	4.5W 250LM 3000K White
PL12ADJ-40K-WH	4.5W 250LM 4000K White
PL12ADJ-50K-WH	4.5W 250LM 5000K White
PL12ADJ-30K-BK	4.5W 250LM 3000K Black
PL12ADJ-40K-BK	4.5W 250LM 4000K Black
PL12ADJ-50K-BK	4.5W 250LM 5000K Black
PL12ADJ-30K-BN	4.5W 250LM 3000K Brushed-Nickel
PL12ADJ-40K-BN	4.5W 250LM 4000K Brushed-Nickel
PL12ADJ-50K-BN	4.5W 250LM 5000K Brushed-Nickel

LED PUCK LIGHT ACCESSORIES



PL12-SPLIT3-WH	3-Hole mini splitter with female socket & 40" cord, white
PL12-SPLIT3-BK	3-Hole mini splitter with female socket & 40" cord, Black
PL12-SPLIT6-WH	6-Hole mini splitter with female socket & 40" cord, white
PL12-SPLIT6-BK	6-Hole mini splitter with female socket & 40" cord, Black
PL12-SPLIT10-WH	10-Hole mini splitter with female socket & 40" cord, white
PL12-SPLIT10-BK	10-Hole mini splitter with female socket & 40" cord, Black
PL12-PF-WH	6" Power feed cord, White
PL12-PF-BK	6" Power feed cord, Black
PL12-PIDR-12W-WH	12W Plug-in driver with switch, white
PL12-PIDR-12W-BK	12W Plug-in driver with switch, Black
PL12-PIDR-24W-WH	24W Plug-in driver with switch, white
PL12-PIDR-24W-BK	24W Plug-in driver with switch, Black
PL12-ILDMR-WH	In-Line dimming control, White
PL12-ILDMR-BK	In-Line dimming control, Black
PL12-HWDR-25W-D	25W Plug-in Dimmable driver with switch, 120V

LED PUCK LIGHTS DISPLAY BOARD

CATALOG NO.

DESCRIPTION





PL12-DISPLAY

Display board with Brochures for PL12 Series



UNDERCABINET

EXIT & EMERGENCY LIGHTING

BUILDER SERIES SUPER SLIM LED EXIT SIGN, 120-277V, 12"(W) x 7 1/2"(H) x 1"(D)

CATALOG NO.	NUMBER OF FACES	LETTERS COLOR	HOUSING	BATTERY
 XTSL-RW	Universal Single/Double	RED	White	1.2V Ni-MH
 XTSL-GW	Universal Single/Double	GREEN	White	1.2V Ni-MH



LED EXIT SIGN EXIT SIGN, 120-277V, 12"(W) x 7-1/2"(H) x 1-1/2"(D)

CATALOG NO.	NUMBER OF FACES	LETTERS COLOR	HOUSING	BATTERY
 XT-RW-EM	Universal Single/Double	RED	White	NiCd
XT-GW-EM	Universal Single/Double	GREEN	White	NiCd
 XT-RB-EM	Universal Single/Double	RED	Black	NiCd
XT-GB-EM	Universal Single/Double	GREEN	Black	NiCd

TWO-CIRCUITS EXIT SIGN, 12"(W) x 7-1/2"(H) x 1-1/2"(D)

CATALOG NO.	NUMBER OF FACES	LETTERS COLOR	HOUSING	NUMBER OF CIRCUITS
 XT-RW-2C-120V	Universal Single/Double	RED	White	Two Circuits
XT-RW-2C-277V	Universal Single/Double	RED	White	Two Circuits
XT-GW-2C-120V	Universal Single/Double	GREEN	White	Two Circuits
XT-GW-2C-277V	Universal Single/Double	GREEN	White	Two Circuits

2-IN-1 COLOR-SELEC UNIVERSAL EXIT SIGN, 120-277V, 15-1/2"(W) x 12-1/2"(H) x 9"(D) DEFAULT IS RED, FLIP SWITCH INSIDE AND CHANGE PROVIDED GREEN FILM[S] FOR GREEN

CATALOG NO.	NUMBER OF FACES	LETTERS COLOR	HOUSING	BATTERY
 XTU-RG-EM-BK	Universal Single/Double	RED/GREEN	Black	1.2V Ni-MH
 XTU-RG-EM	Universal Single/Double	RED/GREEN	White	1.2V Ni-MH

SPEC SERIES THIN DIECAST LED EXIT SIGN, 120-277V, 11-13/16"(W) x 7-3/4"(H) x 7/8"(D)

CATALOG NO.	NUMBER OF FACES	LETTER COLOR	HOUSING	BATTERY
 XD-TH-1GAAEM	Single Face	Green	Aluminum	NiCd
XD-TH-1GBBEM	Single Face	Green	Black	NiCd
XD-TH-1GWWEM	Single Face	Green	White	NiCd
XD-TH-1RAAEM	Single Face	Red	Aluminum	NiCd
XD-TH-1RBBEM	Single Face	Red	Black	NiCd
XD-TH-1RWWEM	Single Face	Red	White	NiCd
XD-TH-2GAAEM	Double Face	Green	Aluminum	NiCd
XD-TH-2GBBEM	Double Face	Green	Black	NiCd
XD-TH-2GWWEM	Double Face	Green	White	NiCd
XD-TH-2RAAEM	Double Face	Red	Aluminum	NiCd
XD-TH-2RBBEM	Double Face	Red	Black	NiCd
XD-TH-2RWWEM	Double Face	Red	White	NiCd

BUILDER SERIES EDGELIT LED EXIT SIGN WITH ALUMINUM HOUSING, SINGLE FACE WITH OPTIONAL DOUBLE FACE, OPT. RECESS-MT. ACCESSORY

CATALOG NO.	NUMBER OF FACES	LETTER COLOR	FACE COLOR	BATTERY
 XT-EL1RCA-EM	Single Face	Red	White	NiCd
XT-EL1GCA-EM	Single Face	Green	White	NiCd
XT-EL2RM-CP	Field-Installed Double-Face Mirror Panel only to Convert Single Face to Double Face- Red			
XT-EL2GM-CP	Field-Installed Double-Face Mirror Panel only to Convert Single Face to Double Face- Green			
XT-ELRMA	Field-Installed Recessed Mounting Conversion Kit, Order together with Exit Sign above			



XT-ELRMA RECESSED CONVERSION KIT (FIXTURE NOT INCL.)

SPEC SERIES EDGELIT LED EXIT SIGN, 120-277V, 13"(W) x 11-1/8"(H) x 1-3/4"(D)



CATALOG NO.	NUMBER OF FACES	LETTER COLOR	FACE COLOR	CANOPY	BATTERY
XE-1RCA-EM	Single Face	Red	Clear	Aluminum	NiCd
XE-1RCW-EM	Single Face	Red	Clear	White	NiCd
XE-2RMW-EM	Double Face	Red	Mirror	White	NiCd
XE-2RMA-EM	Double Face	Red	Mirror	Aluminum	NiCd
XE-2C-120V	Optional Dual circuits, 120V				
XE-2C-277V	Optional Dual circuits, 277V				
XE-SDT	Optional Self Diagnostics Test				



WET LOCATION LED EXIT SIGN, UNIVERSAL



CATALOG NO.	NUMBER OF FACES	LETTER COLOR	HOUSING	BATTERY
XT-WP-RG-EM	Universal Single/Double	Red	Gray	NiCd
XT-WP-GG-EM	Universal Single/Double	Green	Gray	NiCd



SPEC SERIES WET LOCATION LED EXIT SIGN

(TWO-CIRCUITS OPTION AVAILABLE), 120-277V, 12-1/2"(W) x 9-1/4"(H) x 4-3/8"(D)



CATALOG NO.	NUMBER OF FACES	LETTER COLOR	HOUSING	BATTERY
XT-WP-1RB-EM	Single Face	Red	Black	NiCd
XT-WP-1GB-EM	Single Face	Green	Black	NiCd
XT-WP-2RB-EM	Double Face	Red	Black	NiCd
XT-WP-2GG-EM	Double Face	Green	Gray	NiCd
XT-WP-2GB-EM	Double Face	Green	Black	NiCd
XT-WP-SDT	Optional Self Diagnostics Test			
XT-WP-2C-120V	Optional Dual circuits, 120V			
XT-WP-2C-277V	Optional Dual circuits, 277V			



SPEC SERIES NEMA 4X LED EXIT SIGN, 120-277V 14-3/4"(W) X 10"(H) X 6"(D)



CATALOG NO.	WATTS	NUMBER OF FACES	HOUSING COLOR	BATTERY
XTN4X-1GB	3.8W	Single Face	Green	-
XTN4X-1GW	3.8W	Single Face	Green	-
XTN4X-1RB	3.2W	Single Face	Red	-
XTN4X-1RW	3.2W	Single Face	Red	-
XTN4X-2GB	3.8W	Double Face	Green	-
XTN4X-2GW	3.8W	Double Face	Green	-
XTN4X-2RB	3.2W	Double Face	Red	-
XTN4X-2RW	3.2W	Double Face	Red	-
XTN4X-1GBEM	3.8W	Single Face	Green	NiCd
XTN4X-1GWEM	3.8W	Single Face	Green	NiCd
XTN4X-1RBEM	3.2W	Single Face	Red	NiCd
XTN4X-1RWEM	3.2W	Single Face	Red	NiCd
XTN4X-2GBEM	3.8W	Double Face	Green	NiCd
XTN4X-2GWEM	3.8W	Double Face	Green	NiCd
XTN4X-2RBEM	3.2W	Double Face	Red	NiCd
XTN4X-2RWEM	3.2W	Double Face	Red	NiCd

NEMA 4X RATED



EXIT & EMERGENCY

BUILDER SERIES SUPER SLIM LED EXIT SIGN

WITH ADJUSTABLE LED HEADS, 120-277V, 12"(W) x 7 3/5"(H) x 1"(D)



CATALOG NO.	NUMBER OF FACES	LETTERS COLOR	HOUSING	BATTERY
 XTSL-CL-RW	Universal Single/Double	RED	White	3.6 Ni-MH
XTSL-CL-GW	Universal Single/Double	GREEN	White	3.6 Ni-MH

COMBINATION LED EXIT SIGN & LED EMERGENCY, 120-277V, 21"(W) x 9"(H) x 4-7/16"(D)





CATALOG NO.	NUMBER OF FACES	LETTER COLOR	HOUSING	BATTERY
 XT-CL-RW-EM	Universal Single/Double	Red	White	NiCd
XT-CL-GW-EM	Universal Single/Double	Green	White	NiCd

2-IN-1 COLOR-SELEC UNIVERSAL COMBO UNIT, 120-277V, 15-1/2"(W) x 12-1/2"(H) x 9"(D)

DEFAULT IS RED, FLIP SWITCH INSIDE AND CHANGE PROVIDED GREEN FILM[S] FOR GREEN



CATALOG NO.	NUMBER OF FACES	LETTERS COLOR	HOUSING	BATTERY	
 XTU-CL-RG-EM-BK	Universal Single/Double	RED/GREEN	Black	1.2V Ni-MH	
XTU-CL-RG-EM	Universal Single/Double	RED/GREEN	White	1.2V Ni-MH	
 XTU-CL-RG-EM-RC	Universal Single/Double	RED/GREEN	White	1.2V Ni-MH	Remote Capable
XTU-CL-RG-EM-RC-BK	Universal Single/Double	RED/GREEN	Black	1.2V Ni-MH	Remote Capable

SPEC SERIES COMBO DIE-CAST ALUMINUM LED EXIT SIGN

ADJUSTABLE HEADS, 120-277V, 12-1/2"(W) x 11-3/4"(H) x 2-3/8"(D)



CATALOG NO.	NUMBER OF FACES	LETTER COLOR	HOUSING	BATTERY
 XT-C-ADJ-3RBBEM	Universal Single/Double	Red	Black	NiCd
XT-C-ADJ-3RAAEM	Universal Single/Double	Red	Aluminum	NiCd
XT-C-ADJ-3RWWEM	Universal Single/Double	Red	White	NiCd
XT-C-ADJ-3GBBEM	Universal Single/Double	Green	Black	NiCd
XT-C-ADJ-3GAAEM	Universal Single/Double	Green	Aluminum	NiCd
XT-C-ADJ-3GWWEM	Universal Single/Double	Green	White	NiCd
XT-C-ADJ-RC	Optional Remote Capability			

SPEC SERIES WET LOCATION COMBINATION LED EXIT SIGN &

LED EMERGENCY, 120-277V 3.6W, 13-11/16"(W) x 12-3/8"(H) x 4-1/16"(D)



CATALOG NO.	NUMBER OF FACES	LETTER COLOR	HOUSING
 CWLEZXT1G	Single Face	Green	White
CWLEZXT1GG	Single Face	Green	Gray
CWLEZXT1RW	Single Face	Red	White
CWLEZXT1RG	Single Face	Red	Gray
CWLEZXT1GB	Single Face	Green	Black
CWLEZXT1RB	Single Face	Red	Black
CWLEZXT2GB	Double Face	Green	Black
CWLEZXT2RB	Double Face	Red	Black
CWLEZXT2GW	Double Face	Green	White
CWLEZXT2GG	Double Face	Green	Gray
CWLEZXT2RW	Double Face	Red	White
CWLEZXT2RG	Double Face	Red	Gray
CWLEZ-SDT	Optional Self Diagnostics Test		
CWLEZ-RC	Optional Remote Capability		
CWLEZ-CW	Optional Cold Weather		



SPEC SERIES NEMA 4X COMBINATION LED EXIT SIGN & LED EMERGENCY, 120-277V



CATALOG NO.	NO. OF FACES/LETTER COLOR	VOLTAGE	WATTAGE	HOUSING COLOR	ITEMS DESCRIPTION
 XTCLN4X	1G 1R 2G 2R	6 6V 12 12V	12W 12W 15W 15W 28W 28W	W WHITE B BLACK G GRAY	6V, 15W, SINGLE FACE 6V, 28W, SINGLE FACE 12V, 15W, SINGLE FACE 12V, 28W, SINGLE FACE 6V, 12W, DOUBLE FACE 12V, 12W, DOUBLE FACE
SAMPLE ORDERING: XTCLN4X-1G-12-15W-W					

WET LOCATION COMBO LED EXIT & EMERGENCY SIGN, UNIVERSAL



CATALOG NO.	NUMBER OF FACES	LETTER COLOR	FACE COLOR	BATTERY
 XT-CLWP-RG-EM	Universal Single/Double	Red	White	NiCd
 XT-CLWP-GG-EM	Universal Single/Double	Green	White	NiCd

WET LOCATION COMBINATION LED EXIT SIGN & INCANDESCENT EMERGENCY, 120-277V, 11-3/4"(W) x 18-1/4"(H) x 3-3/4"(D)



CATALOG NO.	NUMBER OF FACES	LETTER COLOR	HOUSING	BATTERY
 XT-CWP-GG-EM	Single Face	Green	Gray	NiCd
XT-CWP-HTR	Optional Internal Heater			

LED 2-HEAD MINI EMERGENCY LIGHT, 120-277V, 4"(H) x 8 1/2"(W) x 1 3/4"(D)



CATALOG NO.	WATTS	HOUSING COLOR	MOUNTING	BATTERY
 EL-M2	1W(2)	White	Wall	3.6V NiCd
EL-M2-BK	1W(2)	Black	Wall	3.6V NiCd

LED 2-HEAD MINI EMERGENCY LIGHT, 120-277V, 4-1/4"(H) x 9-1/4"(W) x 1-3/5"(D)



CATALOG NO.	WATTS	HOUSING COLOR	MOUNTING	BATTERY	LUMEN
 EL-M1	1.1W(2)	White	Wall	3.6V Ni-MH	200LM
EL-M1-BK	1.1W(2)	Black	Wall	3.6V Ni-MH	200LM

BUILDER SERIES LED EMERGENCY LIGHTS, 120-277V, 13.7" W X 4.3" H X 3.5" D



CATALOG NO.	WATTS	HOUSING COLOR	MOUNTING	BATTERY
 EL-1	1W per Head	White	Wall & Ceiling	NiCd

SPEC SERIES LARGE LED EMERGENCY LIGHTS WITH HIGHER OUTPUT, 120-277V, 15.5" W X 5" H X 4.75" D



CATALOG NO.	WATTS	HOUSING COLOR	MOUNTING	BATTERY	
 EL-1L	1.2W per Head	White	Wall & Ceiling	NiCd	
EL-1L-BK	1.2W per Head	Black	Wall & Ceiling	NiCd	
EL-1L-RC	1.2W per Head	White	Wall & Ceiling	NiCd	Remote Capable

LED 2-HEAD DESIGNER EMERGENCY LIGHT, 120-277V, 4- 1/3"(H) x 13- 1/2"(W) x 3- 1/2"(D)



CATALOG NO.	WATTS	HOUSING COLOR	MOUNTING	BATTERY
 EL-1D	2.4W(2)	White	Wall	3.6V NiCd

BUILDER SERIES LED EMERGENCY LIGHTS, 120-277V, 4 5/8"(H) x 9 1/2"(W) x 2 1/4"(D)



CATALOG NO.	WATTS	HOUSING COLOR	MOUNTING	BATTERY
 EL-2A	1.2W per head	White	Wall & Ceiling	3.6V 1Ah NI-CAD

SPEC SERIES LED 2-HEAD HIGH-OUTPUT EMERGENCY LIGHT, 120-277V, 5"(H) x 12-1/2"(W) x 2-4/5"(D)



CATALOG NO.	WATTS	HOUSING COLOR	BATTERY	LUMEN
 EL-HO	3W(2)	White	Lead Acid	650LM

EXIT & EMERGENCY

LED 2-HEAD EXTRA HIGH-OUTPUT EMERGENCY LIGHT, 120-277V, 5"(H) x 12-1/2"(W) x 2-4/5"(D)



CATALOG NO.	WATTS	HOUSING COLOR	BATTERY	LUMENS
-------------	-------	---------------	---------	--------

EL-EHO 10W per Head **White** Lead Acid 1250LM



LED MR16 EMERGENCY LIGHTS, 120-277V, 3"(H) x 13-3/4"(W) x 5-1/8"(D)



CATALOG NO.	WATTS	HOUSING COLOR	MOUNTING	BATTERY
-------------	-------	---------------	----------	---------

EW-16-LED 3.3W per Head **White** Wall Lead Acid



HALOGEN MR16 EMERGENCY LIGHTS, 120-277V, 3"(H) x 13-3/4"(W) x 5-1/8"(D)



CATALOG NO.	WATTS	HOUSING COLOR	MOUNTING	BATTERY
-------------	-------	---------------	----------	---------

EW-16 7W per Head **White** Wall Lead Acid



WET LOCATION LED 2-HEAD EMERGENCY LIGHT, 120-277V 4-1/5"(H) x 12-1/4"(W) x 5-1/4"(D)



CATALOG NO.	WATTS	HOUSING COLOR	MOUNTING	BATTERY	LUMEN
-------------	-------	---------------	----------	---------	-------

EL-WP 6W(2) **White** Wall & Ceiling 6V Ni-MH 400LM



INDOOR SQUARE LED REMOTE HEADS, 120-277V



CATALOG NO.	WATTS	VOLTAGE	HOUSING COLOR	HEADS PER FIXTURE	
-------------	-------	---------	---------------	-------------------	--

EL-RH1 1W per Head 3.6V/6V/9.9V/12 DC White Single 6-3/8"(H) x 4-1/4"(W) x 4-1/4"(D)
EL-RH2 1W per Head 3.6V/6V/9.9V/12 DC White Double 6-3/4"(H) x 4-1/4"(W) x 10-3/8"(D)



WET LOCATION OUTDOOR SQUARE LED REMOTE HEADS, 120-277V



CATALOG NO.	WATTS	VOLTAGE	HOUSING COLOR	HEADS PER FIXTURE	
-------------	-------	---------	---------------	-------------------	--

EL-RH1-WP 1W per Head 3.6V/6V/9.9V/12 DC White Single 6-3/8"(H) x 4-1/4"(W) x 4-1/4"(D)
EL-RH2-WP 1W per Head 3.6V/6V/9.9V/12 DC White Double 6-3/4"(H) x 4-1/4"(W) x 10-3/8"(D)



WET LOCATION LED EMERGENCY LIGHTS

WITH REMOTE CAPABILITY, 120-277V, 6"(H) x 12-1/2"(W) x 8-1/2"(D)



CATALOG NO.	WATTS	HOUSING COLOR	MOUNTING	BATTERY
-------------	-------	---------------	----------	---------

LEDTFX-2 1.875W per Head **Gray** Wall NiCd
LEDTFX-2-B 1.875W per Head **Black** Wall NiCd



BUILDER SERIES ECONOMY OUTDOOR EMERGENCY WALL PACK

WITH PHOTOCELL, SELECTABLE 15-30W, 30/40K/50K, 120-277V 7 DAYS LEAD TIME



CATALOG NO.	DESCRIPTION
-------------	-------------

LESW-15-30W-MCTP-P-EM 15W/20W/30W 135LM/W 3000K/4000K/5000K Bronze

LESW-15-30W-MCTP-P-WH-EM 15W/20W/30W 135LM/W 3000K/4000K/5000K White



BUILDER SERIES DECORATIVE OUTDOOR

LED AC/EMERGENCY UNIT, 120-277V, 3-5/8"(H) x 10-1/2"(W) x 6-3/5"(D)



CATALOG NO.	WATTS	HOUSING COLOR	BATTERY	DESCRIPTION
DELW-15W-MCT-BK	15W	Black	NiCd	With Photocell
DELW-15W-MCT-BR	15W	Dark Bronze	NiCd	With Photocell
DELW-15W-MCT-WH	15W	White	NiCd	With Photocell

SPEC SERIES DECORATIVE OUTDOOR

LED AC/EMERGENCY UNIT, 120-277V, 3-5/8"(H) x 10-1/2"(W) x 6-3/5"(D)



CATALOG NO.	WATTS	HOUSING COLOR	BATTERY	DESCRIPTION
DBEL-ACEM-WH-SDT	12W	White	NiCd	With Photocell
DBEL-ACEM-BK-SDT	12W	Black	NiCd	With Photocell
DBEL-ACEM-BR-SDT	12W	Dark Bronze	NiCd	With Photocell
DBEL-ACEM-N-SDT	12W	Nickel	NiCd	With Photocell
DBEL-ACEM-WH-SDT-CW	12W	White	NiCd	With Cold Weather & Photocell
DBEL-ACEM-BK-SDT-CW	12W	Black	NiCd	With Cold Weather & Photocell
DBEL-ACEM-BR-SDT-CW	12W	Dark Bronze	NiCd	With Cold Weather & Photocell
DBEL-ACEM-N-SDT-CW	12W	Nickel	NiCd	With Cold Weather & Photocell

SPEC SERIES NEMA 4X OUTDOOR LED REMOTE HEADS, 120-277V, 4-7/8"(H) x 9-5/8"(W) x 5-1/2"(D)



CATALOG NO.	WATTS	VOLTAGE	HOUSING COLOR	HEADS	PER FIXTURE
RHN4X-1W	3.3W per Head	6V/12VDC	White	Single Square Head	Single Square Head
RHN4X-1B	3.3W per Head	6V/12VDC	Black	Double Square Head	Double Square Head
RHN4X-2W	3.3W per Head	6V/12VDC	White	Single Square Head	Single Square Head
RHN4X-2B	3.3W per Head	6V/12VDC	Black	Double Square Head	Double Square Head

SPEC SERIES NEMA 4X LED EMERGENCY LIGHTS, 120-277V



CATALOG NO.	WATTS	VOLTAGE	HOUSING COLOR	BATTERY
ELN4X-12-15W-B	15W	12V	Black	NiCd
ELN4X-12-15W-W	15W	12V	White	NiCd
ELN4X-12-36W-B	36W	12V	Black	NiCd
ELN4X-12-36W-W	36W	12V	White	NiCd
ELN4X-12-54W-B	54W	12V	Black	NiCd
ELN4X-12-54W-W	54W	12V	White	NiCd
ELN4X-6-15W-B	15W	6V	Black	NiCd
ELN4X-6-15W-W	15W	6V	White	NiCd
ELN4X-6-36W-B	36W	6V	Black	NiCd
ELN4X-6-36W-W	36W	6V	White	NiCd
ELN4X-6-54W-B	54W	6V	Black	NiCd
ELN4X-6-54W-W	54W	6V	White	NiCd

POLYCARBONATE VANDAL/ENVIRONMENTAL SHIELD GUARDS

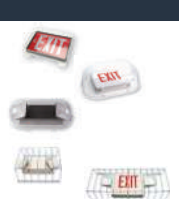

CATALOG NO.	DESCRIPTION
PCS-1	For use with most standard Exit signs
BG-1	For use with most standard Exit signs
BGR-1	For use with most standard Emergency lights
WG-1	Wire Guard, 13-3/4 X 15-1/4 X 6"
WG-3	Wire Guard, 13-3/4 X 30-1/4 X 6"



EMERGENCY BATTERY BACKUPS

CATALOG NO.	OUTPUT VOLTAGE	OUTPUT POWER	BATTERY	NOTES
ELB-0848	25-48V DC	8W MAX	Li-ion 2500mAh	8W SPLIT
ELB-1048-HH	25-48V DC	10W MAX	LifePO4 3000mAh	10W SPLIT HEAT TOLERANT
ELB-1248	25-48V DC	12W MAX	Li-ion 2500mAh	12W SPLIT
ELB-1548-HH	25-48V DC	15W MAX	LifePO4 3000mAh	15W SPLIT HEAT TOLERANT
ELB-2048	25-48V DC	20W MAX	Li-ion 4000mAh	20W SPLIT
ELB-0460-FM	10-60V DC	4W MAX	Li-ion 2500mAh	4W INTEGRATED
ELB-2048-EXTR	25-48V DC	20W MAX	Ni-MH 4000mAh	20W INTEGRATED
ELB-3048-FLEX	25-48V DC	30W MAX	Li-ion 4000mAh	30W INTEGRATED
ELB-0895	95V DC MAX	8W MAX	Ni-MH 2600mAh	8W INTEGRATED HIGH DC VOLTAGE
ELB-30150-FLEX	50-150V DC	30W MAX	Li-ion 4000mAh	30W INTEGRATED HIGH DC VOLTAGE
ELB-2048-IP65	25-48V DC	20W MAX	Li-ion 4000mAh	20W INTEGRATED IP65
ELB-20150-IP65	50-150V DC	20W MAX	Li-ion 4000mAh	20W INTEGRATED HIGH DC VOLTAGE IP65
ELB-20150	50-150V DC	20W MAX	Li-ion 4000mAh	20W INTEGRATED HIGH DC VOLTAGE
ELB-30250-FLEX	250V DC MAX	30W MAX	Li-ion 4000mAh	30W INTEGRATED HIGH DC VOLTAGE
ELB-08120-AC	120V AC	8W MAX	Li-ion	8W & AC VOLTAGE
ELB-08170-EXTR	170VDC	8W MAX	Li-ion	WITH FLEX
ELB-09120-AC	120V AC	9W MAX	Li-ion	9W & AC VOLTAGE
ELB-12120-AC	120V AC	12W MAX	Li-ion	12W & AC VOLTAGE
ELB-15120-AC	120V AC	15W MAX	Li-ion	15W & AC VOLTAGE
ELB-20175-AC-FLEX	175VDC	20W MAX	Li-ion 4000mAh	20W INTEGRATED
ELB-30175-AC-HB	50-150VDC	30W MAX	Li-ion	30W INTEGRATED
ELB-18150-B	50-150VDC	18W MAX	Li-ion	18W SPLIT
ELB-CW-18W-MW	COLD-WEATHER LED EMERGENCY BACKUP 18W MULTI-VOLTAGE INTERNAL			
ELB-CW-27W-MW	COLD-WEATHER LED EMERGENCY BACKUP 27W MULTI-VOLTAGE INTERNAL			
ELB-CW-27W-MW-IP66	COLD-WEATHER LED EMERGENCY BACKUP 27W MULTI-VOLTAGE INTERNAL, IP66			



FACTORY-INSTALLED OPTIONS, ENTER DESIRED OPTION CODE(S) AS LINE ITEMS ON YOUR PURCHASE ORDER UNDER THE PRODUCT CATALOG NUMBER

CATALOG NO.	DESCRIPTION
OPT-EM-CW2EXT	COLD-WEATHER EXTERNAL EMERGENCY POWER SUPPLY 27W FACTORY OPTION
OPT-EM-CW2INT	COLD-WEATHER INTERNAL EMERGENCY POWER SUPPLY 27W FACTORY OPTION
OPT-EM-CW1INT	COLD-WEATHER INTERNAL EMERGENCY POWER SUPPLY 18W FACTORY OPTION



ELECTRICAL PRODUCTS

ONE-GANG BOXES, 2" DEEP



	CATALOG NO.	DESCRIPTION	PKG. QTY.
	W1B50-3	1/2" trade size, 3 outlet holes, 18.3 cu. in.	20
	W1B50-3-WH	1/2" trade size, 3 outlet holes, 18.3 cu. in., white	20
	W1B50-3-BRZ	1/2" trade size, 3 outlet holes, 18.3 cu. in., bronze	20
	W1B75-3	3/4" trade size, 3 outlet holes, 18.3 cu. in.	20
	W1B75-3-WH	3/4" trade size, 3 outlet holes, 18.3 cu. in., white	20
	W1B75-3-BRZ	3/4" trade size, 3 outlet holes, 18.3 cu. in., bronze	20
	W1B100-3	1" trade size, 3 outlet holes, 18.3 cu. in.	20
	W1B50-4	1/2" trade size, 4 outlet holes, 18.3 cu. in.	20
	W1B50-4-WH	1/2" trade size, 4 outlet holes, 18.3 cu. in., white	20
	W1B50-4-BRZ	1/2" trade size, 4 outlet holes, 18.3 cu. in., bronze	20
	W1B75-4	3/4" trade size, 4 outlet holes, 18.3 cu. in.	20
	W1B75-4-WH	3/4" trade size, 4 outlet holes, 18.3 cu. in., white	20
	W1B75-4-BRZ	3/4" trade size, 4 outlet holes, 18.3 cu. in., bronze	20
	W1B50-5	1/2" trade size, 5 outlet holes, 18.3 cu. in.	20
	W1B50-5-WH	1/2" trade size, 5 outlet holes, 18.3 cu. in., white	20
W1B50-5-BRZ	1/2" trade size, 5 outlet holes, 18.3 cu. in., bronze	20	
W1B75-5	3/4" trade size, 5 outlet holes, 18.3 cu. in.	20	
W1B75-5-WH	3/4" trade size, 5 outlet holes, 18.3 cu. in., white	20	
W1B75-5-BRZ	3/4" trade size, 5 outlet holes, 18.3 cu. in., bronze	20	
W1B50-5X	1/2" trade size, 5 outlet holes, 18.3 cu. in.	20	
W1B75-5X	3/4" trade size, 5 outlet holes, 18.3 cu. in.	20	

ONE-GANG DEVICE COVERS DEEP









	CATALOG NO.	DESCRIPTION	PKG. QTY.
	W1BC	BLANK COVER	50
	W1BC-WH	BLANK COVER, white	50
	W1BC-BRZ	BLANK COVER, bronze	50
	W1BC-G	HEAVY DUTY GALVANIZED BLANK COVER - gray	50
	W1C-DV	DUPLEX, VERTICAL	25
	W1C-DV-WH	DUPLEX, VERTICAL, white	25
	W1C-DV-BRZ	DUPLEX, VERTICAL, bronze	25
	W1C-GV	GFCI, VERTICAL	25
	W1C-GV-WH	GFCI, VERTICAL - white	25
	W1C-GV-BRZ	GFCI, VERTICAL - Bronze	25
	W1C-P020	20A RECEPTACLE, 1.60" DIAMETER	25
	W1C-P030	30A RECEPTACLE, 1.75" DIAMETER	25
	W1C-P040	40-50A RECEPTACLE, 2.30" DIAMETER	25
	W1C-SV	SINGLE RECEPTACLE, VERTICAL	25
	W1C-SV-WH	SINGLE RECEPTACLE, VERTICAL, white	25
	W1C-SV-BRZ	SINGLE RECEPTACLE, VERTICAL, bronze	25
	W1C-SW	1 LEVER, VERTICAL, SWITCH NOT INCLUDED	25
	W1C-SW-WH	1 LEVER, VERTICAL, SWITCH NOT INCLUDED	25
W1C-SW-BRZ	1 LEVER, VERTICAL, SWITCH NOT INCLUDED	25	

ELECTRICAL













ONE-GANG DEVICE COVERS

CATALOG NO.	DESCRIPTION	PKG. QTY.
 W1C-TS	TOGGLE SWITCH, VERTICAL	25
 W1C-TS-WH	TOGGLE SWITCH, VERTICAL, white	25
 W1C-TS-BRZ	TOGGLE SWITCH, VERTICAL, bronze	25
 W1C-DH	DUPLEX, HORIZONTAL	25
 W1C-GH	GFCI, HORIZONTAL	25
 W1C-GH-WH	GFCI, HORIZONTAL - white	25
 W1C-GH-BRZ	GFCI, HORIZONTAL - bronze	25
 W1CL-DV	LOCKABLE 1 GANG W/P COVER 1 SI	25
 W1CL-GV	LOCKABLE 1 GANG W/P DEVICE COV	25
 W1CL-SV	LOCKABLE 1 GANG W/P COVER 1 SI	25
 W1C-SH	SINGLE RECEPTACLE HORIZONTAL	25

ONE-GANG BOXES | 2-5/8" DEEP

CATALOG NO.	DESCRIPTION	PKG. QTY.
 W1DB50-3	1/2" trade size, 3 outlet holes, 23.8 cu. in.	12
 W1DB75-3	3/4" trade size, 3 outlet holes, 23.8 cu. in.	12
 W1DB100-3	1" trade size, 3 outlet holes, 23.8 cu. in.	12
 W1DB50-4	1/2" trade size, 4 outlet holes, 23.8 cu. in.	12
 W1DB75-4	3/4" trade size, 4 outlet holes, 23.8 cu. in.	12
 W1DB50-5X	1/2" trade size, 5 outlet holes, 23.8 cu. in.	12
 W1DB75-5X	3/4" trade size, 5 outlet holes, 23.8 cu. in.	12
 W1DB100-5X	1" trade size, 5 outlet holes, 23.8 cu. in.	12

TWO-GANG STANDARD BOXES | 2" DEEP

CATALOG NO.	DESCRIPTION	PKG. QTY.
 W2B50-3	1/2" trade size, 3 outlet holes, 30.5 cu. in.	12
 W2B75-3	3/4" trade size, 3 outlet holes, 30.5 cu. in.	12
 W2B100-3	1" trade size, 3 outlet holes, 30.5 cu. in.	12
 W2B50-4	1/2" trade size, 4 outlet holes, 30.5 cu. in.	12
 W2B75-4	3/4" trade size, 4 outlet holes, 30.5 cu. in.	12
 W2B100-4	1" trade size, 4 outlet holes, 30.5 cu. in.	12
 W2B50-5	1/2" trade size, 5 outlet holes, 30.5 cu. in.	12
 W2B75-5	3/4" trade size, 5 outlet holes, 30.5 cu. in.	12
 W2B50-5X	1/2" trade size, 5 outlet holes, 30.5 cu. in.	12
 W2B75-5X	3/4" trade size, 5 outlet holes, 30.5 cu. in.	12
 W2B100-5X	1" trade size, 4 outlet holes, 30.5 cu. in.	12
 W2B50-6X	1/2" trade size, 6 outlet holes, 30.5 cu. in.	12
 W2B75-6X	3/4" trade size, 6 outlet holes, 30.5 cu. in.	12
W2B50-7	1/2" trade size, 7 outlet holes, 30.5 cu. in.	12
W2B75-7	3/4" trade size, 7 outlet holes, 30.5 cu. in.	12
W2B50-7X	1/2" trade size, 7 outlet holes, 30.5 cu. in.	12
W2B75-7X	3/4" trade size, 7 outlet holes, 30.5 cu. in.	12
W2B50-9	1/2" trade size, 9 outlet holes, 30.5 cu. in.	12
W2B75-9	3/4" trade size, 9 outlet holes, 30.5 cu. in.	12

TWO-GANG DEVICE COVERS

CATALOG NO.	DESCRIPTION	PKG. QTY.
 W2BC	2 GANG WEATHERPROOF BLANK COVE	25
W2BC-WH	2 GANG WEATHERPROOF BLANK COVE, white	25
W2BC-BRZ	2 GANG WEATHERPROOF BLANK COVE, bronze	25
W2C-2D	2 DUPLEX RECEPTACLES	12
W2BC-G	HEAVY DUTY GALVANIZED BLANK COVER	25
W2C-2G	2 GFCI RECEPTACLES	12
W2C-2S	2 SINGLE RECEPTACLES 1.406" DIAMETER	12
W2C-GD	1 GFCI & 1 DUPLEX RECEPTACLE	12
W2C-GS	1 GFCI & 1 SINGLE RECEPTACLE	12
W2C-SD	1 DUPLEX & 1 SINGLE RECEPTACLE 1.41" DIAMETER	12
W2C-SW	2 LEVERS + 2-15A SINGLE POLE SWITCHES -NOT INCLUDED	12
W2CL-P050	40-50A RECEPTACLE, 2.125" DIAMETER, LOCKABLE	12
W2CL-P060	60A RECEPTACLE, 2.468" DIAMETER, LOCKABLE	12
W2C-DH	OVER-SIZED DUPLEX, HORIZONTAL	12

SERVICE ENTRANCE CAPS

CATALOG NO.	DESCRIPTION	PKG. QTY.
 WC2-50	SERVICE ENTRANCE CAPS, DIE-CAS	15
WC2-75	SERVICE ENTRANCE CAPS, DIE-CAS	10
WC2-100	SERVICE ENTRANCE CAPS, DIE-CAS	7
WC2-125	SERVICE ENTRANCE CAPS, DIE-CAS	5
WC2-150	SERVICE ENTRANCE CAPS, DIE-CAS	4
WC2-200	SERVICE ENTRANCE CAPS, DIE-CAS	4
WC2-250	SERVICE ENTRANCE CAPS, DIE-CAS	1
WC2-300	SERVICE ENTRANCE CAPS, DIE-CAS	1
WC2-350	SERVICE ENTRANCE CAPS, DIE-CAS	1
WC2-400	SERVICE ENTRANCE CAPS, DIE-CAS	1

TWO-GANG DEEP BOXES | 2-5/8" DEEP

CATALOG NO.	DESCRIPTION	PKG. QTY.
 W2DB50-5	1/2" trade size, 5 outlet holes, 40.3 cu. in.	9
W2DB75-5	3/4" trade size, 5 outlet holes, 40.3 cu. in.	9
W2DB100-5	1" trade size, 5 outlet holes, 40.3 cu. in.	9
W2DB50-7X	1/2" trade size, 7 outlet holes, 40.3 cu. in.	9
W2DB75-7X	3/4" trade size, 7 outlet holes, 40.3 cu. in.	9
W2DB100-7X	1" trade size, 7 outlet holes, 40.3 cu. in.	9

TWO-GANG EXTENSION BOXES | 1-9/16" DEEP

CATALOG NO.	DESCRIPTION	PKG. QTY.
 W2XB50-6	1/2" trade size, 6 outlet holes, 15.0 cu. in.	9
W2XB75-6	3/4" trade size, 6 outlet holes, 15.0 cu. in.	9
W2XB50-8	1/2" trade size, 8 outlet holes, 15.0 cu. in.	9
W2XB75-8	3/4" trade size, 8 outlet holes, 15.0 cu. in.	9

THREE-GANG DEVICE COVER

CATALOG NO.	DESCRIPTION	PKG. QTY.
 W3BC	BLANK COVER	7
W3C-3D	3 DUPLEX RECEPTACLES	7
W3C-3G	3 GFCI RECEPTACLES	7
W3C-3S	3 SINGLE 1.41" DIAMETER RECEPTACLES	7

THREE-GANG DEEP BOXES | 2-5/8" DEEP

CATALOG NO.	DESCRIPTION	PKG. QTY.
 W3DB50-7	1/2" trade size, 7 outlet holes, 54.0 cu. in.	10
W3DB75-7	3/4" trade size, 7 outlet holes, 54.0 cu. in.	10
W3DB100-7	1" trade size, 7 outlet holes, 54.0 cu. in.	10

ROUND EXTENSION BOXES | 4" DEEP

	CATALOG NO.	DESCRIPTION	PKG. QTY.
	WRB50-5	1/2" trade size, 5 outlet holes, 15.8 cu. in.	16
	WRB50-5-WH	1/2" trade size, 5 outlet holes, 15.8 cu. in., white	16
	WRB50-5-BRZ	1/2" trade size, 5 outlet holes, 15.8 cu. in., bronze	16
	WRB75-5	3/4" trade size, 5 outlet holes, 54.0 cu. in	16

ROUND COVERS | 4" DEEP

	CATALOG NO.	DESCRIPTION	PKG. QTY.
	WRC-1	1/2" trade size, 1 outlet holes	25
	WRC-1-WH	1/2" trade size, 1 outlet holes, white	25
	WRC-1-BRZ	1/2" trade size, 1 outlet holes, bronze	25
	WRC-2	1/2" trade size, 2 outlet holes	25
	WRC-2-WH	1/2" trade size, 2 outlet holes, white	25
	WRC-2-BRZ	1/2" trade size, 2 outlet holes, bronze	25
	WRC-3	1/2" trade size, 3 outlet holes	25
	WRC-3-WH	1/2" trade size, 3 outlet holes, white	25
	WRC-3-BRZ	1/2" trade size, 3 outlet holes, bronze	25
		W4RBC	4" round blank cover with gasket

ONE-GANG RECTANGULAR COVERS

	CATALOG NO.	DESCRIPTION	PKG. QTY.
	WRE-1	1/2" trade size, 1 outlet holes	25
	WRE-1-WH	1/2" trade size, 1 outlet holes, white	25
	WRE-1-BRZ	1/2" trade size, 1 outlet holes, bronze	25
	WRE-2	1/2" trade size, 2 outlet holes	25
	WRE-2-WH	1/2" trade size, 2 outlet holes, white	25
	WRE-2-BRZ	1/2" trade size, 2 outlet holes, bronze	25
	WRE-3	1/2" trade size, 3 outlet holes	25
	WRE-3-WH	1/2" trade size, 3 outlet holes, white	25
	WRE-3-BRZ	1/2" trade size, 3 outlet holes, bronze	25

ONE-GANG EXTENSION BOXES | 1-3/8" DEEP

	CATALOG NO.	DESCRIPTION	PKG. QTY.
	WXB50-4	1/2" trade size, 4 outlet holes, 9.5 cu. in.	12
	WXB75-4	3/4" trade size, 4 outlet holes, 9.5 cu. in.	12
	WXB50-6	1/2" trade size, 6 outlet holes, 9.5 cu. in	12
	WXB75-6	3/4" trade size, 6 outlet holes, 9.5 cu. in.	12

ONE-GANG FLANGED EXTENSION BOXES | 1-9/16" DEEP

	CATALOG NO.	DESCRIPTION	PKG. QTY.
	WXF50-2	1/2" trade size, 2 outlet holes, 13.5 cu. in.	10
	WXF75-2	3/4" trade size, 2 outlet holes, 13.5 cu. in.	10
	WXF50-4	1/2" trade size, 4 outlet holes, 13.5 cu. in.	10
	WXF75-4	3/4" trade size, 4 outlet holes, 13.5 cu. in.	10
	WXF50-6	1/2" trade size, 6 outlet holes, 13.5 cu. in.	10
	WXF75-6	3/4" trade size, 6 outlet holes, 13.5 cu. in	10

ONE-GANG FLANGED EXTENSION RING | 1" DEEP

	CATALOG NO.	DESCRIPTION	PKG. QTY.
	WXR-1	1 GANG W/P EXTENSION RING	24
	WXR-2	2 GANG W/P EXTENSION RING	12
	WXR50-4	4" ROUND W/P EXT. BOX 4 1/2" H	16
	WXR75-4	4" ROUND W/P EXT. BOX 4 3/4" H	16
	WRC-GASKET	Universal 1-gang foam gasket	25

THREADED CONDUIT BODIES | LB SERIES

	CATALOG NO.	TRADE SIZE	LENGTH	WIDTH	HEIGHT	PKG. QTY.
	LB-50CG	1/2"	4-5/16"	1-5/16"	2-11/32"	10
	LB-75CG	3/4"	5-3/32"	1-9/16"	2-5/8"	10
	LB-100CG	1"	5-29/32"	1-13/16"	3"	5
	LB-125CG	1-1/4"	7-13/16"	2-1/2"	3-3/4"	2
	LB-150CG	1-1/2"	7-13/16"	2-1/2"	3-3/4"	2
	LB-200CG	2"	10-1/16"	3-3/16"	4-3/4"	1
	LB-250CG	2-1/2"	12-13/16" 12-	4-1/2"	5-9/16"	1
	LB-300CG	3"	13/16"	4-1/2"	6-5/32"	1
	LB-400CG	4"	15-5/8"	5-9/16"	7-9/16"	1

THREADED CONDUIT BODIES | LL SERIES

	CATALOG NO.	TRADE SIZE	LENGTH	WIDTH	HEIGHT	PKG. QTY.
	LL-50CG	1/2"	4-5/16"	2-1/32"	1-5/8"	10
	LL-75CG	3/4"	5-3/32"	2-5/16"	1-7/8"	10
	LL-100CG	1"	5-29/32"	2-11/16"	2-1/8"	5
	LL-125CG	1-1/4"	7-13/16"	3-1/2"	2-3/4"	2
	LL-150CG	1-1/2"	7-13/16"	3-1/2"	2-3/4"	2
	LL-200CG	2"	10-1/16"	4-9/32"	3-5/8"	1
	LL-250CG	2-1/2"	12-13/16" 12-	5-7/8"	4-1/4"	1
	LL-300CG	3"	13/16"	5-7/8"	4-3/4"	1
	LL-400CG	4"	15-5/8"	7-21/32"	5-7/8"	1

THREADED CONDUIT BODIES | LR SERIES

	CATALOG NO.	TRADE SIZE	LENGTH	WIDTH	HEIGHT	PKG. QTY.
	LR-50CG	1/2"	4-5/16"	2-1/32"	1-5/8"	10
	LR-75CG	3/4"	5-3/32"	2-5/16"	1-7/8"	10
	LR-100CG	1"	5-29/32"	2-11/16"	2-1/8"	5
	LR-125CG	1-1/4"	7-13/16"	3-1/2"	2-3/4"	2
	LR-150CG	1-1/2"	7-13/16"	3-1/2"	2-3/4"	2
	LR-200CG	2"	10-1/16"	4-9/32"	3-5/8"	1
	LR-250CG	2-1/2"	12-13/16" 12-	5-7/8"	4-1/4"	1
	LR-300CG	3"	13/16"	5-7/8"	4-3/4"	1
	LR-400CG	4"	15-5/8"	7-21/32"	5-7/8"	1

THREADED CONDUIT BODIES | C SERIES

	CATALOG NO.	TRADE SIZE	LENGTH	WIDTH	HEIGHT	PKG. QTY.
	C-50CG	1/2"	4-11/16"	1-5/16"	1-5/8"	10
	C-75CG	3/4"	5-1/2"	1-9/16"	1-7/8"	10
	C-100CG	1"	6-7/16"	1-13/16"	2-1/8"	5
	C-125CG	1-1/4"	8-3/8"	2-1/2"	2-3/4"	2
	C-150CG	1-1/2"	8-3/8"	2-1/2"	2-3/4"	2
	C-200CG	2"	10-9/16"	3-3/16"	3-5/8"	1
	C-250CG	2-1/2"	13-1/2"	4-1/2"	4-1/4"	1
	C-300CG	3"	13-1/2"	4-1/2"	4-3/4"	1
	C-400CG	4"	16-5/16"	5-9/16"	5-7/8"	1

THREADED CONDUIT BODIES | T SERIES

	CATALOG NO.	TRADE SIZE	LENGTH	WIDTH	HEIGHT	PKG. QTY.
	T-50CG	1/2"	4-11/16"	2-1/32"	1-5/8"	10
	T-75CG	3/4"	5-1/2"	2-5/16"	1-7/8"	10
	T-100CG	1"	6-7/16"	2-11/16"	2-1/8"	5
	T-125CG	1-1/4"	8-3/8"	3-1/2"	2-3/4"	2
	T-150CG	1-1/2"	8-3/8"	3-1/2"	2-3/4"	2
	T-200CG	2"	10-9/16"	4-9/32"	3-5/8"	1
	T-250CG	2-1/2"	13-1/2"	5-7/8"	4-1/4"	1
	T-300CG	3"	13-1/2"	5-7/8"	4-3/4"	1
	T-350CG	3-1/2"	16-5/16"	7-21/32"	5-7/8"	1
	T-400CG	4"	16-5/16"	7-21/32"	5-7/8"	1

THREADED CONDUIT BODIES | SLB SERIES

	CATALOG NO.	TRADE SIZE	LENGTH	WIDTH	HEIGHT	PKG. QTY.
	SLB-50	1/2"	3-9/32"	1-3/8"	1-5/8"	20
	SLB-75	3/4"	3-19/32"	1-9/16"	1-27/32"	20
	SLB-100	1"	4-5/16"	1-31/32"	2-1/8"	10

COVERS & GASKETS FOR THREADED CONDUIT BODIES

	CATALOG NO.	TRADE SIZE	LENGTH	WIDTH	HEIGHT	PKG. QTY.
	CG-50	1/2"	3-7/8"	1-5/16"	-	100
	CG-75	3/4"	4-11/16"	1-9/16"	-	50
	CG-100	1	5-3/8"	1-3/4"	-	50
	CG-125/150	1-1/4" &	7-5/16"	2-1/2"	-	25
	CG-200	1-1/2"	9-1/2"	3-1/8"	-	10
	CG-250/300	2"	12-1/16"	4-7/16"	-	10
	CG-350/400	2-1/2"	15-1/16"	5-9/2016"	-	5

LAMP HOLDERS

	CATALOG NO.	DESCRIPTION	PKG. QTY.
	LH150-1	STANDARD WEATHERPROOF LAMP HOLDER	20
	LH150-1-BRZ	STANDARD WEATHERPROOF LAMP HOLDER, white	12
	LH150-1-WH	STANDARD WEATHERPROOF LAMP HOLDER, bronze	12
	LH150-GASKET	Silicon Gasket For LH150	20

LAMP HOLDERS

	CATALOG NO.	DESCRIPTION	PKG. QTY.
	PL-50	CLOSE-UP PLUG 1/2" - 50 PER BA	500 per bag
	PL-50-BRZ	CLOSE-UP PLUG 1/2" - 50 PER BA, BRONZE	500 per bag
	PL-50-WH	CLOSE-UP PLUG 1/2" - 50 PER BA, WHITE	500 per bag
	PL-75	CLOSE-UP PLUG 3/4" - 50 PER BA	500 per bag
	PL-100	CLOSE-UP PLUG 1" - 50 PER BAG	200 per bag

PORCELAIN LAMP HOLDERS

	CATALOG NO.	DESCRIPTION	PKG. QTY.
	M507CW-UL	E26, PORCELAIN LAMPHOLDER WITH PULL CHAIN, 4 TERMINAL SCREWS, 660W/250V RATING, WHITE	48

PLASTIC LAMP HOLDERS

	CATALOG NO.	DESCRIPTION	PKG. QTY.
	M507C-UL	E26, BAKELITE KEYLESS LAMPHOLDER WITH 2 TERMINAL SCREWS, 660W/250V RATING, WHITE	108
	M507CW-UL	E26, BAKELITE LAMPHOLDER WITH PULL CHAIN, 2 TERMINAL SCREWS, 660W/250V RATING, WHITE	108

ANGLE PLUG, GENERAL PURPOSE CORDS | 125V-13A, GRAY

	CATALOG NO.	DESCRIPTION	PKG. QTY.
	GPA3-2	SPT-2 16AWG/ 3 CONDUCTOR, ANGLE PLUG, NEMA 5-15P, 125V, GRAY, 3FT	100
	GPA6-2	SPT-2 16AWG/ 3 CONDUCTOR, ANGLE PLUG, NEMA 5-15P, 125V, GRAY, 6FT	100
	GPA8-2	SPT-2 16AWG/ 3 CONDUCTOR, ANGLE PLUG, NEMA 5-15P, 125V, GRAY, 8FT	100

STRAIGHT PLUG, GENERAL PURPOSE CORDS | 125V-13A, GRAY

CATALOG NO.	DESCRIPTION	PKG. QTY.
 GPS3-2	SPT-2 16AWG/ 3 CONDUCTOR, STRAIGHT PLUG, NEMA 5-15P, 125V, GRAY, 3FT	100
GPS6-2	SPT-2 16AWG/ 3 CONDUCTOR, STRAIGHT PLUG, NEMA 5-15P, 125V, GRAY, 6FT	100
GPS8-2	SPT-2 16AWG/ 3 CONDUCTOR, STRAIGHT PLUG, NEMA 5-15P, 125V, GRAY, 8FT	100

STRAIGHT PLUG WITH VINYL INSULATION

CATALOG NO.	DESCRIPTION	PKG. QTY.
 EX123-100	Replacement Cords For Range Or Dryer	
EX143-50	Replacement Cords For Range Or Dryer	

DIRECTIONAL ARMORED GROUND CLAMP WITH STEEL SCREWS

CATALOG NO.	DESCRIPTION	PKG. QTY.
 MVP98	TRADE SIZE 1/2"- 1" WIRE SIZE 4-6-8	100

FEED-THROUGH ARMORED GROUND CLAMP WITH STEEL SCREWS

CATALOG NO.	DESCRIPTION	PKG. QTY.
 MVP99	TRADE SIZE 1/2"- 1" WIRE SIZE 4-6-8,	100

FEED-THROUGH ARMORED GROUND CLAMP WITH STEEL SCREWS

CATALOG NO.	DESCRIPTION	PKG. QTY.
 MVP94-50	1/2" FEED-THROUGH ARMORED GROUND CLAMP	100
MVP94-75	3/4" FEED-THROUGH ARMORED GROUND CLAMP	100

FEED-THROUGH ARMORED GROUND CLAMP WITH CABLE ADAPTOR

CATALOG NO.	DESCRIPTION	PKG. QTY.
 MVP99-360-1C	TRADE SIZE 1/2"- 1" WIRE SIZE 4-6-8, MASTER 80 WITH 1 ARMORED CABLE ADAPTOR	80
MVP99-360-2C	TRADE SIZE 1/2"- 1" WIRE SIZE 4-6-8, MASTER 80 WITH 2 ARMORED CABLE ADAPTOR	80

STEEL JACK CHAIN & FIXTURE HANGER

CATALOG NO.	DESCRIPTION	PKG. QTY.
 CH-1212	Steel jack chain, 100ft., 12GA, (Meets weight requirements for Linear High Bays)	
CH-1010	Steel jack chain, 100ft., 10GA	
FH-S	Side mount Steel fixture hangers, 10GA	
FH-E	End mount Steel fixture hangers, 10GA	
LH-SCREW	Steel flat hanger screw with single hole, 1/4" x 3"	

OCCUPANCY/VACANCY SENSORS

CATALOG NO.	DESCRIPTION	PKG. QTY.
 YM183-W	Occupancy PIR Sensor, 180°, 30FT (720FT), 120V 800/1200W max, Single Pole, Neutral Req.	
YM2108-W	Vacancy & Occupancy PIR Sensor, 180°, 30FT (720FT), 120V 800/1200W max, Single Pole, Neutral Req.	
YM2108-T-W	Vacancy & Occupancy PIR Sensor, 180°, 25FT (600FT), 120V 600/1000W max, 3-Way, Neutral Req.	

2 VERTICAL USB PORT 5V DC

CATALOG NO.	DESCRIPTION	PKG. QTY.
 USB2-15TR-WH	15A Receptacle W/2 USB Ports	
USB2-20TR-WH	20A Receptacle W/2 USB Ports	

FINAL PRODUCTION DEALS

"WHILE SUPPLIES LAST"

LED ADJUSTABLE CUTOFF WALL PACK, 120-277V

TYPE 2 LENS

Dark Bronze & White



CATALOG NO.	DESCRIPTION
LWA-20NW	20W 2200LM 4000K
LWA-30CW	30W 3200LM 5000K
LWA-30WW	30W 3000LM 3000K
LWA-50CW	50W 5200LM 5000K
LWA-50CW-WH	50W 5200LM 5000K
LWA-50WW-WH	50W 4900LM 3000K
LWA-80NW	80W 9000LM 4000K
LWA-120NW	120W 13700LM 4000K
LWA-120WW	120W 13700LM 5000K

LED CUTOFF WALL PACK, 120-277V



CATALOG NO.	DESCRIPTION
LWP2-50NW	50W 5500LM 4000K
LWP2-80CW	80W 9000LM 5000K

LED CUTOFF WALL PACK, 120-277V



CATALOG NO.	DESCRIPTION	REPLACEMENT RANGE
LWP-22CW	22W 2000LM 5000K	50-100 MH
LWP-30CW	30W 2800LM 5000K	100-125 MH
LWP-80CW	80W 7900LM 5000K	320-400 MH

LED ROTATABLE WALL PACKS, 120-277V

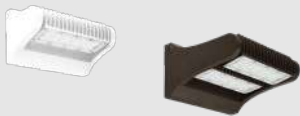
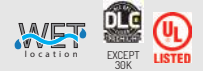

CATALOG NO.	DESCRIPTION
LW360-25W-50K-WH	25W 3375LM 5000K
LW360-40W-30K	40W 5400LM 3000K
LW360-40W-50K	40W 5400LM 5000K
LW360-60W-30K	60W 8100LM 3000K

LED NON-CUTOFF WALL PACK WITH GLASS LENS, 120-277V

Dark Bronze



CATALOG NO.	DESCRIPTION
WML-30CW-SM	30W 3200LM 5000K
WML-60CW	60W 6600LM 5000K
WML-60NW	60W 6400LM 4000K
WML-120WW-LG	120W 12000LM 3000K

LED NON-CUTOFF WALL PACKS, 120-277V



CATALOG NO.	DESCRIPTION
WML-HL-100W-30K	100W 14800LM 3000K
WML-HL-120W-30K	120W 17100LM 3000K
WML-HL-30W-30K	30W 4200LM 3000K
WML-HL-30W-40K	30W 4200LM 4000K
WML-HL-60W-30K	60W 8700LM 3000K
WML-HL-80W-30K	80W 11600LM 3000K
WML-HL-80W-50K	80W 11600LM 5000K

Items displayed in this sheet will no longer be reproduced.

FINAL PRODUCTION DEALS

"WHILE SUPPLIES LAST"

LED NON-CUTOFF WALL PACKS WITH DIRECTIONAL OPTIC LENS



CATALOG NO.	DESCRIPTION
WML2-28W-40K-HL-SM	28W 3640LM 4000K
WML2-28W-50K-HL-SM	28W 3780LM 5000K
WML2-28W-50K-HL-SM-D	28W 3780LM 5000K
WML2-50W-30K-HL	48W 6000LM 3000K
WML2-50W-30K-SM	50W 5500LM 3000K
WML2-50W-40K-HL	48W 6240LM 4000K
WML2-80W-30K-HL	80W 9750LM 3000K
WML2-80W-40K-HL	80W 10140LM 4000K

LED SEMI-CUTOFF VANDAL-PROOF WALL PACK, 120-277V



CATALOG NO.	DESCRIPTION
LTW-50WW	50W 4400LM 3000K

LED SMALL NON-CUTOFF WALL PACK WITH PHOTOCELL, 120V



CATALOG NO.	DESCRIPTION	REPLACEMENT RANGE	PKG. QTY.
LESW-12W-30K-P	12W 1225LM 3000K	50-70MH	6

LED FLOOD LIGHTS, 120-277V



CATALOG NO.	DESCRIPTION	EQUIVALENCY	PKG. QTY.
LF-WH20-CW	20W 1800LM 5000K	70 MH	8

LF2 ARCHITECTURAL FLOOD LIGHTS, 120-277V



CATALOG NO.	DESCRIPTION	REPLACEMENT RANGE	PKG. QTY.
LF2-10CW-TR	10W 942LM 5000K TRUNNION	90-100 MH	8
LF2-10WW-TR	10W 900LM 3000K TRUNNION	90-100 MH	

12V LED GARDEN LIGHT



CATALOG NO.	DESCRIPTION
LF12-6CW	6W 450LM 5000K
LF12-6NW	6W 450LM 4000K

LED FLOOD LIGHTS LF3 SERIES w/ SLIP FITTER, 120-277V

Dark Bronze



CATALOG NO.	DESCRIPTION	REPLACEMENT RANGE
LF3-80WW-SF	80W 9600LM 3000K	150-250 MH
LF3-220WW-SF	220W 22000LM 3000K	350-400 MH
LF3-300WW-SF	300W 30800LM 3000K	1000 MH

LED FLOOD LIGHTS SERIES LF3

WITH BOTTOM YOKE (Incl.) & other MOUNTING OPTIONS (SEE BELOW)



CATALOG NO.	DESCRIPTION	REPLACEMENT RANGE
LF3-80WW-YK	80W 9600LM 3000K	150-250 MH
LF3-150WW-YK	150W 15500LM 3000K	320-400 MH
LF3-220WW-YK	220W 22000LM 3000K	350-400 MH
LF3-300WW-YK	300W 30800LM 3000K	1000 MH

Items displayed in this sheet will no longer be reproduced.

FINAL PRODUCTION DEALS

"WHILE SUPPLIES LAST"

MOUNTING ACCESSORIES FOR LF3 SERIES

CATALOG NO.	DESCRIPTION	PKG. QTY.
LF3-EXTARM	Straight Extension Arm For Shoe Box Application, W/ K/O To Install PC Or Sensor (LF3-80-300)	6
LF3-STR	Street Light Arm 6" Long With 20" Wire And Strain Relief Connector (LF3-80-300)	6
LF3-SF	Adjustable Slip Fitter For Pole Mount 2"-2-1/2", W/ K/O To Install PC Or Sensor (LF3-80-300)	6
LF3-PK	Photocell Kit For LF3-80W, 100W, 150W Field Installed	
LF3-WG3	WIRE GUARD FOR LF3-HL-80W/100W/150W	
LF3-WG4	WIRE GUARD FOR LF3-HL-230W	
LF3-WMA	WALL MOUNTING PLATE FOR LF3 AND LF3-HL SERIES	



ACCESSORIES FOR LF3 HL CSERIES

CATALOG NO.	DESCRIPTION
LF3-EXTARM	STRAIGHT EXTENSION ARM FOR SHOE BOX APPLICATION, WITH K/O TO INSTALL PC OR
LF3-HL-ASA	ADJUSTABLE STRAIGHT ARM FOR LF3-HL SERIES
LF3-HL-EXT	STRAIGHT EXTENSION ARM FOR SHOE BOX APPLICATION
LF3-HL-PMR1	ROUND POLE MOUNT FOR LF3-HL-80W/100W/150W
LF3-HL-PMR2	ROUND POLE MOUNT FOR LF3-HL-300W
LF3-HL-PMS1	SQUARE POLE MOUNT FOR LF3-HL-80W/100W/150W
LF3-HL-RSF	ROUND SLIP FITTER FOR LF3-HL SERIES
LF3-HL-SF	ADJUSTABLE SLIP FITTER FOR POLE MOUNT
LF3-HL-TR-230/300W	U BRACKET FOR LF3-HL-230W&300W
LF3-HL-TR-80/100/150W	U BRACKET FOR LF3-HL-80W,100W, AND 150W.
LF3-HL-TYPEIV-100W	TYPE 4 LENS FOR LF3-HL SERIES 100W (ORDER 2)
LF3-HL-YK-100W/150W/230W	ADJUSTABLE U SHAPE YOKE MOUNT FOR LF3-HL-100W/150W/230W
LF3-HL-YK-300W	ADJUSTABLE U SHAPE YOKE MOUNT FOR LF3-HL-300W

ECONOMY FLOOD/AREA LIGHT SERIES TYPE 3 LENSES



CATALOG NO.	DESCRIPTION
LFCO-80W-40K	80W 10800LM 4000K
LFCO-80W-50K	80W 10800LM 5000K
LFCO-100W-50K	100W 14000LM 5000K
LFCO-150W-40K	150W 19900LM 4000K
LFCO-150W-50K	150W 19900LM 5000K
LFCO-230W-50K	230W 30100LM 5000K
LFCO-300W-40K	300W 41000LM 4000K
LFCO-300W-50K	300W 41000LM 5000K
LFCO-TR1	"U" Bracket For 80W 100W 150W
LFCO-TR2	"U" Bracket For 300W
LFCO-YK	Yoke for LFCO



LED ARCHITECTURAL FLOOD LIGHTS LF4 SERIES, 120V-277V



CATALOG NO.	DESCRIPTION
LF4-50CW-KN	50W 5600LM 5000K
LF4-50WW-KN	50W 5400LM 3000K
LF4-30WW-TR	30W 3100LM 3000K
LF4-50WW-TR	50W 5400LM 3000K
LF4-80CW-TR	80W 9500LM 5000K
LF4-80CW-SF	80W 9500LM 5000K
LF4-80WW-SF	80W 9500LM 3000K



FINAL PRODUCTION DEALS

"WHILE SUPPLIES LAST"

LED FLOOD LIGHT LF5 380W



CATALOG NO.	DESCRIPTION
 LF5-380CW-480V	380W 4600LM 5000K

LED BULLET FLOOD LIGHTS w/ 1/2" KNUCKLE (1st Gen.)



CATALOG NO.	DESCRIPTION	REPLACEMENT RANGE	PKG. QTY.
 FLD-12WW-WH	12W 800LM 3000K WHITE	100 PAR	6
FLD-30CW-WH	30W 2500LM 5000K WHITE	70-100 MH	6
FLD-30WW-WH	30W 2450LM 3000K WHITE	70-100 MH	6
FLD-30CW-GRN	30W 2500LM 5000K GREEN	70-100 MH	6

HIGH-OUTPUT SECURITY LIGHTS with 240° PIR SENSOR, 120V, IP65, 120° BEAM ANGLE



CATALOG NO.	DESCRIPTION	EQUIVALENCY	PKG. QTY.
 SLB-312-30K-P	3 X 12W 3 x 1050LM 3000K BRONZE	100 MH	8

DIMMABLE SECURITY LIGHTS



CATALOG NO.	DESCRIPTION
 SL-28W-30K-BZ-D	28W 3400LM 3000K
SL-28W-30K-WH-D	28W 3400LM 3000K
SL-28W-50K-WH-D	28W 3400LM 5000K
SL-30W-30K-BZ-D	30W 2800LM 3000K
SL-30W-30K-WH-D	30W 2800LM 3000K
SL-30W-50K-BZ-D	30W 2800LM 5000K
SL-30W-50K-WH-D	30W 2800LM 5000K
SL-40W-30K-BZ-D	40W 4800LM 3000K
SL-40W-50K-BZ-D	40W 4800LM 5000K

PHOTOCELL SECURITY LIGHTS



CATALOG NO.	DESCRIPTION
 SL-28W-30K-BZ-P	28W 3400LM 3000K
SL-28W-30K-WH-P	28W 3400LM 3000K
SL-28W-50K-BZ-P	28W 3400LM 5000K
SL-28W-50K-WH-P	28W 3400LM 5000K
SL-30W-30K-BZ-P	30W 2800LM 3000K
SL-30W-30K-WH-P	30W 2800LM 3000K
SL-30W-50K-BZ-P	30W 2800LM 5000K
SL-30W-50K-WH-P	30W 2800LM 5000K

LED RESIDENTIAL LANTERNS



CATALOG NO.	DESCRIPTION
 LRS-B-40K-PC	6W 550LM 4000K
LRS-C-30K-D	12W 1100LM 3000K
LRS-C-40K-D	12W 1100LM 4000K
LRS-D-30K-D	12W 1100LM 3000K
LRS-D-40K-D	12W 1100LM 4000K

FINAL PRODUCTION DEALS

"WHILE SUPPLIES LAST"

CREST ENGINES



CATALOG NO.	DESCRIPTION
CRE-EGN-40K-BR	10W(2.5Wx4) 900LM 4000K
CRE-EGN-50K-BR	10W(2.5Wx4) 900LM 5000K
CRE-EGN-HL20-30K-BR	20W(5Wx4) 1800LM 3000K
CRE-EGN-HL20-30K-SIL	20W(5Wx4) 1800LM 3000K



4" CYLINDER LIGHTS, 120V, IP65



CATALOG NO.	DESCRIPTION
WMC-DL-15W-50K-BN	15W 1144LM 5000K
WMC-DL-15W-50K-BR	15W 1144LM 5000K
WMC-UDL-20W-30K-BN	20W 1667LM 3000K
WMC-UDL-20W-30K-BR	20W 1667LM 3000K
WMC-UDL-20W-50K-BN	20W 1667LM 5000K
WMC-UDL-20W-50K-BR	20W 1667LM 5000K



LED DECORATIVE WALL SCNCE, 120V



CATALOG NO.	DESCRIPTION
LDS-12W-30K-D	12W 1200LM 3000K



DUSK-TO-DAWN AREA LIGHT WITH NEMA TWIST-LOCK PHOTOCELL



CATALOG NO.	DESCRIPTION
LR2-50CW-P	50W 5050LM 5000K
LR2-50NW-P	50W 5050LM 4000K

LR ECO ARM



CATALOG NO.	DESCRIPTION
LR-ECO-ARM	90° Arm for LR-ECO Series.(Mounting Strap Incl.)



LED STREET/ROADWAY LIGHTS_w/NEMA TWIST-LOCK PHOTOCELL SOCKET, (SHORTING CAP INCL.)



CATALOG NO.	DESCRIPTION
STL2-30W-30K	30W 3900LM 3000K
STL2-30W-50K	30W 3900LM 5000K
STL2-80W-30K	80W 10800LM 3000K
STL2-80W-50K	80W 10800LM 5000K
STL2-150W-30K	150W 21000LM 3000K
STL2-150W-50K	150W 21000LM 5000K
STL2-200W-30K	200W 27000LM 3000K
STL2-200W-50K	200W 27000LM 5000K
STL3-50W-30K-L	50W 6750LM 3000K

STADIUM LIGHTS, 120-277V



CATALOG NO.	DESCRIPTION
SFX-G5-600W-30D-50K	600W 90000LM 5000K
SFX-G5-RB	ROTATABLE BASE FOR SFX SERIES
SFX-G5-SF	SLIP FITTER FOR SFX SERIES
SFX-G5-SH1	SHROUD FOR 600W - FOR SFX SERIES
SFX-G5-SH2	SHROUD FOR 1000W - FOR SFX SERIES

FINAL PRODUCTION DEALS

"WHILE SUPPLIES LAST"

LED GAS STATION/CANOPY LIGHT, 120-277V



CATALOG NO.	DESCRIPTION	REPLACEMENT RANGE	PKG. QTY.
GS-CANOPY-150W-50K	150W 20558LM 5000K	250-400 MH	1
GS-CANOPY-SMB	GS Surface Mounting Shoe Box		-



BOLLARD ROUND FROSTED LENS ACCESSORY

CATALOG NO.	DESCRIPTION
BOL-R-ACC-FL	BOLLARD ROUND FROSTED LENS ACCESSORY

MOTION SENSORS FOR OUTDOOR

CATALOG NO.	DESCRIPTION
WEC-2P-44	0-10V PIR 6-24VDC TROFFER SENSOR DIP
WEC-3MDR-42	0-10V MW 120-277V SENSOR DIP & RC
WEC-3MR-4-BR	90-DEGREE IP67 MICROWAVE SENSOR, REMOTE CAPABLE, BRONZE
WEC-3MR-4-WH	90-DEGREE IP67 MICROWAVE SENSOR, REMOTE CAPABLE, WHITE
WEC-3MRLV-5-GY	0-10V MW LOW-VOLTAGE DIMMER WITH REMOTE DRIVER 120-277V REMOTE CAPABLE - GRAY
WEC-3MRLV-5-WH	0-10V MW LOW-VOLTAGE DIMMER WITH REMOTE DRIVER 120-277V REMOTE CAPABLE - WHITE
WEC-3PDR-52	0-10V PIR 120-277V SENSOR DIP & RC
WEC-3PDR-52CAP-BR	REPLACEMENT CAP WITH LENS FOR BRI823 BRONZE TO MATCH COLOR OF LIGHTS
WEC-ON50-WH	SENSOR MOUNTING OFFSET NIPPLE, 1/2 INCH SIZE , WHITE



LED HIGH-LUMEN UFO HIGH BAY, 110° BEAM ANGLE- HOOK WITH 3/4" THREAD



CATALOG NO.	DESCRIPTION
ULHB-100W-40K	100W 13000LM 4000K
ULHB-100W-50K-480V	100W 13000LM 5000K
ULHB-150W-40K	150W 19500LM 4000K
ULHB-240W-40K	240W 31200LM 4000K
ULHB-240W-50K	240W 31200LM 5000K
ULHB-240W-50K-480V	240W 31200LM 5000K
ULHB-90KIT-200/240	90 Degree Reflector and Glass Kit for 200W & 240W (Conversion from default 110° beam angle)
ULHB-ALR-100/150	Aluminum Reflector for 100W & 150W
ULHB-ALR-200/240	Aluminum Reflector for 200W & 240W
ULHB-EMK	Emergency Battery Backup Kit for 120-277V UFO High Bays (All wattages)
ULHB-FL-200/240	FROSTED LENS FOR ULHB 200-240W
ULHB-FL-50/100/150	FROSTED LENS FOR ULHB 50-150W
ULHB-PCC-100/150	Polycarbonate Cover for 100W & 150W (for ULHB-PCR-100/150 only) - Increases heat captured
ULHB-PCC-200/240	Polycarbonate Cover for 200W & 240W (for ULHB-PCR-200/240 only) - Increases heat cap-
ULHB-PCR-100/150	Polycarbonate Reflector for 100W & 150W
ULHB-SC-100/150	Safety Cable for 100W & 150W
ULHB-SC-200/240	Safety Cable for 200W & 240W
ULHB-SK	Ultrasonic Bi-Level (Dimming) Motion Sensor Kit for 120-277V UFO High Bays
ULHB-SK-480V	Ultrasonic Bi-Level (Dimming) Motion Sensor Kit for 480V UFO High Bays
ULHB-SMB-100/150	Surface Mount Bracket for 100W & 150W
ULHB-SMB-200/240	Surface Mount Bracket for 200W & 240W
ULHB-WG-100/150	Wire Guard for 100W & 150W
ULHB-WG-200/240	Wire Guard for 200W & 240W



FINAL DEALS

FINAL PRODUCTION DEALS

"WHILE SUPPLIES LAST"

LED SATURN ARCHITECTURAL HIGH BAY



CATALOG NO.	DESCRIPTION
USHB-150W-40K	150W 19500LM 4000K
USHB-200W-40K	200W 26000LM 4000K
USHB-200W-50K	200W 26000LM 5000K

LED FOOD SERVICE & LABORATORY HIGH BAY



CATALOG NO.	DESCRIPTION
UFHB-150W-50K	150W 20250LM 5000K

LED LINEAR VAPOR LIGHT



CATALOG NO.	DESCRIPTION
LLVT-4FT-40W-40K-D	40W 5000LM 4000K
LLVT-4FT-40W-50K-D	40W 5000LM 5000K
LLVT-8FT-65W-40K-D	65W 8450LM 4000K
LLVT-8FT-68W-40K-D	68W 8840LM 4000K
LLVT-8FT-68W-50K-D	68W 8840LM 5000K
LLVT-4FT-75W-50K-D	75W 9375LM 5000K
LLVT-4FT-150W-40K-D	150W 20250LM 4000K
LLVT-4FT-150W-50K-D	150W 20250LM 5000K
LLVT-4FT-150W-MCT-D	150W 20250LM 35K/40K/50K

SPEC SERIES 4TH GENERATION OF LINEAR HIGH BAYS

CATALOG NO.	DESCRIPTION
LLHB-CL-120/180	CLEAR LENS FOR LLHB 120W & 180W
LLHB-OC-REMOTE	INDOOR HIGHBAY OCCUPANCY SENSOR WITH BI-LEVEL DIMMING - NEEDS LLHB-OC-REMOTE TO CHANGE SETTINGS

SPEC SERIES 4TH GENERATION OF LINEAR HIGH BAYS, 480V



CATALOG NO.	DESCRIPTION
LLHB4-100W-50K-D	100W 15500LM 5000K
LLHB4-200W-50K-D	200W 31000LM 5000K

HIGH-LUMEN LED CORN LAMP WITH UP LIGHT, 100-277V AC



CATALOG NO.	DESCRIPTION
CL-HL-18W-50K-E26	18W 2340LM 5000K E26
CL-HL-27W-30K-E26	27W 3510LM 3000K E26
CL-HL-36W-50K-E39	36W 4680LM 5000K E39
CL-HL-45W-30K-E39	45W 5850LM 3000K E39
CL-HL-45W-50K-E39	45W 5850LM 5000K E39
CL-HL-54W-30K-E39	54W 7020LM 3000K E39
CL-HL-54W-50K-E39	54W 7020LM 5000K E39
CL-HL-75W-30K-E39	75W 9750LM 3000K E39
CL-HL-75W-50K-E39	75W 9750LM 5000K E39
CL-HL-125W-50K-E39-NRW	125W 16250LM 5000K E39



FINAL DEALS

FINAL PRODUCTION DEALS

"WHILE SUPPLIES LAST"

LED HIGH POWER LAMPS, 120-277V



	CATALOG NO.	DESCRIPTION	PKG. QTY.
	HPL-16W-30K-E26	16W 2000LM 3000K E26 Medium Base	20
	HPL-16W-50K-E26	16W 2000LM 5000K E26 Medium Base	20
	HPL-24W-30K-E26	24W 3000LM 3000K E26 Medium Base	20
	HPL-HB-60W-50K-E39	60W 6480LM 5000K E39 Mogul Base	4
	HPL-HB-75W-50K-E39	75W 8100LM 5000K E39 Mogul Base	4
	HPL-HB-100W-50K-E39	100W 12500LM 5000K E39 Mogul Base	4
	HPL-HB-140W-50K-E39	140W 15120LM 5000K E39 Mogul Base	4
	HPL-HB-R1	Optional PC Reflector for HPL-HB-60W	12
	HPL-HB-R3	Optional PC Reflector for HPL-HB-120W & HPL-HB-140W	8

LED BACKLIT PANEL LIGHT, 100-277VAC



	CATALOG NO.	DESCRIPTION	PKG. QTY.
	LPNG-2X2-4KLM-35K-D	40W 4200LM 3500K	4
	LPNG-2X2-4KLM-27K-D	40W 3800LM 2700K	4
	LPNG-2X2-MCTP	20/30/40W 3500K/4000K/5000K	4
	LPNG-2X4-4KLM-50K-D	40W 4200LM 5000K	4
	LPNG-2X4-5KLM-50K-D	50W 5250LM 5000K	4
	LPNG-2X4-5KLM-40K-D	50W 5200LM 4000K	4
	LPNG-2X4-5KLM-35K-D	50W 5140LM 3500K	4
	LPNG-2X4-5KLM-27K-D	50W 4800LM 2700K	4
	LPNG-2X4-7KLM-27K-D	60W 6500LM 2700K	4
	LPNG-1X4-4KLM-27K-D	40W 3800LM 2700K	4

LED PANEL LIGHTS



	CATALOG NO.	DESCRIPTION
	LP-1X4-45W-40K-D	45W 5175LM 4000K
	LP-1X4-45W-50K-D	45W 5175LM 5000K
	LP-2X2-45W-35K-D	45W 5175LM 3500K
	LP-2X2-45W-40K-D	45W 5175LM 4000K
	LP-2X2-45W-50K-D	45W 5175LM 5000K
	LP-2X4-60W-35K-D	60W 6900LM 3500K
	LP-2X4-60W-40K-D	60W 6900LM 4000K
	LP-2X4-60W-50K-D	60W 6900LM 5000K

PREMIUM HIGH-OUTPUT LED PANELS, 125LM/W



	CATALOG NO.	DESCRIPTION
	LP-2X4-50W-40K-D-HL	50W 6260LM 4000K
	LP-2X4-50W-50K-D-HL	50W 6260LM 5000K

LED PANEL LIGHTS (2X2 & 2X4)- MULTI WATTAGE, 110LM/W

	CATALOG NO.	DESCRIPTION
	LP-2X2-MW-40K-DS	30W,35W,40W,50W N/A 4000K
	LP-2X4-MW-35K-DS	30W,35W,40W,50W N/A 3500K
	LP-2X4-MW-40K-DS	30W,35W,40W,50W N/A 4000K

FINAL PRODUCTION DEALS

"WHILE SUPPLIES LAST"

LED PANEL LIGHTS WITH EMERGENCY BATTERY BACKUP



CATALOG NO.	DESCRIPTION
 LP-1X4-40W-40K-DS-EM	40W 4400LM 4000K
 LP-1X4-40W-50K-DS-EM	40W 4400LM 5000K
 LP-2X2-40W-40K-DS-EM	40W 4400LM 4000K
 LP-2X2-40W-50K-DS-EM	40W 4400LM 5000K
 LP-2X4-60W-40K-DS-EM	60W 6600LM 4000K

LED PANEL LIGHTS



CATALOG NO.	DESCRIPTION
 LP-1X4-40W-27K-DS	40W 3600LM 2700K
 LP-2X2-40W-35K-DS	40W 4200LM 3500K
 LP-2X2-40W-40K-DS	40W 4400LM 4000K
 LP-2X2-40W-50K-DS	40W 4400LM 5000K
 LP-2X4-60W-27K-DS	60W 5400LM 2700K
 LP-2X4-60W-35K-DS	60W 6300LM 3500K
 LP-2X4-60W-40K-DS	60W 6600LM 4000K
 LP-2X4-60W-50K-DS	60W 6600LM 5000K
 LP-2X4-72W-27K-DS	72W 6480LM 2700K
 LP-2X4-72W-35K-DS	72W 7560LM 3500K
 LP-2X4-72W-40K-DS	72W 7920LM 4000K

SINGLE CCT T-BAR GRID LIGHTS



CATALOG NO.	DESCRIPTION
 TGL-2X4-30K	60W 6000LM 3000K

INTERNAL-DRIVER LED SURFACE MOUNT PANELS, (1X4 & LARGER CAN BE RECESS MOUNTED)



CATALOG NO.	DESCRIPTION	PKG. QTY.	
 LPS-1X4-50K-D	40W 4000LM 5000K 1' X 4'	120-277VAC	1
 LPS-1X4-40K-D	40W 4000LM 4000K 1' X 4'	120-277VAC	1
 LPS-2X2-50K-D	40W 4400LM 5000K 2' X 2'	120-277VAC	1
 LPS-2X4-50K-D	50W 5500LM 5000K 2' X 4'	120-277VAC	1
 LPS-2X4-40K-D	50W 5500LM 4000K 2' X 4'	120-277VAC	1

DURABLE (PC BODY) TROFFER LIGHTS, 140LM/W



CATALOG NO.	DESCRIPTION
 LTRP-2X2-35W-40K-D	35W 4900LM 4000K
 LTRP-2X2-35W-50K-D	35W 4900LM 5000K
 LTRP-2X4-50W-50K-D	50W 6850LM 5000K

LED DIRECT-INDIRECT (METAL HOUSING+PC LENS) TROFFERS



CATALOG NO.	DESCRIPTION
 LTR-2X4-50W-40K-D	50W 5590LM 4000K
 LTR-SRFC-2X4	SURFACE MOUNTING KIT FOR 2X4 TROFFER

FINAL PRODUCTION DEALS

"WHILE SUPPLIES LAST"

HIGH LUMEN LED RETROFIT BASKET TROFFER



CATALOG NO.	DESCRIPTION
LRT-HL-2X2-40W-40K-D	40W 5200LM 4000K
LRT-HL-2X4-50W-40K-D	50W 6500LM 4000K



SCX LINEAR SERIES



CATALOG NO.	DESCRIPTION
SCX-2FT-20W-30K-D	20W 2240LM 3000K
SCX-2FT-20W-35K-D	20W 2300LM 3500K
SCX-2FT-20W-40K-D	20W 2360LM 4000K
SCX-2FT-20W-50K-D	20W 2420LM 5000K
SCX-3FT-30W-30K-D	30W 3360LM 3000K
SCX-6FT-60W-35K-D	60W 6900LM 3500K
SCX-6FT-60W-50K-D	60W 7260LM 5000K
SCX-8FT-80W-30K-D	80W 8960LM 3000K
SCX-8FT-80W-35K-D	80W 9200LM 3500K
SCX-ULM-8FT-32W-50K	UPLIGHT FOR SCX
SCX-T-40K	SCX SERIES T SECTION 40K



LED PARABOLIC SUSPENDED LIGHT



CATALOG NO.	DESCRIPTION
SCLP-4FT-40W-35K-D	40W 4600LM 3500K
SCLP-4FT-40W-40K-D	40W 4600LM 4000K
SCLP-4FT-40W-50K-D	40W 4600LM 5000K
SCLP-UD-4FT-60W-35K-D	40W/20W 4400LM/2100LM 3500K
SCLP-UD-4FT-60W-40K-D	40W/20W 4400LM/2100LM 4000K
SCLP-UD-4FT-60W-50K-D	40W/20W 4400LM/2100LM 5000K

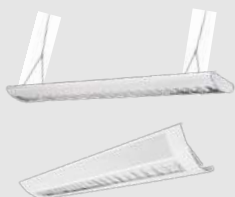

LED PARABOLIC SUSPENDED LIGHT



CATALOG NO.	DESCRIPTION
SCLT-4FT-40W-35K-D	40W 4600LM 3500K
SCLT-4FT-40W-40K-D	40W 4600LM 4000K
SCLT-4FT-40W-50K-D	40W 4600LM 5000K



LED SUSPENDED UP/DOWN CLEAR PANEL LIGHT, 120-277V (SUSPENSION & CORD NOT INCL.)



CATALOG NO.	DESCRIPTION
SPL-4FT-40W-35K-D	40W 2100LM/2100LM 3500K
SPL-4FT-40W-40K-D	40W 2100LM/2100LM 4000K
SPL-4FT-40W-50K-D	40W 2100LM/2100LM 5000K



LED SUSPENDED UP/DOWN CLEAR ROUND PANEL LIGHT, 22" DIA., 6FT HEIGHT



CATALOG NO.	DESCRIPTION
SRPL-40W-35K-D	40W 2100LM/2100LM 3500K
SRPL-40W-40K-D	40W 2100LM/2100LM 4000K
SRPL-40W-50K-D	40W 2100LM/2100LM 5000K



FINAL DEALS

FINAL PRODUCTION DEALS

"WHILE SUPPLIES LAST"

LED ARCHITECTURAL ROUND SUSPENDED DOWN LIGHT, 24" DIA, 6FT HEIGHT



CATALOG NO.	DESCRIPTION
SCR-24D-40K-D	50W 5197LM 4000K
SCR-24D-50K-D	50W 5267LM 5000K



ADJ. 6FT 1/16in DOUBLE SUSPENSION KIT

CATALOG NO.	DESCRIPTION
SCL-CSY	ADJ. 6FT 1/16in DOUBLE SUSPENSION KIT WITH Y DOUBLE KEY HOLE CONNECTORS, CANOPIES, T-BAR CLIPS, ACCESSORIES



SPEC SERIES LED ARCHITECTURAL WRAP-AROUND LIGHT



CATALOG NO.	DESCRIPTION
WA-2FT-25W-35K-D	25W 2750LM 3500K
WA-2FT-25W-40K-D	25W 2750LM 4000K
WA-2FT-25W-50K-D	25W 2750LM 5000K
WA-4FT-30W-MCT-D	30W 3200LM 3500K/4000K/5000K



BUILDER SERIES LED ECONOMY WRAP-AROUND FIXTURES



CATALOG NO.	DESCRIPTION
WAE-2FT-MCT-DT	20W 1600LM 3000K/4000K/5000K



4FT. LED T8-EZ5 GLASS LAMPS



CATALOG NO.	DESCRIPTION
T8-EZ5-GS-4FT-18W-40K-F	18W 2100LM 4000K
T8-EZ5-GS-4FT-18W-50K-C	18W 2100LM 5000K
T8-EZ5-GS-4FT-18W-50K-F	18W 2100LM 5000K

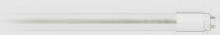

LED T8 2FT, PLASTIC ALUMINUM TUBE



CATALOG NO.	DESCRIPTION
T8-EZ6-AHL-2FT-15W-40K-F	15W 1650LM 4000K



8FT. LED T8 LAMPS



CATALOG NO.	DESCRIPTION
T8-8FT-40W-40K-F	40W 4800LM 4000K
T8-8FT-40W-50K-C	40W 4800LM 5000K
T8-8FT-40W-50K-F	40W 4800LM 5000K



4FT. LED T8-EZ4 LAMPS



CATALOG NO.	DESCRIPTION
T8-EZ4-HL-15W-40K-C	15W 2100LM 4000K



FINAL DEALS

FINAL PRODUCTION DEALS

"WHILE SUPPLIES LAST"

4FT. LED T8 LAMPS



CATALOG NO.	DESCRIPTION
T8-4FT-18W-35K-D-F	18W 1900LM 3500K



LED 4FT T8 TYPE B, SINGLE/DOUBLE ENDED



CATALOG NO.	DESCRIPTION
T8-4FT-TYPB-2E-18W-40K-C	18W 2200LM 4000K



4FT. T8 LED GLASS LAMPS DIMMABLE DIRECT A/C (one end N+L)



CATALOG NO.	DESCRIPTION
T8-4FT-DIM-18W-35K-C	18W 1900LM 3500K
T8-4FT-DIM-18W-35K-F	18W 1900LM 3500K
T8-4FT-DIM-18W-40K-C	18W 2150LM 4000K
T8-4FT-DIM-18W-50K-C	18W 2150LM 5000K
T8-4FT-DIM-18W-50K-F	18W 2150LM 5000K



4FT. LED T5 GLASS LAMPS



CATALOG NO.	DESCRIPTION
T5-TYPA-27W-40K-F	27W 3200LM 4000K



CRL ENGINES AND TRIMS

CATALOG NO.	DESCRIPTION
CRL-EGN-18W-30K	18W 1639LM 3000K
CRL-EGN-18W-50K	18W 1639LM 5000K
CRL-EGN-27W-30K	27W 2387LM 3000K
CRL-EGN-27W-40K	27W 2387LM 4000K
CRL-EGN-40W-30K	40W 3447LM 3000K
CRL-EGN-40W-40K	40W 3447LM 4000K
CRL-EGN-40W-50K	40W 3447LM 5000K
CRL-EGN-54W-40K	54W 4500LM 4000K
CRL-EGN-54W-50K	54W 4500LM 5000K
CRL-TRM-8	8" Trim for CRL



CRLC ENGINES

CATALOG NO.	DESCRIPTION
CRLC-EGN-15W-30K-D	15W 1200LM 3000K
CRLC-EGN-15W-40K-D	15W 1245LM 4000K
CRLC-EGN-15W-50K-D	15W 1275LM 5000K
CRLC-EGN-20W-50K-D	20W 1720LM 5000K



LED VANITY LIGHT, 120-277VAC



CATALOG NO.	DESCRIPTION
LVL-2FT-17W-30K	17W 1900LM 3000K



FINAL DEALS

FINAL PRODUCTION DEALS

"WHILE SUPPLIES LAST"







LED TRACK LIGHTS, 120V



CATALOG NO.	DESCRIPTION
 TRI-R-10W-WH-40K	10W 691LM 4000K
TRI-S-10W-BK-30K	10W 681LM 3000K
TRI-S-10W-BK-40K	10W 706LM 4000K
TRI-S-10W-WH-30K	10W 681LM 3000K
TRI-S-10W-WH-40K	10W 706LM 4000K
TRI-S-10W-WH-50K	10W 732LM 5000K

SINGLE CCT LED TRIMS 3", 4", 5/6" E26 included in the box
(JA8-E-2016 COMPLIANT)



CATALOG NO.	DESCRIPTION	PKG. QTY.	
 SMOOTH	RDL3-27K-WP	9W 540LM 2700K 3"	20
	RDL3-30K-WP	9W 540LM 3000K 3"	20
	RDL3-41K-WP	9W 540LM 4100K 3"	20
	RDL3-50K-WP	9W 540LM 5000K 3"	20
 SMOOTH	RDL4-27K-WP	12W 650LM 2700K 4"	12
	RDL4-30K-WP	12W 700LM 3000K 4"	12
	RDL4-35K-WP	12W 725LM 3500K 4"	12
	RDL4-41K-WP	12W 750LM 4100K 4"	12
	RDL4-50K-WP	12W 800LM 5000K 4"	12
	RDL4-65K-WP	12W 850LM 6500K 4"	12
 SMOOTH	RDL6-27K-WP	19W 1200LM 2700K 5/6"	8
	RDL6-30K-WP	19W 1250LM 3000K 5/6"	8
	RDL6-35K-WP	19W 1275LM 3500K 5/6"	8
	RDL6-41K-WP	19W 1300LM 4100K 5/6"	8
	RDL6-50K-WP	19W 1350LM 5000K 5/6"	8
	RDL6-65K-WP	19W 1400LM 6500K 5/6"	8
 BAFFLE	RDL4-BF-27K	10W 650LM 2700K 4"	24
	RDL4-BF-30K	10W 680LM 3000K 4"	24
	RDL4-BF-35K	10W 720LM 3500K 4"	24
	RDL4-BF-41K	10W 746LM 4100K 4"	24
	RDL4-BF-50K	10W 761LM 5000K 4"	24
 BAFFLE	RDL6-BF-27K	18W 1102LM 2700K 5/6"	16
	RDL6-BF-30K	18W 1204LM 3000K 5/6"	16
	RDL6-BF-30K-ORB	18W 1204LM 3000K 5/6" Oil-Rubbed Bronze	16
	RDL6-BF-35K	18W 1280LM 3500K 5/6"	16
	RDL6-BF-41K	18W 1300LM 4100K 5/6"	16
	RDL6-BF-50K	18W 1350LM 5000K 5/6"	16
 ADJUSTABLE EYEBALL	RDL4-ADJ-41K	10W 650LM 4100K 4"	12
	RDL4-ADJ-50K	10W 650LM 5000K 4"	12
	RDL6-ADJ-50K	13W 900LM 5000K 5/6"	8

4" LED SQUARE TRIMS



CATALOG NO.	DESCRIPTION
 SDL4-BF-27K	10W 600LM 2700K
SDL4-BF-30K	10W 650LM 3000K
SDL4-BF-50K	10W 700LM 5000K

FINAL PRODUCTION DEALS

"WHILE SUPPLIES LAST"

SINGLE CCT LED ULTRA SLIM RECESSED LIGHTS, 120V



CATALOG NO.	DESCRIPTION
 RSL3-27K	6W 400LM 2700K
RSL3-50K	6W 420LM 5000K
RSL4-27K	9W 630LM 2700K
RSL4-30K	9W 630LM 3000K
RSL4-30K-BN	9W 630LM 3000K
RSL4-40K	9W 650LM 4000K
RSL4-50K	9W 650LM 5000K
 RSL6-40K	15W 1125LM 4000K
RSL6-50K	15W 1125LM 5000K
RSL8-40K	18W 1300LM 4000K
RSL8-50K	18W 1300LM 5000K
 RSL12-30K	24W 1800LM 3000K
RSL12-40K	24W 1800LM 4000K
RSL12-50K	24W 1800LM 5000K

SINGLE CCT LED ULTRA SLIM RECESSED LIGHTS, 120V



CATALOG NO.	DESCRIPTION
 SSL4-50K	9W 650LM 5000K
SSL6-27K	15W 1125LM 2700K
SSL6-30K	15W 1125LM 3000K
SSL6-40K	15W 1125LM 4000K
SSL6-MCT	15W 1125-1200LM MULTI-CCT:3000K/4000K/5000K

4" SINGLE CCT LED ADJUSTABLE PULL-DOWN ULTRA SLIM RECESSED LIGHTS



CATALOG NO.	DESCRIPTION
 RSL4-APD-27K	12W 700LM 2700K
RSL4-APD-50K	12W 700LM 5000K

LED ADJUSTABLE ULTRA SLIM RECESSED LIGHTS



CATALOG NO.	DESCRIPTION
 RSL4-ADJ-27K	9W 700LM 2700K
RSL4-ADJ-30K	9W 700LM 3000K
RSL4-ADJ-40K	9W 700LM 4000K
RSL6-ADJ-30K	12W 900LM 3000K

2" LED RECESSED LIGHTS (Baffle)(JA8-E-2016 COMPLIANT)



CATALOG NO.	DESCRIPTION
 RDL2S-BF-40K-WH	8W 600LM 4000K
RDL2S-BF-50K-WH	8W 600LM 5000K

2" LED RECESSED LIGHTS (Baffle)(JA8-E-2016 COMPLIANT)



CATALOG NO.	DESCRIPTION
 SDL2S-BF-27K-WH	8W 600LM 2700K
SDL2S-BF-40K-WH	8W 600LM 4000K
SDL2S-BF-50K-WH	8W 600LM 5000K

FINAL PRODUCTION DEALS

"WHILE SUPPLIES LAST"

3" LED ADJUSTABLE (EYEBALL) RECESSED LIGHTS (JA8-E-2016 COMPLIANT)



CATALOG NO.	DESCRIPTION
SDL3S-ADJ-27K-WH	8W 600LM 2700K
SDL3S-ADJ-30K-WH	8W 600LM 3000K
SDL3S-ADJ-40K-WH	8W 600LM 4000K

DUSK-TO-DAWN AREA LIGHT, 120-277V



CATALOG NO.	DESCRIPTION
LRD-EGN-10W-27K-D	10W 700LM 2700K
LRD-EGN-10W-30K-D	10W 700LM 3000K
LRD-EGN-10W-35K-D	10W 700LM 3500K
LRD-EGN-10W-40K-D	10W 700LM 4000K
LRD-EGN-10W-50K-D	10W 700LM 5000K

LED 5CCT CLOUD FIXTURE WITH PRE-INSTALLED SENSOR, 120V



CATALOG NO.	DESCRIPTION	PKG. QTY.
FCRB-16-MCT5-SEN	20W 1400LM 27K/30K/35K/40K/50K 16" DIA	8

12V LED DIRECTIONAL LIGHTS - ALUMINUM



CATALOG NO.	DESCRIPTION
FCS-11-12W-40K	15W 1100LM 4000K

12V LED DIRECTIONAL LIGHTS - ALUMINUM



CATALOG NO.	DESCRIPTION
FCR-14-18W-40K	22W 1800LM 4000K

LED DRUM FIXTURES, 120V



CATALOG NO.	DESCRIPTION
FDL-14-20W-30K	20W 1500LM 3000K 14"
FDL-14-20W-40K	20W 1500LM 4000K 14"
FDL-14-MCT5	20W 1500LM 27K/30K/35K/40K/50K 14"
FDL-16-25W-30K	25W 1800LM 3000K 16"
FDL-16-25W-40K	25W 1800LM 4000K 16"
FDL-16-MCT5	24W 1800LM 27K/30K/35K/40K/50K 16"
FDL-18-30W-30K	30W 2250LM 3000K 18"
FDL-18-30W-40K	30W 2250LM 4000K 18"

FINAL DEALS

FINAL PRODUCTION DEALS

"WHILE SUPPLIES LAST"

BUILDER SERIES 6" LED ECONOMY DISC LIGHT, 120V



	CATALOG NO.	DESCRIPTION	PKG. QTY.
	DLSE4-MCT	9W 540LM 3000K/4000K/5000K	20
	DLSE6-30K	15W 900LM 3000K	20
	DLSE6-40K	15W 900LM 4000K	20
	DLSE6-50K	15W 900LM 5000K	20
	DLSE6-MCT	15W 1000LM 3000K/4000K/5000K	20
	DLSE6-MCT-BN	15W 1000LM 3000K/4000K/5000K	20

LED DISC LIGHT 4" & 6" 120V (J-BOX MOUNTING)(JA8-E-2016 COMPLIANT)



	CATALOG NO.	DESCRIPTION	PKG. QTY.
	DLSN4-27K	10W 600LM 2700K	20
	DLSN4-30K	10W 600LM 3000K	20
	DLSN4-41K	10W 600LM 4000K	20
	DLSN4-50K	10W 600LM 5000K	20
	DLSN6-27K	15W 1000LM 2700K	20
	DLSN6-30K	15W 1000LM 3000K	20
	DLSN6-41K	15W 1000LM 4000K	20
	DLSN6-50K	15W 1000LM 5000K	20
	DLSN6-30K-BN	15W 1000LM 3000K BRUSHED NICKEL	20

SPEC SERIES HIGH-PERFORMANCE DISC LIGHTS, 120V

DIE CAST ALUMINUM, ALL MOUNTING OPTIONS INCL.



	CATALOG NO.	DESCRIPTION	PKG. QTY.
	DLS4-27K	9W 550-600LM 2700K 4"	20
	DLS4-30K	9W 550-600LM 3000K 4"	20
	DLS4-41K	9W 550-600LM 4000K 4"	20
	DLS4-50K	9W 550-600LM 5000K 4"	20
	DLS6-27K	15W 950-1000LM 2700K 6"	20
	DLS6-30K	15W 950-1000LM 3000K 6"	20
	DLS6-41K	15W 950-1000LM 4000K 6"	20
	DLS6-50K	15W 950-1000LM 5000K 6"	20
	DLS6-30K-BR	15W 950-1000LM 3000K BRONZE 6"	20
	DLS6-30K-BN	15W 950-1000LM 3000K BRUSHED NICKEL 6"	20

LED PL LAMPS

	CATALOG NO.	DESCRIPTION
	LPL-EB-14W-H-L-40K	12W 1200LM 4000K
	LPL-MB-9W-H-40K	9W 800LM 4000K

FINAL DEALS

FINAL PRODUCTION DEALS

"WHILE SUPPLIES LAST"

LED T5 RETROFIT BAR WITH INTERNAL DRIVER



CATALOG NO.	DESCRIPTION	MAX RUN	PKG. QTY.
T5-12IN-5W-30K-D	5W 575LM 3000K 1FT.	15'	24
T5-12IN-5W-40K-D	5W 575LM 4000K 1FT.	15'	24
T5-12IN-5W-50K-D	5W 625LM 5000K 1FT.	15'	24
T5-22IN-9W-30K-D	9W 1035LM 3000K 2FT.	24'	24
T5-22IN-9W-40K-D	9W 1035LM 4000K 2FT.	24'	24
T5-22IN-9W-50K-D	9W 1125LM 5000K 2FT.	24'	24
T5-47IN-16W-30K-D	16W 1840LM 3000K 4FT.	31'	24
T5-47IN-16W-50K-D	16W 2000LM 5000K 4FT.	31'	24
T5-6FT-PC	6 FT. Plug-in Power Cord		-
T5-6FT-PCS	6 FT. Plug-in Power Cord with Switch		-
T5-8IN-JUMP	8" Linking Cable		-
T5-6FT-PT	6' AC Input Wire (PIGTAIL)		-
T5-COUPLER	Coupler		-
T5-MAGSET	Clip-on Secure Magnet Set		-



LED T5 RETROFIT LAMPS WITH INTERNAL DRIVER



CATALOG NO.	DESCRIPTION	MAX RUN	PKG. QTY.
T5-22IN-9W-40K	9W 1035LM 4000K 2FT	24'	24
T5-22IN-9W-50K	9W 1125LM 5000K 2FT	24'	24
T5-47IN-16W-40K	16W 1840LM 4000K 4FT	31'	24
T5-47IN-16W-50K	16W 2000LM 5000K 4FT	31'	24
T5-6FT-PC	6 FT. Plug-in Power Cord		-
T5-6FT-PCS	7 FT. Plug-in Power Cord		-
T5-8IN-JUMP	8" Linking Cable		-
T5-6FT-PT	6' AC Input Wire (PIGTAIL)		-
T5-COUPLER	Coupler		-
T5-MAGSET	Clip-on Secure Magnet Set		-



LED PUCK LIGHTS, 120V INTERNAL DRIVERS Surface/Recess

6Ft. Power Cord with In-Line switch



CATALOG NO.	DESCRIPTION	PKG. QTY.
PL12ADJ-30K-BK	4.5W 250LM 3000K PLASTIC WHITE 1LIGHT	50
PL12ADJ-40K-BK	4.5W 250LM 4000K PLASTIC BRUSHED NICKEL 1LIGHT	50
PL12ADJ-50K-BK	4.5W 250LM 5000K PLASTIC BLACK 1LIGHT	50



12V LED DIRECTIONAL LIGHTS - ALUMINUM

CATALOG NO.	DESCRIPTION
AD-130-BR	5W 400LM 3000K Bronze



FINAL PRODUCTION DEALS

"WHILE SUPPLIES LAST"

WELL LIGHTS WITH SLEEVE & LED LAMPS

CATALOG NO.	DESCRIPTION
 WL-105-1-BK	5W 400LM 3000K
WL-157-BK	5W 400LM 3000K
WL-157-FGBZ	5W 400LM 3000K
WL-181-BR	5W 400LM 3000K
WL-181-BZ	5W 400LM 3000K

12V LED PATH LIGHTS

CATALOG NO.	DESCRIPTION
 LAL-126-BR	3W 200LM 3000K
LAL-126-SIL	3W 200LM 3000K

WET LOCATION COMBINATION LED EXIT SIGN &

INCANDESCENT EMERGENCY, 120-277V, 11-3/4"(W) x 18-1/4"(H) x 3-3/4"(D)

CATALOG NO.	NUMBER OF FACES	LETTER COLOR	HOUSING	BATTERY
 XT-CWP-GG-EM	Single Face	Green	Gray	NiCd

LED EMERGENCY DRIVER

CATALOG NO.	DESCRIPTION
 ELB-2548-EXTR	LED EMERGENCY DRIVER FOR LED PRODUCTS WITH EXTERNAL DRIVER, UL RECOGNIZED 120-277 INPUT 25W 90 ...

SENSOR, IP66

CATALOG NO.	DESCRIPTION
 MSK-IP66-KN	Ultrasonic Bi-Level Outdoor Lighting Sensor Kit with DIP Switch Settings
MS0-IP66-KN	OUTDOOR BI-LEVEL PROGRAMMABLE MOTIONS SENSOR WITH 1/2" KNUCKLE

EXTENSION CORD

CATALOG NO.	DESCRIPTION
 EX143-25	SJTW 14Awg/3C, 25 Ft, 13A, 125V, Outside Extension Cord, 10 Pcs/Ctn
EX163-50	SJTW 14Awg/3C, 50 Ft, 13A, 125V, Outside Extension Cord, 8 Pcs/Ctn
EXL143-50	SJTW 14Awg/3C, 50 Ft, 15A, 125V, Blue Outdoor Extension Cord, Lighted Plug, 6 Pcs/Ctn
EXL123-50	SJTW 3C/12Awg, 50 Ft, 15A, 125V, Blue Outdoor Extension Cord, Lighted Plug, 4 Pcs/Ctn

STRAIGHT ANGLE PLUG WITH THICK VINYL INSULATION

CATALOG NO.	DESCRIPTION
 DRY4	Heavy-Duty Strain Relief Protects Cord Resulting In Longer Cord Life
DRY5	Heavy-Duty Strain Relief Protects Cord Resulting In Longer Cord Life

FINAL DEALS

Westgate Series

INDEX

WG Series	Page No.	WG Series	Page No.	WG Series	Page No.	WG Series	Page No.	WG Series	Page No.	WG Series	Page No.	WG Series	Page No.
A19	138	EL-M2	173	LCFR	133	LRS-J	18	RDDF	121	SOLN	46	ULR-IN-SO	143
A19-FLA	140	ELN4X	175	LCFS	134	LRS-J1S	18	RDJ	122	SOLR	159	ULR-IN-XHO	144
A-41	161	EL-RH	174	LCFW	132	LRS-K	21	RDL	123	SOLS	39	ULR-IN-YHO	144
A-41-S	161	EL-RH-WP	174	LCL	97	LRS-L	98	RDL-12V	122	SP10KV	58	ULR-IP54-HO	145
AA	155	EL-WP	174	LD	153	LRS-L	20	RDL2S	127	SPIKE	162	ULR-LENS	148
AA-146	156	EL-ZA	173	LDAP	132	LRS-M	21	RDL3S	127	SPL	92	ULR-OT-HO	146
AA-RG	162	EW-16	174	LDL	68	LRS-MC	22	RDL3S-ADJ	127	SR16	90	ULR-OT-HO-COB	147
OUTDOOR ACCESSORIES	33	EX	183	LDLS	127	LRS-N	21	RDL4S-SB	127	SRPL	93	ULR-OT-XHO	146
AD	153	EXPF	44	LDS	17	LRS-O	21	RDL-MCT5	121	SSLRB	125	ULR-OT-YHO	146
AD-018	152	EXPL	44	LDL	17	LRS-P	22	RDL-TRM	122	SSLRB-TRM	125	ULR-RGBW	145
AD120-017	36	EXPR	44	LDSS	17	LRS-PV	20	RDPF	121	ST19-FLA	140	USB2	183
AD120-017	152	FCD	131	LDSW	17	LRS-Q	22	RDPS	121	STG	138	UW	159
AD120-018	36	FCR	129	LDSX	17	LRS-R	20	REOTES	58	STG-RGB	142	VTA	40
AD120-018	152	FCRB	129	LDSXL	17	LRS-S	20	RHN4X	175	STL2	47	VTU	40
AS	158	FCRB-SEN	129	LEDDR	148	LRS-S	20	RMS	62	STL3	47	W1B	177
B-41	161	FCS	129	LEDTFX	174	LRS-SWVG	20	RSL	126	STL4	47	W1C	177
BC	161	FDL	129	LESW	11	LRS-T	20	RSL-ADJ	126	T	181	W1D	178
BKH	8	FDSL	130	LESW-EM	174	LRS-WS	21	RSL-ADJ-MCT5	124	T12-EZX	111	W2B	178
BOL-44	55	FEL	73	LF12	152	LRT-HL	75	RSL-ADJ-WP	124	T5	62	W2C	179
BOL-62	54	FLD2	36	LF12-KN	38	LRX	40	RSL-APD	126	T5-D	168	W2D	179
BOL-64	53	FLD3	36	LF3 SHROUD	31	LS	158	RSL-APD-MCT5	124	T5-EZ6-GS	111	W2X	179
BOL-G4-SOLAR	52	FLDX	34	LF3-HL-KN	30	LSL	96	RSLC	115	T5-TYP	111	W3B	179
BOL-G5	53	FLDXPRO	34	LF3-KN	30	LSN	95	RSLC	126	T8-DIM	110	W3C	179
BPS	52	FLH	39	LF3-TR	31	LSP	98	RSL-FR	126	T8-DIM	111	W3D	179
BR-30	139	FLS	39	LF4-12V	38	LS-REPL	162	RSL-GIM	126	T8-EZ6	109	WA	98
BRL	135	FLV12	38	LF4-12V	152	LSS	94	RSL-JB	126	T8-EZ6-GS	110	WAE	99
C	181	FLV12	152	LF4-KN	30	LSW	19	RSL-MCT5	124	T8-EZX	109	WAS	98
CAX	49	FLVX	37	LF4PRO	26	LSWN	161	RSL-MCT5-G2	123	T8-HL	111	WAX	6
CDLX	48	FLVXPRO	37	LF4PRO	32	LSWX	11	RSL-MCT5-WP	124	T8-HL-SPLIT	111	WCPL	93
CDX	48	FMD	137	LF4PRO	32	LTPV	66	RSL-TRM	125	T8-TYPB	110	WCPL	93
CG	182	FML	130	LFE	32	LTR	75	SCE	77	T8-U2F	109	WE167	161
CGL	49	FMLE	130	LFE-KN	29	LTRB	74	SCLL	91	TC-A19	139	WEC-MOD	58
CL-CONST	70	FML-MCT	131	LFE-TR	30	LTRD	75	SCLP	91	TC-A19	141	WEC-SW	58
CL-FLT	68	FMLS	130	LFLD	152	LTRE	74	SCLP	91	TC-E12	140	WFL	120
CL-FLT	70	FML-TRM	131	LFLV	38	LTRP	76	SCLT	91	TC-E12	141	WL	160
CL-HL	69	FML-UGR	131	LFVL	157	LTRS	74	SCO	83	TC-FL	35	WL-3IN1	39
CMC1	104	FSL	129	LFX	27	LTW	7	SCP	90	TC-FL	141	WL-EZCG	39
CMC2	105	G10	140	LFX MOUNTING	28	LVA	118	SCPL	92	TC-FL-12V	38	WLL	159
CMC3	104	GL	35	LFX SHROUD	28	LVB	116	SCPP	92	TC-FL-12V	141	WMC	15
CMC4	106	GL-12V	36	LFXE	25	LVC	117	SCR	93	TC-FML	130	WMC-12V	153
CMC6	107	GL-12V	152	LFX-KN	29	LVD	117	SCX	78	TC-FML	141	WMC-RGBW	16
CMC9	108	GNB	14	LFXMAX	26	LVE	117	SCX	79	TC-G25	141	WMC-RGBW	23
CMC-RGBW	108	GPA	182	LFXPRO	25	LVF	116	SCX2	82	TC-GL-12V	38	WMC-RGBW	142
CMC-RGBW	142	GPC	42	LFX-TR	31	LVG	118	SCX-2X2	85	TC-GL-12V	141	WMC5	16
CRE	13	GPE	41	LH150	182	LVL	116	SCX4	81	TC-PAR	139	WML2	9
CREA	13	GPET	41	LHB2	62	LVS	118	SCX4-IP66	77	TC-PAR	141	WML-HL	8
CRE5	13	GPH	43	LHCX	63	LVT	160	SCX6	82	TC-RDPS	122	WMS	10
CRL	114	GPL	42	LL	181	LVTE	66	SCX2	76	TC-RDPS	141	WMV	8
CRLC4	112	GPS	183	LLHB	64	LWV	19	SCX-BK	80	TC-RGBW	23	WMX	9
CRLC6	113	GPX	27	LLHB4	64	LWV	153	SCX-DIP	85	TGL	72	WMXE	8
CRLC8	113	GPX	41	LLHB4	65	LW360	5	SCX-Q	85	TL	163	WPAX	6
CRLE	115	GSX-RECS	51	LLHC	63	LWAX	4	SCXR	83	TR	119	WPFX	6
CRLX	114	GSX-SRFC	51	LTVT	67	LWPX	7	SCXT	84	T-RFG	111	WPMX	7
CWLEZXT	172	GZ	140	LTVT-480V	68	MS07C	182	SDLS	122	TR-MT	160	WPX	7
CWS	119	GZ	161	LMIR	119	MOTION SENSORS	57	SDL2S	127	TR-TPC	160	WRB	180
CXER	50	HBL	70	LMW	10	MR11	139	SDL3S	127	UC	166	WRC	180
CXES	50	HPL	70	LOHB	39	MR16	139	SDL4S-SB	127	UCA	165	WRE	180
DAB	42	HSL	159	LOV	162	MR16	161	SDL	90	UC-ADJ	167	WSX	14
DBEL	175	ICF	123	LP-D-HL	72	MR16-RGB	140	SFL	90	UCA-RGB	166	WXB	180
DELW	175	IGL	158	LPF	99	MVP94	183	SFX-G7	44	UCE	165	WXF	180
DISPLAY	162	IGLA	159	LPL	138	MVP98	183	SFX-G9	44	UCM	167	WXR	180
DISPLAY	169	LA	156	LPNG	71	MVP99	183	SFX-G9-RGB	24	UCW	166	XD	170
DLS	137	LA-90	161	LPS	73	MVP99-1C	183	SFX-G9-RGB	45	UHL	62	XE	171
DLS-277V	137	LA-FMS21	161	LR	181	MVP99-2C	183	SFX-RGB	142	UHX	59	XT	170
DISE	136	LAL	157	LR2	40	PAR36	139	SLB	182	UHX-480V	60	XT-C-ADJ	172
DLS-MCT	137	LA-STEM	162	LRD	128	PAR36	161	SL-D	12	UHKE	61	XT-CL	172
DLSN	136	LA-T	161	LR-ECO	40	PAR38	139	SLE	163	UHX-SR	60	XTCLN4X	172
DLS-PIR	137	LB	181	LRP-HL	75	PHOTOCONTROLS	56	SLE	164	ULR-1FT	150	XT-CLWP	173
DMX-RGWM	24	LCFA	133	LRS-A	20	PL	182	SLEA	164	ULR-1FT	151	XT-CWP	173
E12	140	LCFB	134	LRS-B	20	PL12	169	SLEB	164	ULR-2WRE	149	XT-EL	171
EL-HO	173	LCFC	133	LRS-C	20	PL120ADJ	168	SL-P	11	ULR-CH	148	XTN4X	171
EL-1	173	LCFD	134	LRS-CR2	21	PL12-3KIT	169	SL-P	12	ULR-DCJ	149	XTSL	170
EL-1D	173	LCFE	135	LRS-D	20	PL12ADJ	169	SLR	97	ULR-IN-HO	143	XTSL-CL	172
EL-1L	173	LCFF	132	LRS-E	18	PL12R	168	SLRP	62	ULR-IN-HO-COB	144	XTU	170
ELB	176	LCFH	135	LRS-F	18	PL12S	168	SOLA	46	ULR-IN-HO-COM-WT	145	XT-WP	171
EL-EHO	174	LCFN	132	LRS-G	18	PML	43	SOLA-SPLT	45	ULR-IN-HWDR	147	YM	183
EL-M1	173	LCFP	133	LRS-H	18	POB	93	SOLF	45	ULR-IN-PIDR	147		

NEED ADDITIONAL SERVICES?

REVIEW THE BELOW LIST OF FLAT RATE SERVICES OFFERED BY WESTGATE

Optional Add-Ons:

PART#	SERVICE DESCRIPTION	2024 Terms
/SR-EXTW-3YR	3 years Additional Warranty	Request A Quote
/SR-STRG-14D	Additional 14days Storage*	Request A Quote
/SR-STRG-30D	Additional 30days Storage*	Request A Quote
/SR-EXPED-LTL	Expedited Pallet Delivery**	Request A Quote
/SR-SIGN-PKG	Signature Required For FedEx/UPS Delivery	Request A Quote

* Westgate offers up to 14 days of free storage hold for your orders.

**Free freight is the standard speed is at Westgate's discretion.

Manadatory Charges:

PART#	SERVICE DESCRIPTION	2024Terms
/SR-RESI-D	Residential Pallet Delivery fee*	Request A Quote
/SR-LIFT-G	Lift Gate fee	Request A Quote
/SR-REDELIVERY	Truck Re-delivery Fee	Request A Quote
/SR-WAIT-T	Wait Fee At The Delivery Location	Request A Quote

* The additional fee applies even if when the standard shipping is Prepaid by Westgate.

**All Rates Subject to Change in 2025.

Westgate will send a new invoice referencing the original purchase order number when the additional freight charges occur after the initial invoice.

Extend Invoice Pay Terms:

PART#	SERVICE DESCRIPTION	Cost/Invoice
/EXT1	1-month extension	Request A Quote
/EXT2	1-month extension	Request A Quote
/EXT3	1-month extension	Request A Quote
/EXT4	1-month extension	Request A Quote
/EXT5	1-month extension	Request A Quote
/EXT6	1-month extension	Request A Quote

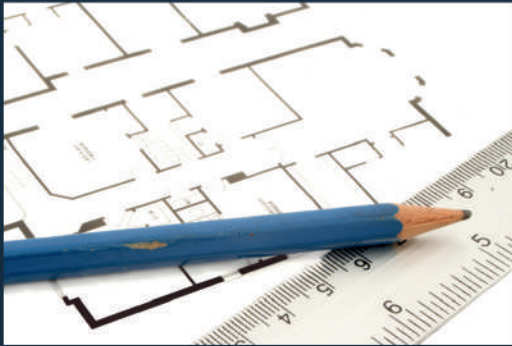

FREE LIGHTING LAYOUT DESIGN

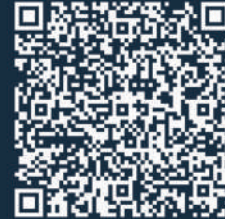

Online Warranty Processing

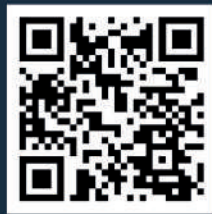

WE CUSTOMIZE

EM, Sensor, PC, Powdercoat,
Cold-Weather EM, Whips

Energy-efficient lighting easier and more profitable!

NO MINIMUMS 🚫

QUICK FREE SHIPPING 🚚

FRIENDLY POLICIES 😊

\$1

WESTGATEMFG.COM



Follow us @westgatemfg

Loving Lighting?

CALL/TEXT
877-805-2252