



BUYERS GUIDE



*Delivering
Quality Light*
BETTER



*Qualifies for Buy American under ARRA

TABLE OF CONTENTS

LED Products

◆ Independence Wall Lights

W.	4
WSG	5
WMS/WM	6
WD.	7

Classic Wall Lights

WL	8
--------------	---

◆ WLSG 9

WLM	10
WLD	11

SlimPak Pro

WSPS.	12
---------------	----

◆ WSPL. 13

WSPLD.	13
----------------	----

Wall Pak Pro

WPS	14
---------------	----

◆ WPM. 15

WPL	16
---------------	----

Cut Off Wall Lights

WLCFC/ WLMFC	17
------------------------	----

◆ Dusk to Dawn

DD2G	18
----------------	----

◆ Independence Canopy Lights

LPC.	19
--------------	----

◆ Canopy/Parking Garage Lights

CPM	20
PGM	21

◆ Independence Floods

FS	22
FM	23

◆ Extra Wide Floods

PFSXW	24
PFMXW	26
HXW - Hawk Selectable	28
PFL2GXW	30
PFXL2GXW	32

◆ Optic Flood Lights

PFS.	25
PFM	27
HXP - Hawk Selectable	29
Brackets.	37

◆ Extreme Flood Lights

PFL2GH	31
PFXL2GH	33

◆ Patriot Sports Lights

SPT.	34-35
--------------	-------

◆ Area Lighting

Roadway Light	36
Eagle Series - Selectable.	40-41
Eagle Series	42-45
PLM	46
Bollard.	47
Universal Bracket System	48-49

◆ Independence High Bay	
IHB - Selectable	50-51
IHB	52-53
◆ Linear High Bay	
ILH	54-65
◆ Round High Bay	
IRH	66-67
◆ Independence Vaportite	
IVT	69
◆ Linear Wet Location	
ILWRK - Potomac-AT	70-71
ILW Narrow	72-74
ILW Wide	75-76
◆ Field Adjustable Edge Lit Panels	
FAELP	77
◆ Linear LED Strips	
ILS	78
◆ Stairwell Lights	
ILS	79
◆ Exit & Emergency	
EXP	82
EEC	82
EMO	83
ERD	83
ERHR	83



Independence Series

LED Wall Light

REPLACES UP TO 100W MH



- 2,133 **LUMENS**
- 21 **WATTS**
- 110 **LPW**
- 80 **CRI**
- 4500K **CCT**
- 0-10V **DIMMING**
- REC MNT HT**
8 FT to 10 FT



- Reduced Glare & Offensive Light
- Less Wasted Light
- More Footcandles on the Ground
- Creates a Smooth & Uniform Light Pattern

6.83"Wx10.95"Hx5.24"D
6.6 LBS

ORDERING INFORMATION

CATALOG #	DESCRIPTION	CCT	REPLACES UP TO	VOLTS
W2L45K	LED Wall Light	4500K	100W MH	120-277

Specs shown are for 4500K CCT. Also available in 4000K and 5000K. See Cut Sheet for more information.

FOOTCANDLES ON THE GROUND

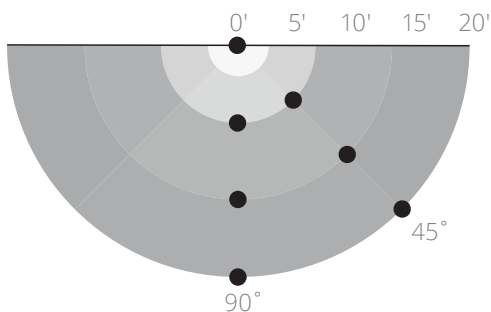

	8' Mtg Height		10' Mtg Height	
	90°	45°	90°	45°
0'	11.9	11.9	0'	7.4
5'	5.2	6.0	5'	4.6
10'	2.1	1.5	10'	1.8
15'	1.0	0.6	15'	0.9
Average	4.0		3.1	

OPTIONS

ADD SUFFIX #	DESCRIPTION	ADD SUFFIX #	DESCRIPTION
PC	120V Photocontrol	EB	Emergency Back-Up
PM	208-277V Photocontrol		

ENERGY SAVINGS

LED		HID			
WATTAGE	ANNUAL COST	SOURCE WATTAGE	TOTAL WATTAGE USED	ANNUAL COST	ANNUAL SAVINGS
21	\$9	50	72	\$52	\$43
21	\$9	70	90	\$59	\$50
21	\$9	100	129	\$77	\$68



*The majority of Atlas Lighting Products are assembled in USA facilities by an American Workforce utilizing both Domestic and Foreign components
*Qualifies for Buy American under ARRA



Independence Series



Small LED Wall Light REPLACES UP TO 100W MH

- Reduced Glare & Offensive Light
- Less Wasted Light
- More Footcandles on the Ground
- Creates a Smooth & Uniform Light Pattern



Patent Pending

8.75"Wx8.5"Hx9.05"D
6.6 LBS

- 3,913 **LUMENS** ☀️
- 31 **WATTS** ⚡
- 125 **LPW** 💰
- 80 **CRI** ⊕
- 4500K **CCT** 🌈
- 0-10V **DIMMING** ⬆️⬇️⬆️
- REC MNT HT** 10 FT to 12 FT 📏

ORDERING INFORMATION

CATALOG #	DESCRIPTION	CCT	REPLACES UP TO	VOLTS
WSG4L45K	Small LED Wall Light	4500K	100W MH	120-277

Specs shown are for 4500K CCT. Also available in 3000K, 4000K and 5000K. See Cut Sheet for more information.

FOOTCANDLES ON THE GROUND

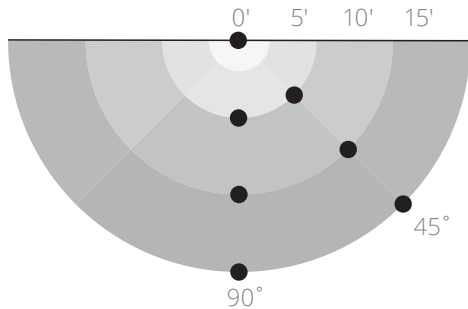

	10' Mtg Height		12' Mtg Height	
	90°	45°	90°	45°
0'	11.2	11.2	7.6	7.6
5'	10.2	8.7	7.5	6.4
10'	4.3	3.9	3.9	3.6
15'	2.3	1.8	2.2	1.8

OPTIONS

ADD SUFFIX #	DESCRIPTION	ADD SUFFIX #	DESCRIPTION
PC	120V Photocontrol	PM	208-277V Photocontrol

ENERGY SAVINGS

LED		HID			
WATTAGE	ANNUAL COST	SOURCE WATTAGE	TOTAL WATTAGE USED	ANNUAL COST	ANNUAL SAVINGS
31	\$14	50	72	\$52	\$38
31	\$14	70	90	\$59	\$45
31	\$14	100	129	\$77	\$63

Average **6.0** Average **4.7**



*The majority of Atlas Lighting Products are assembled in USA facilities by an American Workforce utilizing both Domestic and Foreign components
*Qualifies for Buy American under ARRA



Independence Series

Medium LED Wall Light

REPLACES UP TO 400W MH



WM5L45K / WM7L45K / WM10L45K

4,900 / 7,229 / 10,500 **LUMENS**

38 / 60 / 78 **WATTS**

128 / 121 / 135 **LPW**

80 **CRI**

4500K **CCT**

0-10V **DIMMING**

REC MNT HT
12-14 FT / 18-20 FT / 20-22 FT



14.2"Wx9.02"Hx7.85"D
9.25 LBS

Design is Protected
by U.S. Patent
No. 9,482,395

- Reduced Glare & Offensive Light
- Less Wasted Light
- More Footcandles on the Ground
- Creates a Smooth & Uniform Light Pattern

ORDERING INFORMATION

CATALOG #	DESCRIPTION	LUMENS	CCT	REPLACES UP TO	VOLTS
WM5L45K	Medium LED Wall Light	4,900	4500K	175W MH	120-277
WM7L45K	Medium LED Wall Light	7,229	4500K	400W MH	120-277
WM10L45K	Medium LED Wall Light	10,500	4500K	400W MH	120-277
WMS3-10L	Fully Selectable LED Wall Light	3,000 - 10,000 Selectable	4K/45K/4K Selectable	400W MH	120-277

Specs shown are for 4500K CCT. Also available in 3000K, 4000K and 5000K. See Cut Sheet for more information.

FOOTCANDLES ON THE GROUND

5,000 Lumens 0' 5' 10' 15' 20'

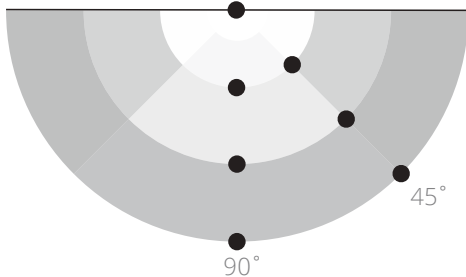

12' Mtg Height

14' Mtg Height

	90°	45°		90°	45°
0'	6.4	6.4	0'	4.6	4.6
5'	7.8	6.5	5'	5.8	4.9
10'	5.1	4.0	10'	4.3	3.5
15'	2.9	2.1	15'	2.7	2.0

Average **5.0** Average **4.0**

OPTIONS

ADD SUFFIX #	DESCRIPTION	ADD SUFFIX #	DESCRIPTION
PC	120V Photocontrol	EB	Emergency Back-Up
PM	208-277V Photocontrol	4	480V Driver

ENERGY SAVINGS

LED		HID			
WATTAGE	ANNUAL COST	SOURCE WATTAGE	TOTAL WATTAGE USED	ANNUAL COST	ANNUAL SAVINGS
38	\$17	150	185	\$100	\$83
38	\$17	175	210	\$112	\$95
57	\$25	250	285	\$150	\$125
57	\$25	400	458	\$226	\$201
78	\$34	250	285	\$150	\$116
78	\$34	400	458	\$226	\$192



*The majority of Atlas Lighting Products are assembled in USA facilities by an American Workforce utilizing both Domestic and Foreign components
*Qualifies for Buy American under ARRA



Independence Series



Large LED Wall Light REPLACES UP TO 400W MH

- Reduced Glare & Offensive Light
- Less Wasted Light
- More Footcandles on the Ground
- Creates a Smooth & Uniform Light Pattern



18.2"Wx9.01"Hx9.78"D
15 LBS

Design is Protected
by U.S. Patent
No. 9,482,395

WD7L45K / WD10L45K
6,933 / 9,958 **LUMENS** ☀️
56 / 82 **WATTS** ⚡️
124 / 122 **LPW** 💰
80 **CRI** Ⓢ
4500K **CCT** 🔌
0-10V **DIMMING** 📉
REC MNT HT 📏
18-20 FT / 20-22 FT

ORDERING INFORMATION

CATALOG #	DESCRIPTION	LUMENS	CCT	REPLACES UP TO	VOLTS
WD7L45K	Large LED Wall Light	6,933	4500K	400W MH	120-277
WD10L45K	Large LED Wall Light	9,958	4500K	400W MH	120-277

Specs shown are for 4500K CCT. Also available in 3000K, 4000K and 5000K. See Cut Sheet for more information.

FOOTCANDLES ON THE GROUND

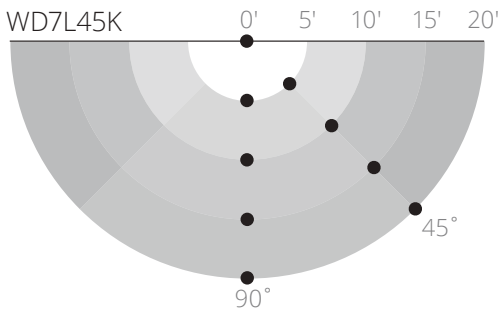

18' Mtg Height

	90°	45°
0'	3.9	3.9
5'	5.0	4.4
10'	4.5	3.8
15'	3.2	2.6
20'	2.2	1.7

Average **3.5**

20' Mtg Height

	90°	45°
0'	3.2	3.2
5'	4.0	3.6
10'	3.8	3.2
15'	2.9	2.4
20'	2.1	1.7

Average **3.0**

OPTIONS

ADD SUFFIX #	DESCRIPTION	ADD SUFFIX #	DESCRIPTION
PC	120V Photocontrol	EB	Emergency Back-Up
PM	208-277V Photocontrol	4	480V

ENERGY SAVINGS

LED		HID			
WATTAGE	ANNUAL COST	SOURCE WATTAGE	TOTAL WATTAGE USED	ANNUAL COST	ANNUAL SAVINGS
56	\$25	250	285	\$150	\$125
56	\$25	400	458	\$226	\$201
82	\$36	250	285	\$150	\$114
82	\$36	400	458	\$226	\$190



*The majority of Atlas Lighting Products are assembled in USA facilities by an American Workforce utilizing both Domestic and Foreign components
*Qualifies for Buy American under ARRA



WL20LED

20 Watt LED Classic Wall Light

REPLACES UP TO 100W MH



- 1,788 **LUMENS**
- 20 **WATTS**
- 92 **LPW**
- 84 **CRI**
- 4500K **CCT**
- 0-10V **DIMMING**
- REC MNT HT**
8 FT to 10 FT



6.83"Wx10.95"Hx5.24"D
6.6 LBS

- Eliminates Glare & Offensive Light
- Less Wasted Light
- More Footcandles on the Ground
- Creates a Smooth & Uniform Light Pattern

ORDERING INFORMATION

CATALOG #	DESCRIPTION	CCT	REPLACES UP TO	VOLTS
WL20LED	20W LED Wall Light	4500K	100W MH	120-277

Specs shown are for 4500K CCT. Also available in 3000K, 4000K and 5000K. See Cut Sheet for more information.

FOOTCANDLES ON THE GROUND

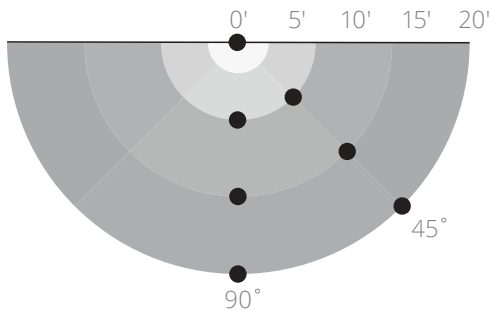

	8' Mtg Height		10' Mtg Height	
	90°	45°	90°	45°
0'	9.1	9.1	0'	5.9
5'	5.9	5.4	5'	4.3
10'	2.0	1.5	10'	1.8
15'	1.0	0.7	15'	1.0
Average	3.3		2.6	

OPTIONS

ADD SUFFIX #	DESCRIPTION	ADD SUFFIX #	DESCRIPTION
PC	120V Photocontrol	EB	Emergency Back-Up
PM	208-277V Photocontrol		

ENERGY SAVINGS

LED		HID			
WATTAGE	ANNUAL COST	SOURCE WATTAGE	TOTAL WATTAGE USED	ANNUAL COST	ANNUAL SAVINGS
20	\$9	50	72	\$52	\$43
20	\$9	70	90	\$59	\$50
20	\$9	100	129	\$77	\$68



*The majority of Atlas Lighting Products are assembled in USA facilities by an American Workforce utilizing both Domestic and Foreign components
*Qualifies for Buy American under ARRA



WLSG27LED

27 Watt LED Classic Wall Light

REPLACES UP TO 100W MH



- Eliminates Glare & Offensive Light
- Less Wasted Light
- More Footcandles on the Ground
- Creates a Smooth & Uniform Light Pattern



Patent Pending

8.75"Wx8.5"Hx9.05"D
6.6 LBS

- 3,017 **LUMENS**
- 27 **WATTS**
- 113 **LPW**
- 83 **CRI**
- 4500K **CCT**
- 0-10V **DIMMING**
- REC MNT HT**
10 FT to 12 FT

ORDERING INFORMATION

CATALOG #	DESCRIPTION	CCT	REPLACES UP TO	VOLTS
WLSG27LED	27W LED Wall Light	4500K	100W MH	120-277

Specs shown are for 4500K CCT. Also available in 3000K, 4000K and 5000K. See Cut Sheet for more information.

FOOTCANDLES ON THE GROUND

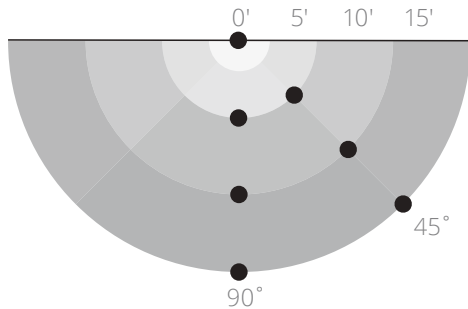

	10' Mtg Height		12' Mtg Height	
	90°	45°	90°	45°
0'	9.0	9.0	6.3	6.3
5'	7.2	6.8	5.6	5.3
10'	3.3	4.4	3.0	3.7
15'	1.8	2.3	1.8	2.3

OPTIONS

ADD SUFFIX #	DESCRIPTION	ADD SUFFIX #	DESCRIPTION
PC	120V Photocontrol	PM	208-277V Photocontrol

ENERGY SAVINGS

LED		HID			
WATTAGE	ANNUAL COST	SOURCE WATTAGE	TOTAL WATTAGE USED	ANNUAL COST	ANNUAL SAVINGS
27	\$12	50	72	\$52	\$40
27	\$12	70	90	\$59	\$47
27	\$12	100	129	\$77	\$65

Average **4.8** Average **3.9**



*The majority of Atlas Lighting Products are assembled in USA facilities by an American Workforce utilizing both Domestic and Foreign components
*Qualifies for Buy American under ARRA



WLM Series

43-80 Watt LED Classic Wall Light

REPLACES UP TO 400W MH



WLM43LED / WLM64LED / WLM80LED

☀️ 4,350 / 6,793 / 8,615 **LUMENS**

⚡ 43 / 64 / 80 **WATTS**

💰 107 / 112 / 109 **LPW**

⊕ 82 / 73 / 73 **CRI**

🔌 4500K **CCT**

📏 0-10V **DIMMING**

📏 **REC MNT HT**
12-14 FT / 18-20 FT / 20-22 FT



- 95% Efficient Reflector Targets the Light
- Eliminates Glare & Offensive Light
- Less Wasted Light
- More Footcandles on the Ground
- Creates a Smooth & Uniform Light Pattern

14.2"Wx9.02"Hx7.85"D
9.25 LBS

Design is Protected
by U.S. Patent
No. 9,482,395

ORDERING INFORMATION

CATALOG #	DESCRIPTION	LUMENS	CCT	REPLACES UP TO	VOLTS
WLM43LED	43W LED Wall Light	4,350	4500K	175W MH	120-277
WLM64LED	64W LED Wall Light	6,793	4500K	400W MH	120-277
WLM80LED	80W LED Wall Light	8,615	4500K	400W MH	120-277
WLMS3-9L	Fully Selectable LED Wall Light	3,000 - 9,000 Selectable	4K/45K/4K Selectable	400W MH	120-277

Specs shown are for 4500K CCT. Also available in 3000K, 4000K and 5000K. See Cut Sheet for more information.

FOOTCANDLES ON THE GROUND

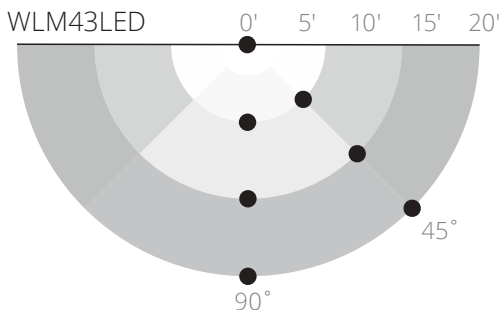

12' Mtg Height

14' Mtg Height

	90°	45°		90°	45°
0'	11.5	11.5	0'	8.3	8.3
5'	9.2	9.9	5'	7.6	8.0
10'	7.9	5.3	10'	6.1	4.4
15'	3.6	3.0	15'	3.7	3.0

Average **7.8** Average **6.2**

OPTIONS

ADD SUFFIX #	DESCRIPTION	ADD SUFFIX #	DESCRIPTION
PC	120V Photocontrol	EB	Emergency Back-Up
PM	208-277V Photocontrol	4	480V Driver

ENERGY SAVINGS

LED		HID			
WATTAGE	ANNUAL COST	SOURCE WATTAGE	TOTAL WATTAGE USED	ANNUAL COST	ANNUAL SAVINGS
43	\$19	150	185	\$100	\$81
43	\$19	175	210	\$112	\$93
64	\$28	250	285	\$150	\$122
64	\$28	400	458	\$226	\$198
80	\$35	250	285	\$150	\$115
80	\$35	400	458	\$226	\$191



*The majority of Atlas Lighting Products are assembled in USA facilities by an American Workforce utilizing both Domestic and Foreign components
 *WLM80 is not DLC Qualified | *Qualifies for Buy American under ARRA



WLD Series

64-86 Watt LED Classic Wall Light

REPLACES UP TO 400W MH



- 95% Efficient Reflector Targets the Light
- Eliminates Glare & Offensive Light
- Less Wasted Light
- More Footcandles on the Ground
- Creates a Smooth & Uniform Light Pattern



18.2"Wx9.01"Hx9.78"D
15 LBS

Design is Protected
by U.S. Patent
No. 9,482,395

WLD64LED / WLD86LED / WLD120LED

6,966 / 9,173 / 13,170 **LUMENS**

64 / 86 **WATTS**

111 / 107 **LPW**

83 **CRI**

4500K **CCT**

0-10V **DIMMING**

REC MNT HT
18-20 FT / 20-22 FT

ORDERING INFORMATION

CATALOG #	DESCRIPTION	LUMENS	CCT	REPLACES UP TO	VOLTS
WLD64LED	64W LED Wall Light	6,966	4500K	400W MH	120-277
WLD86LED	86W LED Wall Light	9,173	4500K	400W MH	120-277
WLD120LED	120W LED Wall Light	13,170	4500K	400W MH	120-277
WLDS4-13L	Fully Selectable LED Wall Light	4,000 -13,000 Selectable	4K/45K/4K Selectable	400W MH	120-277

Specs shown are for 4500K CCT. Also available in 3000K, 4000K and 5000K. See Cut Sheet for more information.

FOOTCANDLES ON THE GROUND

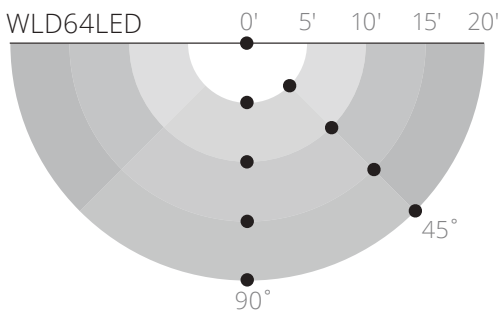

18' Mtg Height

20' Mtg Height

	90°	45°		90°	45°
0'	11.6	11.6	0'	9.4	9.4
5'	10.8	10.2	5'	9.0	8.6
10'	5.7	6.4	10'	5.3	5.9
15'	4.4	3.6	15'	3.9	3.5
20'	3.8	2.6	20'	3.5	2.4

Average **6.3**

Average **5.5**

OPTIONS

ADD SUFFIX #	DESCRIPTION	ADD SUFFIX #	DESCRIPTION
PC	120V Photocontrol	EB	Emergency Back-Up
PM	208-277V Photocontrol	4	480V

ENERGY SAVINGS

LED		HID			
WATTAGE	ANNUAL COST	SOURCE WATTAGE	TOTAL WATTAGE USED	ANNUAL COST	ANNUAL SAVINGS
64	\$28	250	285	\$150	\$122
64	\$28	400	458	\$226	\$198
86	\$38	250	285	\$150	\$112
86	\$38	400	458	\$226	\$188
120		400	458	\$226	



*The majority of Atlas Lighting Products are assembled in USA facilities by an American Workforce utilizing both Domestic and Foreign components
*Qualifies for Buy American under ARRA



WSPS Series

12-40 Watt LED SlimPak Pro

REPLACES UP TO 175W MH



WSPS12LED / WSPS20LED / WSPS40LED

1,326 / 2,228 / 4,211 **LUMENS**

12 / 20 / 40 **WATTS**

108 / 109 / 113 **LPW**

73 / 75 / 70 **CRI**

4500K **CCT**

0-10V **DIMMING**

REC MNT HT
14-16 FT / 18-20 FT

Patent Pending



6"Wx7.65"Hx4"D
3.8 LBS

- Slim Low Profile Design
- Attractive Architectural Styling
- Quick and Easy Mounting
- Bottom Hinged to Prevent Leakage

ORDERING INFORMATION

CATALOG #	DESCRIPTION	LUMENS	CCT	REPLACES UP TO	VOLTS
WSPS12LED	12W LED SlimPak Pro	1,326	4500K	70W MH	120-277
WSPS20LED	20W LED SlimPak Pro	2,228	4500K	100W MH	120-277
WSPS40LED*	40W LED SlimPak Pro	4,211	4500K	175W MH	120-277

Specs shown are for 4500K CCT. Also available in 3000K, 4000K and 5000K. See Cut Sheet for more information.
*Add Suffix EB for Emergency Battery Back Up. Requires larger deep back housing (WSPLD).

FOOTCANDLES ON THE GROUND

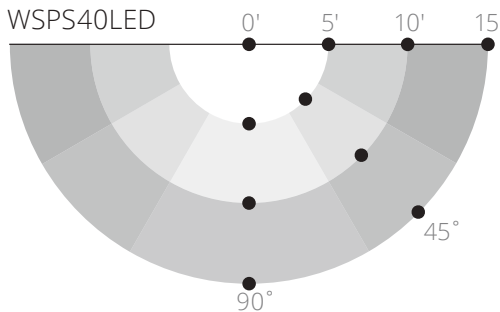

12' Mtg Height

14' Mtg Height

	90°	45°		90°	45°
0'	14.7	14.7	0'	10.6	10.6
5'	14.8	12.5	5'	11.1	9.7
10'	8.3	6.8	10'	7.3	6.1
15'	4.3	3.3	15'	4.3	3.4

Average **8.4** Average **6.9**

OPTIONS

ADD SUFFIX #	DESCRIPTION	ADD SUFFIX #	DESCRIPTION
PC	120V Photocontrol	PM	208-277V Photocontrol

ENERGY SAVINGS

LED		HID			
WATTAGE	ANNUAL COST	SOURCE WATTAGE	TOTAL WATTAGE USED	ANNUAL COST	ANNUAL SAVINGS
12	\$5	50	72	\$52	\$47
12	\$5	70	90	\$59	\$54
20	\$9	70	90	\$59	\$50
20	\$9	100	129	\$77	\$68
40	\$18	150	185	\$100	\$82
40	\$18	175	210	\$112	\$94

QUICK & EASY INSTALLATION



Unscrew door with Phillips screw driver.



Using the leveling bubble in the wall mounting box, level the fixture & attach to wall.



Secure door to back box with hinge. Complete wiring. Tighten door with screws.



*The majority of Atlas Lighting Products are assembled in USA facilities by an American Workforce utilizing both Domestic and Foreign components
*Qualifies for Buy American under ARRA

200,000+ HOURS



WSPL Series

60-80 Watt LED SlimPak Pro REPLACES UP TO 400W MH



- Slim Low Profile Design
- Attractive Architectural Styling
- Quick and Easy Mounting
- Bottom Hinged to Prevent Leakage



Patent Pending

8.88"Wx9.4"Hx5.25"D
7.9 LBS

- WSPL60LED / WSPL80LED
- 6,635 / 8,396 **LUMENS** ☀️
- 60 / 80 **WATTS** ⚡
- 111 / 108 **LPW** 💰
- 75 **CRI** Ⓢ
- 4500K **CCT** 🌈
- 0-10V **DIMMING** 📉
- REC MNT HT** 📏
- 14-16 FT / 18-20 FT

ORDERING INFORMATION

CATALOG #	DESCRIPTION	LUMENS	CCT	REPLACES UP TO	VOLTS
WSPL60LED*	60W LED SlimPak Pro	6,635	4500K	250W MH	120-277
WSPL80LED	80W LED SlimPak Pro	8,396	4500K	400W MH	120-277

Specs shown are for 4500K CCT. Also available in 3000K, 4000K and 5000K. See Cut Sheet for more information.
*Add Suffix EB for Emergency Battery Back Up. Requires deep back housing (WSPLD).

FOOTCANDLES ON THE GROUND

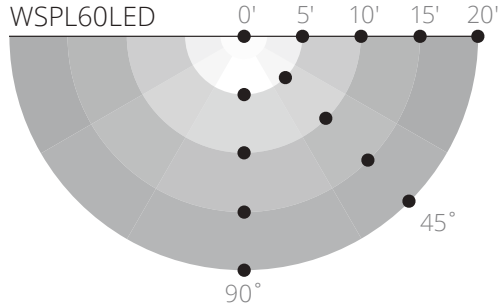

	14' Mtg Height		16' Mtg Height	
	90°	45°	90°	45°
0'	18.4	18.4	14.0	14.0
5'	19.0	17.0	14.8	13.5
10'	11.5	10.7	10.3	9.5
15'	6.4	5.6	6.2	5.6
20'	3.7	3.1	3.8	3.2

Average **10.1** Average **8.7**

OPTIONS

ADD SUFFIX #	DESCRIPTION	ADD SUFFIX #	DESCRIPTION
PC	120V Photocontrol	PM	208-277V Photocontrol

ENERGY SAVINGS

LED		HID			
WATTAGE	ANNUAL COST	SOURCE WATTAGE	TOTAL WATTAGE USED	ANNUAL COST	ANNUAL SAVINGS
60	\$26	200	232	\$128	\$102
60	\$26	250	285	\$150	\$124
60	\$26	400	458	\$226	\$200
80	\$35	200	232	\$128	\$93
80	\$35	250	285	\$150	\$115
80	\$35	400	458	\$226	\$191

QUICK & EASY INSTALLATION

- Unscrew door with Phillips screw driver.
- Using the leveling bubble in the wall mounting box, level the fixture & attach to wall.
- Secure door to back box with hinge. Complete wiring. Tighten door with screws.



*The majority of Atlas Lighting Products are assembled in USA facilities by an American Workforce utilizing both Domestic and Foreign components
*Qualifies for Buy American under ARRA



WPS Series

13-27 Watt LED Wall Pak Pro

REPLACES UP TO 100W MH



WPS13LED / WPS27LED

1,629 / 3,132 **LUMENS**

13 / 27 **WATTS**

121 / 114 **LPW**

80 / 82 **CRI**

4500K **CCT**

0-10V **DIMMING**

REC MNT HT
8-10 FT / 10-12 FT



6.29"Wx6.28"Hx7.99"D
7.5 LBS

Design is Protected
by U.S. Patent No
D710,530 and D752,274

- Eliminates Glare & Offensive Light
- Less Wasted Light
- More Footcandles on the Ground
- Labor Saving: Quick and Secure Mounting

ORDERING INFORMATION

CATALOG #	DESCRIPTION	LUMENS	CCT	REPLACES UP TO	VOLTS
WPS13LED	13W LED Wall Pak Pro	1,629	4500K	70W MH	120-277
WPS27LED	27W LED Wall Pak Pro	3,132	4500K	100W MH	120-277

Specs shown are for 4500K CCT. Also available in 3000K, 4000K and 5000K. See Cut Sheet for more information.

FOOTCANDLES ON THE GROUND

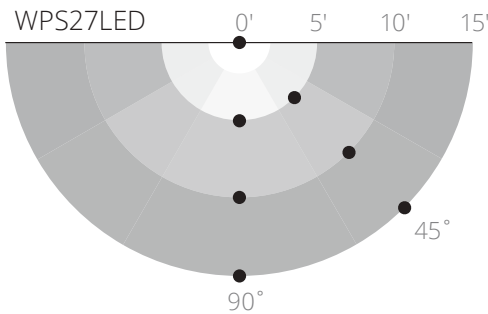

10' Mtg Height

12' Mtg Height

	90°	45°		90°	45°
0'	14.7	14.7	0'	10.3	10.3
5'	11.7	10.3	5'	9.1	8.2
10'	4.7	4.4	10'	4.6	4.3
15'	1.9	1.9	15'	2.1	2.1

Average **6.6** Average **5.5**

OPTIONS

ADD SUFFIX #	DESCRIPTION	ADD SUFFIX #	DESCRIPTION
PC	120V Photocontrol	PM	208-277V Photocontrol

ENERGY SAVINGS

LED		HID			
WATTAGE	ANNUAL COST	SOURCE WATTAGE	TOTAL WATTAGE USED	ANNUAL COST	ANNUAL SAVINGS
13	\$6	50	72	\$52	\$46
13	\$6	70	90	\$59	\$53
27	\$12	50	72	\$52	\$40
27	\$12	70	90	\$59	\$47
27	\$12	100	129	\$77	\$65

QUICK & EASY INSTALLATION



Secure Mounting Plate with back box to wall



Slide fixture housing onto mounting box



Connect wires & return them to mounting box



Replace bottom plate on quick mount box



*The majority of Atlas Lighting Products are assembled in USA facilities by an American Workforce utilizing both Domestic and Foreign components
*Qualifies for Buy American under ARRA



WPM Series

43-64 Watt LED Wall Pak Pro

REPLACES UP TO 400W MH



- Eliminates Glare & Offensive Light
- Less Wasted Light
- More Footcandles on the Ground
- Labor Saving: Quick and Secure Mounting



Design is Protected by U.S. Patent No. D772,474 and D752,274

9.29"Wx6.25"Hx9.06"D
10 LBS

WPM43LED / WPM64LED

5,025 / 6,983 **LUMENS** ☀️

42 / 64 **WATTS** ⚡

116 / 114 **LPW** 💰

80 **CRI** ⊕

4500K **CCT** 🔌

0-10V **DIMMING** ⚙️

REC MNT HT 📏
12-14 FT / 16-18 FT

ORDERING INFORMATION

CATALOG #	DESCRIPTION	LUMENS	CCT	REPLACES UP TO	VOLTS
WPM43LED	43W LED Wall Pak Pro	5,025	4500K	175W MH	120-277
WPM64LED	64W LED Wall Pak Pro	6,983	4500K	400W MH	120-277

Specs shown are for 4500K CCT. Also available in 3000K, 4000K and 5000K. See Cut Sheet for more information.

FOOTCANDLES ON THE GROUND

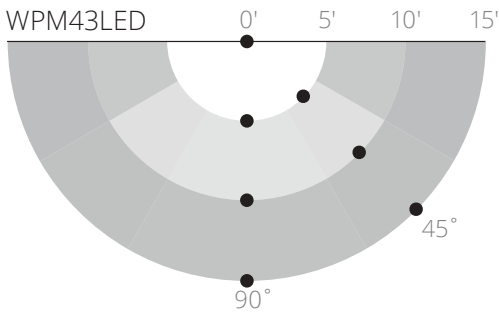

12' Mtg Height

14' Mtg Height

	90°	45°		90°	45°
0'	15.8	15.8	0'	11.6	11.6
5'	13.9	12.5	5'	10.6	9.8
10'	6.9	6.6	10'	6.3	5.9
15'	3.3	3.1	15'	3.3	3.2

Average **8.4**

Average **7.0**

OPTIONS

ADD SUFFIX #	DESCRIPTION	ADD SUFFIX #	DESCRIPTION
PC	120V Photocontrol	4	480V Driver
PM	208-277V Photocontrol		

ENERGY SAVINGS

LED		HID			
WATTAGE	ANNUAL COST	SOURCE WATTAGE	TOTAL WATTAGE USED	ANNUAL COST	ANNUAL SAVINGS
43	\$19	150	185	\$100	\$81
43	\$19	175	210	\$112	\$93
64	\$28	200	232	\$128	\$100
64	\$28	250	285	\$150	\$122
64	\$28	400	458	\$226	\$198

QUICK & EASY INSTALLATION



Secure Mounting Plate with back box to wall



Slide fixture housing onto mounting box



Connect wires & return them to mounting box



Replace bottom plate on quick mount box



*The majority of Atlas Lighting Products are assembled in USA facilities by an American Workforce utilizing both Domestic and Foreign components
*Qualifies for Buy American under ARRA



WPL86LED

86 Watt LED Wall Pak Pro

REPLACES UP TO 400W MH



WPL86LED / WPL102LED

10,730 / 12,720 **LUMENS**

86 / 102 **WATTS**

121 / 125 **LPW**

80 / 83 **CRI**

4500K **CCT**

0-10V **DIMMING**

REC MNT HT
18-20 FT / 22-25 FT



12"Wx8.79"Hx12.5"D
21.5 LBS

Design is Protected
by U.S. Patent No.
D740,997 and D752,274

- Eliminates Glare & Offensive Light
- Less Wasted Light
- More Footcandles on the Ground
- Labor Saving: Quick and Secure Mounting

ORDERING INFORMATION

CATALOG #	DESCRIPTION	LUMENS	CCT	REPLACES UP TO	VOLTS
WPL86LED	86W LED Wall Pak Pro	10,730	4500K	400W MH	120-277
WPL102LED	102W LED Wall Pak Pro	12,720	4500K	400W MH	120-277

Specs shown are for 4500K CCT. Also available in 3000K, 4000K and 5000K. See Cut Sheet for more information.

FOOTCANDLES ON THE GROUND

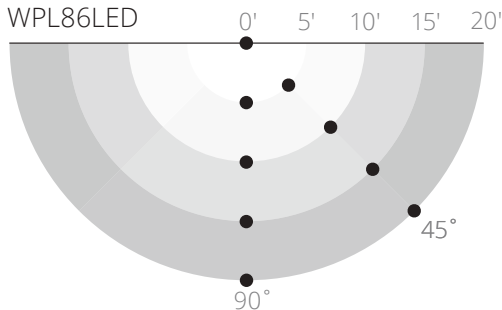

18' Mtg Height

20' Mtg Height

	90°	45°		90°	45°
0'	14.8	14.8	0'	12.1	12.1
5'	14.3	13.6	5'	11.8	11.3
10'	10.5	9.9	10'	9.2	8.7
15'	6.9	6.4	15'	6.4	6.1
20'	4.4	4.1	20'	4.4	4.1

Average **9.1**

Average **8.0**

OPTIONS

ADD SUFFIX #	DESCRIPTION	ADD SUFFIX #	DESCRIPTION
PC	120V Photocontrol	EB	Emergency Back-Up
PM	208-277V Photocontrol	4	480V Driver

ENERGY SAVINGS

LED			HID		
WATTAGE	ANNUAL COST	SOURCE WATTAGE	TOTAL WATTAGE USED	ANNUAL COST	ANNUAL SAVINGS
86	\$38	200	232	\$128	\$90
86	\$38	250	285	\$150	\$112
86	\$38	400	458	\$226	\$188
102	\$45	200	232	\$128	\$83
102	\$45	250	285	\$150	\$105
102	\$45	400	458	\$226	\$181

QUICK & EASY INSTALLATION



Secure Mounting Plate with back box to wall



Slide fixture housing onto mounting box



Connect wires & return them to mounting box



Replace bottom plate on quick mount box



*The majority of Atlas Lighting Products are assembled in USA facilities by an American Workforce utilizing both Domestic and Foreign components

*Qualifies for Buy American under ARRA

200,000+ HOURS



WLCFC / WLMFC



27-64 Watt LED Full Cut-Off Wall Light

REPLACES UP TO 400W MH

- Eliminates Glare & Offensive Light
- Less Wasted Light
- More Footcandles on the Ground



Patent Pending

8.75"Wx8.5"Hx9.25"D
6.6 LBS

14.18"Wx9.08"Hx11.5"D
11.9 LBS

ORDERING INFORMATION

CATALOG #	DESCRIPTION	LUMENS	WATTS	LPW	CRI	CCT	REPLACES UP TO	VOLTS
WLCFC27LED	27W LED Full Cut-Off Wall Light	3,411	27	129	82	4500K	100W MH	120-277
WLMFC43LED	43W LED Full Cut-Off Wall Light	5,366	43	130	82	4500K	175W MH	120-277
WLMFC64LED	64W LED Full Cut-Off Wall Light	8,131	64	132	82	4500K	400W MH	120-277

Specs shown are for 4500K CCT. Also available in 3000K, 4000K and 5000K. See Cut Sheet for more information.

FOOTCANDLES ON THE GROUND

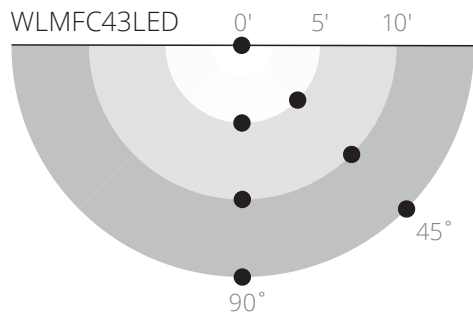

	12' Mtg Height		14' Mtg Height	
	90°	45°	90°	45°
0'	16.3	16.3	11.9	11.9
5'	14.2	13.0	10.9	10.1
10'	6.8	6.7	6.2	6.1
15'	3.2	3.1	3.2	3.2
Average	8.6		7.1	

OPTIONS

ADD SUFFIX #	DESCRIPTION	ADD SUFFIX #	DESCRIPTION
PC	120V Photocontrol	EB*	Emergency Back-Up
PM	208-277V Photocontrol	4	480V Driver

*WLMFC only

ENERGY SAVINGS

LED		HID			
WATTAGE	ANNUAL COST	SOURCE WATTAGE	TOTAL WATTAGE USED	ANNUAL COST	ANNUAL SAVINGS
27	\$12	70	90	\$59	\$47
27	\$12	100	129	\$77	\$65
43	\$19	150	185	\$100	\$81
43	\$19	175	210	\$112	\$93
64	\$28	250	285	\$150	\$122
64	\$28	400	458	\$226	\$198



*The majority of Atlas Lighting Products are assembled in USA facilities by an American Workforce utilizing both Domestic and Foreign components
*Qualifies for Buy American under ARRA



DD2G42LED5K

42 Watt LED Dusk to Dawn

REPLACES UP TO 400W MH



- 4,805 **LUMENS**
- 42 **WATTS**
- 123 **LPW**
- 70+ **CRI**
- 5000K **CCT**
- 0-10V **DIMMING**
- REC MNT HT**
12 FT to 14 FT



7.55"Wx6.9"Hx11.4"D
5.7 LBS

- Smooth & Even Light Pattern
- Twist Lock Photocontrol
- Glare Free Light Output

ORDERING INFORMATION

CATALOG #	DESCRIPTION	REPLACES UP TO	VOLTS
DD2G42LED5K	42W LED Dusk to Dawn	175W MV	120-277

FOOTCANDLES ON THE GROUND

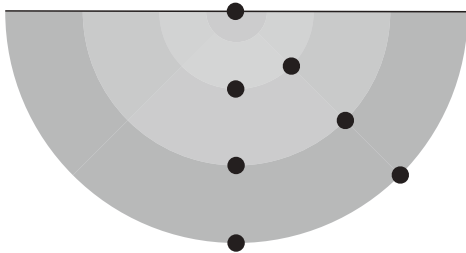

	90°	45°		90°	45°
0'	4.4	4.4	0'	3.3	3.3
5'	5.3	5.1	5'	3.7	3.6
10'	4.4	4.1	10'	3.6	3.4
15'	2.2	2.2	15'	2.2	2.1
Average	3.9		Average	3.1	

ACCESSORIES

CATALOG #	DESCRIPTION	CATALOG #	DESCRIPTION
21DDA	21" Dusk to Dawn Arm	8DDL	8" Dusk to Dawn Lens

ENERGY SAVINGS

LED			HID		
WATTAGE	ANNUAL COST		SOURCE WATTAGE	TOTAL WATTAGE USED	ANNUAL SAVINGS
42	\$18		100	129	\$77
42	\$18		150	185	\$100
42	\$18		175	250	\$108



Independence Series



LED Low Profile Canopy Light

REPLACES UP TO 250W MH

- Slim low profile design
- Heavy duty die-cast aluminum housing
- Smooth even light pattern with low glare



10.29"Wx3.9"Hx10.29"D

LPC5L45K / LPC7L45K
 5,100 / 7,001 **LUMENS**
 36 / 52 **WATTS**
 143 / 134 **LPW**
 83 / 82 / 82 / 82 **CRI**
 4500K **CCT**
 0-10V **DIMMING**

ORDERING INFORMATION

CATALOG #	DESCRIPTION	CCT	REPLACES UP TO	VOLTS
LPC5L45K	5,000 Lumen LED Low Profile Canopy Light	4500K	175W MH	120-277
LPC7L45K	7,000 Lumen LED Low Profile Canopy Light	4500K	250W MH	120-277

Specs shown are for 4500K CCT. Also available in 4000K and 5000K. See Cut Sheet for more information.

ORDERING FORMAT

LPC

PRODUCT SERIES
 LPC = Independence
 Low Profile
 Canopy

5L

LUMEN PACKAGE
 5L = 5,000 Lumens
 7L = 7,000 Lumens

45K

COLOR TEMP.
 4K = 4000K
 45K = 4500K
 5K = 5000K

CONTROLS
 Blank = Dimming (0-10V)

VOLTAGE
 Blank = 120-277

COLOR
 Blank = Bronze
 WT = White*
 BK = Black*
 *optional with adder

QUICK & EASY INSTALLATION

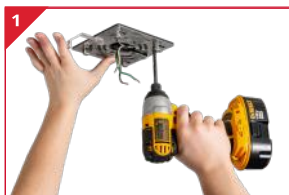

200,000+ HOURS



*The majority of Atlas Lighting Products are assembled in USA facilities by an American Workforce utilizing both Domestic and Foreign components
 *Qualifies for Buy American under ARRA



CPM Series

25-80 Watt LED Low Profile Canopy

REPLACES UP TO 400W MH



CPM25LED / CPM40LED / CPM60LED / CPM80LED

3,363 / 5,401 / 7,514 / 9,691 **LUMENS**

25 / 40 / 60 / 80 **WATTS**

137 / 133 / 127 / 122 **LPW**

83 / 82 / 82 / 82 **CRI**

4500K **CCT**

0-10V **DIMMING**



11.90"Wx4.88"Hx11.90"D
10 LBS

Patent
Pending

- Low Profile Design – Less than 5"
- 91% efficient lens
- Easy Installation
- Emergency Back Up Available

ORDERING INFORMATION

CATALOG #	DESCRIPTION	LUMENS	CCT	REPLACES UP TO	VOLTS
CPM25LED	25 Watt LED Low Profile Canopy	3,363	4500K	100W MH	120-277
CPM40LED	40 Watt LED Low Profile Canopy	5,401	4500K	175W MH	120-277
CPM60LED	60 Watt LED Low Profile Canopy	7,514	4500K	250W MH	120-277
CPM80LED	80 Watt LED Low Profile Canopy	9,691	4500K	400W MH	120-277

Specs shown are for 4500K CCT. Also available in 3000K, 4000K and 5000K. See Cut Sheet for more information.

ORDERING FORMAT

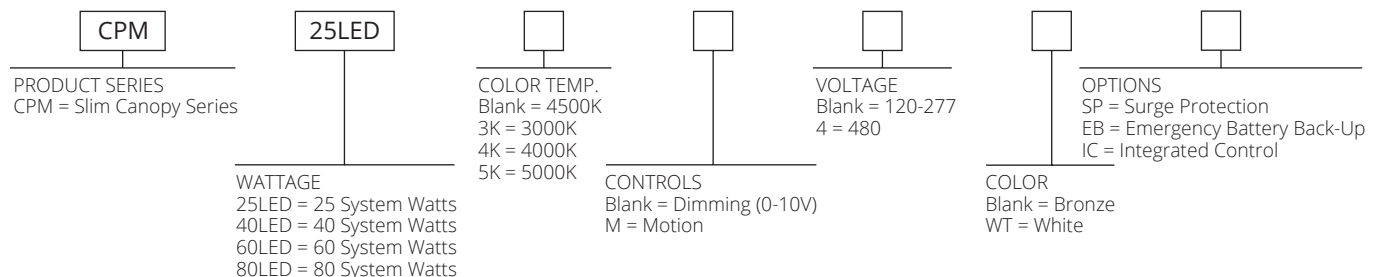

QUICK & EASY INSTALLATION

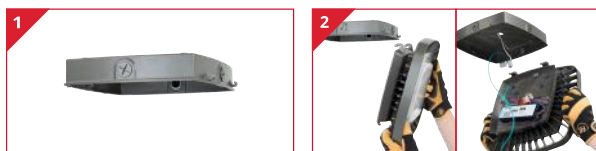

Attach top housing to either mounting box or conduit



Hang bottom housing to the top by connecting the hinges



Wire fixture using provided quick connect connectors



Simply Close fixture and tighten 2 screws

OPTIONS

ADD SUFFIX #	DESCRIPTION	ADD SUFFIX #	DESCRIPTION
4	480V Driver	EB	Emergency Back-Up
IC	Integrated Control	M	Motion

ENERGY SAVINGS

LED		HID			
WATTAGE	ANNUAL COST	SOURCE WATTAGE	TOTAL WATTAGE USED	ANNUAL COST	ANNUAL SAVINGS
25	\$11	100	129	\$77	\$66
40	\$18	175	210	\$112	\$94
60	\$26	250	285	\$150	\$124
80	\$35	400	458	\$226	\$191



*The majority of Atlas Lighting Products are assembled in USA facilities by an American Workforce utilizing both Domestic and Foreign components
*Qualifies for Buy American under ARRA



PGM Series



25-80W LED Low Profile Parking Garage Light

REPLACES UP TO 400W MH

- Low Profile Design – Less than 5"
- Optics designed for parking garage applications
- Easy Installation
- Emergency Back Up Available



Patent Pending

11.90"Wx4.88"Hx11.90"D
10 LBS

PGM25LED / PGM40LED / PGM60LED / PGM80LED

3,363 / 5,528 / 7,693 / 9,830 **LUMENS** ☀️

25 / 40 / 60 / 80 **WATTS** ⚡

138 / 134 / 130 / 124 **LPW** 💰

83 / 82 / 82 / 82 **CRI** Ⓢ

4500K **CCT** 🔥

0-10V **DIMMING** ⚙️

ORDERING INFORMATION

CATALOG #	DESCRIPTION	LUMENS	CCT	REPLACES UP TO	VOLTS
PGM25LED	25 Watt LED Low Profile Parking Garage Light	3,363	4500K	100W MH	120-277
PGM40LED	40 Watt LED Low Profile Parking Garage Light	5,528	4500K	175W MH	120-277
PGM60LED	60 Watt LED Low Profile Parking Garage Light	7,693	4500K	250W MH	120-277
PGM80LED	80 Watt LED Low Profile Parking Garage Light	9,830	4500K	400W MH	120-277

Specs shown are for 4500K CCT. Also available in 3000K, 4000K and 5000K. See Cut Sheet for more information.

ORDERING FORMAT

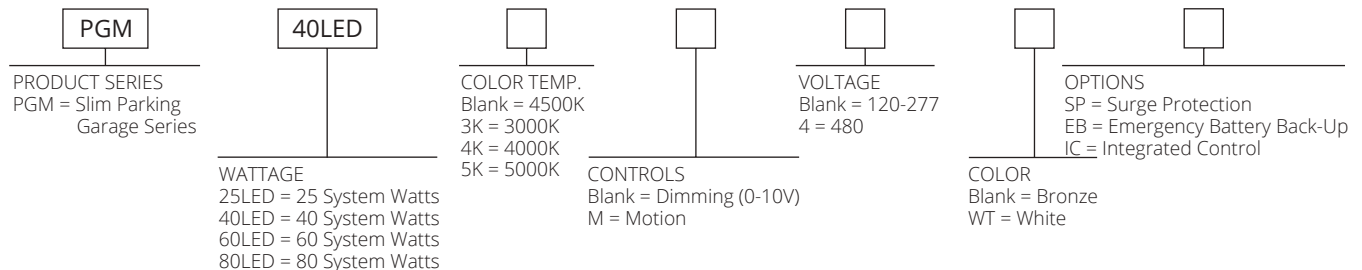

QUICK & EASY INSTALLATION



Attach top housing to either mounting box or conduit



Hang bottom housing to the top by connecting the hinges



Wire fixture using provided quick connect connectors



Simply Close fixture and tighten 2 screws

OPTIONS

ADD SUFFIX #	DESCRIPTION	ADD SUFFIX #	DESCRIPTION
4	480V Driver	EB	Emergency Back-Up
IC	Integrated Control	M	Motion

ENERGY SAVINGS

LED		HID			
WATTAGE	ANNUAL COST	SOURCE WATTAGE	TOTAL WATTAGE USED	ANNUAL COST	ANNUAL SAVINGS
25	\$11	100	129	\$77	\$66
40	\$18	175	210	\$112	\$94
60	\$26	250	285	\$150	\$124
80	\$35	400	458	\$226	\$191



*The majority of Atlas Lighting Products are assembled in USA facilities by an American Workforce utilizing both Domestic and Foreign components
*Qualifies for Buy American under ARRA



FS Series Small Housing

3,000-6,000 Lumen LED Independence Flood
REPLACES UP TO 175W MH



FS3L45K / FS6L45K

3,463 / 5,765 **LUMENS**

27 / 48 **WATTS**

127 / 121 **LPW**

80 **CRI**

4500K **CCT**

0-10V **DIMMING**

REC SETBACK
16 FT / 25 FT



8.9"Wx8.8"Hx1.9"D
3.3 LBS

- High light output with low glare
- One piece die cast aluminum heatsink providing maximum heat dissipation
- External air flow fins dissipate heat
- High performance optics provide smooth even light

ORDERING INFORMATION

CATALOG #	DESCRIPTION	CCT	REPLACES UP TO	VOLTS
FS3L45K	3,000 Lumen LED Independence Flood Light	4500K	100W MH	120-277
FS6L45K	6,000 Lumen LED Independence Flood Light	4500K	175W MH	120-277

Specs shown are for 4500K CCT. Also available in 4000K and 5000K. See Cut Sheet for more information.

OPTIONS

ADD SUFFIX #	DESCRIPTION	ADD SUFFIX #	DESCRIPTION
PC	120V Photocontrol	SP	Surge Protector
PM	208-277V Photocontrol		



CATALOG #	DESCRIPTION
500-082BZ	Post-Top Fitter



ENERGY SAVINGS

LED			HID		
WATTAGE	ANNUAL COST	SOURCE WATTAGE	TOTAL WATTAGE USED	ANNUAL COST	ANNUAL SAVINGS
27	\$12	70	90	\$59	\$47
27	\$12	100	129	\$77	\$65
48	\$21	150	185	\$100	\$79
48	\$21	175	210	\$112	\$91

APPLICATIONS:



*The majority of Atlas Lighting Products are assembled in USA facilities by an American Workforce utilizing both Domestic and Foreign components
*Qualifies for Buy American under ARRA



FM Series Medium Housing

8,000 Lumen LED Independence Flood

REPLACES UP TO 400W MH



- High light output with low glare
- One piece die cast aluminum heatsink providing maximum heat dissipation
- External air flow fins dissipate heat
- High performance optics provide smooth even light



12.04"Wx10.6"Hx2.9"D
5.7 LBS

FM8L45K

8775 **LUMENS**

68 **WATTS**

128 **LPW**

80 **CRI**

4500K **CCT**

0-10V **DIMMING**

REC SETBACK
15 FT to 30 FT

ORDERING INFORMATION

CATALOG #	DESCRIPTION	CCT	REPLACES UP TO	VOLTS
FM8L45K	8,000 Lumen LED Independence Flood Light	4500K	400W MH	120-277

Specs shown are for 4500K CCT. Also available in 4000K and 5000K. See Cut Sheet for more information.



OPTIONS

ADD SUFFIX #	DESCRIPTION	ADD SUFFIX #	DESCRIPTION
PC	120V Photocontrol	SP	Surge Protector
PM	208-277V Photocontrol		

CATALOG #	DESCRIPTION
500-082BZ	Post-Top Fitter



ENERGY SAVINGS

LED		HID			
WATTAGE	ANNUAL COST	SOURCE WATTAGE	TOTAL WATTAGE USED	ANNUAL COST	ANNUAL SAVINGS
68	\$30	250	285	\$150	\$120
68	\$30	400	458	\$226	\$196

APPLICATIONS:



*The majority of Atlas Lighting Products are assembled in USA facilities by an American Workforce utilizing both Domestic and Foreign components
*Qualifies for Buy American under ARRA



PFSXW Series Small Housing

27 Watt LED Extra Wide Flood

REPLACES UP TO 100W MH



PFSXW27LED

- 3,132 **LUMENS**
- 27 **WATTS**
- 114 **LPW**
- 80 **CRI**
- 4500K **CCT**
- 0-10V **DIMMING**
- REC SETBACK**
20 FT



6.36"Wx9.36"Hx7.53"D
7 LBS Design is Protected by U.S. Patent No. D710,530

- Extra Wide Distribution
- Recommended for Accent Lighting
- For Short Set Backs, Signs & Wall Wash Applications

ORDERING INFORMATION

CATALOG #	DESCRIPTION	CCT	REPLACES UP TO	VOLTS
PFSXW27LED	27W LED Extra Wide Flood Light	4500K	100W MH	120-277

Specs shown are for 4500K CCT. Also available in 3000K, 4000K and 5000K. See Cut Sheet for more information.



OPTIONS

ADD SUFFIX #	DESCRIPTION	ADD SUFFIX #	DESCRIPTION
PC	120V Photocontrol	SP	Surge Protector
PM	208-277V Photocontrol		
CATALOG #	DESCRIPTION		
500-082BZ	Post-Top Fitter		



ENERGY SAVINGS

LED			HID		
WATTAGE	ANNUAL COST	SOURCE WATTAGE	TOTAL WATTAGE USED	ANNUAL COST	ANNUAL SAVINGS
27	\$12	50	72	\$52	\$40
27	\$12	70	90	\$59	\$47
27	\$12	100	129	\$77	\$65

APPLICATIONS:



*The majority of Atlas Lighting Products are assembled in USA facilities by an American Workforce utilizing both Domestic and Foreign components
*Qualifies for Buy American under ARRA



Small Housing PFS Series

22 Watt LED Optic Flood Light

REPLACES UP TO 100W MH



Design is Protected
by U.S. Patent
No. D710,530

6.36"Wx9.36"Hx7.53"D
7 LBS

- Optical Grade Individual Acrylic Lenses
- More Footcandles Delivered to the Target
- Less Glare and Wasted Light

PFS22LED
1,978 **LUMENS**

22 **WATTS**

93 **LPW**

70 **CRI**

4500K **CCT**

0-10V **DIMMING**

REC SETBACK
8 FT to 16 FT

ORDERING INFORMATION

CATALOG #	DESCRIPTION	CCT	REPLACES UP TO	VOLTS
PFS22LED	22W LED Wide Flood Light	4500K	100W MH	120-277

Specs shown are for 4500K CCT. Also available in 3000K, 4000K and 5000K. See Cut Sheet for more information.



OPTIONS

ADD SUFFIX #	DESCRIPTION	ADD SUFFIX #	DESCRIPTION
PC	120V Photocontrol	SP	Surge Protector
PM	208-277V Photocontrol		

CATALOG #	DESCRIPTION
500-082BZ	Post-Top Fitter



ENERGY SAVINGS

LED		HID			
WATTAGE	ANNUAL COST	SOURCE WATTAGE	TOTAL WATTAGE USED	ANNUAL COST	ANNUAL SAVINGS
22	\$10	50	72	\$52	\$42
22	\$10	70	90	\$59	\$49
22	\$10	100	129	\$77	\$67

APPLICATIONS:



200,000+ HOURS



*The majority of Atlas Lighting Products are assembled in USA facilities by an American Workforce utilizing both Domestic and Foreign components
*Qualifies for Buy American under ARRA



PFMXW Series Medium Housing

43 Watt LED Extra Wide Flood

REPLACES UP TO 175W MH



PFMXW43LED

5,025 **LUMENS**

43 **WATTS**

116 **LPW**

80 **CRI**

4500K **CCT**

0-10V **DIMMING**

REC SETBACK
25 FT



- Extra Wide Distribution
- Smooth, even and uniform light pattern

9.36"Wx10.36"Hx7.57"D
10 LBS

Design is Protected
by U.S. Patent
No. D772,474

ORDERING INFORMATION

CATALOG #	DESCRIPTION	CCT	REPLACES UP TO	VOLTS
PFMXW43LED	43W LED Extra Wide Flood Light	4500K	175W MH	120-277

Specs shown are for 4500K CCT. Also available in 3000K, 4000K and 5000K. See Cut Sheet for more information.



OPTIONS

ADD SUFFIX #	DESCRIPTION	ADD SUFFIX #	DESCRIPTION
PC	120V Photocontrol	4	480V Driver
PM	208-277V Photocontrol	SP	Surge Protector

CATALOG #	DESCRIPTION
500-082BZ	Post-Top Fitter



ENERGY SAVINGS

LED			HID		
WATTAGE	ANNUAL COST	SOURCE WATTAGE	TOTAL WATTAGE USED	ANNUAL COST	ANNUAL SAVINGS
43	\$19	150	185	\$100	\$81
43	\$19	175	210	\$112	\$93

APPLICATIONS:



*The majority of Atlas Lighting Products are assembled in USA facilities by an American Workforce utilizing both Domestic and Foreign components
*Qualifies for Buy American under ARRA



Medium Housing PFM Series



43 Watt LED Optic Flood Light

REPLACES UP TO 175W MH



Design is Protected by U.S. Patent No. D772,474
9.36"Wx10.36"Hx7.57"D
10 LBS

- Optical Grade Individual Acrylic Lenses
- More Footcandles Delivered to the Target
- Less Glare and Wasted Light

PFM43LED
4,010 **LUMENS**
43 **WATTS**
97 **LPW**
70 **CRI**
4500K **CCT**
0-10V **DIMMING**
REC SETBACK
12 FT to 25 FT

ORDERING INFORMATION

CATALOG #	DESCRIPTION	CCT	REPLACES UP TO	VOLTS
PFM43LED	43W LED Wide Flood Light	4500K	175W MH	120-277

Specs shown are for 4500K CCT. Also available in 3000K, 4000K and 5000K. See Cut Sheet for more information.



OPTIONS

ADD SUFFIX #	DESCRIPTION	ADD SUFFIX #	DESCRIPTION
PC	120V Photocontrol	4	480V Driver
PM	208-277V Photocontrol	SP	Surge Protector

CATALOG #	DESCRIPTION
500-082BZ	Post-Top Fitter



ENERGY SAVINGS

LED		HID			
WATTAGE	ANNUAL COST	SOURCE WATTAGE	TOTAL WATTAGE USED	ANNUAL COST	ANNUAL SAVINGS
43	\$19	100	129	\$77	\$58
43	\$19	150	185	\$100	\$81
43	\$19	175	210	\$112	\$93

APPLICATIONS:



200,000+ HOURS



*The majority of Atlas Lighting Products are assembled in USA facilities by an American Workforce utilizing both Domestic and Foreign components
*Qualifies for Buy American under ARRA



HXW Series



8,000-16,000 Lumen Extra Wide Flood
REPLACES UP TO 400W MH



SELECTABLE

HSXW8-16L

8,000-16,000 **LUMENS**

62-120 **WATTS**

Up to 161 **LPW**

70 **CRI**

3K/4K/5K **CCT**

0-10V **DIMMING**

REC SETBACK
35 FT / 40 FT



TRUNNION:
11.00"Wx11.42"Hx6.45"D

KNUCKLE:
11.00"Wx11.24"Hx6.48"D

- Extra Wide Distribution
- Smooth, even and uniform light pattern
- Compact: 40% Smaller
- Selectable Flood: Reduce from 9 fixtures to 1

ORDERING INFORMATION

CATALOG #	DESCRIPTION	CCT	REPLACES UP TO	VOLTS
HXW8L	8,000 Lumen LED Extra Wide Flood Light	4500K	175W MH	120-277
HXW12L	12,000 Lumen LED Extra Wide Flood Light	4500K	250W MH	120-277
HXW16L	16,000 Lumen LED Extra Wide Flood Light	4500K	400W MH	120-277
HSXW8-16L	8,000-16,000 Lumen Selectable LED Extra Wide Flood Light	3000K, 4000K 5000K Selectable	175W - 400W MH	120-277

Fixed version also available in 3000K, 4000K and 5000K. See Cut Sheet for more information.
Knuckle mount standard. For Trunnion mount see ordering format on cut sheet.

CHANGE AT THE FLIP OF A SWITCH

Easy Access

Individual dip switches allow users to select color temperature and light output



OPTIONS

ADD SUFFIX #	DESCRIPTION	ADD SUFFIX #	DESCRIPTION
PC	120V Photocontrol	4	480V Driver
PM	208-277V Photocontrol	PR	Photo Receptacle*

*Must use adapter

ENERGY SAVINGS

LED			HID		
WATTAGE	ANNUAL COST	SOURCE WATTAGE	TOTAL WATTAGE USED	ANNUAL COST	ANNUAL SAVINGS
62	\$27	175	210	\$112	\$85
94	\$41	250	285	\$150	\$109
126	\$55	400	458	\$226	\$171

APPLICATIONS:



*The majority of Atlas Lighting Products are assembled in USA facilities by an American Workforce utilizing both Domestic and Foreign components
*Qualifies for Buy American under ARRA





8,000-16,000 Lumen Precision Optic Flood

REPLACES UP TO 400W MH

- XP - High Performance Extra Precision Optics Deliver More Footcandles
- Less Glare and Wasted Light
- Compact: 40% Smaller
- Selectable Flood: Reduce from 9 fixtures to 1



KNUCKLE:
11.00"Wx11.24"Hx6.48"D

TRUNNION:
11.00"Wx11.42"Hx6.45"D

- SELECTABLE**
HSXP68-16L
- 8,000-16,000 **LUMENS**
 - 62-120 **WATTS**
 - Up to 161 **LPW**
 - 70 **CRI**
 - 3K/4K/5K **CCT**
 - 0-10V **DIMMING**
 - REC SETBACK**
18-35 FT / 20-40 FT

ORDERING INFORMATION

CATALOG #	DESCRIPTION	CCT	REPLACES UP TO	VOLTS
HXP68L	8,000 Lumen LED Extra Precision Optics Flood Light	4500K	175W MH	120-277
HXP612L	12,000 Lumen LED Extra Precision Optics Flood Light	4500K	250W MH	120-277
HXP616L	16,000 Lumen LED Extra Precision Optics Flood Light	4500K	400W MH	120-277
HSXP68-16L	8,000-16,000 Lumen Selectable LED Extra Precision Optics Flood Light	3000K, 4000K 5000K Selectable	175W - 400W MH	120-277

Fixed version also available in 3000K, 4000K and 5000K. See Cut Sheet for more information.
Knuckle mount standard. For Trunnion mount see ordering format on cut sheet.

CHANGE AT THE FLIP OF A SWITCH

Easy Access

Individual dip switches allow users to select color temperature and light output



OPTIONS

ADD SUFFIX #	DESCRIPTION	ADD SUFFIX #	DESCRIPTION
PC	120V Photocontrol	4	480V Driver
PM	208-277V Photocontrol	PR	Photo Receptacle*

*Must use adapter

ENERGY SAVINGS

LED		HID			
WATTAGE	ANNUAL COST	SOURCE WATTAGE	TOTAL WATTAGE USED	ANNUAL COST	ANNUAL SAVINGS
62	\$27	175	210	\$112	\$85
93	\$41	250	285	\$150	\$109
120	\$53	400	458	\$226	\$173

APPLICATIONS:



200,000+ HOURS



*The majority of Atlas Lighting Products are assembled in USA facilities by an American Workforce utilizing both Domestic and Foreign components
*Qualifies for Buy American under ARRA



PFL2GXW Series Large Housing

20,000-25,000 Lumen LED Extra Wide Flood
REPLACES UP TO 400W MH



PFL2GXW20L / PFL2GXW25L

20,540 / 25,040 **LUMENS**

142 / 180 **WATTS**

144 / 139 **LPW**

70 **CRI**

4500K **CCT**

0-10V **DIMMING**

REC SETBACK
20-40 FT / 25-50 FT



TRUNNION:
12"Wx14.5"Hx12.25"D
25.8 LBS

SLIPFITTER:
23"Wx16.08"Hx12.25"D
26.6 LBS

Design is
Patent Pending

- Extra Wide Distribution
- Smooth, even and uniform light pattern
- Attractive Architectural Styling
- Hooded Glare Shield Face Frame

IP65 RATED

ORDERING INFORMATION

CATALOG #	DESCRIPTION	CCT	REPLACES UP TO	VOLTS
PFL2GXW20L	20,000 Lumen LED Extra Wide Flood Light w/ Trunnion	4500K	400W MH	120-277
PFL2GXW25L	25,000 Lumen LED Extra Wide Flood Light w/ Trunnion	4500K	400W MH	120-277

Specs shown are for 4500K CCT. Also available in 3000K, 4000K and 5000K. See Cut Sheet for more information. For Slipfitter mount see ordering format on cut sheet.

Cooling Fins Separate Driver & LED Housing

- Eliminating Cross Contamination of Heat

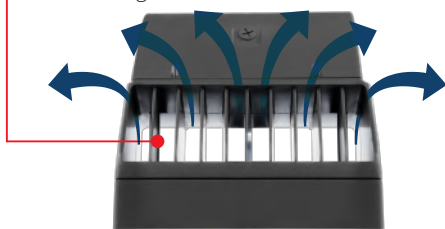

Airflow Assists in Cooling of both LEDs & Driver

Removable Gasketed Back for Easy Driver Access



OPTIONS

ADD SUFFIX #	DESCRIPTION	ADD SUFFIX #	DESCRIPTION
PC	120V Photocontrol	PR	Photo Receptacle
PM	208-277V Photocontrol	4	480V Driver
SP	Surge Protector		

ENERGY SAVINGS

LED		HID			
WATTAGE	ANNUAL COST	SOURCE WATTAGE	TOTAL WATTAGE USED	ANNUAL COST	ANNUAL SAVINGS
142	\$62	250	285	\$150	\$88
142	\$62	400	458	\$226	\$164
180	\$79	250	285	\$150	\$71
180	\$79	400	458	\$226	\$147

APPLICATIONS:



*The majority of Atlas Lighting Products are assembled in USA facilities by an American Workforce utilizing both Domestic and Foreign components
*Qualifies for Buy American under ARRA

200,000+ HOURS



PFL2GH Series Large Housing

20,000-25,000 Lumen LED Extreme Flood
REPLACES UP TO 400W MH



- High Performance Optics Deliver More Footcandles
- Optical Grade Individual Acrylic Lenses
- Attractive Architectural Styling
- Hooded Glare Shield Face Frame



Design is Patent Pending

TRUNNION:
12"Wx14.5"Hx12.25"D
25.8 LBS

SLIPFITTER:
23"Wx16.08"Hx12.25"D
26.6 LBS

PFL2GH20L / PFL2GH25L
17,994 / 20,766 / 25,312 **LUMENS** ☀️
125 / 142 / 179 **WATTS** ⚡️
144 / 145 / 141 **LPW** ⚡️
70 **CRI** ⊕
4500K **CCT** ⚡️
0-10V **DIMMING** ⚡️
REC SETBACK ⚡️
20-40 FT / 25-50 FT

IP65 RATED

ORDERING INFORMATION

CATALOG #	DESCRIPTION	CCT	REPLACES UP TO	VOLTS
PFL2GH20L	20,000 Lumen Extreme Flood Light w/ Trunnion	4500K	400W MH	120-277
PFL2GH25L	25,000 Lumen Extreme Flood Light w/ Trunnion	4500K	400W MH	120-277

Specs shown are for 4500K CCT. Also available in 3000K, 4000K and 5000K. See Cut Sheet for more information. For Slipfitter mount see ordering format on cut sheet.

Cooling Fins Separate Driver & LED Housing

- Eliminating Cross Contamination of Heat

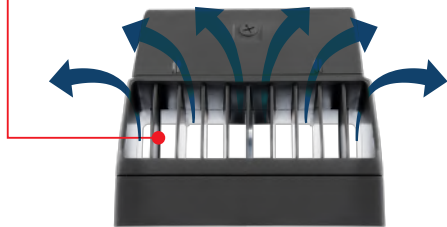

Airflow Assists in Cooling of both LEDs & Driver

Removable Gasketed Back for Easy Driver Access



OPTIONS

ADD SUFFIX #	DESCRIPTION	ADD SUFFIX #	DESCRIPTION
PC	120V Photocontrol	4	480V Driver
PM	208-277V Photocontrol	M	Motion
PR	Photo Receptacle	SP	Surge Protector

ENERGY SAVINGS

LED		HID			
WATTAGE	ANNUAL COST	SOURCE WATTAGE	TOTAL WATTAGE USED	ANNUAL COST	ANNUAL SAVINGS
142	\$62	400	458	\$226	\$164
179	\$78	400	458	\$226	\$148

APPLICATIONS:



*The majority of Atlas Lighting Products are assembled in USA facilities by an American Workforce utilizing both Domestic and Foreign components
*Qualifies for Buy American under ARRA



PFXL2GXW Series Extra Large Housing

33,000-50,000 Lumen LED Extra Wide Flood
REPLACES UP TO 1000W MH



PFXL2GXW33L / PFXL2GXW40L / PFXL2GXW50L

33,210 / 39,430 / 50,130 **LUMENS**

220 / 267 / 357 **WATTS**

151 / 148 / 141 **LPW**

70 **CRI**

4500K **CCT**

0-10V **DIMMING**

REC SETBACK
25-50 FT



TRUNNION:
16"Wx17.07"Hx12.21"D
44 LBS

SLIPFITTER:
16"Wx18.60"Hx12.21"D
45 LBS

Design is
Patent Pending

- Extra Wide Distribution
- Smooth, even and uniform light pattern
- Attractive Architectural Styling
- Hooded Glare Shield Face Frame

IP65 RATED

ORDERING INFORMATION

CATALOG #	DESCRIPTION	CCT	REPLACES UP TO	VOLTS
PFXL2GXW33L	33,000 Lumen Extra Wide Flood Light w/ Trunnion	4500K	1000W MH	120-277
PFXL2GXW40L	40,000 Lumen Extra Wide Flood Light w/ Trunnion	4500K	1000W MH	120-277
PFXL2GXW50L	50,000 Lumen Extra Wide Flood Light w/ Trunnion	4500K	1000W MH	120-277

Specs shown are for 4500K CCT. Also available in 3000K, 4000K and 5000K. See Cut Sheet for more information. For Slipfitter mount see ordering format on cut sheet.

Cooling Fins Separate Driver & LED Housing

- Eliminating Cross Contamination of Heat

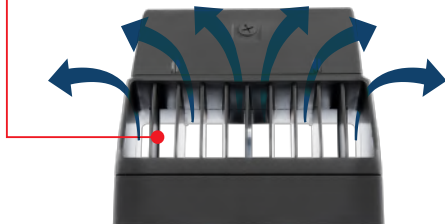

Airflow Assists in Cooling
of both LEDs & Driver

Removable Gasketed Back for Easy Driver Access



OPTIONS

ADD SUFFIX #	DESCRIPTION	ADD SUFFIX #	DESCRIPTION
PC	120V Photocontrol	4	480V Driver
PM	208-277V Photocontrol	M	Motion
PR	Photo Receptacle	SP	Surge Protector

ENERGY SAVINGS

LED		HID			
WATTAGE	ANNUAL COST	SOURCE WATTAGE	TOTAL WATTAGE USED	ANNUAL COST	ANNUAL SAVINGS
220	\$96	1000	1080	\$513	\$417
267	\$117	1000	1080	\$513	\$396
357	\$156	1000	1080	\$513	\$357

APPLICATIONS:



*The majority of Atlas Lighting Products are assembled in USA facilities by an American Workforce utilizing both Domestic and Foreign components
*Qualifies for Buy American under ARRA



PFXL2GH Series Extra Large Housing



33,000-50,000 Lumen LED Extreme Flood
REPLACES UP TO 1000W MH

- High Performance Optics Deliver More Footcandles
- Optical Grade Individual Acrylic Lenses
- Attractive Architectural Styling
- Hooded Glare Shield Face Frame



PFXL2GH33L / PFXL2GH40L / PFXL2GH50L
 32,936 / 38,933 / 48,173 **LUMENS** ☀️
 222 / 269 / 362 **WATTS** ⚡️
 148 / 145 / 133 **LPW** ⚡️
 70 **CRI** ⊕
 4500K **CCT** 🌈
 0-10V **DIMMING** 📏
REC SETBACK 25-50 FT 📏

Design is Patent Pending

SLIPFITTER:
16"Wx18.60"Hx12.21"D
45 LBS

TRUNNION:
16"Wx17.07"Hx12.21"D
44 LBS

IP65 RATED

ORDERING INFORMATION

CATALOG #	DESCRIPTION	REPLACES UP TO	VOLTS
PFXL2GH33L	33,000 Lumen Extreme Flood Light w/ Trunnion	1000W MH	120-277
PFXL2GH40L	40,000 Lumen Extreme Flood Light w/ Trunnion	1000W MH	120-277
PFXL2GH50L	50,000 Lumen Extreme Flood Light w/ Trunnion	1000W MH	120-277

Specs shown are for 4500K CCT. Also available in 3000K, 4000K and 5000K. See Cut Sheet for more information. For Slipfitter mount see ordering format on cut sheet.

Cooling Fins Separate Driver & LED Housing

- Eliminating Cross Contamination of Heat

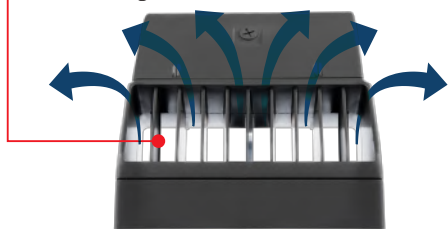

Airflow Assists in Cooling of both LEDs & Driver

Removable Gasketed Back for Easy Driver Access



OPTIONS

ADD SUFFIX #	DESCRIPTION	ADD SUFFIX #	DESCRIPTION
PC	120V Photocontrol	4	480V Driver
PM	208-277V Photocontrol	M	Motion
PR	Photo Receptacle	SP	Surge Protector

ENERGY SAVINGS

LED		HID			
WATTAGE	ANNUAL COST	SOURCE WATTAGE	TOTAL WATTAGE USED	ANNUAL COST	ANNUAL SAVINGS
222	\$97	1000	1080	\$513	\$416
269	\$118	1000	1080	\$513	\$395
362	\$159	1000	1080	\$513	\$354

APPLICATIONS:



200,000+ HOURS



*The majority of Atlas Lighting Products are assembled in USA facilities by an American Workforce utilizing both Domestic and Foreign components
 *Qualifies for Buy American under ARRA



SPT Series

70,000-105,000 Lumen Sports Light

REPLACES UP TO 1500W MH



450-550W:
18.3"Wx15.85"Hx13.35"D

750W:
18.3"Wx15.85"Hx14.5"D

- Easy to install, easy to maintain
- Optical Grade Individual Lenses
- Delivers Increased Footcandles
- Less Glare & Less Wasted Light

ORDERING FORMAT

SPT	70L	2	40		
PRODUCT SERIES SPT = Sports Light	LUMEN PACKAGE 70L = 70,000 Lumens 85L = 85,000 Lumens 105L = 105,000 Lumens	DISTRIBUTION 2 = NEMA 2x2 3 = NEMA 3x3 4 = NEMA 4x4 5 = NEMA 5x5	COLOR TEMP. 40 = 4000K 50 = 5000K	VOLTAGE Blank = 120-277 4 = 347/480	OPTIONS GS - Glare Shield Visor LS - Less Round Housing Shroud

ACCESSORIES



PART NUMBER	DESCRIPTION	FINISH	STD. PKG.
SPT-LZR	Laser Sight	Black	1
SPT-GS	Glare Shield Visor	Black	1
320-200	Tenon Mount	Black	1

ENERGY SAVINGS

LED		HID			
WATTAGE	ANNUAL COST	SOURCE WATTAGE	TOTAL WATTAGE USED	ANNUAL COST	ANNUAL SAVINGS
450	\$197	1000	1080	\$613	\$416
550	\$241	1500	1605	\$853	\$612
750	\$329	1500	1605	\$853	\$524

ELECTRICAL DATA*

LUMENS	120V	208V	240V	277V	347V	480V
70L	3.94	2.27	1.97	1.71	1.36	0.98
85L	4.82	2.78	2.41	2.08	1.66	1.20
100L	6.57	3.79	3.28	2.84	2.27	1.64

*Electrical data at 25C (77F). Actual wattage may differ by +/-10%.

SPECIFICATIONS

VOLTAGE	100V-277V / 277V-480V / 200-480V
CONTROL	0-10V Dimming
IP RATING	IP66
LIFESPAN	up to 100,000 hrs.
WORKING TEMP.	-40°F ~ 122°F
WARRANTY	5 year limited



*The majority of Atlas Lighting Products are assembled in USA facilities by an American Workforce utilizing both Domestic and Foreign components
*Qualifies for Buy American under ARRA





SPT Series

70,000-105,000 Lumen Sports Light

REPLACES UP TO 1500W MH

PERFORMANCE

UNIT	WEIGHT	EPA	DISTRIBUTION	CRI	4000K CCT		5000K CCT		WATTS
					DELIVERED LUMENS	EFFICACY (LPW)	DELIVERED LUMENS	EFFICACY (LPW)	
SPT70L	37.5 lbs.	1.3	2x2	70	62952	141	62952	141	450W
			3x3	70	70922	157	70922	157	
			4x4	70	71276	157	71276	157	
			5x5	70	69158	154	69158	154	
SPT85L	38.6 lbs.	1.3	2x2	70	71599	133	71599	133	550W
			3x3	70	84569	154	84569	154	
			4x4	70	83982	156	83982	156	
			5x5	70	82674	150	82674	150	
SPT105L	42 lbs.	1.3	2x2	70	90443	125	90443	125	750W
			3x3	70	106230	144	106230	144	
			4x4	70	106410	144	106410	144	
			5x5	70	107000	145	107000	145	

BRACKETS

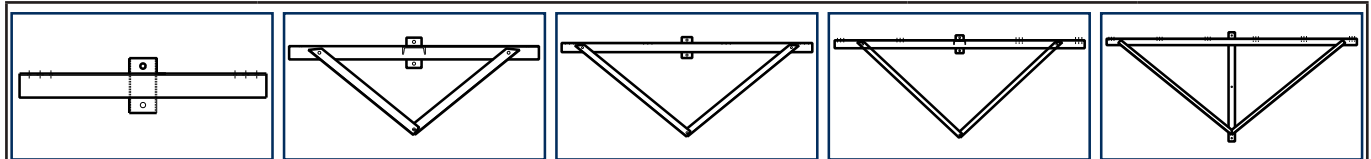

PART NUMBER	DESCRIPTION	FINISH	STD. PKG.
500-001G	2 Light Sports Light Wood Pole Bracket	Galvanized	1
500-002G	3 Light Sports Light Wood Pole Bracket	Galvanized	1
500-003G	4 Light Sports Light Wood Pole Bracket	Galvanized	1
500-004G	5 Light Sports Light Wood Pole Bracket	Galvanized	1
500-005G	6 Light Sports Light Wood Pole Bracket	Galvanized	1

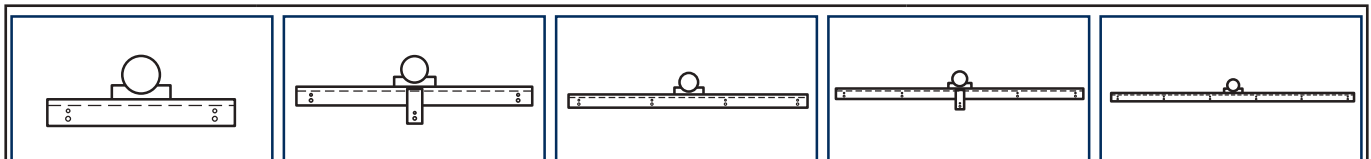

PART NUMBER	DESCRIPTION	FINISH	STD. PKG.
500-069G	2 Light Sports Light Crossarm Bracket	Galvanized	1
500-070G	3 Light Sports Light Crossarm Bracket	Galvanized	1
500-071G	4 Light Sports Light Crossarm Bracket	Galvanized	1
500-072G	5 Light Sports Light Crossarm Bracket	Galvanized	1
500-073G	6 Light Sports Light Crossarm Bracket	Galvanized	1

Constitution Series

8,000-23,000 Lumens LED Roadway Light

REPLACES UP TO 400 MH



14.18"Wx5.35"Hx27.5"D

- Aerodynamic Shape Design for Low Wind Resistance & EPA
- Solid Construction Die-cast Aluminum Housing
- UV Stabilize Power Coated Finish
- 7-Pin Photocell Receptacle Standard
- Surge Protection Standard

ORDERING FORMAT

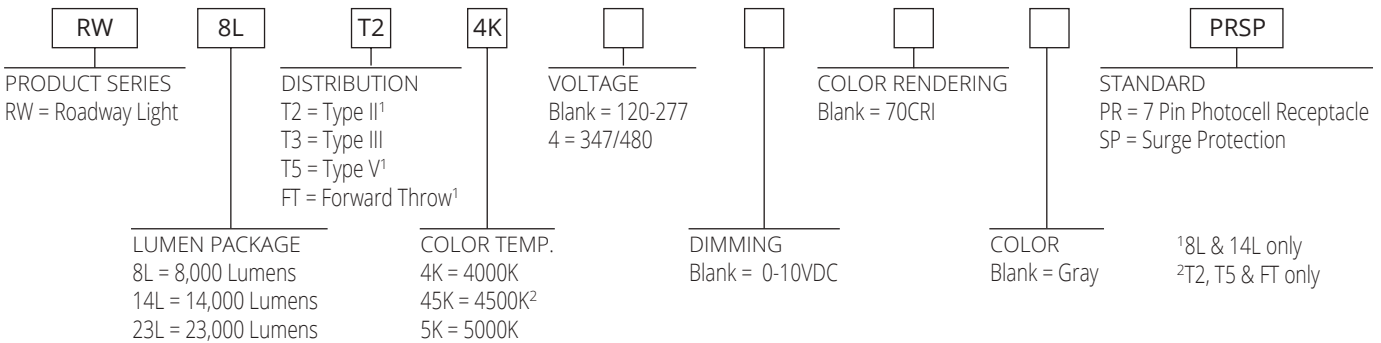

DATA PERFORMANCE

LUMEN PACKAGE	DISTRIBUTION	CRI	4000K CCT			4500K CCT			5000K CCT		
			DELIVERED LUMENS	EFFICACY (LPW)	WATTS	DELIVERED LUMENS	EFFICACY (LPW)	WATTS	DELIVERED LUMENS	EFFICACY (LPW)	WATTS
8L	Type II	70	7,615	154	49.3	7,509	152	49.3	7,572	154	49.3
8L	Type III	70	8,193	132	63.0	n/a	n/a	n/a	8,238	130	64.0
8L	Forward Throw	70	7,387	150	49.3	7,345	149	49.3	7,326	148	49.3
8L	Type V	70	7,632	155	49.2	7,588	154	49.2	7,526	153	49.2
14L	Type II	70	13,289	146	90.9	13,079	144	90.9	12,872	142	90.9
14L	Type III	70	13,850	116	120.0	n/a	n/a	n/a	14,070	115	122.0
14L	Forward Throw	70	13,007	143	90.8	12,801	141	90.8	12,807	141	90.8
14L	Type V	70	13,315	147	90.9	13,110	144	90.9	12,908	142	90.9
23L	Type III	70	22,230	119	186	n/a	n/a	n/a	22,360	120	187



*The majority of Atlas Lighting Products are assembled in USA facilities by an American Workforce utilizing both Domestic and Foreign components
*Qualifies for Buy American under ARRA



LED | HID Brackets & Accessories

Glare Shields for Site Lighter Pro



CATALOG#	DESCRIPTION	FINISH
SGSU16	Side Shield for SLP16	Bronze
SGSU22	Side Shield for SLP22	Bronze
BGS16	Back Glare Shield for SLP16	Bronze
BGS22	Back Glare Shield for SLP22	Bronze

RSR Brackets



CATALOG#	DESCRIPTION	FINISH	WT/LBS.
500-015BZ	2 In Line RSR Bracket	Bronze	20

Configuration	EPA Rating		
	Bracket	PFL	PFXL
DOUBLE	1.92	3.92	4.50

Side Mount Brackets



CATALOG#	DESCRIPTION	FINISH
500-018BZ	Right Angle Bracket (for Wall)	Bronze
500-050BZ	Right Angle Bracket (for Pole)	Bronze
500-054BZ	4" Side Tenon Mount Bracket	Bronze
500-055BZ	8" Side Tenon Mount Bracket	Bronze
500-060G	Side Angle Bracket	Galvanized
500-SSFM4	Single Square Flood Mount Bracket for 4" Pole	Bronze

Bullhorn Brackets



CATALOG#	DESCRIPTION	FINISH	WT/LBS.
500-011BZ	2 In Line Bullhorn	Bronze	20
500-012BZ	3 In Line Bullhorn	Bronze	31
500-052BZ	3 @ 120° Bullhorn	Bronze	33
500-022BZ	4 @ 90° Bullhorn	Bronze	43

Configuration	EPA Rating		
	Bracket	PFL	PFXL
DOUBLE	1.35	3.35	3.93
TRIPLE @ 120°	2.0	4.0	4.58
TRIPLE	2.5	4.5	5.08
QUAD @ 90°	1.79	3.79	4.37

Miscellaneous Brackets



CATALOG#	DESCRIPTION	FINISH
500-006G*	Cross Arm Bracket-Steel	Galvanized
500-007G*	Single Flood Light Bracket	Galvanized
500-082BZ	Post-Top Fitter for Knuckle	Bronze
320-035BZ	Slipfitter for Trunnion Mount	Bronze
280-032	Adjustable Post Top Fitter	Bronze
500-009BZ	4" Drop In Tenon	Bronze
500-010BZ	5" Drop In Tenon	Bronze
500-066BZ	6" Drop In Tenon	Bronze

*For Wood Pole Mount Only

Eagle Series

Area Light

200,000+ HOURS



Optional 7-Pin Controls Receptacle

Die Cast Aluminum Housing

External Air Flow Fins Dissipate Heat

Low Profile



Advanced One Piece Optics with Multiple Distributions

- Type II
- Type III
- Type V
- Forward Throw
- Rotatable Optics

Optional Surge Protector

Separate Driver Compartment for Cooler Operation & Longer Driver Life

Dimming

120+ Lumens per Watt

PHILIPS ADVANCE

Quality LED Drivers



Labor Saving - Quick Mount Universal Bracket System Fits Any Pole



COLOR OPTIONS



Bronze



Black



Silver



White

Easy Retrofit

Replace the Fixture, Not the Pole



250W MH

HID

SOURCE WATTAGE	TOTAL WATTAGE USED	ANNUAL COST
250	285	\$150

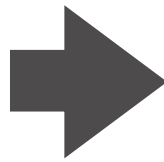

LED

WATTAGE	ANNUAL COST	ANNUAL SAVINGS
75	\$33	\$117

14' - 18' Rec. Mounting Height

ENERGY SAVINGS

*INCLUDING MAINTENANCE



400W MH

HID

SOURCE WATTAGE	TOTAL WATTAGE USED	ANNUAL COST
400	458	\$251
400	458	\$251

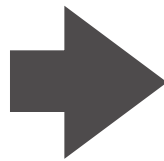

LED

WATTAGE	ANNUAL COST	ANNUAL SAVINGS
115	\$50	\$201
160	\$70	\$181

20' - 30' Rec. Mounting Height

ENERGY SAVINGS

*INCLUDING MAINTENANCE



1000W MH

HID

SOURCE WATTAGE	TOTAL WATTAGE USED	ANNUAL COST
1000	1080	\$513
1000	1080	\$513

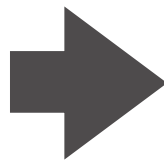

LED

WATTAGE	ANNUAL COST	ANNUAL SAVINGS
265	\$116	\$397
348	\$152	\$361

25' - 40' Rec. Mounting Height

ENERGY SAVINGS

*INCLUDING MAINTENANCE

Quick & Easy Installation



Remove existing fixture. Install cleat (or bracket) to pole.



Slide fixture onto cleat.



Tighten bottom bolts and complete wiring.

Eagle Series

Small Area Light - Selectable

REPLACES UP TO 250W MH



10.62"Wx6.33"Hx19.09"D
0.61 EPA

- Easy to install, easy to maintain
- Optical Grade Individual Lenses
- Delivers Increased Footcandles
- Less Glare & Less Wasted Light

ORDERING FORMAT

SLPS	S	6-12L	T2	4K				
PRODUCT SERIES SLPS = Small Eagle Series Area Light	SELECTABLE S = Selectable	LUMEN PACKAGE 6-12L = 6,000, 8,000, 12,000 Lumens Selectable	DISTRIBUTION T2 = Type 2 T5 = Type 5 FT = Forward Throw T2L = Type 2 Rotated Left FTL = Forward Throw Rotated Left T2R = Type 2 Rotated Right FTR = Forward Throw Rotated Right	COLOR TEMP. 4K = 4000K 45K = 4500K 5K = 5000K	VOLTAGE Blank = 120-277 4 = 347/480	DIMMING Blank = 0-10VDC	COLOR Blank = Bronze SL = Anodized Silver BK = Black WT = White	OPTIONS PR = 7 Pin Photocell Receptacle SP = Surge Protection IC = Integrated Motion Control BTM = Bluetooth Microwave Motion Control <i>includes photocontrol</i>

ENERGY SAVINGS

LED		HID			
WATTAGE	ANNUAL COST	SOURCE WATTAGE	TOTAL WATTAGE USED	ANNUAL COST	ANNUAL SAVINGS
39	\$17	175	210	\$112	\$95
58	\$25	175	210	\$112	\$87
75	\$33	250	285	\$150	\$117



*The majority of Atlas Lighting Products are assembled in USA facilities by an American Workforce utilizing both Domestic and Foreign components
*Qualifies for Buy American under ARRA



Eagle Series

Small Area Light - Selectable

REPLACES UP TO 250W MH

MULTIPLE DISTRIBUTION PATTERNS - ROTATABLE OPTICS

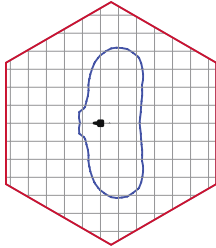

TYPE II

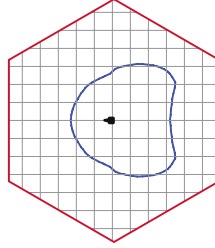

TYPE FT

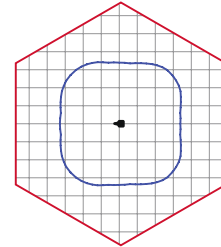

TYPE V

PERFORMANCE

LUMEN PACKAGE	DISTRIBUTION	CRI	4000K CCT			4500K CCT			5000K CCT		
			DELIVERED LUMENS	EFFICACY (LPW)	WATTAGE	DELIVERED LUMENS	EFFICACY (LPW)	WATTAGE	DELIVERED LUMENS	EFFICACY (LPW)	WATTAGE
6L-12L	T2	70	6036	143	42.1	6036	143	42.1	6036	143	42.1
	FT	70	5899	140	42.1	5859	139	42.1	5859	139	42.1
	T5	70	5812	138	42.1	5812	138	42.1	5812	138	42.1
	T2	70	8946	142	63.2	8946	142	63.2	8946	142	63.2
	FT	70	8743	138	63.2	8684	137	63.2	8684	137	63.2
	T5	70	8614	136	63.2	8614	136	63.2	8614	136	63.2
	T2	70	11755	137	86	11755	137	86	11755	137	86
	FT	70	11488	134	86	11410	133	86	11410	133	86
	T5	70	11319	132	86	11319	132	86	11319	132	86

Eagle Series

Small Area Light

REPLACES UP TO 250W MH



10.62"Wx6.33"Hx19.09"D
0.61 EPA

- Easy to install, easy to maintain
- Optical Grade Individual Lenses
- Delivers Increased Footcandles
- Less Glare & Less Wasted Light

ORDERING FORMAT

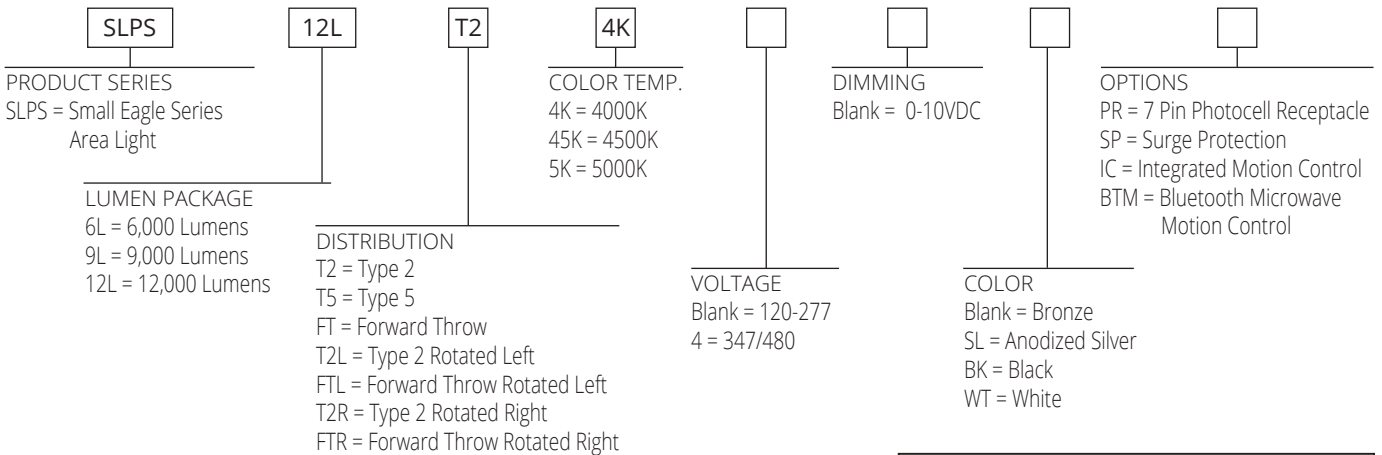

ENERGY SAVINGS

LED		HID			
WATTAGE	ANNUAL COST	SOURCE WATTAGE	TOTAL WATTAGE USED	ANNUAL COST	ANNUAL SAVINGS
39	\$17	175	210	\$112	\$95
58	\$25	175	210	\$112	\$87
75	\$33	250	285	\$150	\$117

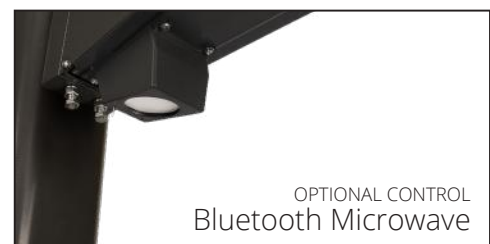

*The majority of Atlas Lighting Products are assembled in USA facilities by an American Workforce utilizing both Domestic and Foreign components
*Qualifies for Buy American under ARRA



Eagle Series

Small Area Light
REPLACES UP TO 250W MH

MULTIPLE DISTRIBUTION PATTERNS - ROTATABLE OPTICS

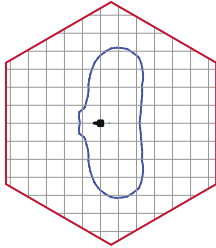

TYPE II

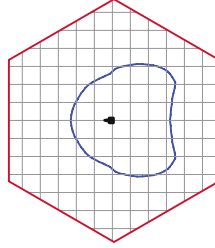

TYPE FT

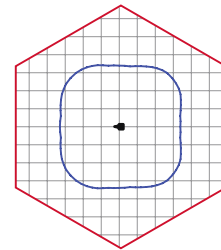

TYPE V

PERFORMANCE

LUMEN PACKAGE	DISTRIBUTION	CRI	4000K CCT			4500K CCT			5000K CCT		
			DELIVERED LUMENS	EFFICACY (LPW)	WATTAGE	DELIVERED LUMENS	EFFICACY (LPW)	WATTAGE	DELIVERED LUMENS	EFFICACY (LPW)	WATTAGE
6L	T2	70	6297	154	41.0	6288	153	41.0	6288	153	41.0
	FT	70	6005	146	40.6	5839	144	40.6	5839	144	40.6
	T5	70	6025	147	40.6	6016	147	40.9	6016	147	40.9
9L	T2	70	9041	144.4	62.6	8859	141.5	62.6	8859	141.5	62.6
	FT	70	8717	139.2	62.8	8541	136.0	62.8	8541	136.0	62.8
	T5	70	8639	137.9	62.5	8465	134.8	62.8	8465	134.8	62.8
12L	T2	70	12028	135.9	88.6	11822	133.4	88.6	11822	133.4	88.6
	FT	70	11417	128.9	88.6	11222	126.7	88.6	11222	126.7	88.6
	T5	70	11578	130.5	88.7	11380	128.9	88.3	11380	128.9	88.3

Eagle Series

Medium Area Light

REPLACES UP TO 1000W MH



16.12"Wx6.59"Hx28.84"D
21 LBS • 0.61 EPA

- Easy to install, easy to maintain
- Optical Grade Individual Lenses
- Delivers Increased Footcandles
- Less Glare & Less Wasted Light

ORDERING FORMAT

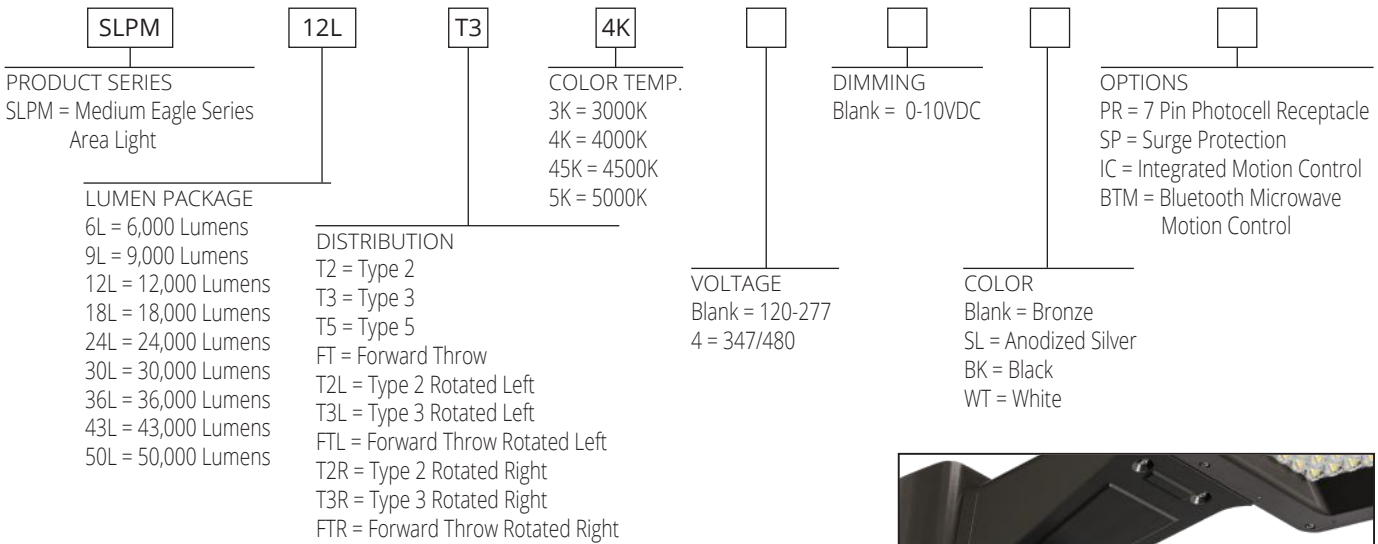

ENERGY SAVINGS

LED		HID			
WATTAGE	ANNUAL COST	SOURCE WATTAGE	TOTAL WATTAGE USED	ANNUAL COST	ANNUAL SAVINGS
39	\$17	175	210	\$112	\$95
58	\$25	175	210	\$112	\$87
75	\$33	250	285	\$150	\$117
115	\$50	400	458	\$251	\$201
160	\$70	400	458	\$251	\$181
210	\$92	750	824	\$411	\$319
265	\$116	1000	1080	\$513	\$397
348	\$152	1000	1080	\$513	\$361



*The majority of Atlas Lighting Products are assembled in USA facilities by an American Workforce utilizing both Domestic and Foreign components
*Qualifies for Buy American under ARRA



Eagle Series

Medium Area Light

REPLACES UP TO 1000W MH

MULTIPLE DISTRIBUTION PATTERNS - ROTATABLE OPTICS

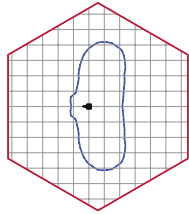

TYPE II

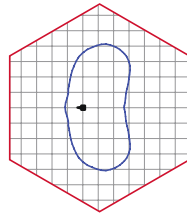

TYPE III

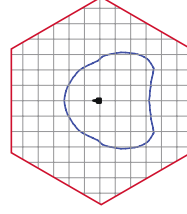

TYPE FT

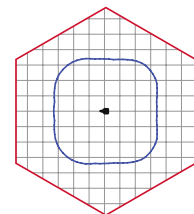

TYPE V

PERFORMANCE

LUMEN PACKAGE	DISTRIBUTION	REPLACES UP TO	CRI	3000K CCT		4000K CCT		4500K CCT		5000K CCT		WATTAGE
				DELIVERED LUMENS	EFFICACY (LPW)	DELIVERED LUMENS	EFFICACY (LPW)	DELIVERED LUMENS	EFFICACY (LPW)	DELIVERED LUMENS	EFFICACY (LPW)	
6L	T2	175W MH	70	5,908	153	6,067	158	6,093	159	6,152	160	39
	T3		70	5,824	151	5,981	155	6,006	155	6,065	157	
	FT		70	5,712	148	5,866	152	5,891	153	5,948	154	
	T5		70	5,848	152	6,005	156	6,031	156	6,090	158	
9L	T2	175W MH	70	9,155	159	9,401	163	9,442	164	9,533	166	58
	T3		70	9,082	158	9,326	162	9,366	163	9,457	164	
	FT		70	8,866	154	9,104	158	9,144	159	9,232	160	
	T5		70	9,086	158	9,330	162	9,370	163	9,461	164	
12L	T2	250W MH	70	12,030	160	12,354	164	12,407	165	12,527	167	75
	T3		70	11,900	159	12,220	163	12,272	164	12,391	165	
	FT		70	11,670	156	11,984	160	12,035	160	12,152	162	
	T5		70	11,950	159	12,271	164	12,324	164	12,444	166	
18L	T2	400W MH	70	19506	160	18509	152	18509	152	18,577	162	122
	T3		70	19489	160	18493	152	18493	152	18,546	161	
	FT		70	19182	157	18201	149	18201	149	18,056	157	
	T5		70	19650	161	18645	153	18645	154	18,556	161	
24L	T2	400W MH	70	25447	149	24146	141	24146	141	24,616	154	171
	T3		70	25425	149	24125	141	24125	141	24,596	154	
	FT		70	25025	146	23745	139	23745	139	23,981	150	
	T5		70	25635	150	24324	142	24324	142	24,637	154	
30L	T2	750W MH	70	29,450	140	30,242	144	30,372	145	30,666	146	210
	T3		70	29,440	140	30,232	144	30,361	145	30,656	146	
	FT		70	28,750	137	29,523	141	29,650	141	29,937	143	
	T5		70	29,470	141	30,263	144	30,392	145	30,687	146	
36L	T2	1000W MH	70	35,260	133	36,208	137	36,364	137	36,716	139	265
	T3		70	35,220	133	36,167	137	36,322	137	36,675	139	
	FT		70	34,490	131	35,418	134	35,570	135	35,914	136	
	T5		70	35,200	133	36,147	137	36,302	137	36,654	139	
43L	T2	1000W MH	70	42,200	121	43,335	124	43,521	125	43,943	126	348
	T3		70	41,940	120	43,068	124	43,253	124	43,672	125	
	FT		70	41,300	118	42,411	122	42,593	122	43,006	123	
	T5		70	41,970	120	43,099	124	43,284	124	43,703	125	
50L	T2	1000W MH	70	n/a	n/a	48821	147	47962	144	47962	144	333
	T3		70	n/a	n/a	49190	148	48324	145	48324	145	
	FT		70	n/a	n/a	47891	144	47048	142	47048	142	
	T5		70	n/a	n/a	49524	149	48652	146	48652	146	

PLM Series

43-64W LED Low Wattage Site Lighting Solution

REPLACES UP TO 400 MH

Low Cost Option - Lower Mounting Heights



PLM43LED / PLM64LED

☀️ 5,334 / 7,384 **LUMENS**

⚡ 43 / 64 **WATTS**

💰 133 / 121 **LPW**

⊕ 82 / 84 **CRI**

🔌 4500K **CCT**

📏 0-10V **DIMMING**

📏 **REC MNT HT**
12-14 FT / 16-18 FT



9.29"Wx6.25"Hx9.06"D
10 LBS

Design is Protected
by U.S. Patent No. D772,474

ORDERING INFORMATION

CATALOG #	DESCRIPTION	LUMENS	CCT	REPLACES UP TO	VOLTS
PLM43LED	43W LED Low Wattage Site Lighting Solution	5,334	4500K	175W MH	120-277
PLM64LED	64W LED Low Wattage Site Lighting Solution	7,384	4500K	400W MH	120-277

Specs shown are for 4500K CCT. Also available in 3000K, 4000K and 5000K. See Cut Sheet for more information.

FOOTCANDLES ON THE GROUND

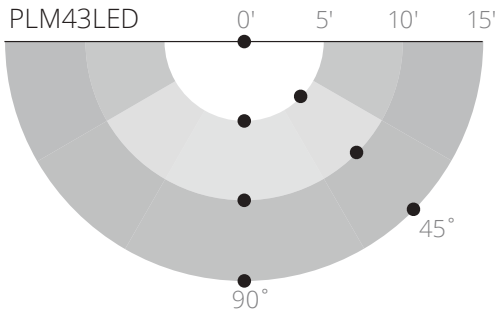

	12' Mtg Height		14' Mtg Height	
	90°	45°	90°	45°
0'	15.8	15.8	11.6	11.6
5'	13.9	12.5	10.6	9.8
10'	6.9	6.6	6.3	5.9
15'	3.3	3.1	3.3	3.2
Average	8.4		7.0	

OPTIONS

ADD SUFFIX #	DESCRIPTION	ADD SUFFIX #	DESCRIPTION
PC	120V Photocontrol	4	480V Driver
PM	208-277V Photocontrol		

ENERGY SAVINGS

LED		HID			
WATTAGE	ANNUAL COST	SOURCE WATTAGE	TOTAL WATTAGE USED	ANNUAL COST	ANNUAL SAVINGS
43	\$19	100	129	\$77	\$58
43	\$19	150	185	\$100	\$81
43	\$19	175	210	\$112	\$93
64	\$28	200	232	\$128	\$100
64	\$28	250	285	\$150	\$122
64	\$28	400	458	\$226	\$198



*The majority of Atlas Lighting Products are assembled in USA facilities by an American Workforce utilizing both Domestic and Foreign components
*Qualifies for Buy American under ARRA









BL Series

18-36 Watt LED Bollard



8.39"Wx36"H

BL18LED / BL36LED
 2,035 / 3,960 **LUMENS** 
 18 / 36 **WATTS** 
 111 / 110 **LPW** 
 70 **CRI** 
 4000K **CCT** 
 0-10V **DIMMING** 

ORDERING INFORMATION

CATALOG #	DESCRIPTION	LUMENS	DIST. TYPE	CCT	VOLTS
BL18LED4K	18W LED Bollard	2,035	Type V	4000K	120-277
BL36LED4K	36W LED Bollard	3,960	Type V	4000K	120-277

Specs shown are for 4000K CCT. Also available in 5000K. See Cut Sheet for more information.

ORDERING FORMAT

<div style="border: 1px solid black; padding: 2px; width: 40px; margin: 0 auto;">BL</div> <hr style="width: 100%;"/> <p>PRODUCT SERIES BL = LED Bollard</p>	<div style="border: 1px solid black; padding: 2px; width: 60px; margin: 0 auto;">18LED</div> <hr style="width: 100%;"/> <p>WATTAGE 18LED = 18 Watts 36LED = 36 Watts</p>	<div style="border: 1px solid black; padding: 2px; width: 30px; margin: 0 auto;"></div> <hr style="width: 100%;"/> <p>VOLTAGE Blank = 120-277</p>	<div style="border: 1px solid black; padding: 2px; width: 30px; margin: 0 auto;"></div> <hr style="width: 100%;"/> <p>CRI Blank = 70</p>	<div style="border: 1px solid black; padding: 2px; width: 40px; margin: 0 auto;">4K</div> <hr style="width: 100%;"/> <p>COLOR TEMP. 4K = 4000K 5K = 5000K</p>	<div style="border: 1px solid black; padding: 2px; width: 30px; margin: 0 auto;"></div> <hr style="width: 100%;"/> <p>COLOR Blank = Bronze</p>
---	--	---	--	---	--



Universal Bracket System

Fits Any Pole

Round Pole Adapter



Mounting Cleat Included with Fixture

CATALOG#	DESCRIPTION	FINISH
500-SLPMRPA	Round Pole Bracket	Bronze

Square Pole Tenon Adapter - Up to 4 @ 90°



Removable Top Bracket Cover Included

(3) Sides have Removable Hole Plugs Installed

Bracket is Pre-drilled for Mounting up to (4) Fixtures

Fits square pole with 2 3/8" tenon

Mounting Cleat Included with Fixture

See Figure 1 for Fixture Configuration

CATALOG#	DESCRIPTION	FINISH
500-SPTBZ	For Square Poles w/ Tenon	Bronze

Square or Round Pole w/ Tenon - Up to 4 @ 90°



(3) Sides have Removable Hole Plugs Installed

Bracket is Pre-drilled for Mounting up to (4) Fixtures

Fits square or round poles with 2 3/8" tenon

Pole Cap Included



Mounting Cleat Included with Fixture

See Figure 1 for Fixture Configuration

CATALOG#	DESCRIPTION	FINISH
500-RPT90BZ	For Tenon Up to 4 @ 90°	Bronze

Square or Round Pole w/ Tenon - Up to 3 @ 120°



(2) Sides have Removable Hole Plugs Installed

Bracket is Pre-drilled for Mounting up to (3) Fixtures

Fits square or round poles with 2 3/8" tenon

Pole Cap Included



Mounting Cleat Included with Fixture

See Figure 2 for Fixture Configuration

CATALOG#	DESCRIPTION	FINISH
500-RPT120BZ	For Tenon 3 @ 120°	Bronze

Round Pole Top Adapter - Up to 4 @ 90°



Mounting Cleat Included with Fixture

Pole Cap Included



Reducer Sleeve Included

Bolts Included

See Figure 1 for Fixture Configuration

CATALOG#	DESCRIPTION	FINISH
500-RPT243490BZ	2.3" - 3.4" Pole Top O.D.	Bronze
500-RPT35490BZ	3.5" - 4" Pole Top O.D.	Bronze

Round Pole Top Adapter - Up to 3 @ 120°



Mounting Cleat Included with Fixture

Pole Cap Included



Reducer Sleeve Included

Bolts Included

See Figure 2 for Fixture Configuration

CATALOG#	DESCRIPTION	FINISH
500-RPT2434120BZ	2.3" - 3.4" Pole Top O.D.	Bronze

Note: All brackets are available in bronze, black, silver or white finishes.

Universal Bracket System

Fits Any Pole

Wall Brackets

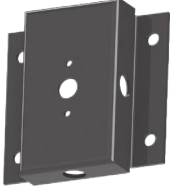

CATALOG#	DESCRIPTION	FINISH
500-WBBZ	Wall Mount Bracket	Bronze

Note: Not to be used as junction box.

Wooden Pole Bracket

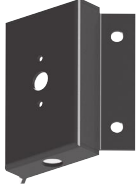

Mounts to wood poles
8"-12" in diameter

CATALOG#	DESCRIPTION	FINISH
500-WPBBZ	Wooden Pole Bracket	Bronze

Note: Not to be used as junction box.

Spoke Arm Brackets







CATALOG#	DESCRIPTION	FINISH
500-SAB21	Spoke Arm Bracket for SLP 22"	Bronze

Angled Bracket





CATALOG#	DESCRIPTION	FINISH
500-AAB	Angled Bracket for SLP	Bronze

Fixture Configurations - Up to 4 @ 90°

Figure 1	Configuration	16" EPA	22" EPA
	Single	0.6	0.8
	2 @ 90°	1.4	1.8
	2 @ 180°	0.7	0.9
	3 @ 90°	2.1	2.7
	4 @ 90°	2.1	2.7

Fixture Configurations - Up to 3 @ 120°

Figure 2	Configuration	16" EPA	22" EPA
	Single	0.6	0.8
	2 @ 120°	1.4	1.8
	3 @ 120°	2.1	2.7



Scan QR code to view video of the Universal Bracket System

Independence Series

12,000-24,000 Selectable Lumen LED High Bay



14"Wx3.22"Hx13.66"L

- Ultra compact (14"W x 3.22"H x 13.66")
- Easy to install
- Smooth & uniform light

ORDERING FORMAT

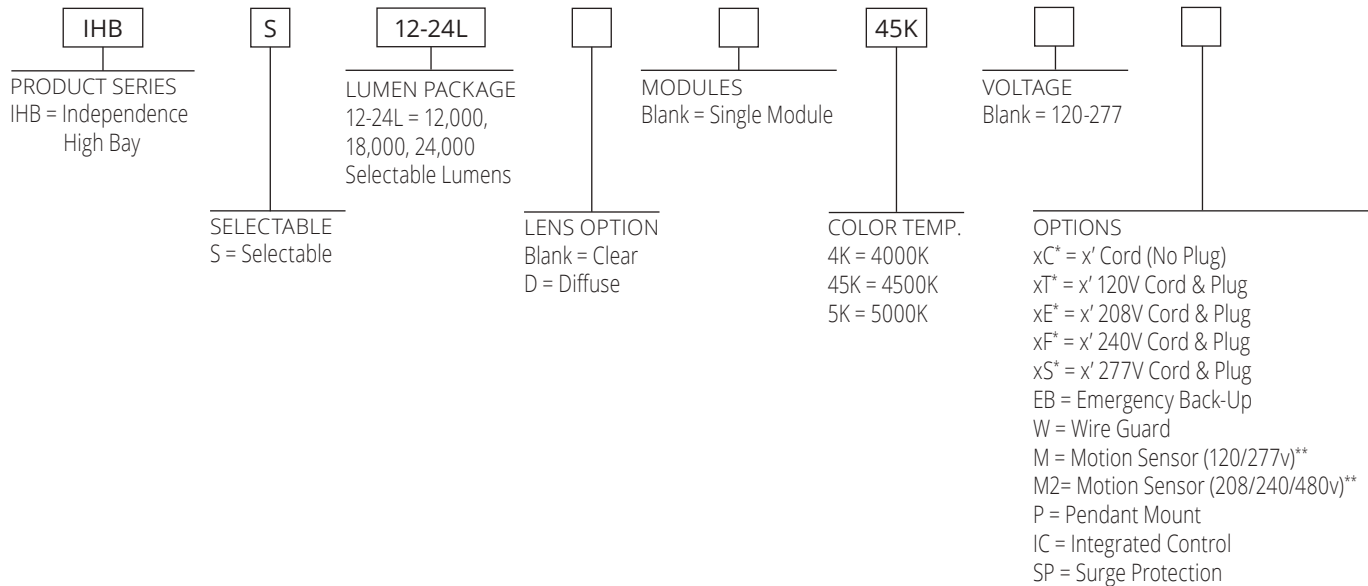

*x = 3 for 3'; 6 for 6'; 10 for 10'; and 20 for 20'
 ** - M and M2 are end mount only



*The majority of Atlas Lighting Products are assembled in USA facilities by an American Workforce utilizing both Domestic and Foreign components
 *Qualifies for Buy American under ARRA



Independence Series

12,000-24,000 Selectable Lumen LED High Bay

PERFORMANCE DATA

UNIT	CRI	4000K CCT			4500K CCT			5000K CCT		
		Delivered Lumens	Efficacy (LPW)	Wattage	Delivered Lumens	Efficacy (LPW)	Wattage	Delivered Lumens	Efficacy (LPW)	Wattage
CLEAR LENS										
12L-24L	80	12,967	158	82.1	12,967	158	82.1	13,011	157	82.8
	80	19,045	152	125.2	19,045	152	125.2	19,110	153	125.2
	80	23,843	146	162.8	23,843	146	162.8	23,924	147	162.8
DIFFUSED LENS										
12L-24L	80	11,587	141	82.2	11,523	139	82.7	11,523	139	82.7
	80	16,954	136	124.9	16,860	135	124.9	16,860	135	124.9
	80	21,281	132	161.5	21,163	131	161.5	21,163	131	161.5

Independence Series

12,000-60,000 Lumen LED High Bay



- Ultra compact
(14"W x 3.22"H x 13.66"/27.32"L)
- Easy to install
- Smooth & uniform light

Single Module: 14"Wx3.22"Hx13.66"L
 Double Module: 14"Wx3.22"Hx24.32"L

ORDERING FORMAT

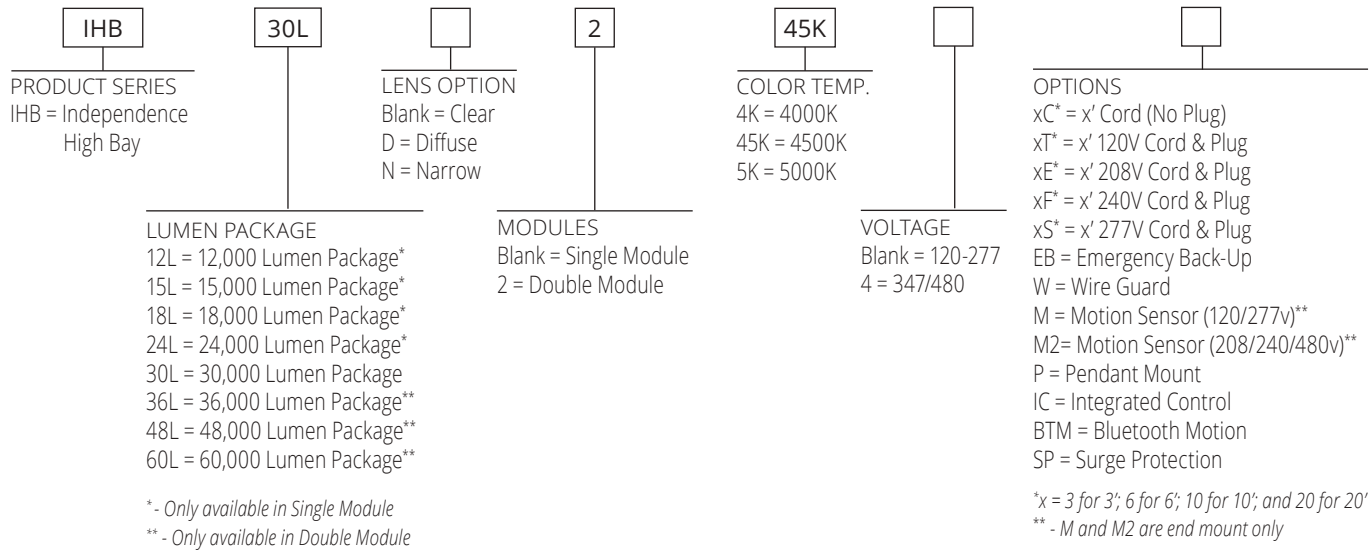

*The majority of Atlas Lighting Products are assembled in USA facilities by an American Workforce utilizing both Domestic and Foreign components
 *Qualifies for Buy American under ARRA



Independence Series

12,000-60,000 Lumen LED High Bay

PERFORMANCE DATA

UNIT	CRI	4000K CCT			4500K CCT			5000K CCT			MODULES
		Delivered Lumens	Efficacy (LPW)	Wattage	Delivered Lumens	Efficacy (LPW)	Wattage	Delivered Lumens	Efficacy (LPW)	Wattage	
CLEAR LENS											
IHB12L	80	12,386	159	78	12,386	159	78	12,669	160	79	Single
IHB15L	80	16,144	154	105	16,144	154	105	16,513	157	105	Single
IHB18L	80	18,597	153	122	18,597	153	122	19,022	156	122	Single
IHB24L	80	23,910	148	162	23,899	148	162	23,899	148	162	Single
IHB30L	80	29,550	159	186	29,550	159	186	30,370	166	183	Single
IHB30L2	80	28,347	160	177	28,347	160	177	29,134	165	177	Double
IHB36L2	80	37,194	153	244	37,194	153	244	38,044	156	244	Double
IHB48L2	80	47,820	148	324	47,798	148	324	47,798	148	324	Double
IHB60L2	80	59,100	159	371	59,100	159	371	60,740	166	367	Double
DIFFUSED LENS											
IHB12LD	80	11,126	143	78	11,126	143	78	11,418	144	79	Single
IHB15LD	80	14,567	140	105	14,567	140	105	14,949	143	105	Single
IHB18LD	80	16,767	137	122	16,767	137	122	17,207	141	122	Single
IHB24LD	80	21,506	133	162	21,404	136	162	21,404	136	162	Single
IHB30LD	80	26,470	143	185	26,470	143	185	27,343	149	184	Single
IHB30LD2	80	25,537	145	177	25,537	145	177	26,379	149	177	Double
IHB36LD2	80	33,534	137	244	33,534	137	244	34,414	141	244	Double
IHB48LD2	80	43,012	133	324	42,808	136	323	42,808	135.5	323	Double
IHB60LD2	80	52,940	143	371	52,940	143	371	54,686	149	367	Double
NARROW											
IHB12LN	80	11,089	143	78	11,089	143	78	11,501	145	79	Single
IHB15LN	80	14,652	140	105	14,652	140	105	15,196	145	105	Single
IHB18LN	80	16,766	138	122	16,766	138	122	17,389	143	122	Single
IHB24LN	80	21,363	132	162	21,363	132	162	21,491	133	162	Single
IHB30LN	80	26,488	143	185	26,488	143	185	27,097	148	183	Single
IHB30LN2	80	25,400	144	177	25,400	144	177	25,552	145	177	Double
IHB36LN2	80	33,532	138	243	33,532	138	243	34,778	143	243	Double
IHB48LN2	80	42,726	132	323	42,726	132	323	42,982	133	324	Double
IHB60LN2	80	52,976	143	371	52,976	143	371	54,194	148	367	Double

9,000 Lumen

2' Slim LED High Bay

REPLACES UP TO 100W MH / 4L T8 FL



ILH29LL / ILH29L

9,631 / 10,300 **LUMENS**

74 **WATTS**

130 / 139 **LPW**

80 **CRI**

4500K **CCT**

0-10V **DIMMING**

REC MNT HT
10 FT to 14 FT



4.5"Wx3.3"Hx25.51"L
6.6 LBS

ORDERING INFORMATION

CATALOG #	DESCRIPTION	LUMENS	VOLTS
ILH29LL	9,000 Lumen LED High Bay with Glare Free Lens	9,631	120-277
ILH29L	9,000 Lumen LED High Bay - No Lens	10,300	120-277

Specs shown are for 4500K CCT. Also available in 4000K and 5000K. See Cut Sheet for more information.

ACCESSORIES

CATALOG #	DESCRIPTION
CH36	Chain Set
CH36HFC	Chain Set w/Hammer-On Flange Clip
CA36	Cable Set
MS360	360° Motion Sensor (120, 277V)
MS360-480	360° Motion Sensor (208, 240, 480V)



Hanging Hooks Included

OPTIONS

ADD SUFFIX #	DESCRIPTION	ADD SUFFIX #	DESCRIPTION
xC*	3' Cord (No Plug)	M	Motion Sensor (120, 277V)**
xT*	3' 120V Cord & Plug	M2	Motion Sensor (208, 240, 480V)**
xE*	3' 208V Cord & Plug	P	Pendant Mount
xF*	3' 240V Cord & Plug	IC	Integrated Control**
xE*	3' 277V Cord & Plug	4	480V Driver
EB	Emergency Back-Up		

*x = 3 for 3' Cord; 6 for 6' cord, 10 for 10' cord; and 20 for 20' cord lengths

**End Panel Mounted

ENERGY SAVINGS

LED			HID		
WATTAGE	ANNUAL COST	SOURCE WATTAGE	TOTAL WATTAGE USED	ANNUAL COST	ANNUAL SAVINGS
74	\$32	100 MH	129	\$82	\$50
74	\$32	4L T8 FL	151	\$91	\$59

AMBIENT TEMPERATURE FIXTURE RATING

PART #	12" CHAIN MOUNT
ILH29LL	60°C (140°F)
ILH29L	60°C (140°F)



*The majority of Atlas Lighting Products are assembled in USA facilities by an American Workforce utilizing both Domestic and Foreign components
*Qualifies for Buy American under ARRA



12,000 Lumen

2' Slim LED High Bay
REPLACES UP TO 175W MH / 4L T8 FL



4.5"Wx3.3"Hx25.51"L
6.6 LBS

ILHS212LL / ILHS212L
11,485 / 12,303 **LUMENS** ☀️
84 **WATTS** ⚡️
137 / 146 **LPW** 💰
80 **CRI** ⊕
4500K **CCT** 🌈
0-10V **DIMMING** 📏
REC MNT HT 📏
12 FT to 16 FT

ORDERING INFORMATION

CATALOG #	DESCRIPTION	LUMENS	VOLTS
ILHS212LL	12,000 Lumen LED High Bay with Glare Free Lens	11,485	120-277
ILHS212L	12,000 Lumen LED High Bay - No Lens	12,303	120-277

Specs shown are for 4500K CCT. Also available in 4000K and 5000K. See Cut Sheet for more information.

ACCESSORIES

CATALOG #	DESCRIPTION
CH36	Chain Set
CH36HFC	Chain Set w/Hammer-On Flange Clip
CA36	Cable Set
MS360	360° Motion Sensor (120, 277V)
MS360-480	360° Motion Sensor (208, 240, 480V)



Hanging Hooks Included

OPTIONS

ADD SUFFIX #	DESCRIPTION	ADD SUFFIX #	DESCRIPTION
xC*	3' Cord (No Plug)	M	Motion Sensor (120, 277V)**
xT*	3' 120V Cord & Plug	M2	Motion Sensor (208, 240, 480V)**
xE*	3' 208V Cord & Plug	P	Pendant Mount
xF*	3' 240V Cord & Plug	IC	Integrated Control**
xS*	3' 277V Cord & Plug	4	480V Driver

EB Emergency Back-Up

*x = 3 for 3' Cord; 6 for 6' cord, 10 for 10' cord; and 20 for 20' cord lengths

**End Panel Mounted

AMBIENT TEMPERATURE FIXTURE RATING

PART #	12" CHAIN MOUNT
ILHS212LL4K	55°C (131°F)
ILHS212L4K	55°C (131°F)

ENERGY SAVINGS

LED			HID		
WATTAGE	ANNUAL COST	SOURCE WATTAGE	TOTAL WATTAGE USED	ANNUAL COST	ANNUAL SAVINGS
83	\$36	175 MH	210	\$117	\$81
83	\$36	4L T8 FL	151	\$91	\$55

200,000+ HOURS



*The majority of Atlas Lighting Products are assembled in USA facilities by an American Workforce utilizing both Domestic and Foreign components
*Qualifies for Buy American under ARRA



15,000 Lumen

2' Narrow LED High Bay

REPLACES UP TO 250W MH / 4L T5 FL / 6L T8 FL



ILHS215LL / ILHS215L

13,841 / 14,915 **LUMENS**

101 **WATTS**

137 / 148 **LPW**

80 **CRI**

4500K **CCT**

0-10V **DIMMING**

REC MNT HT
12 FT to 18 FT



4.5"Wx3.3"Hx25.51"L
6.6 LBS

ORDERING INFORMATION

CATALOG #	DESCRIPTION	LUMENS	VOLTS
ILHS215LL	15,000 Lumen LED High Bay with Glare Free Lens	13,841	120-277
ILHS215L	15,000 Lumen LED High Bay - No Lens	14,915	120-277

Specs shown are for 4500K CCT. Also available in 4000K and 5000K. See Cut Sheet for more information.

ACCESSORIES

CATALOG #	DESCRIPTION
CH36	Chain Set
CH36HFC	Chain Set w/Hammer-On Flange Clip
CA36	Cable Set
MS360	360° Motion Sensor (120, 277V)
MS360-480	360° Motion Sensor (208, 240, 480V)
WGH33	Wireguard



Hanging Hooks Included

OPTIONS

ADD SUFFIX #	DESCRIPTION	ADD SUFFIX #	DESCRIPTION
xC*	3' Cord (No Plug)	M	Motion Sensor (120, 277V)**
xT*	3' 120V Cord & Plug	M2	Motion Sensor (208, 240, 480V)**
xE*	3' 208V Cord & Plug	P	Pendant Mount
xF*	3' 240V Cord & Plug	W	Wireguard
xS*	3' 277V Cord & Plug	IC	Integrated Control**
EB	Emergency Back-Up	4	480V Driver

*x = 3 for 3' Cord; 6 for 6' cord, 10 for 10' cord; and 20 for 20' cord lengths

**End Panel Mounted

ENERGY SAVINGS

LED			HID		
WATTAGE	ANNUAL COST	SOURCE WATTAGE	TOTAL WATTAGE USED	ANNUAL COST	ANNUAL SAVINGS
99	\$43	250 MH	290	\$157	\$114
99	\$43	4L T5 FL	238	\$129	\$86
99	\$43	6L T8 FL	186	\$106	\$63

AMBIENT TEMPERATURE FIXTURE RATING

PART #	12" CHAIN MOUNT
ILHS215LL	50°C (122°F)
ILHS215L	50°C (122°F)



*The majority of Atlas Lighting Products are assembled in USA facilities by an American Workforce utilizing both Domestic and Foreign components
*Qualifies for Buy American under ARRA



15,000 Lumen



4' Narrow LED High Bay
REPLACES UP TO 250W MH / 4L T5 FL / 6L T8 FL

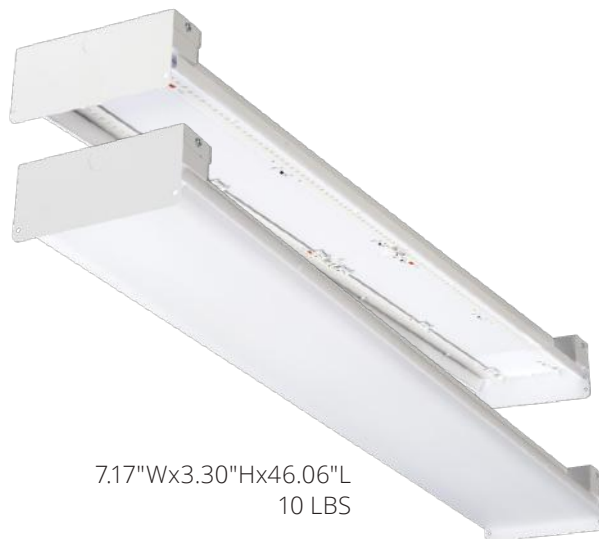

7.17"Wx3.30"Hx46.06"L
10 LBS

ILH415LL / ILH415L
14,120 / 14,980 **LUMENS** ☀️
100 **WATTS** ⚡️
141 / 149 **LPW** 💰
80 **CRI** ⊕
4500K **CCT** 🌈
0-10V **DIMMING** 📏
REC MNT HT 📏
12 FT to 18 FT

ORDERING INFORMATION

Specs shown are for 4500K CCT. Also available in 4000K and 5000K. See Cut Sheet for more information.

ACCESSORIES

CATALOG #	DESCRIPTION
CH36	Chain Set
CH36HFC	Chain Set w/Hammer-On Flange Clip
CA36	Cable Set
MS360	360° Motion Sensor (120, 277V)
MS360-480	360° Motion Sensor (208, 240, 480V)
WGH33	Wireguard



Hanging Hooks Included

AMBIENT TEMPERATURE FIXTURE RATING

PART #	12" CHAIN MOUNT
ILH415LL	50°C (122°F)
ILH415L	50°C (122°F)

OPTIONS

ADD SUFFIX #	DESCRIPTION	ADD SUFFIX #	DESCRIPTION
xC*	3' Cord (No Plug)	M	Motion Sensor (120, 277V)**
xT*	3' 120V Cord & Plug	M2	Motion Sensor (208, 240, 480V)**
xE*	3' 208V Cord & Plug	P	Pendant Mount
xF*	3' 240V Cord & Plug	W	Wireguard
xS*	3' 277V Cord & Plug	IC	Integrated Control**
EB	Emergency Back-Up	4	480V Driver

*x = 3 for 3' Cord; 6 for 6' cord, 10 for 10' cord; and 20 for 20' cord lengths

**End Panel Mounted

ENERGY SAVINGS

LED			HID		
WATTAGE	ANNUAL COST	SOURCE WATTAGE	TOTAL WATTAGE USED	ANNUAL COST	ANNUAL SAVINGS
100	\$44	250 MH	290	\$157	\$113
100	\$44	4L T5 FL	238	\$129	\$85
100	\$44	6L T8 FL	186	\$106	\$62



*The majority of Atlas Lighting Products are assembled in USA facilities by an American Workforce utilizing both Domestic and Foreign components
*Qualifies for Buy American under ARRA



18,000 Lumen

2' LED High Bay

REPLACES UP TO 250W MH / 4L T5 FL / 6L T8 FL



- ILH218LL / ILH218L
- 18,870 / 20,240 **LUMENS**
- 145 **WATTS**
- 130 / 139 **LPW**
- 80 **CRI**
- 4500K **CCT**
- 0-10V **DIMMING**
- REC MNT HT**
14 FT to 20 FT



19.25"Wx3.30"Hx25.50"L
11 LBS

ORDERING INFORMATION

CATALOG #	DESCRIPTION	LUMENS	VOLTS
ILH218LL	18,000 Lumen LED High Bay with Glare Free Lens	18,870	120-277
ILH218L	18,000 Lumen LED High Bay - No Lens	20,240	120-277

Specs shown are for 4500K CCT. Also available in 4000K and 5000K. See Cut Sheet for more information.

ACCESSORIES

CATALOG #	DESCRIPTION
CH36	Chain Set
CH36HFC	Chain Set w/Hammer-On Flange Clip
CA36	Cable Set
MS360	360° Motion Sensor (120, 277V)
MS360-480	360° Motion Sensor (208, 240, 480V)

OPTIONS

ADD SUFFIX #	DESCRIPTION	ADD SUFFIX #	DESCRIPTION
xC*	3' Cord (No Plug)	M	Motion Sensor (120, 277V)**
xT*	3' 120V Cord & Plug	M2	Motion Sensor (208, 240, 480V)**
xE*	3' 208V Cord & Plug	P	Pendant Mount
xF*	3' 240V Cord & Plug	IC	Integrated Control**
xS*	3' 277V Cord & Plug	4	480V Driver

EB Emergency Back-Up

*x = 3 for 3' Cord; 6 for 6' cord, 10 for 10' cord; and 20 for 20' cord lengths

**End Panel Mounted



Hanging Hooks Included

ENERGY SAVINGS

LED			HID		
WATTAGE	ANNUAL COST	SOURCE WATTAGE	TOTAL WATTAGE USED	ANNUAL COST	ANNUAL SAVINGS
145	\$64	250 MH	290	\$157	\$93
145	\$64	4L T5 FL	238	\$129	\$65
145	\$64	6L T8 FL	186	\$106	\$42

AMBIENT TEMPERATURE FIXTURE RATING

PART #	12" CHAIN MOUNT
ILH218LL	50°C (122°F)
ILH218L	50°C (122°F)



*The majority of Atlas Lighting Products are assembled in USA facilities by an American Workforce utilizing both Domestic and Foreign components
*Qualifies for Buy American under ARRA



18,000 Lumen



4' Narrow LED High Bay REPLACES UP TO 250W MH / 4L T5 FL / 6L T8 FL



7.17"Wx3.30"Hx46.06"L
10 LBS

- ILH418LL / ILH418L
- 19,990 / 21,410 **LUMENS**
- 157 **WATTS**
- 128 / 136 **LPW**
- 80 **CRI**
- 4500K **CCT**
- 0-10V **DIMMING**
- REC MNT HT**
- 14 FT to 20 FT

ORDERING INFORMATION

CATALOG #	DESCRIPTION	LUMENS	VOLTS
ILH418LL	18,000 Lumen LED High Bay with Glare Free Lens	19,990	120-277
ILH418L	18,000 Lumen LED High Bay - No Lens	21,410	120-277

Specs shown are for 4500K CCT. Also available in 4000K and 5000K. See Cut Sheet for more information.

ACCESSORIES

CATALOG #	DESCRIPTION
CH36	Chain Set
CH36HFC	Chain Set w/Hammer-On Flange Clip
CA36	Cable Set
MS360	360° Motion Sensor (120, 277V)
MS360-480	360° Motion Sensor (208, 240, 480V)
WGH33	Wireguard



Hanging Hooks Included

OPTIONS

ADD SUFFIX #	DESCRIPTION	ADD SUFFIX #	DESCRIPTION
xC*	3' Cord (No Plug)	M	Motion Sensor (120, 277V)**
xT*	3' 120V Cord & Plug	M2	Motion Sensor (208, 240, 480V)**
xE*	3' 208V Cord & Plug	P	Pendant Mount
xF*	3' 240V Cord & Plug	W	Wireguard
xS*	3' 277V Cord & Plug	IC	Integrated Control**
EB	Emergency Back-Up	4	480V Driver

*x = 3 for 3' Cord; 6 for 6' cord, 10 for 10' cord; and 20 for 20' cord lengths

**End Panel Mounted

ENERGY SAVINGS

WATTAGE	ANNUAL COST	
	LED	HID
157	\$69	
157	\$69	
157	\$69	

AMBIENT TEMPERATURE FIXTURE RATING

PART #	12" CHAIN MOUNT
ILH418LL	50°C (122°F)
ILH418L	50°C (122°F)



*The majority of Atlas Lighting Products are assembled in USA facilities by an American Workforce utilizing both Domestic and Foreign components
*Qualifies for Buy American under ARRA



24,000 Lumen

2' LED High Bay

REPLACES UP TO 400W MH / 6L T5 FL



ILH224LL / ILH224L

24,230 / 25,870 **LUMENS**

187 **WATTS**

130 / 138 **LPW**

80 **CRI**

4500K **CCT**

0-10V **DIMMING**

REC MNT HT
18 FT to 30 FT



19.25"Wx3.30"Hx25.50"L
11.2 LBS

ORDERING INFORMATION

CATALOG #	DESCRIPTION	LUMENS	VOLTS
ILH224LL	24,000 Lumen LED High Bay with Glare Free Lens	24,230	120-277
ILH224L	24,000 Lumen LED High Bay - No Lens	25,870	120-277

Specs shown are for 4500K CCT. Also available in 4000K and 5000K. See Cut Sheet for more information.

ACCESSORIES

CATALOG #	DESCRIPTION
CH36	Chain Set
CH36HFC	Chain Set w/Hammer-On Flange Clip
CA36	Cable Set
MS360	360° Motion Sensor (120, 277V)
MS360-480	360° Motion Sensor (208, 240, 480V)



Hanging Hooks Included

OPTIONS

ADD SUFFIX #	DESCRIPTION	ADD SUFFIX #	DESCRIPTION
xC*	3' Cord (No Plug)	M	Motion Sensor (120, 277V)**
xT*	3' 120V Cord & Plug	M2	Motion Sensor (208, 240, 480V)**
xE*	3' 208V Cord & Plug	P	Pendant Mount
xF*	3' 240V Cord & Plug	IC	Integrated Control**
xS*	3' 277V Cord & Plug	4	480V Driver

EB Emergency Back-Up

*x = 3 for 3' Cord; 6 for 6' cord, 10 for 10' cord; and 20 for 20' cord lengths

**End Panel Mounted

ENERGY SAVINGS

LED			HID		
WATTAGE	ANNUAL COST	SOURCE WATTAGE	TOTAL WATTAGE USED	ANNUAL COST	ANNUAL SAVINGS
187	\$73	400 MH	458	\$251	\$178
187	\$73	6L T5 FL	342	\$175	\$102

AMBIENT TEMPERATURE FIXTURE RATING

PART #	12" CHAIN MOUNT
ILH224LL	50°C (122°F)
ILH224L	50°C (122°F)



*The majority of Atlas Lighting Products are assembled in USA facilities by an American Workforce utilizing both Domestic and Foreign components
*Qualifies for Buy American under ARRA



24,000 Lumen



4' LED High Bay

REPLACES UP TO 400W MH / 6L T5 FL



7.17"Wx3.30"Hx46.06"L
10 LBS

ILHS424LL / ILHS424L
22,767 / 24,416 **LUMENS**

168 **WATTS**

136 / 146 **LPW**

80 **CRI**

4500K **CCT**

0-10V **DIMMING**

REC MNT HT
18 FT to 30 FT

ORDERING INFORMATION

Specs shown are for 4500K CCT. Also available in 4000K and 5000K. See Cut Sheet for more information.

ACCESSORIES

CATALOG #	DESCRIPTION
CH36	Chain Set
CH36HFC	Chain Set w/Hammer-On Flange Clip
CA36	Cable Set
MS360	360° Motion Sensor (120, 277V)
MS360-480	360° Motion Sensor (208, 240, 480V)
WGH36	Wireguard



Hanging Hooks Included

OPTIONS

ADD SUFFIX #	DESCRIPTION	ADD SUFFIX #	DESCRIPTION
xC*	3' Cord (No Plug)	M	Motion Sensor (120, 277V)**
xT*	3' 120V Cord & Plug	M2	Motion Sensor (208, 240, 480V)**
xE*	3' 208V Cord & Plug	P	Pendant Mount
xF*	3' 240V Cord & Plug	W	Wireguard
xS*	3' 277V Cord & Plug	IC	Integrated Control**
EB	Emergency Back-Up	4	480V Driver

*x = 3 for 3' Cord; 6 for 6' cord, 10 for 10' cord; and 20 for 20' cord lengths

**End Panel Mounted

AMBIENT TEMPERATURE FIXTURE RATING

PART #	12" CHAIN MOUNT
ILH424LL	50°C (122°F)
ILH424L	50°C (122°F)

ENERGY SAVINGS

LED			HID		
WATTAGE	ANNUAL COST	SOURCE WATTAGE	TOTAL WATTAGE USED	ANNUAL COST	ANNUAL SAVINGS
166	\$73	400 MH	458	\$251	\$178
166	\$73	6L T5 FL	342	\$175	\$102



30,000 Lumen

2' LED High Bay

REPLACES UP TO 400W MH / 6L T5 FL



ILH230LL4K / ILH230L4K
 28,757 / 30,716 **LUMENS**

199 **WATTS**

144 / 154 **LPW**

80 **CRI**

4000K **CCT**

0-10V **DIMMING**

REC MNT HT
20 FT to 35 FT



19.25"Wx3.30"Hx25.50"L
11.2 LBS

ORDERING INFORMATION

CATALOG #	DESCRIPTION	LUMENS	VOLTS
ILH230LL4K	30,000 Lumen LED High Bay with Glare Free Lens	28,757	120-277
ILH230L4K	30,000 Lumen LED High Bay - No Lens	30,716	120-277

Specs shown are for 4000K CCT. Also available in 5000K. See Cut Sheet for more information.

ACCESSORIES

CATALOG #	DESCRIPTION
CH36	Chain Set
CH36HFC	Chain Set w/Hammer-On Flange Clip
CA36	Cable Set
MS360	360° Motion Sensor (120, 277V)
MS360-480	360° Motion Sensor (208, 240, 480V)

OPTIONS

ADD SUFFIX #	DESCRIPTION	ADD SUFFIX #	DESCRIPTION
xC*	3' Cord (No Plug)	M	Motion Sensor (120, 277V)**
xT*	3' 120V Cord & Plug	M2	Motion Sensor (208, 240, 480V)**
xE*	3' 208V Cord & Plug	P	Pendant Mount
xF*	3' 240V Cord & Plug	IC	Integrated Control**
XS*	3' 277V Cord & Plug	4	480V Driver

EB Emergency Back-Up

*x = 3 for 3' Cord; 6 for 6' cord, 10 for 10' cord; and 20 for 20' cord lengths

**End Panel Mounted



Hanging Hooks Included

AMBIENT TEMPERATURE FIXTURE RATING

PART #	12" CHAIN MOUNT
ILH212LL	55°C (131°F)
ILH212L	55°C (131°F)

ENERGY SAVINGS

LED		HID			
WATTAGE	ANNUAL COST	SOURCE WATTAGE	TOTAL WATTAGE USED	ANNUAL COST	ANNUAL SAVINGS
199	\$87	400 MH	458	\$251	\$164
199	\$87	6L T5 FL	342	\$175	\$88



*The majority of Atlas Lighting Products are assembled in USA facilities by an American Workforce utilizing both Domestic and Foreign components
 *Qualifies for Buy American under ARRA



30,000 Lumen



4' Slim LED High Bay REPLACES UP TO 400W MH / 6L T5 FL

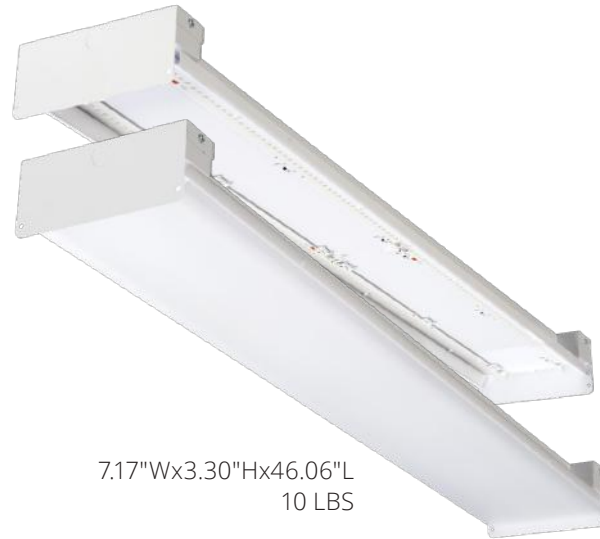

7.17"Wx3.30"Hx46.06"L
10 LBS

ILHS430LL4K / ILHS430L4K
28,519 / 30,352 **LUMENS**

198 **WATTS**

144 / 153 **LPW**

80 **CRI**

4000K **CCT**

0-10V **DIMMING**

REC MNT HT
20 FT to 35 FT

ORDERING INFORMATION

CATALOG #	DESCRIPTION	LUMENS	VOLTS
ILHS430LL	30,000 Lumen LED High Bay with Glare Free Lens	28,519	120-277
ILHS430L	30,000 Lumen LED High Bay - No Lens	30,352	120-277

Specs shown are for 4000K CCT. Also available in 5000K. See Cut Sheet for more information.

ACCESSORIES

CATALOG #	DESCRIPTION
CH36	Chain Set
CH36HFC	Chain Set w/Hammer-On Flange Clip
CA36	Cable Set
MS360	360° Motion Sensor (120, 277V)
MS360-480	360° Motion Sensor (208, 240, 480V)
WGH33	Wireguard



Hanging Hooks Included

OPTIONS

ADD SUFFIX #	DESCRIPTION	ADD SUFFIX #	DESCRIPTION
xC*	3' Cord (No Plug)	M	Motion Sensor (120, 277V)**
xT*	3' 120V Cord & Plug	M2	Motion Sensor (208, 240, 480V)**
xE*	3' 208V Cord & Plug	P	Pendant Mount
xF*	3' 240V Cord & Plug	W	Wireguard
xS*	3' 277V Cord & Plug	IC	Integrated Control**
EB	Emergency Back-Up	4	480V Driver

*x = 3 for 3' Cord; 6 for 6' cord, 10 for 10' cord; and 20 for 20' cord lengths

**End Panel Mounted

ENERGY SAVINGS

LED			HID		
WATTAGE	ANNUAL COST	SOURCE WATTAGE	TOTAL WATTAGE USED	ANNUAL COST	ANNUAL SAVINGS
198	\$87	400 MH	458	\$251	\$164
198	\$87	6L T5 FL	342	\$175	\$88

AMBIENT TEMPERATURE FIXTURE RATING

PART #	12" CHAIN MOUNT
ILHS430LL4K	50°C (122°F)
ILHS430L4K	50°C (122°F)



36,000 Lumen

4' LED High Bay

REPLACES UP TO 1000W MH



ILH436LL / ILH436L

35,120 / 37,540 **LUMENS**

249 **WATTS**

141 / 151 **LPW**

80 **CRI**

4500K **CCT**

0-10V **DIMMING**

REC MNT HT
25 FT to 40 FT



19.25"Wx3.30"Hx46.01"L
17.4 LBS

ORDERING INFORMATION

CATALOG #	DESCRIPTION	LUMENS	VOLTS
ILH436LL	36,000 Lumen LED High Bay with Glare Free Lens	35,120	120-277
ILH436L	36,000 Lumen LED High Bay - No Lens	37,540	120-277

Specs shown are for 4500K CCT. Also available in 4000K and 5000K. See Cut Sheet for more information.

ACCESSORIES

CATALOG #	DESCRIPTION
CH36	Chain Set
CH36HFC	Chain Set w/Hammer-On Flange Clip
CA36	Cable Set
MS360	360° Motion Sensor (120, 277V)
MS360-480	360° Motion Sensor (208, 240, 480V)
WGH36	Wireguard



Hanging Hooks Included

OPTIONS

ADD SUFFIX #	DESCRIPTION	ADD SUFFIX #	DESCRIPTION
xC*	3' Cord (No Plug)	M	Motion Sensor (120, 277V)**
xT*	3' 120V Cord & Plug	M2	Motion Sensor (208, 240, 480V)**
xE*	3' 208V Cord & Plug	P	Pendant Mount
xF*	3' 240V Cord & Plug	W	Wireguard
XS*	3' 277V Cord & Plug	IC	Integrated Control**
EB	Emergency Back-Up	4	480V Driver

*x = 3 for 3' Cord; 6 for 6' cord, 10 for 10' cord; and 20 for 20' cord lengths

**End Panel Mounted

ENERGY SAVINGS

LED		HID			
WATTAGE	ANNUAL COST	SOURCE WATTAGE	TOTAL WATTAGE USED	ANNUAL COST	ANNUAL SAVINGS
249	\$109	1000 MH	1080	\$523	\$414

AMBIENT TEMPERATURE FIXTURE RATING

PART #	12" CHAIN MOUNT
ILH436LL	50°C (122°F)
ILH436L	50°C (122°F)



*The majority of Atlas Lighting Products are assembled in USA facilities by an American Workforce utilizing both Domestic and Foreign components
*Qualifies for Buy American under ARRA



48,000 Lumen



4' LED High Bay
REPLACES UP TO 1000W MH



19.25"Wx3.30"Hx46.01"L
17.4 LBS

ILH448LL / ILH448L
40,760 / 44,450 **LUMENS** ☀️
303 **WATTS** ⚡️
135 / 146 **LPW** 💰
80 **CRI** ⊕
4500K **CCT** 🌈
0-10V **DIMMING** 📏
REC MNT HT
25 FT to 45 FT 📏

ORDERING INFORMATION

CATALOG #	DESCRIPTION	LUMENS	VOLTS
ILH448LL	48,000 Lumen LED High Bay with Glare Free Lens	40,760	120-277
ILH448L	48,000 Lumen LED High Bay - No Lens	44,450	120-277

Specs shown are for 4500K CCT. Also available in 4000K and 5000K. See Cut Sheet for more information.

ACCESSORIES

CATALOG #	DESCRIPTION
CH36	Chain Set
CH36HFC	Chain Set w/Hammer-On Flange Clip
CA36	Cable Set
MS360	360° Motion Sensor (120, 277V)
MS360-480	360° Motion Sensor (208, 240, 480V)
WGH36	Wireguard



Hanging Hooks Included

OPTIONS

ADD SUFFIX #	DESCRIPTION	ADD SUFFIX #	DESCRIPTION
xC*	3' Cord (No Plug)	M	Motion Sensor (120, 277V)**
xT*	3' 120V Cord & Plug	M2	Motion Sensor (208, 240, 480V)**
xE*	3' 208V Cord & Plug	P	Pendant Mount
xF*	3' 240V Cord & Plug	W	Wireguard
xS*	3' 277V Cord & Plug	IC	Integrated Control**
EB	Emergency Back-Up	4	480V Driver

*x = 3 for 3' Cord; 6 for 6' cord, 10 for 10' cord; and 20 for 20' cord lengths

**End Panel Mounted

AMBIENT TEMPERATURE FIXTURE RATING

PART #	12" CHAIN MOUNT
ILH448LL	50°C (122°F)
ILH448L	50°C (122°F)

ENERGY SAVINGS

LED			HID		
WATTAGE	ANNUAL COST	SOURCE WATTAGE	TOTAL WATTAGE USED	ANNUAL COST	ANNUAL SAVINGS
303	\$133	1000 MH	1080	\$523	\$390

200,000+ HOURS



18,000-30,000 Lumen

LED Round High Bay

REPLACES UP TO 400W MH



IRH18L / IRH24L / IRH30L
19,606 / 24,068 / 29,984

LUMENS
150 / 180 / 235 **WATTS**

132 / 135 / 129 **LPW**

85 **CRI**

5000K **CCT**

0-10V **DIMMING**

REC MNT HT
Up to 30 FT



13.4"W x 8.26"H
10.81 LBS

- 50°C Ambient Temp rating
- Optional Pendant mount adapter for easy one for one replacement
- Optional optics

ORDERING INFORMATION

CATALOG #	DESCRIPTION	LUMENS	VOLTS
IRH18L	18,000 Lumen LED Round High Bay, 5000K CCT	19,606	120-277
IRH24L	24,000 Lumen LED Round High Bay, 5000K CCT	24,068	120-277
IRH30L	30,000 Lumen LED Round High Bay, 5000K CCT	29,984	120-277

Specs shown are for 5000K CCT. Also available in 4000K. See Cut Sheet for more information.

ACCESSORIES

CATALOG #	DESCRIPTION
RHB16SAR	Spun Aluminum Reflector
RHB16FGC	16" Flat Glass and Clamp Band
RHB16WG	16" Wireguard
RHB16PAR	Prismatic Acrylic Refractor
RHB16CLC	16" Conical Lens and Clamp Band
IRH-PMK	Pendant Mount Adapter Kit; Fits 3/4" NPT

OPTIONS

ADD SUFFIX #	DESCRIPTION	ADD SUFFIX #	DESCRIPTION
M	Motion Sensor	IC	Integrated Control
4	480V Driver		

ENERGY SAVINGS

LED			HID		
WATTAGE	ANNUAL COST	SOURCE WATTAGE	TOTAL WATTAGE USED	ANNUAL COST	ANNUAL SAVINGS
150	\$66	175 MH	210	\$117	\$51
180	\$79	250 MH	290	\$157	\$78
235	\$103	400 MH	458	\$251	\$148

AMBIENT TEMPERATURE FIXTURE RATING

PART #	12" CHAIN MOUNT
IRH18L	50°C (122°F)
IRH24L	50°C (122°F)
IRH30L	50°C (122°F)



*The majority of Atlas Lighting Products are assembled in USA facilities by an American Workforce utilizing both Domestic and Foreign components
*Qualifies for Buy American under ARRA



LED Round High Bay

Options & Accessories



INTEGRATED CONTROLS

- Omni-Directional Infrared Motion Sensor
- Photocell Sensor for Daylight Harvesting
- Bi-Level Switching



MOTION SENSORS

- 2 Interchangeable, Application Specific Lenses (Aisle, High Bay, Low Bay)

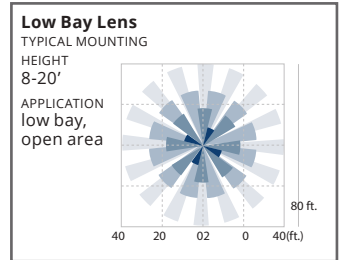
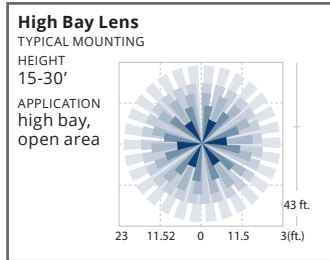
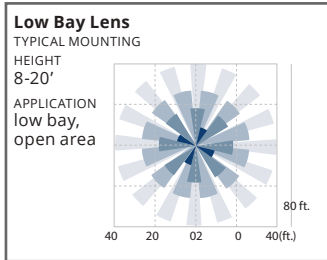
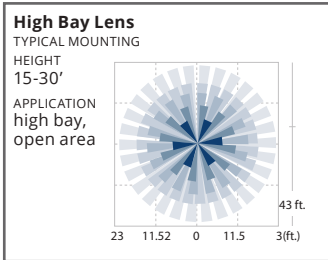

Options

SUFFIX#	DESCRIPTION
IC	Integrated Control (120, 277V)

Options

SUFFIX#	DESCRIPTION
M	360° Motion Sensor (120, 277V)

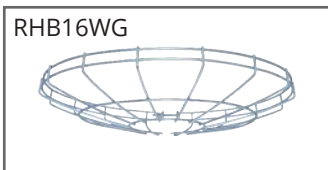

Optical Accessories

CATALOG #	DESCRIPTION
RHB16SAR	Spun Aluminum Reflector
RHB16FGC	16" Flat Glass and Clamp Band
RHB16WG	16" Wireguard
RHB16PAR	Prismatic Acrylic Refractor
RHB16CLC	16" Conical Lens and Clamp Band









Pendant Mount

CATALOG #	DESCRIPTION
IRH-PMK	Pendant Mount Adapter Kit; Fits 3/4" NPT

Comparisons

Linear Wet Location

LED				Fluorescent				
LENGTH	WATTS	ANNUAL COST	FIXTURE TYPE	TOTAL WATTAGE USED	ANNUAL COST	ANNUAL SAVINGS*		
	2 FT	25	\$11		2L T8	77	\$59	\$48
	4 FT	48	\$21		4L T8	151	\$91	\$70
	8 FT	76	\$33		6L T8	186	\$107	\$74
	8 FT	98	\$43		4L T5	238	\$129	\$86
	2 FT	76	\$33		6L T8	186	\$107	\$74
	2 FT	98	\$43		4L T5	238	\$129	\$86
	2 FT	130	\$57		6L T5	342	\$175	\$118
	4 FT	98	\$43		4L T5	238	\$129	\$86
	4 FT	130	\$57		6L T5	342	\$175	\$118
	4 FT	190	\$83		6L T5	342	\$175	\$92

*Based on 12 hours per day | \$0.10/KWH | Inc. Maintenance

IVT Ordering Format

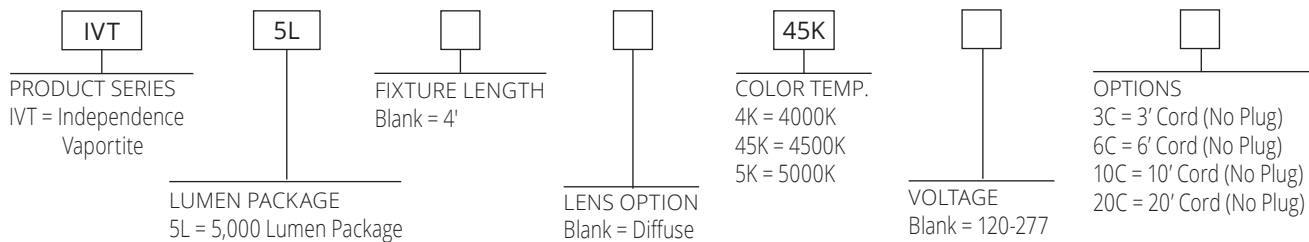

ILW Ordering Format

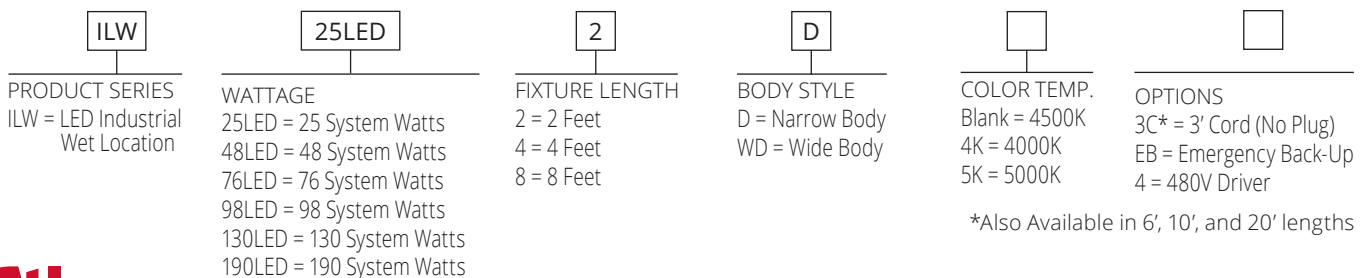

5,000 Lumen



4' LED Independence Vaportite
REPLACES UP TO 100W MH / 2L T5 FL / 4L T8 FL



14.5"Wx5.8"Hx26.6"L
13.2 LBS

IVT5L45K
4,849 **LUMENS**
34 **WATTS**
143 **LPW**
80 **CRI**
4500K **CCT**
0-10V **DIMMING**
REC MNT HT
10 FT to 14 FT

IP65 RATED

ORDERING INFORMATION

CATALOG #	DESCRIPTION	LUMENS	REPLACES UP TO	VOLTS
IVT5L45K	5,000 Lumen LED Independence Vaportite	4,849	4L T8 FL	120-277

Specs shown are for 4500K CCT. Also available in 4000K and 5000K. See Cut Sheet for more information.

AMBIENT TEMPERATURE FIXTURE RATING

PART #	12" CHAIN MOUNT
IVT5L45K	40°C (104°F)

OPTIONS

ADD SUFFIX #	DESCRIPTION	ADD SUFFIX #	DESCRIPTION
3C	3' Cord (No Plug)	10C	10' Cord (No Plug)
6C	6' Cord (No Plug)	20C	20' Cord (No Plug)

ENERGY SAVINGS

LED			HID		
WATTAGE	ANNUAL COST	SOURCE WATTAGE	TOTAL WATTAGE USED	ANNUAL COST	ANNUAL SAVINGS
34	\$15	100 MH	129	\$77	\$62
34	\$15	2L T5 FL	117	\$76	\$61
34	\$15	4L T8 FL	151	\$91	\$76



Potomac-AT Series

4' - 8' LED Wet Location Retrofit Kit

REPLACES UP TO 70W MH / 2L T8 FL



- Installs in less than 5 mins
- Easy upgrade to LED with gear tray retrofit
- Reduce power consumption up to 50%
- Ability to retrofit most T5 & T8 fluorescent wet location fixtures

ORDERING FORMAT

ILWRK	48LED	4	D		
PRODUCT SERIES ILWRK = LED Linear Wet Location Retrofit Kit	WATTAGE 30LED = 30 System Watts ¹ 48LED = 48 System Watts ¹ 76LED = 76 System Watts ¹ 98LED = 98 System Watts ¹ 130LED = 130 System Watts ² 190LED = 190 System Watts ² ¹ Narrow body only ² Wide body only	FIXTURE LENGTH 4 = 4 Feet 8 = 8 Feet ¹	BODY STYLE D = Narrow Body WD = Wide Body	COLOR TEMP. Blank = 4500K 4K = 4000K 5K = 5000K	OPTIONS EB = Emergency Back-Up 4 = 480V Driver

DIMENSIONS

4' NARROW WET LOCATION RETROFIT KIT

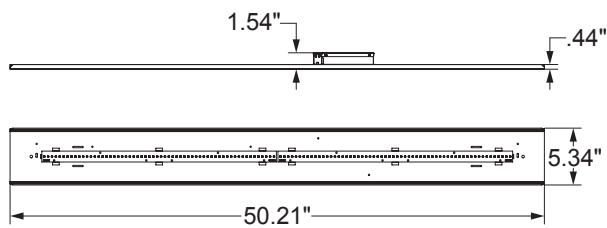

4' WIDE WET LOCATION RETROFIT KIT

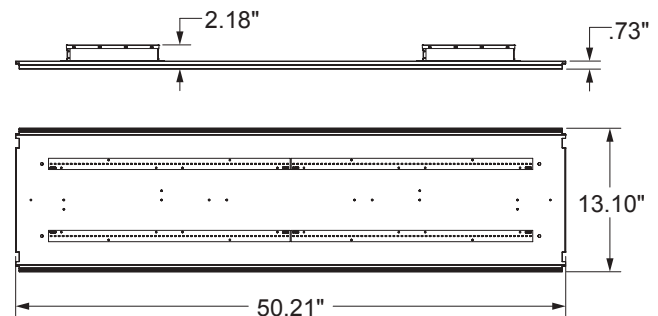

8' NARROW WET LOCATION RETROFIT KIT

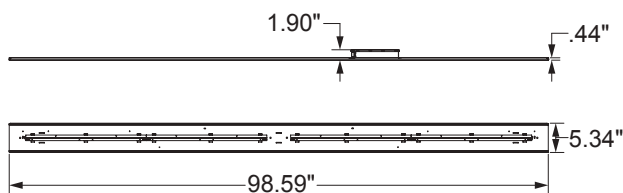

*The majority of Atlas Lighting Products are assembled in USA facilities by an American Workforce utilizing both Domestic and Foreign components
*Qualifies for Buy American under ARRA



Potomac-AT Series

4' - 8' LED Wet Location Retrofit Kit

PERFORMANCE DATA

UNIT	CRI	4000K CCT		4500K CCT		5000K CCT		WATTAGE	FITTURE REPLACEMENT
		DELIVERED LUMENS	EFFICACY (LPW)	DELIVERED LUMENS	EFFICACY (LPW)	DELIVERED LUMENS	EFFICACY (LPW)		
ILWRK30LED4D	80	4511	143	4511	143	4508	143	30	4' 2 Lamp T8
ILWRK48LED4D	80	6695	138	6695	138	6695	138	48	4' 2 Lamp T5
ILWRK76LED8D	80	10650	143	10650	143	10650	143	76	8' 2 Lamp T8
ILWRK98LED8D	80	13060	138	13060	138	13060	138	98	8' 2 Lamp T5
ILWRK98LED4WD	80	14130	147	14130	147	14130	147	98	4' 4 Lamp T8
ILWRK130LED4WD	80	17590	135	17590	135	17590	135	130	4' 4 Lamp T5 or 6 Lamp T8
ILWRK190LED4WD	80	27480	144	27480	144	27480	144	190	4' 6 Lamp T5

EASY INSTALLATION



STEP 1

Unhinge the latches and remove the lens.



STEP 2

Remove the lamps, disconnect the ballast, and remove the gear tray from the housing.



STEP 3

Install the provided clips into the housing and securely attach the safety straps.



STEP 4

Complete all necessary electrical connections, then push the LED tray into the clips to secure it.



STEP 5

Reattach the lens. Reconnect the power to the fixture to complete the installation.

COMPATIBLE FIXTURES

- Columbia XEM
- Columbia HEM
- SimkarEN2
- Texas Fluorescents CIT
- LDPI 376
- Atlas IFW
- LSI EG3
- TechBrite VaporBrite
- Howard VSA
- HE Williams 96 Series

25 Watt

2' Narrow LED Wet Location

REPLACES UP TO 70W MH / 2L T8 FL



- 4,455 **LUMENS**
- 25 **WATTS**
- 142 **LPW**
- 80 **CRI**
- 4500K **CCT**
- 0-10V **DIMMING**
- REC MNT HT**
8 FT to 12 FT



6.77"Wx4.13"Hx27.68"L
4.4 LBS

IP65 RATED

IP66 RATED

IP67 RATED

NSF

ORDERING INFORMATION

CATALOG #	DESCRIPTION	LUMENS	VOLTS
ILW25LED2D	25W LED Wet Location with Glare Free Lens	4,455	120-277

Specs shown are for 4500K CCT. Also available in 4000K and 5000K. See Cut Sheet for more information.

ACCESSORIES

CATALOG #	DESCRIPTION
MS360WL	Wet Location 360° Motion Sensor
150-103WL45-4	45° Mounting Bracket (Pack of 2)

OPTIONS

ADD SUFFIX #	DESCRIPTION	ADD SUFFIX #	DESCRIPTION
xC*	3' Cord (No Plug)	L	Stainless Steel Latches

*x = 3 for 3' Cord; 6 for 6' cord; 10 for 10' cord; and 20 for 20' cord lengths



Mounting Clips and Bail Included

AMBIENT TEMPERATURE FIXTURE RATING

PART #	12" CHAIN MOUNT
ILW25LED2D	40°C (104°F)

ENERGY SAVINGS

LED		HID			
WATTAGE	ANNUAL COST	SOURCE WATTAGE	TOTAL WATTAGE USED	ANNUAL COST	ANNUAL SAVINGS
25	\$11	70	90	\$64	\$53
25	\$11	2L T8 FL	77	\$59	\$48



*The majority of Atlas Lighting Products are assembled in USA facilities by an American Workforce utilizing both Domestic and Foreign components
*Qualifies for Buy American under ARRA



48 Watt



4' Narrow LED Wet Location REPLACES UP TO 100W MH / 2L T5 FL / 4L T8 FL



6.77"Wx4.13"Hx51.65"L
9.5 LBS

ILW30LED4D / ILW48LED4D

4,270 / 6,695 **LUMENS**

30 / 48 **WATTS**

x / 138 **LPW**

80 **CRI**

4500K **CCT**

0-10V **DIMMING**

REC MNT HT
10 FT to 14 FT

IP65 RATED

IP66 RATED

IP67 RATED

NSF

ORDERING INFORMATION

CATALOG #	DESCRIPTION	LUMENS	VOLTS
ILW30LED4D	30W LED Wet Location with Glare Free Lens	4,270	120-277
ILW48LED4D	48W LED Wet Location with Glare Free Lens	6,695	120-277

Specs shown are for 4500K CCT. Also available in 4000K and 5000K. See Cut Sheet for more information.

ACCESSORIES

CATALOG #	DESCRIPTION
MS360WL	Wet Location 360° Motion Sensor
150-103WL45-4	45° Mounting Bracket (Pack of 2)

OPTIONS

ADD SUFFIX #	DESCRIPTION	ADD SUFFIX #	DESCRIPTION
xC*	3' Cord (No Plug)	L	Stainless Steel Latches
EB	Emergency Back-Up	4	480V Driver

*x = 3 for 3' Cord; 6 for 6' cord, 10 for 10' cord; and 20 for 20' cord lengths



Mounting Clips and Bail Included

AMBIENT TEMPERATURE FIXTURE RATING

PART #	12" CHAIN MOUNT
ILW30LED4D	40°C (104°F)
ILW48LED4D	40°C (104°F)

ENERGY SAVINGS

LED		HID			
WATTAGE	ANNUAL COST	SOURCE WATTAGE	TOTAL WATTAGE USED	ANNUAL COST	ANNUAL SAVINGS
30	\$13	100	129	\$77	\$64
30	\$13	2L T5 FL	117	\$76	\$65
48	\$21	2L T5 FL	117	\$76	\$55
48	\$21	4L T8 FL	151	\$91	\$70

200,000+ HOURS



76-98 Watt

8' Narrow LED Wet Location

REPLACES UP TO 4L T5 FL / 6L T8 FL



ILW76LED8D / ILW98LED8D

10,650 / 13,060 **LUMENS**

76 / 98 **WATTS**

143 / 138 **LPW**

80 / 80 **CRI**

4500K **CCT**

0-10V **DIMMING**

REC MNT HT
12-16 FT / 14-18 FT



6.77"Wx4.13"Hx100"L
16.9 LBS

IP65 RATED

IP66 RATED

IP67 RATED



ORDERING INFORMATION

CATALOG #	DESCRIPTION	LUMENS	VOLTS
ILW76LED8D	76W LED Wet Location with Glare Free Lens	10,650	120-277
ILW98LED8D	98W LED Wet Location with Glare Free Lens	13,060	120-277

Specs shown are for 4500K CCT. Also available in 4000K and 5000K. See Cut Sheet for more information.

ACCESSORIES

CATALOG #	DESCRIPTION
MS360WL	Wet Location 360° Motion Sensor
150-103WL45-4	45° Mounting Bracket (Pack of 2)

OPTIONS

ADD SUFFIX #	DESCRIPTION	ADD SUFFIX #	DESCRIPTION
xC*	3' Cord (No Plug)	L	Stainless Steel Latches
EB	Emergency Back-Up	4	480V Driver

*x = 3 for 3' Cord; 6 for 6' cord; 10 for 10' cord; and 20 for 20' cord lengths



Mounting Clips and Bail Included

AMBIENT TEMPERATURE FIXTURE RATING

PART #	12" CHAIN MOUNT
ILW76LED8D	45°C (113°F)
ILW98LED8D	45°C (113°F)

ENERGY SAVINGS

LED		HID			
WATTAGE	ANNUAL COST	SOURCE WATTAGE	TOTAL WATTAGE USED	ANNUAL COST	ANNUAL SAVINGS
76	\$33	4L T5 FL	238	\$129	\$96
76	\$33	6L T8 FL	186	\$107	\$74
98	\$43	4L T5 FL	238	\$129	\$86
98	\$43	6L T8 FL	186	\$107	\$64



*The majority of Atlas Lighting Products are assembled in USA facilities by an American Workforce utilizing both Domestic and Foreign components
*Qualifies for Buy American under ARRA



76-130 Watt



2' LED Wet Location

REPLACES UP TO 4L T5 FL / 6L T8 FL / 6L T5 FL



14.5"Wx5.8"Hx26.6"L
13.2 LBS

ILW76LED2WD / ILW98LED2WD / ILW130LED2WD

10,380 / 13,570 / 16,930 **LUMENS**

76 / 98 / 130 **WATTS**

149 / 143 / 132 **LPW**

80 / 80 / 80 **CRI**

4500K **CCT**

0-10V **DIMMING**

REC MNT HT
12-16 FT / 14-18 FT / 14-20 FT



ORDERING INFORMATION

CATALOG #	DESCRIPTION	LUMENS	REPLACES UP TO	VOLTS
ILW76LED2WD	76W LED Wet Location with Glare Free Lens	10,380	4L T5 FL / 6L T8 FL	120-277
ILW98LED2WD	98W LED Wet Location with Glare Free Lens	13,570	4L T5 FL / 6L T8 FL	120-277
ILW130LED2WD	130W LED Wet Location with Glare Free Lens	16,930	6L T5 FL	120-277

Specs shown are for 4500K CCT. Also available in 4000K and 5000K. See Cut Sheet for more information.

ACCESSORIES

CATALOG #	DESCRIPTION
MS360WL	Wet Location 360° Motion Sensor
80-271CMB	Ceiling Mount Bracket



V Hooks Included

OPTIONS

ADD SUFFIX #	DESCRIPTION	ADD SUFFIX #	DESCRIPTION
xC*	3' Cord (No Plug)	4	480V Driver
EB	Emergency Back-Up		

*x = 3 for 3' Cord; 6 for 6' cord, 10 for 10' cord; and 20 for 20' cord lengths

ENERGY SAVINGS

LED		HID			
WATTAGE	ANNUAL COST	SOURCE WATTAGE	TOTAL WATTAGE USED	ANNUAL COST	ANNUAL SAVINGS
76	\$33	4L T5 FL	238	\$129	\$96
76	\$33	6L T8 FL	186	\$107	\$74
98	\$43	4L T5 FL	238	\$129	\$86
98	\$43	6L T8 FL	186	\$107	\$64
130	\$57	6L T5 FL	342	\$175	\$118

AMBIENT TEMPERATURE FIXTURE RATING

PART #	12" CHAIN MOUNT
ILW76LED2WD	45°C (113°F)
ILW98LED2WD	45°C (113°F)
ILW130LED2WD	45°C (113°F)



*The majority of Atlas Lighting Products are assembled in USA facilities by an American Workforce utilizing both Domestic and Foreign components
*Qualifies for Buy American under ARRA



98-190 Watt

4' LED Wet Location

REPLACES UP TO 6L T5 FL



ILW98LED4WD / ILW130LED4WD / ILW190LED4WD

14,130 / 17,590 / 27,480 **LUMENS**

98 / 130 / 190 **WATTS**

147 / 135 / 144 **LPW**

80 **CRI**

4500K **CCT**

0-10V **DIMMING**

REC MNT HT
14-18 FT / 14-20 FT / 16-22FT



14.375"Wx6.25"Hx51.5"L
21 LBS

IP65 RATED

IP66 RATED

IP67 RATED



ORDERING INFORMATION

CATALOG #	DESCRIPTION	LUMENS	VOLTS
ILW98LED4WD	98W LED Wet Location with Glare Free Lens	14,130	120-277
ILW130LED4WD	130W LED Wet Location with Glare Free Lens	17,590	120-277
ILW190LED4WD	190W LED Wet Location with Glare Free Lens	27,480	120-277

Specs shown are for 4500K CCT. Also available in 4000K and 5000K. See Cut Sheet for more information.

ACCESSORIES

CATALOG #	DESCRIPTION
MS360WL	Wet Location 360° Motion Sensor
80-271CMB	Ceiling Mount Bracket

OPTIONS

ADD SUFFIX #	DESCRIPTION	ADD SUFFIX #	DESCRIPTION
xC*	3' Cord (No Plug)	4	480V Driver

EB Emergency Back-Up

*x = 3 for 3' Cord; 6 for 6' cord, 10 for 10' cord; and 20 for 20' cord lengths



V Hooks Included

ENERGY SAVINGS

LED		HID			
WATTAGE	ANNUAL COST	SOURCE WATTAGE	TOTAL WATTAGE USED	ANNUAL COST	ANNUAL SAVINGS
98	\$43	4L T5 FL	238	\$129	\$86
98	\$43	6L T8 FL	186	\$107	\$74
130	\$57	6L T5 FL	342	\$175	\$118
190	\$83	6L T5 FL	342	\$175	\$92

AMBIENT TEMPERATURE FIXTURE RATING

PART #	12" CHAIN MOUNT
ILW98LED4WD	45°C (113°F)
ILW130LED4WD	45°C (113°F)
ILW190LED4WD	45°C (113°F)



*The majority of Atlas Lighting Products are assembled in USA facilities by an American Workforce utilizing both Domestic and Foreign components
*Qualifies for Buy American under ARRA



Field Adjustable

1'x4' | 2'x2' | 2'x4' LED Edge Lit Flat Panel



- Field Adjustable Lumen Output and Color Temp.
- Quick Connects for easy installation
- PMMA lens designed not to yellow
- 120° beam angle for smooth and uniform light
- Ultra thin design < 2" height



FAELP14: 12"Wx0.5"Hx47.75"L
 FAELP22: 23.75"Wx0.5"Hx23.75"L
 FAELP24: 24"Wx0.5"Hx47.75"L

PERFORMANCE DATA

FAELP14LED	25 Watts (adjustable)			30 Watts (adjustable)			40 Watts (adjustable)		
	CCT:	3500K	4000K	5000K	3500K	4000K	5000K	3500K	4000K
Lumens:	3,102	3,274	3,154	3,513	3,748	3,570	4,398	4,767	4,464
LpW:	121	132	123	118	130	120	110	125	112
CRI:	>80			>80			>80		

FAELP22LED	25 Watts (adjustable)			30 Watts (adjustable)			40 Watts (adjustable)		
	CCT:	3500K	4000K	5000K	3500K	4000K	5000K	3500K	4000K
Lumens:	3,187	3,385	3,259	3,599	3,863	3,683	4,412	4,856	4,542
LpW:	121	133	122	117	131	119	109	126	111
CRI:	>80			>80			>80		

FAELP24LED	30 Watts (adjustable)			35 Watts (adjustable)			45 Watts (adjustable)		
	CCT:	3500K	4000K	5000K	3500K	4000K	5000K	3500K	4000K
Lumens:	3,248	3,413	3,409	3,702	3,921	3,891	4,698	5,046	4,971
LpW:	112	120	117	109	119	115	104	115	110
CRI:	>80			>80			>80		

OPTIONS

ADD SUFFIX #	DESCRIPTION
EB	Emergency Back-Up

ACCESSORIES

CATALOG #	DESCRIPTION
SMK14	Frame Kits for Surface Mount Panels



3,000-8,000 Lumen

4' | 8' LED Linear Strip



ILS4: 4.378"Wx4.379"Hx48"L

ILS8: 4.378"Wx4.379"Hx95.947"L

4' PERFORMANCE DATA

UNIT	CRI	3500K CCT		4000K CCT		5000K CCT		WATTAGE
		DELIVERED LUMENS	EFFICACY (LPW)	DELIVERED LUMENS	EFFICACY (LPW)	DELIVERED LUMENS	EFFICACY (LPW)	
ILS43LL	80	3,041	135	3,032	134	3,242	143	23
ILS45LL	80	5,017	131	5,002	130	5,348	139	38
ILS46LL	80	6,036	138	6,018	137	6,434	147	44
ILS48LL	80	8,072	132	8,048	132	8,605	141	61

8' PERFORMANCE DATA

UNIT	CRI	3500K CCT		4000K CCT		5000K CCT		WATTAGE
		DELIVERED LUMENS	EFFICACY (LPW)	DELIVERED LUMENS	EFFICACY (LPW)	DELIVERED LUMENS	EFFICACY (LPW)	
ILS88LL	80	8,212	136	8,075	133	8,664	143	61



*The majority of Atlas Lighting Products are assembled in USA facilities by an American Workforce utilizing both Domestic and Foreign components
 *Qualifies for Buy American under ARRA



2,000-8,000 Lumen

2' | 4' LED Stairwell Light



SWL2: 6.8"Wx5"Hx24.25"L

SWL4: 6.8"Wx5"Hx48.25"L

ORDERING FORMAT

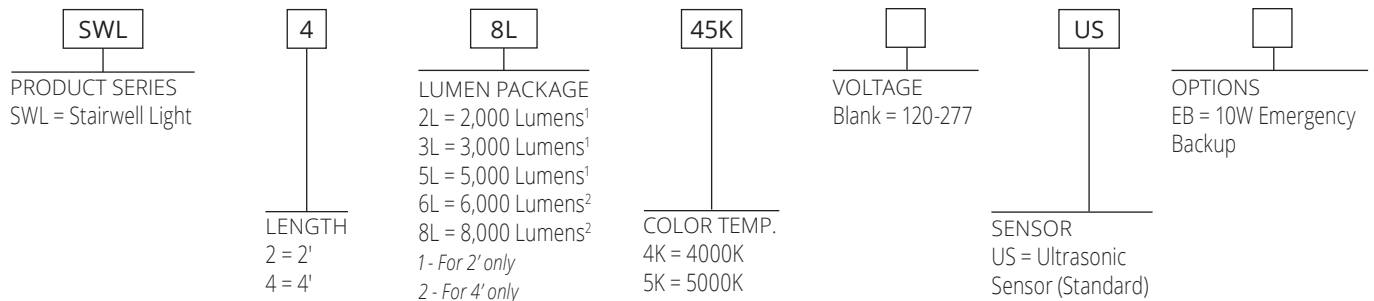

2' PERFORMANCE DATA

LENGTH	LUMEN PACKAGE	WATTAGE	3000K		4000K		5000K	
			DELIVERED LUMENS	EFFICACY	DELIVERED LUMENS	EFFICACY	DELIVERED LUMENS	EFFICACY
2'	2L	16	1,856	116	1,968	123	2,032	127
2'	3L	23	2,737	119	2,967	129	3,036	132

4' PERFORMANCE DATA

LENGTH	LUMEN PACKAGE	WATTAGE	3000K		4000K		5000K	
			DELIVERED LUMENS	EFFICACY	DELIVERED LUMENS	EFFICACY	DELIVERED LUMENS	EFFICACY
4'	5L	36	4,644	129	5,011	139	5,040	140
4'	6L	44	5,544	126	5,940	135	6,028	137
4'	8L	62	7,502	121	8,044	129	8,184	132



*The majority of Atlas Lighting Products are assembled in USA facilities by an American Workforce utilizing both Domestic and Foreign components
*Qualifies for Buy American under ARRA



Linear LED

Options & Accessories



FIG. A

INTEGRATED CONTROLS

- Omni-Directional Infrared Motion Sensor
- Photocell Sensor for Daylight Harvesting
- Bi-Level Switching

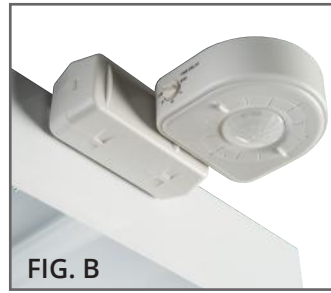
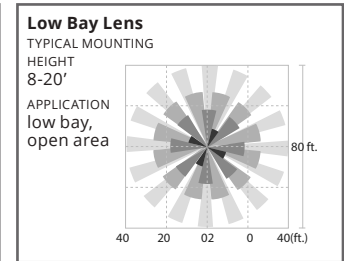
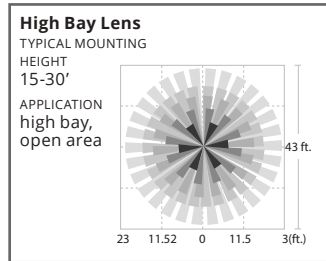
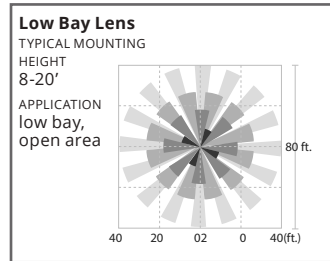
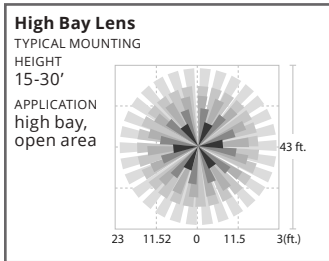

FIG. B

MOTION SENSORS

- 3 Interchangeable, Application Specific Lenses (Aisle, High Bay, Low Bay)



FACTORY INSTALLED OPTIONS

SUFFIX#	DESCRIPTION
IC	Integrated Control (120, 277V) (FIG. A)
M	360° Motion Sensor (120, 277V) (FIG. B)
M2	360° Motion Sensor (208, 240, 480V) (FIG. B)

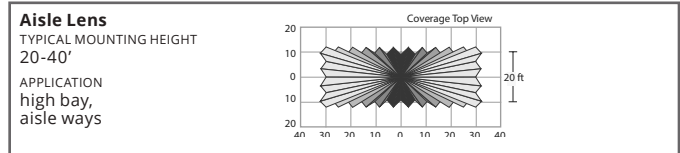

FIELD AVAILABLE ACCESSORIES

CATALOG#	DESCRIPTION
MS360	360° Motion Sensor (120, 277V) (FIG. B)
MS360-480	360° Motion Sensor (208, 240, 480V) (FIG. B)
MS360WL	Wet Location Motion Sensor (120, 277V) (FIG. C)
MS360WL-480	Wet Location Motion Sensor (208, 240, 480V) (FIG. C)



FIG. C

WET LOCATION MOTION SENSORS

- Wet Location 360° Motion Sensor

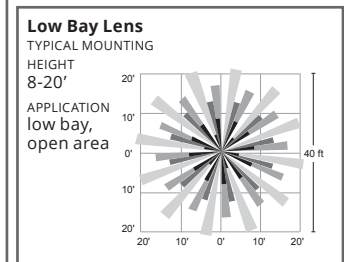

CORD SETS

- Available in Several Lengths
- With or Without Molded Plug

FACTORY INSTALLED OPTIONS

SUFFIX#	DESCRIPTION
xC*	x' Cord
xT*	x' 120V Plug
xE*	x' 208V Plug
xF*	x' 240V Plug
xS*	x' 277V Plug

*x = 3 for 3' Cord; 6 for 6' cord, 10 for 10' cord; and 20 for 20' cord lengths

Linear LED

Options & Accessories

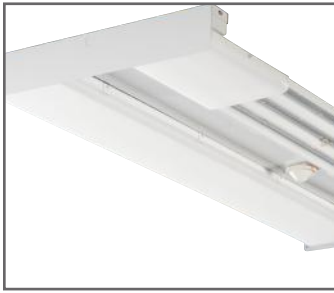

HIGH TRANSMISSION LENS

- Frosted Acrylic Lens
- 91% Efficiency
- Provides Improved Visual Comfort
- High Impact with Scratch Resistant Surface
- Provides Wider, Smoother, & Uniform Light Output
- Protects LEDs

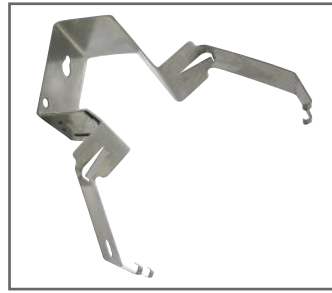

45° MOUNTING BRACKET

- For Narrow Wet Location Fixtures
- Mounts the Fixture at a 45° Angle Away From the Wall

FACTORY INSTALLED OPTIONS

SUFFIX#	DESCRIPTION
L	Tool-less Snap On Lens

FIELD AVAILABLE ACCESSORIES

CATALOG#	DESCRIPTION
150-103WL45-4	45° Mounting Bracket (Pack of 2)
150-103WL45-8	45° Mounting Bracket (Pack of 3)

FACTORY INSTALLED OPTIONS

SUFFIX#	DESCRIPTION
W	Wireguard for Narrow High Bay - installed
W	Wireguard for Wide High Bay - installed

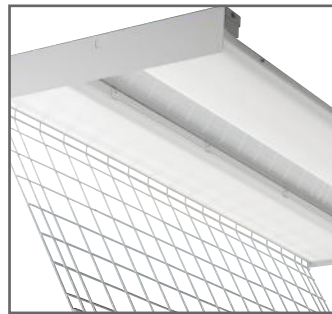

WIREGUARD

- Protects Fixtures from Hazards
- Tool-less Entry
- Hinges Down



FIELD AVAILABLE ACCESSORIES

CATALOG#	DESCRIPTION
WGH33	Wireguard for Narrow 4' High Bay
WGH36	Wireguard for Wide 4' High Bay

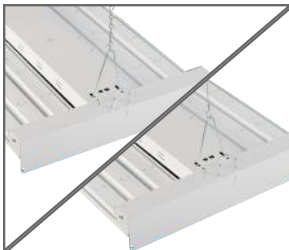

HANGERS

- Either Chain or Cable Available
- Comes with V-hooks

FIELD AVAILABLE ACCESSORIES

CATALOG#	DESCRIPTION
CH36	36" Chain Set (Set of 2)
CH36HFC	36" Chain Set w/ Hammer-On Flange
CA36	36" Cable Set (Set of 2)

FACTORY INSTALLED OPTIONS

SUFFIX#	DESCRIPTION
P	Pendant Mount



PENDANT MOUNT

- Accepts 3/4" Rigid Conduit
- Single Point Mounting

FIELD AVAILABLE ACCESSORIES

CATALOG#	DESCRIPTION
PMK	Pendant Mount Kit for 4' High Bay
PMK-2	Pendant Mount Kit for 2' High Bay

FACTORY INSTALLED OPTIONS

SUFFIX#	DESCRIPTION
SP	10Kv Surge Protector

FIELD AVAILABLE ACCESSORIES

CATALOG#	DESCRIPTION
80-SP	10Kv Surge Protection
80-HS	Hook Set (2)

EXP Series

Thermoplastic LED Exit Sign



12.625"Wx8.125"Hx1.75"L

- Maintenance-free nickel-cadmium battery
- Energy-saving LED
- Injection-molded, high-impact, UV-stabilized, UL94 V-0 thermoplastic construction
- Top, back, J-box or end mounting through universal mounting plate and canopy

ORDERING INFORMATION

CATALOG #	DESCRIPTION	LETTER COLOR	VOLTS
EXPRWR	Thermoplastic Exit Sign	Red	120-277
EXPRWG	Thermoplastic Exit Sign	Green	120-277
EXPRWRC	Thermoplastic Exit Sign - Remote Capable	Red	120-277
EXPRWGRC	Thermoplastic Exit Sign - Remote Capable	Green	120-277

EEC Series

Thermoplastic LED Exit/Emergency Combo



18"Wx8.125"Hx1.75"D

- Maintenance-free nickel-cadmium battery
- Energy-saving LED
- Injection-molded, high-impact, UV-stabilized, UL94 V-0 thermoplastic construction
- Top, back, J-box or end mounting through universal mounting plate and canopy

ORDERING INFORMATION

CATALOG #	DESCRIPTION	LETTER COLOR	VOLTS
EECPWR	Thermoplastic LED Exit/Emergency Combo	Red	120-277
EECPWG	Thermoplastic LED Exit/Emergency Combo	Green	120-277
EECPWRC	Thermoplastic LED Exit/Emergency Combo - Remote Capable	Red	120-277
EECPWGRC	Thermoplastic LED Exit/Emergency Combo - Remote Capable	Green	120-277

EMO Series

Oval 2 Headed Emergency Light

- Maintenance-free nickel-cadmium battery (RC version nickel-metal hydride)
- Injection-molded, high-impact, UV-stabilized, UL94 V-0 thermoplastic construction
- Universal J-box pattern knock-out & mounting plate w/ quick connect features
- Fully adjustable glare free LED heads
- RC version provides 3.44 watts for 90 minutes



9"Wx4.75"Hx2.75"D

ORDERING INFORMATION

CATALOG #	DESCRIPTION	FINISH	VOLTS
EMO2A	Oval 2 headed emergency light	White	120/277
EMO2ARC	Oval 2 headed emergency light - Remote Capable	White	120/277

ERD Series

Architectural Emergency Light

- Long-life, efficient ultra-bright white LED
- Mirror-bright reflector and prismatic polycarbonate refractor
- Die-cast aluminum housing
- Durable powder-coated finish
- Sealed and gasketed
- Cold-weather unit for use in temperatures as low as -30°C



6.125"Wx10.5"Hx3.625"D

ORDERING INFORMATION

CATALOG #	DESCRIPTION	FINISH	VOLTS
ERD12BZ	Architectural LED Emergency Light with Photocell	Bronze	120/277
ERD12WT	Architectural LED Emergency Light with Photocell	White	120/277



ERHR Series

Indoor/Outdoor LED Remote Heads

ORDERING INFORMATION

CATALOG #	DESCRIPTION	VOLTAGE	TOTAL WATTAGE
ERHR12	Single Remote Head - Indoor/Outdoor	3.6 Volts	1.17 Watts
ERHR22	Double Remote Head - Indoor/Outdoor	3.6 Volts	2.34 Watts



PO Box 2348 Burlington, NC 27216
1406 S. Mebane Street Burlington, NC 27215
800-849-8485 | Fax: 1-855-847-2794
www.atlasled.com

452-254 070522