



Alberta Spa

Owners Manual

243x 213 x 87cm (96 x 84 x 34")

KH-10018



For Service Support please contact us anytime:
support.canadianspacompany.com



canadianspacompany.com

SAFETY INFORMATION - Europe (50Hz)

IMPORTANT SAFETY INSTRUCTIONS

When installing and using this electrical equipment be sure to follow these basic safety precautions:

1. **WARNING:** To reduce the risk of injury, do not permit children to use this product unless they are closely supervised at all times.
2. **DANGER:** Risk of accidental drowning. Extreme caution must be exercised to prevent unauthorised access by children. To avoid accidents, ensure that children cannot use this spa unless they are supervised at all times.
3. **DANGER:** Risk of injury. The suction fittings in this spa are sized to match specific water flow created by the pump. Should the need arise to replace the suction fitting or the pump, ensure that the flow rates are compatible. Never operate the spa if suction fittings are broken or missing. Never replace a suction fitting with one rated less than the flow rate marked on the original suction fitting.
4. **DANGER:** Risk of Electrical Shock. Install at least 5 feet (1.5m) from all metal surfaces. As an alternative, spa may be installed within 5 feet (1.5m) of metal surfaces if each metal surface is permanently connected (bonded) by a minimum ground wire.
5. **DANGER:** Risk of Electrical Shock. Do not permit any electrical appliance such as a light, telephone, radio, television, etc. within 5 feet (1.5m) of a spa unless such appliances are installed and built-in by the manufacturer.
6. **ELECTRICAL SUPPLY:** The electrical supply for this product must include a suitably rated switch or circuit breaker to open all ungrounded supply conductors to comply with the national electrical standards. This disconnect must be readily accessible and visible to the spa occupant but installed at least 5 feet (1.5m), from the spa water.
7. **WARNING:** To reduce the risk of injury:
 - a) The water in the spa should never exceed 40°C (104°F). Water temperature between 38°C (100°F) and 40°C (104°F) is considered safe for a healthy adult. Lower water temperatures are recommended for young children and when the spa use exceeds 10 minutes.
 - b) Since excessive water temperatures have a high potential for causing foetal damage during early months of pregnancy, pregnant women should limit spa water temperatures to 38°C (100°F)
 - c) Before entering a spa, the user should measure the water temperature with an accurate thermometer since the tolerance of water temperature regulating devices varies.
 - d) The use of alcohol, drugs, or medication before or during spa use may lead to unconsciousness with the possibility of drowning.
 - e) Obese persons and persons with a history of heart disease, low or high blood pressure, circulatory system problems, or diabetes should consult a physician before using a spa.
 - f) Persons using medication should consult a physician before using a spa since some medication may induce drowsiness while other medication may affect heart rate, blood pressure, and circulation.
8. **AUDIO/VIDEO EQUIPMENT WARNINGS (Optional equipment based on model)**

CAUTION: Risk of Electrical Shock. Do not leave compartment door open.
9. **CAUTION:** Risk of Electrical Shock. Replace components only with identical components.
10. **WARNING:** Prevent Electrocutation. Do not connect any auxiliary components (for example cable, additional speakers, headphones, additional audio/video components, etc.) to system.
11. **CAUTION:** Risk of Electrical Shock. Do not service this product yourself as opening or removing audio covers may expose you to dangerous voltage or other risk of injury. Refer all servicing to qualified service personnel.
12. **CAUTION:** Risk of Electrical Shock. When the power supply connections or power supply cord(s) are damaged; if water is entering the audio / video compartment or any electrical equipment compartment area; if the protective shields or barriers are showing signs of deterioration; or if there are signs of other potential damage to the unit, turn off the unit and refer the servicing to a qualified service personnel.
13. This unit should be subject to periodic routine maintenance (for example, once every 3 months) to make sure that the unit is operating properly.
14. **CAUTION:** Do not operate audio video controls while inside the spa
15. Installation of the spa for other than a residential dwelling will result in voiding the manufacturer's warranty.
16. Do not bring any object into the spa that could damage the spa shell.
17. Never insert any object into any opening.
18. **WARNING:** Do not sit on the spa cover or place objects on it.
19. Remove any water or debris that may collect on the spa cover.
20. **WARNING:** Do not use the spa immediately after strenuous exercise.
21. If you feel pain or dizziness at any time while using the spa, discontinue use and contact a physician.
22. **WARNING:** To reduce risk of injury it is especially important that persons with pre-existing health conditions or problems such as obesity, heart disease, high or low blood pressure, circulatory problems, pregnancy or diabetes to consult their doctor before using the spa.
23. **WARNING:** Observe reasonable time limits when using the spa. Long exposures at high temperatures can cause high body temperatures. Symptoms may include dizziness, nausea, fainting, drowsiness, and reduced awareness. These effects could possibly result in drowning.
24. **WARNING:** The spa jets produce a stream of water with relatively high pressure. Prolonged exposure of localized area of the body may cause bruises to the skin.
25. **IMPORTANT:** The include warning sign must be posted where all users of the spa can see and read it.
26. **WARNING:** To avoid risk of drowning. The Spa cover should be in place and properly latched when spa is not in use.
27. **IMPORTANT:** Read and understand the warnings on the spa cover.
28. Proper water chemistry is necessary to maintain the water and prevent possible damage to spa components.

 **WARNING**
REDUCE THE RISK OF ELECTROCUTION

1. Never place an electric appliance within 5 feet (1.5m) of spa.

REDUCE THE RISK OF CHILDREN DROWNING

1. Supervise children at all times.
2. Attach and lock down spa cover after each use.

REDUCE THE RISK OF OVERHEATING

1. Check with a doctor before use if pregnant, diabetic, in poor health, or under medical care.
2. Exit immediately if uncomfortable, dizzy, or sleepy. Spa heat can cause hypothermia and unconsciousness.
3. Spa heat in conjunction with alcohol, drugs, or medication can cause unconsciousness.

WHEN PREGNANT: soaking in hot water for long periods can harm your fetus. Measure water temperature before entering

1. Do not enter spa if water is hotter than 100°F (38°C).
2. Do not stay in spa for longer than 10 minutes.



REGISTER YOUR WARRANTY ONLINE

Please be sure to register your spa so we can efficiently assist with any questions you may have. Until your spa has been registered, we will not have record of your ownership.

To register your spa, visit: canadianspacompany.com/pages/warranty-registration

SERIAL NUMBER: _____ **Purchase Date:** _____



Delivery Video Guides on Canadian Spa Company channel

Delivery Options

Collection

Buyer collects hot tub using own transport from our warehouses. Please arrange 48 hours prior to collection, Monday - Friday 9 am - 4pm.

Kerbside

Delivery to outside the kerbside of house, customer to be present to sign for the delivery. Customer responsible to position the spa after it is removed from truck.

Back Garden Placement

Delivery from our warehouse and delivered to customers hot tub location. Customer to provide access for position. Check measurements required for each spa.

Back Garden Placement & Demonstration

Delivery from warehouse to customer, moved into hot tub location then fully installed (including all accessories) and commissioned (No Electrics). Followed by a maintenance tutorial. Customer to provide access for position. Check your measurement guidelines for each spa. Optional crane service is available, please contact us for more information.

Cancellation Policy

We require a 48-hour cancellation notice in writing or email prior to your scheduled delivery. If we are notified later, then a reasonable cancellation charge will be applied.



BACK GARDEN DELIVERY FORM



Take your smart phone and tape measure outside with you and attach information directly from your phone! At your convenience upload your information to our site and our experienced delivery team will organise your delivery and installation.



Kerbside Drop Off
Arrange a convenient time to deliver

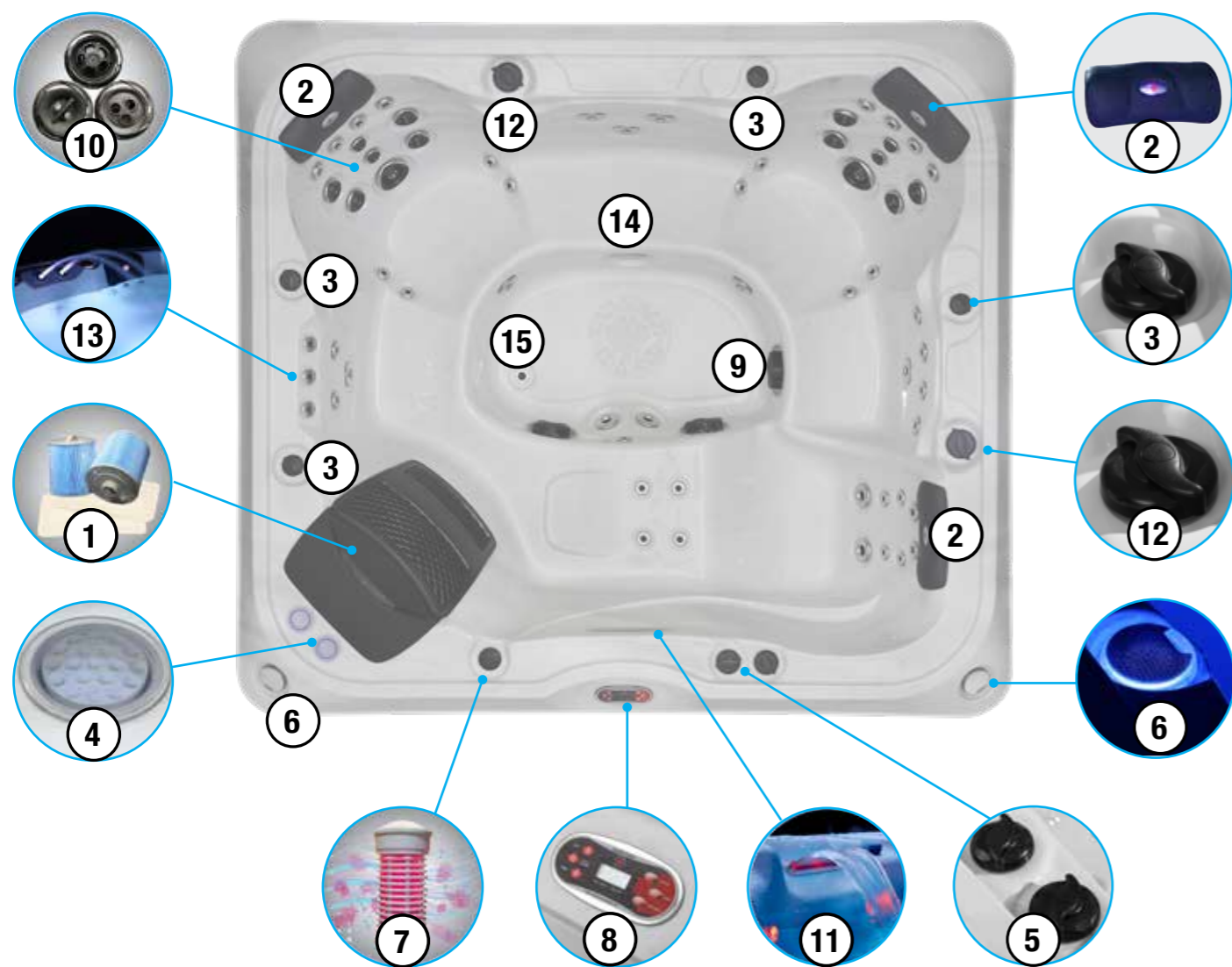

Introduction to the **Alberta** hot tub

1. **FILTER BASKET:** Assembly that holds the filter cartridge (Note: configurations may differ from model to model).
2. **SPA PILLOW:** To rest your head and neck (replaceable).
3. **AIR CONTROLLER:** These are located around the top of your spa. Increase or decrease the force of your jets by opening or closing the air control valves.
4. **ILLUMINATED CUP HOLDER:** Placeholder for drinking receptacle.
5. **WATERFALL & FOUNTAIN ON/OFF VALVES:** Located on top rail of spa used to adjust the waterfall/fountain flow.
6. **SPEAKERS:** Audio speaker system for playing music from an MP3 device
7. **AROMATHERAPY:** A small canister that holds scented beads and works in conjunction with the air control system to create an aromatic experience.
8. **TOPSIDE CONSOLE:** Button pad and temperature display panel located on the top of the spa into which various commands, control sequences and options for operating the spa can be input. User can set temperature, filtration cycle and heating mode through the console.
9. **SUCTION FITTING:** Located at the bottom of the spa, used to return water back into the filter and pump system.
10. **JETS (VARIOUS):** Device that ejects air and water, creating water movement in the spa. Adjustable, directional, rotational and interchangeable.
11. **WATERFALL & PERIMETER LIGHTING:** To create a relaxing spa mood.
12. **LARGE DIVERTER:** Diverts the flow of water from one jet zone to another
13. **LED FOUNTAIN JETS**
14. **MAIN SPA LIGHT**
15. **DRAIN OUTLET**

Hot tub equipment side

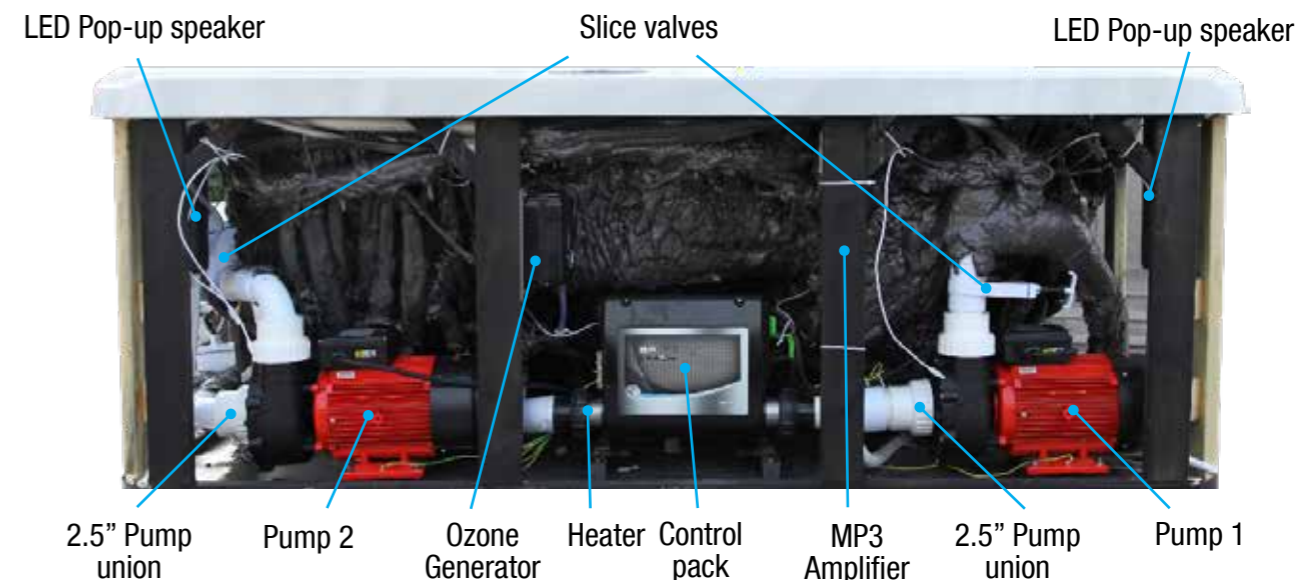

CONTROL PACK: Unit that controls spa operations, containing electronic programming boards, heater and all connections for Pump(s), Light(s), Ozone Generation Unit and Topside Console. Also referred to as 'Spa Pack' or 'Controller'.

HEATER: Electrical resistance device located in the Spa Controller containing the heating element and 2 temperature sensors. The flow through heater heats the spa's water as it flows across the heating element. Heaters are available in several wattages.

MESSAGE PUMP: Electro-mechanical device to move water, consisting of a wet end and a motor.

OZONE GENERATOR: Device that generates ozone to aid in maintaining water quality. Ozone helps eliminate organic material such as body oils, dead skin cells and hair.

DRAIN VALVE: Valve located on the outside of spa cabinet used to drain water from the spa. A garden hose can be attached to the drain valve.

EQUIPMENT BAY: Located under the spa shell covered by access panels that houses the spa controller and equipment.

SLICE VALVE: Two-position (open or closed) sliding valve, used to cut off water flow which allows for service to be performed on the spa equipment without the need to drain the spa. Slice valve operations: up for open, down (toward the valve body) for closed.

Hot tub side view

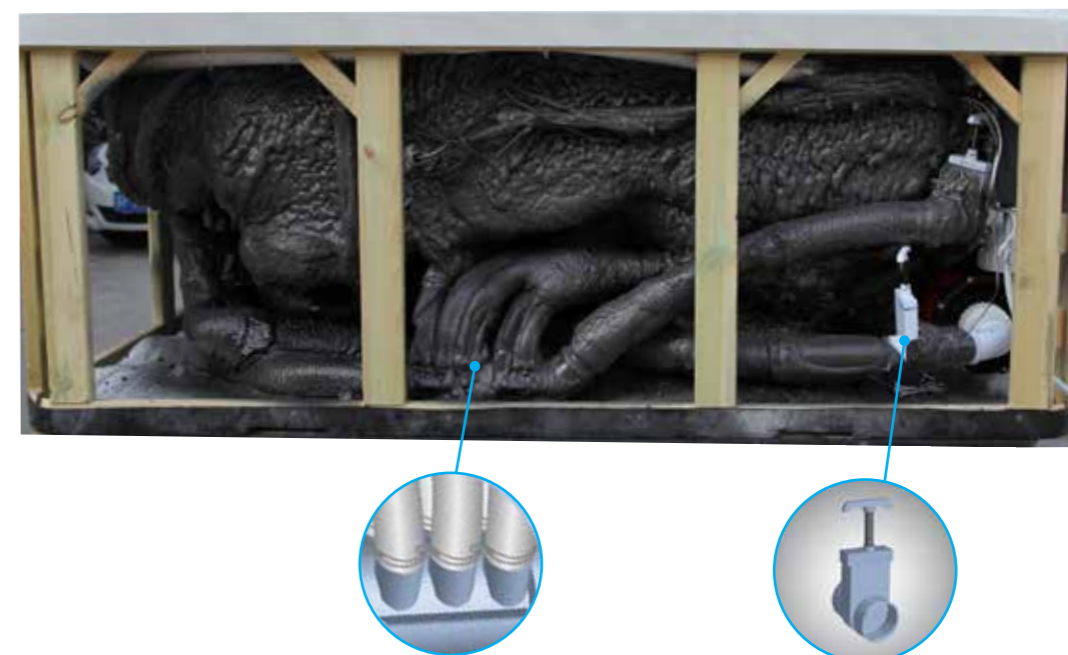

Pre-Delivery Information

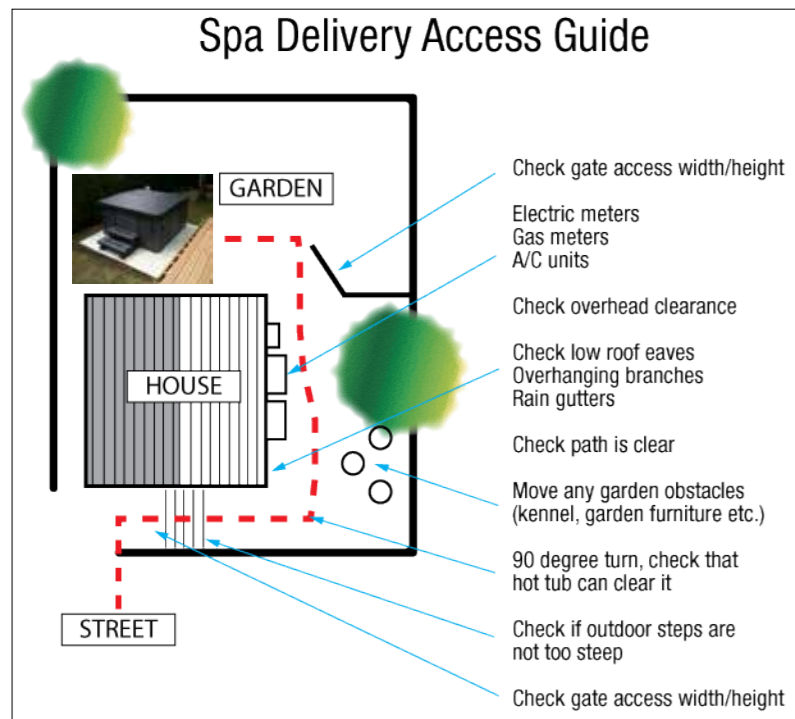

Access: Canadian Spa hot tubs are usually delivered on a flat bed trailer, up to 5 metres long, 2.4 metres wide and 3.5 metres high. Please ensure that there is adequate access for such a vehicle to reach your property. When off loading from our vehicle to the spa site, a minimum of 1100mm width is required, (some models vary) this also needs to be flat and a minimum clear vertical height of 9ft should be considered also.

Electrical supply: If you are having your spa installed, it will be necessary to have a dedicated electrical circuit supply fitted. You will require up to 32 Amp (type C Breaker) supply, dependent on the length from the service point. Your spa must be protected via a RCD and suitable over current protection.

A minimum of 5 metres of cable is required for connection into your spa from the Isolator.

Electrical installation: Arrange for a licensed electrician run the required 230-volt power line to the spa installation site. This power line must be permanently connected (hard-wired) to the mains supply. Do not use extension cords or plug-in type connections. At the site where the spa is to be located leave 5 metres of cable and the appropriate cable gland. All electrical wiring to a spa must be installed by a qualified, licensed electrician, and meet required electrical standards.

Water: The best means of filling your spa is with a garden hosepipe (use cold water not hot water). Please ensure that you have one readily available. If you are aware that your water pressure is poor, we should be advised prior to delivery. The design of our spas allows for easy drainage, again, using the hosepipe which conveniently fits onto the drain valve situated at the base of your spa. Ideally, you should empty the water to a nearby drain. You may wish to purchase a suitable submersible pump to speed up this process.



Before delivery check your spa height and width and add 5cm clearance on each side to ensure access.



Check that the hot tub can clear a 90° turn



Rotary Isolation Switch (pictured). Make sure you have a qualified electrician prepare the electrics. Allow 5 metre slack to connect to Spa.



Ensure you have prepared a level concrete base or a properly fitted existing patio or decking with access to a drain.

NOTE: A 10-15 cm concrete base is ideal preparation for a hot tub.

Decking around your spa: Ensure that you are aware of the above measurements. Always consider during your planning that any decking boards and supporting beams that you install allow access to the sides of your Spa. It is the customers' responsibility to ensure that any decking is clear of these areas prior to any visit by our technicians (Allow 1 metre clearance around your hot tub and if you have decking ensure part of your decking can be removed in order to gain access for future repair or servicing). If you are unsure then please ask before ground construction and the delivery of your spa. Your spa must be sited on a solid, flat, level base which is the same size or larger than the spa. The base can be either a 10-15cm concrete slab or suitably strengthened timber decking or existing patio area assuming it has suitable foundations of hardcore. Whatever base area is chosen, it must be of suitable load bearing capacity. Please ensure your base has suitable drainage.



Ensure part of your decking can be removed in order to gain access for future repair or servicing



Optional CraneService is available

Filling up your Spa

IMPORTANT: Before filling the spa, it is important to read and understand the water chemistry section of this manual. Do not proceed until the water chemistry section is understood and the source water is tested.

Verify that the spa is in the desired final location. Refer to the 'Choose your location' section - once filled, the spa cannot be moved without draining.

Follow these filling instructions to avoid damage to the spa pumps:

1. Leave power to the spa off until spa is completely filled.
2. Never leave an unfilled spa exposed to direct sunlight with out the Spa Cover installed. Resulting damage such as bubbles and wrinkles in the spa shell and fading of the jet faces is not covered by the manufacturer's warranty.
3. Never operate spa pump without water because this could result in permanent pump and/or heater damage which is not covered by the manufacturer's warranty.
4. Remove all warning labels from spa shell.
6. Remove the filter lid, basket and filter cartridge.
7. Inspect all Jets (shipping may cause jets to become loose or detached). Check to see that the black Drain Valve (located to the left or right of the front access panel) is closed.

IMPORTANT: Follow the next steps closely to prevent damage to the Spa Pump.

Filter Type: Glacier Antimicrobial Filter Set SKU: KA-10032



8. Insert garden hose or other clean water source directly into filter housing. Push hose pipe into filter housing until it stops. Fill up to top of the honeycomb grill of the skimmer (see photo above). Secure hose placement and turn on water. Filling the spa through the filter housing prevents an air lock from occurring in the spa pump, which is an air pocket preventing the flow of water through the pump. Permanent damage caused by running the pump with an air lock (or without water) is not covered by the manufacturer's warranty.
9. Check for leaks! Although spas are fully checked at the factory, shipping and delivery might cause a leak.
10. Before power is applied familiarise yourself with the spa control operations.
11. Turn water off and remove hose.
12. Reinstall filter cartridge, basket and filter lid.
13. Add start-up Chemicals after power is turned on.



Draining your Spa/Using the drain valve

1. Start by shutting off the electrical breaker connected to your spa.
2. Locate the drain valve at the side of the spa. This valve has a straightforward locking mechanism that stops the water from flowing out while you attach a garden hose to the cap.

First using the tab of the cap pull and twist until the pipe comes out.

Then with the pipe out turn clockwise until the pipe extends further out.

3. With the valve fully extended, unscrew the cap from the middle of the valve.
4. Screw in the male end of the garden hose to the valve and run the hose to your drain location.
5. Once the water has stopped flowing out of the drain valve, use the wet/dry vacuum to suck out any remaining water from each jet head.
6. Twist valve and push in to CLOSE.

Accessing your spa controls



Installation: Electrical power requirements

Power connections

Single Phase (A) is the normal wiring configuration for most household electrical installations (3 wires: live, neutral and earth). If however you have insufficient Amps you will need to use other connection (see below). **2 Single Phase connection (B)** is used in circumstances where the power supply is limited and where you need more Amps. **3 Phase (C)** is used in certain areas of Europe where 3 Phase power is available and the installation warrants it. **NOTE:** Canadian Spa Company requires that the electrical installation of your hot tub is carried out by a professionally licensed electrician and that all local electrical and building codes are adhered to.

A.) Single Phase connection (Most common):

CONNECTING HOT TUB TO RCD AND CONSUMER PANEL:

- All hot tubs must be wired with the appropriate sized wiring. Failure to do so will cause equipment damage and will not be covered by your warranty
- All hot tubs must be protected with a appropriately sized RCD (Residual Current Device) in the consumer panel. Have your electrician verify using the diagram opposite.

ADDITIONAL ITEMS NEEDED TO HELP COMPLETE ELECTRICAL CONNECTION:

1. RCD Breaker, 2. Electrical cable (check length and width for amperage and distance), 3. Cable gland, 4. Tidy clips

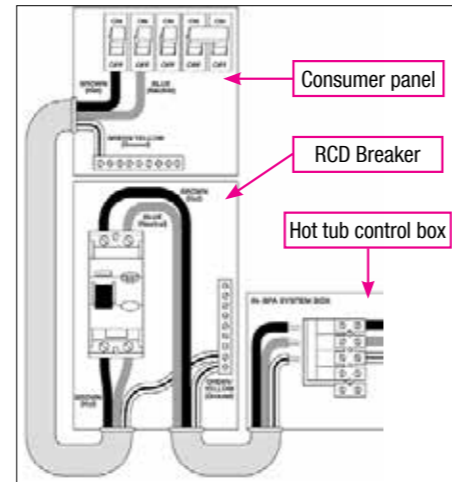

ELECTRICAL REQUIREMENTS FOR WIRED HOT TUBS

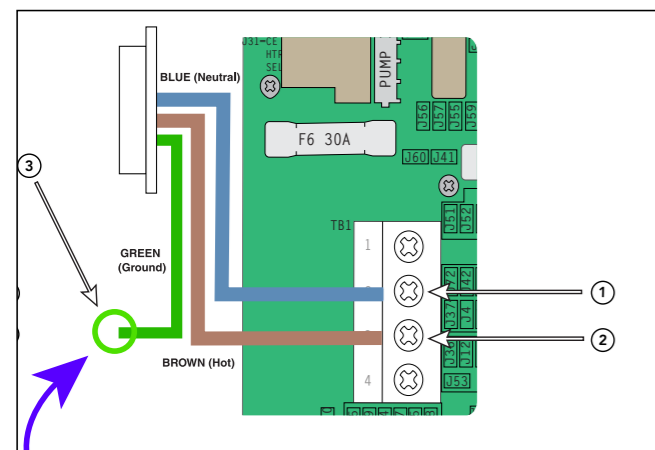

A.) Single Phase connection (most common):
Single Phase (live 1, neutral 1, live 2, neutral 2, ground)]
 230VAC, 50/60Hz, 2p, 16A, (Circuit Breaker rating = 20A max each phase line.)

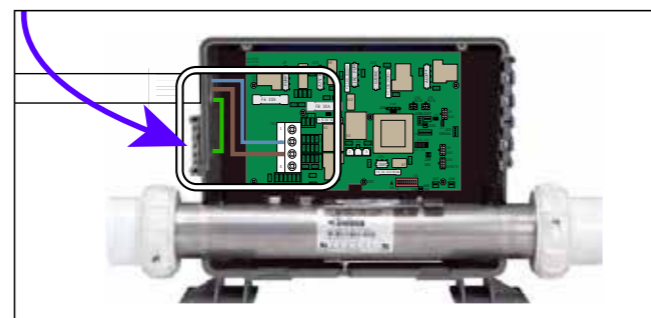

Installation: Electrical power requirements

B.) 2 x 16 Single Phase (live 1, neutral 1, live 2, neutral 2, ground)

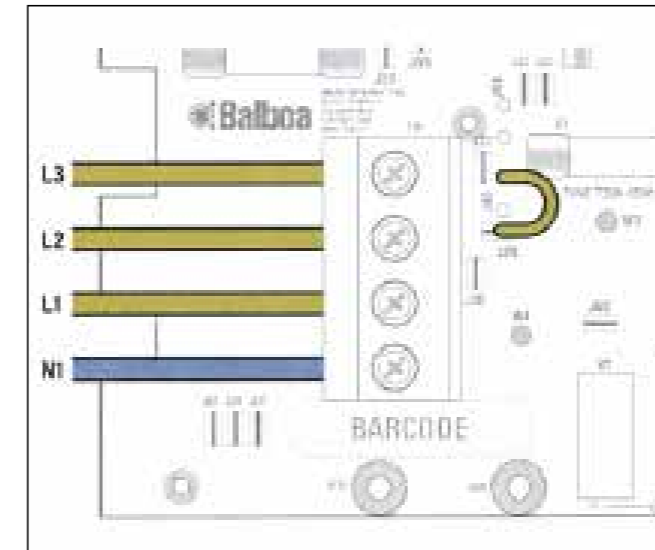

2 x 16 Single Phase
(live 1, neutral 1, live 2, neutral 2, ground)]
 230VAC, 50/60Hz, 2p, 16A,
 (Circuit Breaker rating = 20A max each phase line.)

For 2-Wire connection:

1. Completely remove jumper on J51 and J88.
2. Completely remove jumper on J52 and J62.
3. Make a connection between jumper J60 and J36
4. Make a connection between jumper J41 and J12
5. Make a connection between jumper J46 and J75
6. Make a connection between jumper J20 and J77
7. Make a connection between jumper J38 and J54
8. Put DIP switches A2, A3 and A5 on ON

C.) 3 - Phase connection Where available and needed

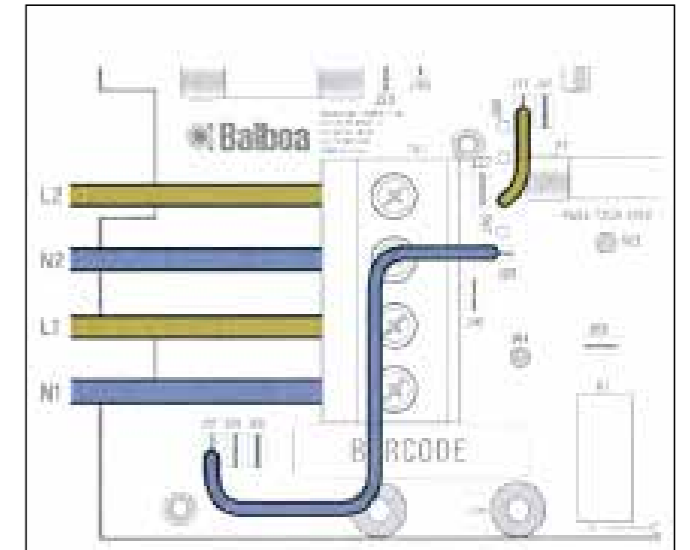

3-Phase 5 wires
(live 1, live 2, live 3, neutral, ground)]
 400VAC, 50/60Hz*, 3p, 16A,
 (Circuit Breaker rating = 20A max each phase line.)

In 3x16A Service:

- Pump 2 is on one service.
- The Heater is on another service.
- Everything else is on the remaining service.

For 3-phase connection:

1. Completely remove jumper on J51 and J88.
2. Completely remove jumper on J52 and J62.
3. Make a connection between jumper J60 and J45
4. Make a connection between jumper J41 and J79
5. Put DIP switches A2 and A3 on ON and DIP switch A5 on OFF.

Airlock warning messages

If you receive any of these error messages on your spa you could have an airlock: **FLO**

How to release an airlock

Air Lock Release Valves

To bleed air from the pump valves (*see photo opposite*):

- Turn one of these valves slightly until you can here a hissing noise
- Once water comes out tighten the valve back up, pump has been bled of the trapped air

If your new spa pump does not prime (flow) on the initial start-up you may be experiencing an "air lock".

This normal occurrence can be easily corrected by loosening the plumbing union on the suction side of the Jet or Pump until water flows into the pump and all air is expelled.

PRESS BUTTONS SLOWLY FOR FIRST RUN WHEN STARTING UP ONCE PR EXITS, SET TEMPERATURE ON SPA



Chemical Guide



Starter Chemical Kit
KA-10122



Deluxe Chemical Kit
KA-10089

FREE Water Test App



Chlorine Granules - Disinfection

To protect your health, ensure that your spa water is disinfected thoroughly on a regular basis. This is particularly important in spas, as the high water temperatures provide an ideal breeding ground for bacteria. To prevent water care problems, there must always be sufficient levels of disinfectant in the water.

The use of Chlorine granules is the traditional method of disinfecting spas. Chlorine granules dissolve quickly, without residues, and do not bleach the surfaces. The granules are pH-neutral, i.e. the pH value of the water does not change with the dosing of the granules.

Check the pH value using the 3 function test strips at least once a week, and, if necessary, adjust it to 7.2 – 7.6. Add 10 g/m³ of Chlorine granules after each bathing session. Let the circulation pump run for 10 minutes, and then check afterwards using 3 function test strips that the ideal value of 1.0 – 1.5 ppm (mg/L). is reached. If necessary, continue to dose. The granules are dosed directly into hot tub water. **KA-10087**



pH Up and pH Down

The pH value is the basis for reliable disinfection. The care products only work perfectly when the levels are correct, meaning the water is not harmful to skin, hair or eyes. The ideal pH value is between 7.2 and 7.6. The pH value is influenced by various factors. For example it increases when fresh water is added. Increasing the water temperature or using the jets changes the pH value. Therefore, check the value at least once a week and, if necessary, increase the levels using pH Up or decrease with pH Down. The granules are dosed directly into the spa water.

pH Up: KA-10051 / pH Down: KA-10050



Scale Control

The overall hardness is a measure of the amount of calcium and magnesium in the water. Scale Control prevents calcium precipitations forming on the walls and in the pipes of your spa. You can find out the overall hardness level of your water by contacting your local water supplier. With a level over 200 ppm (mg/L), heating the water can cause limescale deposits on the walls, creating rough surfaces. To prevent limescale deposits, always use Scale Control after refilling.

KA-10055



Test strips

Canadian Spa 3 Way Test strips to check the levels of Chlorine, PH and Total Alkalinity. Simple and easy to use. Ensure your spa is always safe to use. Pack of 50 strips. Dip a test strip into the water and compare to the colour chart to take readings for: - Chlorine, pH, Total Alkalinity.

TIP: Chlorine and pH should be checked EVERY TIME the spa is used to ensure that the water is safe to use! Go to App, put in your test results and it will tell you what to add and how much. **KA-10052**



Foam Free

If your spa water has a tendency to foam, then we recommend you add Foam Free. The product is added directly to the spa water. If the water continues to foam, even after the product has been added, replace the water.

KA-10054



Alkalinity Booster

Alkalinity booster will prevent erratic changes in the pH level of the spa/hot tub water. Alkalinity Booster will help the bromine or chlorine in the spa/hot tub work more efficiently. Alkalinity Booster raises the total alkalinity of the spa/hot tub water preventing any corrosion that could be caused by low alkalinity.

KA-10056



Spa Clear

Super highly Concentrated Clarifier

- Adds brilliance back to spa water
- Aids filter in removing suspended particles
- Non-toxic. Will not affect pH level.
- Reduces chlorine demand when used regularly
- Restores water clarity

KA-10053

TROUBLESHOOTING GUIDE

PROBLEM	POSSIBLE CAUSE	SOLUTION
CLOUDY WATER	A) organic contaminants build-up B) suspended particles C) pH high D) total alkalinity too high E) poor filtration F) high dissolved solids	A) shock treatment with Granular Chlorine B) add Granular Chlorine, use SPA-BALL C) add pH DOWN until pH level reads 7.2–7.6 D) add pH DOWN, adjust total alkalinity to 80–150 p.p.m. E) dirty filter, replace filter F) empty spa and refill
COLOURED WATER	Debris in water	Use Chlorine Granules.
FOAMING	High concentration of oils and organic contaminants being agitated by jet	Squirt FOAM-FREE on foam. Use the SPA-BALL
SCALE DEPOSITS	High calcium level, high pH, high alkalinity	Drain partially, add Granular Chlorine, correct pH level to 7.2–7.6 and alkalinity to 80–150 p.p.m.
ODOUR	High level of organic contaminants combined chlorine. Chlorine level too high	Shock with Granular Chlorine
EYE/SKIN IRRITATION	A) pH too low B) combined chlorine due to high concentration of organic contaminants	A) add pH up until level is 7.2–7.6 B) shock with Granular Chlorine, add disinfectant
NO CHLORINE/ BROMINE READING	A) high concentration of organic contaminants using up sanitizers B) test trips may be ineffective	A) add Granular Chlorine B) replace at least once a year, keep cool and out of sunlight



Low PH and low-quality chlorine causes the heater element to calcify

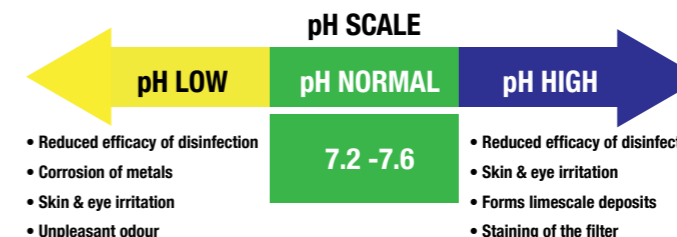

Canadian Spa Company Spa Ball **KA-10003**

Helps to keep your spa clean and achieve crystal clear water!



Chemical Video Guides on Canadian Spa Company channel



Configuration: Your Control Centre

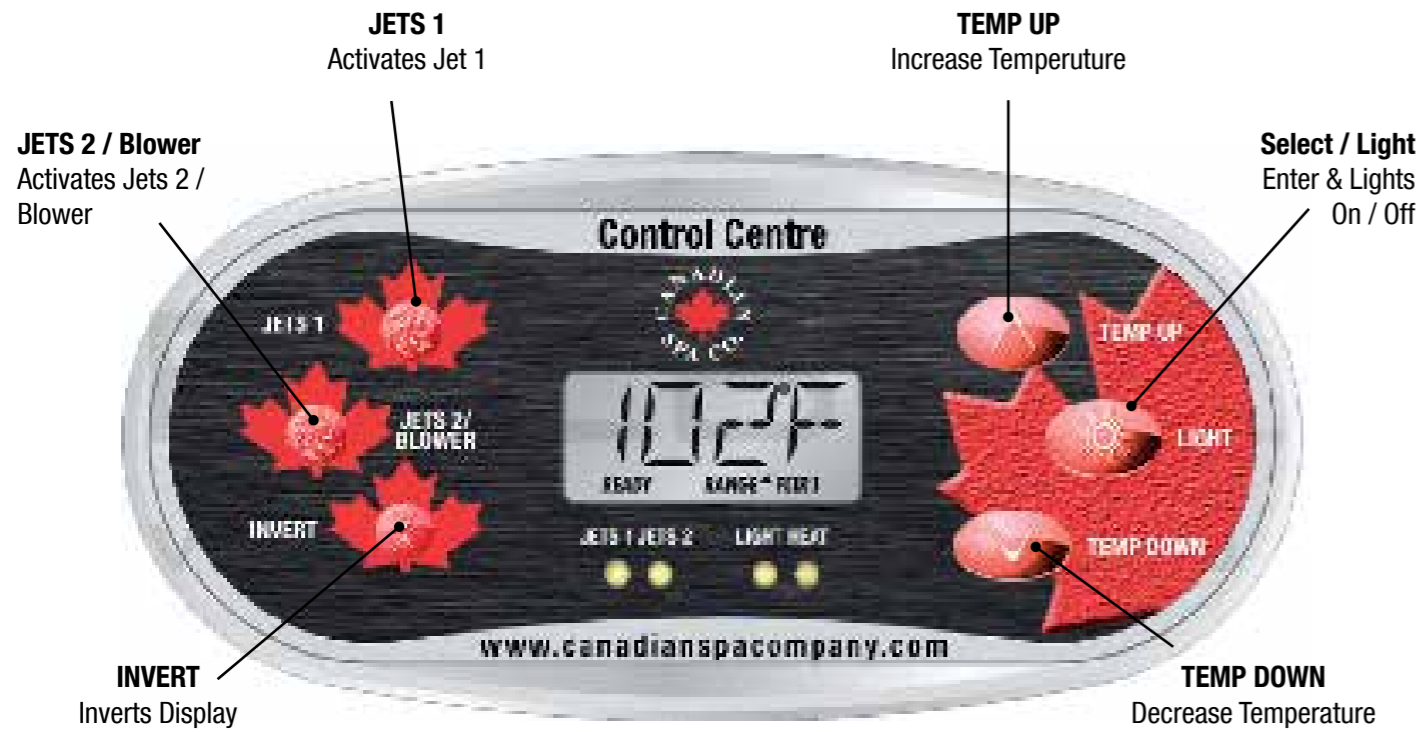

Ready Mode Range Temperature High



Jets 1 Light

Ready Mode Range Temperature High



Jets 1 Light Heat

Rest Mode Range Temperature Low



Jets 1 Light

Ready Mode Range Temperature Low



Jets 1 Jets 2 Light

Button Functions



Pumps

Press the "Jets 1" button once to turn pump 1 on or off, and to shift between low- and high-speeds if equipped. If left running, the pump will turn off after a time-out period. The pump 1 low-speed will time out after 30 minutes. The high-speed will time out after 15 minutes.

The low-speed of pump 1 runs when the other pump is on. If the spa is in Ready Mode, Pump 1 low may also activate for at least 1 minute every 30 minutes to detect the spa temperature (polling) and then to heat to the set temperature if needed. When the low-speed turns on automatically, it cannot be deactivated from the panel, however the high speed may be started.

FLIP (INVERT DISPLAY)

Press the dedicated Flip/Invert button. Allows the user to flip the display with a single button press. the progression will reverse direction.



LIGHTS

Press light button to turn on and off the lights. Each consecutive press will alternate through different lighting modes and colours.

Filtration and Ozone

Pump 1 low and the ozone generator will run during filtration. The system is factory-programmed with two filter cycles that will run 10 minutes after power-up. The filter duration is programmable. At the start of each filter cycle, Pump 2 will run briefly to purge its plumbing to maintain good water quality.



TEMPERATURE UP



TEMPERATURE DOWN

ADJUST TEMPERATURE

When using a panel with Up and Down buttons (Temperature buttons), pressing Up or Down will cause the temperature to flash. Pressing a temperature button again will adjust the set temperature in the direction indicated on the button. When the LCD stops flashing, the spa will heat to the new set temperature when the progression will reverse direction.

Press-and-Hold

If a Temperature button is pressed and held when the temperature is flashing, the temperature will continue to change until the button is released. If only one temperature button is available and the limit of the Temperature Range is reached when the button is being held, the progression will reverse direction.

Freeze Protection

If the temperature sensors within the heater detect a low enough temperature, then the pump(s) automatically activate to provide freeze protection. The pump(s) will run either continuously or periodically depending on conditions.

In colder climates, an optional additional freeze sensor may be added to protect against freeze conditions that may not be sensed by the standard sensors. Auxiliary freeze sensor protection acts similarly except with the temperature thresholds determined by the switch. See your dealer for details.

Clean-up Cycle

When a pump is turned on by a button press, a clean-up cycle begins 30 minutes after the pump is turned off or times out. The pump and the ozone generator will run for 30 minutes or more, depending on the system.

HOW JETS WORK

Air is mixed with the water by using the air controls to create massage(s) of varying degrees. Water flow is adjusted by simply turning the outer face of the full sized jets. Our hot tubs have a combination of pulsating, rotating, and directional adjustable jets.



2" Directional jet
Adjustable and interchangeable jet features a directional nozzle. The jet can be removed by turning it counter-clockwise. To replace the jet push inward and clockwise until it clicks into place.



2" Twin Roto jet
Adjustable and interchangeable jet spins and pulsates. The jet can be removed by turning it counter-clockwise. To replace the jet push inward and clockwise until it clicks into place.



2" Point jet
Standard jet is permanently on and supplies heated water continually. The jet can be removed by turning it counter-clockwise. To replace the jet push inward and clockwise until it clicks into place.



3" Directional jet
Adjustable and interchangeable jet features a directional nozzle. The jet can be removed by turning it counter-clockwise. To replace the jet push inward and clockwise until it clicks into place.

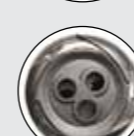

3" Massage jet
Adjustable and interchangeable jet which spins to deliver a soothing massage. The jet can be removed by turning it counter-clockwise. To replace the jet push inward and clockwise until it clicks into place.



5" Massage jet
Adjustable and interchangeable jet features an internal spinner to deliver a low pressure soothing massage. The jet can be removed by turning it counter-clockwise. To replace the jet push inward and clockwise until it clicks into place.



5" (Jumbo) Directional jet
Adjustable and interchangeable jet features a directional nozzle. The jet can be removed by turning it counter-clockwise. To replace the jet push inward and clockwise until it clicks into place.



Air Controller
These are located around the top of your spa. Increase or decrease the force of your jets by opening or closing the air control valves.



Waterfall control
Located on the top side of the spa, this valve adjusts water flow to the waterfall.



Aroma basket cap
Open cap to place aromatherapy beads. Close after use.



PUMPS
5 HP Big Red 2 Speed pumps
Our 5 HP pump is the most powerful spa pump in the market with our oversized intakes.

Diagnostic Messages

MESSAGE	MEANING	ACTION REQUIRED
	No message on display. Power has been cut off to spa	The control panel will be disabled until power is re-established. Based on the spa controller configuration will return to the Factory Default Settings.
--	Temperature unknown	After the Pump has been running for 2 minutes, the current water temperature will be displayed.
HH/OHH	“Overheat” The spa has shut down. One of the sensors has detected that the spa water is 110°F/43.3°C or higher.	DO NOT ENTER THE WATER. Remove Spa Cover and allow water to cool. Once the Heater has cooled, press any button to reset. If spa does not reset, shut off power to the spa and contact the dealer.
OH/OHH	“Overheat” The spa has shut down. One of the sensors has detected that the spa water is 110°F/43.3°C	DO NOT ENTER THE WATER. Remove spa cover and allow water to cool. At 107°F/41°C, the spa should automatically reset. If spa does not reset, shut off power to the spa and call your dealer.
SA/SnA	Spa is shut down. The sensor that is plugged into Sensor “A” jack is not working.	If problem persists, contact the dealer. (May appear temporarily in an overheat condition).
Sb/Snb	Spa is shut down. The sensor that is plugged into Sensor “B” jack is not working.	If problem persists, contact the dealer. (May appear temporarily in an overheat condition).
Sn/SnS	Sensors are out of balance. If alternating with spa temperature, it may be a temporary condition. If flashing by itself, spa is shut down.	If problem persists, contact the dealer. (May appear temporarily in an overheat condition).
HL/HFL	A significant difference between temperature sensors has been detected. This could indicate a flow problem.	If the water level is normal, make sure all pumps have been primed and no Air Lock exists. If problem persists, contact the dealer.
LF	Persistent low flow problems. (Display on the fifth occurrence of HL/HFL message with in 24 hours.). Heater is shut down, but other spa functions continue to operate.	Follow action required for HL/HFL message. Heating capability of the spa will not reset automatically; Press any button to reset.
dr	Possible inadequate water, poor flow or air bubble detected in the heater. Spa is shut down for 15 minutes.	If the water level is normal, make sure all pumps have been primed and no Air Lock exists. This message will reset within 15 minutes. If problem persists, contact the dealer.
dry	Inadequate water detected in heater. (Displays on third occurrence of dr message). Spa is shut down.	Follow action required for dr message. Spa will not reset automatically; Press any button to reset.
IC/ICE	“Ice” Potential freeze condition detected.	Please contact your Dealer
EC/ECN	Spa is in Economy Mode	See Spa Modes section
SL/SLP	Spa is in Economy Mode	See Spa Modes section

Configuration: Your Control Centre

OPERATIONS

PRIMING MODE

This mode will last for 4-5 minutes or you can manually exit the priming mode after the pump(s) have primed.



Regardless of whether the priming mode ends automatically or you manually exit the priming mode, the system will automatically return to normal heating and filtering at the end of the priming mode. During the priming mode, the heater is disabled to allow the priming process to be completed without the possibility of energizing the heater under low-flow or no-flow conditions. Nothing comes on automatically, but the pump(s) can be energized by pushing the “Jet” buttons.

PRIMING PUMPS

As soon as the above display appears on the panel, push the “Jet” button once to start Pump 1 in low-speed and then again to switch to high-speed. Also, push the Pump 2 if you have a 2nd pump, to turn it on. The pumps will now be running in high-speed to facilitate priming. If the pumps have not primed after 2 minutes, and water is not flowing from the jets in the spa, do not allow the pumps to continue to run. Turn off the pumps and repeat the process.

Note: Turning the power off and back on again will initiate a new pump priming session. Sometimes momentarily turning the pump off and on will help it to prime. Do not do this more than 5 times. If the pump(s) will not prime, shut off the power to the spa and call for service.

EXITING PRIMING MODE

You can manually exit Priming Mode by pressing a “Temp” button (Up or Down). Note that if you do not manually exit the priming mode as described above, the priming mode will be automatically terminated after 4-5 minutes. Be sure that the pump(s) have been primed by this time. Once the system has exited Priming Mode, the top-side panel will momentarily display the set temperature but the display will not show the temperature yet, as shown below. This is because the system requires approximately 1 minute of water flowing through the heater to determine the water temperature and display it.



MODE - READY AND REST

READY Mode will circulate water every 1/2 hour, using Pump 1 Low, in order to maintain a constant water temperature, heat as needed, and refresh the temperature display. This is known as “polling.” REST Mode will only allow heating during programmed filter cycles. Since polling does not occur, the temperature display may not show a current temperature until the heater pump has been running for a minute or two.

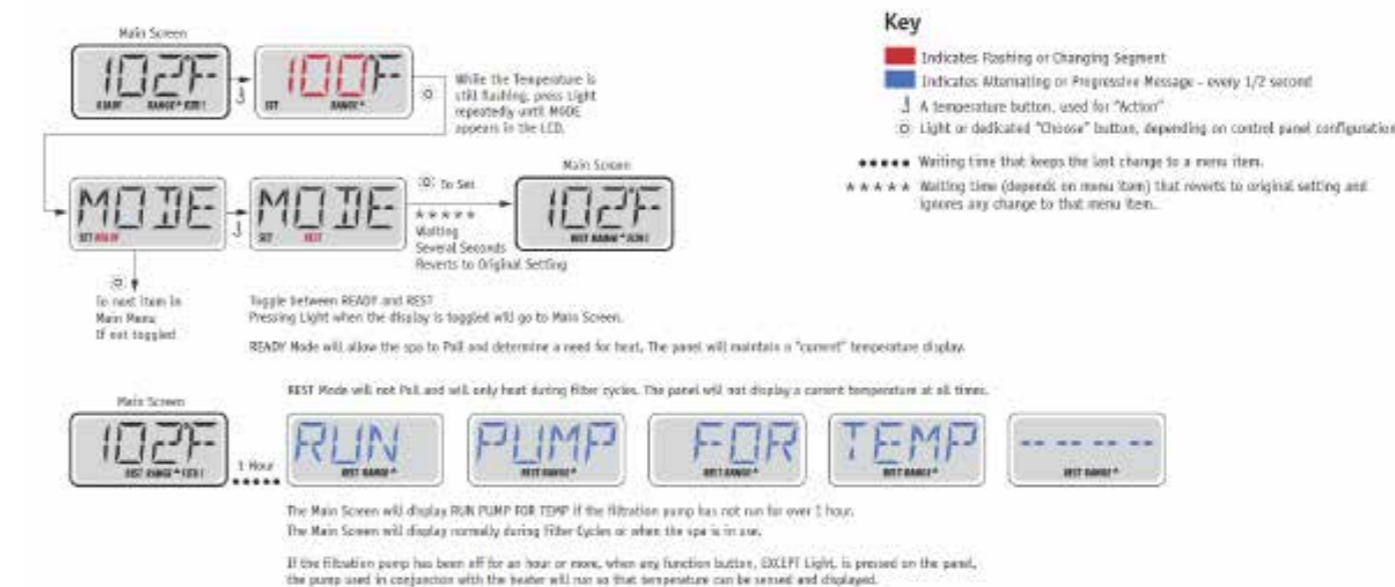

Configuration: Your Control Centre

READY-IN-REST MODE

READY/REST appears in the display if the spa is in Rest Mode and Jet 1 is pressed. It is assumed that the spa is being used and will heat to set temperature. While Pump 1 High can be turned on and off, Pump 1 Low will run until set temperature is reached, or 1 hour has passed. After 1 hour, the System will revert to Rest Mode. This mode can also be reset by entering the Mode Menu and changing the Mode.

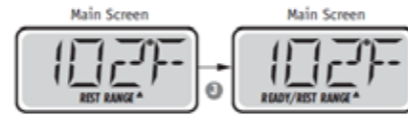

ADJUSTING FILTRATION

Filter cycles are set using a duration. Each setting can be adjusted in 1-hour increments. Filter Cycle 1 and Filter Cycle 2 are set to the same duration.

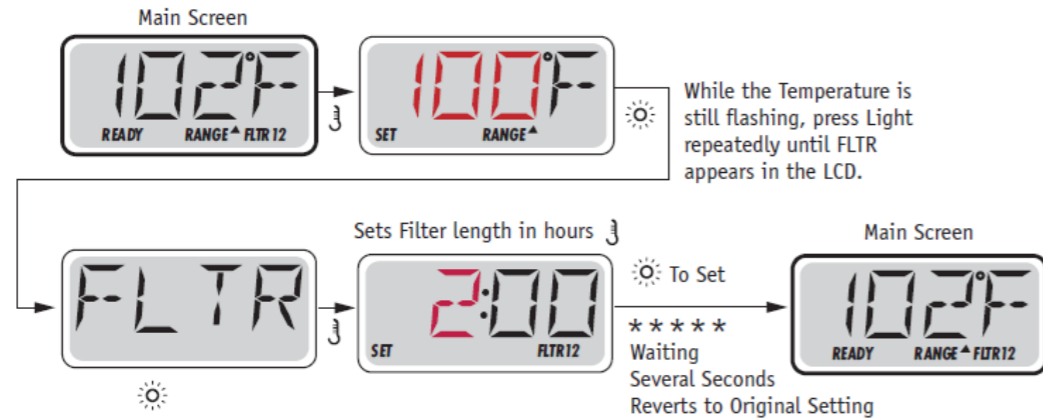

When Filter Cycle 2 is enabled, Filter 12 will appear in the LCD. If Filter is disabled, Filter 1 will appear.



PURGE CYCLES

In order to maintain sanitary conditions, secondary Pumps will purge water from their respective plumbing by running briefly at the beginning of each filter cycle.

FILTRATION AND OZONE

Pump 1 low and the ozone generator will run during filtration. The system is factory-programmed with two filter cycles that will run 10 minutes after power-up. The filter duration is programmable. At the start of each filter cycle, Pump 2 will run briefly to purge its plumbing to maintain good water quality.

CLEAN-UP CYCLE

When a pump is turned on by a button press, a clean-up cycle begins 30 minutes after the pump is turned off or times out. The pump and the ozone generator will run for 30 minutes or more, depending on the system. This cycle is used to clean the water within the spa after it has been used.



WATER IS TOO HOT (OHS)

One of the water temp sensors has detected spa water temp 110°F (43.3°C) and spa functions are disabled. System will auto reset when the spa water temp is below 108°F (42.2°C). Check for extended pump operation or high ambient temp.



TOO COLD - FREEZE PROTECTION

If the temperature sensors within the heater detect a low enough temperature, then the pump(s) activate to provide freeze protection. The pump(s) will run either continuously or periodically depending on conditions.

Preparation and filling the spa

Preparation and Filling

Fill the spa to its correct operating level. Be sure to open all valves and jets in the plumbing system before filling to allow as much air as possible to escape from the plumbing and the control system during the filling process.

After turning the power on at the main power panel, the top-side panel display will go through specific sequences. These sequences are normal and display a variety of information regarding the configuration of the hot tub control.

Mode – Ready and Rest

In order for the spa to heat, a pump needs to circulate water through the heater. The pump that performs this function is known as the “heater pump.” The heater pump is a 2-Speed Pump.

The heater pump is a 2-Speed Pump 1, READY Mode will circulate water every 1/2 hour, using Pump 1 Low, in order to maintain a constant water temperature, heat as needed, and refresh the temperature display. This is known as “polling.”

REST Mode will only allow heating during programmed filter cycles. Since polling does not occur, the temperature display may not show a current temperature until the heater pump has been running for a minute or two.

Circulation Mode

If the spa is configured for 24HR circulation, the heater pump generally runs continuously. Since the heater pump is always running, the spa will maintain set temperature and heat as needed in Ready Mode, without polling.

In Rest Mode, the spa will only heat to set temperature during programmed filter times, even though the water is being filtered constantly when in Circulation Mode.

Flip (Invert Display)



Note: Some panels may have a dedicated FLIP button, which allows the user to flip the display with a single button-press. The FLIP menu/functionality depends on Manufacturer configuration and may not be available. (Menu Style 1)

General Messages



Water Temperature is Unknown

After the pump has been running for 1 minute, the temperature will be displayed.



Safety Trip - Pump Suction Blockage* – M033

The Safety Trip error message indicates that the vacuum switch has closed. This occurs when there has been a suction problem or a possible entrapment situation avoided. (Note: not all spas have this feature.)

Display Messages

Heater-Related Messages



Heater Flow is Reduced (HFL) – M016

There may not be enough water flow through the heater to carry the heat away from the heating element. Heater start up will begin again after about 1 min. See “Flow Related Checks” below.



Heater Flow is Reduced (LF)* – M017

There is not enough water flow through the heater to carry the heat away from the heating element and the heater has been disabled. See “Flow Related Checks” below. After the problem has been resolved, you must press any button to reset and begin heater start up.



Heater may be Dry (dr)* – M028

Possible dry heater, or not enough water in the heater to start it. The spa is shut down for 15 min. Press any button to reset the heater start-up. See “Flow Related Checks” below.



Heater is Dry* – M027

There is not enough water in the heater to start it. The spa is shut down. After the problem has been resolved, you must press any button to reset and restart heater start up. See “Flow Related Checks” below.



Heater is too Hot (OHH)* – M030

One of the water temp sensors has detected 118°F (47.8°C) in the heater and the spa is shut down. You must press any button to reset when water is below 108°F (42.2°C). See “Flow Related Checks” below.



A Reset Message may Appear with other Messages.

Some errors may require power to be removed and restored.

Flow-Related Checks

Check for low water level, suction flow restrictions, closed valves, trapped air, too many closed jets and pump prime. On some systems even when spa is shut down, some equipment may occasionally turn on to continue monitoring temperature or if freeze protection is needed.

* This message can be reset from the topside panel with any button press.

Sensor-Related Messages

Sensor Balance is Poor – M015

The temperature sensors MAY be out of sync by 2°F or 3°F. Call for Service.

Sensor Balance is Poor* – M026

The temperature sensors ARE out of sync. The Sensor Balance is Poor fault has been established for at least 1 hour. Call for Service.

Sensor Failure – Sensor A: M031, Sensor B: M032

A temperature sensor or sensor circuit has failed. Call for Service.

Miscellaneous Messages

No Communications

The control panel is not receiving communication from the System. Call for Service.

Pre-Production Software

The Control System is operating with test software. Call for Service.

°F or °C is replaced by °T

The Control System is in Test Mode. Call for Service. * This message can be reset from the topside panel with any button press.



System-Related Messages



Memory Failure - Checksum Error* – M022

At Power-Up, the system has failed the Program Checksum Test. This indicates a problem with the firmware (operation program) and requires a service call.



Configuration Error – Spa will not Start Up

Contact your dealer or service organisation.



A Pump Appears to be Stuck ON – M034

Water may be overheated. POWER DOWN THE SPA. DO NOT ENTER THE WATER. Contact your dealer or service organization.



A Pump Appears to have been Stuck ON when spa was last powered – M035

POWER DOWN THE SPA. DO NOT ENTER THE WATER. Contact your dealer or service organization.

Reminder Messages

General maintenance helps.

Reminder Messages can be suppressed by using the PREF Menu. Reminder Messages can be chosen individually by the Manufacturer. They may be disabled entirely, or there may be a limited number of reminders on a specific model. The frequency of each reminder (i.e. 7 days) can be specified by the Manufacturer. Press Temperature Up button to reset a displayed reminder message.

Appears on a regular schedule, e.g. every 7 days.

Check pH with a test kit and adjust pH with the appropriate chemicals.

Appears on a regular schedule, e.g. every 7 days.

Check sanitizer level and other water chemistry with a test kit and adjust with the appropriate chemicals.

Appears on a regular schedule, e.g. every 30 days.

Clean the filter media as instructed by the manufacturer.

Appears on a regular schedule, e.g. every 30 days.
The Residual Current Device (RCD) is an important safety device and must be tested on a regular basis to verify its reliability.

Every user should be trained to safely test the RCD associated with the hot tub installation. An RCD will have a TEST and RESET button on it that allows a user to verify proper function.

Warning:

If freezing conditions exist, an RCD should be reset immediately or spa damage could result. The end user should always be trained to test and reset the RCD on a regular basis.

Appears on a regular schedule, e.g. every 90 days.

Change the water in the spa on regular basis to maintain proper chemical balance and sanitary conditions.

Appears on a regular schedule, e.g. every 180 days.

Vinyl covers should be cleaned and conditioned for maximum life.

Appears on a regular schedule, e.g. every 180 days.

Wood skirting and furniture should be cleaned and conditioned per the manufacturers instructions for maximum life.

Appears on a regular schedule, e.g. every 365 days.

Filters should be replaced occasionally to maintain proper spa function and sanitary conditions.

As needed.

Install new mineral cartridge.

Reminders

CHEK PH Check your PH levels (every 7 days)

CHEK CHEM Check your Chemical levels (every 7 days)

CLN FLTR Clean the Filters/replace Filters (every 30 days)

To reset the Reminders press TEMP-UP button until all messages have been removed and Spa Temp is displayed.



How your spa functions

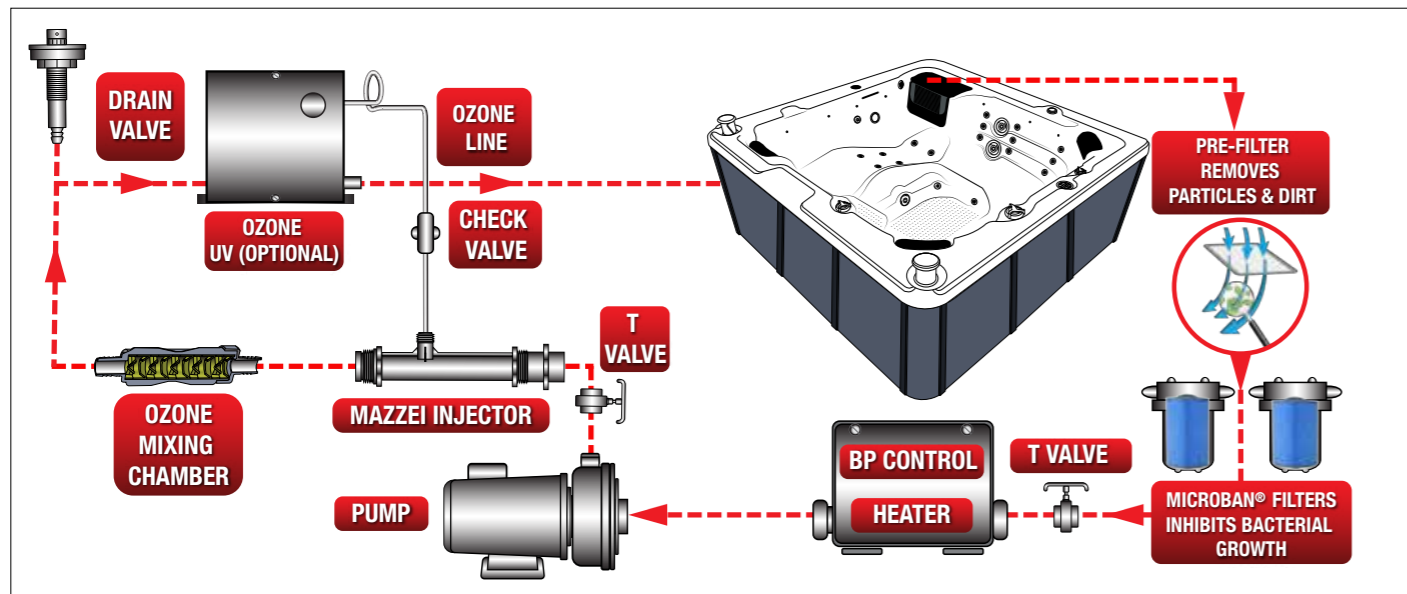

ATTACHING YOUR SPA COVER

The Spa Cover is an important accessory to help preserve the spa's temperature. The Spa Cover also serves as a safety device, preventing unauthorised users from entering the spa. Proper installation of the Spa Cover is an important addition in the spa installation.

- 1) Remove Spa Cover from packaging.
- 2) Place Spa Cover on spa in order to allow easy access to the topside console when opening the cover.
- 3) Line up attaching straps and secure with mounting hardware and use locking mechanism to lock Spa Cover in place.

IMPORTANT:

Always lock Spa Cover in place when not using the spa. Do not walk or sit on Spa Cover. Remove snow build-up to avoid breaking the foam inner core. Do not drag Spa Cover on rough surfaces.

TOP MOUNT™ HOT TUB COVER LIFTER

Fully compatible with ALL our Canadian Spa hot tubs and spas and most other brands; this Cover Lifter is the ideal choice to complement your Hot Tub, making cover removal and replacement a quick, one-handed operation and reducing wear and tear.

- Low-profile design
- Virtually zero clearance required behind spa – great for tight spaces (particularly if your spa is located in a gazebo)
- Mounts directly to the spa
- Fits up to 2.4m Spas
- Made of Aluminium **KA-10027**

BOTTOM MOUNT™ HOT TUB COVER LIFTER.

Fully compatible with Canadian Spas; this Cover Lifter is the ideal choice to complement your hot tub or spa, making cover removal and replacement a quick, one-handed operation while reducing wear and tear on your hot tub cover.

- Mounts directly to the spa
- Made of black powder-coated Aluminum
- Requires 31cm - 46 cm rear clearance **KA-10026**



LED LIGHTING

Change the colour of your spa with a press of a button, 13 colour options to choose from. Chromotherapy is a great way to relax in your spa using colours to change your mood



Trouble shooting

ISSUE	POSSIBLE CAUSE	SOLUTION
• No power	Breaker or RCD off Loose wire connection	Check that RCD breaker is turned ON Check wire connections
• RCD trips	Mis-wired Component failure	Check wiring per diagram, especially neutral wire Perform elimination test to determine failed component. See elimination test section
• Heater not operating or spa not heating	Improper voltage to heater Set on ECON or SLP mode Temperature set to low Water level too low Blown fuse Component failure	At power up, verify voltage to heater by observing the last numbers displayed on Topside Console: '12' for 110-120 volt spas or '24' for 230-240 volt spas Reset to STD Set temperature above current water temperature Add water until water level is 1 inch (25mm) above Water Line Check 30amp bus fuse on control board Contact dealer
• Pump not operating or turns off after a short time	Air lock Improper voltage to pump Time out Component failure Thermal overload	See Air lock procedure Contact dealer or qualified electrician As a safety precaution, the Spa Controller only allows Pump operation for 15 minutes continuously Contact dealer or qualified electrician During extreme high ambient temperatures the pump motor may reach the motor thermal overload limit. Wait until motor cools and retry. If problem persists contact dealer
• Pump surging • Light will not turn on	Low water level Burned out bulb Light bulb may have fallen out	Add water until water level is 1 inch (25mm) above water line Change bulb Unscrew back housing and reinsert bulb
• Ozone Generation Unit will not operate	Blown fuse Burned out UV bulb Component failure	Check Ozone fuse Replace unit Contact dealer
• No water Flow from Jets	Air lock Adjustable jets turned off Faulty pump or motor Slice valve closed Clogged filter	See air lock procedure Turn jets on Contact dealer Open slice valve Clean or change filter
• Jet popped Out	Jet face not seated Broken jet	Insert jet and turn clockwise until jet snaps into place you will feel the jet seat Contact dealer
• No air flow from jet	Adjustable jets turned off Air control valve not open Broken jet Jet not seated properly	Turn jets on Open air control valve Contact dealer Insert jet and turn clockwise until jet snaps into place as it seats
• Noisy Pump or Motor	Air lock Low water level Clogged filter Damaged or worn motor bearings	See air lock procedure Add water until water level is 1 inch (25mm) above water line Clean or replace filter Contact dealer
• Spa Overheating	High ambient temperature Filtration duration	During extreme high ambient temperatures the spa may over heat due to internal friction with in the plumbing. Reduce set temperature or remove spa cover to cool. Reduce filtration cycle duration to minimum setting
• Spa will not turn off	Spa is trying to heat Spa is on high filter cycle Spa is in standard mode	Check set temperature or heat indicator light on topside console is ON Check filter cycle and reduce to 2 or 4 See spa modes section
• Abnormal water	Excessive evaporation Excessive splashing	Check and adjust spa cover if needed Monitor water level after each use
• Water not clean	Dirty or clogged filter Poor water chemistry Insufficient filtration Cycle duration High solids content	Clean or replace filter See common water problems section Based on usage ,adjust filtration cycle duration See common water problem section

Spa Accessories



Canadian Spa waterproof playing cards **KA-10035**



Spa Vacuum Deluxe Kit for hot tubs and Swim Spas **KA-10002**



Canadian Spa water filled booster seat. **KA-10019**



Hot Tub Submersible 1/2 HP Pump, (7.5m hose) **KA-10141**



Filter Cleaning Brush. **KA-10154**



Leaf Skimmer **.KA-10114**

Hot Tub Parts

Here is a list of parts used in our spas:

2.25" Small Point Jet KK-10039	2.25" Directional Jet KK-10040	2.25" Massage Jet KK-10041	3.5" Directional Jet KK-10050	3.5" Massage Jet KK-10051	5" Directional Jet KK-10052	5" Massage Jet KK-10053	10" waterfall KK-10155
Bread Pillow KK-010145	Audio Control KK-10437	Pop-Up Speaker KK-10043	Amplifier KK-10885	Transformer KK-10005	Ozone KK-10141	Big Red LX 5 hp 2 speed Pump KK-10319	Big Red LX 5 hp 1 speed Pump KK-10319
UV 15W system KK-10141	UV 15W Bulb KK-10141	Balboa BP600 Control 3 Kw heater KK-10285	BP600/ 2100 (M7) Heater 3kW KK-10285	TP 600 Topside no label KK-10281	TP 600 Topside 2 pump label KK-10018	Filter Lid for skimmer KK-10888	SCF filter lid screws (2 per lid) KK-10859
Air Control KK-10184	Waterfall valve KK-10141	Waer Diverter KK-10191	Aroma therapy Cap KK-10209	LED Light KK-10213	Drain Cap KK-10355	Drain Assembly KK-10901	84 x 84"/213 x 213 Brown Cover KK-10285

Customer Service



In the unlikely event that a customer experiences an issue we provide multiple channels to contact us.

A specific ticket number will then be assigned to the customer/issue, which enables us to have all information in one place, from order status, any outstanding customer service issues to previous customer history.

Based on the issue we then either send one of our local technicians or ship the replacement part to the customer. This is followed up with a short email to confirm that the job was completed to their satisfaction.



Maintaining your Spa

It is important to keep your spa working efficiently. We recommend a Health Check twice yearly.

Maintenance Packages:	SPRING Hot tubs/ Swim Spas	SILVER Hot tubs/ Swim Spas	GOLD Hot tubs/ Swim Spas	PLATINUM Hot tubs/ Swim Spas	WINTER Hot tubs/ Swim Spas
• Pipe clean, Spa Shock & Anti Scale flush		•	•	•	•
• Filters removed and cleaned		•	•	•	•
• Electrical consumption test			•	•	
• Plumbing leak check			•	•	
• Inside cabinet hoovered & cleaned			•	•	•
• Spa water emptied, spa cleaned, hosed vacuumed	•	•	•	•	
• Cabinet Panels washed & polished (subject to access)				•	
• Acrylic surface wiped/polished clean		•	•	•	•
• Components left drained					•
• Spa refilled with water	•	•	•	•	
• Plumbing bled of any air locks	•	•	•	•	
• Water chemistry checked	•	•	•	•	
• Cover cleaned & polished				•	

SERVICE PORTAL

The FAQ section provides answers to your hot tub questions.

Submit a ticket in our system and our global team will effectively solve your issue quickly and efficiently 24/7.







**Submit a ticket
Customer Support
on Canadian Spa Company channel**



CUSTOMER SUPPORT

CANADIAN SPA CO.

How to:

LOG A SUPPORT TICKET ONLINE

LIMITED WARRANTY

Canadian Spa Co. Manufacturing extends the following warranties to the original purchasers of its portable spas:

Structural Warranty: Canadian Spa Co. warrants structure of the spa shell against water loss due to structural failure for the period of 10 years from the date of purchase by the original owner. If in Canadian Spa Co. opinion, structure proves to be defective Canadian Spa Co. will repair or, at its option, replace the defective structure without charge to the customer

Surface Warranty: Canadian Spa Co. warrants the acrylic finish against defects in material and workmanship and specifically against blistering, cracking or delamination for the period of two (2) years from the original purchase date to the original purchaser. If, in Canadian Spa Co. opinion, the surface proves to be defective during this period, Canadian Spa Co. will repair or, at its option, replace the defective spa shell without charge to the customer.

Plumbing Warranty: Canadian Spa Co. warrants the plumbing of the spa will remain free from leaks for the period of two (2) years from the date of purchase to the original purchaser.

Equipment Warranty: Canadian Spa Co. warrants the equipment pack (pump, heater, and control system) against malfunction and defects in the materials and workmanship for two (2) years from the date of purchase to the original purchaser.

Skirting Warranty: Canadian Spa Co. warrants the wood skirting surrounding the spa to be free from defects in materials and workmanship at the time of purchase. Because wood is a natural product and subject to weathering, any fading, crazing, cracking or warping of the wood finish is not covered.

Extent of Warranty: This Limited Warranty applies to portable spas manufactured after January 1st 2020 and sold by authorised Canadian Spa Co. dealers to residential retail customers. This Limited Warranty is given only to the first retail purchaser and terminates upon transfer of ownership. No warranty is provided on light bulbs, light lens covers, filters or any dealer installed accessories. Cost of installation, removal and/or shipping of the spa is not covered by this Limited Warranty. In the event Canadian Spa Co. deems necessary the removal of the spa to a place of repair or that the spa must be replaced, any and all costs of the spa removal and replacement; landscaping, decking, fencing and/or structure removal, alteration and/or replacement; or other costs of providing access to the spa will be for the purchaser. This Warranty applies only to spas in single family, residential installations. This Limited Warranty becomes void if the spa is placed in commercial application.

Guarantee of the insulating cover: Canadian Spa Co. guarantees that the cover the purchase is free from defects in materials and workmanship. Where the cover is exposed to strong external influences such as extreme weather conditions, regular maintenance or protection is essential. Canadian Spa Co. warrants the cover for the period of two (2) years. Defects caused by misuse or insufficient care are not covered by the warranty.

TERMS, CONDITIONS AND LIMITATIONS

Any defect or damage caused by installation, alteration or repair by anyone who is not an employee of Canadian Spa Co. or authorised service technician is not covered by the Warranty. This Warranty becomes void if the spa has been subjected to misuse, abuse, alteration or attempted alteration, repairs or attempted repairs by anyone other than an authorised Canadian Spa Co. service technician, improper installation, improper water chemistry, improper maintenance, acts of god, or damage caused beyond the control of Canadian Spa Co. Misuse and abuse shall include any operation of the spas other than as directed in the Canadian Spa Co. Manual.

Examples of misuse and abuse include, without limitation:

- Damage of the spa surface caused by leaving the spa uncovered while the spa is empty of water or due to covering the spa with plastic film of any kind.
- Damage to the spa surface caused by contact with cleaners or solvents.
- Damage caused by the operation of the spas at water temperatures outside of the range of 2 – 40 degrees Celsius.
- Damage caused by unapproved sanitizer such as calcium hypochlorite, tri-chlor type chlorine or any sanitising chemical that may remain undissolved on the spa surface.
- Damage caused by failure to provide even sufficient support for the spa.

Warranty Performance:

In the event of a defect covered under the terms of this Limited Warranty, notify your authorised Canadian Spa Co dealer. A Canadian Spa Co. authorised service technician will repair the spa subject to the Terms and Conditions of this Limited Warranty. Use all reasonable means to protect the spa from further damage. Reasonable travel charges may be assessed by Canadian Spa Co. or its authorised service technician if the spa is located outside the nearest authorised service technician's service area. This warranty covers parts ONLY and does not include travel or on-site service charges unless a Service Contract has been purchased from Canadian Spa Co. Ltd.

Disclaimers:

Canadian Spa Co. or any of its authorised service technicians shall not be held liable for injury, inconvenience, loss of use, chemical or water damage, transportation costs, continent liabilities or any other incidental or consequential costs, expenses or damage as result of any deficiency or alleged deficiency of the spa. In no event shall Canadian Spa Co. be liable, for any reason or cause, in excess of the amount paid for the product. No other warranties, expressed or implied, are valid. No agent, dealer, distributor, Service Company or other party is authorised to change, modify or extend the terms of this Limited Warranty in any manner whatsoever.



For Service Support please contact us anytime:
support.canadianspacompany.com



Need assistance? Visit our Service Portal:
support.canadianspacompany.com

SERVICE PORTAL

The FAQ section provides answers to your hot tub questions.

Submit a ticket in our system and our global team will effectively solve your issue quickly and efficiently 24/7.

European Head Office:
Canadian Spa Company
Canada House
Salbrook Road
Salfords, Redhill
Surrey, RH1 5GL
T: +44 1293 824094
www.canadianspacompany.co.uk

France Office:
Canadian Spa Company sarl
29 avenue de Grande Bretagne
66000 Perpignan, France
T: +33 9970 4448004
E: support@canadianspacompany.com
www.canadianspacompany.com

German Office:
Canadian Spa Company GmBh
Hohenstaufenring 43 – 45
50674 Köln, Germany
TEL: + 49 22038064038
www.canadianspacompany.de



Canadian Spa Company meets ISO 9001 Standards. When you purchase a hot tub from Canadian Spa Company the ISO 9001 certification assures world class excellence in manufacturing and customer service.



canadianspacompany.com

