



2024 Collection



Canadian Spa Company
6405 Inducon Drive
West, Sanborn, NY 14132
Toll Free 844-879-7727

Canadian Spa Company
Canada House, Salbrook Road,
Salfords, Surrey, RH1 5GL, UK
Tel: +44 (0)1293 824094

Canadian Spa Company
1283 Cornwall Rd,
Oakville, ON L6J 7T5
CA: 877-347-7727

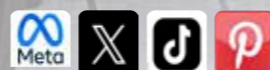

canadianspacompany.com

SKU: KM-10088. 02/10/23

- Hot tubs
- Grills
- Saunas
- Accessories
- Swim spas
- Gazebos



Welcome

We are glad that you have chosen to partner with Canadian Spa Company on your path to wellness, relaxation and family fun time.

We started in the pool and spa industry 45 years ago with a vision to make the benefits of hydrotherapy available to everyone. Over the last few decades, our team has worked diligently to perfect hot tub designs that include all of the features that we know our customers love in a readily available and affordable package.

We keep quality at the top of our mind every step of the way, from the components that we use within our spas, to the hydro efficiency of our insulation and heat reclamation system, to the customer care and after sales service that we provide. This is part of the reason why our products have received numerous awards and accolades throughout the industry.





ACRYLIC SPA FEATURES

HYDROTHERAPY JET CUSTOMISATION Directional • Rotational • Adjustable • Interchangeable

There are two different styles of jets in our spas: directional, rotational.

Each jet provides a different hydrotherapy experience.

Directional Rotational



Adjustable

All jets are individually controlled and adjustable. This includes the ability to increase/decrease the flow of each jet by rotating the faceplate which allows for complete control over the massage.

Our unique design makes it easy to turn the jet face.



Interchangeable

Each jet can be interchanged with any other jet of the same size.

This means ultimate individual customisation for every seat in the spa.



Our diverter valve lets you concentrate the full power of our pump(s) to one or both sides of the spa giving you full control of the flow volume.



Every jet is equipped with air control valves which control the amount of air mixed into the water to further adjust the hydrotherapy massage pressure level and increase blood circulation.

COMPONENTS FROM LEADING MANUFACTURERS

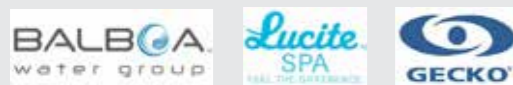

CANADIAN SPA CO. HYDROMASSAGE BATHTUB PUMP SKU:KK-10319

Model WP500-II	SKU:KK-10319
High speed	Qmax 1120 L/min
220-240 V	50 Hz 15A P. 3.7 kW 2900 r/min
Low speed	Qmax 520 L/min
220-240 V	50 Hz 4.5A P. 0.75 kW 1450 r/min
PH1 Class 155(F) IP 55 CAP 50 µF/450V S1	
AMB 40°C Maximum Water Temperature: 50°C	
Thermally Protected	

WARNING: MOTOR MUST BE UNPLUGGED OR DISCONNECTED FROM LOCAL AND REMOTE ELECTRICAL CIRCUITS. COMPONENT COUPLER MUST BE IN PLACE BEFORE OPERATION TO PREVENT ELECTRICAL SHOCK OR INJURY. SEE NEXT PAGES PUMP USER MANUAL.

Our industry leading 15A 5HP 2 speed pump provides more power than any other pump on the market to circulate the spa water and provide a deep hydrotherapy massage.



Sensors detect water flow and pressure to circuit



Built in energy efficient heater provides hot water and is controlled by our digital control pack. Energy saving features include a daily purge system to keep hot tub pristine.

EFFICIENT HOT TUB PLUMBING

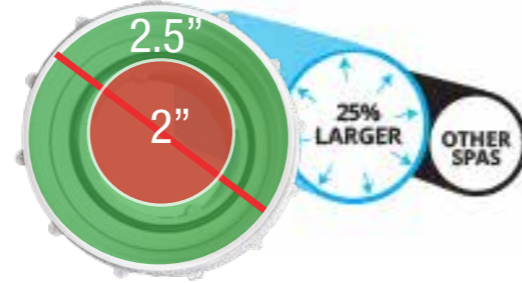

Our oversized 2.5" intake is 25% more efficient than the industry standard of 2" for maximum flow.

No right angle restrictions in our plumbing means better flow-through and less resistance placed on the pump.

There are no twisted or rigid corners with our FlowFlex coil pipes, allowing for maximum water pressure.



For user safety, our spas are fitted with a vacuum brake, ensuring the suction inside the spa is cut off immediately if blocked.

3 Step water purification

CANADIAN SPA COMPANY OXIDATION PROCESS

Ozone Generator + UV-C Germicidal Light + Glacier Filtration = AO₃P

FREE-FLOW CORE

SILVER+STREAM

Natural silver ions stop harmful bacteria

ANTIMICROBIAL TECHNOLOGY
Inhibits the growth of bacteria

Mixing Chamber

OZONE PURIFICATION

UV installed AO₃P system installed in every spa



Our Glacier AO₃P system sterilizes up to 99.9% of bacteria in your hot tub, reducing chemical usage by up to 80% and leaving your water crystal clear!

BACK GARDEN DELIVERY FORM

Upload your information to our site and our experienced team will provide you with a quote to move your spa from the kerb to your garden, remove the packaging and install the accessories.



Cover Comparison

Canadian Spa Cover:	Other Covers:
25% better insulation	Thinner cover
No heat loss through middle seam	Less heat efficient cover
Easy to lift cover from all sides	No side handles
Skirt completely seals spa	Shorter skirt does not seal spa

Warm air rises and the majority of heat is lost through the top of the spa, this cover helps to retain the heat.

Introducing Black Out Insulation

Black Out insulation will also increase the absorption of heat in materials up to 20%. Our innovative insulation is an industry first.



Black Out Foam Curtain Insulation



ABS SEALED BASE

The waterproof base is designed with a layer of the same infrared reflective material found on the cabinet walls. This prevents heat loss and moisture damage.



FILTRATION SYSTEM

Our Digital filtration system guarantees clear water using 75% fewer chemicals

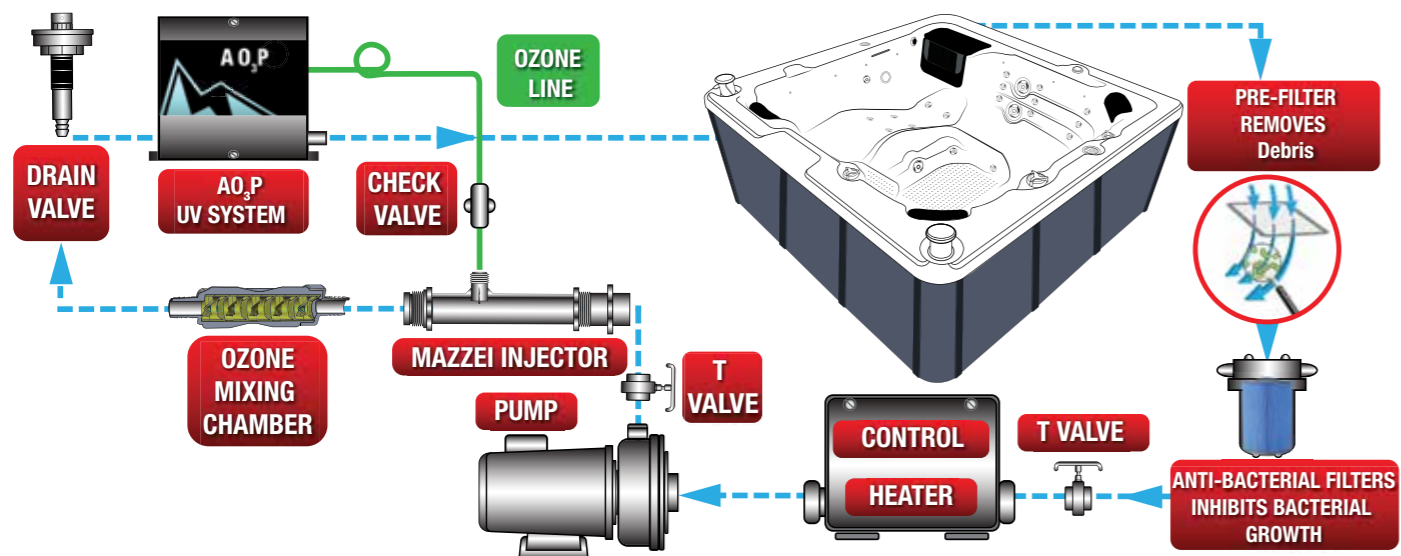

Pre-Filter - Fine mesh screen to prevent your filters becoming clogged.

Silver-Ion - Embedded into the filter, acts as a natural disinfectant and our antimicrobial filter pleats inhibit the growth of bacteria

Mazzei Injector - Produces smaller bubbles and creates the vacuum to pull the ozonated air into the water stream

Ozone Purifier - Generates ozone to aid in the oxidation of the spa water.

Mixing Chamber - Breaks down the ozone Bubbles and helps absorb the ozone into the water.

UV - Neutralises the unabsorbed ozone and neutralises bacteria in the water.

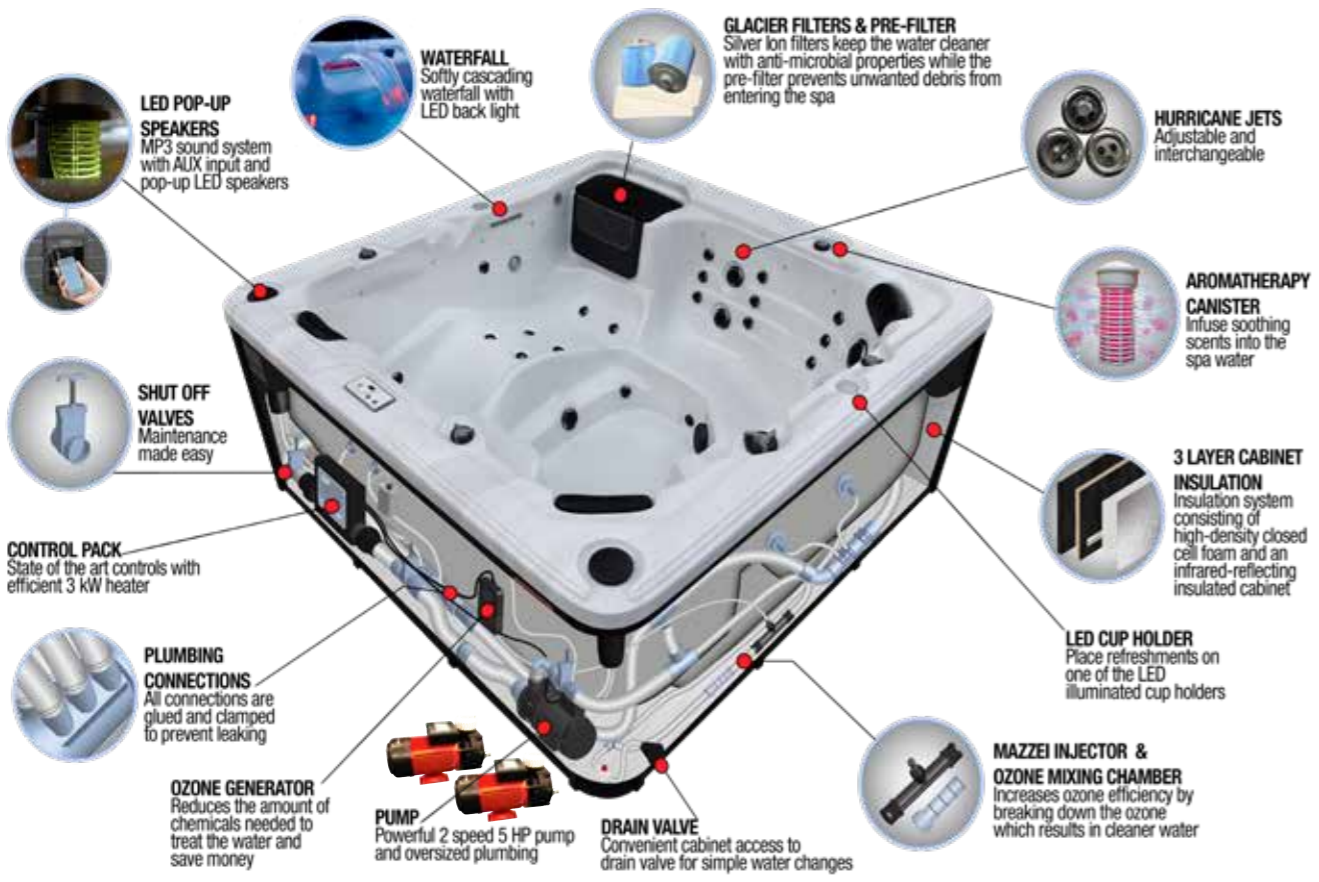

Toronto UV
6 person spa

KH-10047

- L213 x W213 x D82cm
- 5 HP, 2 Speed Pump 15amp
- 5 HP, 1 Speed Pump 15amp
- 44 powerful adjustable jets.
- Blackout Insulation
- A03P Included

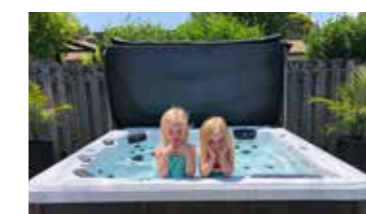

100 sq ft Glacier filter with prefilter



Oversized Footwell
Oversized footwell comfortably accommodates all users feet without contact and includes foot jets.



Built-in Step
Designed to act as an easy entrance point to the spa and stippled for a better grip. Can also be used as a cool-down seat for children.

DIVERSE SEATING ARRANGEMENTS



Captains Chair
Ideal seating for the primary spa user, or taller individuals. Well outfitted with jets and a comfortable LED headrest.



Barrier Free Seating
Allows users to stretch out whilst the jets are configured to massage more areas of the body compared to a specifically moulded seat.



No Float Lounger
An ergonomic lounger that can comfortably accommodate all users. Designed to keep your body mass lower without floating away.

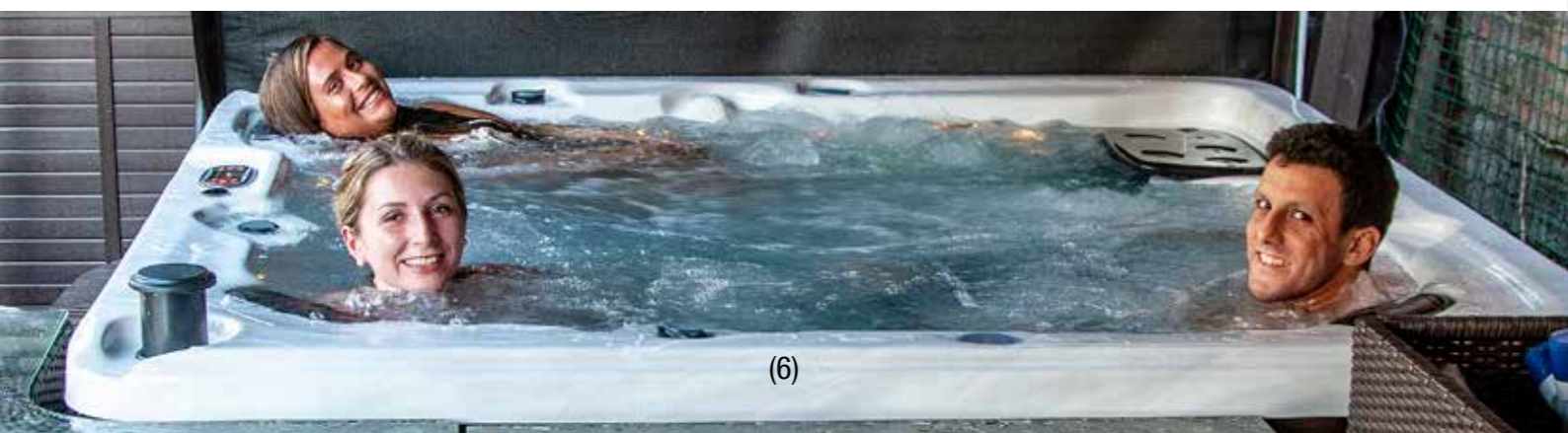

ACRYLIC SPAS

Cambridge 5 person spa
L200 x W200 x D88cm,
1 x 5hp pump 34 Jets, LED lights, Ozone, and Cover
KH-10077



The Canadian Spa Cambridge and London SE Spas are the perfect hot tubs for you to enjoy with your friends and family. Lay back in the comfortable no-float lounger and relax while powerful adjustable hydrotherapy jets ease the knots in your back and soothe the tension in your calves.

A built-in aromatherapy system mixes warm air with aromatherapy beads to release soothing scents while premium LED lighting sets the mood.

Canadian Spa Company tubs include our Glacier water filtration system which includes Ozone water purification and Glacier Silver Ion anti-microbial filtration, ensuring crystal-clear water while limiting the amount of chemicals you need.

London 6 person spa
L213 x W213x D89cm - 2 x 5hp pumps 44 Jets, LED lights, Ozone, UV and Cover
KH-10131



(8)

WINNIPEG UV



Winnipeg 5 person spa
KH-10159 L200 x W200 x D82cm



- 5 HP, 2 Speed Pump 15amp
- 35 powerful adjustable jets.
- Blackout Insulation
- A03P Included

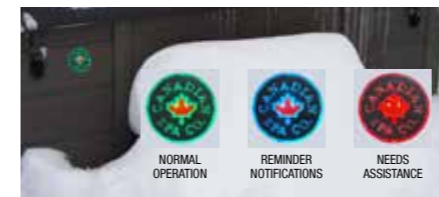

Spa Status LED (Optional)



Our new Spa Status LED provides convenience, right at your finger tips. Check the status of your spa by looking at the colour of the LED light from afar – no more breaking your back trying to remove your cover just to see if your spa is running!

Erie 6 person spa
L213 x W213x D89cm
2 x 5hp pumps 46 Jets, Led lights, Ozone, UV and Cover
KH-10130



(9)

PATIO SPAS



Okanagan spa 10 Jets
L160 x W160 x D73 cm
KH-10078

Canadian Spa Company's Portable Spas are compact, fit up to 4 adults, and fit in almost any location. Packed with features such as: adjustable hydrotherapy jets, multi-colored LED lights, are energy efficient, and Antimicrobial filtration along with a built-in ozone generator and UV system to keep your water crystal clear. All of our Portable Spas are compatible with the average 13 amp outlet; so your family can plug in the spa and go, giving a hassle free experience. Our spas come with valuable customer and technical support for the lifetime of the spa These lightweight portable spas make them the ideal choice for your patio, back garden or holiday home.



Manitoba 14 Jets
L170 x W154 x D73 cm. **KH-10132**

The Canadian Spa Company Manitoba Plug & Play patio spa fits in almost any location. It features 14 adjustable stainless steel hydrotherapy jets and is energy-efficient and easy to install – just plug it into any standard socket and start relaxing right away! The Manitoba uses 50ft² of filtration along with a built-in ozone generator and UV system to keep your water crystal clear without hassle.



PATIO STANDARD FEATURES



13 Amp inline RCD plug with 7 metre / 20ft cable



Multi-coloured LED Perimeter lighting

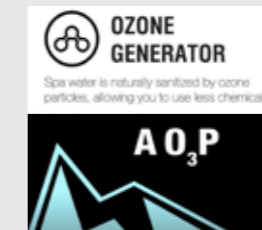

Ozone & A.O.P UV system



Black locking hard top Spa Cover



Waterproof ABS Base





ROUND FURNITURE

Our round furniture is not only designed to fit perfectly around your round spa. It also offers clever and convenient options from comfy seats to handy storage styles that will provide a safe, dry haven for your clothes and towels.

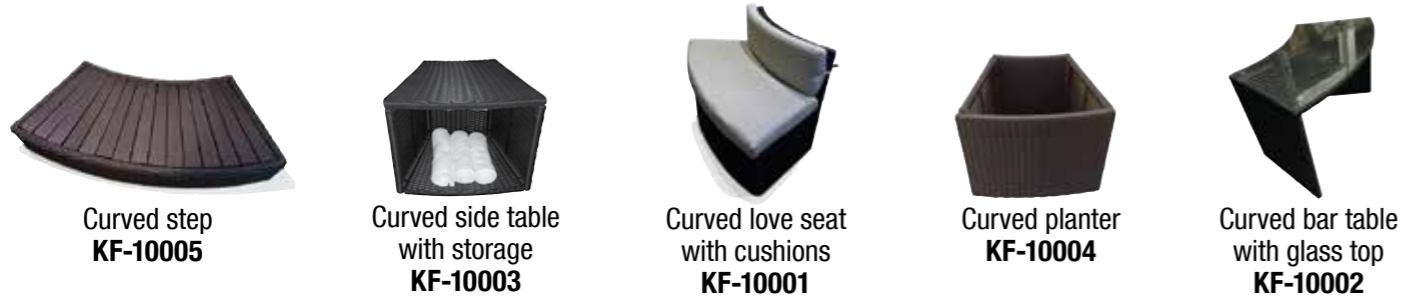

Curved step
KF-10005

Curved side table
with storage
KF-10003

Curved love seat
with cushions
KF-10001

Curved planter
KF-10004

Curved bar table
with glass top
KF-10002

OCTAGONAL FURNITURE

Octagonal furniture fits Muskoka spa 188cm (74")



Sofa
with cushions **KF-10063**



Bar table
with glass top
KF-10064



Side table with storage
KF-10065



Planter
KF-10066



Step
KF-10067

SPA STEPS



- Fits Round Spas



- Fits Square Spas



- Non-slip mat



- Weather resistant



- Easy to assemble

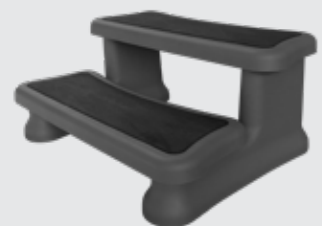

Universal Black Spa Steps
KF-10058
W 90cm x H40cm x D60cm

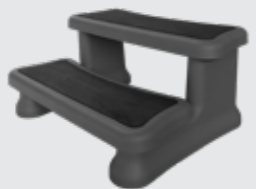

Classic Black Spa Steps
KF-10061
W 72cm x H40cm x D52cm

PATIO SPAS



All Canadian Spa Company Spas provide an unbeatable combination of great value, high-end features and design which are sure to satisfy any household. Our spas come with valuable customer and technical support for the lifetime of the spa, and the knowledge that you're supporting a local company. Our spas use genuine North American made components, including Balboa, Gecko and Lucite Acrylic.

Muskoka Spa 14 Jets
L184 x W184 x D73 cm **KH-10095**



Features

- Digital Controls
- Plugs directly into a standard 13 A household socket- Electrician not required
- Ozone with UV water purification system
- Glacier filtration ensures crystal clear water
- Air venturi valves to vary the water jet pressure
- 50ft² Antimicrobial Glacier filter
Includes 3" to 2" hardtop cover.



The Canadian Spa Company Muskoka Plug & Play spa fits in almost any location. This roomy but compact spa is packed with features of a full-sized spa and easily accommodates 5 adults. It features adjustable stainless steel hydrotherapy jets. This spa is energy-efficient and easy to install – just plug it into an outlet and start relaxing right away!





Yukon UV 2 person Plug & Play spa

L213 x W100 x D74cm **KH-10169**

The Yukon Plug & Play spa is the perfect hot tub for two. Designed for customers who want a big spa experience in a small package.

Features multi-coloured perimeter LED lighting, a digital audio system with backlit pop-up LED speakers, a softly cascading waterfall, and built-in aromatherapy to ensure the ultimate spa experience.

The Yukon is easy to install and plugs directly into any standard outlet. Each of its 16 hurricane hydrotherapy jets can be easily adjusted to ensure just the right pressure.

An ozone generator and UV system along with 35 sq ft of Anti-microbial filtration makes it easy to maintain crystal clear water with far fewer chemicals.



ACRYLIC SPAS

The Montreal & Calgary Plug & Play spas fit in almost any location. These spas are spacious but compact and packed with all the features of full-sized spas and easily accommodate up to 4 adults.

These spas feature adjustable stainless steel hydrotherapy jets. 'Plug & Play' hot tubs are energy-efficient and easy to install – just plug into any outlet and start relaxing right away!

They use 50 sq ft of Anti-microbial filtration and feature a built in ozone generator and UV system to keep your water crystal clear.

The multi-coloured perimeter LED lighting, aromatherapy canister, and a cascading backlit waterfall provide you with the perfect way to truly unwind after a long day.



Calgary 4 person Plug & Play spa

L213 x W153 x D78cm

KH-10037



Montreal UV 3 person Plug & Play spa

L213 x W153 x D78cm

KH-10171



Kelowna 2 lounges + 2 seats

L210 x W152 x D72cm **KH-10041**

The Kelowna has a compact frame and is a perfect addition to back garden locations that have limited access.

Multi-colour LED mood lighting and a cascading waterfall create a soothing and relaxing atmosphere. An aromatherapy canister is built into the spa shell to allow for scented beads to help ease your tension and stress.

Plug & Play hot tubs can be located wherever there is access to a standard household socket. 28 adjustable jets

Our tubs incorporate a water filtration system including ozone water purification, UV system and Anti-microbial filtration, ensuring crystal clear water. Insulation includes high-density closed cell foam that surrounds the shell, and an infrared-lined insulated cabinet that traps the heat inside the spa.



Bluetooth speaker system is standard





Thunder Bay UV 6 person spa
L219 x W219 x D82cm
KH-10030



This 6-person spa features a full-length body-form lounger, 2 deep-seating Captains Chairs, and deep multi-level seating.

The whole family will enjoy the Thunder Bay's 44 hydro-massage jets along with the perfect ambience that's created by a perimeter LED mood lighting system, softly cascading waterfall, built-in aromatherapy canister, and a digital audio system with pop-up LED speakers.

Oversized Footwell

Oversized footwell comfortably accommodates all users feet without contact and includes foot jets.



Captains Chairs

Ideal seating for the primary spa user, or taller individuals. Well outfitted with jets and a comfortable LED headrest.



Victoria UV 6 person spa
L219 x W219 x D82cm
KH-10025

The Victoria hot tub is a truly therapeutic massage spa. It incorporates hydrotherapy, chromotherapy, skin therapy, and aromatherapy packages.

44 hydromassage jets can be adjusted in multiple combinations and degrees to suit every taste, from the gentlest touch to the deepest massage. 100ft² filtration ensures your water is always crystal clear.



STANDARD FEATURES

 ADJUSTABLE JETS	 AUDIO SYSTEM
 LED WATERFALL	 EASY TO USE CONTROLS
 AROMATHERAPY	 OZONE PURIFICATION



Vancouver UV 6 person spa
L227 x W227 x D87cm
KH-10032



The Vancouver hot tub incorporates high-quality insulation suited for the coldest of climates.

Can accommodate larger families with its 6 seat multilevel configuration including two loungers for the ultimate relaxation.

All 65 jets can be easily individually adjusted to ensure everyone receives the pressure they require.



Niagara UV 7 person spa
L228 x W228 x D99cm
KH-10024



The Niagara with a depth of 99cm spa is extra deep and can accommodate larger families with its 7 seat multilevel configuration including one lounger for the ultimate relaxation.

An internal step helps with entry and exit from the spa.

60 hurricane hydrotherapy jets provide a powerful massage



Alberta 7 person spa
L240 x W216 x D93cm **KH-10018**



The Alberta hot tub is packed with high-end features. 57 adjustable and interchangeable jets allow the hot tub full customisation.

This hot tub includes two captain's chairs and a lounger.



Kingston 7 person spa
L240 x W216 x D93cm **KH-10019**



This large spa is equipped with all of the high-end features that guarantee you and your guests have a great experience.

55 hydrotherapy jets are adjustable to customise your spa.



Grand Bend 9 person spa
L300 x W228 x D100cm
KH-10135

The Grand Bend is our most impressive spa to date with three 5HP pumps and 82 adjustable hydrotherapy jets. The Grand Bend provides multi-level seating for 9 people featuring a no-float lounger and two Captain's Chairs to accommodate a number of users with varying needs. The Grand Bend is fully loaded with perimeter LED mood light, Bluetooth audio connectivity. The built-in aromatherapy and cascading waterfalls create the ideal atmosphere for relaxation! The 10-step, 100 sq ft filtration which includes an ozone purification system makes maintaining crystal clear water incredibly easy! All Canadian Spa Company Spas provide an unbeatable combination of great value, high-end features, and design which are sure to satisfy any household. Our spas come with valuable customer and technical support for the lifetime of the spa, and the knowledge that you're supporting a local company. Our spas use genuine North American made components, including Balboa, and Lucite Acrylic.

- Features perimeter multi-coloured LED mood lighting
- Cascading waterfall
- Built-in aromatherapy canister.
- Three powerful 5HP (16.4 amp) pumps
- Oversized 2.5" intakes that guarantee consistent performance
- Equipped with a digital MP3 audio sound system
- Pop-up LED speakers, built in Bluetooth audio streaming
- Insulation includes high-density Black out closed cell foam that surrounds the shell, heat retention blanket
- Equipped with a UV A03P system



2024 Grand Rapids Inflatable Spa

170cm diameter x 74cm **KP-10014**

- Includes LED and Aroma Therapy

- 110 air jets
- Rapid heating system
- Deep Depth for submersion

Our inflatable spa is one of the deepest on the market with a depth of 74cm.

You can completely submerge their shoulders and neck for a truly relaxing massage. Our unique design makes these portable spas easy to assemble and the perfect addition to your patio, back garden, holiday home or cottage.

The air jets help relieve the stress and tension of everyday life. These spas plug directly into any standard household outlet so no electrician is required.

The external Portable Control Unit (PCU) equipped with Anti-microbial filtration housing allows the spa water to be heated to 39°C (103F). Includes an aromatherapy unit.



Inflatable wall with protective vinyl cover



Control Unit

- Easy to use
- 3 Speed
- 7 metre cable
- Aromatherapy
- Anti-microbial Filter



CHROMOTHERAPY GUIDE
CANADIANSPACOMPANY.CA

- RED**
Increases respiration rate, enhances metabolism, raises blood pressure. Activates circulatory and nervous systems.
- ORANGE**
Energizes body, reduces localized fat and eases digestive system discomfort. Used to treat asthma and bronchitis.
- YELLOW**
Has a cleansing effect, purifies blood and increases neuromuscular tone. Stimulates happiness.
- GREEN**
Acts as a relaxant and fights depression. Regulates pituitary gland, calms nervous systems and insomnia.
- STRONG GREEN**
Regenerative stimulation, fights infections. Slows metabolism and produces calming effect.
- BLUE**
Calms breathing and heart rate. Lowers blood pressure, helps insomnia and headaches. Reduces overall gain.
- STRONG BLUE**
Reduces stress and nervous tension, lubricates joints, and fights infections.
- INDIGO**
Helps eye inflammation, cataracts, glaucoma and ocular fatigue.
- PURPLE**
Relaxes muscles, relieves headaches and arthritis pain. Purifies body and assists with detoxification.
- PINK**
Eliminates impurities in the blood stream. Cleanses body, and strengthens veins and arteries.
- WHITE**
Stimulates production of serotonin, regulating sleep and nervous system. Provides energy and helps reduce effects of seasonal affective disorder (SAD).



STANDARD FEATURES



Spas come with a lockable 6 inch inflatable cover which is tapered to allow rain water run-off. Our cover keeps the spa sealed to stop heat loss.



Aromatherapy Dispenser is included as standard in each spa



Anti-microbial Filters keep spa water cleaner by inhibiting bacterial growth



13 Amp inline RCD plug with 7metre/20ft cable



Thermal blanket for quicker heating and better insulation

SWIM SPAS



Powerful swim lane jets
Current River jets deliver a powerful continuous stream of water to aid straight and level swim

St. Lawrence 16ft swim spa
L500 x W228 x D137cm **KS-10005**

The St. Lawrence Swim Spa features a unique Swim Lane system that uses 3 resistance jets and 2 profile aligning jets to ensure that you receive the preferred pressure and support needed for swim exercise.

- 4 hydro-massage seats and 1 full length lounger. 72 massage jets
- Insulation includes high-density closed cell foam that surrounds the shell and an infrared-lined insulated cabinet that traps the heat inside the spa making it more efficient

Includes two-part hard top cover, Anti-microbial filter set, fibreglass tether pole for resistance swimming and aerobic exercise.



Ideal for learning how to swim



Perfect for exercise and practice



Galvanised steel frame Sturdy integral galvanised steel frame



SWIM SPA FEATURES

-
- 1. LOUNGER**
Integral lounger to let you lie back and receive a full body massage
 - 2. FILTER**
A built-in Ozone Purifier works with our 10-step, 200 square foot filtration process to keep your Spa's water crystal clear with little maintenance required.
 - 3. PUMP SUCTIONS**
Ensures continuous flow of water
 - 4. WATERFALL & PERIMETER LIGHTS**
Helps to create a relaxing spa mood to soothe your mind
 - 5. LED CUP HOLDERS**
Illuminated placeholder for a glass of your favourite drink (plastic glasses only please)
 - 6. DEEP SOAK SEATS**
Take a rest from swimming and relax tired muscles in two deep soak seats
 - 7. SWIM JETS AIR CONTROLS**
Adjust the force of the "river jets" with individual air control valves
 - 8. GRAB RAIL**
Use the grab rail to aid stability. Ideal for young people or beginners learning to swim
 - 9. SWIM JETS**
Current generator jets delivers a powerful continuous stream of water to aid straight and level swim
 - 10. DIVERTER VALVES**
Controls the water pressure between the different seats by diverting the water flow around the spa
 - 11. AIR FLOW CONTROL(S)**
Adjust the massage action and jet pressure by changing the air flow
 - 12. BENCH SEAT**
Additional seat with back jets to give a broad back massage
 - 13. CAPTAIN'S CHAIR**
Specially sculpted 'Captain's' Chair for the ultimate back massage
 - 14. POP UP LED SPEAKERS**
Compatible with any MP3 players or smart phone. Each pop up speaker is illuminated to match the LED perimeter lighting
 - 15. VOLUME CONTROL**
Allows you to control your music volumes from the comfort of the spa
 - 16. TOPSIDE CONTROL PANEL**
Easy to use control panel allows for complete control of the pump, blower, temperature or lighting
 - 17. TETHER POINT**
Allows you to tether a swim pole in order to give extra resistance when swimming against the flow of the jets
 - 18. AROMATHERAPY**
Place scented beads into the canister to infuse the jet stream with therapeutic scents

St. Lawrence 13ft swim spa
L390 x W228 x D137cm **KS-10004**

The 13 ft. St. Lawrence Sport Pool is perfect for swimming and aqua-aerobics alike. It has 3-river resistance jets, creating our unique swim lane system. The 3-water pumps and large flat floor make it ideal for a wide range of activities, like jogging against a gentle current and experiencing the benefits of resistance training.

The water flow is fully adjustable, allowing you to customise it for any level of activity. The 13 ft. St. Lawrence also functions as a hot tub, so after a good swim, relax with a soothing massage in one of the four multi-jet Captains' Chairs or a full body 12 massage jet stand up area. The built-in digital audio system with pop up speakers provides music entertainment, perimeter multi-coloured LED lighting and 2-cascading waterfalls enhance relaxation. The waterfalls also act as a visual aid to keep your pace, all in the privacy of your own home.



St. Lawrence 20ft fully featured dual temperature/zone swim spa and hot tub
L594 x W228 x D137cm. **KS-10006**

Enjoy the luxury of the 20 ft St Lawrence Swim Spa with dual zones for both a hot tub and a swim spa experience. Each side can be controlled independently to allow for different temperatures. The unique jet system in the swim spa provides controllable resistance for swimming and aqua-aerobics. After exercising, relax in the hot tub while adjustable hurricane jets target your back, calves and feet.



SPA FURNITURE



SQUARE FURNITURE

Our range of furniture is designed and built to fit around your spa. Whether you want to add comfy seating to transform it into both a spa and seating area, or clever storage to ensure your towels stay nice and dry, we have products you can pick and choose to make it perfect.



Corner steps
KF-10025



Straight planter
KF-10027



Straight side table
KF-10028



Straight love seat
KF-10029



Corner bar & stools
KF-10024



Straight bar & stool
KF-10035

RATTAN STRAIGHT STEPS

Our straight steps are perfect for providing easy access into your hot tub with a range of sizes to suit different spa dimensions:

- Step size Width 85 x D57 x H43 cm - Fit Spa Size 200cm / 79": **KF-10031**
- Step size (Width 100 x D57 x H43 cm - Fit Spa Size 213cm / 84": **KF-10032**
- Step size (Width 115 x D57 x H43 cm - Fit Spa Size 228cm / 90": **KF-10034**
- Step size (Width 130 x D57 x H43 cm - Fit Spa Size 244cm / 96": **KF-10044**



SPA STEPS



- Fits Round Spas
- Fits Square Spas
- Non-slip mat

Classic Black Spa Steps
KF-10061 W 72cm x H40cm x D52cm

Universal Black Spa Steps
KF-10058 W 90cm x H40cm x D60cm

GAZEBOS

Fraser
Free standing Gazebo
KF-10052

H292 x W337 x D337cm
CHOCOLATE
Synthetic wood to ensure durability.
2 louvre sides for privacy and protection.
Includes bar and 4 stools.



GARDEN SANCTUARY

The Fraser Gazebo creates a safe environment for you to enjoy your spa all year round!

Complete your hot tub purchase by turning your home and garden spa into a sanctuary with our Fraser gazebo.



Roof Dome Box
Strengthen the Gazebo by using a reinforced dome box



Metal Straps
Strengthen the Gazebo by using steel strapping through-out the roof and rafters



FRASER GAZEBO STANDARD ROOF FEATURES



UV Roof Panels

These panels are treated with UV protection to withstand the harshest of climates.



CANADIAN GRILL CO. BBQ SMOKER GRILLS

ZPG-7002 PELLET GRILL WITH PID CONTROLS KG-10014



PID CONTROLLER FOR CONSISTENT TEMPERATURES

The PID controller is a grill master's dream come true. It maintains an incredibly steady temperature throughout your cook for precision grilling. Take the guesswork out and create deliciously consistent meals every time.



CONVENIENTLY MONITOR THE COOKING PROCESS

Achieve the ideal doneness every time. Two included temperature probes let you conveniently check internal temperatures on the large LCD control panel without lifting the lid.



HEATS HOTTER, FASTER

Boost the smoke for maximum wood-fired flavor or get the internal temperature back up faster after you open the lid by holding the Feed button.



Enhance your grilling experience, greater flavour, easier to operate Canadian grill wood pellet barbecues are fueled by 100%-natural BBQ wood pellets.

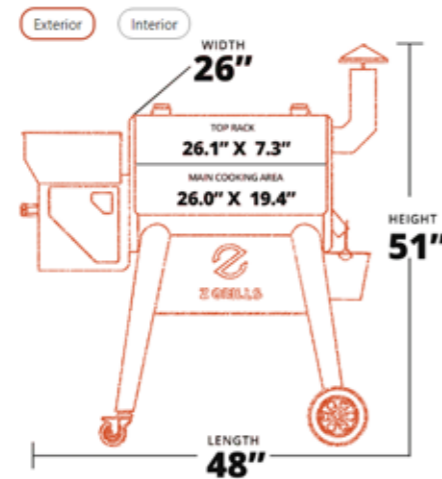

PELLETS

Canadian Grill premium wood pellets are made from 100% natural, food-grade hardwood to ensure that these pure wood pellets give the perfect burn for optimal wood fired flavour.

Canadian Grill premium wood pellets are made in Canada and their production is overseen from the sawmill to the shelf to provide the cleanest, healthiest fuel source available with limitless flavour combinations.

Canada has some of the world's highest quality hardwood trees.

We're pleased to bring you a pellet that is 100% natural with no artificial flavours of any kind. No binding substances, chemicals or glue.



8-IN-1 COOKING



SAUNAS



Chilliwack Sauna
W104 x D97 x H191cm
1485w - 5 Heaters
KY-10007

Banff Sauna
W146 x D117 x H191cm
2005w, 8 Heaters
KY-10009

Aspen Sauna
W137 x D137 x H191cm
1805w - 6 Heaters
KY-10011

Whistler Sauna
W177 x D132 x 191cm
2605w -10 Heaters
KY-10010

HOW SAUNA HEATING WORKS HEATING THE BODY CORE

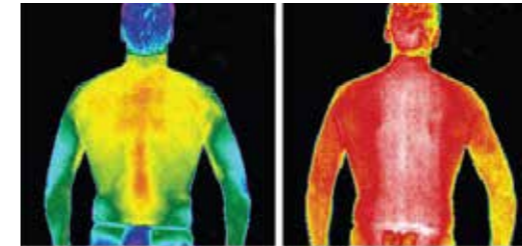

All sauna heating systems work in the same way to heat the core of the body.

STANDARD FEATURES

SOLID FRAME
Solid wall/stud wall, not particle or MDF board, stronger structure, less chance of warping.



CANADIAN SPA - MICA FAR INFRARED

MICA Heaters heat evenly and are more efficient than standard carbon fibre heaters and with low EMF levels and no off gassing. They are very effective at heating your body core and helping your body detox.

EVEN SURROUND HEATING

In your Canadian Spa Far Infrared Sauna only about 20% of the heat goes to heat the air and the other 80% directly heats your body. The result is deeper tissue penetration. Health benefits start at lower heat, starting 32°C. You can set your sauna at a more comfortable temperature.

DIGITAL CONTROLS

Easy to view and change temperature settings with our digital control panel.

TIMER SETTING

Adjust the amount of time you wish to spend in the sauna at your desired temperature.

PRE-HEAT SETTING

Schedule your sauna time everyday by setting up a pre-heat time so that it is always ready.



Fig 1. POWER & HEATING lights illuminated to show sauna in operation



Fig 2. Press SET button and hours and minutes are displayed



Aromatherapy Oil Dispenser

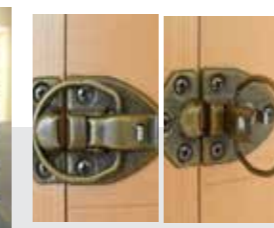

Easy Clip system



Low EMF



Cool Handle



Exterior Lighting



Wooden floor



Speakers



Fresh Air Vent



High output LED Light

FREE-FLOW CORE

Ensures steady flow



QUALITY FILTERS

Rigid and long-lasting 100% polyester Reemay filter fibres

FILTERS

Increase the cleaning power of your spa with an antimicrobial spa filter! Our filters are infused with antimicrobial protection to inhibit the growth of bacteria upon the cartridge and extend the filter's life. Silver ion technology is added into the end caps and fabric of this filter, making it the most advanced filter cartridge available. Break the cycle of bacteria growth when the spa is not in use and the high demand of chemicals once it starts up. Filter should be changed every 4-6 months for best results.

WITHOUT WITH

ANTIMICROBIAL TECHNOLOGY

Inhibits the growth of bacteria, mould, and fungi that can cause contamination of the filter cartridge

SILVER STREAM

Natural silver ions stop harmful bacteria from building up inside your filter and entering your spa water



2 x Glacier Antimicrobial Filters with 2 pre-filter set **KA-10032**

The Canadian Spa Glacier Filters: Antimicrobial filters with a silver ion slow release water purification system available in twinpack + pre-filter screens or single Glacier filter. These filters are compatible with the Canadian Spa Grate filter system.



Pre-Filter screens **KA-10031**



Antimicrobial 1 x Glacier Filter **KA-10082**



Antimicrobial Filter 4 pack fits Grand Rapids Swift Current **KA-10010**



Antimicrobial Swim Spa filter 4 pack **KA-10009**

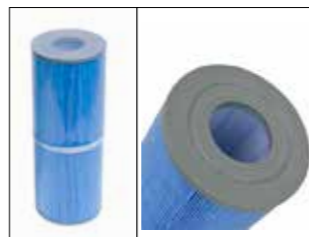

Antimicrobial 50 ft² Slip **KA-10004**



Antimicrobial 50 ft² SAE Threaded **KA-10005**



Filter Cleaning Brush Adapter (Inc.) **KA-10154**



Antimicrobial 1 x Glacier Filter SaniStream **KA-10145**

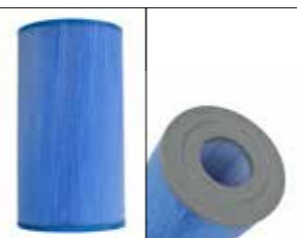

Antimicrobial 35 ft² Slip (for use with Yukon spa) **KA-10007**



Deluxe Chemical Kit: 50 Test strips, 680gm Chlorine, 750gm pH up, 1Kg pH down, 800gm Alkalinity, 500ml Foam Free, 500ml Stain & Scale, 500ml Spa Clear. **KA-10089**



Starter Chemical Kit: 50 Test strips, 500gm Chlorine, 500gm pH up, 500gm pH down, 500ml Foam Free, Manual & App Included. **KA-10122**

CHEMICALS



Chlorine Granules 500g **KA-10123** | Alkalinity Booster 500g **KA-10146** | pH Down 1Kg **KA-10050** | pH Up 750g **KA-10051** | Foam Free 500ml **KA-10054** | Chlorine Tablets 800g **KA-10048** | Bromine Tablets 700g **KA-10103** | Filter Free Cleaner 1Kg **KA-10011**



Fix a leak 8 OZ **KK-11188** | Scale Control 500ml **KA-10055** | Spa Clear 500ml **KA-10053** | Spa Shock 1Kg **KA-10047** | Whirlpool Rinse 500ml **KA-10074** | Spa Flush Sachet 15ml **KA-10164** | Test Strips (50pk) Chlorine, pH & Alkalinity **KA-10052**



Chamomile **KA-10015** | Green tea **KA-10014** | Lavender **KA-10017** | Rose **KA-10013** | Canadian Spa Company Spa Ball & Pad **KA-10003**



SPA CHEMICAL START UP GUIDE

					REPLACE FILTER According to replacement schedule & use
Balance water according to test strip readings	Balance pH with pH Up or pH Down	Balance alkalinity with Alkalinity Booster	FOAMING Add Foam Free as needed		
Add chlorine as per test readings	Circulate spa and retest water	SPA BALL replace Spa Ball	FILTER FREE Soak filter and rinse	Stain and Scale Control	Spa Clear for cloudy water

REPLACEMENT HOT TUB COVERS



We manufacture our covers for our spas and replacement covers with all the features included as standard. All our covers carry the ASTM (American Society for Testing and Materials) Standard to ensure peace of mind. We carry a large stock of the most popular sizes, so we can fulfil quickly.



Cover Comparison

Canadian Spa Cover:
25% better insulation
No heat loss through middle seam
Easy to lift cover from all sides
Skirt completely seals spa

Other Covers:
Thinner cover
Less heat efficient cover
No side handles
Shorter skirt does not seal spa

www.canadianspacompany.com

8 Locking Straps

Eight locking straps secure your cover against strong winds or unwanted access

canadianspacompany.com

Full Steam Seal

Compare our full length steam seal which insulates the entire fold of the cover and reduces heat loss

canadianspacompany.com

Metal Channel

Two parallel C-channels provide support along the entire length of the cover to protect against heavy snow loads or accidental damage

canadianspacompany.com

Drainage

Drainage grommets allow for trapped moisture to escape which keeps your cover lightweight

canadianspacompany.com

5" Skirt

A five inch skirt keeps heat inside with a snug seal that extends all the way around the spa

canadianspacompany.com

Vapour Barrier

Our 6 mil vapour barrier protects against water absorption better than the industry standard 3 mil barrier.

canadianspacompany.com

ROUND COVER SIZES

BROWN	78" x 78" / 198 x 198cm Brown Spa Cover ROUND KC-10021
	80" x 80" / 203 x 203cm Brown Spa Cover ROUND KC-10022
GREY	78" x 78" / 198 x 198cm Grey Spa Cover ROUND KC-10023
	80" x 80" / 203 x 203cm Grey Spa Cover ROUND KC-10024

STANDARD SQUARE COVER SIZES

BROWN	78" x 78" / 198 x 198cm Brown Spa Cover KC-10001	80" x 80" / 203 x 203cm Brown Spa Cover KC-10002	82" x 82" / 208 x 208cm Brown Spa Cover KC-10003	84" x 84" / 213 x 213cm Brown Spa Cover KC-10004
	86" x 86" / 218 x 218cm Brown Spa Cover KC-10005	88" x 88" / 223 x 223cm Brown Spa Cover KC-10006	90" x 90" / 228 x 228cm Brown Spa Cover KC-10007	92" x 92" / 233 x 233cm Brown Spa Cover KC-10008
GREY	78" x 78" / 198 x 198cm Grey Spa Cover KC-10011	80" x 80" / 203 x 203cm Grey Spa Cover KC-10012	82" x 82" / 208 x 208cm Grey Spa Cover KC-10013	84" x 84" / 213 x 213cm Grey Spa Cover KC-10014
	86" x 86" / 218 x 218cm Grey Spa Cover KC-10015	88" x 88" / 223 x 223cm Grey Spa Cover KC-10016	90" x 90" / 228 x 228cm Grey Spa Cover KC-10017	92" x 92" / 233 x 233cm Grey Spa Cover KC-10018

For all other Cover sizes check our website for details



COVER CLIP (SET 4) TWIST KEY
KK-10843



COVER CLIP FLAT KEY
KK-10354



COVER CLIP & TWIST KEY
KK-10819



COVER GUARDS



- Protect your cover from snow
- Prevents cover bleaching
- Elasticated skirt for better fitting
- UV resistant
- Waterproof, no middle seam
- Protects from tree sap

84" / 213cm round
Cover guard
KA-10022

78" / 200cm square
Cover guard
KA-10108

84" / 213cm square
Cover guard
KA-10020

90" / 228cm square
Cover guard
KA-10109

96" / 243cm Square
Cover guard
KA-10021

96" / 243cm x 84" / 213cm
Rectangular cover guard
KA-10110

ROLLING COVERS



Roll covers make it easier than ever to ensure that your swim spa is maintained correctly. Long gone are the days of thick heavy covers which required so much effort and struggle to remove, that you ended up neglecting your much-loved swim spa. The Roll On Roll Off cover is made from carbon fiber making it 25% lighter than other rolling spa covers, resulting in super easy use for anyone. In fact, they are designed to enable one person to roll the cover off in less than a minute. This cover is cleverly designed to have built-in eyelets that allow air to escape as is rolls up so it does not get bigger and bigger.

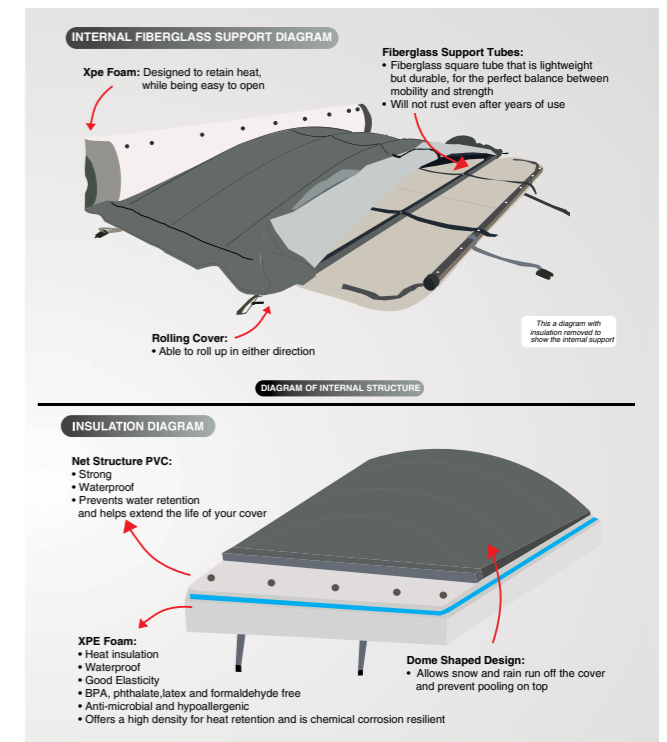
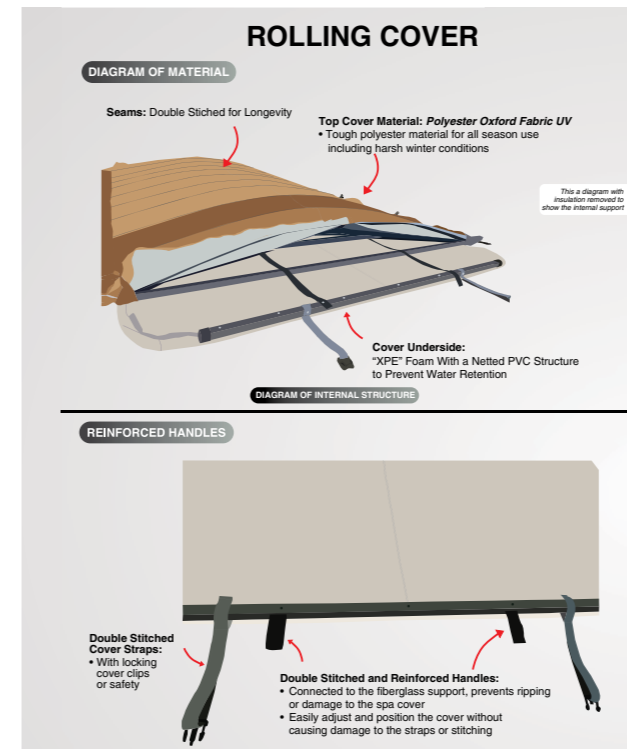

We ensure that our products are of the highest quality, and the Roll Covers are constructed with non-collapsible supports, allowing it to keep its shape in all weather conditions.

The cover is made from durable, UV protected, waterproof and weatherproof material which is securely double stitched on all the seams, to ensure the highest level of protection, even during strong winds. In addition, the Roll On/ Roll Off cover has triple thermal shield technology, which includes 3 distinct insulated layers and 2 insulating air pockets, meaning that heat is locked in, as a complete seal is created. In fact, 97% of the spa's infra-red heat is reflected back into the spa which makes the cover the most insulated part of the swim spa. This lowers the energy consumption and cost of your spa.



COVERS LIFTERS



Bottom mount cover lifter **KA-10026**

- Mounts directly to spa
- Aluminium
- Fits up to 95" wide spas
- Requires 17" clearance
- Max spa depth 36"

Top mount cover lifter **KA-10027**

- Mounts directly to spa
- Aluminium
- Fits up to 95" wide spas
- Requires 12" clearance

LIFTERS PARTS

Top mount cover lifter
Bottom mount cover lifter

**Fixing Kit
KK-11079**



Top mount cover lifter
Bottom mount cover lifter
ABS Bracket KK-10140



Basket cover lifter **KA-10061**

- Ideal for Swim Spas
- Mounts directly to spa
- Aluminium
- Fits up to 94" wide spas
- Requires 12" clearance



Cradle cover lifter **KA-10060**

- Fits underneath spa
- Ideal for Round/Octagonal Covers
- Aluminium
- Fits up to 92" wide spas
- Requires 24" clearance



SPA ACCESSORIES



7 metre RCD UK Plug
KK-10695



7 metre RCD Euro Plug
KK-10733



Spa Floating Dispenser
KA-10113

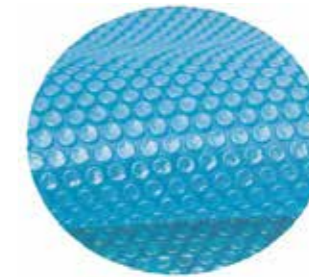

FLOATING THERMAL BLANKET - GRAND RAPIDS 1
30CM ROUND
KA-10155

FLOATING THERMAL BLANKET - Swift Current 1
60CM ROUND
KA-10156



Spa Vacuum Deluxe Kit for hot tubs and Swim Spas
KA-10002



Vinyl Repair Kit Repairs Inflatables, Covers, Booster/Spa Pillows, Liners
KA-10142



Waterproof playing cards
KA-10035



Filter Cleaning Brush Adapter (Inc.)
KA-10154



Canadian Spa water filled booster seat.
KA-10019



Floating Colour LED with Remote
KA-10140



Hot Tub Submersible 1/2 HP Pump, with 10M reinforced drain Hose
KA-10141

SPA PILLOWS



Hurricane U-SHAPE PILLOW
KK-10444



Hurricane Bread Pillow
KK-10145



Black Ice Rectangle Pillow
KK-10735



Spa Pillow (Rectangular)
KA-10138



Spa Pillow (Half Round)
KA-10137



POSITIONING OF YOUR SPA



Local Regulations:

There may be certain restrictions and/or requirements that are particular to your locality. If in doubt, check with your council.

Delivery Passageway:

The spa will arrive as a unit, and cannot be disassembled. Ideally the spa will be placed on a trolley, either on its side or on its base.

The unit will then be rolled into place easily crossing grass, gravel, and small terrain anomalies.

If your access does not meet these conditions, or in the case of other obstacles (steps, fences, walls, steep hills, etc.) contact Canadian Spa Company

THERE ARE 2 DIFFERENT METHODS OF DELIVERY TO CHOOSE FROM:
*SERVICES VARY BY LOCATION

CURBSIDE **BACKYARD**

<https://youtube/6-HNPIrDpT4>

Our couriers will arrange with you for a convenient time to drop off your spa

Kerbside Drop Off



Back Garden Placement



SPA SPECIFICATIONS*

OKANAGAN
10 JETS

Pack Size: 176 x 75 x 160cm
Weight: 150Kg. Amperage: 13A
KH-10078

MANITOBA
14 JETS

Pack Size: 156 x 75 x 188cm
Weight: 170Kg. Amperage: 13A
KH-10132

MUSKOKA
14 JETS

Pack Size: 196 x 75 x 203cm
Weight: 217Kg. Amperage: 13A
KH-10095



YUKON
16 JETS

Pack Size: 225 x 76 x 102 cm
Weight: 190Kg. Amperage: 13A
KH-10021

KELOWNA
20 JETS

Pack Size: 225 x 76 x 153cm
Weight: 240Kg. Amperage: 13A
KH-10041

CALGARY
24 JETS

Pack Size: 225 x 80 x 152cm
Weight: 230Kg. Amperage: 13A
KH-10037

MONTREAL
24 JETS

Pack Size: 225 x 80 x 155cm
Weight: 230Kg. Amperage: 13A
KH-10033

WINNIPEG
35 JETS

Pack Size: 201 x 82 x 211cm
Weight: 320Kg. Amperage: 25A
KH-10159

CAMBRIDGE
34 JETS

Pack Size: 215 x 90 x 215cm
Weight: 260Kg. Amperage: 25A
KH-10077

LONDON SE
44 JETS

Pack Size: 215 x 90 x 233cm
Weight: 340Kg. Amperage: 32A
KH-10131

ERIE SE
46 JETS

Pack Size: 215 x 90 x 233cm
Weight: 340Kg. Amperage: 32A
KH-10130

SPA SPECIFICATIONS

TORONTO UV
44 JETS

Pack Size: 215 x 84 x 225cm
Weight: 380Kg. Amperage: 32A
KH-10047

THUNDER BAY
44 JETS

Pack Size: 221 x 84 x 231cm
Weight: 410Kg. Amperage: 32A
KH-10030

VICTORIA
44 JETS

Pack Size: 221 x 84 x 231cm
Weight: 410Kg. Amperage: 32A
KH-10025

GRAND BEND
94 JETS

Pack Size: 242 x 102 x 302cm
Weight: 620Kg. Amperage: 48A
KH-10135

VANCOUVER
66 JETS

Pack Size: 229 x 89 x 239cm
Weight: 420Kg. Amperage: 32A
KH-10032

NIAGARA
49 JETS

Pack Size: 230 x 101 x 230cm
Weight: 480Kg. Amperage: 32A
KH-10024

KINGSTON
55 JETS

Pack Size: 230 x 96 x 253cm
Weight: 338Kg. Amperage: 32A
KH-10019

ALBERTA
57 JETS

Pack Size: 220 x 98 x 253cm
Weight: 349Kg. Amperage: 32A
KH-10018

BACK GARDEN DELIVERY FORM

* Note: 'Pack Size' includes: packaging, pallet, and cover. Add 40 cm. extra to pack size width to ensure access



SWIM SPA SPECIFICATIONS

ST LAWRENCE 13' SWIM SPA
73 JETS

Pack Size: 392 x 230 x 149 cm
Weight: 1089Kg. Amperage: 50A. KS-10004

ST LAWRENCE 16' SWIM SPA
72 JETS

Pack Size: 502 x 230 x 149 cm
Weight: 1360Kg. Amperage: 50A. KS-10005

ST LAWRENCE 20' SWIM SPA
73 JETS

Pack Size: 596 x 230 x 149 cm
Weight: 1630Kg. Amperage: 1 x 50A + 1 x 32A. KS-10006

