

**Raked Ceiling Mount Accessory****PLB-CE8-02**

ISSUED: MAR. 2013

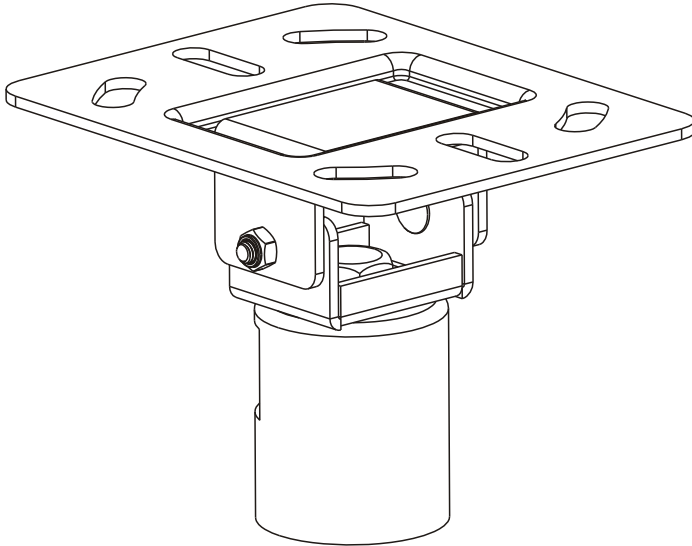

**NOTE:** Read the entire instruction manual before you start installation and assembly.

**⚠ WARNING**

- Do not begin the installation until you have read and understood all the instructions and warnings contained in this installation sheet. If you have any questions regarding any of the instructions or warnings, please contact your local distributor.
- This mounting bracket was designed to be installed and utilised **ONLY** as specified in this manual. Improper installation of this product may cause damage or serious injury.
- This product should only be installed by someone with good mechanical ability who has basic building experience and fully understands this manual.
- This product is intended for indoor use only. Using this product outdoors could lead to product failure and personal injury.

## Component Checklist

**IMPORTANT:** Ensure that you have received all parts according to the component checklist prior to installation. If any parts are missing or faulty, telephone your local distributor for a replacement.

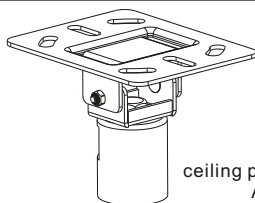

ceiling plate (x1)  
A

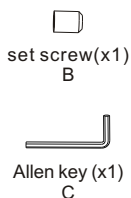

set screw(x1)  
B

Allen key (x1)  
C

## Package W



M8x70 iron expansion bolt (x6)  
W-A

## 1. For Solid Brick and Concrete Mounting (fit flat roof or pitched roof)

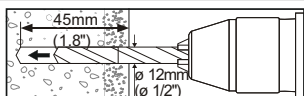

Mark the exact location of mounting holes

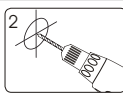

Drill six pilot holes



Screw ceiling plate on the ceiling

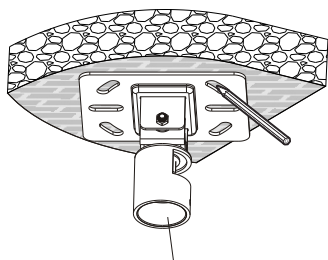

1-1/2" internal diameter

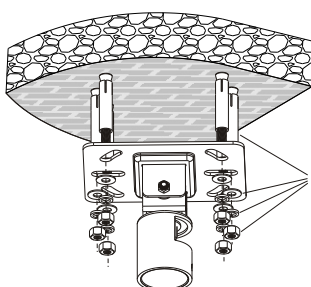

or

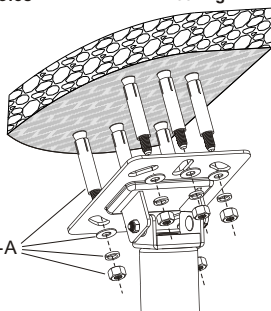

## WARNING

Installers must verify that the supporting surface will safely support the combined weight of the equipment and all attached hardware and components.

## 2. Installing the Pole

Thread and tighten the pole (not included) onto the ceiling plate.

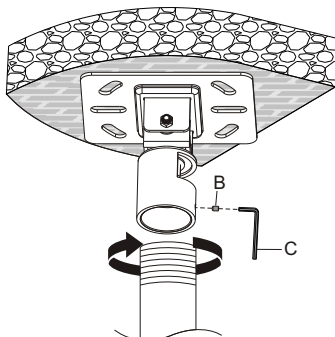

Insert and tighten one set screw to secure it.