

NOTE: ALL MATERIAL COMPLIANT ROHS STANDARD

REVISION INFORMATION			
Rev.	Rev. Date	Modified By	Brief Description

SPECIFICATION MECHANICAL:

- Housing Material: Polycarbonate, UL 94V-2. NO Poison
 UL 94V-0. NO Poison
- Material Contact: Brass / Phosphor Bronze.
- Gold Plating: FU" 2-3U" 3U" 6U" 15U" 30U"
 50U"
- Housing Color: Transparence.
- Material Shell : Brass.
- Operation Temperature: -40°C to 80°C.
- NO: P8-009-1/3-002-E

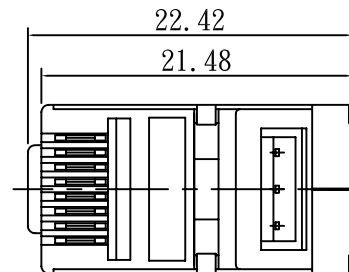
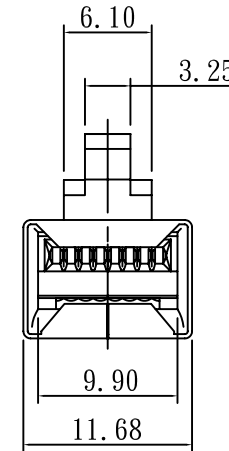
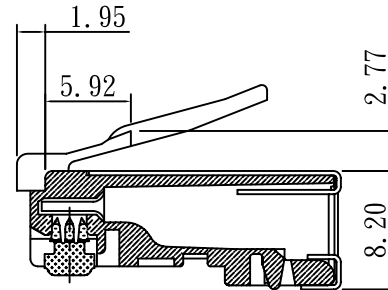
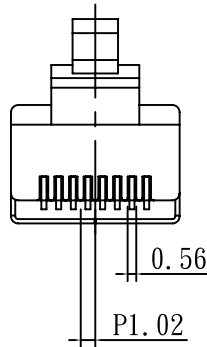
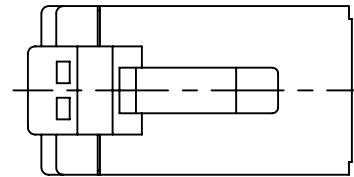
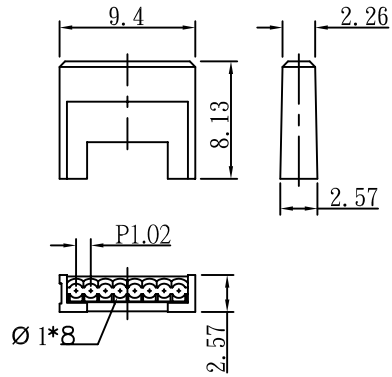

NOTE TOL: ±0.1



DRAWN BY	DATE:	DESCRIPTION: Cat.5E STP Solid 50M
CHECKED BY	SHEET 1 of 1	ITEM NO. 101210
APPROVED BY	SCALE 1:1	REV. 00 UNIT: mm

NO.	PART NAME	SPECIFICATION DESCRIPTION	QTY	UNIT
③				
②				
①				