

NOTE: ALL MATERIAL COMPLIANT ROHS STANDARD

REV	DATE	MODIFICATION	DRAWN

SPECIFICATIONS

- ELECTRICAL:**  
 UL APPLICATIONS: 250 VOLTS AC MAX., AT 2 AMPS.  
 DIELECTRIC WITHSTANDING VOLTAGE : 1000 VOLTS AC.  
 INSULATION RESISTANCE: 500 M Ω .  
 TERMINATION: RESISTANCE 20m Ω MAX AFTER ENVIRONMENTAL TESTING.
- MECHANICAL:**  
 CABLE-TO-PLUG TENSILE STRENGTH : 20POUND MIN.  
 DURABILITY : 450 MATING CYCLES.
- MATERIAL & FINISH:**  
 HOUSING: POLYCARBONATE, UL94V-0 OR UL94V-2.  
 COLOR : TRANSPARENT OR OTHER COLOR ARE AVAILABLE.  
 CONTACT BLADE: COPPER ALLOY.  
 CONDUCTOR : STRANDED & SOLID WIRE , 24AWG, 26 AWG.  
 (It can be used for the wire OD fromØ 0.96~Ø1.02)  
 GOLD PLATING: 3u"-50u",ARE AVAILABLE.

A

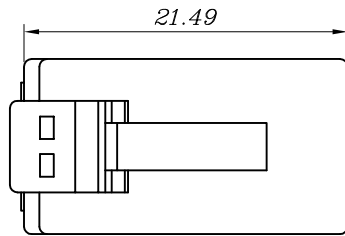

B

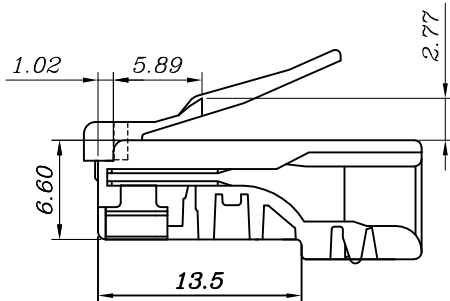
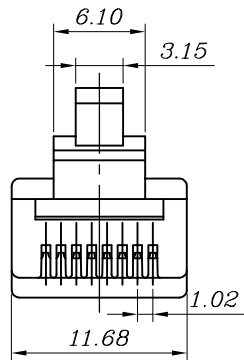

Round

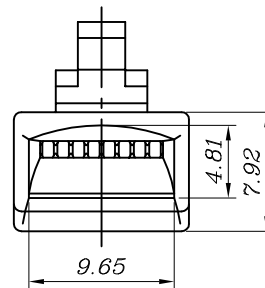

Flat

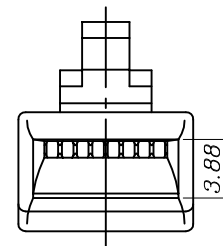

C

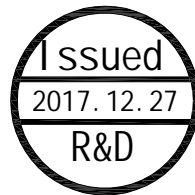
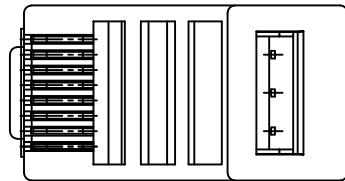

D

BLADE:	E	EB	Y	YB	Z	A	AE	AB	EC	AL	ZL	YBL
Drawing												
Mark								✓				
GOLD PLATING	3Mu"	3u"	6u"	15u"	30u"	50u"	CABLE TYPE	ROUND	FLAT			
Mark			✓				Mark	✓				



<b>DRAWN BY</b>	<b>DATE:</b> 2017/12/27	<b>DESCRIPTION:</b> P88RAB06V2-RJ45 Cat.5E Plug Solid 2Prong 6 Micron	
<b>CHECKED BY</b>	<b>SHEET 1 of 1</b>	<b>ITEM NO.</b>	
<b>APPROVED BY</b>	<b>SCALE 1:1</b>	<b>REV. 00</b>	<b>UNIT: mm</b>

1

2

3

4

5

6

ST-DR-009A

7