

NOTE: ALL MATERIAL COMPLIANT ROHS STANDARD

REV	DATE	MODIFICATION	DRAWN

A

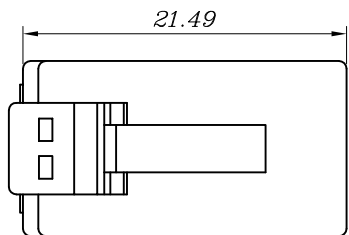

B

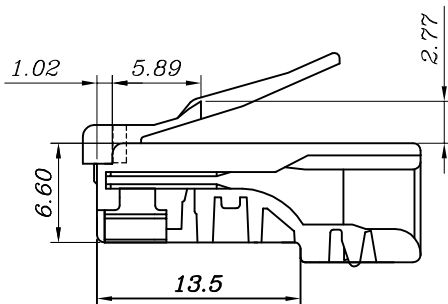
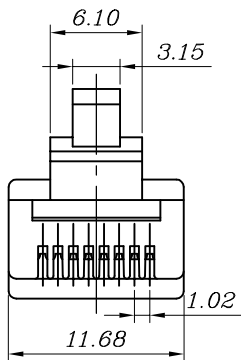

Round

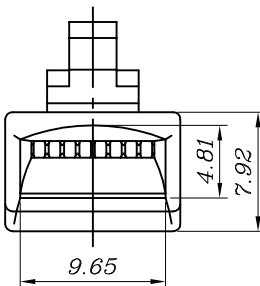

Flat

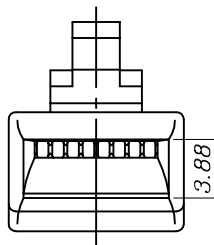

C

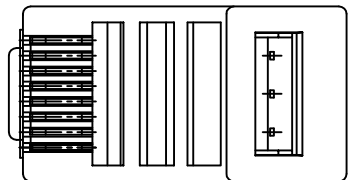

SPECIFICATIONS

- ELECTRICAL:**
 UL APPLICATIONS: 250 VOLTS AC MAX., AT 2 AMPS.
 DIELECTRIC WITHSTANDING VOLTAGE : 1000 VOLTS AC.
 INSULATION RESISTANCE: 500 M Ω .
 TERMINATION: RESISTANCE 20m Ω MAX AFTER ENVIRONMENTAL TESTING.
- MECHANICAL:**
 CABLE-TO-PLUG TENSILE STRENGTH : 20POUND MIN.
 DURABILITY : 1200 MATING CYCLES.
- MATERIAL & FINISH:**
 HOUSING: POLYCARBONATE, UL94V-0 OR UL94V-2.
 COLOR : TRANSPARENT OR OTHER COLOR ARE AVAILABLE.
 CONTACT BLADE: COPPER ALLOY.
 CONDUCTOR : STRANDED & SOLID WIRE , 24AWG, 26 AWG.
 (It can be used for the wire OD fromØ 0.96-Ø1.02)
 GOLD PLATING: 3u"-50u".ARE AVAILABLE.

D

BLADE:	E	EB	Y	YB	Z	A	AE	AB	EC	AL	ZL	YBL
Drawing												
Mark	✓											
GOLD PLATING	3Mu"	3u"	6u"	15u"	30u"	50u"	CABLE TYPE	ROUND	FLAT			
Mark						✓	Mark	✓				



DRAWN BY	DATE: 2017/12/27	DESCRIPTION: P88RE50V2-RJ45 Cat.5E Plug Stranded 2Prong 50 Micron
CHECKED BY	SHEET 1 of 1	ITEM NO.
APPROVED BY	SCALE 1:1	REV. 00

1

2

3

4

5

6

ST-DR-009A

7