

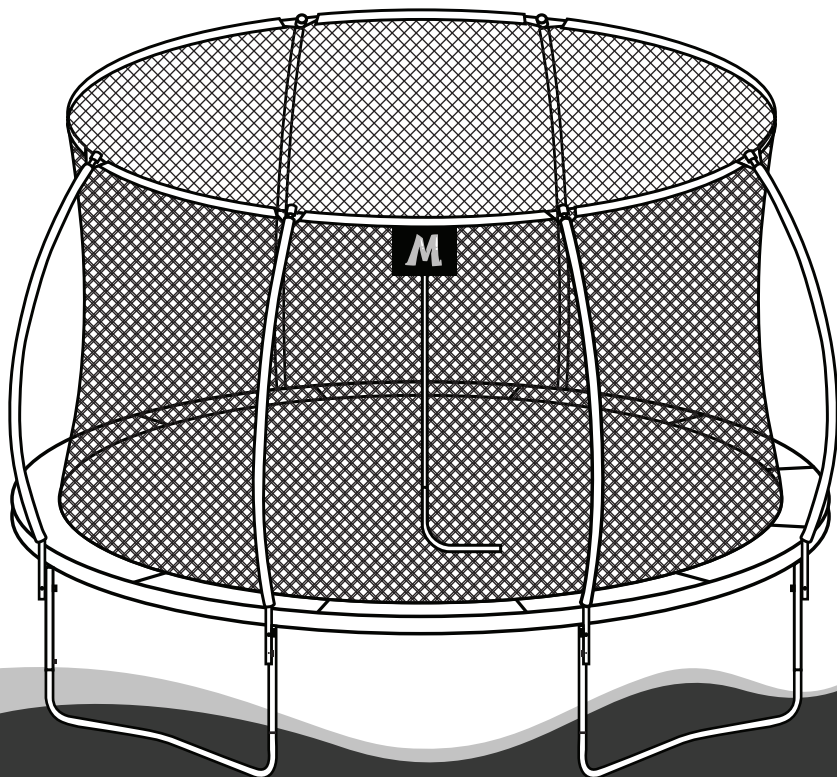

MOXIE™ PUMPKIN-SHAPED  
OUTDOOR TRAMPOLINE SET WITH  
PREMIUM TOP-RING FRAME  
SAFETY ENCLOSURE



# USER MANUAL

FOR MODELS:

|              |              |
|--------------|--------------|
| MXSF03-6-BL  | MXSF03-12-BL |
| MXSF03-6-OR  | MXSF03-14-DG |
| MXSF03-8-GA  | MXSF03-14-GR |
| MXSF03-8-GR  | MXSF03-15-GA |
| MXSF03-10-OR | MXSF03-15-BK |
| MXSF03-10-BK | MXSF03-16-BL |
| MXSF03-12-GA | MXSF03-16-DG |



By Upper Bounce

USA

UK



Call us

1-888-965-3331

020-3150-0484



Email us

support@upperbounce.com

support@upperbounce.co.uk



Check out our website

[www.uppperbounce.com](http://www.uppperbounce.com)

**THANK YOU FOR PURCHASING THE UPPER BOUNCE® TRAMPOLINE PART**

Simply follow the assembly and safety instructions in this manual and you will soon be starting your **UPPER BOUNCE®** exercise program for a happier, healthier and more fun lifestyle!

Should you have any questions, please call our Customer Service Department  
Toll-free number: **1-888-965-3331**

|  |  |
|--|--|
| <b>MONDAY - THURSDAY</b><br>9:30 A.M. - 5:00 P.M.<br>Eastern Time. | <b>FRIDAY</b><br>9:00 A.M. - 12:00 P.M.<br>Eastern Time. |
|--|--|

**TABLE OF CONTENTS**

|  | Page  |
|--|-------|
| Instructions, Proper Assembly & Use, Safety Tips, Warnings | 2-5   |
| Trampoline Frame Parts List                                | 6     |
| Trampoline Enclosure Parts Set                             | 7     |
| Trampoline Frame Assembly                                  | 8-9   |
| Trampoline Mat Assembly                                    | 10-11 |
| Trampoline Pad Assembly                                    | 11    |
| Enclosure Assembly   | 12-14 |
| Jump Like a Pro  | 15    |
| Packaging & Replacement Parts                              | 16    |



## GENERAL INSTRUCTIONS

Included in this manual are instructions for: Proper assembly, care and maintenance of product, safety tips, warnings, and proper use; in order to ensure a secure and fun use of the trampoline. All users and supervisors must read and familiarize themselves with all these instructions and all other information in this manual.

As with any type of recreational physical activity, without being careful participants can be injured. Anybody who chooses to use this trampoline must be aware of their own limitations in regards to performing various jumps and bounces with this trampoline. Trampolines are rebounding devices which propel the performer to unaccustomed heights through a variety of movements, so initially; you should get accustomed to the feel and bounce of the trampoline. The focus must be on your body position, and you should practice each fundamental bounce until you can do each bounce with skill before moving on to more difficult and advanced bounces. Do not behave recklessly on the trampoline, emphasis must be made on good control and the mastering of various bounce techniques.

### Proper Assembly

- The assembly of the product must be done carefully by at least two able-bodied adults. Contact us, or ask any technically qualified person if you have any difficulties.
- Beware that when using tools or doing technical work, there is always a risk of injury, so assemble the product carefully, and use gloves to protect your hands.
- Remove all packaging materials and lay down all parts on a free space. This gives you an overview and simplifies the assembly procedure. Check with the parts list that no parts are missing and dispose of the packaging material when the assembly is completed.
- Work in a danger free environment, do not leave tools or hazardous materials scattered around the workspace.
- Place trampoline on level and non-slippery ground, preferably on grass. Locating the trampoline on a hard surface will add stress to the frame and over time cause damage which is not covered by warranty. Placing the trampoline on uneven surfaces could result in the trampoline tipping over.
- A clearance space of at least 24ft is necessary above the trampoline. An appropriated clearance must be kept between the trampoline and possible sources of danger, such as electric cables, tree branches, playing devices, swimming pools and fences.
- After assembling the trampoline according to the instructions, please make sure that all screws, bolts and nuts are correctly installed and tightened, and that all joints are tightly sealed.
- For additional stability you can attach anchors on the trampoline legs. This will prevent the trampoline from tipping over in the event of any wind force.



- Never set up the trampoline in rainy, windy or stormy conditions, especially lightening conditions. It is recommended that the trampoline be anchored with ground stakes.
- Do not alter the product; use it only as described in this manual.

### Care and Maintenance

- Always inspect the trampoline before each use. Check for damage, wear or defective parts, as they can impair the overall safety of the trampoline. The damaged, worn, or defective parts should be replaced immediately. In the meantime access to the trampoline must be restricted.
- Use the trampoline only in a well-lit area.
- Do not place any objects under the trampoline.
- Repairs should only be carried out by qualified technicians, using only original spare parts. Improper repairs can compromise the safety of your trampoline.
- Try to avoid moving the assembled trampoline, it could bend during transportation. Should it be necessary to move the trampoline, please consider the following: At least four people, evenly spaced around the frame, are needed to lift the trampoline off the ground. The trampoline must be carried horizontally, and if the frame shifts position, use four people to draw the trampoline back into the correct shape.
- The trampoline can only be used if the jumping mat is clean and dry. Worn or damaged jumping mats should be replaced immediately.

### Safety Guidelines

To reduce the risk of injury, please carefully read and follow the appropriate safety rules and tips, implementing all safety rules at all times.

- The product is intended for home/domestic use only and is not suitable for professional or medical uses.
- No more than one person at a time is allowed on the trampoline! Multiple jumpers increase the risk of mid-air collisions resulting in injury.



- Do not perform somersaults on the trampoline as this will increase the chances of landing on your head or neck, paralysis or even death can result.
- Children do not recognize the potential dangers of this product, so do not allow your children to play on this product without adult supervision.

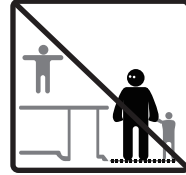

## Warnings

- Secure the trampoline against unauthorized use.
- Do not use during pregnancy or if suffering from high blood pressure.
- Do not smoke on the trampoline or use the trampoline when under the influence of alcohol or drugs (incl. Medication).
- Protect the product against humidity and high temperatures.
- Do not put cigarettes, pets, sharp objects or any other foreign objects on the trampoline.



- Do not expose the trampoline to open flames.
- The metal frame of the trampoline will conduct electricity. Lighting, extension cords and all electrical equipment must never be allowed to come in to contact with the trampoline parts.
- The trampoline may not be used in the close vicinity of other outdoor objects and furniture.
- Do not allow anyone or any object to go under the trampoline while someone is jumping on the mat. The jumping mat is flexible and the downward force created by someone jumping can cause serious injuries.



- Take care to keep the packaging materials beyond children's reach, as they present a choking hazard.



## Proper Use











- The maximum weight allowed on the trampoline is 500 lbs. Overloading the trampoline above the recommended user weight will cause damage to the trampoline.
- No more than one person at a time should be allowed on the trampoline!
- Avoid unsupervised use of the trampoline.
- Do not use the trampoline if it is wet.
- Do not wear shoes while jumping; this will damage the jumping mat.
- Do not sit or lean on the cover pad as it needs to be flexible so it can move with the jumping mat.
- Objects that could be dangerous should be vacated from the playing area.
- Do not allow small children to pull themselves up onto the trampoline by using the cover pads, as this may damage the pads and compromise the safety of your trampoline.
- Do not wear clothes with hooks or loose parts when jumping on the trampoline, in order to avoid getting stuck in any trampoline parts.
- Carefully climb onto trampoline. Do not jump into it directly, or use it as a jump board for other activities. Jumping into the trampoline, hitting the frame, cover pads, and landing incorrectly on the trampoline; can lead to injury.

It is the responsibility of the owner or the supervisor to guarantee that all users of the trampoline are informed about all safety rules and that there is sufficient space around the trampoline to allow for safe play.

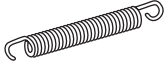
Learn the fundamental jumping techniques thoroughly before trying difficult jumps, see section: fundamental bounce techniques for further guidance.



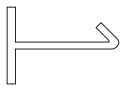





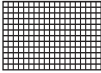

## TRAMPOLINE FRAME PARTS LIST

| PART | DESCRIPTION      | ILLUSTRATION  | QTY.<br>6/8/10FT | QTY.<br>12/14FT | QTY.<br>15FT | QTY.<br>16FT |
|------|------------------|---|------------------|-----------------|--------------|--------------|
| A    | TOP-RAIL         |    | 6                | 8               | 10           | 12           |
| B    | T JOINT          |    | 6                | 8               | 10           | 12           |
| C    | MAT              |    | 1                | 1               | 1            | 1            |
| D    | FRAME PAD        |    | 1                | 1               | 1            | 1            |
| E    | SPRING           |    | 36/48/60         | 72/80           | 90           | 108          |
| F    | LEG<br>EXTENSION |    | 0/0/6            | 8               | 10           | 12           |
| G    | LEG BASE         |   | 3                | 4               | 5            | 6            |
| H    | BOLT SET         |  | 0/0/6            | 8               | 10           | 12           |
| I    | SPRING TOOL      |  | 1                | 1               | 1            | 1            |
| J    | WRENCH           |  | 1                | 1               | 1            | 1            |



## TRAMPOLINE ENCLOSURE PARTS LIST

| PART | DESCRIPTION    | ILLUSTRATION  | QTY.<br>6/8/10FT | QTY.<br>12/14FT | QTY.<br>15FT | QTY.<br>16FT |
|------|----------------|---|------------------|-----------------|--------------|--------------|
| A    | UPPER POLE     |    | 6                | 8               | 6            | 10           |
| B    | LOWER POLE     |    | 6                | 8               | 6            | 10           |
| C    | ENCLOSURE NET  |    | 1                | 1               | 1            | 1            |
| D    | FIBERGLASS ROD |    | 1                | 1               | 1            | 1            |
| E    | POLE CLIP      |    | 36/48/60         | 72/80           | 36/48/60     | 90           |
| F    | POLE SLEEVE    |    | 0/0/6            | 8               | 0/0/6        | 10           |
| H    | BOLT SET       |   | 0/0/6            | 8               | 0/0/6        | 10           |
| I    | ROPE           |  | 1                | 1               | 1            | 1            |



## ASSEMBLY INSTRUCTIONS

Two adults are required for the folling assembly. For your safety, you should wear suitable gloves. Failure to follow these instructions can result in injury.

### Step 1 : Assembling the frame

The upper rail (part A) has 2 different ends - one side is narrow, the other side is wider. Please put the T-piece (part B) on the wide end of the upper rail part A). Please repeat this for all the other upper rails.

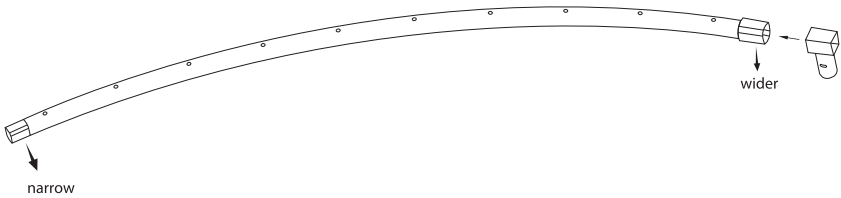

### Step 2 :

Please connect all of the upper rails together by inserting the narrow side of one upper rail into the wide side of the next upper rail.

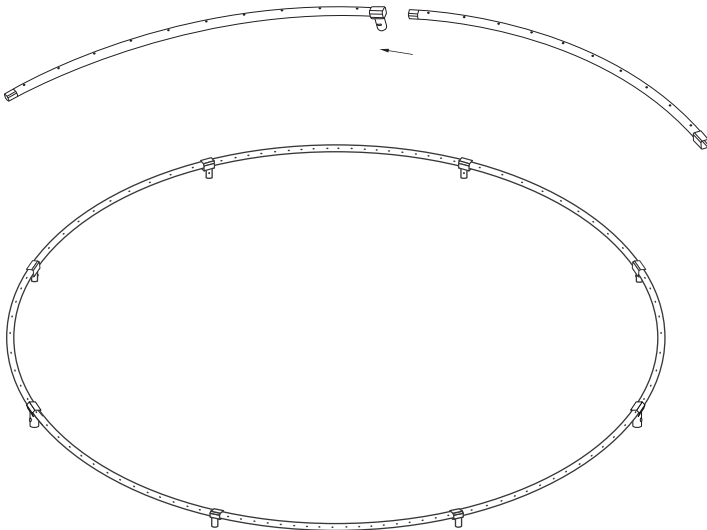

**Step 3 :**

Please screw the “vertical leg extensions” (part F) to the leg base (part G). Please use the bolts (part H) for this.

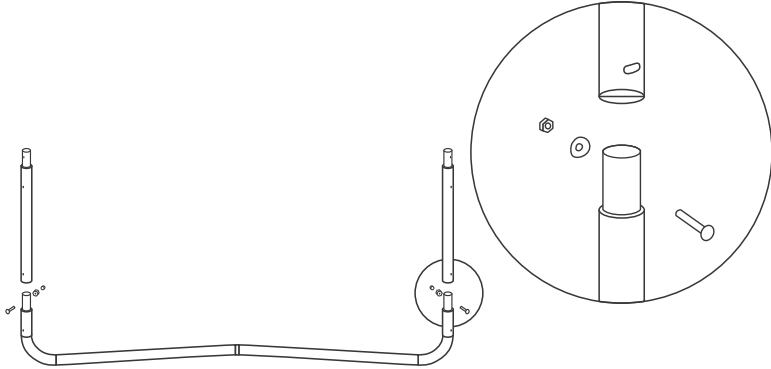

**Step 4 :**

Assemble the legs (in step 3) with the frame (in step 2).

**Caution!** Please note that all bolts point to the center of the frame.

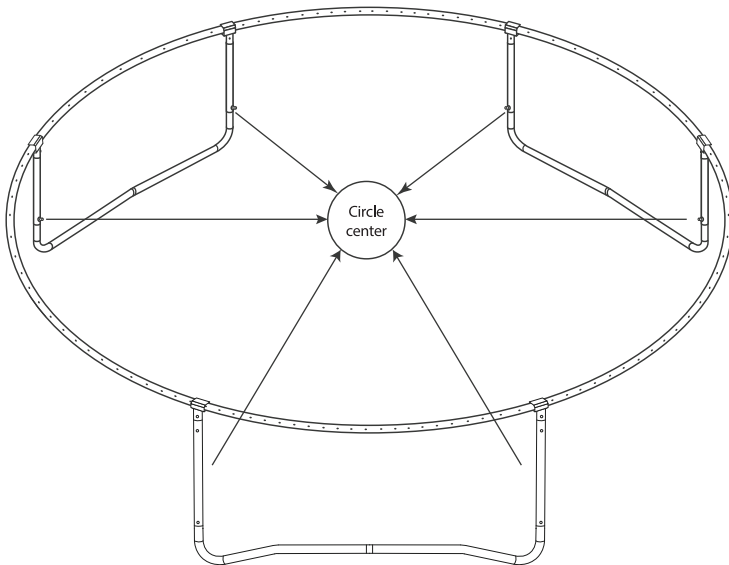

### Step 5 : Assembly of the jumping mat

Use caution when installing the jumping mat. Two people, work gloves, and proper attire are recommended.

1) Unfold the jumping mat inside the ring.

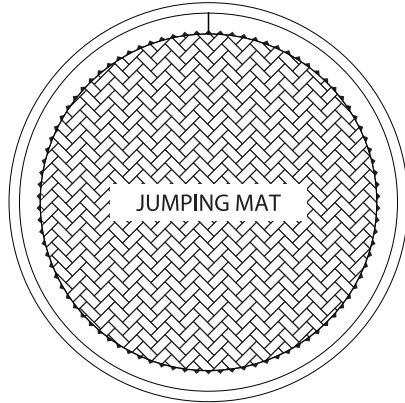

2) Please attach the springs. The narrower opening of the spring (A) goes into the jumping mat eyelet. Using the spring tool (part I) please pull the wider opening of the spring (B) towards the frame and insert the spring.

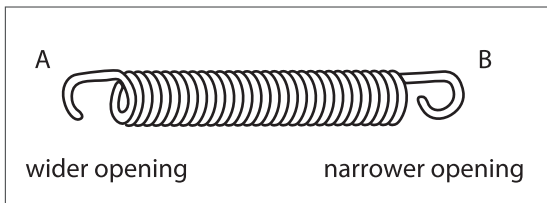
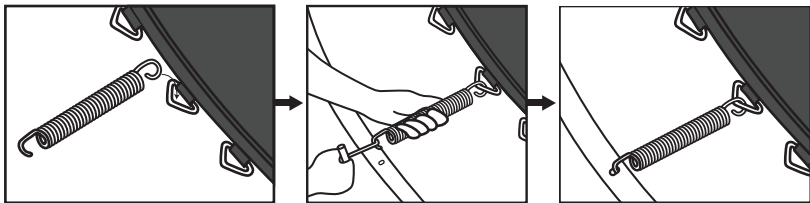

3) Please repeat this process for all springs one after the other. So that the tension of the jumping mat is evenly distributed, please note the following figure and keep to the sequence of the spring assembly.

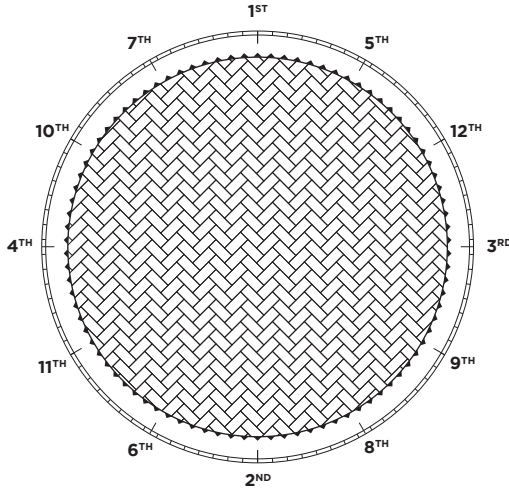

**Caution:** Please be careful not to injure your fingers. As mentioned at the beginning, please use gloves!

#### 4) Installation of the frame pad

Please place the edge cover (part D) over the springs and the steel frame. Attach the elastic bands of the edge cover to the frame.

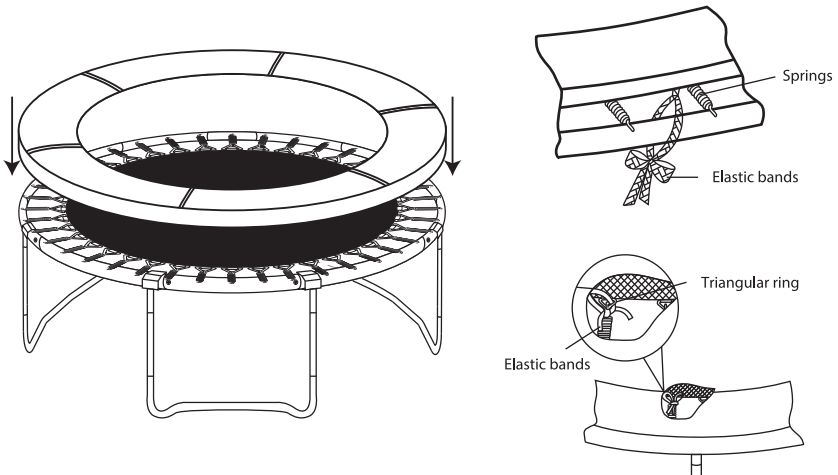

## ENCLOSURE ASSEMBLY

For your safety, it is recommended that assembly is done by 2 adults wearing working gloves.

### Step 1 :

Please connect the poles to each other by inserting the lower enclosure pole (enclosure part B) into the upper enclosure pole (enclosure part A) securing it with the safety pin. Repeat this process for all other bars.

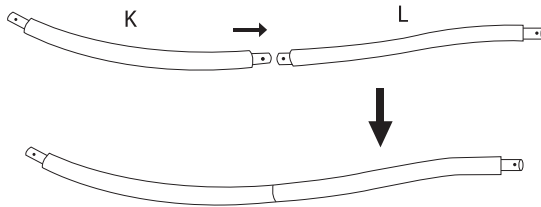

### Step 2 :

Slide the pole sleeve (Enclosure Part F) over each of the assembled bars.

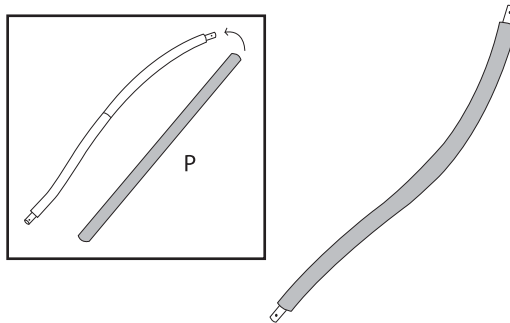

### Step 3 :

Attach the lower net bars with the bolts (Enclosure Part H) to the leg extension (Part F) and T-Joint (Part B), securing the nut with the provided wrench or another tool.

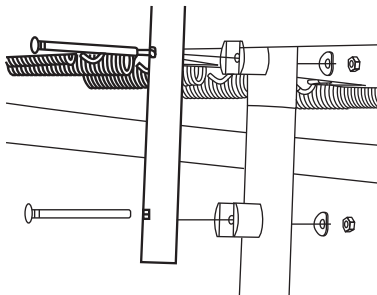

## Step 4 :

Hold the enclosure net (Enclosure Part C), with sleeves facing up. Pull each section of the fiberglass rod (Enclosure Part D) through each sleeve on the net. Connect the ends together forming a circle. This is easier when two people hold the net.

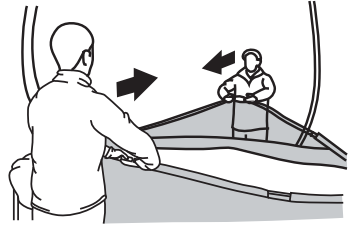
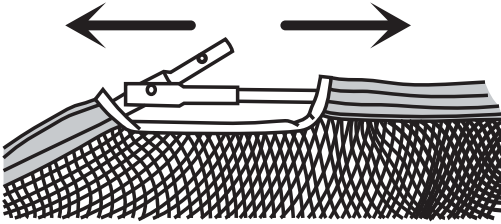

## Step 5 :

- A.** Align the two parts of the Pole Clip (Enclosure Part E) according to the below diagram.
- B.** Insert over each open section of the fiberglass loop.
- C.** Insert the pole caps which are now holding the fiberglass ring, over the enclosure poles, and secure with locking pins.

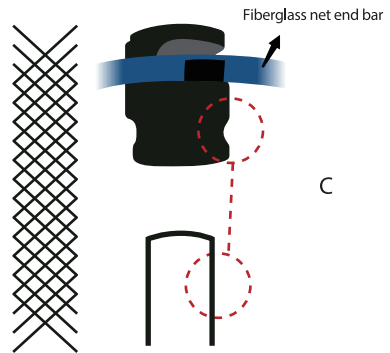
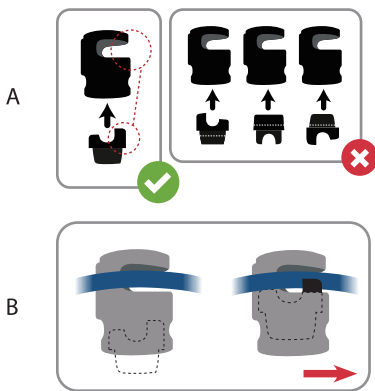

## Step 6 :

Pull back the frame pad for better visibility. Align the bottom hem of the enclosure net to the eyelet rings on the jumping mat and insert the Rope (Enclosure Part I) alternating between the slits in the jumping mat, and the eyelet rings.

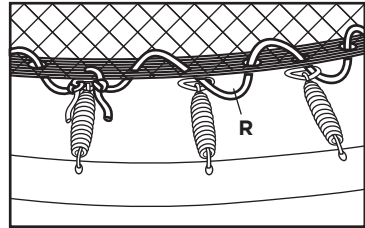
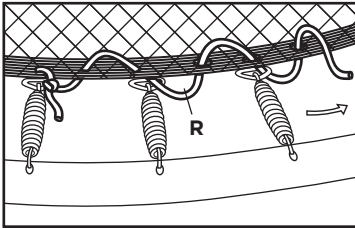

# *Congratulations*

you have completed the  
trampoline assembly!  
Remember to abide by  
all the safety rules.

*Have fun, play safe...*

## JUMP LIKE A PRO!

### BASIC JUMP

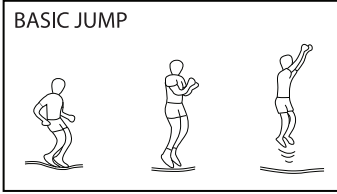

1. Standing starting position, feet shoulder-width apart, head straight and eyes on the jumping mat.
2. Swing your arms forwards and up in a circular motion.
3. Bring your feet together in the air, toes pointing down.
4. When landing on the jumping mat, the feet must be shoulder-width apart again.

### KNEE JUMP

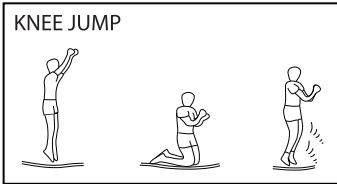

1. Start with a basic jump.
2. Land on your knees, keeping your body and back straight. Keep your balance with your arms.
3. Jump back to the basic jump position by swinging your arms.

### SIT JUMP

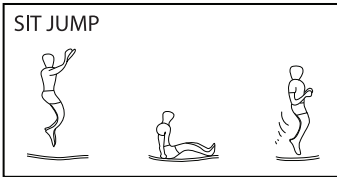

1. Land in a flat sitting position.
2. Place your hands on the jumping mat next to your hips.
3. Return to a standing position by pressing with your hands.

### STOMACH JUMP

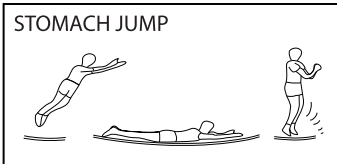

1. Start from the forward drop position.
2. Land in prone position (face down) with your arms and hands stretched forward on the jumping mat.
3. Push your arms off the jumping mat to return to the standing position.

### 180-DEGREE JUMP

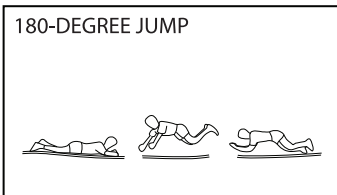

1. Start from the forward drop position.
2. Push with your left or right hand and your left or right arm (depending on which direction you want to turn).
3. Turn your head and shoulders in the same direction, keep your back parallel to the jumping mat and your head up.
4. Land in the prone position and return to the standing position by pressing with your hands and arms.





## Dispose of the packaging



Please recycle all parts appropriately. Paper, cardboard, and plastic should be disposed to correct recycle areas according to your local recycling laws.



www.tuv.com  
ID 1419072263

## Trampoline replacement parts

While we provide a large variety of trampolines, we also pride ourselves in the large selection of our trampoline replacement parts which are compatible with most trampolines regardless of their brand.

If you have difficulty finding the correct replacement part for your trampoline,

PLEASE GIVE US A CALL  
1-888-965-3331



OR

EMAIL US AT  
sales@upperbounce.com



Our Customer Service Department staff are trained in the details of all trampolines and will help you find the right part to get you bouncing again.

**TAKE  
15% OFF**

**FOR ANY  
TRAMPOLINE  
PARTS**

**USE CODE :  
15OFFMANUAL**