



FLAT BACKS NO HOTFIX





















































Flat Backs No Hotfix are loose crystal elements backed with platinum foiling for extra brilliance and protection. These Flat Backs are easy to apply to a variety of carrier materials using standard one- or two-component glues. They are available in a multitude of sizes, colors, shapes, and cuts.

The most innovative single item in this product group is art. 2088 XIRIUS Rose, with the most progressive and unique cut on the market: multilayer cut technology

creates the inspiring XIRIUS star design. Superior shine and rich, well-balanced refraction of light redefine the market standard.

Swarovski's outstanding quality in crystal elements is underlined by the highest precision in table size and diameter.

SUMMARY

1 	2 	2000 SS 3, 4	1 	2 	CORE ASSORTMENT 2300 8x4.8, 10x6 mm	1 	2 	2555 8x2.6, 12x4, 15x5 mm
		2006 10, 12, 14, 16 mm			2303 8x5, 14x9 mm			2570 50x16 mm
		2034 SS 10, 20, 48			2304 6x1.7, 10x2.8, 14x3.9 mm			2585 8, 10 mm
		2035 6, 10, 14, 20, 30, 40 mm			CORE ASSORTMENT 2400 2.2, 3, 4, 6, 10 mm			2602 8x5.5, 14x10 mm
		CORE ASSORTMENT 2058 SS 5, 6, 7, 8, 9, 10			2402 4, 6, 10 mm			2709 10x6, 13x8 mm
		2072 8, 10, 12 mm			2403 4, 6, 10 mm			2711 3.3 mm
		CORE ASSORTMENT 2088 SS 12, 14, 16, 20, 24, 30, 34, 40, 48			2420 10, 25 mm			2714 6, 10 mm
		2088/1 SS 16, 20, 34			2483 10, 25 mm			2716 5 mm
		CORE ASSORTMENT 2200 4x2, 8x4 mm			2493 8, 10, 20 mm			2720 7.5, 9, 12.5 mm
		2201 8x3.5, 14x6 mm			2494 6, 8 mm			2738 10x5, 12x6 mm
		2204 6x4.8, 10x8 mm			2520 8x6, 10x8, 14x10 mm			2739 5.8x5.3, 7x6.5 mm
		2205 7.5, 10, 14 mm			2540 7x5.5 mm			2740 8.3x8.3, 10x10 mm



2753
10 mm



2856
10x7.5, 14x10.5, 18x14 mm



2770
6x3.5, 12x7 mm



2858
6x4.5, 9x6.5 mm



2771
6.4x4.2, 8.6x5.6,
12.9x8.3 mm



2772
6.5x2.1, 8.6x2.8,
12.9x4.2 mm

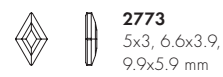

2773
5x3, 6.6x3.9,
9.9x5.9 mm



DESIGNER EDITION
2797
8x4 mm



2798
8, 10, 14 mm



2808
6, 10, 14 mm



2813
8x5.5, 10x7 mm



2816
5 mm



2826
5 mm

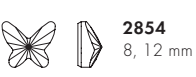

2854
8, 12 mm

SUMMARY

2000 Rose Flat Back



Size
SS 3
SS 4

Crystal	
Crystal F (001)	■ ■
Colors	
Plain Colors	
Amethyst F (204)	■
Aquamarine F (202)	■
Black Diamond F (215)	■
Indian Siam F (327)	■
Jet (280)	■
Jonquil F (213)	■
Light Colorado Topaz F (246)	■
Light Rose F (223)	■
Montana F (207)	■
Peridot F (214)	■
Smoked Topaz F (220)	■
Crystal Effects	
Transparent Effects	
Crystal AB F (001 AB)	■ ■
Crystal Golden Shadow F (001 GSHA)	■
Crystal Silver Shade F (001 SSHA)	■
Metallic Effects	
Crystal Metallic Light Gold F (001 MLGLD)	■
Crystal Rose Gold F (001 ROGL)	■
Color Effects	
Metallic Effects	
Jet Hematite F (280 HEM)	■

2006 Rivoli Flat Back

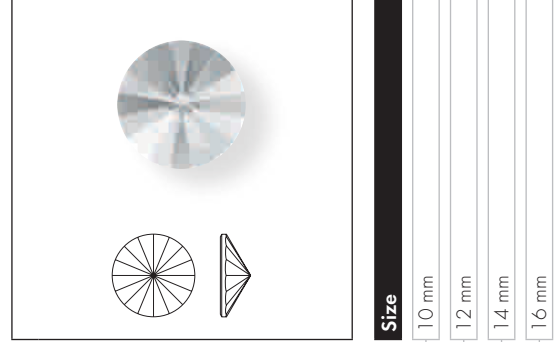

Size
10 mm
12 mm
14 mm
16 mm

Crystal	
Crystal F (001)	■ ■ ■ ■

2034 Concise Flat Back

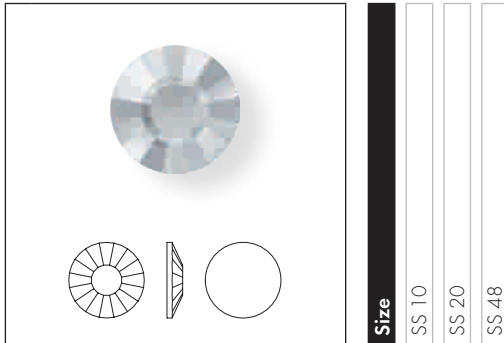

	SS 10	SS 20	SS 48
Crystal			
Crystal F (001)	■	■	■
Colors			
Plain Colors			
Jet F (280)	■	■	■
Light Siam F (227)	■	■	■
Crystal Effects			
Transparent Effects			
Crystal AB F (001 AB)	■	■	■
Crystal Golden Shadow F (001 GSHA)	■	■	■
Metallic Effects			
Crystal Light Chrome F (001 LTCH)	■	■	■
Crystal Patina Effect			
Crystal Black Patina F (001 BLAPA)	■	■	■
Crystal Rose Patina F (001 ROSPA)	■	■	■
Color Effects			
Transparent Effects			
Light Siam AB F (227 AB)	■	■	■

2035 Chessboard Circle Flat Back

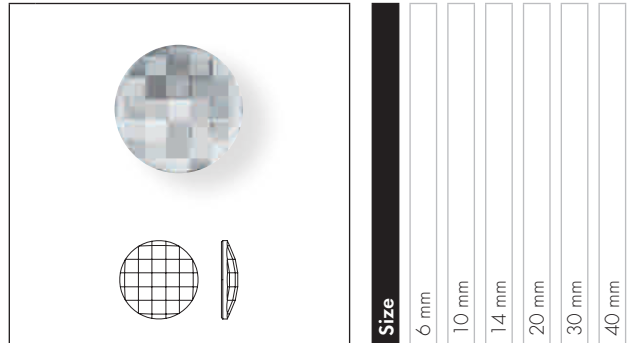

	6 mm	10 mm	14 mm	20 mm	30 mm	40 mm
Crystal						
Crystal F (001)	■	■	■	■	■	■
Crystal CAL V SI (001 CAL V SI) ¹				■	■	■
Colors						
Plain Colors						
Jet (280)	■	■	■	■		
Crystal Effects						
Transparent Effects						
Crystal AB F (001 AB)	■	■				
Crystal Golden Shadow F (001 GSHA)	■	■	■	■		

¹ Coated on faceted side.

CORE ASSORTMENT

2058 XILION Rose Enhanced

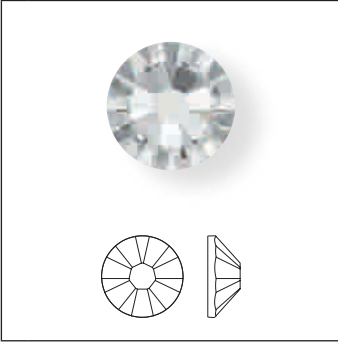

Size	SS 5	SS 6	SS 7	SS 8	SS 6 SS	SS 10
------	------	------	------	------	---------	-------

Crystal

Crystal F (001)	◆	◆	◆	◆	◆	◆
-----------------	---	---	---	---	---	---

Colors

Plain Colors

Amethyst F (204)	◆	◆	◆	◆	◆	◆
Aquamarine F (202)	◆	◆	◆	◆	◆	◆
Black Diamond F (215)	■	■	■	■	■	■
Blue Zircon F (229)	■	■	■	■	■	■
Blush Rose F (257)	■	■	■	■	■	■
Burgundy F (515)	■	■	■	■	■	■
Capri Blue F (243)	■	■	■	■	■	■
Chrysolite F (238)	■	■	■	■	■	■
Citrine F (249)	■	■	■	■	■	■
Cobalt F (369)	■	■	■	■	■	■
Dark Indigo F (288)	■	■	■	■	■	■
Denim Blue F (266)	■	■	■	■	■	■
Emerald F (205)	◆	◆	◆	◆	◆	◆
Erinite F (360)	■	■	■	■	■	■
Fern Green F (291)	■	■	■	■	■	■
Fuchsia F (502)	■	■	■	■	■	■
Graphite F (253)	■	■	■	■	■	■
Greige F (284)	■	■	■	■	■	■
Hyacinth F (236)	■	■	■	■	■	■
Indian Pink F (289)	■	■	■	■	■	■
Indian Siam F (327)	■	■	■	■	■	■
Jet (280)	◆	◆	◆	◆	◆	◆
Jet F (280)	■	■	■	■	■	■
Jonquil F (213)	■	■	■	■	■	■
Light Amethyst F (212)	■	■	■	■	■	■
Light Colorado Topaz F (246)	◆	◆	◆	◆	◆	◆
Light Peach F (362)	■	■	■	■	■	■
Light Rose F (223)	■	■	■	■	■	■
Light Sapphire F (211)	■	■	■	■	■	■
Light Siam F (227)	■	■	■	■	■	■
Light Silk F (261)	■	■	■	■	■	■
Light Topaz F (226)	■	■	■	■	■	■
Light Turquoise F (263)	■	■	■	■	■	■
Majestic Blue F (296)	■	■	■	■	■	■
Montana F (207)	■	■	■	■	■	■
Olivine F (228)	■	■	■	■	■	■

◆ Core Assortment

2058		Size	SS 5	SS 6	SS 7	SS 8	SS 9	SS 10
Padparadscha F (542)			■		■		■	
Peridot F (214)			■		■		■	■
Provence Lavender F (283)			■		■		■	
Purple Velvet F (277)			■		■		■	
Rose F (209)			■	■	■		■	■
Rose Peach F (262)			■		■		■	
Ruby F (501)			■		■		■	■
Sapphire F (206)			■	■	■		■	■
Scarlet F (276)			◆	◆	◆	◆	◆	◆
Siam F (208)			■		■		■	■
Silk F (391)			■		■		■	
Smoked Topaz F (220)			■		■		■	
Sunflower F (292)			■		■		■	
Tangerine F (259)			■		■		■	
Tanzanite F (539)			■		■		■	
Topaz F (203)			■		■		■	
Vintage Rose F (319)			■		■		■	
Opal Colors								
Air Blue Opal F (285)			■		■		■	
Chrysolite Opal F (294)			■		■		■	
Pacific Opal F (390)			■		■		■	
White Opal F (234)			■		■		■	
Yellow Opal F (231)			■		■		■	
Crystal Effects								
Transparent Effects								
Crystal AB F (001 AB)			■	■	■	■	■	■
Crystal Antique Pink F (001 ANTP)			■		■		■	
Crystal Blue Shade F (001 BLSH)			■		■		■	
Crystal Copper F (001 COP)			■		■		■	
Crystal Golden Shadow F (001 GSHA)			■		■		■	
Crystal Luminous Green F (001 LUMG)			■		■		■	
Crystal Meridian Blue F (001 MBL)			■		■		■	
Crystal Moonlight F (001 MOL)			■		■		■	
Crystal Paradise Shine F (001 PARSH)			■		■		■	
Crystal Silver Night F (001 SINI)			■		■		■	
Crystal Silver Shade F (001 SSHA)			■		■		■	
Crystal Volcano F (001 VOL)			■		■		■	
Metallic Effects								
Crystal Dorado F (001 DOR)			■		■		■	
Crystal Iridescent Green F (001 IRIG)			■		■		■	

◆ Core Assortment

2058		Size	SS 5	SS 6	SS 7	SS 8	SS 9	SS 10
	Crystal Light Chrome F (001 LTCH)		■		■		■	
	Crystal Metallic Blue F (001 METBL)		■		■		■	
	Crystal Metallic Light Gold F (001 MLGLD)		■		■		■	
	Crystal Metallic Sunshine F (001 METSH)		■		■		■	
	Crystal Rainbow Dark F (001 RABDK)		■		■		■	
	Crystal Rose Gold F (001 ROGL)		■		■		■	
	Crystal Scarabaeus Green*** F (001 SCGR)		■		■		■	
Color Effects								
Transparent Effects								
	Aquamarine AB F (202 AB)		■		■		■	
	Black Diamond Shimmer F (215 SHIM)		■				■	
	Blue Zircon Shimmer F (229 SHIM)		■				■	
	Citrine Shimmer F (249 SHIM)		■				■	
	Cobalt Shimmer F (369 SHIM)		■				■	
	Crystal Shimmer F (001 SHIM)		■				■	
	Erinite Shimmer F (360 SHIM)		■				■	
	Fuchsia Shimmer F (502 SHIM)		■				■	
	Hyacinth Shimmer F (236 SHIM)		■				■	
	Jonquil AB F (213 AB)		■		■		■	
	Light Colorado Topaz Shimmer F (246 SHIM)		■				■	
	Light Rose AB F (223 AB)		■		■		■	
	Light Sapphire Shimmer F (211 SHIM)		■				■	
	Light Siam AB F (227 AB)		■		■		■	
	Light Siam Shimmer F (227 SHIM)		■				■	
	Light Topaz Shimmer F (226 SHIM)		■				■	
	Peridot AB F (214 AB)		■		■		■	
	Peridot Shimmer F (214 SHIM)		■				■	
	Rose AB F (209 AB)		■		■		■	
	Sapphire AB F (206 AB)		■		■		■	
	Siam Shimmer F (208 SHIM)		■				■	
	Silk Shimmer F (391 SHIM)		■				■	
	Tangerine Shimmer F (259 SHIM)		■				■	
	Topaz AB F (203 AB)		■		■		■	
	Topaz Shimmer F (203 SHIM)		■				■	
Metallic Effects								
	Jet Hematite (280 HEM)		■		■		■	■
	Jet Hematite F (280 HEM)		■		■		■	■

2072 Rose Cut Flat Back

2072 Rose Cut Flat Back		Size	8 mm	10 mm	12 mm
	Crystal F (001)		■	■	■

*** designed by Jean Paul Gaultier

CORE ASSORTMENT

2088 XIRIUS Rose

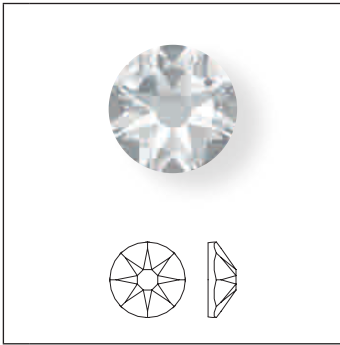

Size	SS 12	SS 14	SS 16	SS 20	SS 24	SS 30	SS 34	SS 40	SS 48
------	-------	-------	-------	-------	-------	-------	-------	-------	-------

Crystal

Crystal F (001)	◆	◆	◆	◆	■	◆	◆	■	■
-----------------	---	---	---	---	---	---	---	---	---

Colors

Plain Colors

Amethyst F (204)	◆	◆	◆	◆		◆	◆		
Aquamarine F (202)	◆	◆	◆	◆		◆	◆		
Black Diamond F (215)	■		■	■		■	■		
Blue Zircon F (229)	■		■	■		■	■		
Blush Rose F (257)	■		■	■		■	■		
Burgundy F (515)	■		■	■		■	■		
Capri Blue F (243)	■		■	■		■	■		
Chrysolite F (238)	■		■	■		■	■		
Citrine F (249)	■		■	■		■	■		
Cobalt F (369)	■		■	■		■	■		
Dark Indigo F (288)	■		■	■		■	■		
Denim Blue F (266)	■		■	■		■	■		
Emerald F (205)	◆	◆	◆	◆		◆	◆		
Erinite F (360)	■		■	■		■	■		
Fern Green F (291)	■		■	■		■	■		
Fireopal F (237)	■		■	■		■	■		
Fuchsia F (502)	■		■	■		■	■		
Graphite F (253)	■		■	■		■	■		
Greige F (284)	■		■	■		■	■		
Hyacinth F (236)	■		■	■		■	■		
Indian Pink F (289)	■		■	■		■	■		
Indian Siam F (327)	■		■	■		■	■		
Jet (280)	◆	◆	◆	◆		◆	◆		
Jet F (280)	■		■	■		■	■		
Jonquil F (213)	■		■	■		■	■		
Light Amethyst F (212)	■		■	■		■	■		
Light Colorado Topaz F (246)	◆	◆	◆	◆		◆	◆		
Light Peach F (362)	■		■	■		■	■		
Light Rose F (223)	■		■	■		■	■		
Light Sapphire F (211)	■		■	■		■	■		
Light Siam F (227)	■		■	■		■	■		
Light Silk F (261)	■		■	■		■	■		
Light Topaz F (226)	■		■	■		■	■		
Light Turquoise F (263)	■		■	■		■	■		
Majestic Blue F (296)	■		■	■		■	■		
Montana F (207)	■		■	■		■	■		

◆ Core Assortment

2088		Size	SS 12	SS 14	SS 16	SS 20	SS 24	SS 30	SS 34	SS 40	SS 48
Olivine F (228)			■		■	■		■	■		
Padparadscha F (542)			■		■	■		■	■		
Peridot F (214)			■		■	■		■	■		
Provence Lavender F (283)			■		■	■		■	■		
Purple Velvet F (277)			■		■	■		■	■		
Rose F (209)			■		■	■		■	■		
Rose Peach F (262)			■		■	■		■	■		
Ruby F (501)			■		■	■		■	■		
Sapphire F (206)			■		■	■		■	■		
Scarlet F (276)			◆	◆	◆	◆		◆	◆		
Siam F (208)			■		■	■		■	■		
Silk F (391)			■		■	■		■	■		
Smoked Topaz F (220)			■		■	■		■	■		
Sunflower F (292)			■		■	■		■	■		
Tangerine F (259)			■		■	■		■	■		
Tanzanite F (539)			■		■	■		■	■		
Topaz F (203)			■		■	■		■	■		
Vintage Rose F (319)			■		■	■		■	■		
Opal Colors											
Air Blue Opal F (285)			■		■	■		■	■		
Chrysolite Opal F (294)			■		■	■		■	■		
Pacific Opal F (390)			■		■	■		■	■		
White Opal F (234)			■		■	■		■	■		
Yellow Opal F (231)			■		■	■		■	■		
Crystal Effects											
Transparent Effects											
Crystal AB F (001 AB)			■	■	■	■	■	■	■	■	■
Crystal Antique Pink F (001 ANTP)			■		■	■		■	■		
Crystal Blue Shade F (001 BLSH)			■		■	■		■	■		
Crystal Copper F (001 COP)			■		■	■		■	■		
Crystal Golden Shadow F (001 GSHA)			■		■	■		■	■		
Crystal Luminous Green F (001 LUMG)			■		■	■		■	■		
Crystal Meridian Blue F (001 MBL)			■		■	■		■	■		
Crystal Moonlight F (001 MOL)			■		■	■		■	■		
Crystal Paradise Shine F (001 PARSH)			■		■	■		■	■		
Crystal Silver Night F (001 SINI)			■		■	■		■	■		
Crystal Silver Shade F (001 SSHA)			■		■	■		■	■		
Crystal Volcano F (001 VOL)			■		■	■		■	■		
Metallic Effects											
Crystal Dorado F (001 DOR)			■		■	■		■	■		
Crystal Iridescent Green F (001 IRIG)			■		■	■		■	■		

2088		Size								
		SS 12	SS 14	SS 16	SS 20	SS 24	SS 30	SS 34	SS 40	SS 48
	Crystal Light Chrome F (001 LTCH)	■		■	■		■	■		
	Crystal Metallic Blue F (001 METBL)	■		■	■		■	■		
	Crystal Metallic Light Gold F (001 MLGLD)	■		■	■		■	■		
	Crystal Metallic Sunshine F (001 METSH)	■		■	■		■	■		
	Crystal Rainbow Dark F (001 RABDK)	■		■	■		■	■		
	Crystal Rose Gold F (001 ROGL)	■		■	■		■	■		
	Crystal Scarabaeus Green*** F (001 SCGR)	■		■	■		■	■		
Crystal Lacquer^{PRO} Effects										
Crystal Shiny Lacquer^{PRO} Effects										
	Crystal Azure Blue (001 L112S)	■		■	■		■			
	Crystal Buttercup (001 L124S)	■		■	■		■			
	Crystal Dark Grey (001 L111S)	■		■	■		■			
	Crystal Dark Red (001 L108S)	■		■	■		■			
	Crystal Ivory Cream (001 L106S)	■		■	■		■			
	Crystal Light Coral (001 L116S)	■		■	■		■			
	Crystal Lilac (001 L126S)	■		■	■		■			
	Crystal Lime (001 L125S)	■		■	■		■			
	Crystal Mint Green (001 L115S)	■		■	■		■			
	Crystal Peony Pink (001 L113S)	■		■	■		■			
	Crystal Royal Blue (001 L110S)	■		■	■		■			
	Crystal Royal Green (001 L109S)	■		■	■		■			
	Crystal Royal Red (001 L107S)	■		■	■		■			
	Crystal Summer Blue (001 L114S)	■		■	■		■			
Crystal Lacquer^{PRO} DeLite Effects										
	Crystal Army Green DeLite (001 L130D)	■		■	■		■			
	Crystal Burgundy DeLite (001 L132D)	■		■	■		■			
	Crystal Cappuccino DeLite (001 L133D)	■		■	■		■			
	Crystal Light Grey DeLite (001 L129D)	■		■	■		■			
	Crystal Ochre DeLite (001 L131D)	■		■	■		■			
Color Effects										
Transparent Effects										
	Aquamarine AB F (202 AB)	■		■	■		■			
	Black Diamond Shimmer F (215 SHIM)	■		■	■		■			
	Blue Zircon Shimmer F (229 SHIM)	■		■	■		■			
	Citrine Shimmer F (249 SHIM)	■		■	■		■			
	Cobalt Shimmer F (369 SHIM)	■		■	■		■			
	Crystal Shimmer F (001 SHIM)	■		■	■		■			
	Erinite Shimmer F (360 SHIM)	■		■	■		■			
	Fuchsia Shimmer F (502 SHIM)	■		■	■		■			

*** designed by Jean Paul Gaultier

2088		Size	SS 12	SS 14	SS 16	SS 20	SS 24	SS 30	SS 34	SS 40	SS 48
	Hyacinth Shimmer F (236 SHIM)										
	Light Colorado Topaz Shimmer F (246 SHIM)										
	Jonquil AB F (213 AB)										
	Light Rose AB F (223 AB)										
	Light Sapphire Shimmer F (211 SHIM)										
	Light Siam AB F (227 AB)										
	Light Siam Shimmer F (227 SHIM)										
	Light Topaz Shimmer F (226 SHIM)										
	Peridot AB F (214 AB)										
	Peridot Shimmer F (214 SHIM)										
	Rose AB F (209 AB)										
	Sapphire AB F (206 AB)										
	Siam Shimmer F (208 SHIM)										
	Silk Shimmer F (391 SHIM)										
	Tangerine Shimmer F (259 SHIM)										
	Topaz AB F (203 AB)										
	Topaz Shimmer F (203 SHIM)										
Metallic Effects											
	Jet Hematite (280 HEM)										
	Jet Hematite F (280 HEM)										

2088/I Rimmed XIRIUS Rose

2088/I Rimmed XIRIUS Rose		Size	SS 16	SS 20	SS 34
	Crystal Effects				
	Metallic Effects				
	Crystal & Dorado Z F (001 DORZ)				
	Crystal & Lt. Chrome Z F (001 LTCHZ)				
	Color Effects				
	Metallic Effects				
	Black Diamond & Dorado Z F (215 DORZ)				
	Black Diamond & Lt. Chrome Z F (215 LTCHZ)				
	Burgundy & Dorado Z F (515 DORZ)				
	Burgundy & Lt. Chrome Z F (515 LTCHZ)				
	Denim Blue & Dorado Z F (266 DORZ)				
	Denim Blue & Lt. Chrome Z F (266 LTCHZ)				
	Greige & Dorado Z F (284 DORZ)				
	Greige & Lt. Chrome Z F (284 LTCHZ)				
	Jet & Dorado Z F (280 DORZ)				
	Jet & Lt. Chrome Z F (280 LTCHZ)				
	Khaki & Dorado Z F (550 DORZ)				
	Khaki & Lt. Chrome Z F (550 LTCHZ)				
	Light Siam & Dorado Z F (227 DORZ)				
	Light Siam & Lt. Chrome Z F (227 LTCHZ)				
	White Opal & Dorado Z F (234 DORZ)				
	White Opal & Lt. Chrome Z F (234 LTCHZ)				

CORE ASSORTMENT

2200 Navette Flat Back



Size
4x2 mm
8x4 mm

- Crystal**
- Crystal F (001) ◆
- Colors**
- Plain Colors**
- Amethyst F (204) ◆
- Aquamarine F (202) ◆
- Emerald F (205) ◆
- Jet (280) ◆
- Light Colorado Topaz F (246) ◆
- Scarlet F (276) ◆
- Crystal Effects**
- Transparent Effects**
- Crystal AB F (001 AB) ◆
- Crystal Golden Shadow F (001 GSHA) ◆

2201 Marquise Flat Back

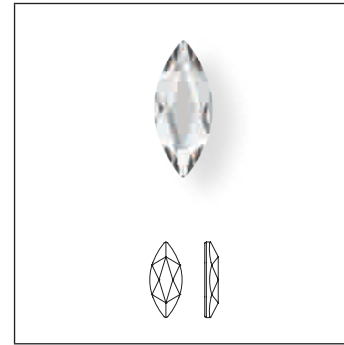

Size
8x3.5 mm
14x6 mm

- Crystal**
- Crystal F (001) ◆
- Colors**
- Plain Colors**
- Aquamarine F (202) ◆
- Emerald F (205) ◆
- Graphite F (253) ◆
- Jet (280) ◆
- Sapphire F (206) ◆
- Scarlet F (276) ◆
- Sunflower F (292) ◆
- Vintage Rose F (319) ◆
- Crystal Effects**
- Transparent Effects**
- Crystal AB F (001 AB) ◆
- Crystal Golden Shadow F (001 GSHA) ◆
- Crystal Silver Shade F (001 SSHA) ◆

2204 Pure Leaf Flat Back

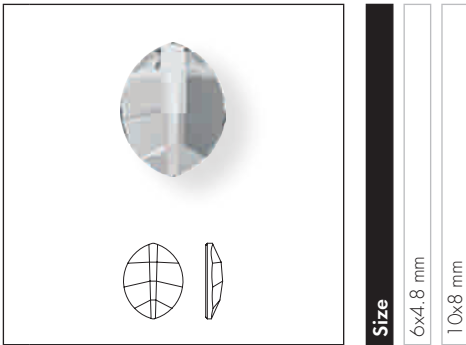

Size
6x4.8 mm
10x8 mm

- Crystal**
- Crystal F (001) ◆
- Crystal Effects**
- Transparent Effects**
- Crystal AB F (001 AB) ◆

2205 Flame Flat Back

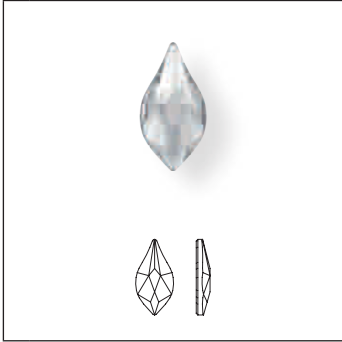

Size	7.5 mm	10 mm	14 mm
------	--------	-------	-------

- Crystal**
- Crystal F (001)
- Colors**
- Plain Colors**
- Fireopal F (237)
- Jet (280)
- Light Colorado Topaz F (246)
- Light Siam F (227)
- Opal Colors**
- White Opal F (234)
- Crystal Effects**
- Transparent Effects**
- Crystal AB F (001 AB)
- Crystal Golden Shadow F (001 GSHA)
- Crystal Silver Night (001 SINI)
- Metallic Effects**
- Crystal Iridescent Green F (001 IRIG)

CORE ASSORTMENT

2300 Drop Flat Back



Size	8x4.8 mm	10x6 mm
------	----------	---------

- Crystal**
- Crystal F (001)
- Colors**
- Plain Colors**
- Amethyst F (204)
- Aquamarine F (202)
- Emerald F (205)
- Jet (280)
- Light Colorado Topaz F (246)
- Scarlet F (276)

2303 Pear Flat Back



Size

8x5 mm

14x9 mm

Crystal

Crystal F (001)

Colors

Plain Colors

Aquamarine F (202)

Emerald F (205)

Graphite F (253)

Jet (280)

Sapphire F (206)

Scarlet F (276)

Sunflower F (292)

Vintage Rose F (319)

Crystal Effects

Transparent Effects

Crystal AB F (001 AB)

Crystal Golden Shadow F (001 GSHA)

Crystal Silver Shade F (001 SSHA)

2304 Raindrop Flat Back



Size

6x1.7 mm

10x2.8 mm

14x3.9 mm

Crystal

Crystal F (001)

Colors

Plain Colors

Blush Rose F (257)

Jet (280)

Light Siam F (227)

Crystal Effects

Transparent Effects

Crystal AB F (001 AB)

Crystal Blue Shade F (001 BLSH)

Crystal Golden Shadow F (001 GSHA)

Crystal Luminous Green F (001 LUMG)

Crystal Silver Night (001 SINI)

SQUARE FAMILY

CORE ASSORTMENT

2400 Square Flat Back

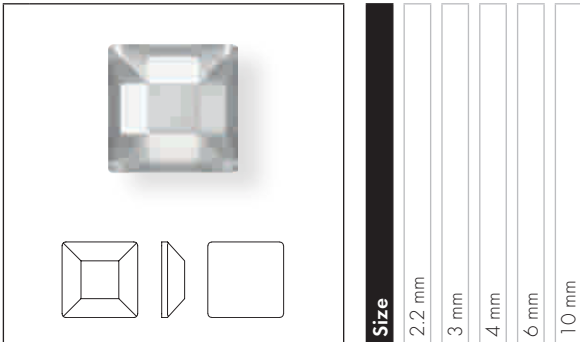

	2.2 mm	3 mm	4 mm	6 mm	10 mm
Crystal					
Crystal F (001)	◆	◆	◆	◆	◆
Colors					
Plain Colors					
Amethyst F (204)	◆	◆	◆	◆	◆
Aquamarine F (202)	◆	◆	◆	◆	◆
Emerald F (205)	◆	◆	◆	◆	◆
Jet (280)	◆	◆	◆	◆	◆
Light Colorado Topaz F (246)	◆	◆	◆	◆	◆
Scarlet F (276)	◆	◆	◆	◆	◆
Crystal Effects					
Transparent Effects					
Crystal AB F (001 AB)	■	■	■	■	■
Crystal Golden Shadow F (001 GSHA)	■	■	■	■	■
Crystal Silver Night (001 SINI)	■	■	■	■	■
Metallic Effects					
Crystal Dorado F (001 DOR)	■	■	■	■	■
Crystal Light Chrome F (001 ITCH)	■	■	■	■	■
Color Effects					
Metallic Effects					
Jet Hematite (280 HEM)	■	■	■	■	■

2402 Base Flat Back

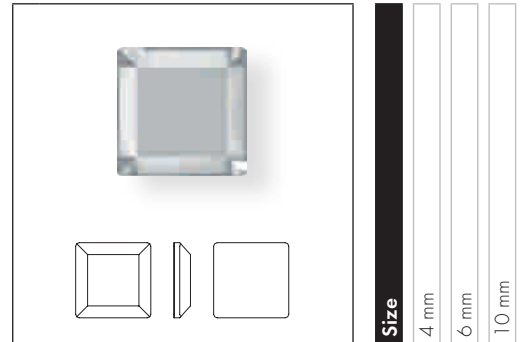

	4 mm	6 mm	10 mm
Crystal			
Crystal F (001)	■	■	■
Colors			
Plain Colors			
Jet (280)	■	■	■
Crystal Effects			
Transparent Effects			
Crystal AB F (001 AB)	■	■	■
Crystal Golden Shadow F (001 GSHA)	■	■	■
Crystal Silver Night (001 SINI)	■	■	■
Metallic Effects			
Crystal Dorado F (001 DOR)	■	■	■
Crystal Light Chrome F (001 ITCH)	■	■	■
Color Effects			
Metallic Effects			
Jet Hematite (280 HEM)	■	■	■

2403 Pyramid Flat Back

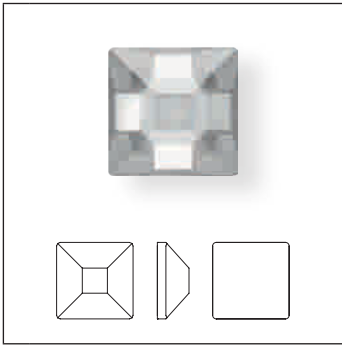

Size	4 mm	6 mm	10 mm
------	------	------	-------

- Crystal**
- Crystal F (001)
- Colors**
- Plain Colors**
- Jet (280)
- Crystal Effects**
- Transparent Effects**
- Crystal AB F (001 AB)
- Crystal Golden Shadow F (001 GSHA)
- Crystal Silver Night (001 SINI)
- Metallic Effects**
- Crystal Dorado F (001 DOR)
- Crystal Light Chrome F (001 LTCH)
- Color Effects**
- Metallic Effects**
- Jet Hematite (280 HEM)

SQUARE FAMILY

2420 Asymmetric Square Flat Back ¹



Size
10 mm
25 mm

- Crystal**
- Crystal F (001)
 - Crystal CAL V SI (001 CAL V SI) ¹

2483 Classic Square Flat Back

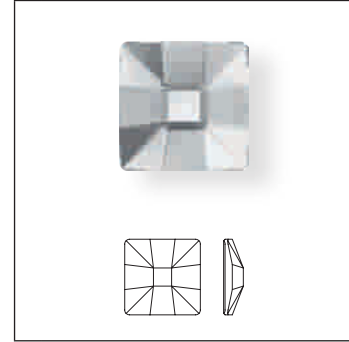

Size
10 mm
25 mm

- Crystal**
- Crystal F (001)
 - Crystal CAL SI (001 CAL SI)
 - Crystal CAL V SI (001 CAL V SI) ¹

2493 Chessboard Flat Back

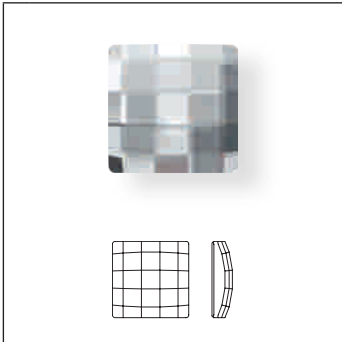

Size
8 mm
10 mm
20 mm

- Crystal**
- Crystal F (001)
- Colors**
- Plain Colors**
- Black Diamond F (215)
 - Jet F (280)
- Crystal Effects**
- Transparent Effects**
- Crystal AB F (001 AB)
 - Crystal Golden Shadow F (001 GSHA)

2494 Starlet Flat Back



Size
6 mm
8 mm

- Crystal**
- Crystal F (001)
- Crystal Effects**
- Transparent Effects**
- Crystal AB F (001 AB)
 - Crystal Golden Shadow F (001 GSHA)

¹ Coated on faceted side.

2520 Cosmic Flat Back

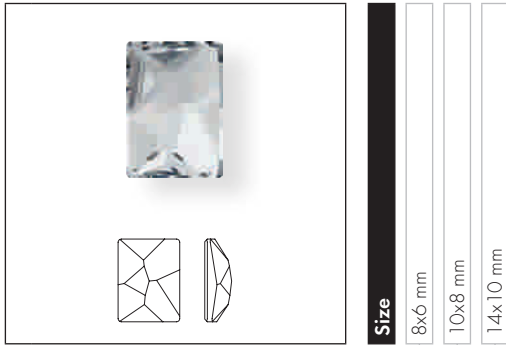

Size
8x6 mm
10x8 mm
14x10 mm

- Crystal**
- Crystal F (001)
- Colors**
- Plain Colors**
- Jet (280)
- Crystal Effects**
- Transparent Effects**
- Crystal AB F (001 AB)
- Crystal Golden Shadow F (001 GSHA)

2540 Curvy Flat Back

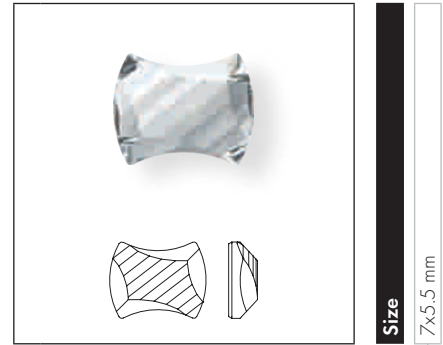

Size
7x5.5 mm

- Crystal**
- Crystal F (001)
- Crystal Effects**
- Transparent Effects**
- Crystal AB F (001 AB)
- Crystal Paradise Shine F (001 PARSH)

2555 Cosmic Baguette Flat Back

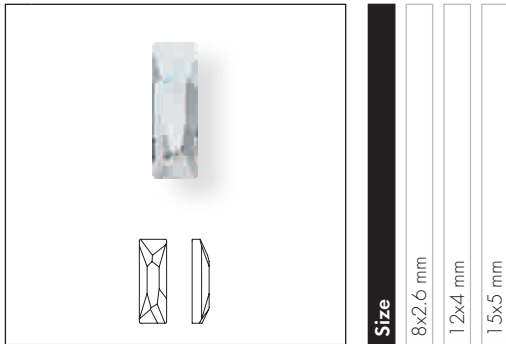

Size
8x2.6 mm
12x4 mm
15x5 mm

- Crystal**
- Crystal F (001)
- Colors**
- Plain Colors**
- Jet (280)
- Crystal Effect**
- Transparent Effects**
- Crystal Golden Shadow F (001 GSHA)

2570 Vigour Rectangle Flat Back ¹



Size
50x16 mm

- Crystal**
- Crystal F (001)
- Crystal CAL SI (001 CAL SI)
- Crystal CAL V SI (001 CAL V SI) ¹

¹ Coated on faceted side.

2585 Graphic Flat Back



Size
8 mm
10 mm

- Crystal**
- Crystal F (001)
- Crystal Effects**
- Transparent Effects**
- Crystal AB F (001 AB)

2602 Emerald Cut Flat Back



Size
8x5.5 mm
14x10 mm

- Crystal**
- Crystal F (001)
- Colors**
- Plain Colors**
- Aquamarine F (202)
- Emerald F (205)
- Graphite F (253)
- Jet (280)
- Sapphire F (206)
- Scarlet F (276)
- Sunflower F (292)
- Vintage Rose F (319)
- Crystal Effects**
- Transparent Effects**
- Crystal AB F (001 AB)
- Crystal Golden Shadow F (001 GSHA)
- Crystal Silver Shade F (001 SSHA)

2709 Rhombus Flat Back

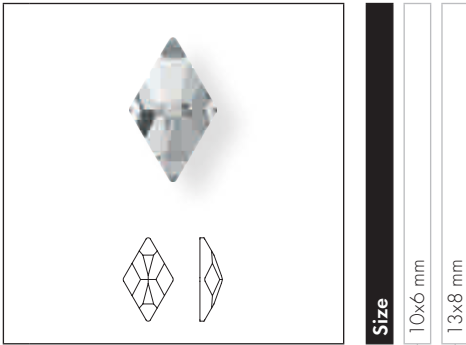

Size

10x6 mm

13x8 mm

Crystal

Crystal F (001)

Colors

Plain Colors

Aquamarine F (202)

Black Diamond F (215)

Light Rose F (223)

Light Siam F (227)

Crystal Effects

Transparent Effects

Crystal AB F (001 AB)

Crystal Golden Shadow F (001 GSHA)

Crystal Silver Shade F (001 SSHA)

2711 Triangle Flat Back

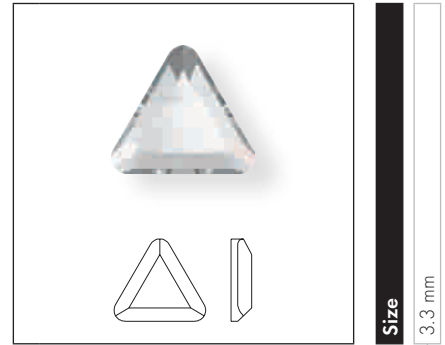

Size

3.3 mm

Crystal

Crystal F (001)

Colors

Plain Colors

Amethyst F (204)

Aquamarine F (202)

Emerald F (205)

Jet (280)

Light Colorado Topaz F (246)

Scarlet F (276)

Crystal Effects

Transparent Effects

Crystal AB F (001 AB)

Crystal Golden Shadow F (001 GSHA)

2714 Fan Flat Back



Size
6 mm
10 mm

Crystal

Crystal F (001)

Crystal Effects

Transparent Effects

Crystal AB F (001 AB)

2716 Rivoli Triangle Flat Back

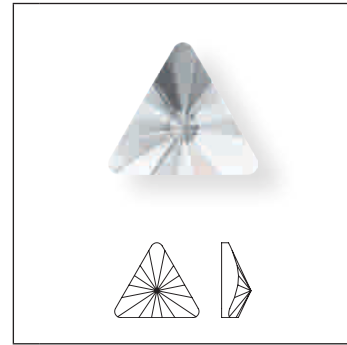

Size
5 mm

Crystal

Crystal F (001)

Crystal Effect

Transparent Effects

Crystal AB F (001 AB)

2720 Cosmic Delta Flat Back

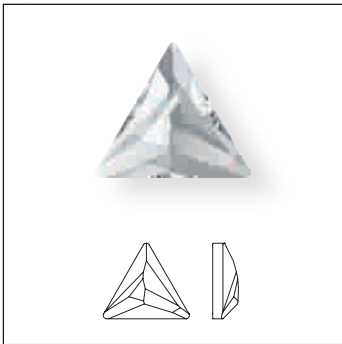

Size
7.5 mm
9 mm
12.5 mm

Crystal

Crystal F (001)

TRIANGLE FAMILY

2738 Triangle Alpha Flat Back



Size

10x5 mm

12x6 mm

Crystal

Crystal F (001)

Colors

Plain Colors

Blush Rose F (257)

Jet (280)

Light Colorado Topaz F (246)

Light Sapphire F (211)

Light Siam F (227)

Crystal Effects

Transparent Effects

Crystal AB F (001 AB)

Crystal Golden Shadow F (001 GSHA)

Crystal Silver Night (001 SINI)

Crystal Lacquer^{PRO} Effects

Crystal Shiny Lacquer^{PRO} Effects

Crystal Dark Grey (001 L111S)

Crystal Dark Red (001 L108S)

Crystal Ivory Cream (001 L106S)

2739 Triangle Beta Flat Back



Size

5.8x5.3 mm

7x6.5 mm

Crystal

Crystal F (001)

Colors

Plain Colors

Blush Rose F (257)

Jet (280)

Light Colorado Topaz F (246)

Light Sapphire F (211)

Light Siam F (227)

Crystal Effects

Transparent Effects

Crystal AB F (001 AB)

Crystal Golden Shadow F (001 GSHA)

Crystal Silver Night (001 SINI)

Crystal Lacquer^{PRO} Effects

Crystal Shiny Lacquer^{PRO} Effects

Crystal Dark Grey (001 L111S)

Crystal Dark Red (001 L108S)

Crystal Ivory Cream (001 L106S)

2740 Triangle Gamma Flat Back

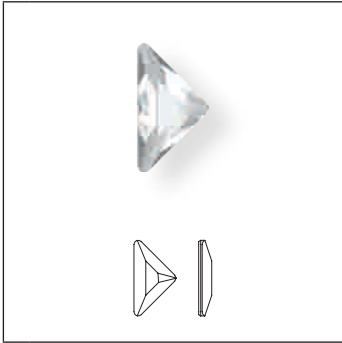

Size	8.3x8.3 mm	10x10 mm
-------------	------------	----------

Crystal		
Crystal F (001)	<input type="checkbox"/>	<input type="checkbox"/>
Colors		
Plain Colors		
Blush Rose F (257)	<input type="checkbox"/>	<input type="checkbox"/>
Jet (280)	<input type="checkbox"/>	<input type="checkbox"/>
Light Colorado Topaz F (246)	<input type="checkbox"/>	<input type="checkbox"/>
Light Sapphire F (211)	<input type="checkbox"/>	<input type="checkbox"/>
Light Siam F (227)	<input type="checkbox"/>	<input type="checkbox"/>
Crystal Effects		
Transparent Effects		
Crystal AB F (001 AB)	<input type="checkbox"/>	<input type="checkbox"/>
Crystal Golden Shadow F (001 GSHA)	<input type="checkbox"/>	<input type="checkbox"/>
Crystal Silver Night (001 SINI)	<input type="checkbox"/>	<input type="checkbox"/>
Crystal Lacquer^{PRO} Effects		
Crystal Shiny Lacquer^{PRO} Effects		
Crystal Dark Grey (001 L111S)	<input type="checkbox"/>	<input type="checkbox"/>
Crystal Dark Red (001 L108S)	<input type="checkbox"/>	<input type="checkbox"/>
Crystal Ivory Cream (001 L106S)	<input type="checkbox"/>	<input type="checkbox"/>

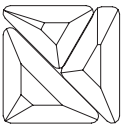

When Alpha, Beta, and Gamma Flat Backs are arranged together, they form a square.

2753 Edelweiss Flat Back

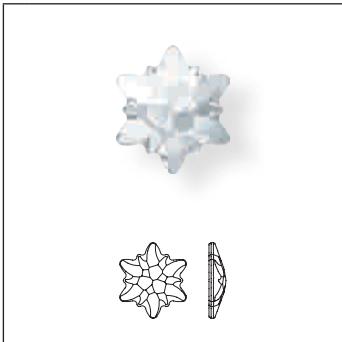

Size
10 mm

- Crystal**
- Crystal F (001)
- Colors**
- Plain Colors**
- Vintage Rose F (319)
- Crystal Effects**
- Transparent Effects**
- Crystal AB F (001 AB)
- Crystal Golden Shadow F (001 GSHA)
- Crystal Silver Night (001 SINI)

2770 Wing Flat Back

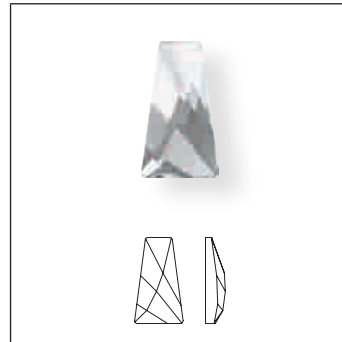

Size
6x3.5 mm
12x7 mm

- Crystal**
- Crystal F (001)
- Color**
- Plain Color**
- Black Diamond F (215)
- Crystal Effects**
- Transparent Effects**
- Crystal Golden Shadow F (001 GSHA)
- Crystal Silver Shade F (001 SSHA)

GEOMETRIC FLAT BACKS

2771 Kite Flat Back

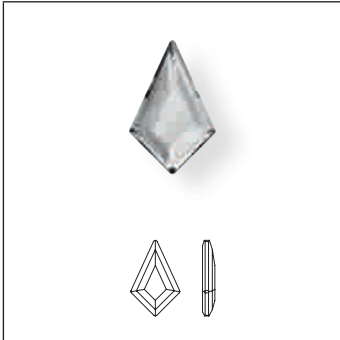

Size
6.4x4.2 mm
8.6x5.6 mm
12.9x8.3 mm

- Crystal**
- Crystal F (001)
- Colors**
- Plain Colors**
- Aquamarine F (202)
- Black Diamond F (215)
- Jet (280)
- Light Rose F (223)
- Light Siam F (227)
- Crystal Effects**
- Transparent Effects**
- Crystal AB F (001 AB)
- Crystal Golden Shadow F (001 GSHA)
- Crystal Silver Shade F (001 SSHA)
- Color Effects**
- Metallic Effects**
- Jet Hematite (280 HEM)

2772 Trapeze Flat Back

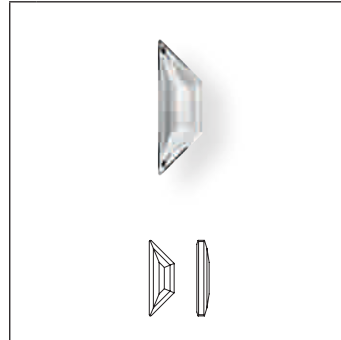

Size
6.5x2.1 mm
8.6x2.8 mm
12.9x4.2 mm

- Crystal**
- Crystal F (001)
- Colors**
- Plain Colors**
- Aquamarine F (202)
- Black Diamond F (215)
- Jet (280)
- Crystal Effects**
- Transparent Effects**
- Crystal AB F (001 AB)
- Crystal Golden Shadow F (001 GSHA)
- Crystal Silver Shade F (001 SSHA)
- Color Effects**
- Metallic Effects**
- Jet Hematite (280 HEM)

2773 Diamond Shape Flat Back



Size
5x3 mm
6.6x3.9 mm
9.9x5.9 mm

Crystal

Crystal F (001)

Colors

Plain Colors

Aquamarine F (202)

Black Diamond F (215)

Jet (280)

Light Rose F (223)

Light Siam F (227)

Crystal Effects

Transparent Effects

Crystal AB F (001 AB)

Crystal Golden Shadow F (001 GSHA)

Crystal Silver Shade F (001 SSHA)

Color Effects

Metallic Effects

Jet Hematite (280 HEM)

GEOMETRIC FLAT BACKS & DESIGNER EDITION

DIAMOND LEAF¹

DESIGNER EDITION

Swarovski and Giorgio Armani worked together to create an exclusive crystal called Diamond Leaf. This Designer Edition has a fluid, organic shape reminiscent of a leaf. Precision-cut facets melt into the softness of a floating, sculptural form, contrasting strength and fragility, the timeless with the ethereal.

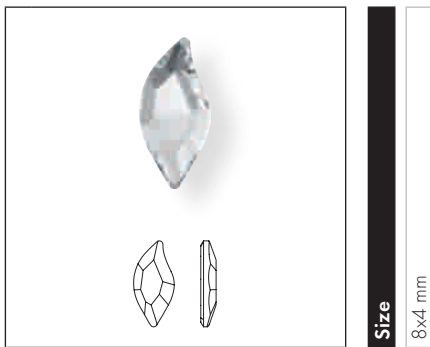

Giorgio Armani: "Swarovski crystal brings a touch of magic to a dress, an ethereal quality, a luster that never fails to captivate the attention."

2797 Diamond Leaf Flat Back¹



- Crystal**
- Crystal F (001)
- Crystal Effect**
- Transparent Effects**
- Crystal AB F (001 AB)

THE DIAMOND LEAF DESIGNER EDITION FAMILY

- 
2797
 8x4 mm chapter 07 Flat Back No Hotfix
 p. 397
- 
3254
 20x9, 30x14 mm chapter 09 Sew-on Articles
 p. 455

DESIGNER EDITIONS – DISTINCT PACKAGING

This Designer Edition will be labeled with the "Designer Edition" imprint directly on the packaging.

¹ Article consists of Advanced Crystal

2798 Contour Flat Back

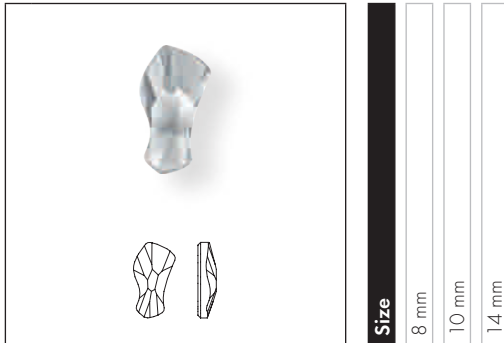

Size
8 mm
10 mm
14 mm

- Crystal**
- Crystal F (001)
- Opal Colors**
- White Opal F (234)
- Crystal Effects**
- Transparent Effects**
- Crystal AB F (001 AB)
- Crystal Silver Night (001 SINI)

2808 Heart Flat Back

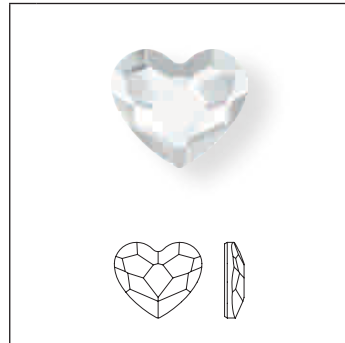

Size
6 mm
10 mm
14 mm

- Crystal**
- Crystal F (001)
- Colors**
- Plain Colors**
- Denim Blue F (266)
- Fuchsia F (502)
- Jet (280)
- Light Siam F (227)
- Light Silk F (261)
- Rosaline F (508)
- Crystal Effects**
- Transparent Effects**
- Crystal AB F (001 AB)
- Crystal Antique Pink F (001 ANTP)
- Crystal Golden Shadow F (001 GSHA)

2813 Moon Flat Back

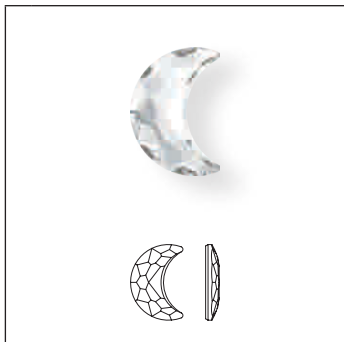

Size
8x5.5 mm
10x7 mm

- Crystal**
- Crystal F (001)
- Colors**
- Plain Colors**
- Jet (280)
- Light Colorado Topaz F (246)
- Light Siam F (227)
- Crystal Effects**
- Transparent Effects**
- Crystal AB F (001 AB)

2816 Rivoli Star Flat Back

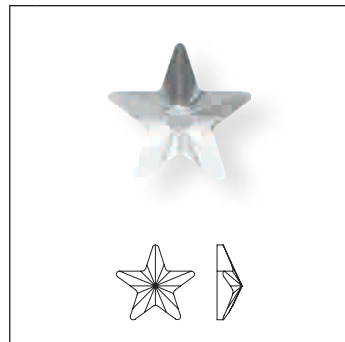

Size
5 mm

- Crystal**
- Crystal F (001)
- Crystal Effects**
- Transparent Effects**
- Crystal AB F (001 AB)

2826 Rivoli Snowflake Flat Back

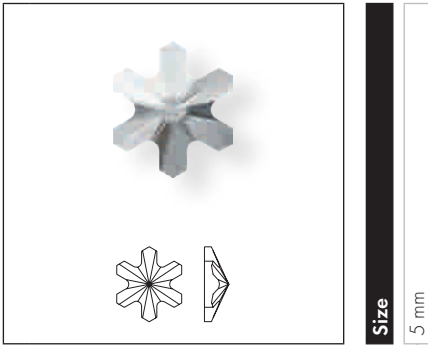

Size
5 mm

Crystal

Crystal F (001)

Crystal Effects

Transparent Effects

Crystal AB F (001 AB)

2854 Butterfly Flat Back

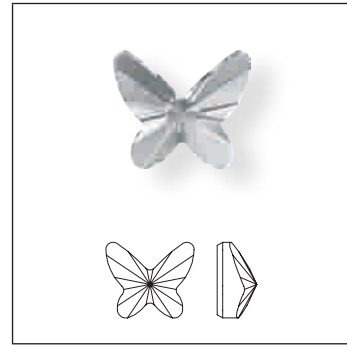

Size
8 mm
12 mm

Crystal

Crystal F (001)

Colors

Plain Colors

Amethyst F (204)

Denim Blue F (266)

Light Rose F (223)

Crystal Effects

Transparent Effects

Crystal AB F (001 AB)

Crystal Silver Night F (001 SINI)

2856 Skull Flat Back



Size
10x7.5 mm
14x10.5 mm
18x14 mm

Colors

Plain Colors

Jet (280)

Crystal Effects

Transparent Effects

Crystal AB F (001 AB)

Crystal Golden Shadow F (001 GSHA)

Crystal Silver Night (001 SINI)

Metallic Effects

Crystal Metallic Blue F (001 METBL)

Crystal Metallic Light Gold F (001 MGLD)

Crystal Light Chrome F (001 LTCH)

Color Effects

Metallic Effects

Jet Hematite (280 HEM)

2858 Bow Tie Flat Back

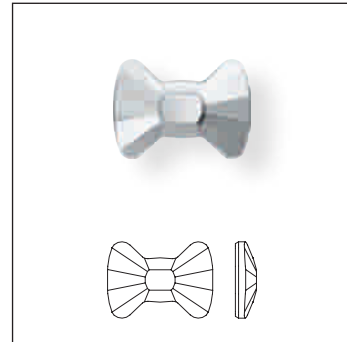

Size
6x4.5 mm
9x6.5 mm

Crystal

Crystal F (001)

Crystal Effects

Transparent Effects

Crystal AB F (001 AB)

PRODUCT DETAILS

Article Size	Packing Unit = Minimum Order Quantity in Pieces	Average Net Weight in Gram per Packing Unit Crystal (001)	Average Gross Weight in Gram per Packing Unit Crystal (001)
2000			
SS 3	1,440	1.8	12.7
SS 4	1,440	3.3	13.7
2006			
10 mm	288	89.9	116.4
12 mm	144	87.2	110.9
14 mm	144	132.4	158.7
16 mm	144	188.6	222.4
2034			
SS 10	1440	10.9	19.3
SS 20	1440	40.7	49.2
SS 48	96	39.8	64.8
2035			
6 mm	360	27.1	34.8
10 mm	192	56.2	88.0
14 mm	96	88.4	109.0
20 mm	40	82.0	121.4
30 mm	12	95.4	130.8
40 mm	6	105.3	140.3
2058			
SS 5	1,440	4.4	17.9
SS 6	1,440	5.7	17.6
SS 7	1,440	7.1	19.0
SS 8	1,440	10.1	19.6
SS 9	1,440	12.4	22.0
SS 10	1,440	15.8	25.3
2072			
8 mm	288	92.9	119.6
10 mm	144	90.6	111.0
12 mm	72	82.0	100.1
2088			
SS 12	1,440	22.1	30.3
SS 14	1,440	30.1	38.3
SS 16	1,440	39.9	49.8
SS 20	1,440	72.2	80.9
SS 24	1,440	127.12	136.3
SS 30	288	34.6	63.0
SS 34	144	25.9	48.6
SS 40	144	50.0	75.1
SS 48	96	76.1	101.3
2088/1			
SS 16	1440	44.69	53.86
SS 20	1440	80.06	89.98
SS 34	144	25.97	44.26
2200			
4x2 mm	720	6.5	18.5
8x4 mm	720	49.6	60.2
2201			
8x3.5 mm	144	10.03	31.11
14x6 mm	72	21.67	45.27

Article Size	Packing Unit = Minimum Order Quantity in Pieces	Average Net Weight in Gram per Packing Unit Crystal (001)	Average Gross Weight in Gram per Packing Unit Crystal (001)
2204			
6x4.8 mm	360	27.2	36.4
10x8 mm	144	31.5	53.3
2205			
7.5 mm	288	20.3	30.5
10 mm	144	17.6	42.4
14 mm	72	22.3	45.9
2300			
8x4.8 mm	720	83.9	94.5
10x6 mm	360	56.9	67.8
2303			
8x5 mm	144	15.70	39.60
14x9 mm	72	36.65	60.25
2304			
10x2.8 mm	180	10.3	20.5
14x3.9 mm	96	13.1	36.3
6x1.7 mm	360	7.5	16.2
2400			
2.2 mm	1,440	11.3	21.7
3 mm	1,440	25.3	36.8
4 mm	720	30.0	41.0
6 mm	144	21.6	32.5
10 mm	72	37.2	61.0
2402			
4 mm	720	22.3	33.1
6 mm	144	15.1	25.9
10 mm	72	30.5	54.1
2403			
4 mm	720	32.2	43.1
6 mm	144	21.9	32.8
10 mm	72	42.7	66.4
2420			
10 mm	144	91.6	118.2
25 mm	32	200.8	251.8
2483			
10 mm	144	90.3	120.2
25 mm	32	233.3	261.5
2493			
8 mm	216	72.3	91.8
10 mm	144	84.4	106.1
20 mm	24	108.5	137.9
2494			
6 mm	220	22.3	31.5
8 mm	144	29.5	50.2
2520			
8x6 mm	288	50.8	80.2
10x8 mm	144	72.3	90.4
14x10 mm	144	119.3	140.8

Article Size	Packing Unit = Minimum Order Quantity in Pieces	Average Net Weight in Gram per Packing Unit Crystal (001)	Average Gross Weight in Gram per Packing Unit Crystal (001)
2540			
7x5.5 mm	240	39.7	43.6
2555			
8x2.6 mm	240	18.4	27.5
12x4 mm	144	28.8	33.6
15x5 mm	72	28.9	46.0
2570			
50x16 mm	6	52.9	81.6
2585			
8 mm	288	48.2	68.1
10 mm	288	72.3	104.3
2602			
8x5.5 mm	144	17.89	41.79
14x10 mm	72	58.61	82.21
2709			
10x6 mm	288	48.2	73.6
13x8 mm	144	41.0	60.1
2711			
3.3 mm	720	10.2	16.4
2714			
6 mm	360	38.8	49.7
10 mm	144	59.8	84.3
2716			
5 mm	720	35.8	75.1
2720			
7.5 mm	240	27.9	37.0
9 mm	180	45.1	54.2
12.5 mm	144	71.1	87.1
2304			
6x1.7 mm	360	7.5	16.2
2738			
10x5 mm	144	16.7	35.1
12x6 mm	96	20.2	38.3
2739			
5.8x5.3 mm	216	19.2	41.9
7x6.5 mm	144	22.6	39.8
2740			
8.3x8.3 mm	216	35.1	54.2
10x10 mm	96	25.1	41.1
2753			
10 mm	72	19.6	40.4
2770			
6x3.5 mm	1,440	60.3	70.3
12x7 mm	192	49.8	98.4

Article Size	Packing Unit = Minimum Order Quantity in Pieces	Average Net Weight in Gram per Packing Unit Crystal (001)	Average Gross Weight in Gram per Packing Unit Crystal (001)
2771			
6.4x4.2 mm	288	9.04	17.87
8.6x5.6 mm	216	16.84	43.02
12.9x8.3 mm	144	36.29	61.39
2772			
6.5x2.1 mm	288	6.39	15.17
8.6x2.8 mm	288	16.29	40.71
12.9x4.2 mm	144	25.57	53.86
2773			
5x3 mm	288	4.83	13.66
6.6x3.9 mm	288	11.23	35.65
9.9x5.9 mm	144	19.30	43.39
2797			
8x4 mm	240	14.9	24.0
2798			
8 mm	360	23.0	33.2
10 mm	144	21.4	44.7
14 mm	108	55.1	83.5
2808			
6 mm	288	19.8	28.9
10 mm	144	38.8	55.9
14 mm	96	56.4	86.8
2813			
8x5.5 mm	144	13.1	37.7
10x7 mm	144	23.0	47.6
2816			
5 mm	720	23.6	30.7
2826			
5 mm	720	23.1	30.1
2854			
8 mm	216	36.0	52.2
12 mm	144	84.4	103.8
2856			
10x7.5 mm	72	20.2	38.6
14x10.5 mm	36	30.2	50.3
18x14 mm	30	53.0	83.4
2858			
6x4.5 mm	240	12.5	21.7
9x6.5 mm	144	23.4	44.1